

# Contents

<b>WELCOME</b>	<b>1</b>
<b>PRODUCTS COVERED BY THIS USER MANUAL</b>	<b>1</b>
<b>1 SAFETY INSTRUCTIONS</b>	<b>2</b>
<b>2 PRODUCT OVERVIEW</b>	<b>3</b>
Preparing the remote for use	4
<b>3 USING YOUR REMOTE</b>	<b>5</b>
<b>4 CONNECTING TO YOUR EXISTING EQUIPMENT</b>	<b>7</b>
4.1 If your television set and video have SCART sockets	7
4.2 If your television set and video have ONLY a standard coaxial aerial input	8
4.3 Connecting to your HIFI	9
4.4 Inserting your smart card	9
<b>5 MENU TREE</b>	<b>10</b>
<b>6 GENERAL OPERATION OF YOUR DIGITAL TERRESTRIAL RECEIVER</b>	<b>11</b>
<b>7 FINDING AND STORING CHANNELS</b>	<b>11</b>
<b>8 DAY TO DAY OPERATION</b>	<b>13</b>
8.1 Switching on - switching off your receiver	13
8.2 Changing channels	13
8.3 Using the TV/DTV button	14
8.4 Using the on screen TV guide	15
8.5 Choosing your favourite channels	16
8.6 Using ONmail	16
<b>9 ADVANCED SETTINGS</b>	<b>17</b>
9.1 Using your parental lock	17
Entering your parental code for the first time	17
To change your parental code	18
9.2 Selecting channels to be locked	19
9.3 Watching your locked channels	19
To unlock individual channel	19
To temporarily unlock all channels	20
9.4 Re-arranging your channels	20
9.5 Timer	21
Setting the timer	21
Timer alarm	22
Deleting a timer	23
9.6 Using teletext	23
9.7 Checking your postbox	24
9.8 Altering your ONdigital box settings	25
9.9 Altering settings for your TV and video	26
9.10 Altering modem settings	28
9.11 Technical information	28
9.12 Adding new channels	29
<b>10 IF YOUR DIGITAL RECEIVER'S REMOTE COMMANDS INTERFERES WITH YOUR TELEVISION</b>	<b>30</b>
10.1 To change your digital receiver from system A to system B	30
10.2 To change your remote control from system A to system B	30
<b>11 PROGRAMMING THE REMOTE FOR YOUR TV AND VIDEO</b>	<b>31</b>
<b>12 TROUBLE SHOOTING GUIDE</b>	<b>35</b>
<b>13 TECHNICAL SPECIFICATION</b>	<b>37</b>

# Welcome to digital television made simple.

Congratulations on your choice of Philips' DTX6372 digital terrestrial receiver. Using your Philips digital receiver will allow you to access digital terrestrial programmes and services.

**Note:** To access ONdigital services you will need to take out a subscription. Refer to the envelope included with your receiver, to get more information.

The simplest way to get digital television is here. No dish. No cable. Simply an aerial. It is, without doubt, the most exciting development in television history since the first ever broadcast in 1936.

In the last 60 years there have been up to five normal channels on analogue television. Digital terrestrial television changes that.

ONdigital is the next step in television. Simply plug in your ONdigital box for a feast of mouthwatering television. ONdigital is the only company that lets you pick and choose the channels you want to watch.

Subscription channels from ONdigital together with free channels from the BBC and ITV, will cover everything from sports and movies to news and current affairs, all with improved picture and sound and widescreen, too.

## Products covered by this User Manual:

This user manual applies to the models DTX 6370, DTX 6371 and DTX 6372. The illustrations are taken from DTX 6372. For the previous models there are small differences in the position of the buttons on the front panel and the connectors on the rear panel, but buttons and connectors perform the very same functions for all three models.

# 1

## SAFETY INSTRUCTIONS

For best results position your receiver away from radiators or other heat sources. Leave a space of at least 3 cm all round the receiver for ventilation making sure that the ventilation holes are not obstructed.

This receiver is intended for use in a domestic environment only and should never be operated or stored in excessively hot, humid or damp conditions.

Make sure no objects or fluids enter the housing through the ventilation slots. Should this happen, disconnect your receiver from the mains and consult your retailer.

For cleaning, use a damp chamois leather, never use any abrasive cloth, sponge or cleaner.

When connecting or disconnecting cables to the receiver always ensure the receiver is disconnected from the mains.

Please wait before connecting your receiver - read on.

### Mains connection

Before connecting the receiver to the mains, check that the mains supply voltage corresponds to the voltage printed on the type plate of the receiver. If the mains voltage is different, consult your dealer.

### Important

This apparatus is fitted with an approved moulded 13 A plug.

To change a fuse in this type of plug proceed as follows:

1. Remove fuse cover and fuse.
2. Fit new fuse which should be a BS1362 3A, A.S.T.A. or BSI approved type.
3. Refit the fuse cover.

If the fitted plug is not suitable for your socket outlets, it should be cut off and appropriate plug fitted in its place. If the mains plug contains a fuse, this should have a value of 3A.

If a plug without a fuse is used, the fuse at the distribution board should not be greater than 5A.

Note : The severed plug must be destroyed to avoid a possible shock hazard should it be inserted into a 13A socket elsewhere.

### How to connect a plug

The wires in the mains lead are coloured in accordance with the following code:

- BLUE - "NEUTRAL" ("N")
- BROWN - "LIVE" ("L")

1. The BLUE wire must be connected to the terminal which is marked with the letter "N" or coloured BLACK.
2. The BROWN wire must be connected to the terminal which is marked with the letter "L" or coloured RED.
3. Do not connect either wires to the earth terminal in the plug which is marked by the letter "E" or by the safety earth symbol  $\perp$  or coloured green or green-and-yellow. Before replacing the plug cover, make certain that the cord grip is clamped over the sheath of the lead - not simply over the two wires.

# 2 PRODUCT OVERVIEW

## FRONT VIEW

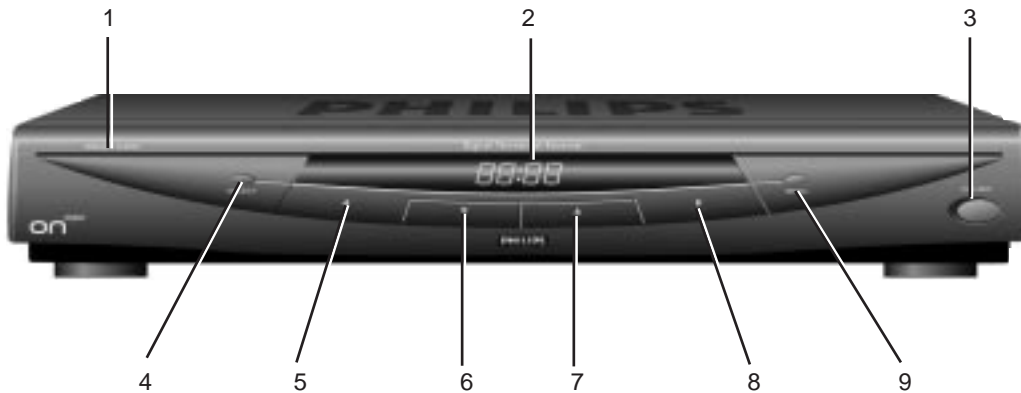

- |   |   |     |                                     |
|---|---|-----|-------------------------------------|
| 1 | Smart card reader.  | 5 ◀ | : Adjust a menu option setting.     |
| 2 | 4 Digit LED front indicator.  | 6 ▼ | : Move highlight downwards in menu. |
| 3 | ON/OFF : Mains ON/OFF button.                                       | 7 ▲ | : Move highlight upwards in menu.   |
| 4 | Select : Open channel list in TV mode<br>Confirm selection in menu. | 8 ▶ | : Adjust a menu option setting.     |
|   |   | 9   | Menu : Open and close Main Menu.    |

## REAR VIEW

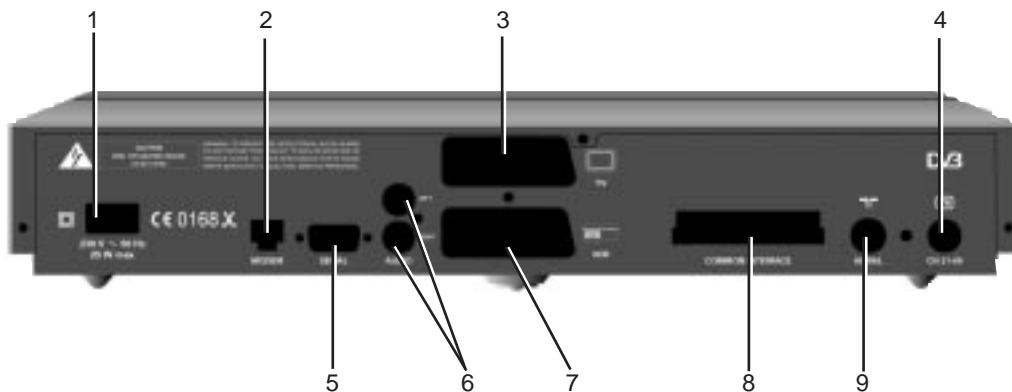

- |             |                                    |             |  |
|-------------|------------------------------------|-------------|--|
| 1           | 230 V - 50 Hz power cord socket.   | 5           | RS 232 serial port socket.                 |
| 2           | RJ11 connector for telephone line. | <b>Note</b> | : Ready to connect multimedia product.     |
| <b>Note</b> | : Ready for ONmail and ONrequest.  | 6           | Audio-cinch outputs for HIFI system.       |
| 3           | SCART* socket for TV.              | 7           | SCART* socket for VCR/video.               |
| 4           | UHF aerial output for TV.          | 8           | Common interface.                          |
|             |                                    | <b>Note</b> | : Ready for connection of a future module. |
| *           | : Euroconnector = SCART            | 9           | UHF aerial input.                          |

**Note:** The label showing the set type and serial number is underneath your receiver.

## PREPARING YOUR REMOTE FOR USE

Your remote not only works your digital receiver but also the main operating features of major-brand televisions and video (VCR's). Please consult chapter 10 of this manual for programming instructions.

Before using the remote:

- Remove its back cover
- Insert the two batteries (type R06G/AA - 1.5 V) supplied.
- Position them as shown in the diagram in the battery compartment.
- Replace the cover.

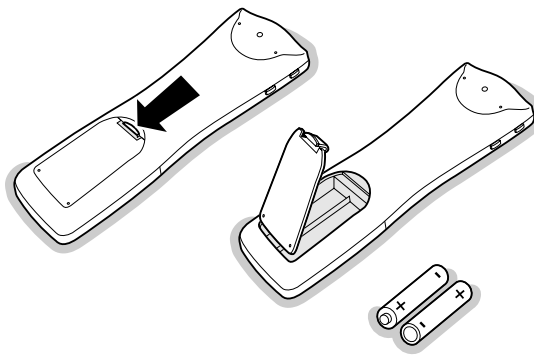







**R06 / AA**

The Philips batteries supplied with your receiver's remote do not contain heavy metals such as Mercury or Nickel Cadmium. Nevertheless in many countries exhausted batteries may not be disposed of with your household waste. Please ensure you dispose of exhausted batteries according to local regulations.

# 3 USING YOUR REMOTE

## Multibrand Video control

Press VCR side key together with:

- +  key : standby
- +  key : record
- +  key : rewind
- +  key : stop
- +  key : play
- +  key : fast forward

**VCR side key** see above description

## SELECT



- In normal mode : open channel list
- In channel list : select a programme
- In menu : confirm your selection

 : Adjust volume up/down

**TV/DTV** (only with receiver/TV scart lead connection)

Switch between watching digital programme from your receiver to watching analogue programmes from your TV set: (refer to chapter 8.2).

## Multibrand TV control

- ON : wake up TV on programme 1
- OFF : switch TV to standby
-  : adjust TV volume up
-  : adjust TV volume down
- P+ : select one programme up
- P- : select one programme down
-  : mute/demute the sound

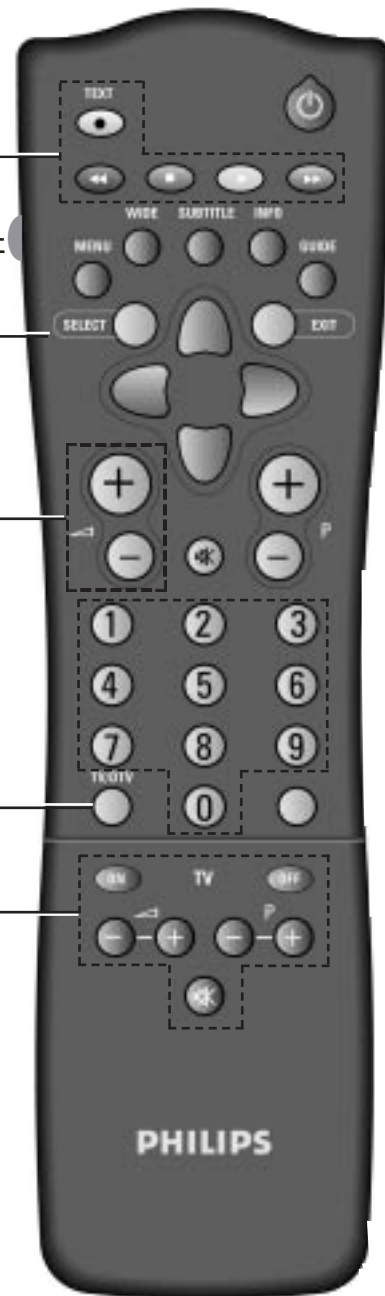

## Multibrand TV and video controls

Your remote can control different major-brand televisions and video's.

Initially your remote is programmed for Philips-brand televisions and video's. If you have a different brands, follow the instructions in chapter 11.

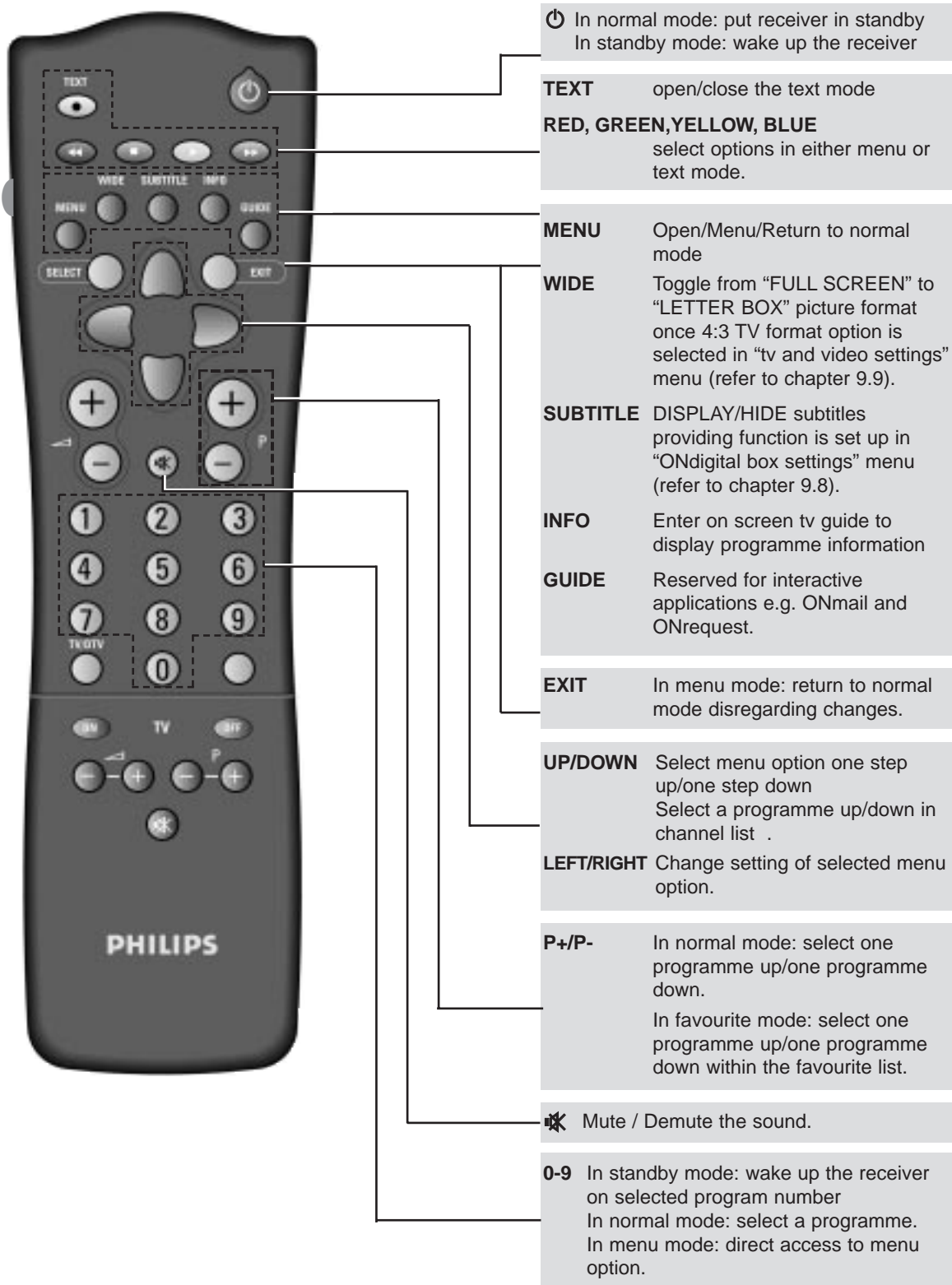

### RECEIVER FRONT PANEL BUTTON FUNCTIONS

- In stand by mode:  
Any key wakes up the receiver from standby
- In normal mode:  
keys have same function as relevant remote control keys (refer below).  
Menu = MENU; Select = SELECT; ◀/▶ = LEFT/RIGHT; ▲/▼ = UP/DOWN

# 4

## CONNECTING TO YOUR EXISTING EQUIPMENT

### 4.1 IF YOUR TELEVISION AND VIDEO HAVE SCART SOCKETS.

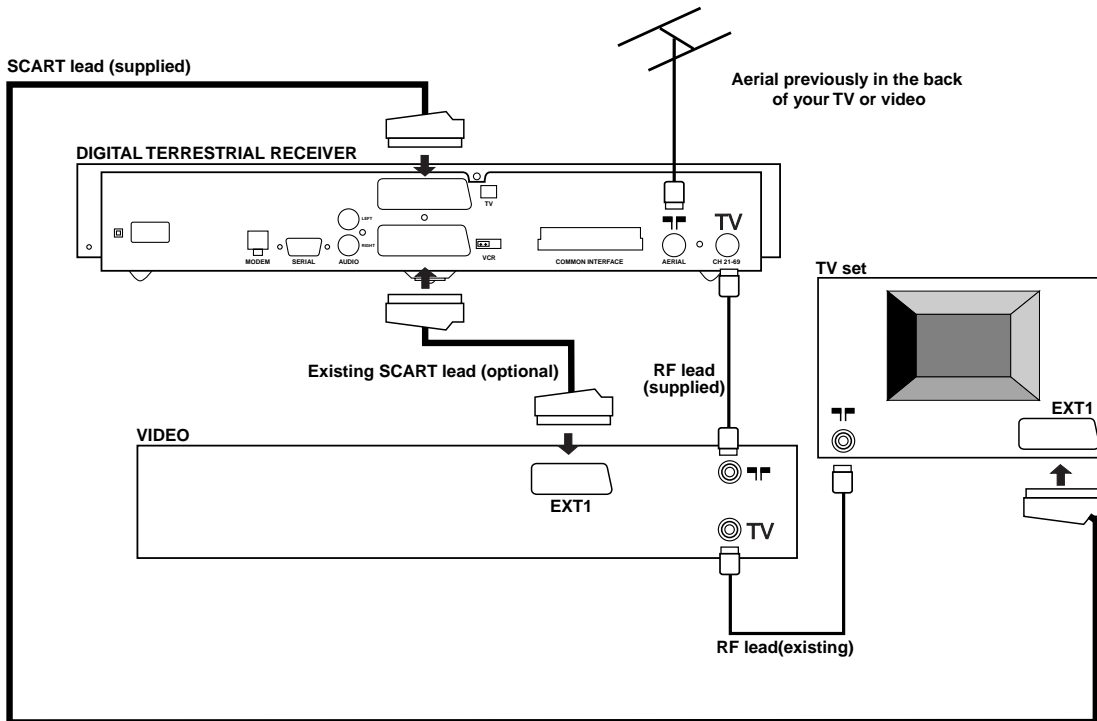

1. Unplug all equipment from the mains before making connections.

**Note:** Before starting to connect check your current wiring because you can keep the coaxial connection in between your TV and your video provided they are connected as shown above. This connection ensures you can still record your current channels.

2. Connect a SCART lead between the "TV" socket of your digital receiver, and the television. Using the first SCART of your TV (usually described as EXT AV 1) will provide the best picture quality. This will also cause a digital television picture to automatically appear on your TV screen when you turn on the digital receiver.
3. If you already have a SCART lead use it between the "VCR" socket of your digital receiver and your video. This connection provides the best recording/playback quality. Use the first EXT AV1 SCART socket on your video. It will make it possible for your video, to play through your digital receiver connection.
4. Refer to the connection diagram above to complete the wiring of your receiver. No further adjustment is required .
5. Then plug all your equipment , including your digital receiver, into the mains.
6. Switch on your TV first and select a channel. Now switch on your digital receiver using the **ON/OFF** button on the front panel. The front display will show " - - : - - ".
7. Press the  (standby) button on your remote to wake up your digital receiver. Your receiver will now be generating a "welcome" screen.
8. Then go to chapter 6.



## 4.2 IF YOUR TELEVISION AND VIDEO HAVE ONLY A STANDARD COAXIAL AERIAL INPUT.

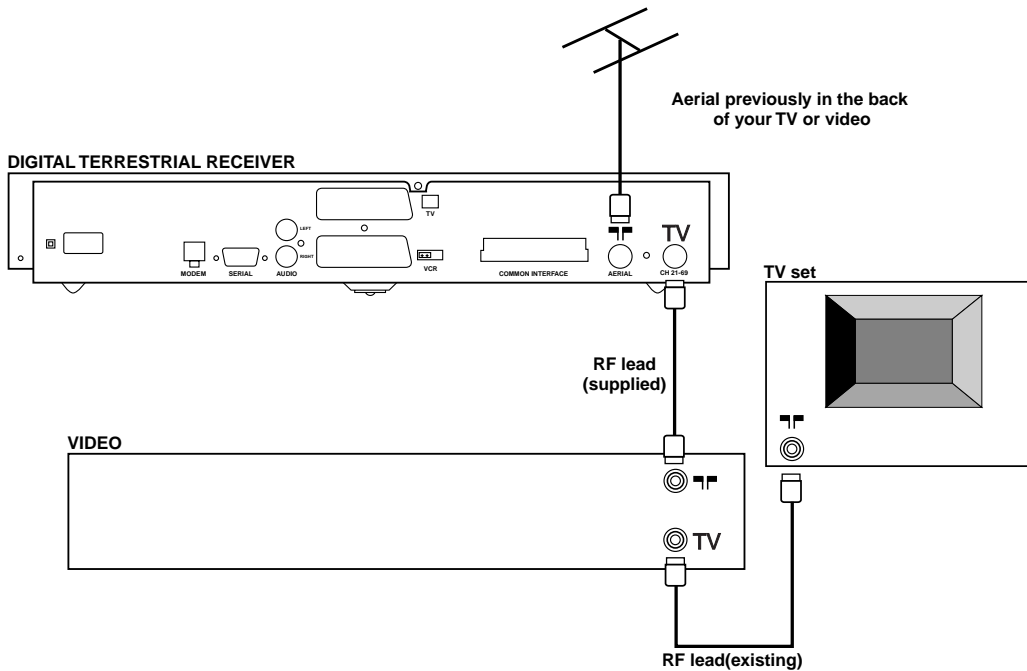

1. Unplug all equipment from the mains power before making connections. Before starting the connection, check your current wiring as you can keep the coaxial aerial connection in between your TV and video. This connection ensures you can still playback your video and watch digital channels.
2. Connect your equipment according to the diagram above but do not connect your aerial to the digital receiver at this stage.
3. Once connected, plug in your equipment. Switch on your TV first and select a spare channel to be used when watching digital programmes, then switch on your video. (It doesn't matter what channel number your video is on at this stage.)
4. Now switch on your digital receiver using the mains **ON/OFF** button on the front panel. The front panel display will show - - : - -.
5. Press the  (standby) button on your remote to wake up your digital receiver. Your receiver will now be generating a welcome screen to give you something to look out for when you are tuning your TV.
6. **Tuning your television**  
You now need to manually tune the channel you have selected on your TV to watch digital programmes. Please refer to your TV's user guide if you need to check how to do this. When the welcome screen appears on your TV, store that channel.
7. If you haven't managed to display the welcome screen at this stage, press the **M** button on the front of the receiver. This will generate the main menu on-screen which you can then look out for when tuning. Try manually tuning your TV again, this time looking for the main menu.
8. Connect your aerial to the digital receiver and check that the picture remains steady (no interference or snow).

9. Switch your TV to all other tuned channels, including that tuned for your video, and check the picture quality. If there is no interference, go to chapter 6.

If there is any interference, continue as follows:

- Disconnect your aerial from the back of the receiver.
- Make sure that your TV is on the channel you have tuned for watching digital programmes
- If you have the welcome message on-screen, press the **SELECT** button on your remote. You will now see the main menu screen.
- From the main menu, select option 4 viewing preferences, option 2 tv and video settings and then option 6 uhf channel number.  
The current setting for this option is 38, which needs to be changed if you are experiencing interference. To do this, use the number buttons to enter a new uhf channel number. Choose one that is significantly different from 38. Press the **RED** button (back) to move back a screen and store your setting.
- Repeat previous steps from step 6 Tuning your television to see if the picture improves. When you are satisfied with the picture, continue to chapter 6.

## 4.3 CONNECTING TO YOUR HIFI

Please refer to your HIFI's instruction book should you require further information.

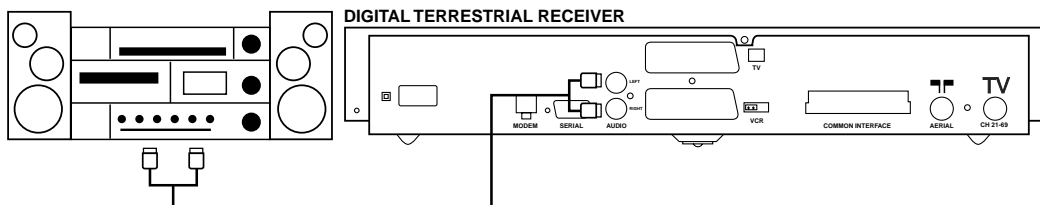

## 4.4 INSERTING YOUR SMARTCARD

In order to watch ONdigital channels your viewing smartcard needs to be inserted in the smartcard slot on the front of your digital receiver.

Remove the smartcard from the ONdigital envelope supplied with your receiver and insert into the smartcard slot on the front of the receiver. You should have the **ARROW** facing forwards into the box and the **GOLD CHIP** facing upwards. Push the card into the slot as far as it will go, the end will be visible outside of the slot.



# 5 MENU TREE

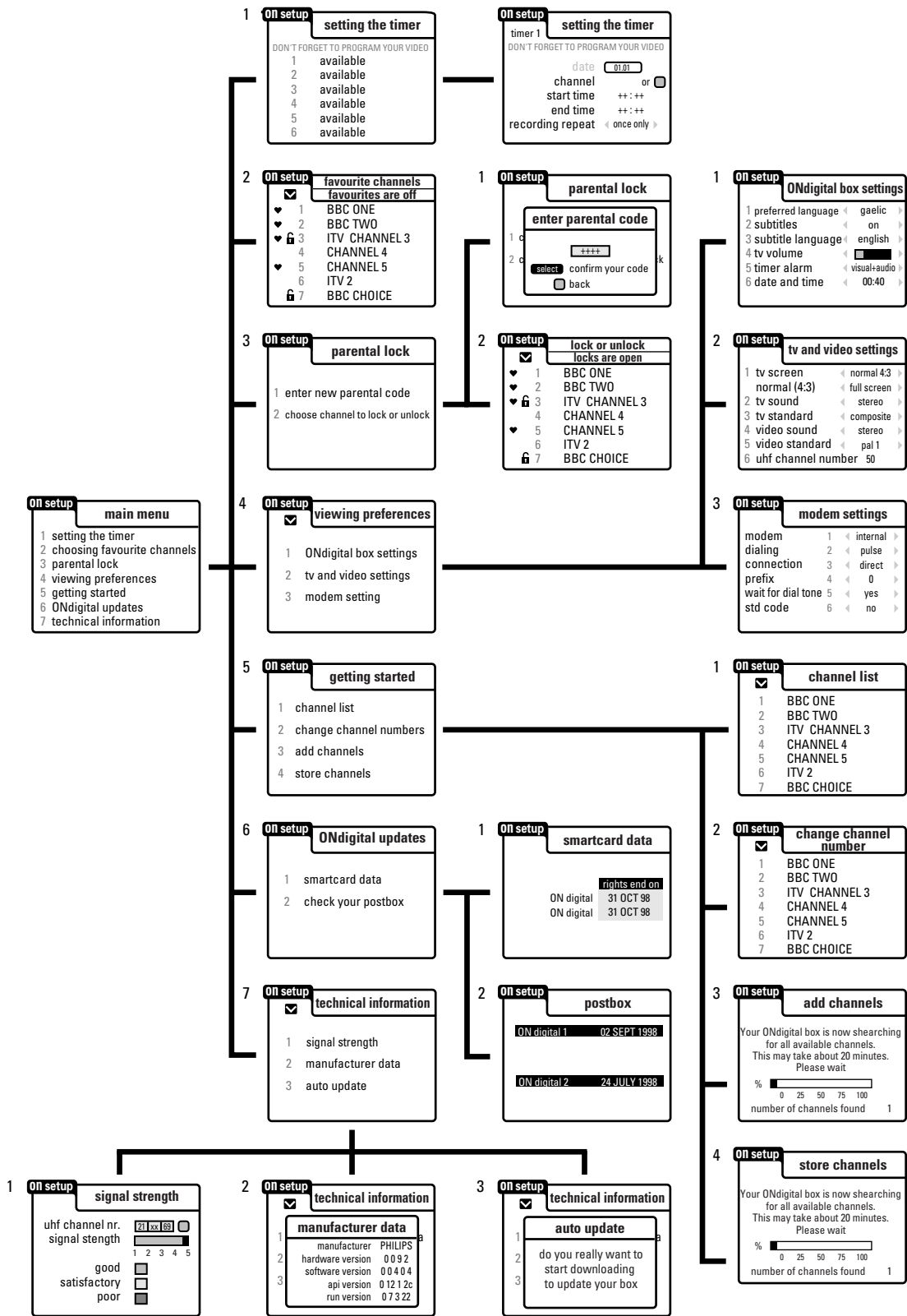

At first power up (Initial Installation) the following screens are shown:

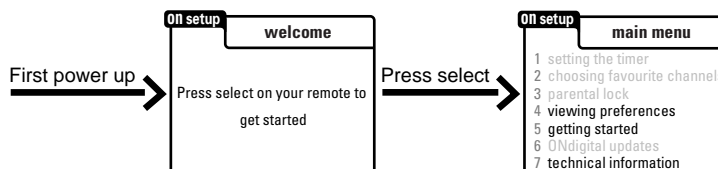

# 6

## GENERAL OPERATION OF YOUR DIGITAL TERRESTRIAL RECEIVER

Throughout this instruction book you will notice that the everyday operation of your digital receiver is based on a series of user friendly on-screen displays and menus. These displays will help you get the most from your digital receiver, guiding you through initial installation, channel selection, timer settings and many other functions.

All functions can be carried out using either the buttons on the front of your digital receiver or the remote, however we suggest that you will find it easier to use your remote in most instances. If at any time when using the menus you want to return to the normal TV picture, press either the **EXIT** or **MENU** button.

Should you experience any difficulties with the operation of your receiver, please consult the relevant section of the instruction book, including the trouble shooting guide, or alternatively call ONdigital customer services on 0870 600 9696.

# 7

## FINDING AND STORING CHANNELS

Now you have connected your digital receiver as described on the previous pages, you are ready to begin searching for your new channels. This is also covered within the ONdigital envelope included with your digital receiver. We recommend that if possible, you use this guide to install your receiver.

The procedure in the ONdigital envelope or that described in chapter 4 of this instruction book will result in you seeing either the welcome or main menu screen on your TV.



### IMPORTANT:

- If you do not see either screen and you have used SCART leads when connecting you may need to press the **TV/DTV** button twice on your remote. Alternatively use the button on your TV remote that selects the TV's AV or External (SCART) socket.
- If you do not see either screen and you have not been able to use SCART leads when connecting check the channel number you have selected, alternatively you may need to adjust the tuning of your TV again. Please refer back to chapter 4.

1. If you have the welcome message on-screen at the moment, press the **SELECT** button on your remote. If you already have the main menu go to step 3.

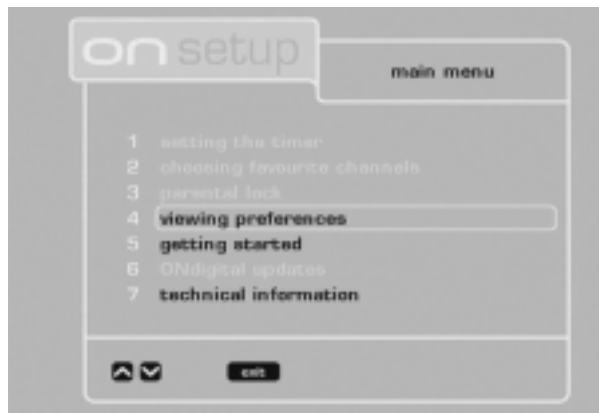

2. Choose option 5 getting started using the **DOWN ARROW** button, and press the **SELECT** button.

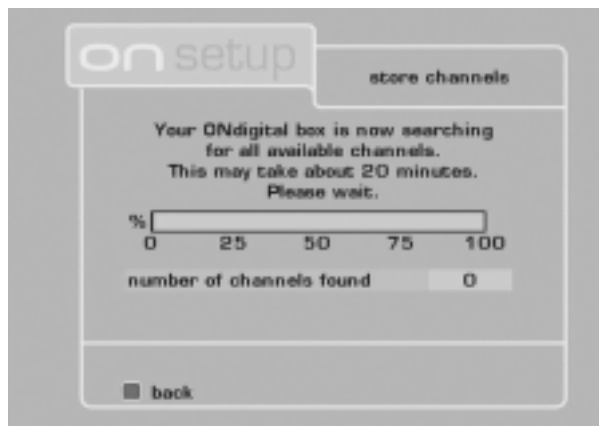

The receiver will start to search for all available channels, as indicated on-screen.

3. If you already had the main menu on-screen
  - Choose option 5 getting started in the same manner as above.
  - Highlight the store channels option using the **DOWN ARROW** button and press the **SELECT** button.
  - Press the **SELECT** button again, the receiver will start to search for all available channels, as indicated on-screen.

During the installation process the display on screen will indicate the number of channels that have been found and the percentage of the installation that has been completed. You will also see the message Your ONdigital box is searching for all available channels – this may take about 20 minutes – please wait.

When complete, the display will briefly show 100%, the number of channels that have been found and indicates that these are being stored. It will then display a list of channels.



- Press the **UP** or **DOWN** button to highlight the channel you want to watch followed by the **SELECT** button to watch that channel.

# 8

## DAY TO DAY OPERATION

### 8.1 SWITCHING YOUR RECEIVER ON AND OFF

With your digital receiver connected to the mains, press the **ON/OFF** button to power it on.

- Press the  button on your remote to wake up your receiver.
- Press the  button on your remote again to put your receiver into standby.

### 8.2 CHANGING CHANNELS

There are three ways to select channels on your digital receiver, as identified in the remote section at the front of this instruction book. In all cases, the receiver will wait approximately 1 second before changing channels after the selection has been made.

#### USING NUMBER BUTTONS

When using the number buttons, a channel number of up to 3 digits can be entered. To select a multiple digit channel number, simply press the other number buttons immediately after the first.



#### IMPORTANT :

Using the number buttons will enable you to select **ALL** channels, regardless of whether they have been selected as your favourite channels.

#### USING THE P+ / P- BUTTONS

- In normal viewing mode pressing **P+** or **P-** selects the next or the previous channel to the one you are currently watching.
- In favourite channel mode pressing **P+** or **P-** selects the next or the previous channel to the one you are currently watching only from those channel in the favourite list.

## USING THE CHANNEL LIST

The channel list is an alternative way of viewing what channels are available on your digital receiver. The list will be displayed over the programme you are currently watching and will also indicate which channels have been selected as your favourites or have been locked (see 8.5 to 9.3 on how to select favourite and locked channel).

1. To display the channel list, press the **SELECT** button whilst viewing any channel. The following is an example of the information that will appear on-screen. All available channels will be included in the channel list. Make the channel list in the photograph consistent with the menu tree on page 10.



2. The display will show a total of 6 channels at a time, along with symbols that identify the status of particular channels, such as favourite and/or locked channel. The channel you are currently viewing will be highlighted on this list.
3. To move through the channel list, press the **UP** or **DOWN** arrow button as indicated on-screen. The selected channel will be highlighted. When you reach the bottom of one screen, continue to press the **DOWN** arrow to scroll to the next screen. Alternatively press **RIGHT** or **LEFT** to move a whole page at a time.
4. At any stage, you can press the **EXIT** button to remove the channel list from the screen, or alternatively, with the required channel highlighted, you can change to that channel by pressing the **SELECT** button.

## 8.3 USING THE TV/DTV BUTTON

This button is used to switch between watching digital channels via your digital receiver and standard analogue channels on your TV. The function of the button depends on whether you have connected your digital receiver using the scart lead supplied.

As an example, if you have used the scart lead between your digital receiver and TV, and are currently recording a digital programme, you may need to use the **TV/DTV** button to watch a standard analogue channel. Pressing this button again will switch back to watching a digital channel.

In most cases, having connected your digital receiver and TV by a scart lead, you will not have to manually select the correct channel on your TV for watching digital programmes. To ensure the correct channel is selected automatically, your TV should be switched on before your digital receiver. If your TV is switched on after your digital receiver, you may need to use the **TV/DTV** button to select the correct channel on your TV.

## 8.4 USING THE ON-SCREEN TV GUIDE

Your digital receiver has the ability to display details of programmes currently being broadcast and those being broadcast immediately afterwards. You can change channels on your digital receiver whilst the information is displayed on your TV.

1. To activate the on-screen tv guide, press the **INFO** button on your remote. The following information will be displayed on your TV. At any of the following stages, you can return to normal viewing by pressing the **INFO** or **EXIT** button. Make the banner text in the photograph consistent with the menu tree on page 10 : Channel 1 / BBC ONE.



The top half of the screen will display the current channel number, channel name, the name of the current programme and the time.

The bottom half of the screen will initially show the same information and additionally, the name and start time of the programme currently being shown as well as that of the next programme. It will also show options to view more information about the programmes.

2. Whilst this information is displayed on-screen, you can press the **UP** and **DOWN** arrow buttons, or **number** buttons 0 to 9 on your remote to see programme information for other channels, without actually changing the channel you are currently watching.  
  
As you change channels, the top part of the screen will continue to display information for the channel you are currently watching.
3. If you want to change channels whilst this screen is displayed, you can do so by pressing the **SELECT** button on your remote when the information for the channel you require is displayed.
4. As part of this feature, you also have access to additional information about both the current and the next programme. You can view this by pressing the **YELLOW** button to display information about the current programme and the **BLUE** button for the next programme. Pressing the same button a second time will return to the standard programme information.

**Note:** The channel cannot be changed by pressing the **SELECT** button if you are viewing information for the next programme.

5. When viewing the additional programme information you may find that it is not all displayed on one screen. In this case, use the **UP** and **DOWN** arrow buttons as indicated on screen to display this information.

The lower section of the on screen TV guide also indicates whether subtitles are available on a particular programme, whether it is broadcast in mono or stereo and also the type of programme. (such as film, drama or comedy.)



## 8.5 CHOOSING YOUR FAVOURITE CHANNELS

This function enables you to select channels that become your favourites, and are therefore easier and faster to access.

When using the **P+** and **P-** buttons to change channels when the favourite mode is ON, only those identified as your favourite channels will be available for selection. You can view a list of your chosen favourite channels by selecting the channel list or the favourite channels menu.

1. Firstly, press the **MENU** button to display the main menu.
2. Then select the "choosing favourite channels" option using the **UP** and **DOWN** arrow buttons until it is highlighted, followed by the **SELECT** button. Alternatively press number button 2.



3. To add channels into your list of favourites, highlight the channel you want to select using the **UP** and **DOWN** buttons. Then press the **SELECT** button to display the favourite channel heart symbol alongside the channel name.
4. Repeat these steps for any other channel that you wish to select as a favourite.
5. To remove any of these channels from your favourites list, use the **UP** and **DOWN** arrow buttons to highlight the channel that you want to remove, and press **SELECT**.

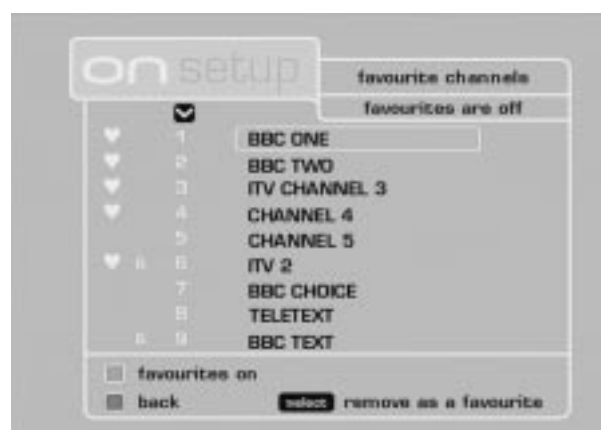

6. After you have selected or de-selected all your favourites, press the **GREEN** button as indicated to activate the favourite mode. The favourite mode status is displayed on the right top part of the menu as favourites are on or favourites are off.
7. Press the **EXIT** button to return to normal operation.
8. Press the **⏻** button to store your selection.

## 8.6 USING ONmail

For instructions about the ONmail service, please refer to « Set up guide » and « User guide » included in the ONmail package.

# 9

## ADVANCED SETTINGS

### 9.1 USING YOUR PARENTAL LOCK

This feature will enable you to limit the access to any particular channel by choosing a security code. Your unique code must then be entered before you can watch a locked channel.

When this option is selected for the first time, you will be prompted to choose your parental code. You must choose your own code following these instructions before you can lock a channel. You will be asked for your parental lock code before being able to gain access to the channel locking menus or a locked channel.

#### ENTERING YOUR PARENTAL CODE FOR THE FIRST TIME

1. Firstly, press the **MENU** button (main menu) then number button 3 (parental lock) then button 1 for parental lock option.

**Note:** Getting access to this menu is only possible once the smart card is in the smart card slot.



2. This menu will display an area where you should input your 4 digit code, using the **number** buttons on the remote.

As you enter the code, it will be displayed on-screen. If you enter an incorrect number, you can use the **LEFT** arrow button to move back one space and make an amendment.

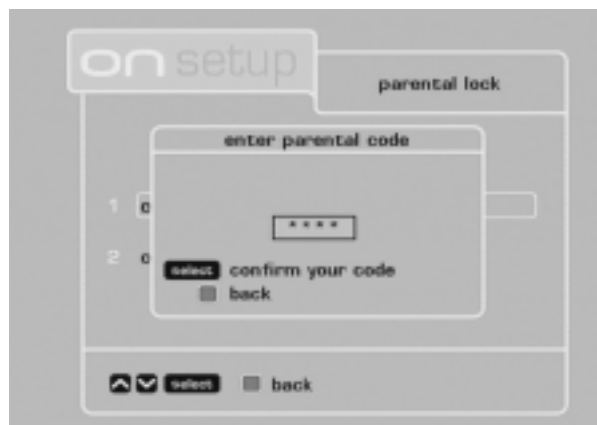

3. Please keep a note of the number you select for future reference.

4. When you have entered the code and made a note of it, press the **SELECT** button to store the code in the memory of your digital receiver. If for any reason the code is not accepted, the entry will be cleared and you will be prompted to enter another code.
5. Press the **RED** button to return to the “main parental code” menu or **EXIT** to return to normal operation.

## TO CHANGE YOUR PARENTAL CODE

Once a code has been entered, the parental lock menu will give you the option of changing your current code. In order to do this, you will need to enter the current code before a new code can be entered.

1. From the main menu, select the parental lock option followed by the change parental code option.



2. The display will ask you to enter your current code, this time asterisks will be displayed as the code is entered. If necessary, use the **LEFT** arrow button to correct any mistakes.
3. When you have entered the code, press the **SELECT** button. If you entered the code correctly, it will be cleared and the screen will prompt the entry of a new code.  
**Note:** If you have entered an incorrect code, an error message will be displayed and you will be asked if you want to try again.
4. Enter your new code in the same way, this time it will be displayed on-screen as you enter the code. Press the **SELECT** button to confirm. Remember to make a note of your new code as you enter it.
5. Press the **RED** button to return to the main parental lock menu or **EXIT** to return to normal operation.

**Note:** If you forget your parental code, contact ONdigital customer services on 0870 600 9696 who can reset it for you.

## 9.2 SELECTING CHANNELS TO BE LOCKED

1. From the parental lock menu, select the choose channel to lock or unlock option and by pressing the **SELECT** button you will be asked to enter your current code and then a complete list of all available channels will be displayed.
2. Use the **UP** and **DOWN** arrow buttons to select the channels that you wish to lock. With one of these channels highlighted, press the **SELECT** button to lock the channel. A “padlock” symbol will appear alongside the selected channel to confirm that it has been locked.
3. Continue to select other channels that you wish to lock in the same way.
4. Press the **GREEN** button as indicated on screen to lock (closed padlock) or to unlock (opened padlock) channels.
5. Press the **EXIT** button to return you to a normal TV picture.

## 9.3 WATCHING YOUR LOCKED CHANNELS

Once you have locked all the required channels, there are 2 ways to regain access and watch these channels. You can either unlock individual channels as you select them or return to the choose channel to lock or unlock menu and temporarily unlock them all.

### TO UNLOCK INDIVIDUAL CHANNELS

1. When selecting a channel that has been locked the channel will not change and you will be asked to press the **SELECT** button to access the channel.



2. You will then be prompted to enter your parental code.



3. Using the number buttons, enter your code. As you do, asterisks will be displayed in the 4 digit field.
4. With the code entered, press the **SELECT** button to confirm the code. Providing that you entered it correctly the locked channel will be selected.

5. If the code was entered incorrectly, a message will appear on screen to advise that the code was incorrect and ask you to try again.
6. If necessary, repeat steps 4 and 5 until the correct code is entered. Alternatively, to escape from this option, press the **RED** button to take you back a step then select a channel which is not locked.

## TO TEMPORARILY UNLOCK ALL CHANNELS

1. If you temporarily want to unlock all your locked channels, the easiest way to do this is from the choose channel to lock or unlock menu. (Press **MENU**, then buttons 3 and 2 in turn).
2. Enter your current code where requested.
3. With the channel list displayed press the **GREEN** button as indicated on-screen, this will open all the padlocks. Pressing this button again will close the padlocks. The top of the screen will indicate whether the locks are open or close.

### **IMPORTANT:**

**Don't forget to your channels again after unlocking them all in this manner.**

## 9.4 RE-ARRANGING YOUR CHANNELS

This feature enables you to swap two channel positions within the total channel list, so that they are displayed in your preferred order.

1. Press the **MENU** button then button **5** and **2** to get access to change channel number menu.
2. A complete list of channels currently available on your digital receiver is displayed. (Alongside these channels will be symbols to indicate whether they have been selected as your favourite or locked channels).
3. To move a channel to an alternative location, firstly highlight the channel using the **UP** and **DOWN** arrow buttons and press the **SELECT** button to choose that channel.
4. Now select the new channel location using the **UP** and **DOWN** arrow buttons to highlight the channel number where you want to move the channel to. The original channel remains highlighted.
5. Lastly, press the **SELECT** button to swap the two channel locations. Repeat the above steps to move further channels or press the **EXIT** button to return to a normal TV picture.
6. Press the  button to store the new order of your channels.

## 9.5 SETTING THE TIMER

The timer settings function enables you to program your digital receiver to switch on and off at selected times, for upto 8 different time slots. Your video can then be set to record digital programmes.

At any stage of the following procedure, pressing the **RED** button on the remote will return you to the previous menu, or pressing the **EXIT** button will discard any changes that have been made and return your receiver to normal operation.

1. Firstly press the **MENU** button on the remote, to display the main menu. The setting the timer option will already be highlighted.
2. Select this option by pressing either the **SELECT** button or a number button 1 on your remote.
3. The screen will now show a list of 8 timer slots, each one indicating that it is either available for programming, or that it has a programme already stored in it.



4. Select an available row using the **UP** and **DOWN** buttons, then press the **SELECT** button to display the setting the timer screen. This screen asks you to confirm the date, channel number, start time, end time and the status of the programme (whether it is on only once, or whether it is repeated daily or weekly).



You can now start enter details of the programme you would like to record. All required buttons are on the remote.

5. Use the number buttons to enter the date. Only the day and month should be entered, the digital receiver will automatically know the year. You must enter a total of 4 digits, for example to enter 8th February 1999, press 0802.
6. Press the **DOWN** arrow button to confirm the entry and move to the channel number line.
7. Enter the channel number you want to record from by pressing the relevant number buttons.

8. Alternatively, if you do not know the number of the channel you want to record, you can choose from the channel list by pressing the **GREEN** button as indicated. The channel list will then be displayed. Use the **UP** and **DOWN** arrow buttons to find the channel you require and press the **SELECT** button. The channel number will then be added to the "set the timer" screen.
9. Press the **DOWN** arrow button to confirm the entry and move to the start time line.
10. Use the number buttons to enter the time when you want the receiver to switch on, preferably several minutes before you set your video recorder to start recording. Your receiver uses a 24 hour clock, so for example to switch on at 8.25pm, you should enter 2025. If you enter something incorrectly, the **LEFT** and **RIGHT** arrow buttons can be used to overwrite the entry.
11. Press the **DOWN** arrow button to confirm the entry and move to the next line.
12. Now enter the time you want your receiver to switch off, preferably after your video will have stopped recording. Again, you should enter 4 digits and in the 24 hour format. Press the **DOWN** arrow button to confirm the entry and move to the next line.
13. Use the **LEFT** and **RIGHT** arrow buttons to select the required recording frequency. The screen display will give you options of ONCE ONLY, DAILY or WEEKLY. Select the 1st option to record only once. Select the 2nd option if you want the receiver to record at these times every day, and select the 3rd option to record at that time on a weekly basis.
14. With all the details entered, press the **SELECT** button to confirm the settings and return to previous menu to check them, then press **EXIT** to return to normal mode or repeat from step 4 for additional timer setting.

If you have finished watching programmes on your digital receiver, you must leave your receiver in standby mode in order for the timer settings to be activated. Once the timer is active the message "rEC" is shown on the front panel display.

**THESE STEPS WILL NOW ACTIVATE YOUR DIGITAL RECEIVER, PLEASE REMEMBER YOU STILL NEED TO PROGRAM YOUR VIDEO RECORDER !**

## TIMER ALARM

If after setting the timer you wish to continue watching other digital a timer, you can do so by changing channels in the normal way. If you are watching another digital channel when the timer is due to start the timer alarm will sound and "rEd" will be shown on the front display. Press the **RED** button on your remote to display the following screen.



You have two choices, whether to change to the channel set in the timer or continue to watch the current channel.

- To change to the channel set in the timer, press the **SELECT** button. In this case the digital receiver will not go into standby at the end of the timer.
- To continue watching the current channel, press the **RED** button again.

## VIDEO RECORDING

As previously mentioned in the setting the timer section of this instruction book, it is not currently possible to record one digital channel whilst watching another. If you are recording a programme from your digital receiver, the channel you are recording is the only digital channel that can be watched.

You can however record a digital channel and watch an analogue channel on your TV, or vice versa.

## DELETING A TIMER

To delete a timer previously set, follow these steps:

1. Press **MENU** then button **1** (setting the timer).
2. Press **UP** or **DOWN** to select the timer you want to delete.
3. Press the **BLUE** button.

## 9.6 USING TELETEXT

Digital Terrestrial television gives you access to new and vastly improved digital teletext services, including high quality text and graphics as well as advanced navigational options.

### DIGITAL TELETEXT CHANNEL

Unlike previous teletext services, you now have access to dedicated digital teletext channels. These appear on their own channel numbers which you select like any other channels. Check the channel list to see what channel numbers these services are on.

Individual teletext pages can be selected using the arrow buttons followed by the **SELECT** button. Alternatively, the number or coloured buttons can be used.

### OTHER DIGITAL TELETEXT AND INFORMATION SERVICES

Other digital channels may also operate digital teletext or information services. These can be selected either by choosing the appropriate channel number or by pressing the text button on your remote whilst you are watching a digital channel that includes teletext services.



## 9.7 CHECKING YOUR POSTBOX

Your digital receiver has the ability to display messages that have been sent to you by a broadcaster, perhaps about a special offer or your current subscription package.

This service will be available during 1999, when ONdigital will give you more details about how this will benefit you.

You will see when a message is waiting to be read by the message "POST" appearing in the LED on the front of your digital receiver.



Your personal postbox can then be accessed through the main menu.

1. Press the **MENU** button and use the **UP** and **DOWN** arrow buttons to highlight the ONdigital update option. Alternatively press the number button 6.
2. From the next menu, choose option 2, "check your postbox" by either pressing the number 2 button or using the **DOWN** arrow button to highlight, followed by the **SELECT** button.
3. Your current messages will then be displayed, the most recent message appears at the top of the screen, with previous messages following.



4. Should you wish to check previous messages, you can scroll around the screen by pressing the **UP** or **DOWN** arrow buttons on your remote. Each time you re-enter the postbox, the latest message will always appear first.
5. When you have read your messages, you can return to normal operation by pressing the **EXIT** button.

### NOTE:

**Messages cannot be manually deleted, but the oldest messages are automatically removed as new messages are received.**

## CHECKING YOUR SUBSCRIPTION

When you access your postbox, you will notice another menu with the option of checking your subscription. Selecting this option will display the current expiry date of your subscription account.

## 9.8 ALTERING YOUR ONdigital BOX SETTINGS

This menu offers the following options, enabling you to set the preferred language, subtitles, tv volume, info display time and timer alarm. The steps involved in making changes to these options are described below.

1. To see the receiver settings menu, press the **MENU** button, then 4 (viewing references), then 1 (ONdigital box settings) on your remote. Each option can be highlighted using the **UP** and **DOWN** arrow buttons.

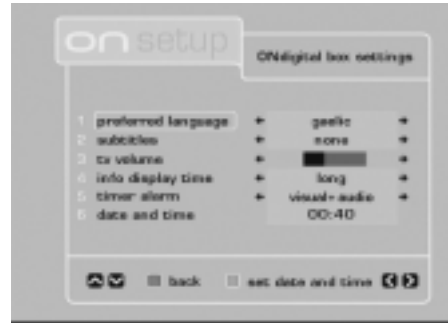

2. When the required option is highlighted, you can make adjustments using the **LEFT** and **RIGHT** arrow buttons.
3. When you have made the adjustment, press the **RED** button followed by the **EXIT** button on your remote to save the new setting and return to a normal TV picture.

An explanation of each option is detailed below:

### PREFERRED LANGUAGE

When your receiver is first switched on, the default setting for this option will be English. Other options are Welsh and Gaelic. Should you wish to change the language, use the **LEFT** and **RIGHT** arrow buttons. If the language selected is not available, the receiver will use English as a default.

### SUBTITLES

Similarly, this option will allow you to choose the language that subtitles are displayed in. Options are English, Welsh, Gaelic and None. If any of the languages are selected, subtitles will always be displayed when they are available. The **SUBTITLE** button on your remote, can be used to switch the subtitles on and off. The option also includes a setting for hard of hearing people, indicated by a symbol next to the language. This means that the subtitles will also include descriptive text, such as telling the viewer when there is laughter or applause.

If the none option is selected, subtitles will not be displayed, even if they are available, unless the **SUBTITLE** button on your remote is pressed.

You will know if subtitles are available for a programme either by a symbol that appears when you look at the channel list, or if you are made aware of this by a broadcaster.

### TV VOLUME

This option sets the default sound output level at wake up from your receiver to your TV. This is factory set to a medium level, but you may notice that when switching between channels on your digital receiver and channels on your normal TV, that the volume differs.

With this option highlighted, use the **LEFT** and **RIGHT** arrow buttons to adjust the digital receivers volume to minimize this sound difference.

**Note:** You should use the TV multibrand remote supplied with your digital receiver to adjust volume levels (consult chapter 3 and 10), alternatively use your TV remote.

## INFO DISPLAY TIME

With this option you can set the length of time that on-screen information is displayed. This only applies to screens that you do not make adjustments to such as channel change. The options available are off, normal or long.

### IMPORTANT:

If this option is set to Off, certain menus will no longer appear on-screen at all.

## TIMER ALARM

This option enables you to select either visual or audio&visual for the timer alarm. The alarm is factory set to audio&visual, and as such will give a warning when a programme is about to start for which the timer has been set. Your digital receiver will display the code rEd on the LED and will beep. More information on how the timer works is included in section 9.5.

## TIME and DATE

Your digital receiver will automatically set the current time and date by taking information from broadcasters. However, should you wish to adjust these settings, you can do so manually using this menu.

Use the number buttons to enter the correct details, remembering that the time should be entered in a 24 hour clock format.

## 9.9 ALTERING SETTINGS FOR YOUR TV and VIDEO

The settings that appear on this menu when you install your receiver have been made by the factory, and in most case need not be changed. Press the **MENU** button, then button 4 (viewing preferences) and button 2 (TV and video settings) to display the menu below.

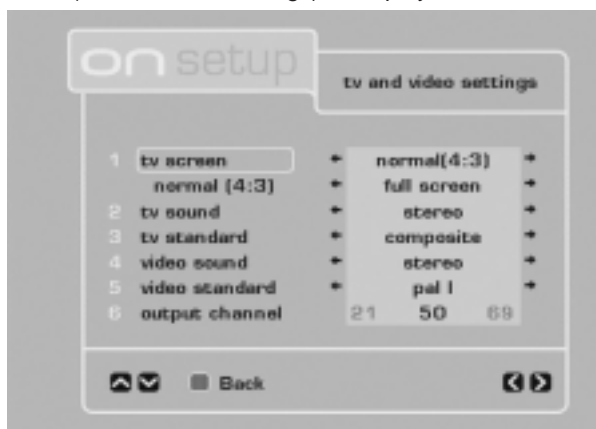

Each option is briefly described below. Pressing the **EXIT** button at any stage of this menu will return you to a normal TV picture.

In all instances, the **UP** and **DOWN** arrow buttons should be used to select the required option and the **LEFT** and **RIGHT** buttons to amend the setting.

### TV SCREEN

This option enables you to tell the receiver whether you have a 4:3 or 16:9 (widescreen) TV. If you select 16:9 in this option, the receiver will automatically display any widescreen programmes in the correct format.

If you choose 4:3, a further option will be highlighted below that enables you to select how you would like a widescreen programme to be shown on your standard 4:3 TV.

## **NORMAL 4:3 (only available if 4:3 is selected in item 1 of this menu)**

If you have a 4:3 TV, you need to choose whether widescreen programmes are shown in a letterbox format ie. with blank areas at the top and bottom of the TV screen, or whether the programme is expanded to fill the height of the screen, but as a result parts of the picture at the side are lost.

While watching a programme the **WIDE** button switches between "letterbox" and "full screen" picture format.



4 : 3 full screen



4 : 3 letter box

## **TV SOUND**

This gives you the option of selecting either mono or stereo sound. As a default, stereo has been selected. You need only change this selection if you are connecting to a mono TV.

## **TV STANDARD**

If you have connected your digital receiver and your TV by a scart lead, you should try adjusting this option to ensure the best possible picture. The receiver will default to a setting called "composite". However you may see further improvement if you select the alternative "rgb" option.

Change the option as previously described. If you do not notice any difference in the picture quality, please ensure the setting remains on composite and exit the menu.

## **VIDEO SOUND**

Leave this set to "stereo".

## **VIDEO STANDARD**

Leave this set to "pal I"

## **UHF OUTPUT CHANNEL**

This is another setting that has been made during manufacture which you should not find necessary to adjust. It relates to the output frequency from your digital receiver to your TV (coaxial connection).

Should you be unable to tune a channel on your TV or video to watch pictures from your digital receiver, you may need to adjust this setting. It may also require slight adjustment if you can see a picture but there is also some interference. (Refer to chapter 4.1.2).

If you are in any doubt about adjusting this setting, please contact your local retailer or ONdigital customer services on 0870 600 9696

## 9.10 ALTERING MODEM SETTINGS

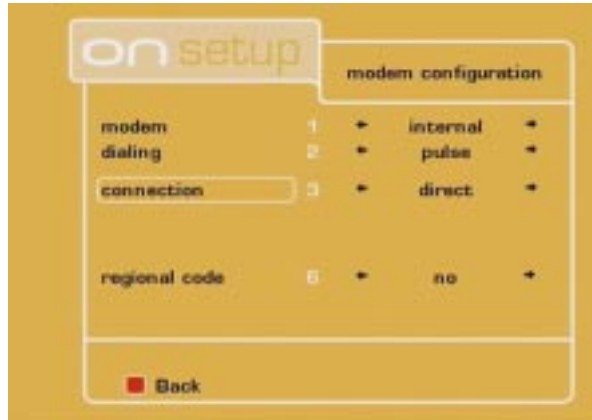

You may need to alter the settings within this menu when you connect your digital receiver to a telephone line. Press the **MENU** button, followed by number button 4 (viewing preferences) then 3 for modem settings.

### MODEM

This option enables you to tell the receiver if you are using the internal modem or have added an external modem.

### DIALLING

This option is to choose either tone or pulse dialling. Most domestic telephones use tone dialling. If you are unsure, check with your telephone company.

### CONNECTION

You will only need to change this setting to pabx if your digital receiver is connected to a phone line that requires you to dial a prefix for an outside line. Most domestic telephones will operate with a direct connection.

### PREFIX

This option is only available if you have chosen pabx in the connection option. You can then choose the prefix that the digital receiver will dial in order to get an outside line.

### WAIT FOR DIAL TONE

This option is only available if you have chosen pabx in the connection option. You can then adjust this setting depending on what your system requires.

### STD CODE

This allows you to tell the receiver whether it will always be required to dial an STD code.

### PREFIX

If you have selected to choose an STD code, this allows you to enter the code using the NUMBER buttons.

## 9.11 TECHNICAL INFORMATION

The options contained within the technical information menu enable you to check the status of your digital receiver. This is not something you should need to do, apart from in the unlikely event of a problem occurring with your receiver. In this instance, it will help the ONdigital customer services people to understand the problem and resolve it as quickly as possible. There are 3 options from the menu, signal strength, manufacturer data and auto update.

### SIGNAL STRENGTH

This section will help to determine the strength of signal that is available to your digital receiver. The display details the output channel that has been selected and the signal strength of that channel.

To enter the UHF number, press the **GREEN** button, enter the channel number and press the **RED** button to measure the signal strength.

You will not normally need to refer to this screen, but should you have any reception problems, it maybe referred to during a call to the ONdigital customer services.

## MANUFACTURER DATA

This option shows various information about your digital receiver, such as its manufacturer and the versions of hardware and software that it contains. This is another screen that will be used by the ONdigital customer service people.

## AUTO UPDATE

The final option on this menu can update the software used in your digital receiver. This may update certain menus or functions of your digital receiver, as well as add new features, but the general way in which it operates will not change.

Normally, this type of update will be broadcast to your receiver like any normal programme. The receiver will detect the broadcast and update itself the next time it is switched on. Whilst this is happening you may notice certain messages on the LED display on the front of the receiver. These messages and their meanings are described below.

On other occasions, you may be asked to start this update process by a member of the ONdigital customer services team. Before the update starts, a message will be displayed to ask if you want to go ahead as it may change some of the personal settings you have made on your receiver, such as locked or favourite channels.

## FRONT PANEL MESSAGES

The front panel display can also indicate the status of your digital receiver during an auto update.

Messages include:

Auto update – this is indicating that your digital receiver is searching for an updated version of software and then updating your receiver.

Update error – this will indicate that the software your receiver is currently using is in fact the most up to date version.

Retrying update – this message may be seen when a newer version of software has been located, but the receiver is having difficulty updating. In this instance, the auto update message will be seen again as the receiver continues the update process.

Out of order – this indicates that your receiver has tried to update the software it currently uses, but has been unsuccessful. It maybe necessary to contact your retailer, but if you are in any doubt, call ONdigital customer services on 0870 600 9696.

## 9.12 ADDING NEW CHANNELS

This function can be used to add channels to your existing list of stored channels. Follow these instructions should you wish to search for new channels that may have subsequently been launched by the broadcasters.

1. Press **MENU**, then button **5** (getting started), and button **3** (add channels).
2. During the channel search the display on screen will indicate the number of channels that have been found.
3. When the search is complete the channel list will be displayed showing any additional channel, that were found.

# 10

## IF YOUR DIGITAL RECEIVER 'S REMOTE INTERFERES WITH YOUR TELEVISION.

If you have interference between your digital receiver's remote control and your particular brand of television set, it may be because the television incorrectly responds to infra-red commands not intended for it.

Your digital receiver and remote can work with one of two infra-red coding systems A & B. The normal setting for your receiver and remote control is system A, these can however be changed to system **B**, to avoid conflict with your television set.

### 10.1 To change your digital receiver from system A to system B.

1. Ensure your digital receiver is switched off (if necessary press the **ON/OFF** button)
2. Press the **ON/OFF** button to switch on your digital receiver (the front display shows the time or "—:—"), your digital receiver will now be in standby.
3. Press and hold the **M** button on the front panel of your digital receiver for at least 3 seconds.
4. The front control panel of the digital receiver will now show "-SA-" (this stands for system A).
5. Press the ► (right arrow) button to change the display from "-SA-" to "-Sb-".
6. Press the **S** button to store the displayed setting, your digital receiver returns to standby and is now programmed to use system B.

**Note:** During the above process, if there is a time lapse of more than 10 seconds between key presses the digital receiver will return to standby.

Should you at any time wish to change your digital receiver back to system A commands, exactly the same sequence should be used except this time the ► (right arrow) button is used to change the display to "-SA-".

### 10.2 To change your remote control from system A to system B.

1. Locate the ⏻ (standby) and **TEXT** buttons on your remote control.
2. Simultaneously press and hold these two buttons for at least 3 seconds.
3. After releasing the ⏻ (standby) and **TEXT** buttons use the number buttons on the remote to enter the three digit code **161**.

Your remote is now programmed to work with system B commands.

**Note:** Should you at any time wish to change your remote control back, to work with system A commands, exactly the same sequence should be used except this time the code entered should be **160**.

#### **Important:**

If your remote is not powered for more than one minute, for instance when the batteries are changed, it is possible your remote could revert back to system A and no longer works your digital receiver.

Should this happen, please carry out the steps shown above to change the remote back to system B.

TV or Video settings you may have entered to operate products other than Philips will also be lost. Refer to chapter 11 "Programming the remote for your TV and Video" for information about these settings.

# 11

## PROGRAMMING THE REMOTE FOR YOUR TV AND VIDEO

Your remote can control different major-brand televisions and video's.

Initially your remote is programmed for Philips-brand televisions and video's. If you have different brands, follow the instructions below to set up your remote.

### **TV brand Setup**

This applies to the TV only.

1. Turn on the television you wish to control.
2. Locate the  and P+ buttons in the TV section of the remote control (as shown below).



3. Simultaneously press both of these buttons for at least 4 seconds.
4. Enter the 3 digit code for the TV (found on pages 32 and 33).
5. Aim the remote at the TV and press the **OFF** button located in the TV section. The television should now go to standby.
6. If the TV does not go to standby, repeat steps 2-5, trying each code listed for your brand of TV.

### **VIDEO brand Setup**

This applies to the video only.

1. Turn on the video for which the code needs to be identified.
2. Press and hold the “◀◀ and ▶▶” buttons simultaneously on the RC for a minimum of 4 seconds.
3. Enter the 3 digit code for the video (found on pages 33 and 34).
4. Aim the remote at the video and press the yellow ▶ button (keep the side button pressed when the yellow ▶ button is pressed). The video should start playback.
5. If the video does not start playback, repeat steps 2-4, trying each code listed for your brand of video.

### **Resetting your remote**

If necessary the remote can be reset to the factory default clearing all the pre-programmed codes.

**TV OFF** and  are pressed simultaneously for at least 4 seconds. This restores the remote to the factory setting.

### **Changing batteries**

When changing batteries in your remote, programmed codes will only be remembered for one minute. Be careful not to press any button when changing the batteries as this will also reset your remote.

**All manufacturers are concerned about the constant improvement of their products. Although the RC 2580 remote is compatible with most of the equipment of the following brand list, Philips cannot guarantee its operation with the complete range of products on the market.**



# BRAND CODE LIST

## CODES FOR TELEVISION

Acura	036	Finlandia	235, 373, 386
Admiral	190	Finlux	064, 097, 099, 132, 373, 438
Adyson	244	Firstline	036, 243, 244, 274, 321, 348
Akai	235, 388	Fisher	235, 244, 330, 397
Akura	245, 291, 396	Flint	482
Alba	036, 063, 064, 245, 398	Formenti	064, 347
Allorgan	321	Frontech	190, 274, 291, 458, 475
Amplivision	244, 427	Fujitsu	099, 233
Amstrad	036, 389, 396, 398, 439, 460	Funai	291, 321, 330
Anitech	036	GEC	064, 099, 244
Arcam	243, 244	GPM	245
Asuka	245	Geloso	036
Atlantic	233	Genexxa	190, 245
Audiosonic	064, 136	GoldStar	064, 136, 244, 317
Autovox	233, 363	Goodmans	063, 064, 099, 244, 344, 370, 398, 401
BPL	309	Gorenje	397
BSR	321	Graetz	190, 388
BTC	245	Granada	064, 099, 235, 244, 366, 386
Baird	370	Grandin	309
Basic Line	036, 245	Grundig	097, 218, 222, 514, 581
Baur	037, 064, 376, 388, 581	HCM	036, 309, 439
Beko	397	Hanseatic	064, 347, 388, 583
Beon	064	Hinari	036, 063, 064, 245
Binatone	244	Hisawa	309, 427, 482
Blaupunkt	218, 222, 227, 354, 355, 581	Hitachi	063, 071, 132, 136, 190, 223, 225, 244, 252, 333, 376, 575
Blue Sky	245	Huanyu	243, 401
Blue Star	309	Hypson	064, 291, 309
Bondstec	274	Ice	244, 291, 398
Boots	244	Ices	245
Brandt	136, 223, 225, 360, 362	ITS	398
Brionvega	389	ITT	190, 388, 575
Britannia	243	Imperial	274, 397, 445
Bush	036, 063, 064, 245, 309, 321, 376, 398, 401, 546	Indiana	064
CGE	274, 333	Ingelen	190
CS Electronics	243	Inno Hit	099
CTC	274	Interfunk	064, 190, 274, 388
Carrefour	063	Intervision	064, 129, 244, 291
Cascade	036	Isukai	245
Cathay	064	JVC	063, 080, 398
Centurion	064	Kaisui	036, 243, 244, 245, 309
Cimline	036	Kapsch	190, 233
Clarivox	064	Kathrein	583
Clatronic	274, 397	Kendo	064, 389
Condor	347, 397	Kingsley	243
Contec	036, 063, 243	Kneissel	286, 462
Continental Edison	223, 225, 360, 426	Korpel	064
Crown	036, 064, 397, 445	Koyoda	036
Crystal	458	Leyco	064, 099, 291, 321
Cybertron	245	Liesenk & Tter	064
Daewoo	036, 064, 401	Luma	233
Dainichi	242, 245	Luxor	376, 388
Dansai	064	M Electronic	036, 064, 132, 136, 190, 244, 314, 373, 401, 507
Dayton	036	MTC	376
De Graaf	235, 575	Magnadyne	129, 274
Decca	064, 099	Magnafon	129
Dixi	036, 064	Maneth	244, 291, 347
Dual	363, 379, 546	Marantz	064, 583
Dual Tec	244	Mark	064
Dumont	097	Matsui	036, 062, 063, 064, 099, 235, 244, 321, 398, 470, 514
Elbe	286	Mediator	039, 064
Elin	064, 575	Memorex	036
Elite	245, 347	Memphis	364
Elta	036	Metz	394
Emerson	388	Minerva	097, 514, 581
Erres	039, 064	Minoka	396, 439
Expert	233	Mitsubishi	063, 135, 177
Ferguson	064, 136, 265, 314, 362, 370		
Fidelity	243, 388		

Mivar	243, 317, 318, 319	Sonoko	036, 064
Multitech	036, 129, 243	Sonolor	190, 235, 242
NEI	064, 364, 458	Sontec	064
Neckermann	064, 218, 376, 581, 583	Sony	037, 063
Nikkai	062, 064, 099, 243, 245, 291, 364	Soundwave	064, 445
Nobluko	129	Standard	036, 244, 245
Nokia	388, 507, 575	Stern	190, 233, 286
Nordmende	136, 223, 225, 314, 370	Sunkai	321, 348
Oceanic	190, 242, 388	Susumu	245
Onwa	460	Sysline	064
Orion	064, 321, 347, 348, 470	Tandy	099, 190, 244, 245
Osaki	099, 244, 245, 291, 439	Tashiko	063, 244, 386
Oso	245	Tatung	064, 099, 244
Osume	099, 184	Tec	244, 274
Otake	344	Technema	347
Otto Versand	037, 063, 064, 218, 244, 347, 370, 376, 581, 583	Technics	277
Palladium	397, 445	Teleavia	360, 370
Panama	244, 291	Telefunken	136, 333, 362, 370, 498, 525
Panasonic	190, 253, 277, 394	Telemeister	347
Pathe Cinema	243, 265, 347	Teletech	036
Pathe Marconi	223, 225, 360	Teleton	233, 244, 376
Pausa	036	Tensai	245, 321, 344, 347
Perdio	347	Texet	243, 245
Philco	274	Thomson	136, 223, 225, 314, 360, 370, 376, 426
Philips	039, 064, 401, 581, 583	Thorn	062, 064, 099, 370, 388
Phonola	039, 064	Tomashi	309
Pioneer	136, 190, 314	Toshiba	062, 063, 097, 270
Profex	036, 388	Triumph	270
Proline	348	Uher	233, 330, 347
Protech	036, 064, 129, 244, 274, 291, 364, 445, 458	Ultravox	129
Pye	039	Universum	064, 132, 291, 373, 397, 519
Quelle	037, 064, 097, 227, 333, 354, 355, 388, 581	Vestel	064
Questa	063	Videosat	274
R-Line	064	Videotechnic	244
RBM	097	Vision	347
Radiola	039, 064	Voxson	190
Rank Arena	063	Waltham	244
Rediffusion	388	Watson	064, 347
Revox	064	Watt Radio	129
Rex	190, 233, 286, 291	Wega	063
Roadstar	036, 245, 291, 445	White Westinghouse	064, 243, 347
SBR	039, 064	Yoko	064, 244, 291, 458
SEG	063, 244, 291	Zanussi	233
SEI	129, 321		
Saba	136, 190, 223, 225, 314, 362, 370		
Saccs	265	<b>CODES FOR VCR</b>	
Saisho	036, 291, 458	ASA	064, 108
Salora	190, 376, 386, 388, 575	Aiwa	027, 375, 379
Sambers	129	Akai	068, 080, 133, 342
Samsung	036, 064, 117, 244, 291, 317, 397, 583	Akiba	099
Sandra	243	Alba	047, 099, 236, 305, 342, 379
Sanyo	063, 099, 184, 235, 366	Ambassador	047
Schaub Lorenz	388	Amstrad	027, 305, 359
Schneider	064, 245, 274, 330, 363, 379, 398, 421	Anitech	099
Sei-Sinudyne	037	Asuka	064
Seleco	190, 233, 286, 389, 438	Baird	027, 068, 131
Sentra	062	Basic Line	047, 099, 305
Sharp	063, 120	Blaupunkt	030, 033, 061, 181, 189, 222, 253, 254, 430
Shorai	321	Brandt	214, 347, 348
Siarem	129	Brandt Electronic	068
Siemens	064, 184, 218, 222, 227, 354, 355, 581	Bush	099, 236, 305, 379
Silver	063	CGE	027
Sinudyne	129, 321	Catron	047
Solavox	190	Cimline	099
Sonitron	235	Clatronic	047
		Combitech	379
		Condor	047
		Crown	047, 099, 305
		Cyrus	108
		Daewoo	047, 305
		Dansai	099

De Graaf	069, 193	Pathe Cinema	063
Decca	027, 108	Pathe Marconi	068
Denon	069	Pentax	069
Dual	068	Perdio	027
Dumont	027, 108, 131	Philco	065
ESC	267, 305	Philips	108, 411, 430
Elbe	065	Phonola	108
Elcotech	099	Pionner	094, 108
Ferguson	068, 347, 348	Portland	047
Fidelity	027	Profex	349
Finlandia	108, 131	Profitronic	267
Finlux	027, 069, 108, 131	Proline	027
Firstline	064, 070, 072, 099, 236	Pye	108
Fisher	073, 074, 131	Quartz	073
frontech	047	Quelle	108
Funai	027	RFT	430
GEC	108	Radiola	108
General	047	Rex	068, 411
GoldHand	099	Roadstar	064, 099, 267, 305
GoldStar	064, 252	SBR	108
Goodmans	027, 047, 064, 099, 305, 430	SEG	267, 349
Graetz	068, 131, 267	SEI	031, 108
Granada	073, 108, 131	Saba	068, 233, 234, 324, 347, 348, 411
Grandin	027, 064, 099	Saisho	031, 063, 236
Grunding	030, 033, 034 ; 099, 108, 222, 234, 253, 374, 376, 430	Salora	070, 073, 133
HCM	099	Samsung	267, 459
Hanseatic	064	Sansui	068, 094
Hinari	031, 099, 267, 379	Sanyo	073, 131
Hitachi	027, 031, 068, 069, 193, 267	Saville	379
Hypson	099	Schaub Lorenz	027, 068, 131
ITT	068, 073, 131, 133, 267, 411	Schneider	027, 099, 108
ITV	064, 305	Seleco	068
Imperial	027	Sentra	047
Ingersol	031	Sharp	075
Interfunk	108	Shintom	099, 131
JVC	035, 068, 094, 233, 234, 411	Shorai	031
Kaisui	099	Siemens	030, 033, 064, 108, 131, 222
kendo	133, 236	Silva	064
Kenwood	068	Singer	072
Korpel	099	Sinudyne	031, 108
Lenco	305	Solavox	047
Leyco	099	Sonolor	073
Loewe	031, 033, 064, 108, 189	Sontec	064
Logik	031, 267	Sony	038, 059, 060, 061
Luxor	070, 073, 075, 131, 133	Sunkai	375
M Electronic	027	Sunstar	027
Manesth	072, 099	Suntronic	027
Marantz	030, 033, 108	Tashiko	027
Matsui	031, 063, 236, 375, 379	Tatung	027, 068, 108
Melectronic	065	Tec	047
Marantz	030, 033, 108	Technics	189, 253
Matsui	031, 063, 236, 375, 379	Teleavia	068
Melectronic	065	Telefunken	068, 214, 347, 348, 411
Memorex	027, 064, 073, 131	Tenosal	099
Memphis	099	Tensai	027, 349
Metz	030, 033, 189, 222, 254, 374	Thomson	068, 347, 411
Minerva	033, 222	Thorn	063, 068, 131
Mitsubishi	070, 094, 108	Toshiba	068, 070, 072, 108, 411
Multitech	027, 099	Towada	349
Murphy	027	Uher	267
Nec	065, 068, 094	Universum	027, 033, 064, 108, 133, 222, 267
Neckermann	108	Yamishi	099
Nesco	099	Yokan	099
Nokia	068, 073, 131, 133, 267	Yoko	047, 267
Nordmende	068, 324, 347, 348, 411		
Oceanic	027, 068		
Okano	342, 375		
Orion	031, 063, 236, 375, 379		
Osaki	027, 064, 099		
Otto Versand	108		
Palladium	033, 064, 068, 099		
Panasonic	189, 253, 254		

# 12 TROUBLESHOOTING

Experiencing difficulty operating your digital receiver? Check the following points first!

<b>Problem</b>	<b>Possible cause</b>	<b>Action</b>
No picture, no sound and no front panel display.	Receiver is not plugged into the mains or is not switched on.	Check mains connection. Press the ON/OFF button on the front of the receiver.
No picture, no sound but the front panel shows the time or - - : - - .	The receiver is in standby.	Press the standby button or any number button to bring the receiver out of standby.
No picture, no sound but the front panel shows a channel number.	You are viewing standard analogue television.	If you have used a scart cable when connecting, press the TV/DTV button on your remote. If you have not used scart, make sure your TV is on the channel that has been tuned for watching digital.
	The scart connection has been made wrong or your TV has not selected the correct AV/EXT channel.	Check scart connections, making sure cables are firmly pushed into the sockets. Try manually selecting the AV/EXT channel on your TV.
The remote does not operate.	Your receiver could be in standby, if it is, it will show the time.	Press the standby button on your remote to bring the receiver out of standby. The front panel will then show a channel number.
	The batteries have been inserted incorrectly or are dead.	Check the condition of the batteries and replace if necessary, according to instructions earlier in this book.
	Your are not pointing your remote at the receiver.	Make sure you point the remote at the receiver and not directly at your TV.
You cannot find all the channels you think should be available.	The signal to your aerial may be weak.	Try retuning your receiver, following the relevant steps in chapter 7. If you are still missing channels, your aerial may need adjusting.
	Your aerial may need adjusting or your local transmitter may not be working.	Call ONdigital customer services on 0870 600 9696. They will check this for you.
You can see interference on your normal TV channels or your video.	Your digital receiver is interfering with the frequency of your other equipment.	Your need to change the UHF output of your receiver as described in section 4.1.2. of this book.
You sometimes see a red dot or square on the screen, or your picture is "freezing".	There could be a transmission problem.	This is normally only a temporary situation and should correct itself. If it persists, contact ONdigital customer services.
	Your aerial may have been moved, for example by severe weather.	Check and if necessary re-align your aerial.
	Your connecting cables have become loose or disconnected.	check all connections and make sure they are all firmly pushed into sockets.
I cannot select all of my channels and the P+/- or Arrow up/down buttons do not always work.	Some channels have been selected as favourites and the favourites mode is on.	Using the number buttons will enable you to select all of your channels all of the time. The P+/- and arrow buttons will only select favourite channels when favourites are on. See chapter 8.5.
Even if I use the number buttons I cannot access a particular channel.	The parental lock has been activated on this channel.	Enter your parental code to access the channel or remove it as a locked channel. See sections 9.1 to 9.3 for more details.

<b>Problem</b>	<b>Possible cause</b>	<b>Action</b>
I have forgotten my parental code.		Call ONdigital customer services who can help you enter a new code.
I set the timer but it did not record what I wanted.	The video was set incorrectly.  Your receiver was not left in standby.  You were watching another digital channel and ignored the timer alarm.	Make sure that your video is set for the same time as your digital receiver.  If you set the timer and have finished watching TV, make sure you put your receiver into standby, otherwise it will not activate.  If you set the timer and continued watching, you must change to the timer channel when the alarm activates. See section 9.5 for more detail.
When I have more than 1 programme in the timer, I sometimes miss the beginning of the second programme.	The timer automatically adds 5 minutes to the start and end times set in the timer. If the 2nd programme starts immediately after the first, this can delay the start of the second recording.	Only set the timer for the exact time of the programme. Allow for the 5 minutes run in and out times when setting more than one event.
There is no picture on certain channels but the channel name is displayed.	Your ONdigital subscription does not currently include these channels	To add channels to your subscription, call ONdigital customer services.
Pressing the TV/DTV button does not do anything.	You have not connected your digital receiver and TV by a scart lead.	Use a scart lead if possible, but if you cannot this button will have no function. This is not a fault.
The order of my channels has changed.	They have been re-arranged as described in section 9.4.	Refer to this section to change the order again.
The remote will not operate my TV or video.	An incorrect code has been entered into the remote.	Refer to section 11 to make sure that the right codes are being used for your other equipment.
The on-screen displays are not as sharp as I expected.	If you have connected using scart and you have an RGB compatible TV, one of the TV settings could be wrong.	Refer to chapter 9.9 and alter the TV standard to RGB.
The picture on some channels seems to have been stretched or squashed.	The broadcast is probably in widescreen and the receiver settings may not be correct.	Check the receiver settings, following the information in chapter 9.9. If you have a widescreen TV, you may also need to check the settings on your TV.

# 13 DTX 6372 DIGITAL TERRESTRIAL RECEIVER

## System capabilities

- DVB compliant MPEG-2 reception of broadcasts up to Main Profile @ Main Level

## Video decoding

- MPEG-2 DVB compliant up to MP@ ML
- Video bit rate : up to 15 Mbit/sec
- Video format : 4 :3 and 16 :9
- Resolution: up to 720x576 pixels

## Audio decoding

- MPEG layer I / II (excluding multichannel management from one bitstream)

## Operation/Features

- Automatic program loading via scanning installation
- Free to air reception
- DVB subtitles
- Program parental lock with PIN code
- Audio mode :single channel, dual channel, stereo, joint stereo
- Volume control
- Fully remote controlled
- Menu controlled operation using On Screen Display
- Menu controlled installation using On Screen Display
- 8 events over one year VCR timer
- Automatic VCR play back
- Receiver compatible with ONdigital services
- Electronic program guide for ONdigital bouquet services
- Mains switch
- Multibrand TV and VCR remote control

## Reception-Demodulation

- Demodulation according DVB-T
- Type COFDM 2K
- Mode All modes
- Non hierarchical

## Descrambling

- Type DVB
- Implementation Internal
- Smart card : 1 x for CA
- Note : subscription is required for the reception of ONdigital scrambled services

## Connections

- RF input (for aerial) connector Female IEC 169-2
- Input frequency range (MHz) 470-868 (CH21 to 69)
- Input level range (dBµV) 40 to 80
- RF output (to TV) connector Male IEC 169-2
- Loophrough frequency range (MHz) 470-868 (CH21 to 69)
- Remodulated output PAL I CH21-69 range Preset CH38
- TV SCART
- Output : CVBS , Controlled audio L/R RGB , Slow blanking, Fast blanking
- VCR SCART
- Input : CVBS, Slow blanking , Audio L/R
- Output : CVBS, Audio L/R
- Audio CINCH :
- Output : Controlled audio L/R
- Serial interface : RS 232 / DB 9 female
- Integrated modem telephone line interface : RJ-11
- Common interface for type II or III module

## Return path

- Integrated Telephone modem
- Type V22 bis
- Error correction V42
- Dialing mode DTMF and pulse

## Accessories

- Remote control : RC6 coding Type RC2580
- Scart cable
- Instruction for use
- Worldwide Guarantee booklet
- Starter kit including Smart card
- Telephone cord with plugs (10 m)
- Batteries : 2 x 1.5V type AA/R06/UM-3
- UHF coaxial lead
- Mains cord

## Miscellaneous

- Temperature range (°C)
- Operating +5 to 45
- Storage -10 to +70
- Mains 230 V ~ +/-10% 50 Hz

### DTX 6372 :

- Power consumption (W) 17 max
- Standby consumption (W) 8 max
- Weight (kg) 2.30
- Including packaging (kg) 3.65
- Dimensions (wxhxd mm) 380x60x255
- Including packaging 470x150x350

### DTX 6370 and DTX 6371 :

- Power consumption (W) 17 max
- Standby consumption (W) 10 max
- Weight (kg) 2.500
- Including packaging (kg) 3.850
- Dimensions (wxhxd mm) 380x71x255
- Including packaging 470x150x350

## REAR PANEL TERMINALS (refer to rear view of chapter 2).

- |  |   |
|--|---|
| 1 230 V - 50 Hz power cord socket. (excessive voltage) | 5 RS 232 serial port socket (SELV).           |
| 2 RJ11 connector for telephone line (TNV 3).           | 6 Audio-cinch outputs for HIFI system (SELV). |
| 3 SCART socket for TV(SELV).                           | 7 SCART socket for video (SELV).              |
| 4 UHF aerial output for TV (SELV).                     | 8 Common interface (SELV).                    |
|  | 9 UHF aerial input (SELV).                    |

SELV: Safety Extra Low Voltage.

TNV 3: Telecommunication Network 3.

Due to continued product improvements, this information is subject to change without notice.



## Free Manuals Download Website

<http://myh66.com>

<http://usermanuals.us>

<http://www.somanuals.com>

<http://www.4manuals.cc>

<http://www.manual-lib.com>

<http://www.404manual.com>

<http://www.luxmanual.com>

<http://aubethermostatmanual.com>

Golf course search by state

<http://golfingnear.com>

Email search by domain

<http://emailbydomain.com>

Auto manuals search

<http://auto.somanuals.com>

TV manuals search

<http://tv.somanuals.com>