

PHILIPS

PR0930X4 Owner's Manual



Read this manual first!

Congratulations on purchasing this product. If you have any problems, our Representatives can help you get the most from your new product by explaining:

- Hookups
- First Time Setup, and
- Feature Operation

Do not attempt to return this product to the store.

For fast help, call us first!

1-800-531-0039

Thank you for making us a part of your home!

TABLE OF CONTENTS

Getting Started

Warning/Precautions1

Features1

Registration1

Hooking Up Your TV2-4

Auto Install5

Basic TV and Remote Control Operation5

Features

Channel Edit6

Language6

Volume6

Sleeptimer6

Picture Adjustments7

FM Mode7

General Information

Glossary7

Tips8

Index8

Warranty8

**Federal Communications Commission
Warning: Any unauthorized changes
or modifications to this equipment
void the user's authority to operate it.**

For Customer Use

Enter below the Serial Number and the Model Number of your television (located on the back of the TV). Keep this information for future reference.

Model No. _____

Serial No. _____

This manual, your new product, and the packaging contain materials that can be recycled and reused. Specialized companies can recycle your product to increase the amount of reusable materials and to minimize the amount that needs to be disposed properly. Your product uses batteries that should not be thrown away when depleted but should be disposed as small chemical waste. Please find out about the local regulations on disposal of your old product, batteries, manual, and packaging whenever you replace existing equipment.



**This owner's manual is
made of recycled paper.**

Copyright 2002 by Philips Consumer Electronics. All rights reserved.

FEATURES

- **Infrared Remote Control** operates your TV and helps you set up on-screen features.
- **Standard Broadcast (VHF/UHF) or Cable TV (CATV) channel capability**
- **Auto Install** quickly and easily selects stations available in your area.
- **Sleeptimer** automatically turns off the TV within a set amount of time.
- **Language Selection** allows you to choose English or Spanish on-screen menus.
- **Automatic Shut Off** turns off the TV after 15 minutes when it is on a channel that is not receiving a broadcast signal (for example, if a station has gone off the air for the night).
- **FM Mode** allows you to listen to FM radio stations through the TV.

Return your Warranty Registration card today to ensure you receive all the benefits you're entitled to.

Once your PHILIPS purchase is registered, you're eligible to receive all the privileges of owning a PHILIPS product. So complete and return the Warranty Registration Card enclosed with your purchase at once. And take advantage of these important benefits.

Warranty Verification

Registering your product within 10 days confirms your right to maximum protection under the terms and conditions of your PHILIPS warranty.

Owner Confirmation

Your completed Warranty Registration Card serves as verification of ownership in the event of product theft or loss.

Model Registration

Returning your Warranty Registration Card right away guarantees you'll receive all the information and special offers which you qualify for as the owner of your model.

Congratulations on your purchase, and welcome to the "family!"



Dear PHILIPS product owner:

Thank you for your confidence in PHILIPS. You've selected one of the best-built, best-backed products available today. And we'll do everything in our power to keep you happy with your purchase for many years to come. As a member of the PHILIPS "family," you're entitled to protection by one of the most comprehensive warranties and outstanding service networks in the industry.

What's more, your purchase guarantees you'll receive all the information and special offers for which you qualify, plus easy access to accessories from our convenient home shopping network.

And most importantly you can count on our uncompromising commitment to your total satisfaction.

All of this is our way of saying welcome—and thanks for investing in a PHILIPS product.

Sincerely,

Lawrence J. Blanford

Lawrence J. Blanford
President and Chief Executive Officer

P.S. Remember, to get the most from your PHILIPS product, you must return your Warranty Registration Card within 10 days. So please mail it to us right now!

Know these safety symbols



⚡ This "bolt of lightning" indicates uninsulated material within your unit which may cause an electrical shock. For the safety of everyone in your household, please do not remove product covering.

⚠ The "exclamation point" calls attention to features for which you should read the enclosed literature closely to prevent operating and maintenance problems.

WARNING: TO PREVENT FIRE OR SHOCK HAZARD, DO NOT EXPOSE THIS EQUIPMENT TO RAIN OR MOISTURE.

CAUTION: To prevent electric shock, match wide blade of plug to wide slot and fully insert.

ATTENTION: Pour éviter les choc électriques, introduire la lame la plus large de la fiche dans la borne correspondante de la prise et pousser jusqu'au fond.

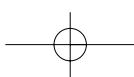

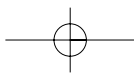

HOOKING UP YOUR TV (ANTENNA/CABLE CONNECTIONS)

ANTENNA

COMBINATION UHF/VHF

A combination antenna or a rod antenna (supplied) receives normal broadcast channels (VHF 2-13 and UHF 14-69). Your connection is easy since there is only one 75Ω (ohm) antenna jack on the back of your TV - and that's where the antenna goes.

BEGIN

1 If you install a rod antenna (supplied), push the base of the antenna into the antenna hole on either the left or the bottom of the TV. **If your antenna has a round connector (75Ω),** then you're ready to connect it to the TV. Go to step 2. **If your antenna has flat twin-lead wire (300Ω),** you first need to attach the antenna wires to the screws on a 300 to 75Ω adapter (not supplied).

2 Push the round end of the adapter (cable or rod antenna) onto the **ANT(enna) IN jack on the back of the TV.** If the round end of the adapter or cable is threaded, screw it down tight.

3 If you installed a rod antenna, extend the antenna and adjust its length, direction, and angle for the clearest picture.

STOP

SMART HELP

To set the TV to select only the channel numbers in your area, see Auto Install on page 5.

If you install the TV beneath a kitchen cabinet, you may push a rod antenna into the antenna hole on the bottom of the TV cabinet for the best use. See page four for details on how to install the TV under a kitchen cabinet.

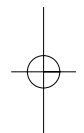
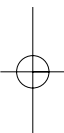
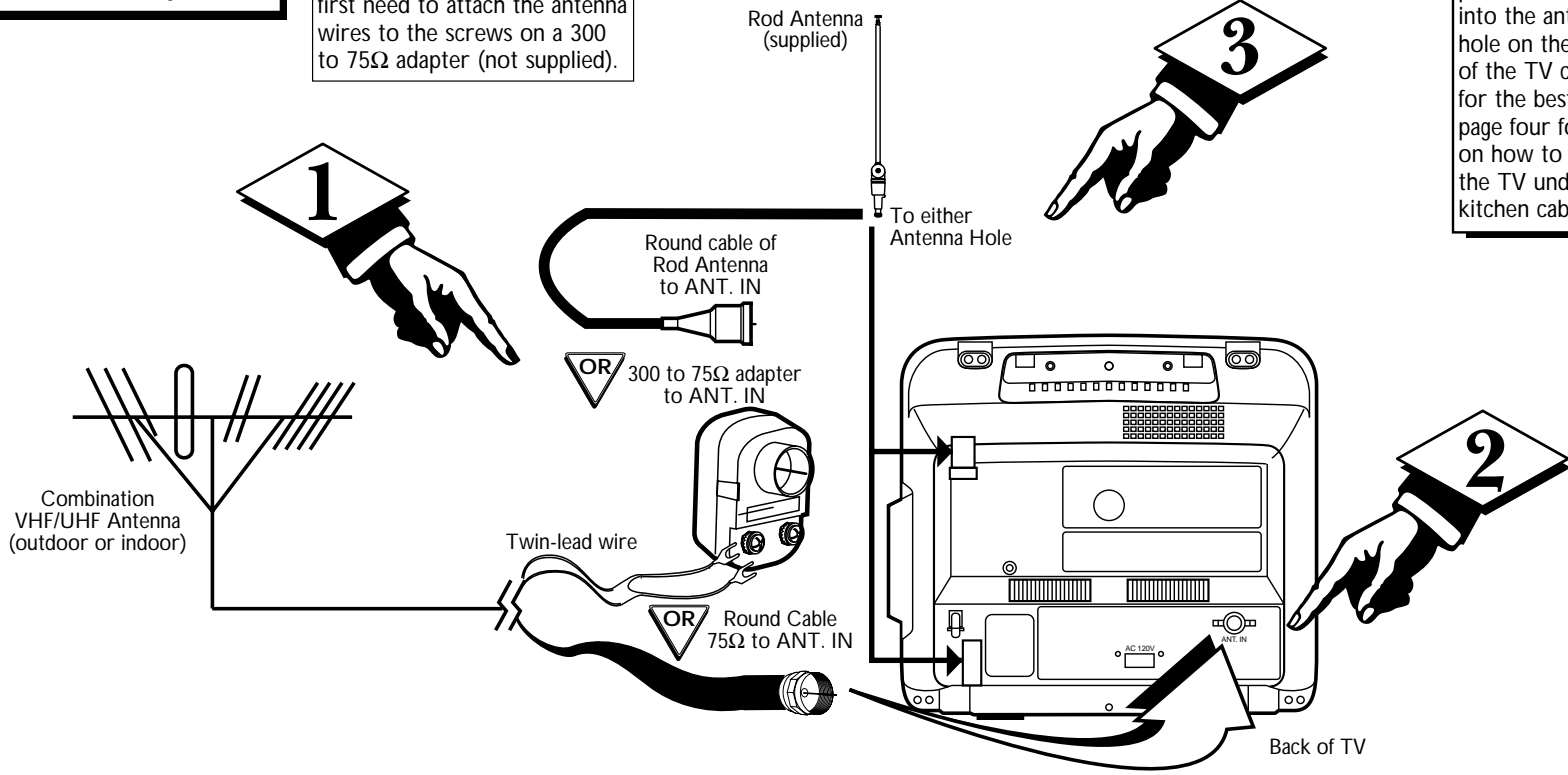

BEGIN

SEPARATE UHF/VHF

You may have two separate antennas. One antenna is for VHF channels (2-13) and the other antenna is for UHF channels (14-69). For homes with separate UHF/VHF antennas, you will need an optional combiner before you can connect the antennas to the TV.

1 Attach the separate UHF and VHF antennas to the correct screws on the combiner (not supplied).

2 Push the round end of the combiner onto the **ANT(enna) IN jack on the back of the TV.**

STOP

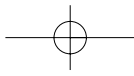
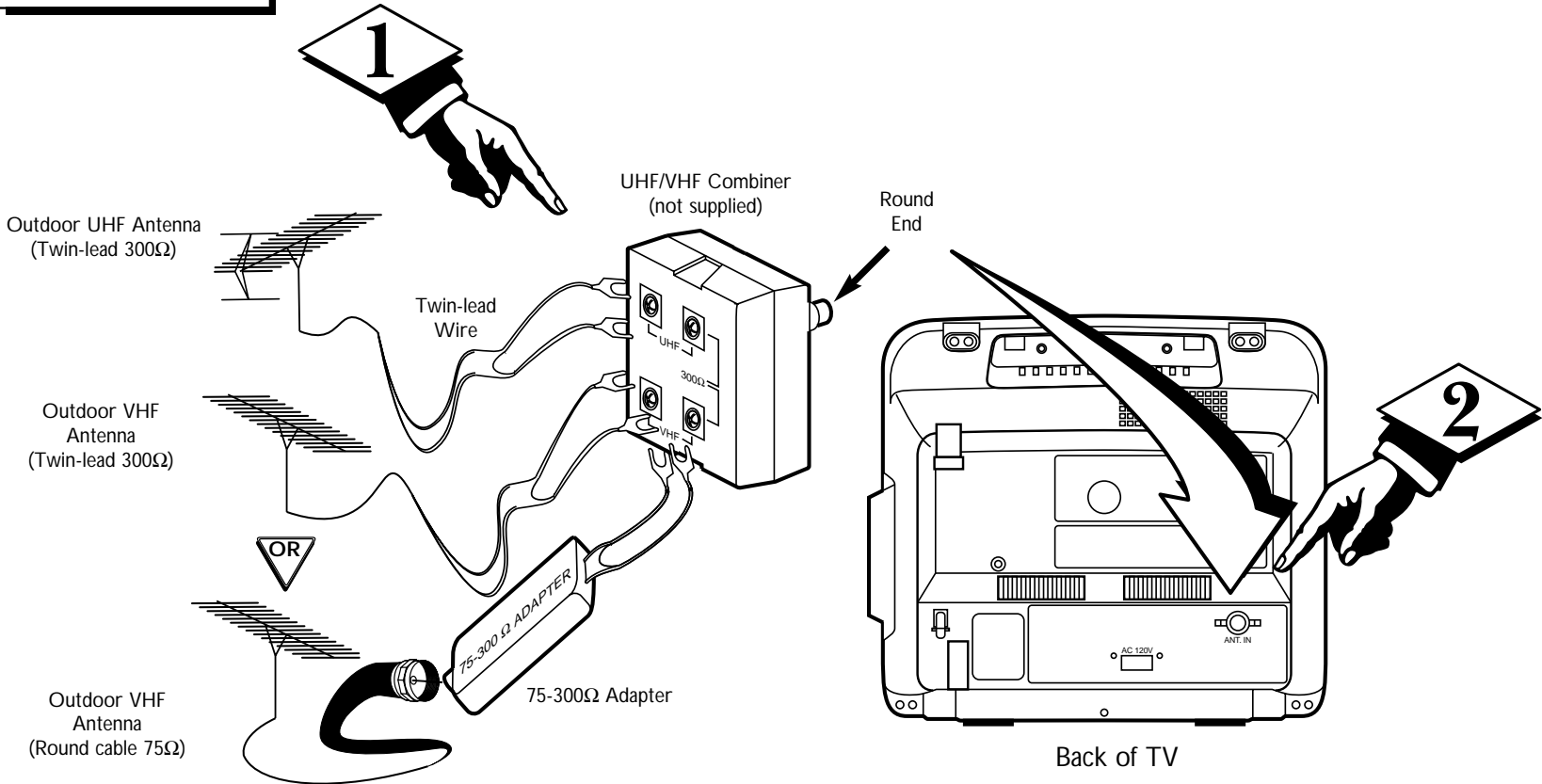

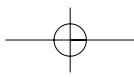

HOOKING UP YOUR TV (ANTENNA/CABLE CONNECTIONS) (CONT'D)

VCR TO TV

BEGIN

BASIC CONNECTION
The basic Antenna/Cable to VCR to TV connection is shown here. If you have a Cable Box, refer to the VCR owner's manual for details.

1 Connect your Antenna or Cable signal to the ANTENNA IN jack on the VCR.

2 Connect a coaxial cable (not supplied) to the RF OUT or ANTENNA OUT jack on the VCR and to the ANT(enna) IN jack on the TV.

3 Refer to the VCR owner's manual for other possible connections and for operating details.

STOP

CABLE TV

BEGIN

CABLE/CABLE BOX
Your Cable TV signal may be a single (75Ω) cable or a Cable Box installation. In either case, the connection to the TV is very easy.

1 If you do not have a Cable Box, then you're ready to connect your Cable TV signal to the TV. Go to step 2. **If you have a Cable Box:** Connect the Cable TV signal to the IN jack on the Cable Box.

2 If you do not have a Cable Box, connect the Cable TV signal directly to the ANT(enna) IN jack on the TV. **If you have a Cable Box:** Use a coaxial cable (not supplied) to connect the OUT jack of the Cable Box to the ANT(enna) IN jack on the TV.

STOP

SMART HELP

To select only the channels on your Cable system, see Auto Install (page 5).

If you use a Cable Box, set the TV to the same channel as the CH 3/4 switch on the back of the Cable Box. Select channels at the Cable Box.

Note to the Cable TV System Installer: This reminder is provided to call the Cable TV system installer's attention to Article 820-40 of the National Electrical Code, which provides guidelines for proper grounding - in particular, specifying that the cable ground shall be connected to the grounding system of the building, as close to the point of cable entry as possible.

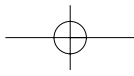

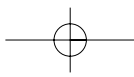

HOOKING UP YOUR TV (ANTENNA/CABLE CONNECTIONS) (CONT'D)

CABINET INSTALLATION / INSTALLATION SUR UN MEUBLE

CABINET INSTALLATION INSTALLATION SUR UN MEUBLE

Follow the instructions below to install the TV beneath a kitchen cabinet.

Suivre les instructions ci-dessous pour installer le téléviseur en-dessous d'un meuble de cuisine.

BEGIN

1 Drill six 1/4-inch holes through the underside of the cabinet using the six circles on the swivel base (supplied) as guides.

Perçer six trous de 1/4 de pouce dans le dessous du meuble en se guidant à l'aide des six cercles sur la base pivotante (fournie).

2 Attach the swivel base to the cabinet using six of each of the following: screws, washers, and hexagonal nuts (supplied) as guides. Refer to the drawing shown below.

Fixer la base pivotante au meuble à l'aide des six vis, rondelles et écrous hexagonaux (fournis). Référez vous au dessin ci dessous.

3 Slide the TV onto the hook on the swivel base and push it backward until the TV locks into place.

Faire glisser le téléviseur sur le crochet de la base pivotante et le repousser jusqu'à ce que le téléviseur se verrouille en place.

4 Secure the TV to the swivel base using two 5/32" (4mm) x 11/16" (18mm) screws (supplied).

Fixer le téléviseur sur la base pivotante à l'aide de deux vis de 5/32" (4mm) x 11/16" (18mm) (fournies).

STOP

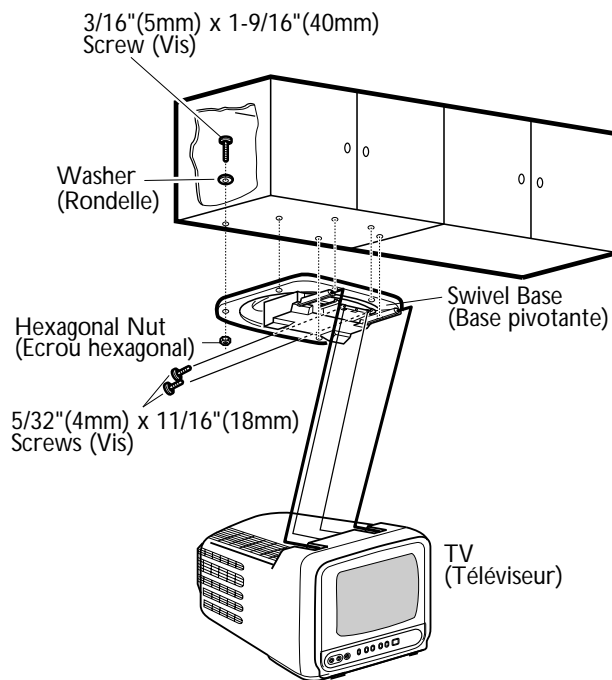

Cabinet Installation

- Keep in mind your normal work pattern, especially the way in which you use other electrical appliances, when you are thinking about where to install the TV.
- Hold the TV in various locations. In each location, turn the TV on so you may check reception.
- If you are going to use the rod antenna, allow enough space around the TV to extend and adjust the antenna.
- Make sure the TV is close enough to an electrical outlet that the power cord can reach it.
- Allow enough room on all sides of the TV for ventilation, access to control knobs, and room to swivel the TV for ease of viewing.
- Route and arrange the excess AC cord so that it will not drape where it can be pulled on or tripped over unintentionally.

SMART HELP



Make sure the area directly beneath the TV is not used for cooking and does not contain an appliance that generates heat or steam.

Veillez à ce que la zone directement en-dessous du téléviseur ne soit pas utilisée pour cuire et ne contienne pas d'appareils générateurs de chaleur ou de vapeur.

CAUTION: To reduce the risk of fire, do not place any heating or cooking appliances beneath this unit.
ATTENTION: Afin de réduire les risques d'incendie, ne placer aucun appareil chauffant ou de cuisson en-dessous de cette unité.

NOTE: Screws that are too short will not screw far enough into the nuts to securely hold the TV. Screws that are too long will protrude below the base of the cabinet and may scratch the TV when it is swiveled.

REMARQUE: Des vis trop courtes ne se visseront pas suffisamment profondément dans les écrous pour maintenir le téléviseur en toute sécurité. Des vis trop longues dépasseront de la base du meuble et pourront rayer le téléviseur lorsque il pivotera.

NOTE: Route and arrange the excess AC cord as illustrated at right so it will not drape where it can be pulled on or tripped over.

REMARQUE: Acheminer et arranger le cordon CA en excès, comme montré dans l'illustration, de telle sorte qu'il ne puisse pas être tiré ou accroché.

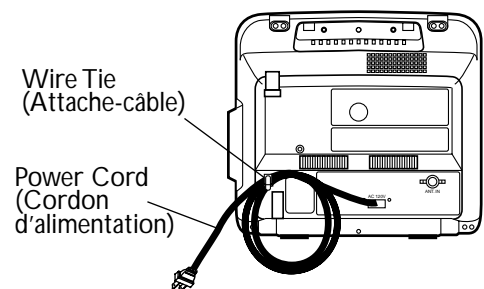

USING THE FRONT AUDIO/VIDEO IN JACKS

AUDIO/VIDEO IN JACKS

For more convenient tape playback from a camcorder or VCR, use the AUDIO and VIDEO In jacks on the front of the TV. These easily accessible jacks allow quick connections between the TV and the VCR or camcorder.

BEGIN

1 Connect a video cable (not supplied) to the VIDEO OUT jack of the camcorder/VCR and to the yellow VIDEO In jack on the front of the TV.

2 Connect an audio cable (not supplied) to the AUDIO OUT jack of the camcorder/VCR and to the white AUDIO In jack on the front of the TV.

3 When you play a tape on the VCR or camcorder, select A/V IN at the TV. Press the TV/AUX button to select A/V IN. A/V IN will appear on the screen.

4 Turn on the camcorder/VCR and press the PLAY button on the camcorder/VCR. When you are finished watching the tape, press the STOP button on the camcorder/VCR.

STOP

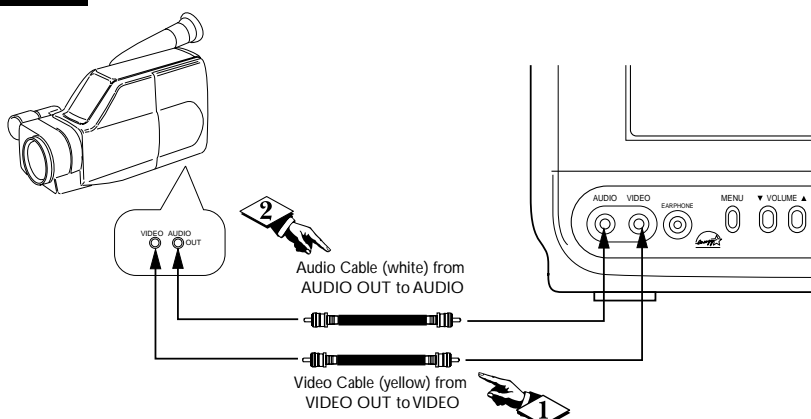

SMART HELP



When you are finished watching the tape, press the TV/AUX button on the TV remote control to return to viewing normal TV channels.

If the VCR or camcorder has Right and Left AUDIO OUT jacks, you will need a "Y" connector cable in order to connect the camcorder/VCR to the TV. Or, check the owner's manual of the camcorder or VCR. It may explain how to connect to a TV that has a single AUDIO In jack.

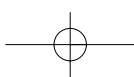

SETTING UP AND USING YOUR TV

AUTO INSTALL

Follow these steps to quickly add area channels into the TV's memory. Before you begin, make sure batteries are in the remote control and you are familiar with the remote.

BEGIN

1 Press the **POWER** button to turn on the TV. Make sure you are not in A/V IN mode. (Press the TV/AUX button so that A/V IN does not appear on the screen.)

2 Press the **MENU** button. The main menu appears on the TV screen.

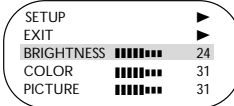

3 Press the **CH(annel) ▲** or **▼** button to select **SETUP**. Then, press the **VOL(ume) ►** or **◄** button to continue to the **SETUP** menu.

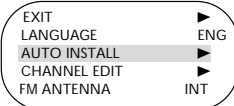

4 Press the **CH(annel) ▲** or **▼** button to select **AUTO INSTALL**. Then, press the **VOL(ume) ►** or **◄** button to enter **AUTO INSTALL**, which will set up the channels.

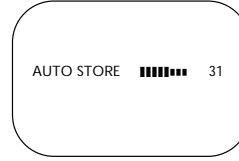

When setup is complete, the **SETUP** menu will reappear for about 30 seconds, then the lowest stored channel will appear. Now, when you press the **CH(annel) ▲** or **▼** button, you will only scan through channels that are available. You still may select non-memorized channels by pressing the Number buttons.

SMART HELP

Complete each step within 30 seconds of the previous step.

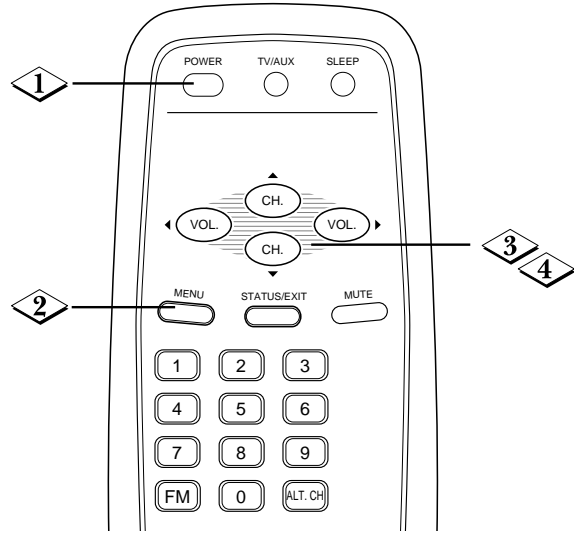

STOP

REMOTE

BEGIN

To load the batteries into the remote:

- Slide off the battery compartment lid on the bottom of the remote control.
- Insert two AA batteries (supplied) into the battery compartment as indicated inside the compartment. Installing batteries incorrectly may damage the remote control.
- Replace the lid.

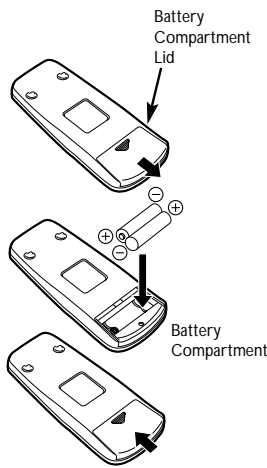

1 Point the remote control toward the remote sensor on the TV when operating the TV with the remote. (See Television illustration below.)

POWER Button
Press to turn the TV on and off.

CH(annel) ▲/▼ Buttons
Press to scan through available channels. Press to select an item in the on-screen menu. When in FM mode, press to select an FM radio channel.

MENU Button
Press to access or remove the on-screen menu. Press the CH(annel) ▲/▼ buttons to select an item in the menu. Press the VOL(ume) ►/◄ buttons to adjust an item in the menu or to advance to the next menu.

Number Buttons
Press to select channels.

- Cable Users**
Enter channel numbers as a two-digit number for the quickest results. For example, to select channel 6, press 0,6. (Pressing only Number button 6 will cause a brief delay. There also may be a brief delay when you select channels 10, 11, and 12.) For channels 100 and above, enter three-digit numbers. For example, to select channel 117, press 1, 1, 7.
- Antenna Users**
Enter channel numbers as a two-digit number for the quickest results. For example, to select channel 5, press 0,5. Pressing only the Number 5 button will cause a delay in selecting channel 5. Only channels 2-69 are available.

SLEEP Button
Press to set the TV to turn itself off automatically. Details are on page 6.

TV/AUX Button
Press to select A/V IN (for viewing video playback at the TV from a VCR, camcorder, DVD Player, etc.). Press again to return to TV channels. Details are on page 4.

VOL(ume) ►/◄ Buttons
Press to adjust the TV sound level in TV mode and FM mode. Press to adjust an item in the on-screen menu or to advance to the next menu. If you press the VOL(ume) ◄ button when the sound is muted, the volume bar will appear on the screen. Pressing the VOL(ume) ► button when the sound is muted will restore the sound.

STATUS/EXIT Button
Press to see the current channel number on the TV screen. Press to remove the on-screen menu. You also may remove the menu by pressing the CH(annel) ▲/▼ buttons to select EXIT, then pressing the VOL(ume) ►/◄ buttons. (You may need to select EXIT repeatedly to completely remove all of the menus.)

MUTE Button
Press to disable the sound in TV mode and FM mode. Press again to restore the sound.

ALT. CH (Alternate Channel) Button
Press to return to the previously viewed TV channel.

FM Button
Press to select FM mode. Press again to return to TV mode.

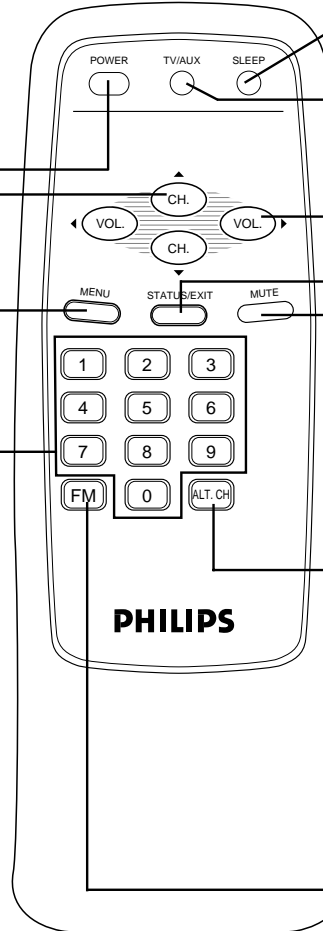

TELEVISION

BEGIN

1 Connect the **AC cord (supplied)** to the AC 120V jack on the back of the TV. Then, plug the power cord into an operating AC outlet. Press the **POWER** button to turn on the TV.

2 Press the **VOLUME ▲/▼** buttons to adjust the sound level.

3 Press the **CHANNEL ▲/▼** buttons to select available TV channels. (See Auto Install above.)

4 Press the **MENU** button to display the TV's on-screen menu. Press the **CHANNEL ▲/▼** buttons to select an item in the menu. Press the **VOLUME ▲/▼** buttons to adjust an item in the menu or to advance to the next menu.

Note: To remove the menu, press the **CHANNEL ▲/▼** buttons to select EXIT. Then, press the **VOLUME ▲** or **▼** button. (You may need to select EXIT repeatedly to completely remove all of the menus.) Or, press the **MENU** button, repeatedly if necessary, to remove the **MENU**.

SMART HELP

The current channel number will appear briefly when the TV is first turned on and with channel changes. To display the channel number for five seconds, press the **STATUS/EXIT** button on the remote control.

You can turn on the TV by pressing the **CHANNEL ▲** or **▼** button on the front of the TV. The **CH(annel) ▲/▼** buttons of the remote control will not turn on the TV power.

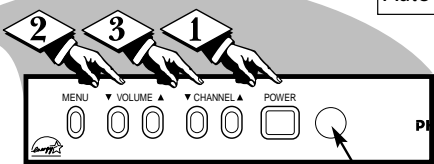
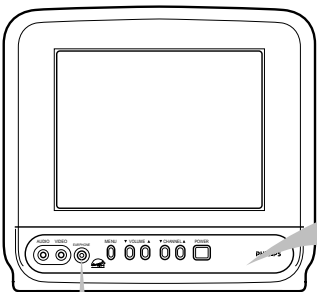

Remote Sensor
Point the remote control here when using the remote to work the TV.

Notes:

- You can connect earphones (not supplied) to the **EARPHONE** jack on the front of the TV for private, personal listening.

STOP

FEATURES

CHANNEL EDIT

AUTO INSTALL (see page 5) memorizes all the channels on your Antenna or Cable TV system. CHANNEL EDIT makes it easy for you to add other channels or drop unwanted channels from the TV's memory. Then, when you use the CH(annel) ▲/▼ buttons, you will only scan through the channels you want.

BEGIN

- Press the MENU button, then press the CH(annel) ▲ or ▼ button to select SETUP.
- Press the VOL(ume) ► or ◀ button to continue to the SETUP menu.
- Press the CH(annel) ▲ or ▼ button to select CHANNEL EDIT.
- Press the VOL(ume) ► or ◀ button to continue to the CHANNEL EDIT menu. CHANNEL will be selected.
- While CHANNEL is selected, press the VOL(ume) ► or ◀ button or the Number buttons to select the channel you want to add or skip.
- Press the CH(annel) ▲ or ▼ button to select SKIPPED. Then, press the VOL(ume) ► or ◀ button to set SKIPPED to YES (if you want to skip past the channel when using the CH(annel) ▲/▼ buttons) or NO (if you want the channel to be available when you are using the CH(annel) ▲/▼ buttons).
- Press the STATUS/EXIT button when you are finished.

STOP

LANGUAGE

Follow these steps to change the language of the on-screen menus and displays.

BEGIN

- Press the MENU button.
- Press the CH(annel) ▲ or ▼ button to select SETUP, then press the VOL(ume) ► or ◀ button to continue. LANGUAGE will be selected.
- Press the VOL(ume) ► or ◀ button to select ENG for English menus or ESP for Spanish menus.
- Press the STATUS/EXIT button.

SMART HELP

If you accidentally choose Spanish and need English:

- 1) Press the MENU button.
- 2) Press the CH(annel) ▲ or ▼ button to select INSTALACION, then press the VOL(ume) ► or ◀ button to continue.
- 3) IDIOMA will be selected. Press the VOL(ume) ► or ◀ button to have ENG appear beside LANGUAGE.
- 4) Press the STATUS/EXIT button.

STOP

VOLUME

There are three ways to adjust the TV's volume. Follow these steps to adjust the volume using the on-screen menu. Or, you can adjust the volume using the VOL(ume) ►/◀ buttons on the remote control or the VOLUME ▲/▼ buttons on the TV.

BEGIN

- Press the MENU button.
- Press the CH(annel) ▲ or ▼ button to select VOLUME. Then, press the VOL(ume) ►/◀ buttons to adjust the volume level. Pressing the VOL(ume) ► button when the sound is muted will restore the sound.
- Press the STATUS/EXIT button to remove the menu.

SMART HELP

The Volume indicator should appear on the screen when you adjust the volume.

The simplest way to adjust the volume is by pressing the VOL(ume) ►/◀ buttons.

The TV must be set to an active channel in order for the Volume control to work properly.

STOP

SLEEPTIMER

Have you ever fallen asleep in front of the TV, only to have it wake you up at 2 a.m. with a test pattern screeching in your ears? Well, your TV can save you all that trouble by automatically turning itself off. Set the Sleptimer simply by pressing the SLEEP button, or you may use the on-screen menu.

BEGIN

- Press the SLEEP button repeatedly to pick the amount of time (15 minutes to 120 minutes in 15-minute increments) before the TV turns itself off. The length of time will appear on the screen. One minute before the TV shuts itself off, the seconds will count down on the screen.
- Press the MENU button.
- Press the VOL(ume) ► or ◀ button repeatedly to set the amount of time or to select OFF.
- Press the STATUS/EXIT button to remove the menu.

SMART HELP

To see how many minutes remain before the TV shuts itself off, press the SLEEP button once or press the STATUS/EXIT button.

To cancel a SLEEPTIMER setting, press the SLEEP button twice so that OFF appears on the screen.

A power failure will cancel the Sleptimer but you may reset it.

STOP

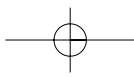

FEATURES (CONT'D)

PICTURE ADJUSTMENTS

To adjust your TV picture controls, select a channel and follow these steps.

BEGIN

1 Press the MENU button, then press the CH(annel) ▲ or ▼ button to select a control.

2 Press the VOL(ume) ►/◄ buttons to adjust the selected picture control.

3 Press the STATUS/EXIT button.

STOP

BRIGHTNESS Press the VOL(ume) ►/◄ buttons until the darkest parts of the picture are as bright as you prefer.

COLOR Press the VOL(ume) ►/◄ buttons to add or reduce color.

PICTURE Press the VOL(ume) ►/◄ buttons until the lightest parts of the picture show good detail.

SHARPNESS Press the VOL(ume) ►/◄ buttons to improve detail in the picture.

TINT Press the VOL(ume) ►/◄ buttons to obtain natural skin tones.

FM MODE

This feature enables you to receive FM radio stations.

The radio frequency indicator will move or shift while on the TV screen during normal FM mode operation.

FM 88.0MHz

BEGIN

1 Press the FM button on the remote control to select the FM mode. The radio frequency appears on the TV screen.

2 Press the CH(annel) ▲/▼ buttons until your desired radio frequency appears.

3 To exit FM mode and return to TV mode, press the FM button.

STOP

SMART HELP

If you turn off the TV in FM mode, the TV will be in TV mode when you turn on the TV again.

You may get better FM reception by repositioning the TV (when you are using the TV's internal antenna).

The TV's FM radio has a built-in antenna with a band range of 88.0 ~ 108.0 MHz. Radio stations may refer to this number as their frequency.

If you receive a weak radio signal, you may switch between the TV's internal and external antennas. Usually, the internal antenna of the TV best allows you to receive FM stations.

To switch between the external (EXT) and internal (INT) antennas, follow these steps.

- 1) Press the FM button to exit the FM mode and return to TV mode.
- 2) Press the MENU button.
- 3) Press the CH(annel) ▲ or ▼ button to select SETUP. Then, press the VOL(ume) ► or ◄ button to continue.
- 4) Press the CH(annel) ▲ or ▼ button to select FM ANTENNA. Then, press the VOL(ume) ► or ◄ button to select INT or EXT.
- 5) Press the STATUS/EXIT button.

GLOSSARY

Coaxial Cable - A single cable with a metal connector that screws (or pushes) directly onto a 75Ω jack (ANT(enna) In jack) on the Television or VCR.

Display - Allows the user to quickly confirm the current channel number.

Menu - An on-screen listing of features that are available for adjustments.

On-screen Displays - The wording or messages that help you set up features.

Programming - Adding or deleting channels in the television's memory. The television "remembers" only the locally available or desired channel numbers and skips over any unwanted channel numbers.

Remote Sensor - An area on the front of the TV through which remote control signals are received.

Twin Lead Wire - The two-strand 300Ω antenna wire used with many indoor and outdoor antenna systems. In many cases, this type of antenna wire requires an additional adapter (or balun) in order to connect to the ANT(enna) In jack on the TV.

Volume Indicator - Appears on the TV screen when you adjust the volume.

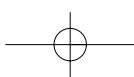

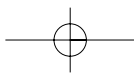

GENERAL INFORMATION

TIPS

TRUBLESHOOTING
 Please make these simple checks before calling for service. These tips can save you time and money since charges for TV installation and adjustment of customer controls are not covered under your warranty.

Battery Safety
 To prevent battery leakage that may result in bodily injury or damage to the unit:

- Install ALL batteries correctly, with the + and - markings on the battery aligned as indicated on the unit;
- Do not mix batteries, for example, old with new or carbon with alkaline; and
- Remove batteries when the unit will not be used for a long time.

- BEGIN**
- 1 **No Power**
 - Check the TV power cord.
 - Make sure the power outlet is not on a wall switch.
 - 2 **No Sound**
 - Check the VOL(ume) ►/◄ buttons.
 - Check the MUTE button.
 - 3 **No Picture**
 - Check antenna/cable connections. Is the antenna or cable properly secured to the ANT(enna) IN jack on the TV?
 - 4 **Remote Doesn't Work**
 - Check batteries. Replace with AA Heavy Duty (Zinc Chloride) or Alkaline batteries if necessary.
 - Clean the remote and the remote sensor on the TV. See page 5.
 - Check the TV power cord.
 - 5 **Wrong Channel**
 - Repeat channel selection.
 - Add desired channel numbers into the TV memory. See Channel Edit on page 6 for details.

Cleaning and Care

- Unplug the TV before cleaning.
- Avoid using anything abrasive that could scratch the screen.
- Wipe the TV screen with a clean cloth dampened with water.
- Gently wipe cabinet surfaces with a clean cloth or sponge dampened with cool clear water. Use a clean dry cloth to dry the wiped surfaces.
- Occasionally vacuum the ventilation holes or slots in the cabinet back.
- Never use thinners, insecticide sprays, or other chemicals on or near the cabinet.

As an ENERGY STAR® Partner, Philips Consumer Electronics Company has determined that this product meets the ENERGY STAR® guidelines for energy efficiency. ENERGY STAR® is a U.S. registered mark.
 Using products with the ENERGY STAR® label can save energy. Saving energy reduces air pollution and lowers utility bills.

INDEX

ALT. CH Button 5	CH(annel) ▲/▼ Buttons . . . 5	Language 6	Remote Sensor 5	VCR Connections 3
Antenna Connections . . . 2-3	Coaxial Cable 3	MENU Button 5	Safety Notes 1	Volume 6
Auto Install 5	Controls/Remote 5	MUTE Button 5	Service 8	VOL(ume) ►/◄ Buttons 5-6
Batteries 5	Controls/TV 5	Number Buttons 5	SLEEP Button 5, 6	Warranty 8
Cabinet Installation 4	EARPHONE jack 5	Picture Adjustments 7	Sleeptimer 6	
Cable TV Connections 3	Features 1	POWER Button 5	STATUS/EXIT button 5	
Channel Edit 6	FM Button 5, 7	Precautions 1, 8	Tips 8	
Channel Setup 5	Glossary 7	Remote Control 5	TV/AUX Button 5	

WARRANTY

COLOR TELEVISION

90 Days Free Labor
One Year Free Replacement of Parts (Two Years Free Replacement on Color Picture Tube)
 This product must be carried in for repair.

WHO IS COVERED?

You must have proof of purchase to receive warranty service. A sales receipt or other document showing that you purchased the product is considered proof of purchase.

WHAT IS COVERED?

Warranty coverage begins the day you buy your product. For 90 days thereafter, all parts will be repaired or replaced free, and labor is free. From 90 days to one year from the day of purchase, all parts will be repaired or replaced free, but you pay for all labor charges. From one to two years from the day of purchase, you pay for the replacement or repair of all parts except the picture tube, and for all labor charges. After two years from the day of purchase, you pay for the replacement or repair of all parts, and for all labor charges.

All parts, including repaired and replaced parts, are covered only for the original warranty period. When the warranty on the product expires, the warranty on all replaced and repaired parts also expires.

WHAT IS EXCLUDED?

- Your warranty does not cover:
- labor charges for installation or setup of the product, adjustment of customer controls on the product, and installation or repair of antenna systems outside of the product.
 - product repair and/or part replacement because of misuse, accident, unauthorized repair, or other cause not within the control of Philips Consumer Electronics Company.
 - reception problems caused by signal conditions or cable or antenna systems outside the unit.
 - a product that requires modification or adaptation to enable it to operate in any country other than the country for which it was designed, manufactured, approved, and/or authorized, or repair of products damaged by these modifications.
 - incidental or consequential damages resulting from the product. (Some states do not allow the exclusion of incidental or consequential damages, so the above exclusion may not apply to you. This includes, but is not limited to, prerecorded material, whether copyrighted or not copyrighted.)
 - a product used for commercial or institutional purposes.

WHERE IS SERVICE AVAILABLE?

Warranty service is available in all countries where the product is officially distributed by Philips Consumer Electronics Company. In countries where Philips Consumer Electronics Company does not distribute the product, the local Philips service organization will attempt to provide service (although there may be a delay if the appropriate spare parts and technical manual(s) are not readily available).

MAKE SURE YOU KEEP...

Please keep your sales receipt or other document showing proof of purchase. Attach it to this owner's manual and keep both nearby. Also keep the original box and packing material in case you need to return your product.

BEFORE REQUESTING SERVICE...

Please check your owner's manual before requesting service. Adjustments of the controls discussed there may save you a service call.

TO GET WARRANTY SERVICE IN U.S.A., PUERTO RICO, OR U.S. VIRGIN ISLANDS...

Contact a Philips factory service center (see enclosed list) or authorized service center to arrange repair.
 (In U.S.A., Puerto Rico, and U.S. Virgin Islands, all implied warranties, including implied warranties of merchantability and fitness for a particular purpose, are limited in duration to the duration of this express warranty. But, because some states do not allow limitations on how long an implied warranty may last, this limitation may not apply to you.)

TO GET WARRANTY SERVICE IN CANADA...

Please contact Philips at:
 1-800-661-6162 (French Speaking)
 1-800-363-7278 (English Speaking)

(In Canada, this warranty is given in lieu of all other warranties. No other warranties are expressed or implied, including any implied warranties of merchantability or fitness for a particular purpose. Philips is not liable under any circumstances for any direct, indirect, special, incidental, or consequential damages, howsoever incurred, even if notified of the possibility of such damages.)

REMEMBER...

Please record below the model and serial numbers found on the product. Also, please fill out and mail your warranty registration card promptly. It will be easier for us to notify you if necessary.

MODEL # _____
 SERIAL # _____

Philips Service Solutions Group, P.O. Box 2976, Longview, Texas 75606
(903) 242-4800

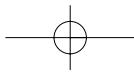

Free Manuals Download Website

<http://myh66.com>

<http://usermanuals.us>

<http://www.somanuals.com>

<http://www.4manuals.cc>

<http://www.manual-lib.com>

<http://www.404manual.com>

<http://www.luxmanual.com>

<http://aubethermostatmanual.com>

Golf course search by state

<http://golfingnear.com>

Email search by domain

<http://emailbydomain.com>

Auto manuals search

<http://auto.somanuals.com>

TV manuals search

<http://tv.somanuals.com>