

Digital Video Disc Player &
Video Cassette Recorder
Owner's Manual

DV900VHS



Read this manual first!

Congratulations on purchasing this Philips product.

We've included everything you need to get started.

If you have any problems, Philips Representatives can help you get the most from your new product by explaining:

- Hookups,
- First Time Setup, and
- Feature Operation.

Do not attempt to return this product to the store.

For fast help, call us first!

1-800-531-0039

Thank you for making Philips a part of your home!

Let's make things better.



PHILIPS

Return your Warranty Registration card today to ensure you receive all the benefits you're entitled to.

Once your PHILIPS purchase is registered, you're eligible to receive all the privileges of owning a PHILIPS product. So complete and return the Warranty Registration Card enclosed with your purchase at once. And take advantage of these important benefits.

Warranty Verification

Registering your product within 10 days confirms your right to maximum protection under the terms and conditions of your PHILIPS warranty.

Owner Confirmation

Your completed Warranty Registration Card serves as verification of ownership in the event of product theft or loss.

Model Registration

Returning your Warranty Registration Card right away guarantees you'll receive all the information and special offers which you qualify for as the owner of your model.

PHILIPS

Congratulations on your purchase, and welcome to the "family!"

Dear PHILIPS product owner:

Thank you for your confidence in PHILIPS. You've selected one of the best-built, best-backed products available today. And we'll do everything in our power to keep you happy with your purchase for many years to come.

As a member of the PHILIPS "family," you're entitled to protection by one of the most comprehensive warranties and outstanding service networks in the industry.

What's more, your purchase guarantees you'll receive all the information and special offers for which you qualify, plus easy access to accessories from our convenient home shopping network.

And most importantly you can count on our uncompromising commitment to your total satisfaction.

All of this is our way of saying welcome-and thanks for investing in a PHILIPS product.

Sincerely,



Robert Minkhorst
President and Chief Executive Officer

P.S. Remember, to get the most from your PHILIPS product, you must return your Warranty Registration Card within 10 days. So please mail it to us right now!



Know these **safety** symbols



⚡ This "bolt of lightning" indicates uninsulated material within your unit may cause an electrical shock. For the safety of everyone in your household, please do not remove product covering.

⚠ The "exclamation point" calls attention to features for which you should read the enclosed literature closely to prevent operating and maintenance problems.

WARNING: TO PREVENT FIRE OR SHOCK HAZARD, DO NOT EXPOSE THIS EQUIPMENT TO RAIN OR MOISTURE.

CAUTION: To prevent electric shock, match wide blade of plug to wide slot, fully insert.

ATTENTION: Pour éviter les choc électriques, introduire la lame la plus large de la fiche dans la borne correspondante de la prise et pousser jusqu'au fond.

For Customer Use

Enter below the Serial No. which is located on the rear of the cabinet. Retain this information for future reference.

Model No. _____
Serial No. _____



PHILIPS

Visit our World Wide Web Site at <http://www.philips.com>

Safety and General Information 3

Safety Precautions

Warning: To prevent fire or shock hazard, do not expose this equipment to rain or moisture.

Federal Communications Commission (FCC) Warning: Any unauthorized changes or modifications to this equipment void the user's authority to operate it.

Department of Health and Human Services (DHHS) Certification: Complies with 21 Center for Radiation (CFR) chapter 1 subchapter J applicable at time of manufacture.

Laser Safety

This unit employs a laser. Only a qualified service person should remove the cover or attempt to service this device, due to possible eye injury.

CAUTION: USE OF CONTROLS OR ADJUSTMENTS OR PERFORMANCE OF PROCEDURES OTHER THAN THOSE SPECIFIED HEREIN MAY RESULT IN HAZARDOUS RADIATION EXPOSURE.

CAUTION: VISIBLE AND INVISIBLE LASER RADIATION WHEN OPEN AND INTERLOCK DEFEATED. DO NOT STARE INTO BEAM. THE BEAM IS LOCATED INSIDE, NEAR THE DECK MECHANISM.

Special Information for Canadian Users

This Class B digital apparatus complies with Canadian ICES-003.

Cet appareil numérique de la classe B est conforme à la norme NMB-003 du Canada.

Radio/TV Interference

This equipment has been tested and found to comply with the limits for a Class B digital device, pursuant to Part 15 of the FCC Rules. These limits are designed to provide reasonable protection against harmful interference in a residential installation. This equipment generates, uses, and can radiate radio frequency energy and, if not installed and used in accordance with the instructions, may cause harmful interference to radio communications. However, there is no guarantee that interference will not occur in a particular installation. If this equipment does cause harmful interference to radio or television reception, which can be determined by turning the equipment off and on, the user is encouraged to try to correct the interference by one or more of the following measures:

- 1) Reorient or relocate the receiving antenna.
- 2) Increase the separation between the equipment and the receiver.
- 3) Connect the equipment into an outlet on a circuit different from that to which the receiver is connected.
- 4) Consult the dealer or an experienced radio/TV technician for help.

Copyright Protection

Unauthorized copying, broadcasting, public performance and lending of Discs are prohibited.

This product incorporates copyright protection technology that is protected by method claims of certain U.S. patents and other intellectual property rights owned by Macrovision Corporation and other rights owners.

Use of this copyright protection technology must be authorized by Macrovision Corporation and is intended for home and other limited viewing uses only unless otherwise authorized by Macrovision Corporation.

Reverse engineering or disassembly is prohibited.

Note to the Cable TV System Installer: This reminder is provided to call the Cable TV system installer's attention to Article 820-40 of the National Electrical Code, which provides guidelines for proper grounding – in particular, specifying that the cable ground shall be connected to the grounding system of the building, as close to the point of cable entry as possible.

High Quality

This DVD/VCR is equipped with a High Quality (HQ) system and is compatible with existing Video Home System (VHS) equipment.

Declaration of Conformity

Model Number: DV900VHS
Trade Name: Philips
Responsible Party: Philips Consumer Electronics
P.O. Box 14810
Knoxville, TN 37914
(865) 521-4316

Manufactured under license from Dolby Laboratories. "Dolby" and the double-D symbol are trademarks of Dolby Laboratories. Confidential Unpublished Works. (© 1992-1997 Dolby Laboratories, Inc. All rights reserved.)

DTS is a trademark of Digital Theater Systems Inc. in the United States of America.

Copyright 2001 Philips Consumer Electronics. All rights reserved.

4 Table of Contents

General Information

Safety and General Information	3
Table of Contents	4
Introduction	5
Playable Discs	6
Playable Video Cassette Tapes	7

Setting Up Your DVD/VCR

Hookups Without a Cable Box/Direct Broadcast System	8-9
Hookups With a Cable Box/Direct Broadcast System	10-11
Optional Hookups	12-14
Remote Control Setup	15
Turning on Your DVD/VCR	16
Automatic Channel Setup	17-19
Setting the Clock	20
Daylight-Savings Time	21
Language Selection (VCR)	22
On-Screen Status Displays (VCR)	23

Description of Controls

DVD/VCR Display - DVD Features	24
DVD/VCR Display - VCR Features	25
Front Panel	26
Rear Panel	27
Remote Control Buttons	28-31

Basic VCR Operations

Playing a Video Cassette Tape	32
Recording on a Video Cassette Tape	33

VCR Recording

Recording One Channel/Watching Another	34
One-Touch Recording	35
Timer Recording	36-39
Rerecording (Tape Duplication)	40

Video Cassette Tape Playback

Repeat Play (Video Cassette Tapes)	41
Real-Time Counter Memory	42
Time Search	43
Special Effects Playback	44
Automatic Operation Features	45

Additional VCR Features

MTS System	46-47
Hi-Fi Stereo Sound System	48
Blue Background	49

Disc Playback and Features

Playing a Disc	50
Disc Menus	51
Pausing Playback	52
Step by Step Playback/Slow Motion	53
Fast Forward/Reverse Search	54
Track Playback	55
Title/Chapter Playback	56
Specific Time Playback	57
Repeat Playback (Discs)	58
A-B Repeat Playback	59
Programmed Playback	60
Random Playback	61
Audio Language/Sound Mode	62
Subtitle Language	63
Camera Angles	64
Status Display (Discs)	65
Parental Lock Levels	66
Parental Lock Password	67

DVD Player Setup and Features

Audio Settings	68-69
Language Settings	70-72
Video Settings	73
Other Menu Settings	74

Information You May Need

Care and Maintenance / Specifications	75
Helpful Hints	76-79
Limited Warranty	80-81
Glossary	82
Index	83
Accessories	84

Welcome!

This DVD/VCR combines a Digital Video Disc (DVD) Player and a Hi-Fi Video Cassette Recorder (VCR) into one unit, allowing you to play DVDs, Audio Compact Discs (Audio CDs), and video cassette tapes from one piece of equipment. The DVD Player of this DVD/VCR will allow you to enjoy better picture quality, clearer sound, and endless playback features available on DVDs. Expanding technology allows you to add options to your viewing - watch a director's cut of a movie, listen to the producer's comments, or play your favorite scene over and over again. Hear a movie in different languages, or listen only to the soundtrack. The possibilities are limited only by your choices and the materials available on the DVD.

When playing Audio CDs, determine the order in which you want to hear the songs, or play the Disc repeatedly - all while seeing the status of the CD on your television.

We hope you enjoy this DVD/VCR and learn to use all of its features. To get the most out of the DVD/VCR, read this owner's manual carefully. It will describe how you can access all the features listed below.

Features

VCR

- Automatic Channel Setup
- Automatic Head Cleaner
- Automatic Operation Features
- Automatic Tracking Adjustment
- Blue Background
- Daylight-Savings Time
- Hi-Fi Stereo Sound System
- High Quality (HQ) System
- MTS (Multi-Channel Television Sound) System
- 19 micron head
- On-Screen Displays in English or Spanish
- One-Touch Recording
- Real-Time Counter
- Repeat Play
- S-VHS Quasi Play Back (SQPB)
- Special Effects Playback: Forward and Reverse Searching; Still; Slow Motion
- Time Search
- Timer Recording

DVD

- Audio Language/Sound Mode Choices*
- Automatic Detection of Disc Type (Audio CD or DVD)
- DVD Menus in a Desired Language *
- On-Screen Display
- Parental Lock*
- Paused/Fast/Slow/Step-by-Step Playback
- Program Playback (Audio CD only)
- Random Playback (Audio CD only)
- Screen Saver
- Multiple Camera Angles*
- Subtitles in a Desired Language *

* If available on the Disc

When referring to this manual, remember...

VCR Indicates that the feature described is available on video cassette tapes when the DVD/VCR is in VCR mode.

DVD Indicates that the feature described is available on some Digital Video Discs when the DVD/VCR is in DVD mode.

AUDIO CD Indicates that the feature described is available on some Audio Compact Discs when the DVD/VCR is in DVD mode.

Disc Menus...

Some explanations in this manual are intended to describe the Disc menus. These menus are set by the movie producers or by the music industry, and the menus will vary among Discs. Furthermore, not all Discs are guaranteed to have menus. However, if the Disc has a menu, you can access the Disc menu by pressing the DVD button, then pressing the MENU button on the remote control. (Make sure the DVD/VCR is in DVD mode. Press the DVD/VCR OUTPUT button so that the red DVD light appears on the front of the DVD/VCR.)

DVD Menus...

Some instructions explain how to use the DVD player's menu to set up features of the DVD player or the Disc. You get to the DVD player menu by pressing the SETUP button on the remote control when playback is stopped. Even if a feature is set up in the DVD player's menu, it may not be available if the current Disc does not include that feature.



Available Disc Features...

Not all of the features described in this manual may be available on every DVD or Audio CD. If the feature is not available on the Disc, you cannot use the DVD/VCR to make these features available. The "No feature" symbol will appear on the TV screen if you try to set up a feature that is not available on the current Disc or is not available at the current time.

6 Playable Discs

This DVD/VCR will play Digital Video Discs (DVDs) and Audio CDs. In order to play a DVD or Audio CD on this DVD/VCR, make sure the Disc meets the requirements for Region Codes and Color Systems as described on this page. Also, the Discs should be labelled with the following logos and should meet these standards.

Disc Type	Logo	Contents	Disc Size	Maximum Playback Time	Disc Segments
Digital Video Disc		Sound and Pictures	12 cm	Approx. 4 hours (single-sided) Approx. 8 hours (double-sided)	DVDs are divided into Titles, which are divided into Chapters. Titles and Chapters are numbered.
			8 cm	Approx. 80 minutes (single-sided) Approx. 160 minutes (double-sided)	
Audio CD		Sound	12 cm	74 minutes	Audio CDs are divided into numbered Tracks, i.e., a track may be one song.
			8 cm (singles)	20 minutes	

Region Codes

DVDs also must be labelled for ALL regions or for Region 1 in order to be played on this DVD/VCR. You can not play Discs that are labelled for other regions. Look for the symbols below on your DVDs. If these region symbols do not appear on your DVD, you cannot play the DVD in this DVD/VCR.



The number inside the globe refers to a region of the world. Region 1 represents the United States, Canada, upper regions of North America, Bermuda, the U.S. Virgin Islands, and small regions near Australia.

A Disc encoded in a specific region format can only be played on DVD players with the same region code. For example, if a Disc is labelled for Region 2, you can not play the DVD on this DVD/VCR.

Color Systems

Different color systems are available throughout the world. The most common color systems are NTSC, which is used primarily in the United States and North America, PAL, and SECAM.

This DVD/VCR uses the NTSC color system. Therefore, the Discs that you play must be recorded in the NTSC system. You cannot play Discs recorded in other formats. The color system of the DVD may be listed on the DVD or on the Disc jacket.

Unacceptable Discs

The following Discs cannot be played on this DVD/VCR.

- CD-ROM
- Compact Disc-Interactive (CD-I)
- Compact Disc-Recordable (CD-R)
- Digital Video Disc-Video Recordable (DVD-VR)
- DVD-RAM
- DVD-ROM
- Photo CD
- Video CD
- Video Single Disc (VSD)

The following discs may be played, but only the audio will be available. There will be no picture.

- Compact Disc-Graphic (CD-G)
- Compact Disc-Video (CD-V)

Playable Video Cassette Tapes 7

Playable Video Cassette Tapes

This DVD/VCR is equipped with a High Quality (HQ) system and is compatible with existing Video Home System (VHS) equipment. Philips Consumer Electronics recommends that you use only video cassette tapes which are labeled with the **VHS** mark. The use of other tapes may result in poor picture quality and excessive deposits on the video heads, which may not be covered by the warranty if damage occurs. The 19 micron head provides a better picture when you view tapes recorded in slow speed (SLP).

Recording Prevention

Video cassette tapes have record tabs to ensure that recordings are not accidentally erased.

1

To prevent recording, break off the tab with a screwdriver.

2

To allow recording, cover the hole with cellophane tape.

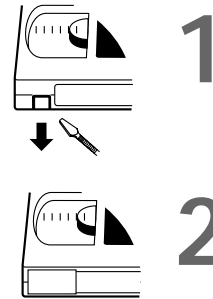

DVD/VCR maintenance

- Use only tapes with the **VHS** mark.
- Remove any light adhesive stick-on notes from the video cassette tape before putting the tape in the DVD/VCR. Removable labels can jam the DVD/VCR.
- Periodic maintenance is required to maintain your DVD/VCR's excellent performance. This DVD/VCR has an Automatic Head Cleaner. However, the video heads will require replacement eventually. Only an authorized service center should perform this service.

8 Hookups Without a Cable Box/Direct Broadcast System

The basic antenna/cable to DVD/VCR to TV is shown below.

If you have a Cable Box or a Direct Broadcast System, please see pages 10-11. For better sound and picture quality when using the DVD player, refer to the Optional Hookups on pages 12-14. After you hook up the DVD/VCR, go to page 16 to turn on the DVD/VCR.

1

Disconnect the antenna or cable from your TV.

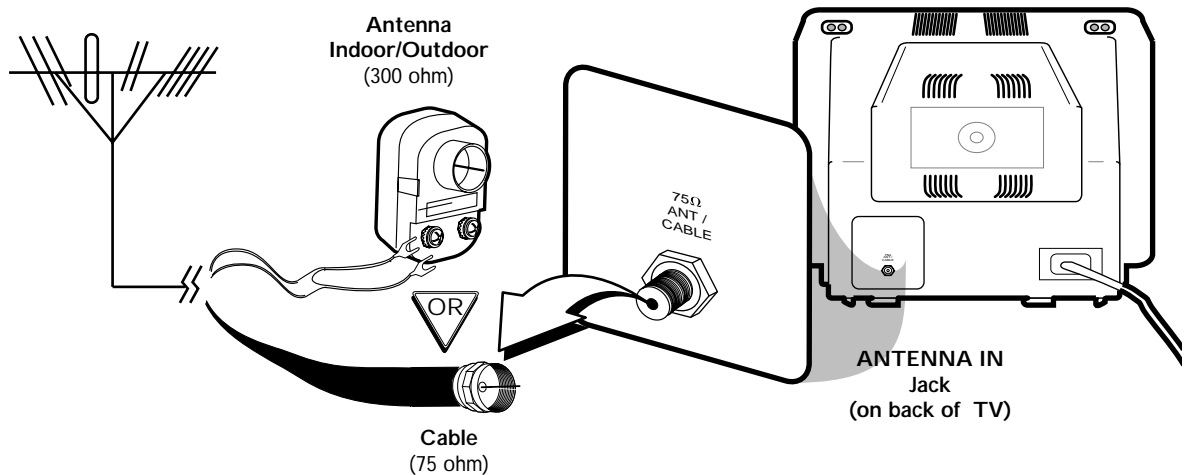

2

Connect the antenna or cable to the ANT-IN (Antenna In) Jack of your DVD/VCR.

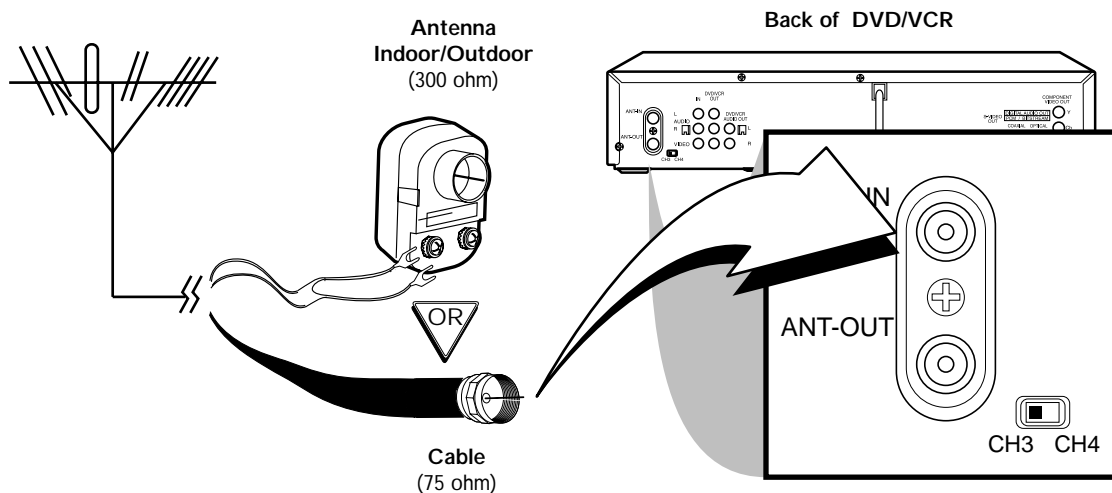

Hookups Without a Cable Box/Direct Broadcast System (cont'd) 9

3

Connect the RF coaxial cable (supplied) to the ANT-IN (Antenna In) Jack on the back of the DVD/VCR and to the ANTENNA IN Jack on the TV. (You may use either a snap-on type (supplied) or screw-on type of coaxial cable, whichever you prefer.)

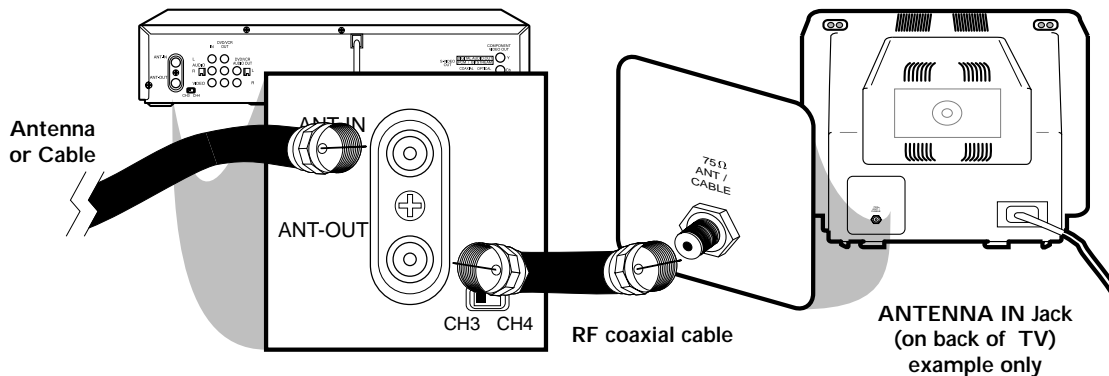

4

Plug in the TV and the DVD/VCR.

5

Set the CH3/CH4 switch on the back of the DVD/VCR to CH3 or CH4, whichever channel is not used or least used in your area. Set the TV to the same channel. For example, when playing a tape, if the CH3/CH4 switch is set to CH3, the TV should be on channel 03.

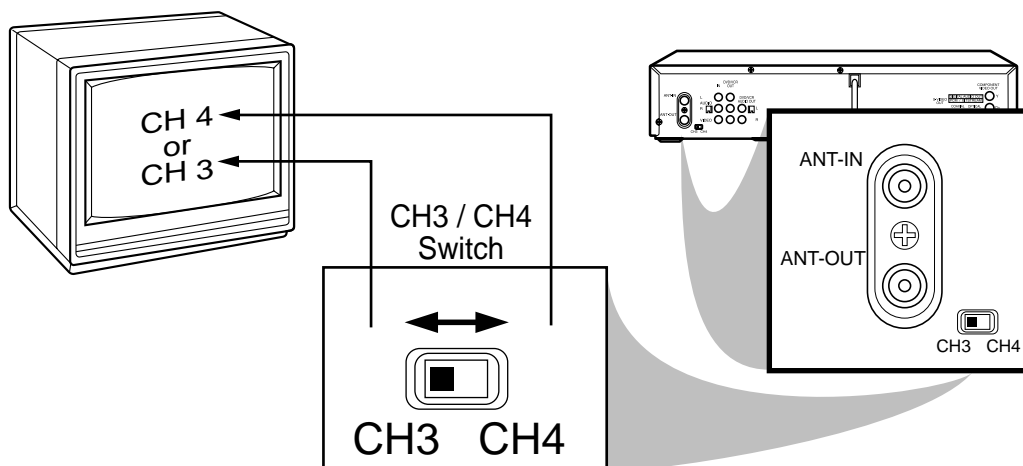

6

You are ready to turn on the DVD/VCR. Please go to page 16 before turning on the DVD/VCR.

10 Hookups With a Cable Box/Direct Broadcast System

There are two ways to connect your Cable Box/DBS to the DVD/VCR. With this connection:

- You may view any channel.
- You must select channels at the Cable Box/DBS. Channels cannot be changed at the DVD/VCR.
- You may not view a channel other than the one you are recording.
- You may not program channels at the DVD/VCR.
- You can only program a timer recording for one channel at a time. Set the TV and the DVD/VCR to the Cable Box/DBS output channel (channel 03 or 04); set the CH3/CH4 switch to the same channel. Set your Cable Box/DBS to the channel you want to record. When you enter the channel you want to record in a timer recording, select channel 03 or 04 (the Cable Box/DBS output channel). (This is step 5 on page 37.) Leave the Cable Box/DBS on for a timer recording.

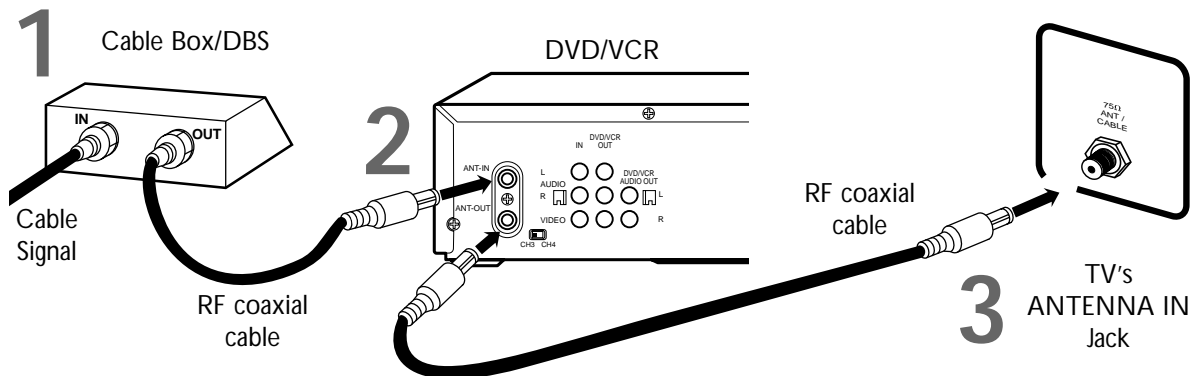

Connections

1

Connect a Cable signal to the IN Jack on the Cable Box/DBS.

2

Use an RF coaxial cable (supplied) to connect the OUT Jack on the Cable Box/DBS to the ANT-IN (Antenna In) Jack on the DVD/VCR.

3

Use a second RF coaxial cable to connect the ANT-OUT (Antenna Out) Jack on the DVD/VCR to the TV's ANTENNA IN Jack.

Recording/Viewing Any Channel

1

With the DVD/VCR on and in VCR position (the VCR light and the VCR/TV light will appear on the display panel), use the **CHANNEL ▲/▼** buttons to set the DVD/VCR to the Cable Box/DBS output channel (channel 03 or 04). Set the CH3/CH4 switch to the same channel.

2

Set the TV to the same channel to which you set the DVD/VCR.

3

Select the channel you want to view/record at the Cable Box/DBS.

Hookups With a Cable Box/Direct Broadcast System (cont'd) 11

With this connection:

- You may watch one channel while recording another.
- You may not record scrambled channels.

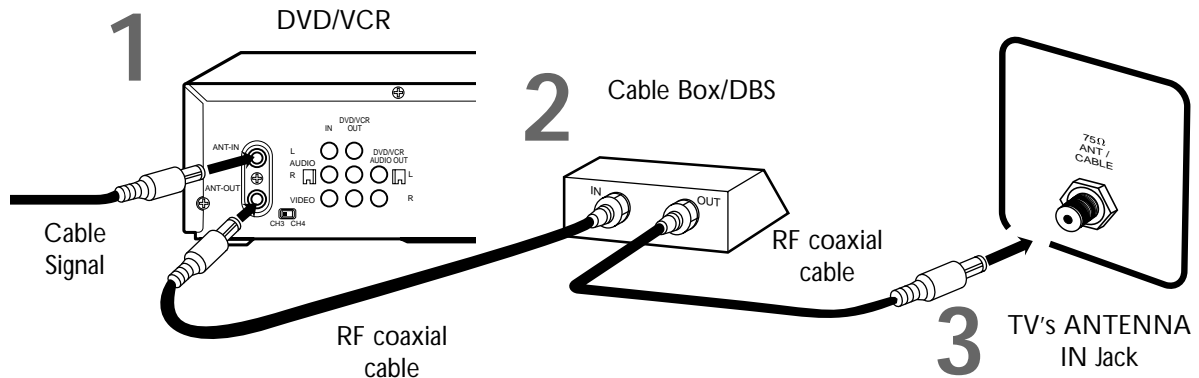

Connections

1

Connect a Cable signal to the DVD/VCR's ANT-IN (Antenna In) Jack.

2

Use an RF coaxial cable (supplied) to connect the ANT-OUT (Antenna Out) Jack on the DVD/VCR to the IN Jack on the Cable Box/DBS.

3

Use a second RF coaxial cable to connect the OUT Jack on the Cable Box/DBS to the ANTENNA IN Jack on the TV.

Recording One Channel/Watching Another

1

Put the Cable Box/DBS on the same channel as the DVD/VCR's CH3/CH4 switch. Set the TV to the Cable Box/DBS output channel (03 or 04).

Then, with the DVD/VCR in VCR position (the VCR light and the VCR/TV light will appear on the display panel), use the **CHANNEL ▲/▼** buttons to select the channel you want to record at the DVD/VCR. Start the recording.

2

Press the **VCR/TV** button once to put the DVD/VCR in TV position. (The VCR/TV light will disappear.)

3

Select the channel you want to watch at the Cable Box/DBS.

Helpful Hint

- When you play a tape, make sure the Cable Box/DBS is set to the same channel as the CH3/CH4 switch on the DVD/VCR. Set the TV to the Cable Box/DBS output channel (03 or 04).

12 Optional Hookups

You may connect the DVD/VCR several different ways, depending on your existing equipment and your preferences for sound and picture quality. To determine which hookup is best for you, examine the options on the following pages, then see which best matches your situation. Before you hook up the DVD/VCR, remember:

- Connect the DVD/VCR directly to a TV. If you connect the DVD/VCR to a VCR, then connect the VCR to the TV, the picture may be distorted by the copyright protection system.
- Turn off the power of all equipment before making any connections.
- Refer to the owner's manuals of your other equipment for additional information.
- Depending on your connection, you may need to purchase additional cables.
- When you use the DVD/VCR AUDIO and VIDEO OUT jacks on the DVD/VCR, press the DVD/VCR OUTPUT button to select VCR mode (or DVD mode).
- The S-VIDEO OUT, COAXIAL, OPTICAL, and COMPONENT VIDEO OUT jacks are useful only in DVD mode.

Connecting the DVD/VCR to a Stereo TV

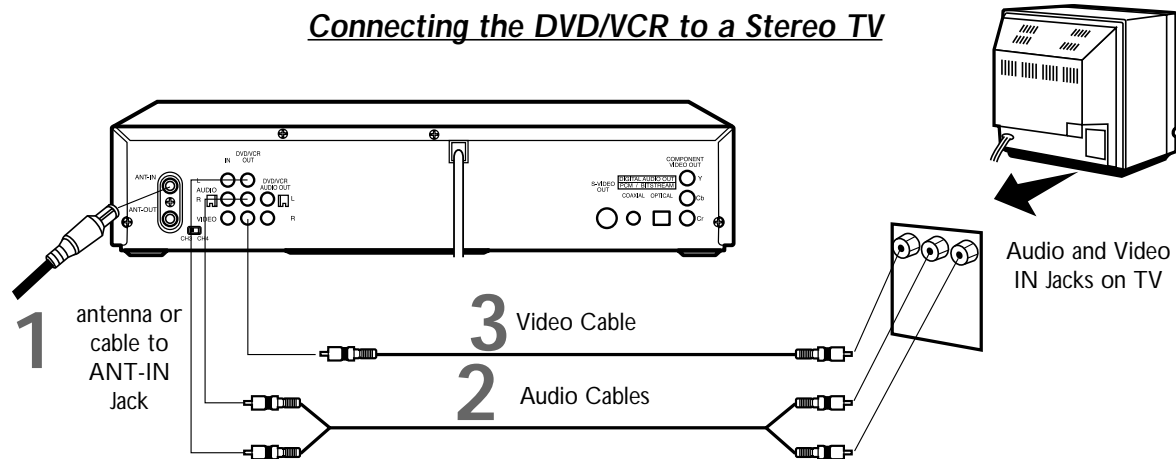

1

Connect the antenna or cable to the ANT-IN (Antenna In) jack of your DVD/VCR.

2

Connect the red and white audio cables (supplied) to the red and white DVD/VCR AUDIO OUT jacks on the DVD/VCR and to the red and white AUDIO IN jacks on the TV, matching the cable colors to the jack colors. If the TV has a single AUDIO IN jack, use the white audio cable to connect the DVD/VCR's white DVD/VCR AUDIO OUT jack to the TV's AUDIO IN jack. You will not use the red audio cable.

3

Connect the yellow video cable (supplied) to the DVD/VCR VIDEO OUT jack on the DVD/VCR and to the VIDEO IN jack on the TV. Or, for better picture quality, connect an S-Video cable (not supplied) to the S-VIDEO OUT jack on the DVD/VCR and to the S-VIDEO IN jack on the TV. You will not use the supplied yellow video cable.

4

Connect the TV's power cord to a power outlet. Turn on the TV and set it to the Audio/Video In channel, which also may be referred to as A/V In or Auxiliary In. This channel usually is located near channel 00. See your TV owner's manual for details. Or, if you used the S-Video cable at step 3, select the S-Video In channel at your TV. See your TV owner's manual for details.

5

Connect the DVD/VCR's power cord to a power outlet. Press the POWER button, then press the DVD/VCR OUTPUT button so that the DVD light appears on the DVD/VCR. "HELLO" will appear briefly on the DVD/VCR's display panel. You should see the DVD logo on the TV screen briefly. If you do not, check your connections and make sure the TV is set to the correct Audio/Video In channel. If there is no disc in the DVD/VCR, "no DISC" will appear on the display panel.

Optional Hookups (cont'd) 13

Connecting to a TV and a Stereo

TV has Component Video In Jacks

- Set DOLBY DIGITAL and DTS to OFF on the DVD/VCR. Details are on pages 68-69. If you play a DVD when the settings are wrong, the sound will be distorted or you may damage the speakers.

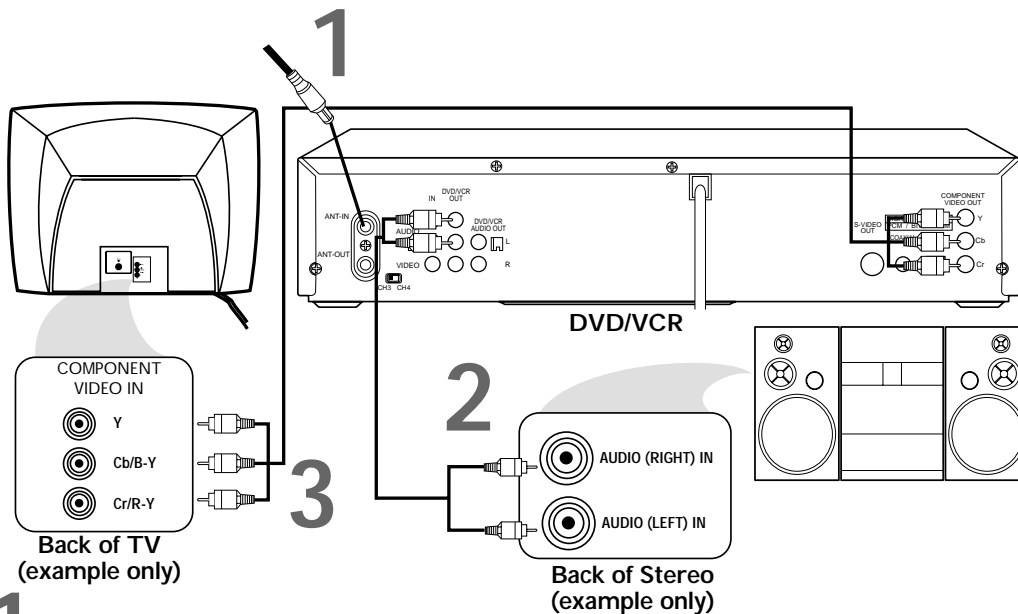

1
Connect the antenna or cable to the ANT-IN (Antenna In) jack of your DVD/VCR.

2
Connect the red and white audio cables to the red and white DVD/VCR AUDIO OUT Jacks on the DVD/VCR and to the red and white AUDIO IN jacks on the Stereo, matching the cable colors to the jack colors.

3
Connect an optional component video cable to the COMPONENT VIDEO OUT jacks on the DVD/VCR and to the COMPONENT VIDEO IN jacks on the TV.

4
Plug in the Stereo's power cord. Turn on the Stereo and select the Stereo's Auxiliary IN station. During Disc playback, you will adjust the volume at your Stereo. See your Stereo owner's manual for details.

5
Plug in the TV's power cord. Turn on the TV and set it to the Component Video In channel, which usually is located near channel 00. During Audio CD playback, you may check the status of Audio CDs on your TV screen. During DVD playback, you will watch the program on the TV. See your TV owner's manual for details.

6
Connect the DVD/VCR's power cord to a power outlet. Press the POWER button, then press the DVD/VCR OUTPUT button so that the DVD light appears on the DVD/VCR. "HELLO" will appear briefly on the DVD/VCR's display panel. You should see the DVD logo on the TV screen briefly. If you do not, check your connections and make sure the TV is set to the correct Component Video In channel. If there is no disc in the DVD/VCR, "no DISC" will appear on the display panel.

14 Optional Hookups (cont'd)

Connecting to a Dolby Digital Decoder, DTS Decoder, or Amplifier

Some Discs are recorded in a 5.1 channel Dolby Digital Surround or Digital Theater System (DTS) Surround format. These Discs will sound best if you connect the DVD/VCR to a Dolby Digital or DTS Decoder.

- You will need a coaxial digital audio cable or an audio optical cable (not supplied). See *Helpful Hints* below.
- If you use the OPTICAL jack, remove the protective cap.
- If you connect the DVD/VCR to a Dolby Digital Decoder, set DOLBY DIGITAL to ON. Details are on pages 68-69.
- If you connect the DVD/VCR to a DTS Decoder, set DTS to ON. Details are on pages 68-69.
- If the DVD/VCR is not connected to a Dolby Digital or DTS decoder, set DOLBY DIGITAL and DTS to OFF. Incorrect settings may cause noise distortion and damage the speakers.
- Select the 5.1 channel Dolby Digital Surround sound in the Disc menu.
- Connect a subwoofer and the center, front, and surround speakers to the Decoder as described in the Decoder owner's manual.
- If the Disc is recorded in 5.1 channel Dolby Digital Surround, you cannot dub the Disc in digital sound using a Mini-Disc or Digital Audio Tape Deck.

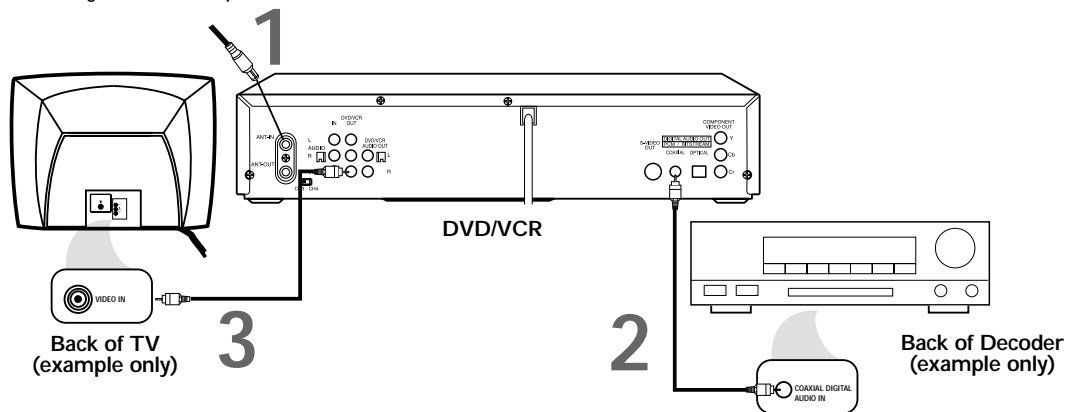

1

Connect the antenna or cable to the ANT-IN (Antenna In) jack of your DVD/VCR.

2

Connect a coaxial digital audio cable (not supplied) to the COAXIAL jack on the DVD/VCR and to the COAXIAL DIGITAL AUDIO IN jack on the Decoder or Amplifier. (Or, you may connect an audio optical cable (not supplied) to the OPTICAL jack on the DVD/VCR and to the OPTICAL DIGITAL AUDIO IN jack on the Decoder or Amplifier.)

3

Connect the supplied yellow video cable to the yellow DVD/VCR VIDEO OUT jack on the DVD/VCR and to the VIDEO IN jack on the TV. (Or, you may connect a component video cable or a S-Video cable. Details are on pages 12-13.)

4

Plug in the power cord of the Decoder or Amplifier. Turn on the Decoder or Amplifier and select its Auxiliary IN station. During Disc playback, you will adjust the volume at the Decoder or Amplifier. See its owner's manual for details.

5

Plug in the TV's power cord. Turn on the TV and set it to the correct Video In channel. During Audio CD playback, you may check the Disc status on your TV screen. During DVD playback, you will watch the program on the TV. See your TV owner's manual for details.

6

Connect the DVD/VCR's power cord to a power outlet. Press the POWER button, then press the DVD/VCR OUTPUT button so that the DVD light appears on the DVD/VCR. "HELLO" will appear briefly on the DVD/VCR's display panel. You should see the DVD logo on the TV screen briefly. If you do not, check your connections and make sure the TV is set to the correct Video In channel. If there is no disc in the DVD/VCR, "no DISC" will appear on the display panel.

Helpful Hints

- Optical cable may be damaged when bent at acute angles. Ensure cables are coiled in loops with a diameter of 6 inches or more when storing them. 
- Use a cable which is 9.8 feet or shorter.
- Insert cable plugs firmly into the jacks when making connections.
- If a plug has minor scratches or is dirty, clean it with a soft cloth before inserting it into a jack.
- Replace the protective cap on the OPTICAL jack when it is not in use.

Putting Batteries in the Remote Control

1

Remove the battery compartment lid on the bottom of the remote control by pressing the tab, then lifting the lid.

2

Place two AA batteries inside the battery compartment with their + and - ends aligned as indicated.

3

Replace the battery compartment lid.



1

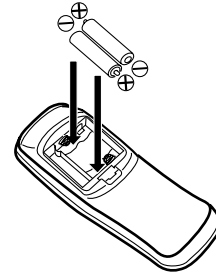

2

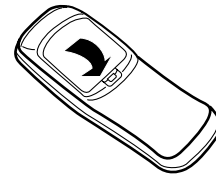

3

Using the Remote Control

- Point the remote control at the DVD/VCR's remote sensor (see page 26) when using the remote control to operate the DVD/VCR.
- Do not put objects between the remote control and the DVD/VCR.

Recycling Guidelines/Battery Safety

- Your new product and its packaging contain materials that can be recycled and reused. Specialized companies can recycle your product to increase the amount that needs to be properly disposed. Your product uses batteries that should not be thrown away when depleted but should be disposed of as small chemical waste. Please find out about the local regulations on disposal of your old product, batteries, and packaging whenever you replace existing equipment.
- Battery Usage CAUTION - To prevent battery leakage that may result in bodily injury or damage to the unit:
Install ALL batteries correctly, with the + and - markings on the battery aligned as indicated on the unit;
Do not mix batteries, for example, old with new or carbon with alkaline; and
Remove batteries when the unit will not be used for a long time.

16 Turning on Your DVD/VCR

Before turning on your DVD/VCR, make sure batteries are in the remote control and the DVD/VCR and TV are connected correctly.

- You can not program channels if you are using a Cable Box or a Direct Broadcast System.

1

Press the **VCR** button, then press the **POWER** button.

"HELLO" will appear briefly on the front of the DVD/VCR. The VCR light, the VCR/TV light, and the POWER light will appear on the front of the DVD/VCR.

2

Turn on the TV. Set it to the same channel as the **CH3/CH4** switch on the back of the DVD/VCR. The display shown below will appear. (If the display does not appear, check your hookups, then follow the steps on page 17 to set up channels and page 22 to select a language.)

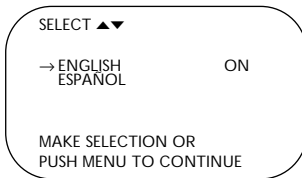

3

Within 60 seconds, press the **PLAY** button or the **STOP** button to select English or Spanish on-screen displays and menus.

4

Press the **MENU** button.

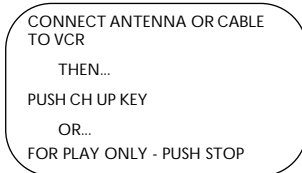

5

Within 60 seconds, press the **CHANNEL ▲** button to begin automatic channel programming. **AUTO CH PROGRAMMING IN PROCESS PLEASE WAIT** will appear on the TV screen. The DVD/VCR will memorize all available channels. When all channels are memorized, **CHANNELS ARE SET** will appear on the screen briefly, then TV programming will appear.

These channels will be available when you want to watch TV while in VCR mode. To put the DVD/VCR in VCR mode, press the DVD/VCR OUTPUT button so that the VCR light appears. Then press the VCR/TV button so that the VCR/TV light appears. Press the VCR button, then use the CHANNEL and Number buttons to select a TV channel for viewing.

2

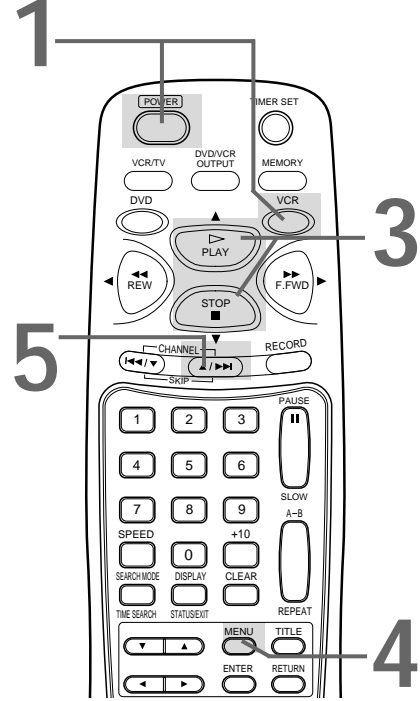
 Turn on the TV.

Helpful Hints

- To skip this feature and play a tape immediately, insert a tape with its record tab removed. Or, to skip step 3, press the MENU button. All on-screen displays will be in English. To skip step 5, press the STOP button. Channels will not be programmed, and CHANNELS NOT SET will appear on the screen.
- If you try to program channels when there is no antenna or cable connected to the DVD/VCR, programming will appear to take place, but eventually a NO TV SIGNALS message will appear. Connect an antenna or cable to the DVD/VCR's ANT-IN (Antenna In) jack and press the CHANNEL ▲ button again. If channel programming does not resume, you may need to follow the steps on page 17.
- You may need to repeat the steps on this page if a power failure occurs.

Automatic Channel Setup 17

Although your DVD/VCR may automatically memorize the channels you receive when you turn it on for the first time, this function lets you set up the channels again.

- Before you begin, place the DVD/VCR in VCR mode. Press the DVD/VCR OUTPUT button so that the green VCR light appears on the front of the DVD/VCR. Press the VCR/TV button so that the VCR/TV light appears on the front of the DVD/VCR.

1

Press the VCR button, then press the MENU button.

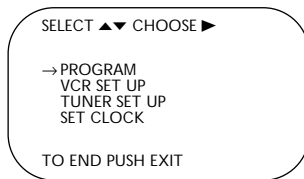

2

Press the PLAY button or the STOP button to select TUNER SET UP, then press the F.FWD button.

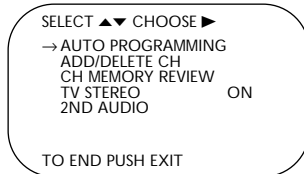

3

Press the PLAY button or the STOP button to select AUTO PROGRAMMING, then press the F.FWD button. The DVD/VCR will memorize all the channels you receive.

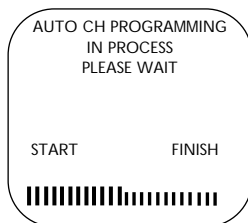

4

Wait for a few minutes while the DVD/VCR sets up the channels. When this is complete, CHANNELS ARE SET will appear on the screen. Then the programming of the lowest channel number placed in the DVD/VCR's memory will appear on the screen. Now when you press the CHANNEL ▲/▼ buttons, you will scan only through channels you receive.

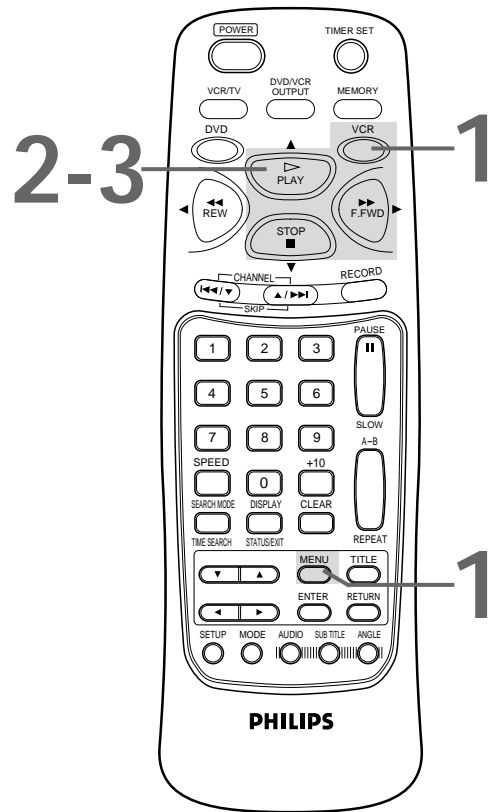

Helpful Hints

- You can not enter the TUNER SET UP menu when you are in Line Input mode (channel 001 or 002). When you select channel 001 or 002, AV REAR or AV FRONT will appear on the screen briefly.
- You can not program channels if you are using a Cable Box or DBS.
- If you have an antenna, channels 2-69 will be available. If you have a cable connection, channels 1-125 will be available.

18 Automatic Channel Setup (cont'd)

Adding/Deleting Channels

- Before you begin, place the DVD/VCR in VCR mode. Press the DVD/VCR OUTPUT button so that the green VCR light appears on the front of the DVD/VCR. Press the VCR/TV button so that the VCR/TV light appears on the front of the DVD/VCR.

1

Press the VCR button, then press the MENU button.

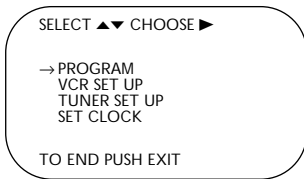

2

Press the PLAY button or the STOP button to select TUNER SET UP, then press the F.FWD button.

3

Press the PLAY button or the STOP button to select ADD/DELETE CH, then press the F.FWD button.

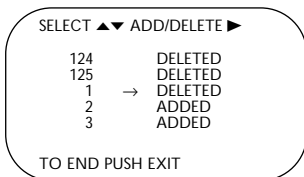

4

Press the PLAY button or the STOP button until the channel number you want to add or delete appears beside the arrow.

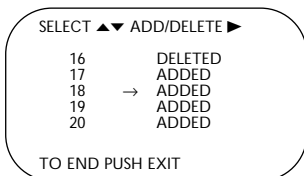

5

Press the F.FWD button to select ADDED or DELETED. Repeat steps 4 and 5 until you have added or deleted all the channels you wanted to add or delete.

6

Press the DISPLAY/STATUS/EXIT button.

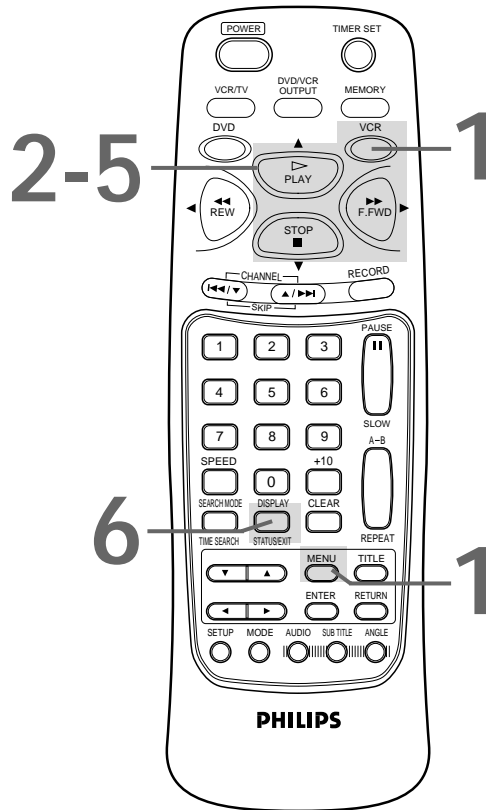

Automatic Channel Setup (cont'd) 19

Reviewing Memorized Channels

- Before you begin, place the DVD/VCR in VCR mode. Press the DVD/VCR OUTPUT button so that the green VCR light appears on the front of the DVD/VCR. Press the VCR/TV button so that the VCR/TV light appears on the front of the DVD/VCR.

1

Press the **VCR** button, then press the **MENU** button.

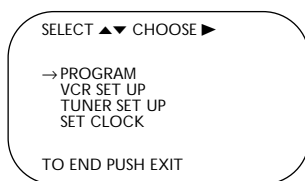

2

Press the **PLAY** button or the **STOP** button to select **TUNER SET UP**, then press the **F.FWD** button.

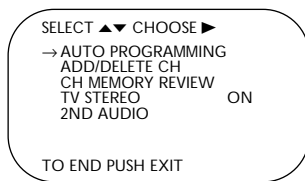

3

Press the **PLAY** button or the **STOP** button to select **CH MEMORY REVIEW**, then press the **F.FWD** button. A list of memorized channels will appear on the screen.

- If all the memorized channels don't fit on the screen, press the **F.FWD** button to see the remaining channels. Then press the **REW(ind)** button to return to the first screen of channels.
- If you do not press any buttons within 10 seconds, you will either go to the next screen of channels or you will return to the previous menu.

4

Press the **DISPLAY/STATUS/EXIT** button once or twice to exit.

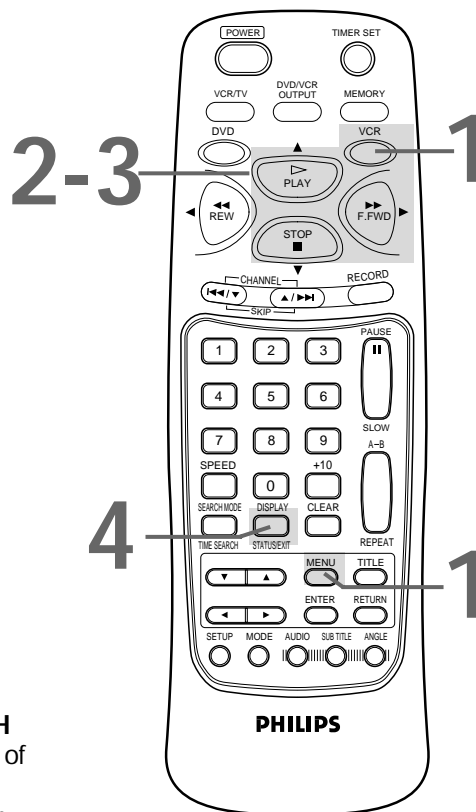

20 Setting the Clock

Follow the steps below to set the clock for the VCR. Make sure:

- The DVD/VCR is on and the VCR/TV light appears on the display panel. (If it does not, press the VCR/TV button once.)
- You make each entry within 60 seconds of the previous entry.
- Before you begin, place the DVD/VCR in VCR mode. Press the DVD/VCR OUTPUT button so that the green VCR light appears on the front of the DVD/VCR. Press the VCR/TV button so that the VCR/TV light appears on the front of the DVD/VCR.

1

Press the **VCR** button, then press the **MENU** button.

2

Press the **PLAY** button or the **STOP** button to select **SET CLOCK**, then press the **F.FWD** button.

3

Press the **PLAY** button or the **STOP** button to select **SET CLOCK**, then press the **F.FWD** button.

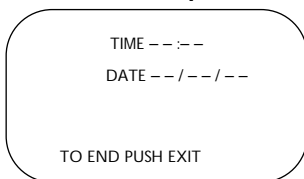

4

Press two **Number** buttons for the hour(s) and two **Number** buttons for the minute(s). Then press **1** for **AM** or **2** for **PM**. For example, for 2:15 PM, press 02, 15, 2.

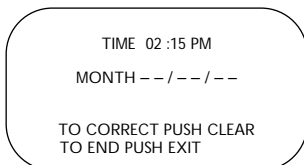

5

Press two **Number** buttons for the month, two **Number** buttons for the day, and two **Number** buttons for the year. For example, for July 1, 2000, press 07, 01, 00. The day of the week will appear automatically.

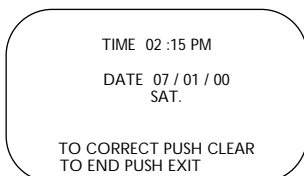

6

Press the **DISPLAY/STATUS/EXIT** button.

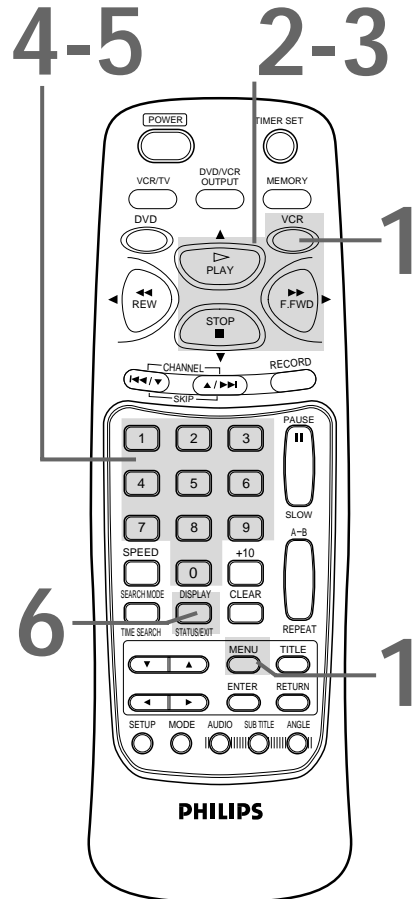

Helpful Hints

- Enter a 0 before a single-digit number.
- Entries that do not match the DVD/VCR's clock or calendar will cause a question mark to appear on the screen.
- To make corrections, press the **CLEAR** button until the space for the number you want to correct is flashing. Then enter the correct number.
- To see the current time on the TV screen, press the **DISPLAY/STATUS/EXIT** button. Details are on page 23.
- Power failures that last for more than one minute can cause you to lose your clock setting.

Daylight-Savings Time 21

You may program the DVD/VCR so the VCR clock will automatically move forward one hour in April and turn back one hour in October. Daylight-Savings Time is set to ON when you receive your DVD/VCR. Turn Daylight-Savings Time ON or OFF by following the steps below. Before you begin:

- Make sure the clock is set.
- Before you begin, place the DVD/VCR in VCR mode. Press the DVD/VCR OUTPUT button so that the green VCR light appears on the front of the DVD/VCR. Press the VCR/TV button so that the VCR/TV light appears on the front of the DVD/VCR.

1

Press the **VCR** button, then press the **MENU** button.

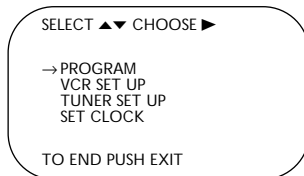

2

Press the **PLAY** button or the **STOP** button to select **SET CLOCK**, then press the **F.FWD** button.

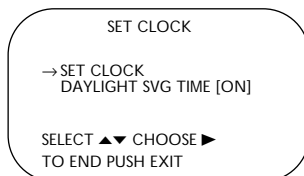

3

Press the **PLAY** button or the **STOP** button to select **DAYLIGHT SVG TIME**. Then, press the **F.FWD** button so that **OFF** (or **ON**) appears beside **DAYLIGHT SVG TIME**.

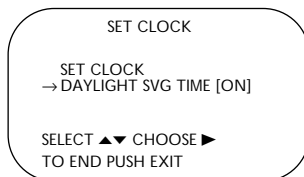

4

Press the **DISPLAY/STATUS/EXIT** button.

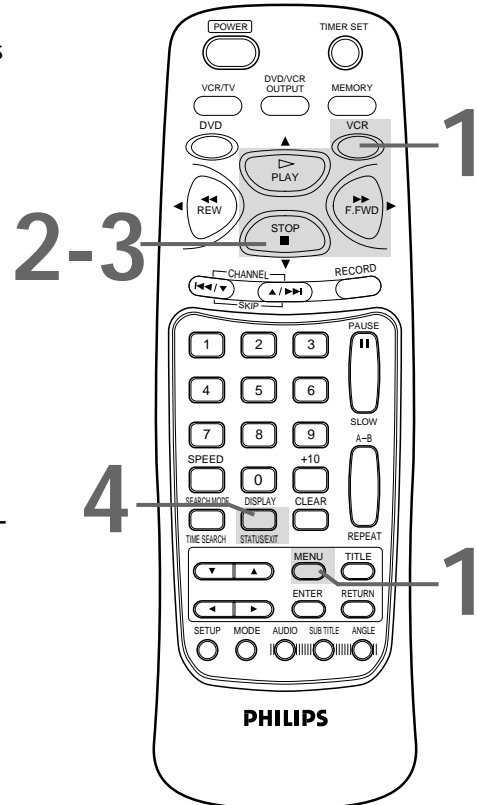

22 Language Selection (VCR)

Follow the steps below to change the language of the VCR on-screen displays and menus.

- Before you begin, place the DVD/VCR in VCR mode. Press the DVD/VCR OUTPUT button so that the green VCR light appears on the front of the DVD/VCR. Press the VCR/TV button so that the VCR/TV light appears on the front of the DVD/VCR.

1

Press the **VCR** button, then press the **MENU** button.

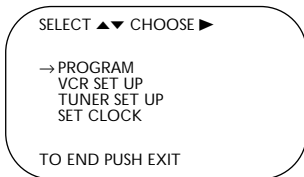

2

Press the **PLAY** button or the **STOP** button to select **VCR SET UP**, then press the **F.FWD** button.

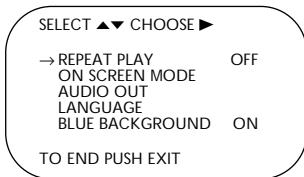

3

Press the **PLAY** button or the **STOP** button to select **LANGUAGE**, then press the **F.FWD** button.

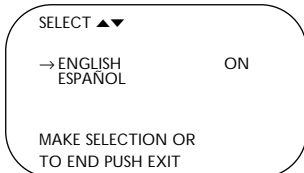

4

Press the **PLAY** button or the **STOP** button to select **English** or **Spanish (ESPAÑOL)** on-screen displays and menus.

5

Press the **DISPLAY/STATUS/EXIT** button.

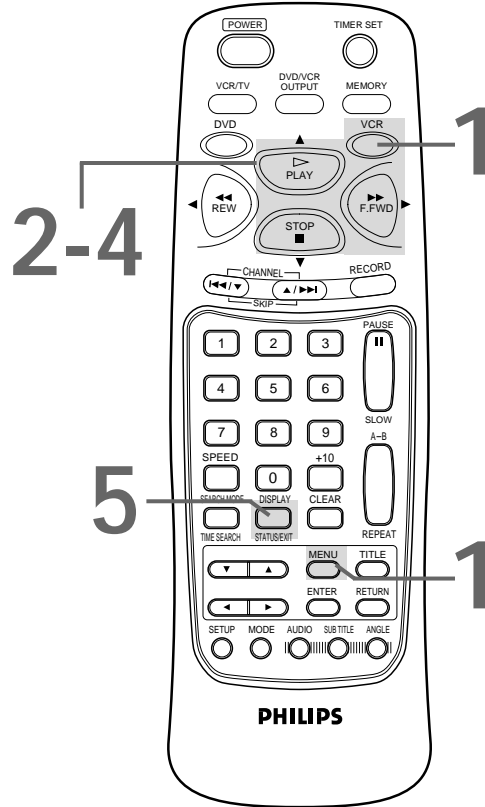

Helpful Hint

- If you accidentally select Spanish and need English:
 1. Press the **VCR** button, then press the **MENU** button.
 2. Press the **PLAY** button or the **STOP** button to select **PREPARE EL VCR**, then press the **F.FWD** button.
 3. Press the **PLAY** button or the **STOP** button to select **LENGUAJE**, then press the **F.FWD** button.
 4. Press the **PLAY** button or the **STOP** button to select **ENGLISH**.
 5. Press the **DISPLAY/STATUS/EXIT** button.

On-Screen Status Displays (VCR) 23

A status display will appear when you press the DISPLAY/STATUS/EXIT button or certain function buttons. The contents of the status display will vary. To choose the status display mode, follow the steps below.

- Before you begin, place the DVD/VCR in VCR mode. Press the DVD/VCR OUTPUT button so that the green VCR light appears on the front of the DVD/VCR. Press the VCR/TV button so that the VCR/TV light appears on the front of the DVD/VCR.

If you select STATUS ON, then select COUNTER ONLY ON:

- Whenever you press the STOP button or the PLAY button, the status display will appear for five seconds. After five seconds, only the counter will remain on the screen. You must press the DISPLAY/STATUS/EXIT button to remove it. Portions of the status display also may appear when you press other function buttons.

If you select STATUS ON, then select COUNTER ONLY OFF:

- Whenever you press the STOP button or the PLAY button, the status display will appear for five seconds. Portions of the status display also may appear when you press other function buttons.

If you select STATUS OFF:

- The status display will not appear when you press function buttons. You must press the DISPLAY/STATUS/EXIT button to see the status display.

1

Press the MENU button.

2

Press the PLAY button or the STOP button to select VCR SET UP, then press the F.FWD button.

3

Press the PLAY button or the STOP button to select ON SCREEN MODE, then press the F.FWD button.

4

Press the PLAY button or the STOP button to select STATUS, then press the F.FWD button so that OFF (or ON) appears beside STATUS.

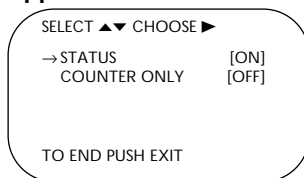

5

If you set STATUS to OFF, go to step 6. If you set STATUS to ON, press the PLAY button or the STOP button to select COUNTER ONLY, then press the F.FWD button so that OFF (or ON) appears beside it.

6

Press the DISPLAY/STATUS/EXIT button.

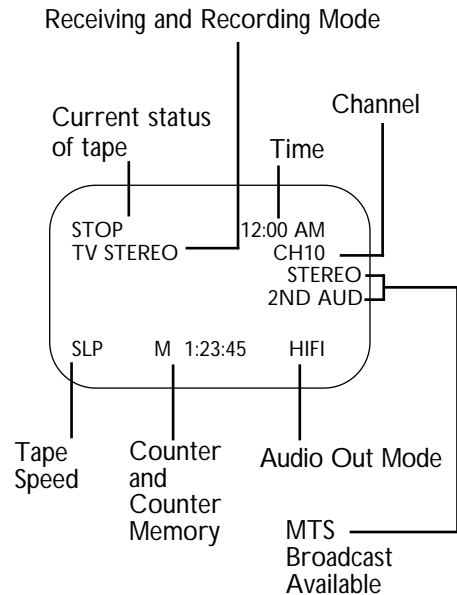

Helpful Hints

- You may not access a status display when viewing a still picture, during slow motion playback, or during forward or reverse searching.
- The status display may not appear if a weak channel is selected and BLUE BACKGROUND is set to OFF. Details are on page 49.

24 DVD/VCR Display - DVD Features

Display

Messages about current DVD operations appear here. See Display Messages below.

DVD Light (red)

This light appears when the DVD/VCR is in DVD mode. You can only watch DVDs when the DVD light is on. To make the DVD light come on, press the OUTPUT button on the front of the DVD/VCR.

Disc loading tray

Insert a Disc here.

POWER Light

This Light appears when the power is on.

Lit when a DVD is inserted. When the DVD light is on, the disc is loaded completely and is ready for playback.

Lit when an Audio CD is inserted. When the CD light is on, the disc is loaded completely and is ready for playback.

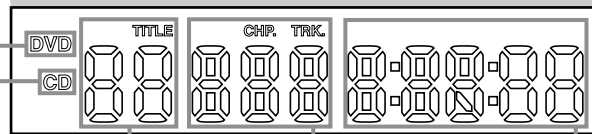

Displays a title number (DVD)

Displays a chapter (DVD) or track (Audio CD) number

Displays the elapsed time of the current title (DVD) or track (Audio CD)

Display Messages

HELLO	Power is turning on.
NO DISC	Appears after the disc tray closes if the tray is empty.
OPEN	Tray is opening or is open.
CLOSE	Tray is closing.
SEARCH	Appears briefly when you press the SKIP buttons to search for the next or previous chapter/track.
BYE	Power is turning off.
LOAD	Disc is loading.

DVD/VCR Display - VCR Features 25

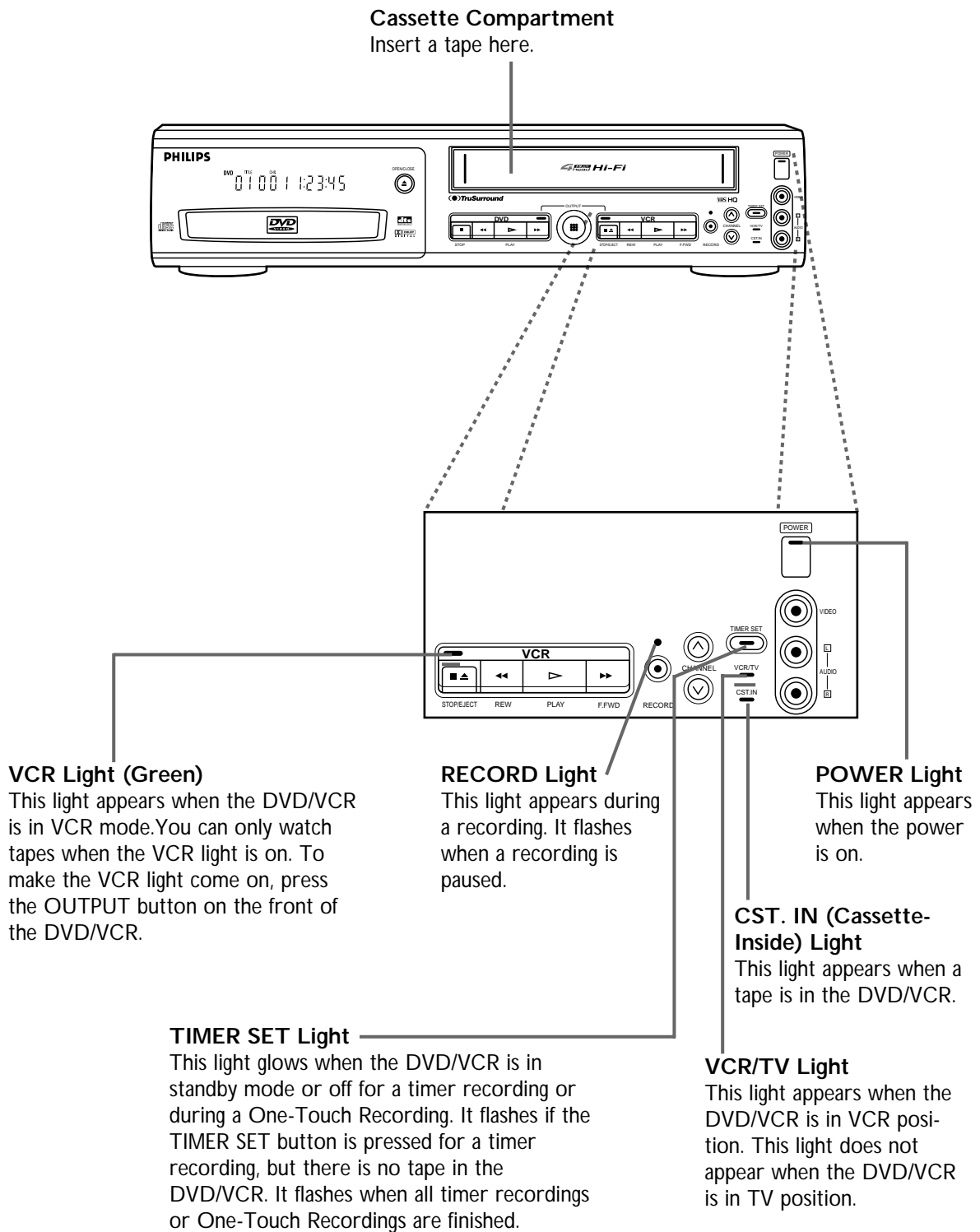

26 Front Panel

POWER Button

Press to turn the power on and off.

TIMER SET Button

Press to put the DVD/VCR into standby mode for a timer recording. *Details are on page 38.*

CHANNEL Buttons

In VCR mode, press to change channels at the DVD/VCR. Or, press to adjust the tracking of a tape during normal playback or slow motion playback. Also, press to remove vertical jitter in a Still picture. *Details are on page 45.*

RECORD Button

Press once to start a recording. Press repeatedly to start a One-Touch Recording. *Details are on page 35.*

PLAY Button

Press to play a tape. Press to release Slow, Search, or Still mode and return to tape playback. *Details are on page 44.* Press to select an item in the VCR menu.

Remote Sensor

Receives a signal from your remote control so you can operate your DVD/VCR from a distance.

SEARCH Buttons

Press for a fast forward or reverse search during Disc playback. *Details are on page 54.*

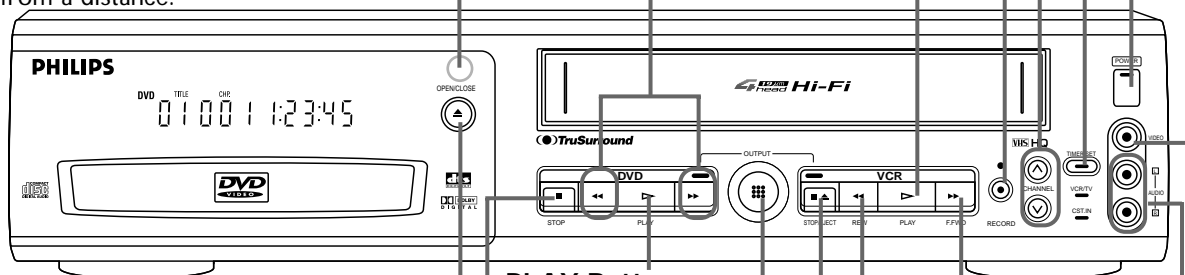

OPEN/CLOSE Button

Press to open or close the Disc tray. *Details are on page 50.*

STOP Button

Press to stop Disc playback. *Details are on page 50.*

REW(ind) Button

When tape playback is stopped, press to rewind the tape at high speed. During playback, press to rewind the tape while the picture stays on the screen. *Details are on page 44.* Press to return to a previous VCR menu.

AUDIO In Jacks

Connect audio cables coming from the audio out jacks of a camcorder, another VCR, or an audio source here. *Details are on page 40.*

VIDEO In Jack

Connect a video cable coming from the video out jack of a camcorder, another VCR, or a video source (laser disc player, video disc player, etc.) here. *Details are on page 40.*

PLAY Button

Press to start or resume Disc playback. *Details are on page 50.*

OUTPUT Button

Press to select DVD mode or VCR mode.

STOP/EJECT Button

Press once to stop the tape. When playback is stopped, press to eject the tape. Press to select an item in the VCR menu.

F.FWD (Fast Forward) Button

When tape playback is stopped, press to fast forward the tape at high speed. During tape playback, press to fast forward the tape while the picture stays on the screen. *Details are on page 44.* Press to advance to the next VCR menu or to change the setting of an item in the VCR menu.

Rear Panel 27

ANT-IN (Antenna In) Jack

Connect your antenna or cable here.
Details are on pages 8-14.

AUDIO IN Jacks

Connect audio cables coming from the audio out jacks of a camcorder, another VCR, or an audio source here. *Details are on page 40.*

DVD/VCR AUDIO OUT Jacks

Connect the supplied audio cables here and to the Audio In jacks of a television or other audio equipment. *Details are on pages 12-14.*

COMPONENT VIDEO OUT Jacks

Connect optional component video cables here and to the component Video In jacks of a television. *Details are on page 13.*

COAXIAL Jack

Connect an optional coaxial digital audio cable here and to the Coaxial Digital Audio In jack of a decoder or amplifier. *Details are on page 14.*

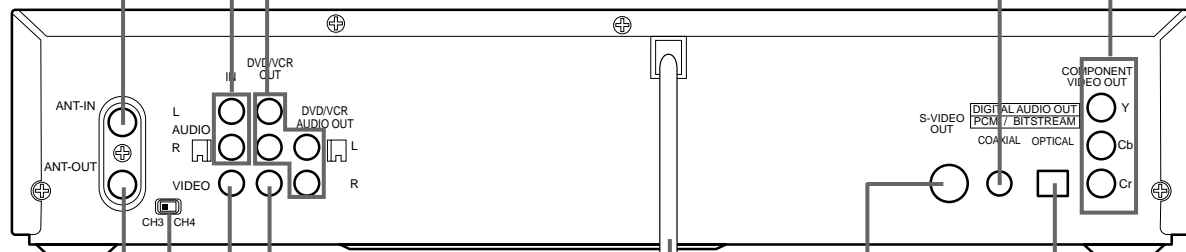

DVD/VCR VIDEO OUT Jack

Connect the yellow video cable (supplied) here and to the TV's Video In jack. *Details are on pages 12 and 14.*

VIDEO IN Jack

Connect a cable coming from the video out jack of a camcorder, another VCR, or an audio-visual source (laser disc player, video disc player, etc.) here. *Details are on page 40.*

CH3/CH4 Switch

Set to channel 3 or 4 to use your TV with your DVD/VCR. *Details are on pages 8-11.*

AC Power Cord

Connect to a standard AC outlet to supply power to the DVD/VCR.

OPTICAL Jack

Connect an optional audio optical cable here and to the Optical Digital Audio In jack of a decoder or amplifier. *Details are on page 14.* When the OPTICAL jack is not in use, make sure its protective cap is in place.

S-VIDEO OUT Jack

Connect an optional S-Video cable here and to the S-Video In jack of a television. *Details are on pages 12 and 14.*

ANT-OUT (Antenna Out) Jack

Use the supplied RF coaxial cable to connect this jack to the ANTENNA IN Jack on your TV, Cable Box, or Direct Broadcast System. *Details are on pages 8-11.*

Helpful Hints

- You only need one audio connection and one video connection, so you will not have a cable connected to every jack. For example, if you are using the S-VIDEO OUT jack, you will not use the yellow VIDEO OUT jack or the COMPONENT VIDEO OUT jacks.
- The S-VIDEO OUT jack, COAXIAL jack, OPTICAL jack, and COMPONENT VIDEO OUT jacks are only useful in DVD mode.
- When you use the DVD/VCR AUDIO and VIDEO OUT jacks, press the DVD/VCR OUTPUT button on the remote control to select VCR mode or DVD mode.

28 Remote Control Buttons

DVD/VCR OUTPUT Button
 Press to select DVD mode or VCR mode. The DVD light will appear on the front of the DVD/VCR when it is in DVD mode. The VCR light will appear on the front of the DVD/VCR when it is in VCR mode. For video tape playback, also make sure the VCR/TV light is on. *Details are on page 32.*

POWER Button
 Press to turn the power on and off. "HELLO" appears briefly on the display panel as the DVD/VCR turns on. "BYE" appears briefly as the DVD/VCR turns off. *Details are on page 24.*

DVD Button
 Press before using the remote control for DVD features.

REW(ind) Button
DVD mode ●
 Press to view the picture in fast reverse motion (DVD) or to reverse playback of an Audio CD. *Details are on page 54.*
VCR mode ●
 When tape playback is stopped, press to rewind the tape at high speed. During playback, press to rewind the tape while the picture stays on the screen. *Details are on page 44.* Press to return to a previous menu.

STOP Button
 In DVD mode, press to stop Disc playback. In VCR mode, press to stop tape playback or recording, or press to select an item in the VCR menu.

SEARCH MODE/TIME SEARCH Button
DVD mode ●
 Press to access or remove the SEARCH menu, which allows you to go directly to a specific Title/Chapter/Track/Time. *Details are on pages 55-57.*
VCR mode ●
 Press to fast forward or rewind the tape a specific length of time. *Details are on page 43.*

SETUP Button
 When Disc playback is stopped, press to access or remove the DVD player's SETUP menu. *Details are on pages 66-74.*

RETURN Button
 Press to return to the previous DVD SETUP menu or to remove the SETUP menu from the TV screen.

TITLE Button
 Press to display the Title menu of the Disc, if available. *Details are on page 51.*

Helpful Hints

- To use the remote control to operate the DVD player and its features, press the DVD button on the remote control before pressing other DVD buttons. DVD operation buttons are labelled in blue or white. Make sure the DVD/VCR is in DVD mode by pressing the DVD/VCR OUTPUT button so that the DVD light appears on the front of the DVD/VCR.
- To use the remote control to operate the VCR and its features, press the VCR button on the remote control before pressing other VCR buttons. VCR operation buttons are labelled in orange or white. Make sure the DVD/VCR is in VCR mode by pressing the DVD/VCR OUTPUT button so that the DVD light appears on the front of the DVD/VCR.

Remote Control Buttons (cont'd) 29

MEMORY Button
Press to memorize a tape position at which the real-time counter was set to 0:00:00. *Details are on page 42.*

TIMER SET Button
Press to put the DVD/VCR in standby mode so a timer recording can occur. *Details are on pages 36-38.*

VCR/TV Button
Use to select the signal that your TV receives.
VCR Position (VCR or DVD mode) ●
When the green VCR light appears on the front of the DVD/VCR, use the VCR to watch a tape, to watch a TV program while recording it, or to watch a TV broadcast using the CHANNEL ▲/▼ or Number buttons to change channels at the DVD/VCR.
When the red DVD light appears on the front of the DVD/VCR, use the DVD Player to view Disc playback or menus.
If the VCR/TV light appears on the front of the DVD/VCR, it is in VCR position (in either VCR or DVD mode).

TV Position ●
Use to watch TV (changing channels at the TV) or to watch one program while recording another. *Details are on page 34.* If the VCR/TV light doesn't appear on the front of the DVD/VCR, it is in TV position.

A-B REPEAT Button
Press to set up A-B Repeat Play, which repeatedly plays a specific segment of a Disc. *Details are on page 59.*

MENU Button
DVD mode ●
Press to display the menu of the Disc. *Details are on pages five and 51.*
VCR mode ●
Press to access the VCR menu.

ENTER Button
Press to select a setting in the DVD Player menu or to select a feature in the Disc menu.

SUBTITLE Button
During disc playback, press to access the subtitle menu of the Disc, then press the ▲/▼ buttons to select a language for the subtitles (among those available) or to turn off the subtitles. *Details are on page 63.*

REPEAT Button
Press to repeat playback of the current Disc or Track (Audio CD) or a Title or Chapter (DVD). *Details are on page 58.*

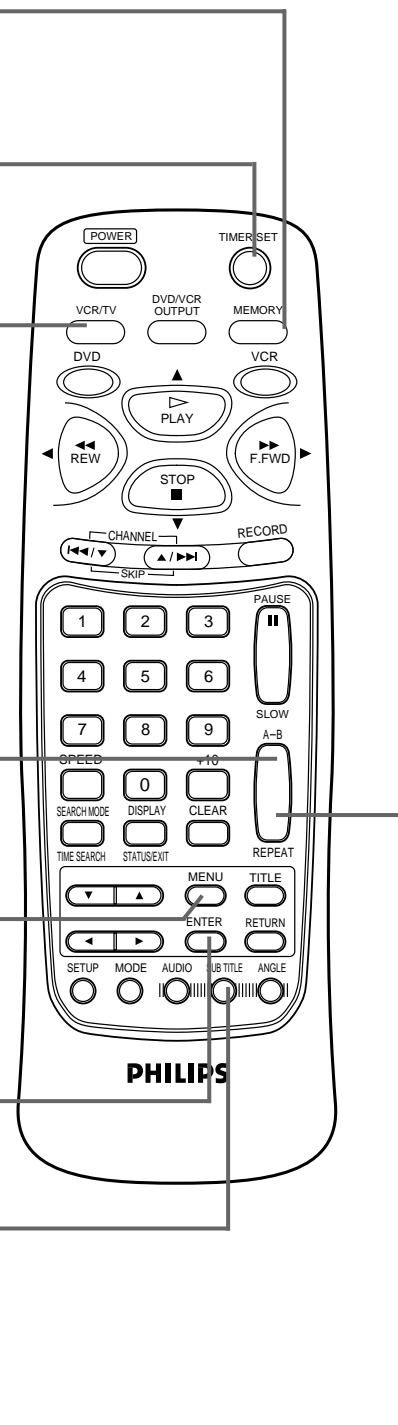

30 Remote Control Buttons (cont'd)

SLOW Button

During tape playback, press to view the picture in slow motion. Press again to resume normal playback. *Details are on page 44.*

PAUSE Button

DVD mode ●

Press to pause Disc playback. *Details are on page 52.* Press repeatedly to advance the DVD picture step by step (or one frame at a time). *Details are on page 53.*

VCR mode ●

While recording, press to temporarily stop the recording (pause). Press a second time to resume normal recording. *Details are on page 33.* You can not pause a One-Touch Recording. Or, press during tape playback to freeze the picture. Press again to resume playback. *Details are on page 44.*

SKIP/CHANNEL Buttons

DVD mode ●

Press to skip Chapters or Tracks. *Details are on page 55.*

VCR mode ●

Press to change channels at the DVD/VCR.

Number Buttons

DVD mode ●

Press to directly select a Track (Audio CD) or a Chapter or Title (DVD) for playback. *Details are on pages 55-56.* Press to program Tracks (Audio CD) for playback. *Details are on page 60.*

VCR mode ●

Use to set up VCR features (such as the clock). Press to select TV channels at the DVD/VCR. **Cable Users:** Enter channel numbers as a two-digit number for the quickest results. For example, to select channel 6, press 0,6. If you only press the Number 6 button, channel 6 will be selected after a brief delay. (There also may be a brief delay when you select channels 10, 11, and 12.) If you want to select channels 100 and above, enter channel numbers as a three-digit number. For example, to select channel 117, press number buttons 1, 1, 7. **Antenna Users:** Enter channel numbers as a two-digit number for the quickest results. For example, to select channel 5, press 0,5. If you only press the Number 5 button, channel 5 will be selected after a brief delay. You may only select channels 2-69.

DISPLAY/STATUS/EXIT Button

DVD mode ●

Press to display information about the disc. *Details are on page 65.*

VCR mode ●

Press to access or remove the VCR's on-screen status display. *Details are on page 23.* Press to exit on-screen VCR menus.

MODE Button

Press to set up programmed or random playback for an Audio CD. *Details are on pages 60-61.*

CLEAR Button

DVD mode ●

Press to remove Track numbers from a Program. *Details are on page 60.*

VCR mode ●

Press to erase incorrect data when programming VCR functions. Also, press to reset the real-time counter. *Details are on page 42.*

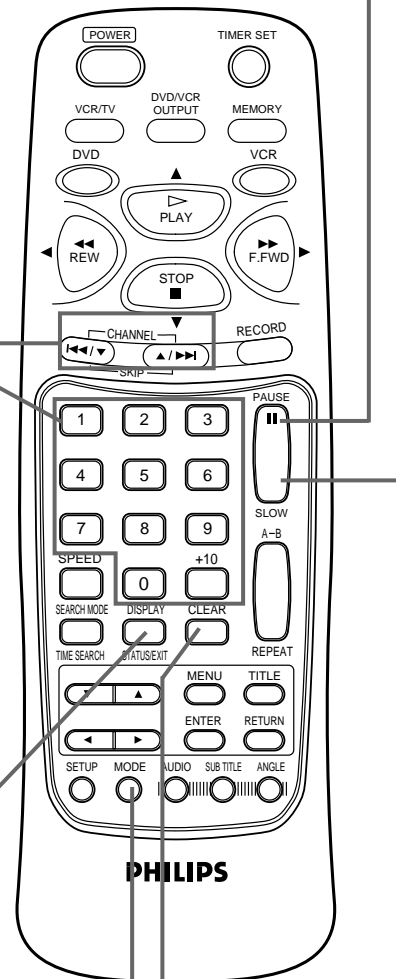

Helpful Hints

- To use the remote control to operate the DVD player and its features, press the DVD button on the remote control before pressing other DVD buttons. DVD operation buttons are labelled in blue or white. Make sure the DVD/VCR is in DVD mode by pressing the DVD/VCR OUTPUT button so that the DVD light appears on the front of the DVD/VCR.
- To use the remote control to operate the VCR and its features, press the VCR button on the remote control before pressing other VCR buttons. VCR operation buttons are labelled in orange or white. Make sure the DVD/VCR is in VCR mode by pressing the DVD/VCR OUTPUT button so that the DVD light appears on the front of the DVD/VCR.

Remote Control Buttons (cont'd) 31

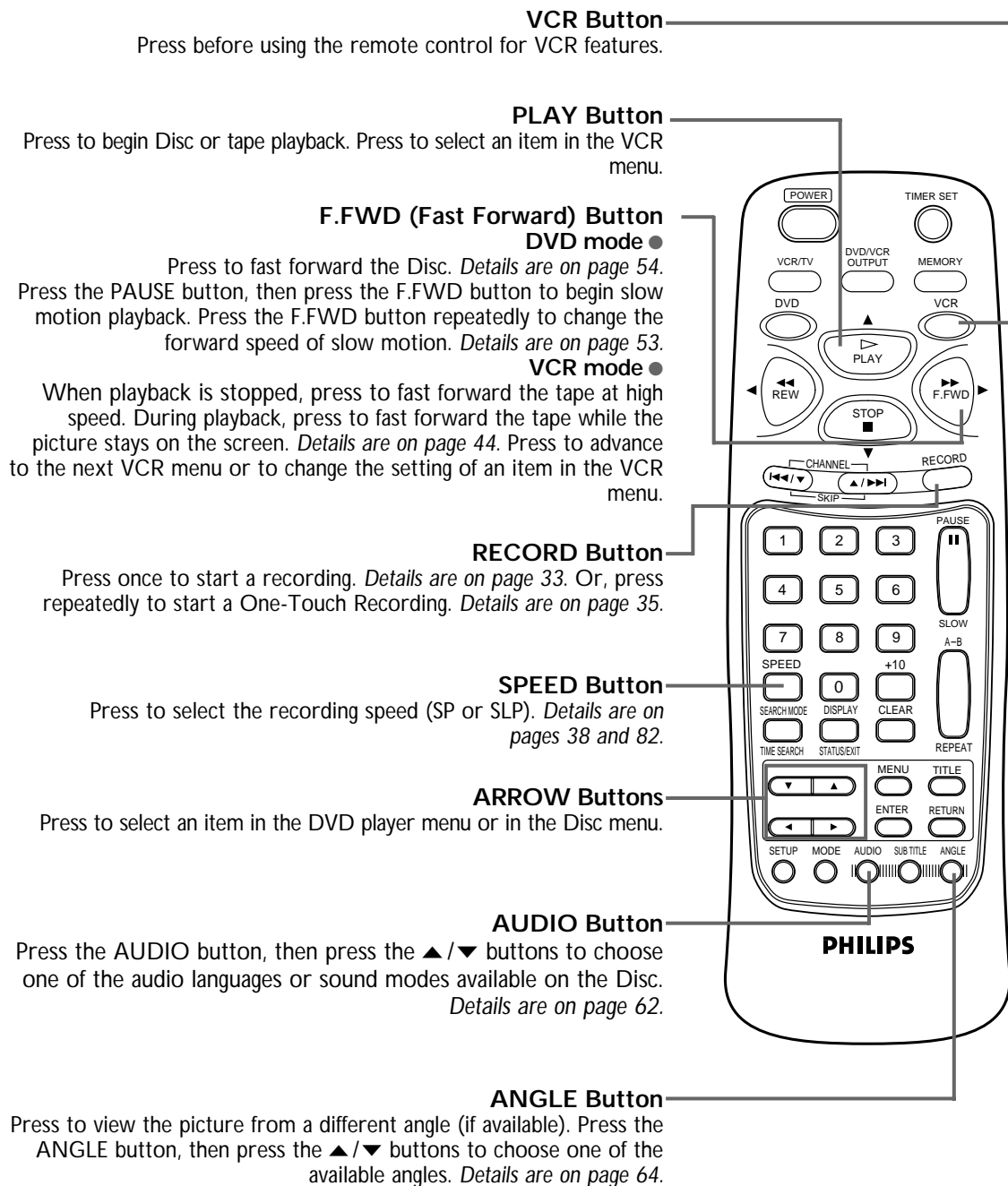

32 Playing a Video Cassette Tape

VCR

Read and follow the steps below to play a tape.

1

Turn on the TV and set it to channel 3 or 4, whichever channel the CH3/CH4 switch on the back of the DVD/VCR is set to. Or, if you connected the DVD/VCR to the TV using audio and video cables, select the correct audio and video in channel at the TV. *Details are on page 12.*

2

Insert a tape in the cassette compartment of the DVD/VCR. The POWER, VCR, VCR/TV and CST. IN lights will appear on the front of the DVD/VCR. If the tape's record tab has been removed, playback will start automatically.

3

If playback does not start automatically, press the VCR button, then press the PLAY button.

4

Press the STOP button to stop playback.

5

Press the REW(ind) button to rewind the tape.

6

After the tape stops, press the STOP/EJECT button on the DVD/VCR to remove the tape.

S-VHS Quasi Play Back (SQPB)

This unit allows you to view a tape recorded in S-VHS format. A tape recorded in S-VHS format will play the same as a tape recorded in normal format. This unit detects whether the tape is recorded in S-VHS format or in normal format.

1 Turn on the TV.

2 Insert a tape in the DVD/VCR.

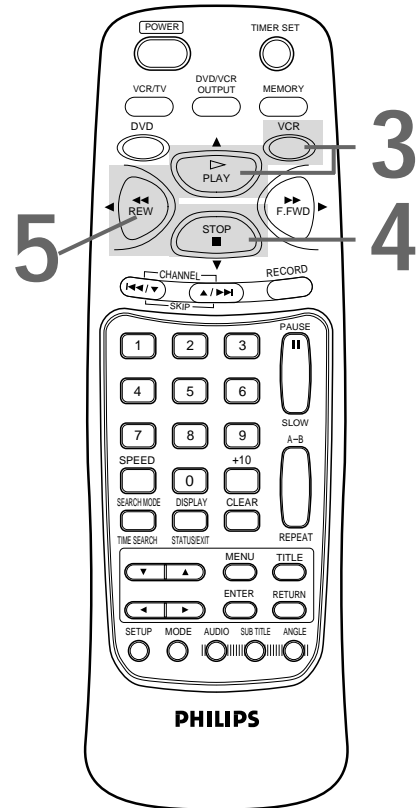

Helpful Hints

- If the tape you want to play is already in the DVD/VCR, make sure the DVD/VCR power is on and the DVD/VCR is in VCR mode and VCR position. (The VCR light and the VCR/TV light will appear on the front of the DVD/VCR.) Then press the PLAY button.
- Other tape playback options and features are on pages 41-48.
- When you play a tape recorded in S-VHS format on this unit, you can not get the high resolution that would be available on an S-VHS VCR. Noise lines (black and white streaks) may appear on the picture.
- If REPEAT PLAY is set to ON, playback will begin automatically, even when the record tab is intact.

Recording on a Video Cassette Tape 33

VCR

Read and follow the steps below to record a television program onto a video cassette tape. Before you begin, make sure the DVD/VCR is in VCR mode. Press the DVD/VCR OUTPUT button so that the green VCR light appears on the front of the DVD/VCR.

1

Turn on the TV and set it to channel 3 or 4, whichever channel the CH3/CH4 switch on the back of the DVD/VCR is set to. Or, if you connected the DVD/VCR to the TV using audio and video cables, select the correct audio and video in channel at the TV. Details are on page 12.

2

Insert a tape with its record tab intact into the cassette compartment of the DVD/VCR. If tape playback begins, press the STOP button.

3

If the VCR/TV light appears on the front of the DVD/VCR, go to step 4. If the VCR/TV light does not appear, press the VCR button, then press the VCR/TV button once.

4

Press the SPEED button until the desired tape speed appears briefly on the screen. (Details about tape speed are on page 38.)

5

Use the CHANNEL ▲/▼ buttons or the Number buttons to select the TV channel to be recorded.

6

Press the RECORD button once to start recording. The RECORD light will appear.

7

To pause the recording, press the PAUSE button once. The RECORD light will flash. To resume recording, press the RECORD button or press the PAUSE button again. The RECORD light will come on again.

8

To stop recording, press the STOP button.

1

 Turn on the TV.

2

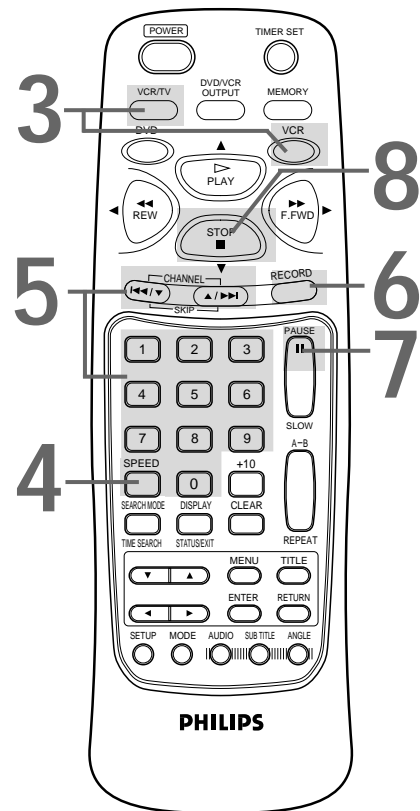
 Insert a tape in the DVD/VCR.

Helpful Hints

- If you press the RECORD button when there is not a tape in the DVD/VCR, NO CASSETTE will flash on the screen.
- If you press the RECORD button while a tape without a record tab is in the DVD/VCR, the DVD/VCR will eject the tape and PROTECTED CASSETTE CANNOT RECORD will flash on the screen.
- Other recording options are on pages 34-40.
- You can change the tape speed during a recording, but some distortion will appear on the tape.
- The DVD/VCR will record in a preset volume.

34 Recording One Channel/Watching Another

VCR

- Before you begin, place the DVD/VCR in VCR mode. Press the DVD/VCR OUTPUT button so that the green VCR light appears on the front of the DVD/VCR. Press the VCR/TV button so that the VCR/TV light appears on the front of the DVD/VCR.

1

Press the **VCR** button, then press the **RECORD** button to start a recording of the current TV channel. Details are on page 33.

2

Press the **VCR/TV** button to put the DVD/VCR in **TV position**. The VCR/TV light will disappear from the front of the DVD/VCR.

3

Use the **TV remote control** to select the channel you want to watch at the TV.

4

To return to the channel being recorded, use the **TV remote control** to select **channel 03 or 04 at the TV** (the channel to which the CH3/CH4 switch on the back of the DVD/VCR is set). Or, if you connected the DVD/VCR to the TV using audio and video cables, select the correct audio and video in channel at the TV. Details are on page 12.

5

Press the **VCR/TV** button on the **DVD/VCR remote control** to put the DVD/VCR in **VCR position**. The VCR/TV light will appear on the front of the DVD/VCR. The channel being recorded will appear on the TV screen.

6

Press the **STOP** button to stop the recording.

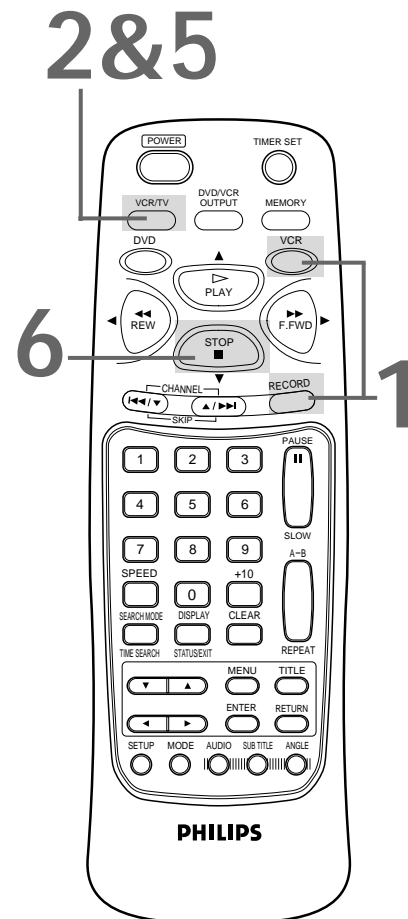

3 Select the channel you want to watch at the TV.

4 Select channel 03 or 04 at the TV.

Helpful Hint

- If you use a Cable Box or Direct Broadcast System hookup, you may not be able to watch one channel while recording another. See pages 10-11 for details.

VCR

The One-Touch Recording (OTR) feature allows you to set an immediate timed recording 30 minutes to eight hours long. Before you begin:

- Set up the TV channels at the DVD/VCR. *Details are on page 17.*
- Select a recording speed (SP, SLP) with the SPEED button.
- Put a tape in the cassette compartment of the DVD/VCR. Make sure the tape's record tab is intact and the tape is long enough to record the program(s).
- If the end of a tape is reached during an OTR, the DVD/VCR will eject the tape. The DVD/VCR will switch to DVD mode immediately, and the TIMER SET light will blink. To let the OTR continue, insert another tape in the DVD/VCR.

To return to VCR mode, press the TIMER SET button on the front of the DVD/VCR, then press the DVD/VCR OUTPUT button so that the green VCR light appears on the front of the DVD/VCR.

- Place the DVD/VCR in VCR mode. Press the DVD/VCR OUTPUT button so that the green VCR light appears on the front of the DVD/VCR.
- Place the DVD/VCR in VCR position. Press the VCR/TV button so that the VCR/TV light appears on the front of the DVD/VCR.

1

Press the **VCR** button, then press the **CHANNEL** ▲/▼ buttons or the **Number** buttons to select the channel you want to record.

2

Press the **RECORD** button repeatedly until the desired recording length (30 minutes to eight hours) appears on the screen. Recording will begin immediately. The **RECORD** light and the **TIMER SET** light will appear on the front of the DVD/VCR.

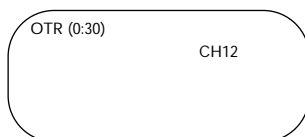

3

To stop an OTR before recording is finished, press the **STOP** button.

To cancel the OTR but continue recording, press the **RECORD** button repeatedly until **REC** appears in the upper left corner of the TV screen. (STATUS must be set to ON. See page 23 for details.) The **RECORD** light will remain on the front of the DVD/VCR, but the **TIMER SET** light will disappear.

When the OTR finishes, if no timer recordings are set, the **TIMER SET** light will blink. The DVD/VCR power will turn off automatically. When the power is turned on again, the DVD/VCR will be in DVD mode. To return to VCR mode, press the **TIMER SET** button, then press the **DVD/VCR OUTPUT** button so that the **VCR** light appears on the front of the DVD/VCR. (The **TIMER SET** light will disappear.)

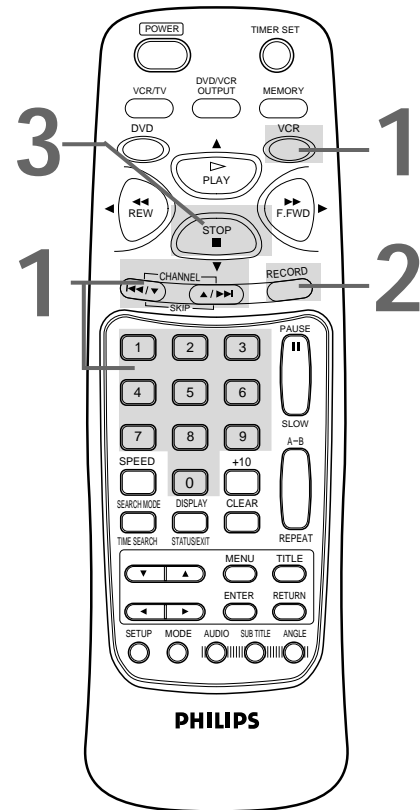

Helpful Hints

- To check the time remaining for an OTR after the OTR has been set, press the **DISPLAY/STATUS/EXIT** button.
- To change the recording length while an OTR is in progress, press the **RECORD** button until the desired length appears on the screen.
- If you begin an OTR when another recording is paused, the OTR will begin.
- You can not pause an OTR.
- If the preset time for a timer recording comes up during an OTR, the OTR has priority. A message will remind you when the timer recording was scheduled to begin. You may let the OTR continue; the timer recording will not take place. Or, stop the OTR and press the **TIMER SET** button immediately. The timer recording will take place if you press the **TIMER SET** button before the timer recording's scheduled start time.

36 Timer Recording

VCR

Follow the steps below to program your DVD/VCR to record TV programs while you're away from home. The DVD/VCR will turn itself on, record, and turn itself off automatically. Before you begin:

- Set up the TV channels at the DVD/VCR. *Details are on page 17.*
- Set the clock. If the clock is not set, **CLOCK MUST BE SET** will appear on the TV screen briefly, followed by the VCR menu. Follow the directions on page 20 to set the VCR's clock.
- Put a tape in the cassette compartment of the DVD/VCR. Make sure the tape's record tab is intact and the tape is long enough to record the program(s).
- Press the DVD/VCR OUTPUT button so that the VCR light appears on the front of the DVD/VCR.
- Press the VCR/TV button so that the VCR/TV light appears on the front of the DVD/VCR.

Do each step within 60 seconds of the previous step.

1

Press the **VCR** button, then press the **MENU** button.

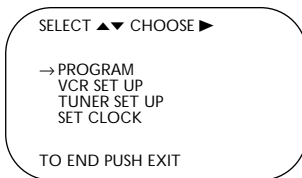

2

Press the **PLAY** button or the **STOP** button to select **PROGRAM**, then press the **F.FWD** button.

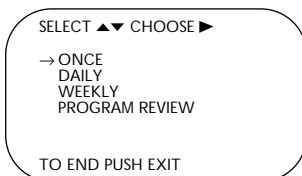

3

Press the **PLAY** button or the **STOP** button to select a **ONCE**, **DAILY**, or **WEEKLY** recording. Then, press the **F.FWD** button.

- **ONCE:** The DVD/VCR will record a TV program on any day you choose, up to 12 months away.
- **DAILY:** The DVD/VCR will record the same channel every day from Monday to Friday – starting at the same time and recording for the same length of time.
- **WEEKLY:** The DVD/VCR will record the same channel on the same day, at the same time, and for the same length of time every week.

**Daily
Recording
(example)**

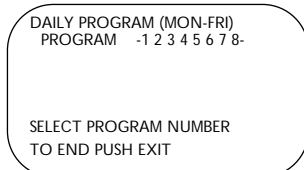

2-3

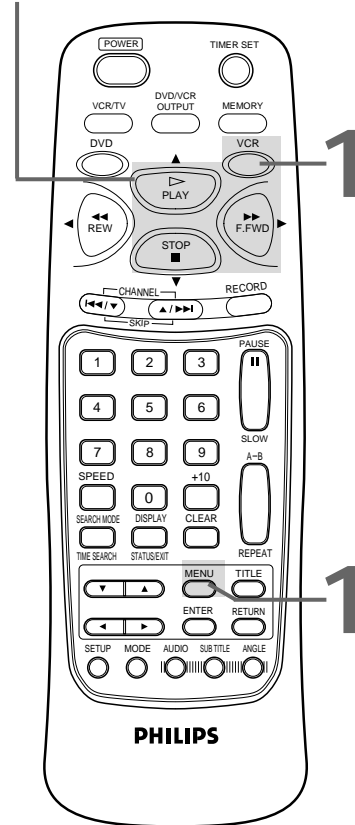

Helpful Hint

- If you need to make a correction while programming a timer recording, press the **CLEAR** button until the cursor is flashing on the item you want to change. Then enter the correct information.

4

Use the **Number buttons (1-8)** to select a slot in which to store the timer recording. There are eight slots. Numbers for open slots will flash on the screen.

NOTE: If you enter a number for a slot that has already been used to store a timer recording, **PREVIOUSLY SET PROGRAM** will appear on the screen briefly. Information about the program in that slot will appear on the screen. If this happens, press the **DISPLAY/STATUS/EXIT** button, then select another number.

5

Use the **Number buttons** to enter the TV channel you want to record.

- Cable Users, enter channel numbers as a two-digit number for the quickest results. For example, to select channel 6, press 0,6. If you only press the Number 6 button, channel 6 will be selected after a brief delay. There also may be a brief delay when you select channels 10, 11, and 12. If you want to select channels 100 and above, enter channel numbers as a three-digit number. For example, to select channel 117, press 1, 1, 7.
- Antenna Users, enter channel numbers as a two-digit number for the quickest results. For example, to select channel 5, press 0,5. If you only press the Number 5 button, channel 5 will be selected after a brief delay. You may only select channels 2-69.
- If you are recording from line input, press 0,0 to select AV REAR.
- If you are using a Cable Box/DBS, select the Cable Box/DBS output channel (03 or 04). Set the Cable Box/DBS to the channel you want to record. Leave the Cable Box/DBS on for the timer recording. *Details are on page 10.*

6

Press two **Number buttons** for the hour you want the recording to begin. Press two **Number buttons** for the minute you want the recording to begin. Press **1** for **AM** or **2** for **PM**. For example, for 9:30 PM, press 09, 30, 2.

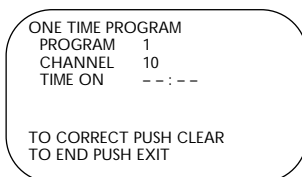

7

Follow the instructions in step 6 to enter the recording's **stop time**. (AM or PM will be set automatically.)

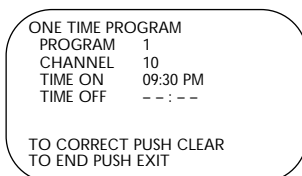

Instructions continue on page 38.

4-7

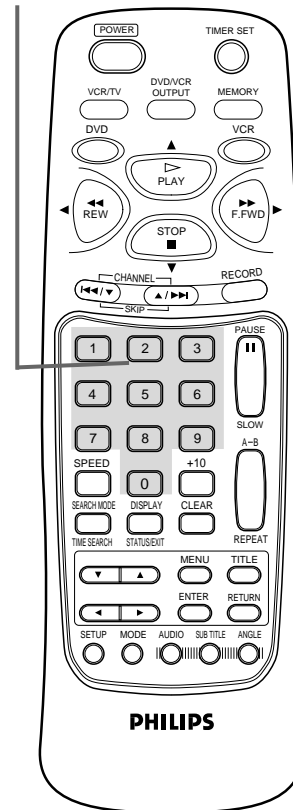

Helpful Hints

- Entries that do not match the DVD/VCR's clock or calendar will cause a question mark to appear on the screen.
- If you are recording from line input, connect the audio and video cables to the **AUDIO IN** and **VIDEO IN** jacks on the back of the DVD/VCR. (Please see illustration on page 40.)

38 Timer Recording (cont'd)

8

Press the **Number 1** button to record in **SP** speed or the **Number 2** button to record in **SLP** speed. (See the chart below.) You cannot use the **SPEED** button at this time.

ONE TIME PROGRAM	
PROGRAM	1
CHANNEL	10
TIME ON	09:30 PM
TIME OFF	11:00 PM
REC SPEED	SLP
SP=1	SLP=2
TO CORRECT PUSH CLEAR	
TO END PUSH EXIT	

9

Press two **Number** buttons for the month and two **Number** buttons for the day you want to record the program. For example, for July 10, 2000, press 07, 10. The day of the week and the year will appear automatically (you cannot program the DVD/VCR to record more than one year in advance).

ONE TIME PROGRAM	
PROGRAM	1
CHANNEL	10
TIME ON	09:30 PM
TIME OFF	11:00 PM
REC SPEED	SLP
START DATE	07/10/00
	MON.
TO CORRECT PUSH CLEAR	
TO END PUSH EXIT	

10

Press the **DISPLAY/STATUS/EXIT** button. PROGRAM WAS COMPLETED/PLEASE PUSH TIMER-SET FOR TIMER RECORDING will appear on the screen briefly. (If PROGRAM NOT COMPLETED appears, try again from step 1.)

11

Press the **TIMER SET** button. The **TIMER SET** light will appear on the front of the DVD/VCR. The DVD/VCR will be in standby mode. If you turn on the DVD/VCR power, the DVD/VCR is in DVD mode. You can use the DVD features.

If the timer recording will take place several hours or days from now, you may use the DVD/VCR until time for the recording. Press the **TIMER SET** button to place the DVD/VCR in standby mode a few minutes before the recording starts.

If you forget to place the DVD/VCR in standby mode, PLEASE PUSH TIMER-SET FOR TIMER RECORDING flashes on your TV screen two minutes before a timer recording starts. Press the **CLEAR** button to remove the message. Then press the **TIMER SET** button.

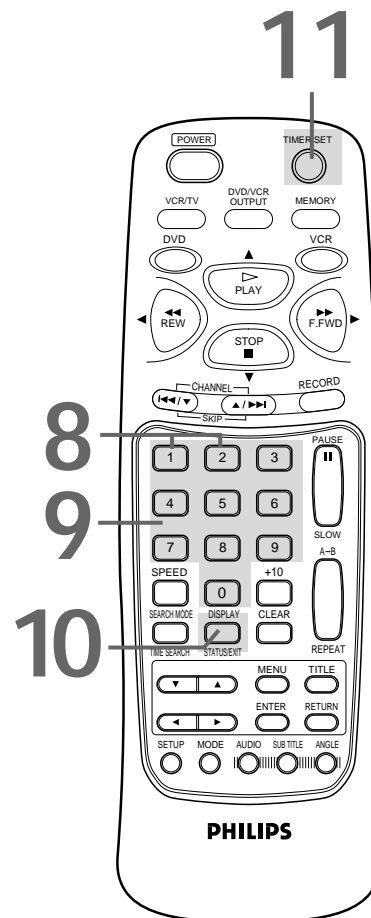

Press the **TIMER SET button to place the DVD/VCR in standby mode. Insert a tape in the DVD/VCR. Leave the Cable Box/DBS on (if applicable).**

Tape Speeds This chart shows the recording/playback time for three types of video cassettes (T160, T120, and T60). There are three playback speeds: SP, LP, and SLP. When recording, you can change the tape speed (SP or SLP) using the SPEED button. You cannot record in LP speed.	Cassette type/Playback Time		
	Tape Speed	T160	T120
SP (standard play)	2 hrs. 40 mins.	2 hrs.	1 hr.
LP (long play) (playback only)	5 hrs. 20 mins.	4 hrs.	2 hrs.
SLP (super long play)	8 hrs.	6 hrs.	3 hrs.

Checking or Cancelling Timer Recordings

- Before you begin, place the DVD/VCR in VCR mode.
Press the DVD/VCR OUTPUT button so that the VCR light appears on the front of the DVD/VCR.

1

With the DVD/VCR on and in VCR mode and in VCR position (press the VCR/TV button so that the VCR/TV light appears on the front of the DVD/VCR), **press the VCR button, then press the MENU button.**

2

Press the **PLAY** button or the **STOP** button to select **PROGRAM**, then press the **F.FWD** button.

3

Press the **PLAY** button or the **STOP** button to select **PROGRAM REVIEW**, then press the **F.FWD** button. The timer recording information for the program in the lowest numbered slot will appear on the screen. If no timer recordings are set, nothing will happen when you press the **F.FWD** button.

4

Press the **F.FWD** button repeatedly to review all programmed timer recordings. If you don't press the **F.FWD** button within 10 seconds, the DVD/VCR will automatically display information about the next programmed timer recording. This will continue until all timer recordings have been displayed. Then the menu will disappear.

5

To cancel the timer recording displayed, press the **CLEAR** button. Either the display will disappear or information about other timer recordings will appear. If you do not press any other buttons, the display will disappear after all timer recordings have been displayed.

6

Repeat steps 1-4 to make sure you have cleared the correct timer recording.

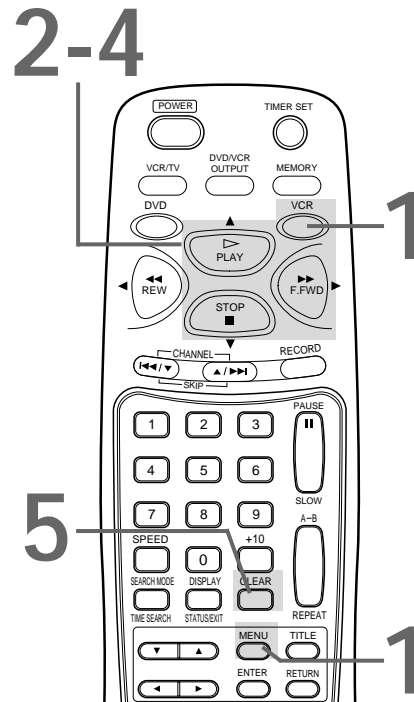

Helpful Hints

- *CLASH* may flash on the screen when you finish setting a timer recording. This means that the timer recording you just programmed and another timer recording overlap. The current timer recording will not take place. You may choose to cancel the overlapping timer recording.
- To stop a started timer recording, press the **STOP/EJECT** button or the **TIMER SET** button on the front of the DVD/VCR.
- If the power fails for more than one minute, programmed timer recordings will be lost. If this occurs, repeat the steps on pages 16 and 20 before resetting the timer recordings.
- If the preset time for a timer recording comes up during an OTR, the OTR has priority. A message will remind you when the timer recording was scheduled to begin. You may let the OTR continue; the timer recording will not take place. Or, stop the OTR and press the **TIMER SET** button immediately. The timer recording will take place if you press the **TIMER SET** button before the timer recording's scheduled start time.

See page 78 for more hints.

40 Rerecording (Tape Duplication)

VCR

The instructions on this page show you how to copy tapes. The illustration uses two DVD/VCRs. Different VCRs may operate differently. To duplicate a tape, make the connections shown, then follow steps 1-7.

1. Audio cables from DVD/VCR AUDIO OUT Jacks of DVD/VCR 1 to AUDIO IN Jacks of DVD/VCR 2

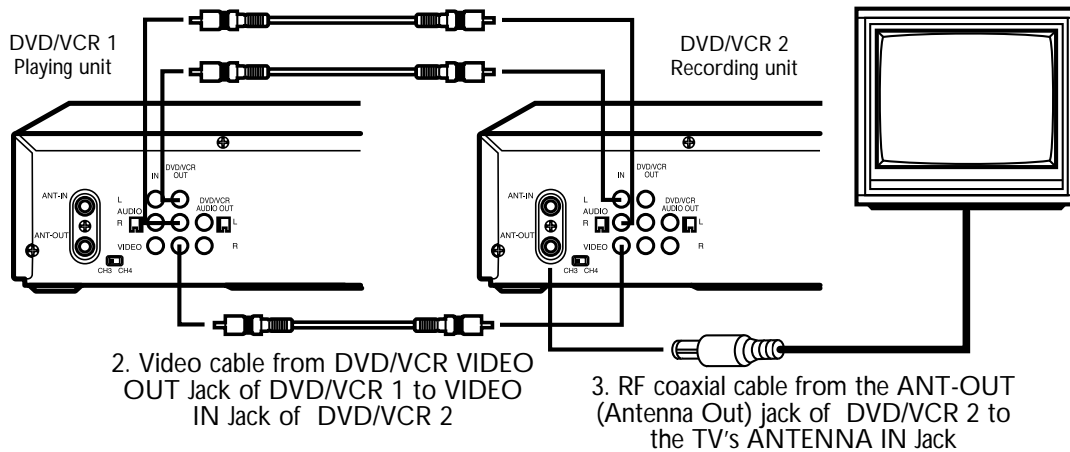

2. Video cable from DVD/VCR VIDEO OUT Jack of DVD/VCR 1 to VIDEO IN Jack of DVD/VCR 2

3. RF coaxial cable from the ANT-OUT (Antenna Out) jack of DVD/VCR 2 to the TV's ANTENNA IN Jack

1

Make the connections shown above.

2

DVD/VCR 1 will play your tape. Put a prerecorded tape into the cassette compartment of DVD/VCR 1.

3

DVD/VCR 2 will record your tape. Insert a blank tape in the cassette compartment of DVD/VCR 2. The DVD/VCR must be in VCR mode and VCR position. (The VCR light and the VCR mode and VCR/TV light will appear on the front of the DVD/VCR.)

4

Turn on the TV and set it to channel 03 or 04, whichever channel the CH3/CH4 switch on DVD/VCR 2 is set to.

5

Point the remote control at DVD/VCR 2. Press the VCR button, then press the Number buttons 0, 0, 1 or 0, 0, 2. (See Helpful Hints at right.)

6

Press the SPEED button to select SP or SLP at DVD/VCR 2.

7

Press the VCR PLAY button on DVD/VCR 1 and the RECORD button on DVD/VCR 2 at the same time. To stop recording, press the STOP/EJECT button on DVD/VCR 1, then press the STOP/EJECT button on DVD/VCR 2.

Helpful Hints

- If you use the AUDIO and VIDEO IN Jacks on the back of DVD/VCR 2, press Number buttons 0, 0, 1 at step 5. AV REAR will appear on the TV screen.
- If you use the AUDIO and VIDEO In Jacks on the front of DVD/VCR 2, press Number buttons 0, 0, 2 at step 5. AV FRONT will appear on the TV screen.
- Unauthorized recording of copyrighted television programs, video tapes, or other materials may infringe on the rights of copyright owners and violate copyright laws.
- If a program has copyright protection, it may not record clearly.
- These instructions show you how to copy tapes using two DVD/VCRs like yours. Different VCRs may operate differently.
- You cannot record DVD material onto a video cassette tape using a single unit.

Repeat Play (Video Cassette Tapes) 41

VCR

- Before you begin, place the DVD/VCR in VCR mode.
Press the DVD/VCR OUTPUT button so that the green VCR light appears on the front of the DVD/VCR.

1

Press the VCR button, then press the MENU button.

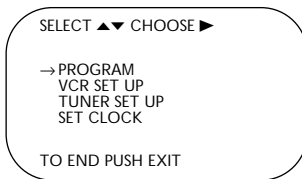

2

Press the PLAY button or the STOP button to select VCR SET UP, then press the F.FWD button.

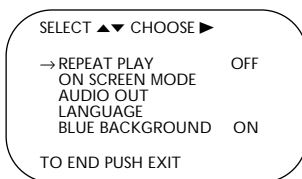

3

Press the PLAY button or the STOP button to select REPEAT PLAY.

4

Press the F.FWD button so that ON appears beside REPEAT PLAY.

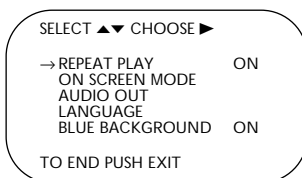

5

Press the DISPLAY/STATUS/EXIT button. Now, when a tape has finished playing, the DVD/VCR will rewind it and start playback again.

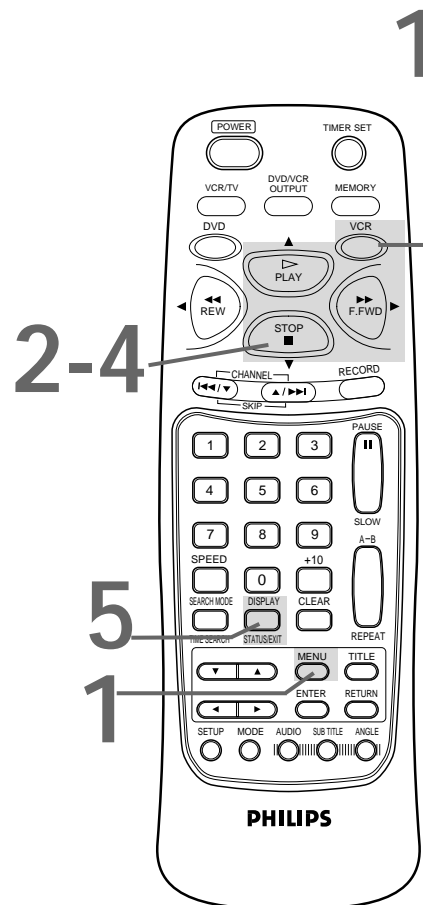

Helpful Hints

- To cancel Repeat Play, follow steps 1-3 above. At step 4, press the F.FWD button so that OFF appears beside REPEAT PLAY. Press the DISPLAY/STATUS/EXIT button.
- The real-time counter memory does not function during Repeat Play.

42 Real-Time Counter Memory

VCR

Follow the steps below to reset the real-time counter to zero at a tape location you want to refer to later.

- Before you begin, place the DVD/VCR in VCR mode.
Press the DVD/VCR OUTPUT button so that the green VCR light appears on the front of the DVD/VCR.

1

Press the VCR button, then play, fast forward, or rewind a tape to the location that you would like to refer to later. Press the STOP button to stop the tape.

2

Press the DISPLAY/STATUS/EXIT button to see the status display.

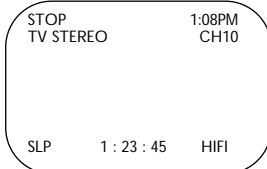

3

While the status display is on the screen, press the CLEAR button to reset the real-time counter to zero.

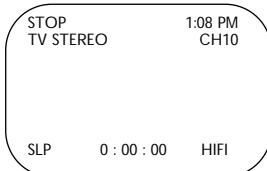

4

While the real-time counter is on the screen, press the MEMORY button so that M appears beside the counter.

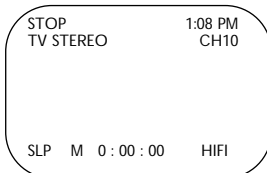

5

To go to a tape location where the real-time counter was reset to zero, press the REW(ind) button or the F.FWD button when playback is stopped.

When the tape reaches the point at which the counter was set to zero, the tape will stop.

Press the PLAY button to watch the tape.

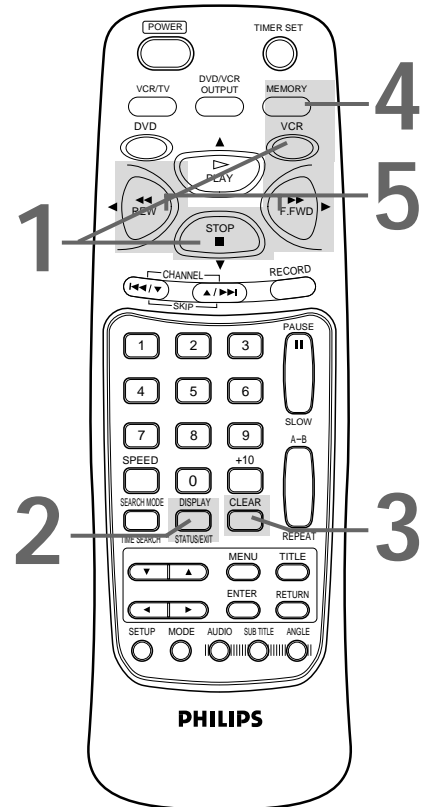

Helpful Hints

- The MEMORY button does not function if REPEAT PLAY is set to ON. Details are on page 41.
- To erase a real-time counter memory, press the MEMORY button until the M disappears from the screen.
- You may only set the real-time counter to zero at one location at a time. If you set the real-time counter to zero at a second location, the previous real-time counter to zero setting will be erased.

VCR

Follow the steps below to program the DVD/VCR to search forward or backward on a tape a specific length of time. There must be a tape in the DVD/VCR.

- Before you begin, place the DVD/VCR in VCR mode. Press the DVD/VCR OUTPUT button so that the green VCR light appears on the front of the DVD/VCR. Press the VCR/TV button so that the VCR/TV light appears on the front of the DVD/VCR.

1

Press the VCR button, then press the SEARCH MODE/TIME SEARCH button.

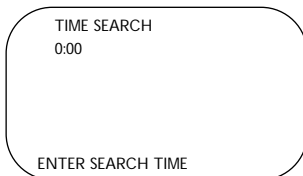

2

Within 10 seconds, use the Number buttons to enter the desired length of time you want to skip forward or backward. For example, for 1 hour, 25 minutes, press Number buttons 1, 2, 5. Or, for five minutes, press Number buttons 0, 0, 5.

3

Within 10 seconds, press the F.FWD button or the REW(ind) button. The DVD/VCR will skip over the specified length of time, then begin playback.

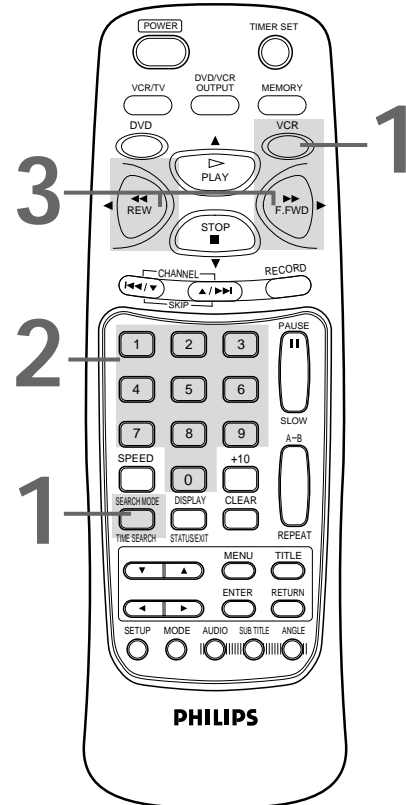

Helpful Hints

- If you want to search for more than 59 minutes, you must enter the length of time in hours and minutes. For example, to search forward 70 minutes, press 1,1,0 at step 2.
- You can not do a Time Search while recording.
- To remove the Time Search display, press the SEARCH MODE/TIME SEARCH button again.
- To cancel a Time Search that is in progress, press the STOP button.
- If the end of the tape is reached during a Time Search, the Time Search will be cancelled. The DVD/VCR may rewind the tape. Details are on page 45.

44 Special Effects Playback

VCR

Before trying the features on this page, make sure the DVD/VCR is in VCR mode.

- Before you begin, place the DVD/VCR in VCR mode. Press the DVD/VCR OUTPUT button so that the green VCR light appears on the front of the DVD/VCR. Press the VCR/TV button so that the VCR/TV light appears on the front of the DVD/VCR.

Forward and Reverse Searching (SP/LP/SLP)

1

During tape playback, press and release the F.FWD button or the REW(ind) button. A fast forward or reverse picture search will begin.

2

To return to playback, press the PLAY button.

Super High Speed Searching (LP/SLP)

1

During tape playback, press the F.FWD button or the REW(ind) button, then press again. The DVD/VCR will now search in super high speed.

2

To return to normal playback, press the PLAY button.

Viewing a Still Picture

1

During tape playback, press the PAUSE button. A still picture will appear on the screen.

2

To release the still picture and return to playback, press the PLAY button or press the PAUSE button again.

Viewing a Slow Motion Picture

1

During tape playback, press the SLOW button. The tape will play in slow motion.

2

To release Slow mode and return to normal playback, press the PLAY button or press the SLOW button again.

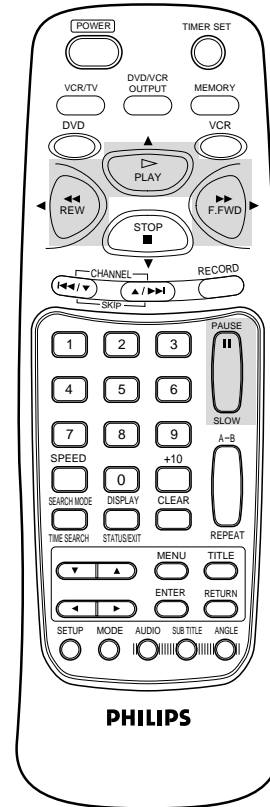

Helpful Hints

- Slow and Still modes will automatically switch to Stop mode after five minutes to protect the DVD/VCR and the tape from damage.
- SP/LP/SLP means this feature will work with tapes recorded in Standard Play, Long Play, or Super Long Play.
- LP/SLP means this feature will work with tapes recorded in Long Play or Super Long Play. For details about tape speed, see pages 38 and 82.

VCR

The following tape playback features are available in VCR mode.

Automatic Playback

When you put a tape in the DVD/VCR, the power will come on automatically. If the tape's record tab is missing, playback will begin. If a timer recording is set, and the TIMER SET light is flashing, the power will not come on automatically when you insert a tape with the record tab intact.

If a timer recording is set and the TIMER SET light is flashing, the DVD/VCR will eject the tape if the record tab is missing.

Automatic Rewind, Eject

When a tape is played, fast forwarded, or recorded to its end, the DVD/VCR will rewind the tape, stop, then eject the tape.

If the real-time counter memory is set, the DVD/VCR will only rewind the tape to the point at which the counter is set to zero, then stop. The DVD/VCR will not eject the tape automatically. If REPEAT PLAY is set to ON, the DVD/VCR will not eject the tape automatically.

Tape Eject

A tape can be ejected with the DVD/VCR power on or off (but the DVD/VCR must be plugged in).

If a timer recording is set, and the TIMER SET light is on or flashing, the tape cannot be ejected. To eject the tape, you must first press the TIMER SET button to cancel the timer recording, then press the STOP/EJECT button to remove the tape. To reset the timer recording, insert a tape, then press the TIMER SET button to put the DVD/VCR in standby mode for the timer recording.

Automatic Tracking Adjustment

The DVD/VCR adjusts tracking automatically to give you the best possible picture quality. With some recordings, however, you may get a better picture using the manual tracking controls (see below).

Manual Tracking

To manually adjust the tracking during normal playback and slow motion playback, press the CHANNEL ▲/▼ buttons **on the DVD/VCR**. (The CHANNEL ▲/▼ buttons on the remote control will not adjust tracking.)

Tracking will return to Automatic Tracking Adjustment when you press the STOP button or insert a tape.

You cannot manually adjust the tracking of a Still picture. However, you may press the CHANNEL ▲/▼ buttons on the front of the DVD/VCR to remove vertical jitter in a Still picture.

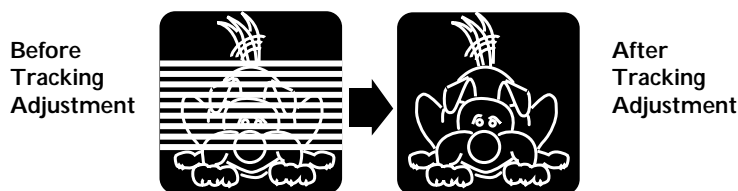

46 MTS (Multi-Channel Television Sound) System

VCR

Your DVD/VCR can play recordings broadcast in Hi-Fi (high fidelity) stereo, which produces a crisp, clear sound from two sources. Your DVD/VCR also can play tapes recorded in a second audio (usually, that means your program is recorded in a second language). Of course, your DVD/VCR will play tapes recorded in monaural (single-source) sound as well.

Your DVD/VCR also will record in Hi-Fi stereo or in second audio, so when you play back that tape on the DVD/VCR, it will be in stereo or second audio.

Read the directions on this page to familiarize yourself with your DVD/VCR's stereo and second audio setups. Then follow the directions on page 47 to record in stereo or second audio and the directions on page 48 to play back tapes recorded in Hi-Fi stereo.

Understanding On-Screen Displays

When you receive a signal from a channel you're watching, portions of the on-screen display shown below will appear when you press the DISPLAY/STATUS/EXIT button on the remote control.



Specifically...

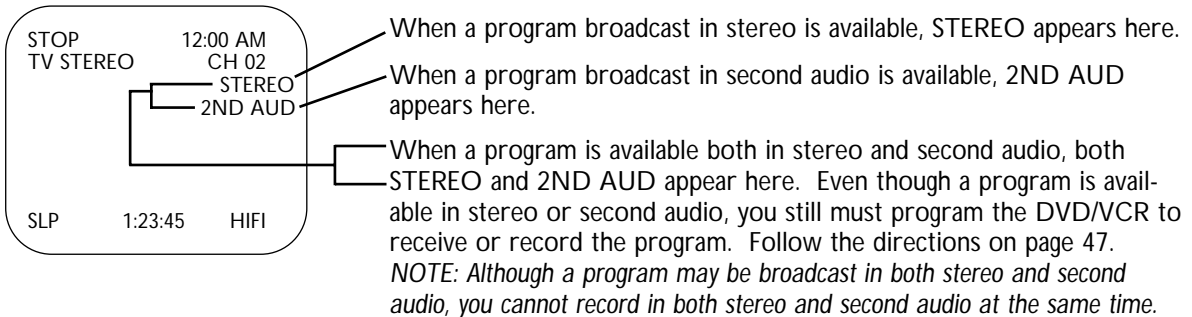

To record and play back programs broadcast in stereo, even if you have a single-speaker TV, just use one of the connections shown, then follow the steps on pages 47-48.

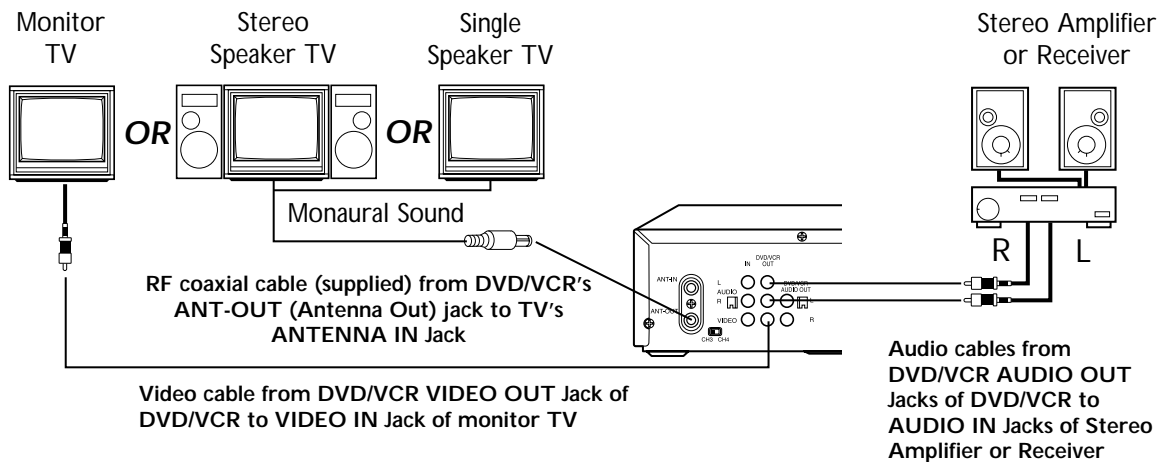

MTS (Multi-Channel Television Sound) System (cont'd) 47

VCR

- Before you begin, place the DVD/VCR in VCR mode. Press the DVD/VCR OUTPUT button so that the green VCR light appears on the front of the DVD/VCR. Press the VCR/TV button so that the VCR/TV light appears on the front of the DVD/VCR.

1

Press the VCR button, then press the MENU button.

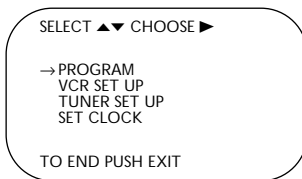

2

Press the PLAY button or the STOP button to select TUNER SET UP, then press the F.FWD button.

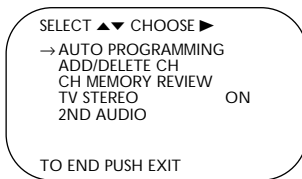

3

Press the PLAY button or the STOP button to select TV STEREO or 2ND AUDIO. Then, press the F.FWD button. ON will appear to the right of your selection.

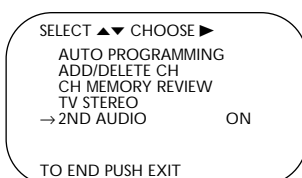

4

Press the DISPLAY/STATUS/EXIT button.

5

To record, select the channel to be recorded using the CHANNEL ▲/▼ buttons, then go to step 6.

6

Press the RECORD button to start recording.

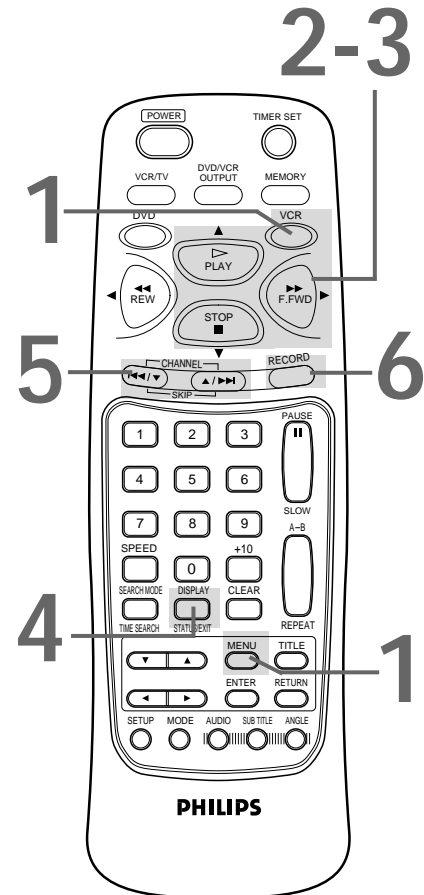

Helpful Hints

- You can only receive and record in stereo or second audio programs that are broadcast in stereo or second audio. You can only play in stereo or second audio tapes that were recorded in stereo or second audio. Please see page 46 to determine if the program you want to watch/record is being broadcast in stereo or second audio.
- If you select second audio when second audio is not available, the DVD/VCR will record normal audio.

48 Hi-Fi Stereo Sound System

VCR

Multi-Channel Television Sound system broadcasts are automatically recorded in Hi-Fi stereo sound. To play in Hi-Fi stereo the tapes recorded in Hi-Fi stereo, however, you'll need to follow steps 1-5.

- Before you begin, place the DVD/VCR in VCR mode. Press the DVD/VCR OUTPUT button so that the green VCR light appears on the front of the DVD/VCR. Press the VCR/TV button so that the VCR/TV light appears on the front of the DVD/VCR.

1

Press the **VCR** button, then press the **MENU** button.

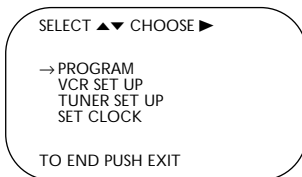

2

Press the **PLAY** button or the **STOP** button to select **VCR SET UP**, then press the **F.FWD** button.

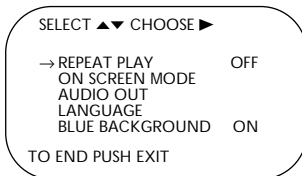

3

Press the **PLAY** button or the **STOP** button to select **AUDIO OUT**, then press the **F.FWD** button.

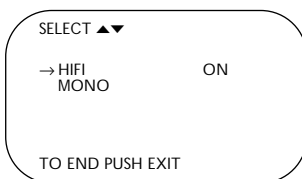

4

Press the **PLAY** button or the **STOP** button to select **HIFI**. ON will appear to the right of HIFI on the screen.

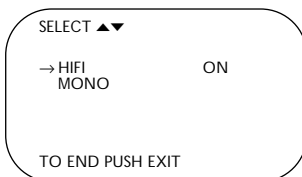

5

Press the **DISPLAY/STATUS/EXIT** button.

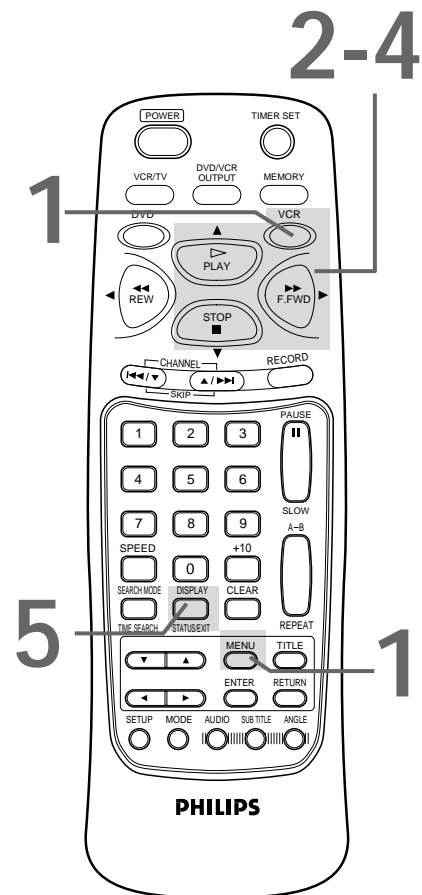

Helpful Hints

- Normally, HIFI should be selected from the **AUDIO OUT** menu for playback with Hi-Fi sound. But, you can change the selection to **MONO** if you want monaural audio playback. To do this, follow steps 1-3. At step 4, press the **PLAY** button or the **STOP** button to select **MONO**. Press the **DISPLAY/STATUS/EXIT** button. HIFI will disappear from the status display.
- All programs are automatically recorded in both Hi-Fi stereo sound and in monaural sound.
- The audio level of a tape recorded in Hi-Fi stereo will differ from the audio level of a tape not recorded in Hi-Fi stereo.
- If you play non-Hi-Fi tapes while the DVD/VCR is set to HIFI, HIFI will disappear from the status display and the tape will play in monaural sound.

Please see additional notes on page 79.

VCR

If you want the TV screen to be solid blue when a weak signal is received, set BLUE BACKGROUND to ON. The screen will be blue and the sound will be muted.

Or, if you want to receive the weak signal, set BLUE BACKGROUND to OFF. When you select a channel that is receiving a weak signal, you will see and hear the static in the TV programming. The channel number will not appear on the screen when you select a weak channel.

To set BLUE BACKGROUND to ON or OFF, follow these steps.

- Before you begin, place the DVD/VCR in VCR mode. Press the DVD/VCR OUTPUT button so that the green VCR light appears on the front of the DVD/VCR. Press the VCR/TV button so that the VCR/TV light appears on the front of the DVD/VCR.

1

Press the VCR button, then press the MENU button.

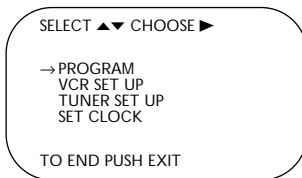

2

Press the PLAY button or the STOP button to select VCR SET UP, then press the F.FWD button.

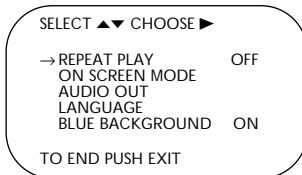

3

Press the PLAY button or the STOP button to select BLUE BACKGROUND. Then, press the F.FWD button repeatedly so that OFF (or ON) appears beside BLUE BACKGROUND.

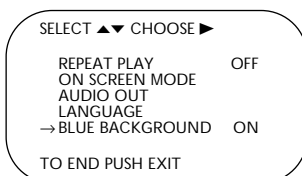

4

Press the DISPLAY/STATUS/EXIT button.

2-3

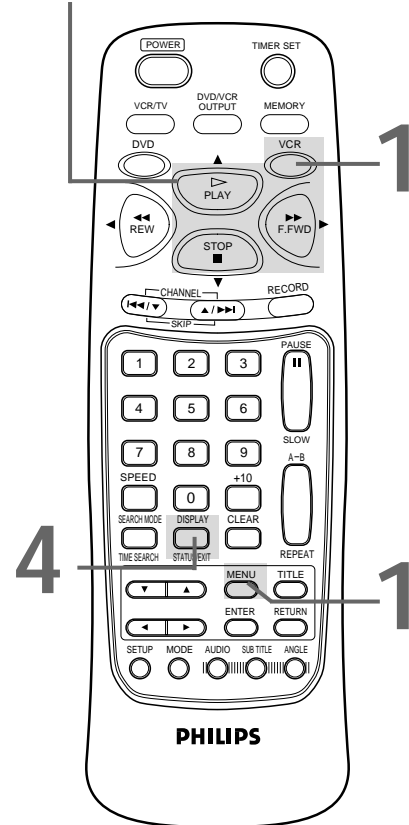

50 Playing a Disc

DVD AUDIO CD

Playing a DVD or an Audio CD

Before you begin...

Turn on the power of the TV, amplifier and any other equipment connected to the DVD/VCR. Make sure the TV and the stereo or amplifier (if applicable) are set to the correct channel. *Details are on pages 8-14.*

1

Press the **POWER** button to turn on the DVD/VCR. "HELLO" will appear briefly on the display panel.

2

Press the **DVD/VCR OUTPUT** button so that the red DVD light appears on the front of the DVD/VCR. Then, press the **DVD** button.

3

Press the **OPEN/CLOSE** button on the front of the DVD/VCR to open the Disc tray.

4

Place a Disc into the tray. Make sure the Disc is sitting properly in the correct recess. Some DVDs are recorded on both sides. Make sure the side you want to play is facing up. Or, if the DVD is recorded on only one side, place the Disc in the tray with the label facing up.

5

Press the **PLAY** button. The tray will close automatically, and playback will begin at the first Chapter or Track of the Disc. Or, you may press the **OPEN/CLOSE** button to close the tray, and DVD playback will start automatically. (You also may close the tray by gently pressing the Disc tray toward the DVD/VCR.) If the DVD in the tray has a menu, the menu may appear on the screen instead. *Details are on page 51.* With some Audio CDs, playback will not begin unless you press the **PLAY** button.

6

Press the **STOP** button to stop playback. If disc playback is stopped for more than one minute, a screen saver will appear. *Details are on page 77.*

Remember, this DVD/VCR will play only certain Discs. See page six for details.

3 Press the **OPEN/CLOSE** button on the DVD/VCR.

4 Insert a Disc.

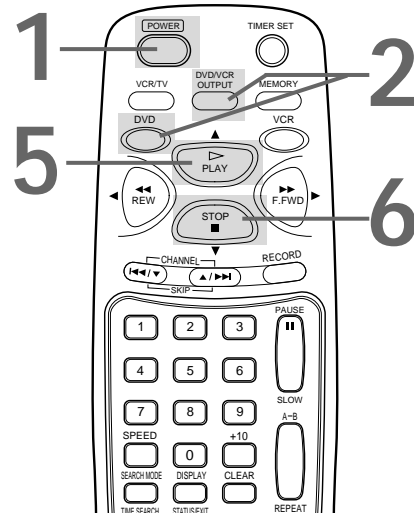

Helpful Hints

- A "No Feature" symbol  may appear at the bottom right of the TV screen. This symbol means either the feature you tried is not available on the Disc, or the DVD/VCR can not access the feature at this time. This does not indicate a problem with the DVD/VCR.
- If a Disc is dirty or has scratches, the pictures may appear distorted and playback may stop. In such cases, remove the Disc and turn off the DVD/VCR. Disconnect the power cord, then reconnect it. Clean the Disc, then turn on the DVD/VCR again and reinsert the Disc for playback.
- When the DVD or CD light appears on the display panel, the Disc is loaded completely and is ready for playback.
- When you press the **OPEN/CLOSE** button or the **DVD PLAY** button on the front of the DVD/VCR when the power is off, the DVD/VCR will turn on automatically and will be in DVD mode.

Disc Menu 51

DVD

Using the DVD Menus

Some DVDs contain menus that describe the contents of the Disc or allow you to customize Disc playback. For example, the menu may offer choices for subtitle languages, director's commentary, or soundtrack playback.

To use the DVD menu and select playback features, follow these steps.

- Before you begin, place the DVD/VCR in DVD mode. Press the DVD/VCR OUTPUT button so that the red DVD light appears on the front of the DVD/VCR.

1

Press the DVD button, then press the MENU button. The DVD's main menu will appear.

2

Press the arrow buttons (▲/▼/◀/▶) to select an item, then press the ENTER button. Continue this process to set up all the features you wish to see on the Disc.

Using the Title Menu

Some DVDs have a Title Menu, which lists the Titles available on the Disc. Use the Title Menu to start playback at a specific Title. Some DVDs may allow you to choose Chapters from the Title menu.

For example, if a DVD has 10 Titles and you want to go directly to Title 5, follow these steps.

- Before you begin, place the DVD/VCR in DVD mode. Press the DVD/VCR OUTPUT button so that the red DVD light appears on the front of the DVD/VCR.

1

Press the DVD button, then press the TITLE button. The Title Menu will appear.

If a Title menu is not available, the  symbol may appear on the TV screen.

NOTE: If the DVD only has a main menu, the main menu may appear when you press the TITLE button.

2

Press the arrow buttons (▲/▼/◀/▶) to select the desired Title, then press the ENTER button. Playback will begin at the Title you selected.

To access the DVD's Main Menu...

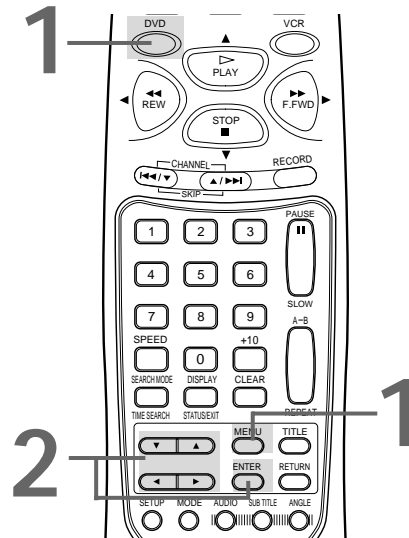

To access the DVD's Title Menu...

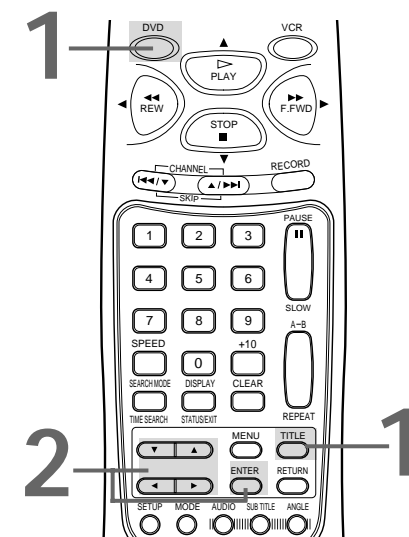

Helpful Hints

- Menus may vary among Discs. Refer to the information accompanying the Disc for details.
- Not all DVDs have Title menus.
- Some DVDs may refer to Chapters as "scenes." Some DVDs may refer to the Title Menu as the "scene index."

52 Pausing Playback

DVD AUDIO CD

Pausing Playback

- Before you begin, place the DVD/VCR in DVD mode.
Press the DVD/VCR OUTPUT button so that the red DVD light appears on the front of the DVD/VCR.

1

During disc playback, press the DVD button, then press the PAUSE button on the remote control. Playback will pause and the sound will be muted.

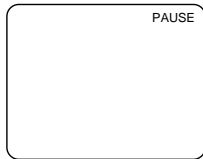

2

Press the PLAY button to resume playback.

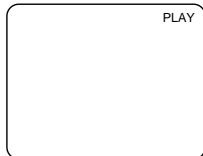

DVD

Memory On: Resuming playback from the point where playback stopped

- Before you begin, place the DVD/VCR in DVD mode.
Press the DVD/VCR OUTPUT button so that the red DVD light appears on the front of the DVD/VCR.

1

Press the DVD button, then press the STOP button during disc playback. Playback will stop, and STOP will appear at the top right corner of the TV screen. In a few seconds, MEMO ON (Memory On) will appear in the top left corner of the TV screen.

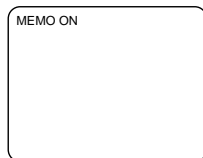

2

Press the PLAY button. Playback will resume from the point where playback stopped last.

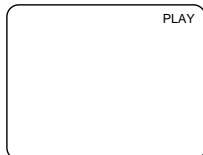

Pausing Playback...

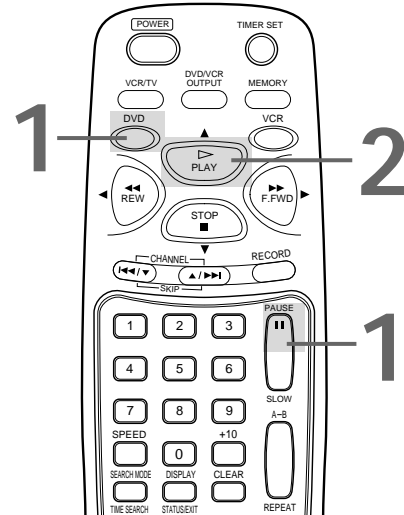

Memory On...

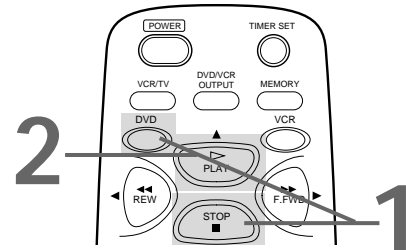

Helpful Hints

- Memory On can be erased by pressing the STOP button a second time while playback is stopped. MEMO OFF will appear briefly at the top left corner of the TV screen.
- Memory On is not available with Audio CDs.
- The DVD/VCR will switch to VCR mode automatically if disc playback is paused or stopped for 30 minutes. This helps avoid the possible burning of a still image into the TV picture tube. Details are on page 77.
- To see the on-screen display messages, such as PLAY, STOP, or PAUSE, set OSD MESSAGE to ON. Details are on page 74.

Step by Step Playback 53

DVD

- Before you begin, place the DVD/VCR in DVD mode.
Press the DVD/VCR OUTPUT button so that the red DVD light appears on the front of the DVD/VCR.

1

Press the **DVD** button, then press the **PAUSE** button to pause playback. The sound will be muted.

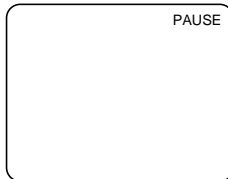

2

Press the **PAUSE** button repeatedly to see the picture advance one frame (or step) at a time.

The sound will remain muted. PAUSE will appear briefly on the screen each time you press the PAUSE button. (OSD MESSAGE must be set to ON. Details are on page 74.)

3

Press the **PLAY** button to resume playback.

PLAY will appear briefly on the screen. (OSD MESSAGE must be set to ON. Details are on page 74.)

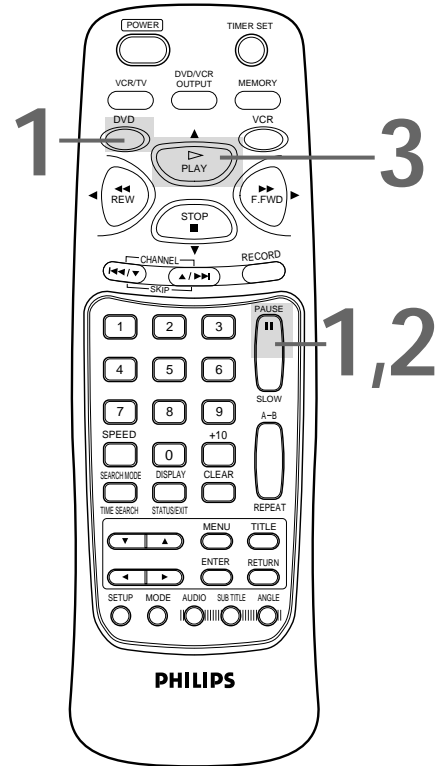
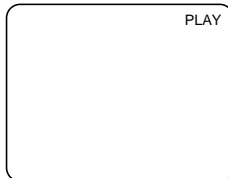

Slow Motion

DVD

- Before you begin, place the DVD/VCR in DVD mode.
Press the DVD/VCR OUTPUT button so that the red DVD light appears on the front of the DVD/VCR.

1

Press the **DVD** button, then press the **PAUSE** button during playback.

2

Press the **F.FWD** button. Slow motion playback will begin. Press the F.FWD button repeatedly during slow motion playback to vary the speed of slow motion playback. You may play the DVD at 1/16, 1/8, or 1/2 the normal playback speed.

3

Press the **PLAY** button to return to normal playback.

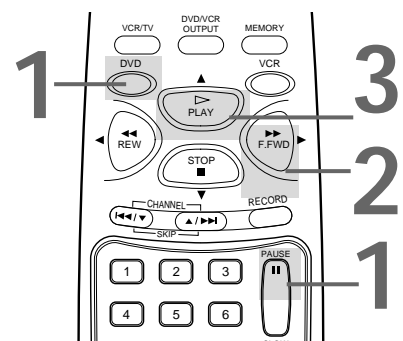

Helpful Hints

- The sound will be muted when playback is paused and during slow motion playback.
- You can not play the DVD in reverse slow motion.

54 Fast Forward/Reverse Search

DVD AUDIO CD

- Before you begin, place the DVD/VCR in DVD mode. Press the DVD/VCR OUTPUT button so that the red DVD light appears on the front of the DVD/VCR.

1

During playback, press the DVD button, then press the F.FWD button or the REW button on the remote control.

- On a DVD, pressing the F.FWD or REW button repeatedly will forward or reverse the picture at twice, eight times, or 32 times the normal playback speed. Sound will be muted during searching.
- Use the F.FWD button for a forward search. Press the REW button for a reverse search.

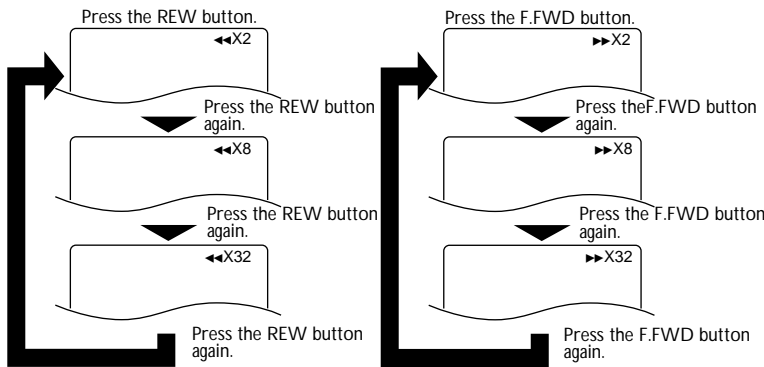

- On an Audio CD, you may search forward or backward at 16 times the normal playback speed ($\ll X16$ or $\gg X16$). Pressing the F.FWD or REW button repeatedly will not affect the speed of the search. Sound will be intermittent during searching on an Audio CD.
- Use the F.FWD button for a forward search. Press the REW button for a reverse search.

Press the REW button during Audio CD playback.



Press the F.FWD button during Audio CD playback.



2

Press the PLAY button to return to normal playback.

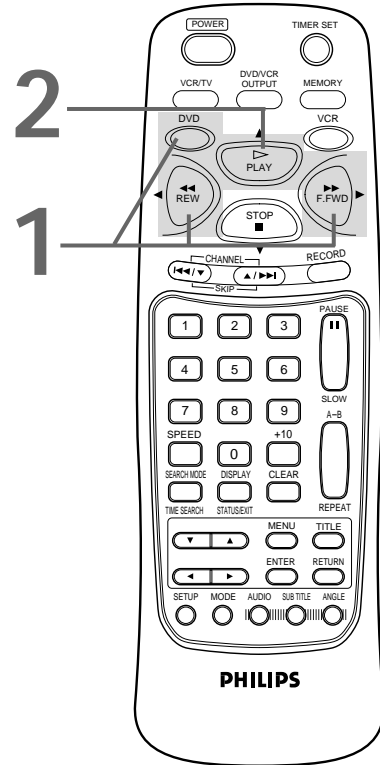

Helpful Hint

- To see the search speed on the screen, OSD MESSAGE must be set to ON. Details are on page 74.

AUDIO CD

Starting Playback at a Specific Track

There are three ways to begin playback on an Audio CD at a specific Track. You may use the Number buttons, the SEARCH MODE button, or the SKIP $\ll\ll\gg\gg$ buttons. For details, read the information below.

- Before you begin, place the DVD/VCR in DVD mode. Press the DVD/VCR OUTPUT button so that the red DVD light appears on the front of the DVD/VCR.

A

Using the Number Buttons to Select a Track

Press the DVD button, then press the Number buttons to enter the desired Track number. The selected Track will be located, and playback will start. You may select a Track with the Number buttons during playback or when playback is stopped.

For single-digit Tracks, press a single Number button. For example, to play Track three, press the Number 3 button.

For Tracks numbered 10 and above, press the +10 button (repeatedly, if necessary), then press the Number button of the second digit. For example, to play Track 12, press the +10 button, then press the Number 2 button. For Track 22, press the +10 button twice, then press the Number 2 button.

If you enter a Track number that is not available on the Disc, playback will not begin (or the current Track will continue to play).

B

Using the SEARCH MODE Button to Select a Track

Press the DVD button, then press the SEARCH MODE button once, then press the $\blacktriangle/\blacktriangledown$ buttons to select the Track number you desire. Finally, press the PLAY button to begin playback at the selected Track.

If you press the SEARCH MODE button once during playback, the current Track number will be displayed inside the brackets.

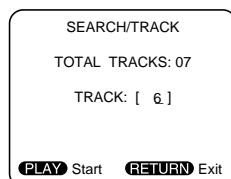

C

Using the SKIP $\ll\ll\gg\gg$ Buttons to Select a Track

Press the DVD button, then press the SKIP $\gg\gg$ button during playback to skip the current Track and move to the next Track. Press the SKIP $\gg\gg$ button repeatedly to skip subsequent Tracks. The Track number will appear briefly on the TV screen.

Press the SKIP $\ll\ll$ button during playback to return to the beginning of the current Track. Press the SKIP $\ll\ll$ button repeatedly to go to previous Tracks. The Track number will appear briefly on the TV screen.

If you press a SKIP button when playback is paused, you must press the PLAY button to resume playback.

If you press a SKIP button when playback is stopped, the selected Track will begin playing automatically.

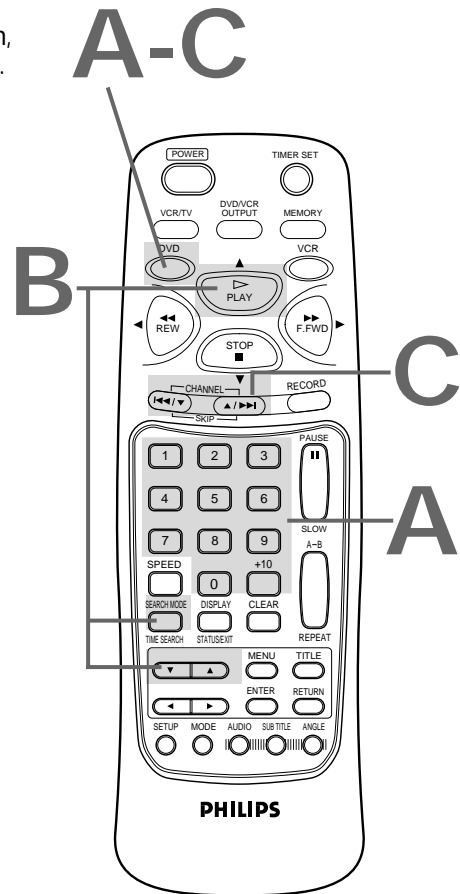

56 Title/Chapter Playback

DVD

Starting Playback at a Specific Title/Chapter

There are two ways to begin DVD playback at a specific Title or Chapter. You may use the Number buttons or the SEARCH MODE button.

- Before you begin, place the DVD/VCR in DVD mode. Press the DVD/VCR OUTPUT button so that the red DVD light appears on the front of the DVD/VCR.

A

Using the Number Buttons to Select a Title/Chapter
During playback, press the DVD button, then press the Number buttons to select a Chapter. The Chapter will be located and playback will start.

When playback is stopped, press the Number buttons to select a Title. The Title will be located and playback will begin. For single-digit Chapters or Titles, press a single Number button. For example, to play Chapter three, press the Number 3 button during playback. To play Title two, press the Number 2 button while playback is stopped.

For Chapters/Titles numbered 10 and above, press the +10 button (repeatedly, if necessary), then press the Number button of the second digit. For example, to play Chapter 12, press the +10 button, then press the Number 2 button during playback. For Title 22, press the +10 button twice, then press the Number 2 button when playback is stopped.

B

Using the SEARCH MODE Button to Select a Title/Chapter
To start playback at a specific Chapter, press the DVD button, then press the SEARCH MODE button once, then press the Number buttons or the ▲/▼ buttons to enter the Chapter number. Press the PLAY button to begin playback at the selected Chapter.

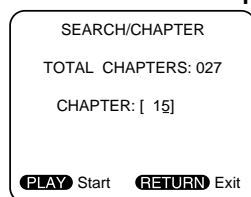

To start playback at a specific Title, press the SEARCH MODE button twice, then press the Number buttons or the ▲/▼ buttons to enter the Title number. Press the PLAY button to begin playback at the selected Title.



A-B

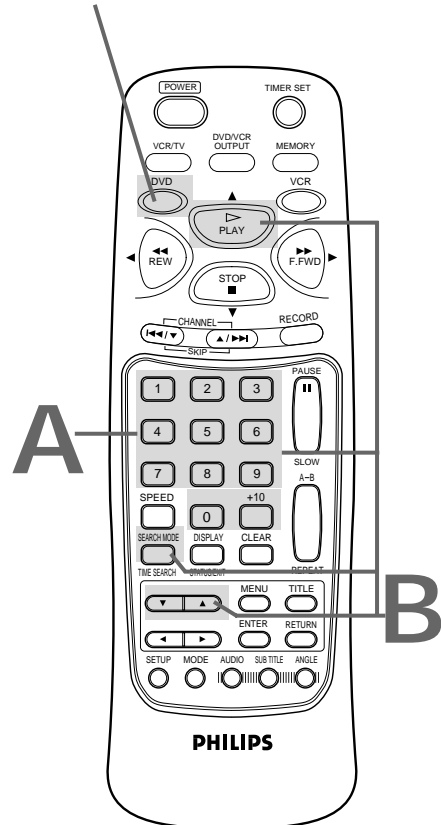

Helpful Hints

- Some discs may not allow you to change Titles in the Search Mode screen.
- During DVD playback, press the SKIP buttons to go to the next chapter, return to the beginning of the current chapter, or go to a previous chapter.

DVD AUDIO CD

Starting Playback at a Specific Disc Time

- Before you begin, place the DVD/VCR in DVD mode. Press the DVD/VCR OUTPUT button so that the red DVD light appears on the front of the DVD/VCR.

1

Press the DVD button, then press the SEARCH MODE button repeatedly (three times for DVDs or two times for Audio CDs).

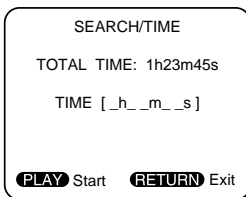

2

Use the Number buttons to enter the Disc time at which you want playback to begin.

- Example: 1 hour, 23 minutes and 30 seconds
1 → +10 → +10 → 3 → +10 → +10 → +10 → 0
- To enter zero, press the Number 0 (zero) button or press the ► button.
- Make sure the time you enter is within the total time of the Disc. If it is not, you will have to enter a different time.
- If you make a mistake, press the ► button repeatedly until you reach the item you need to correct (hour, minute, or second), then enter the correct information.

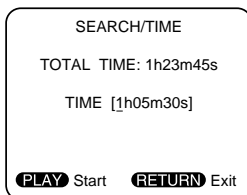

3

Within 30 seconds, press the PLAY button. Playback will start at the time that you specified.

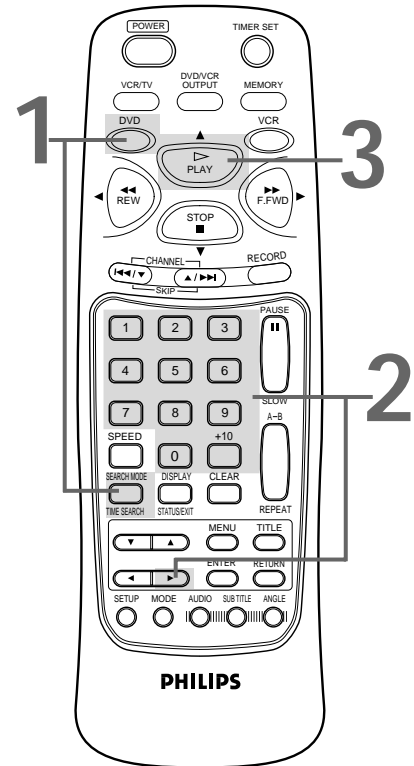

Helpful Hint

- Specific time playback is not available with some discs or if MEMORY OFF is activated for a DVD. Details are on page 52.

58 Repeat Playback (Discs)

- Before you begin, place the DVD/VCR in DVD mode.
Press the DVD/VCR OUTPUT button so that the red DVD light appears on the front of the DVD/VCR.

1

Press the DVD button, then press the REPEAT button repeatedly until the repeat mode you want appears in the top left corner of the TV screen.

DVD

- Repeatedly pressing the REPEAT button during playback lets you choose REPEAT CHAPTER, REPEAT TITLE, or REPEAT OFF.
- If a Chapter is playing repeatedly, then you press the Number buttons to select a new Chapter, the new Chapter will play repeatedly.

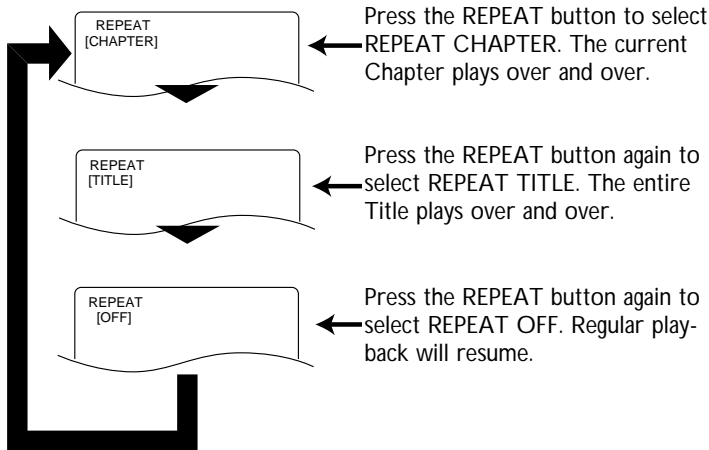

AUDIO CD

- Repeatedly pressing the REPEAT button during playback lets you choose REPEAT TRACK, REPEAT ALL and REPEAT OFF.
- If a Track is playing repeatedly, then you press the Number buttons to select a new Track, the new Track will play repeatedly.

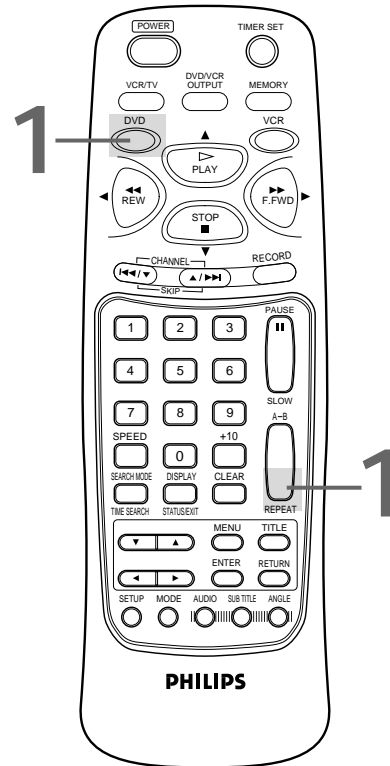
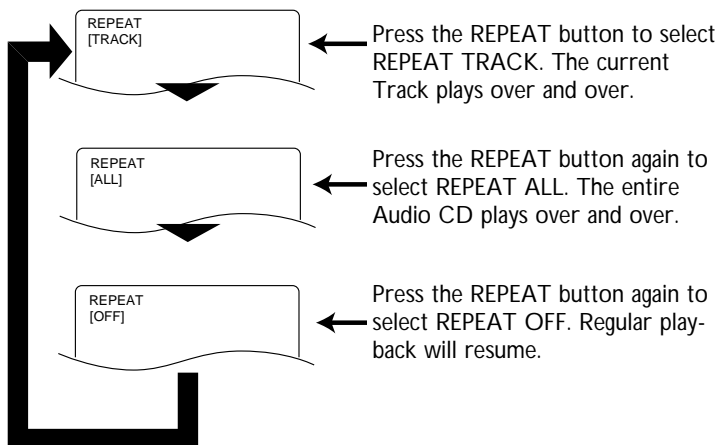

Helpful Hint

- Repeat playback is not available with some discs.

A-B Repeat Playback 59

DVD

AUDIO CD

You can play a section of an Audio CD or DVD repeatedly. Follow these steps to set up the section that you want to play over and over.

- Before you begin, place the DVD/VCR in DVD mode. Press the DVD/VCR OUTPUT button so that the red DVD light appears on the front of the DVD/VCR.

1

Press the DVD button.

2

Play the Disc to the point at which you want repeated playback to begin.

3

Press the A-B REPEAT button to set the starting point (A).

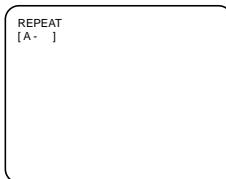

4

Play or fast forward the Disc to the point at which you want repeated playback to end, then press the A-B REPEAT button again.

The section will begin to play immediately, playing over and over until you cancel the A-B Repeat feature.

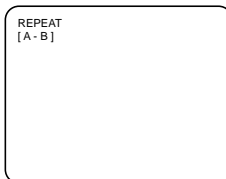

5

To cancel the A-B Repeat feature, press the A-B REPEAT button so that REPEAT [OFF] appears on the TV screen. Regular Disc playback will resume.

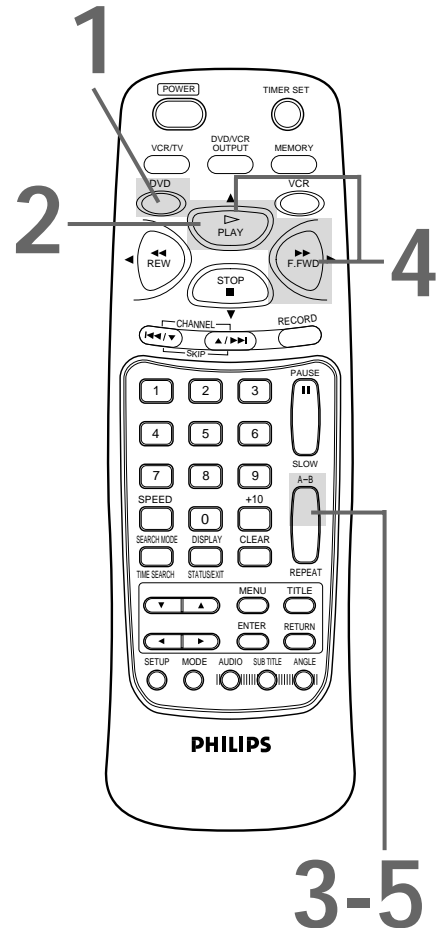
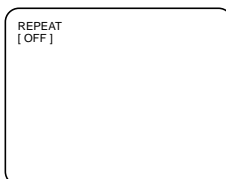

Helpful Hints

- A-B Repeat playback is not available with some DVDs.
- With DVDs, the entire A-B repeat section must be within a single Title.
- With Audio CDs, the A-B repeat section can contain multiple Tracks.
- Point B must be later on the Disc than Point A.

60 Programmed Playback

AUDIO CD

You may determine the order in which Tracks will play. The order that you set is called the Program. To set up programmed playback, follow these steps.

- Before you begin, place the DVD/VCR in DVD mode. Press the DVD/VCR OUTPUT button so that the red DVD light appears on the front of the DVD/VCR.

1

While playback is stopped, press the DVD button, then press the MODE button. The program screen will appear.

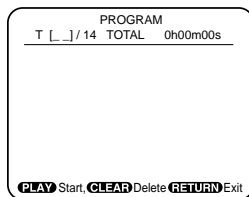

2

Press the Number buttons or the ▲/▼ buttons to enter the number of the first Track that you want to play. Then, press the ENTER button to store the selected Track in the Program.

- If you enter a wrong Track number, press the CLEAR button. The last Track in the Program will be removed.

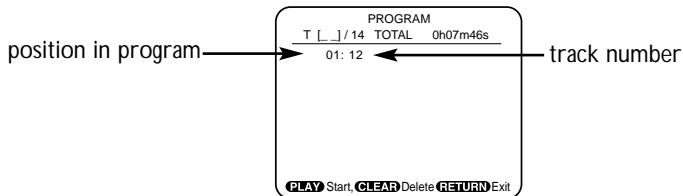

3

Repeat step 2 until you have selected all the Tracks you wish to play in the Program.

- Up to 20 Tracks may be stored in the Program.
- Make sure the Track numbers you enter are available on the Audio CD. If it is not, you will have to enter a different track.

4

Press the PLAY button. The Tracks will play in the order in which you programmed them. The Program will play once.

- The contents of the program will be stored until you turn off the DVD/VCR or open the Disc tray.

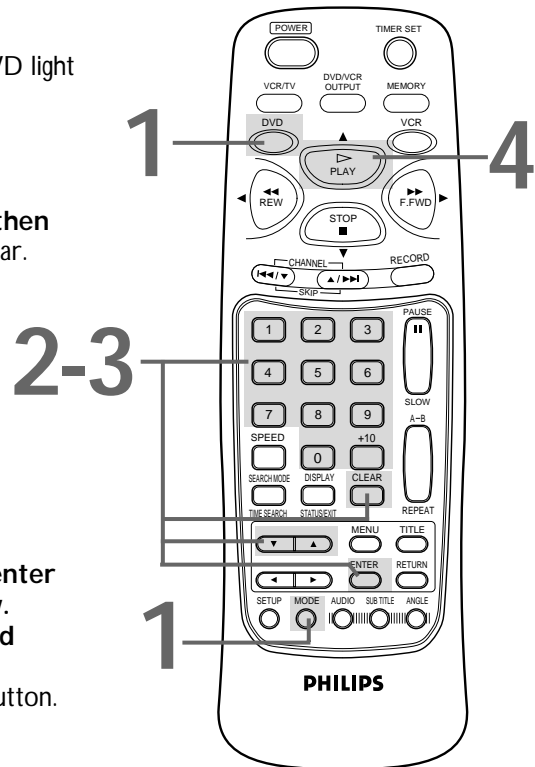

Helpful Hints

- Specific Track and random playback cannot be combined with programmed playback. During programmed playback, the MODE and SEARCH MODE buttons will not operate.
- You may play a Program repeatedly. During programmed playback, press the REPEAT button so that REPEAT [ON] appears. The program will play over and over.
- To see which Tracks you stored in the Program, press the STOP button to stop playback, then press the MODE button so that the PROGRAM screen appears.
- Programmed playback can only be started from the program screen.

Random Playback 61

AUDIO CD

You may play the Tracks of an Audio CD in Random order instead of the order in which they are recorded (1,2,3...). To set up Random Playback, follow these steps.

- Before you begin, place the DVD/VCR in DVD mode. Press the DVD/VCR OUTPUT button so that the red DVD light appears on the front of the DVD/VCR.

1

While playback is stopped, press the DVD button, then press the MODE button repeatedly so that the RANDOM screen appears.

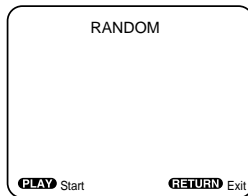

2

While the RANDOM screen appears, press the PLAY button. The Tracks will play in random order. After all the Tracks on the disc have played once, playback will stop.

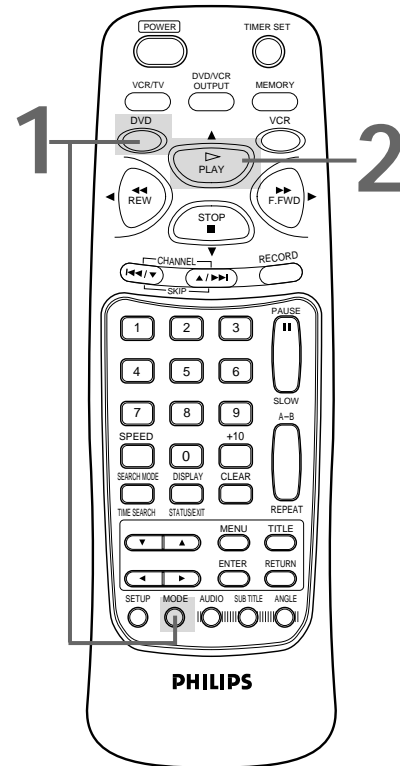

62 Audio Language/Sound Mode

The DVD/VCR allows you to select a Language for DVDs or a Sound Mode for Audio CDs. Before you begin, put the DVD/VCR in DVD mode.

- Press the DVD/VCR OUTPUT button so that the red DVD light appears on the front of the DVD/VCR.

DVD Language

1

Press the DVD button, then press the AUDIO button during playback, then press the ▲/▼ buttons to select the desired language.

- The language can be changed only if multiple languages are available on the DVD.

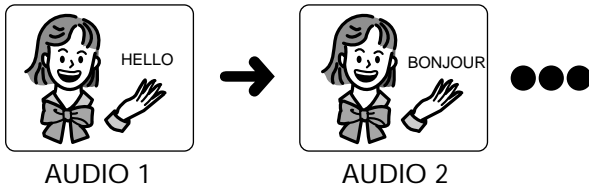
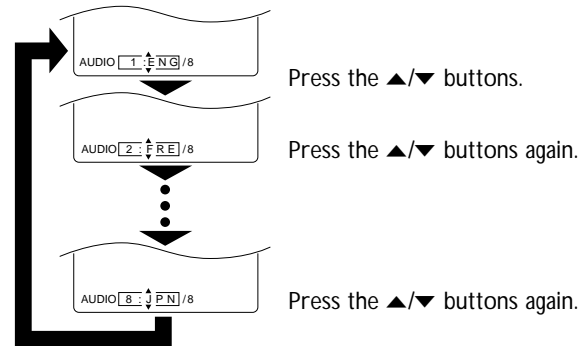

AUDIO CD Sound Mode

1

Press the DVD button, then press the AUDIO button during playback, then press the ▲/▼ buttons until the sound mode you want appears.

- When producers record an Audio CD, they record the sound on two channels - the left and the right. You can choose to hear the sound on the left channel, the sound on the right channel, or the sound on both channels (Stereo). You will select L-CH, R-CH, or STEREO.

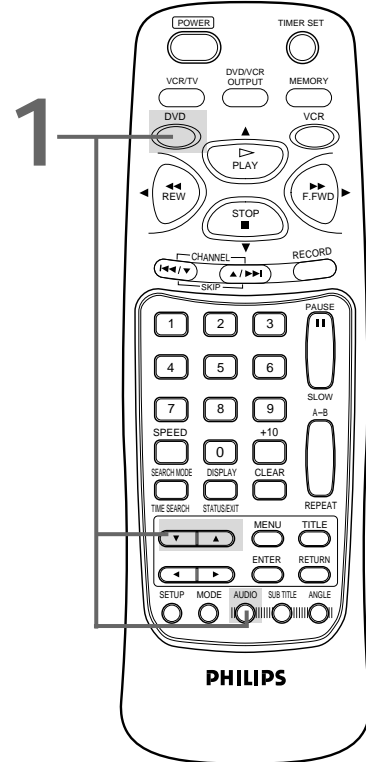
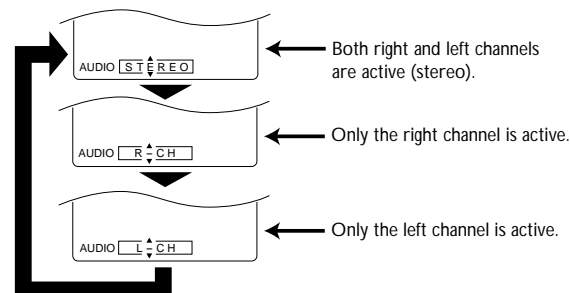

Helpful Hints

- If a desired language is not shown after pressing the ▲/▼ buttons several times, the DVD does not have that language.
- The display will disappear after about 15 seconds.
- Some DVDs only allow you to change the language in the Disc menu.
- When you use the DIGITAL AUDIO OUT COAXIAL jack, the sound mode of audio CDs cannot be changed.

Subtitle Language 63

DVD

The DVD/VCR allows you to select a language for subtitles from those available on the disc.

- Before you begin, place the DVD/VCR in DVD mode. Press the DVD/VCR OUTPUT button so that the red DVD light appears on the front of the DVD/VCR.

1

Press the DVD button, then press the SUBTITLE button during playback. The subtitle menu will appear on the TV screen.

2

Within 15 seconds, press the ▲/▼ buttons to select a subtitle language. Select a language from those available on the DVD.

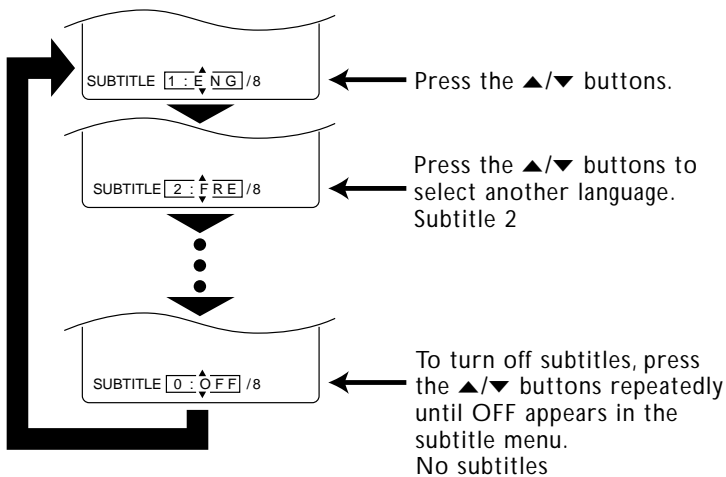

SUBTITLE 1

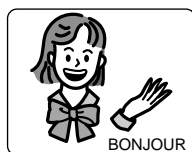

SUBTITLE 2



3

The subtitle menu will disappear after about 15 seconds.

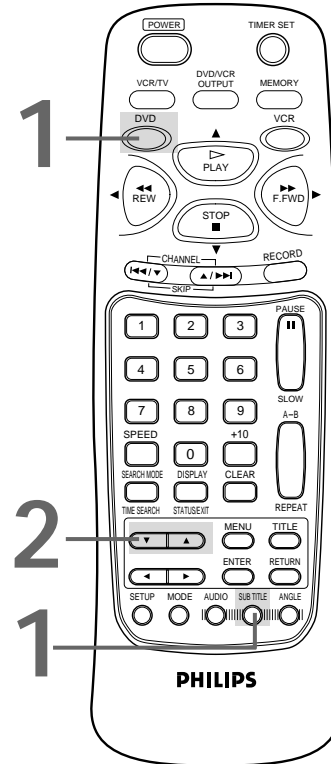

Helpful Hints

- With some DVDs, you may select a subtitle language in the Disc menu.
- If the desired language is not shown after pressing the ▲/▼ buttons several times, the Disc does not have subtitles in that language.
- The subtitles may be delayed for a few seconds.
- Your subtitle selection will be cancelled if you open the Disc tray or turn off the power. The default setting of the DVD will be selected again.

64 Camera Angles

DVD

Some DVDs contain scenes that were recorded from different angles. You may select a camera angle with the DVD/VCR.

- Before you begin, place the DVD/VCR in DVD mode.
Press the DVD/VCR OUTPUT button so that the red DVD light appears on the front of the DVD/VCR.

1

Press the DVD button, then press the ANGLE button during playback.

2

Within 15 seconds, press the ▲/▼ buttons to select a different angle.

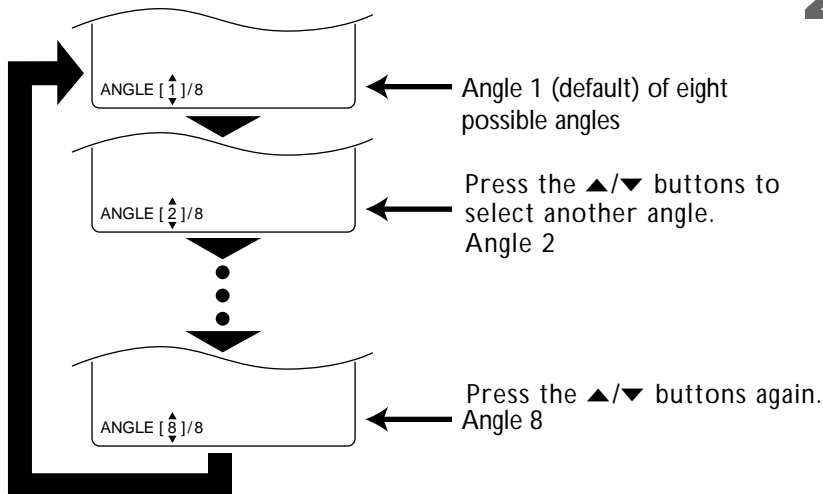

- If the Disc contains sequences recorded from different camera angles, the angle symbol  will appear at the bottom-right of the screen. You can change the camera angle when the symbol appears on the screen.
- The camera angle cannot be changed if the Disc does not contain sequences recorded from different camera angles.

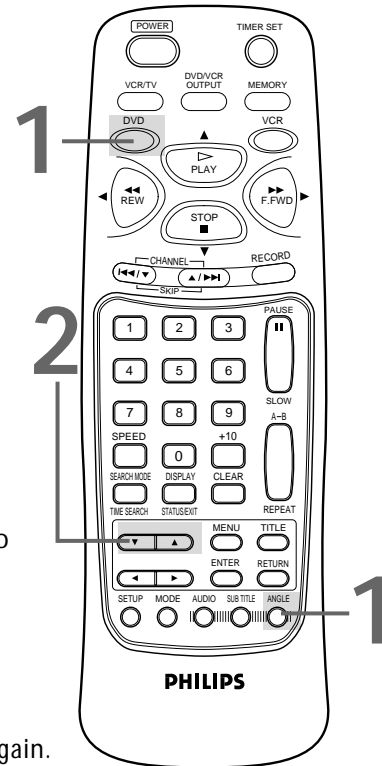

Helpful Hints

- The ANGLE ICON must be set to ON in order for the angle symbol to appear as described in step 2. To set ANGLE ICON to ON, see page 74.
- If the angle status appears on the screen (for example, ANGLE [1]/8), the angle symbol will not appear on the screen.

DVD **AUDIO CD**

Accessing the Status Display

You can check the information about the current Disc by pressing the DISPLAY button on the remote control.

- Before you begin, place the DVD/VCR in DVD mode.
Press the DVD/VCR OUTPUT button so that the red DVD light appears on the front of the DVD/VCR.

1

Press the DVD button, then press the DISPLAY/STATUS/EXIT button repeatedly to access or remove the status displays.

DVD

TITLE	: 01/04	• Current Title number / total number of Titles
TIME	: 0h24m14s	• Elapsed time of the current Title
REMAIN	: 0h05m25s	• Remaining time of the current Title
CHAPTER	: 001/010	• Current Chapter number / total number of Chapters in the current Title
TIME	: 0h02m25s	• Elapsed time of the current Chapter
REMAIN	: 0h01m31s	• Remaining time of the current Chapter

AUDIO	: 1.ENGLISH	• Current language for the sound
	: DOLBY DIGITAL	• Current audio format (DOLBY DIGITAL 5.1 Channel is displayed as DOLBY DIGITAL 6 CH.)
	: 6CH	
SUBTITLE	: 2.FRENCH	• Current language for the subtitles
ANGLE	: 8/8	• Selected angle / total number of angles
VIRTUAL 3D		• VIRTUAL 3D setting (appears only if VIRTUAL 3D is ON)



No display

AUDIO CD

TRACK	: 01/04	• Current Track number / total Track number
TIME	: 0h05m25s	• Elapsed time of the current Track
REMAIN	: 0h01m31s	• Remaining time of the current Track
PROGRAM		• Current play mode



No display

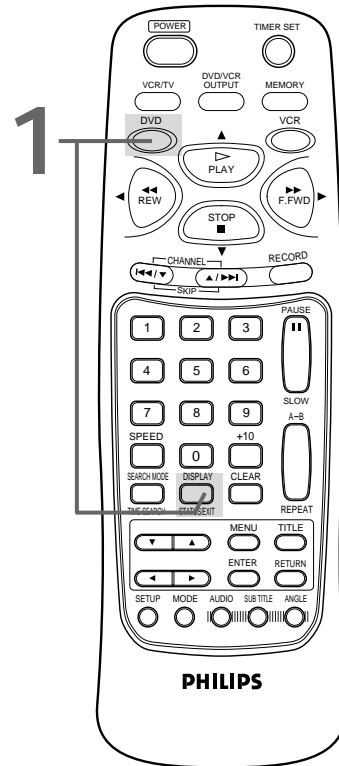

66 Parental Lock Levels

Parental Lock allows you to block viewing of DVDs that have ratings that exceed your selections. To set the levels, follow the steps below.

- Before you begin, place the DVD/VCR in DVD mode.
- Press the DVD/VCR OUTPUT button so that the red DVD light appears on the front of the DVD/VCR.

1

While playback is stopped, press the DVD button, then press the SETUP button. The setup screen will appear.

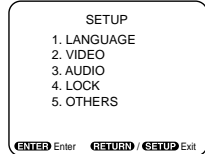

2

Press the Number 4 button to select LOCK. The SETUP/LOCK menu will appear.

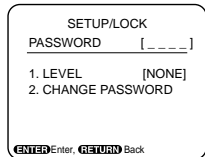

3

Press the Number buttons to enter your 4-digit password. ● When doing this for the first time, enter any 4 digits. That number will be the password until you change it.

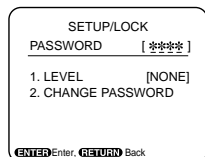

4

Press the Number 1 button to select LEVEL.

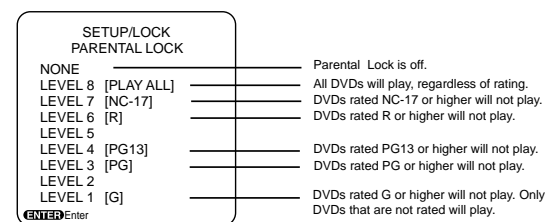

5

Press the ▲/▼ buttons to select the level you desire, then press the ENTER button. For example, if you want to play Discs rated PG13, you must select LEVEL 5 or higher. The SETUP/LOCK menu will reappear. The level you selected will appear on the screen beside LEVEL.

6

Press the RETURN button twice to remove the menu.

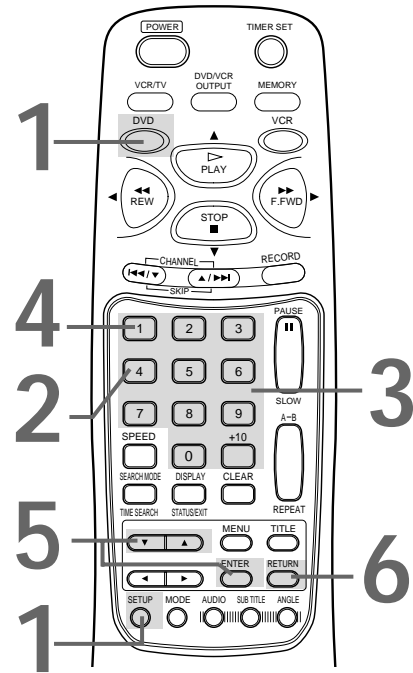

RATING EXPLANATIONS

- NC-17 - Under 17 not admitted
- R - Restricted; under 17 requires accompanying parent or adult guardian
- PG13 - Unsuitable for children under 13
- PG - Parental Guidance suggested
- G - General Audience

Helpful Hints

- Some DVDs are not compatible with Parental Lock. Make sure the DVD plays according to the Parental Lock settings you have made.
- The DVD/VCR will not allow you to change LEVEL settings until you enter the correct password.
- When you try to play a Disc that has a rating that exceeds the level you set, a message will appear on the screen, indicating the Disc cannot be played. If this happens, press the OPEN/CLOSE button to remove the Disc, then select a level that allows playback. Or select NONE to turn off Parental Lock. Load the Disc again and begin playback as usual. Some Discs may allow you to simply enter your 4-digit password, then begin playback automatically. Follow the instructions provided by the Disc message.

Parental Lock Password 67

You can change the password as often as you like. To do so, follow these steps.

- Before you begin, place the DVD/VCR in DVD mode.
Press the DVD/VCR OUTPUT button so that the red DVD light appears on the front of the DVD/VCR.

1

While playback is stopped, press the DVD button, then press the SETUP button. The setup screen will appear.

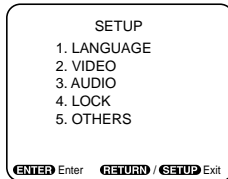

2

Press the Number 4 button to select LOCK. The SETUP/LOCK menu will appear.

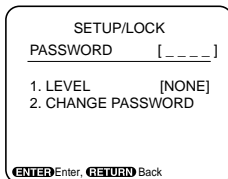

3

Press the Number buttons to enter the 4-digit password.

- When doing this for the first time, enter any 4 digits. That number will be the password until you change it.

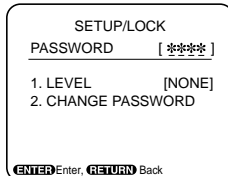

4

Press the Number 2 button to select CHANGE PASSWORD. The first space in the PASSWORD will start flashing.

5

Press the Number buttons to enter your new password.

6

Press the RETURN button twice to remove the menu.

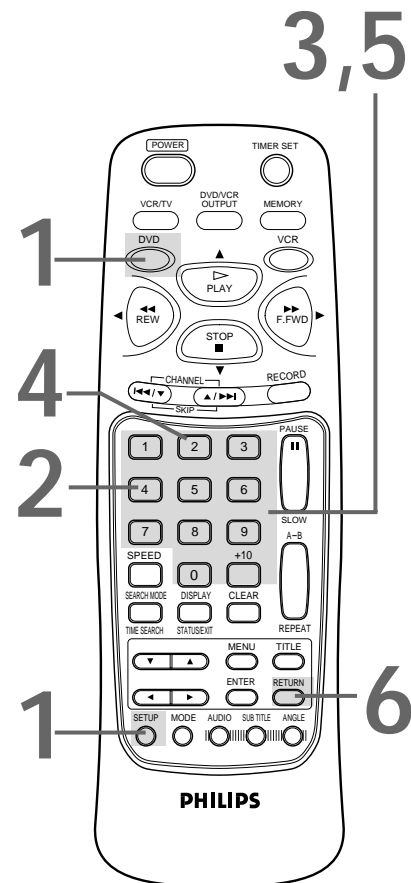

Helpful Hints

- Write down the password in case you forget it.
- To erase the old password, press the POWER button to turn off the DVD/VCR. Then, press and hold the DVD STOP button on the DVD/VCR while pressing the POWER button on the DVD/VCR to turn on the power again. When "HELLO" appears on the display panel, you may release the DVD STOP button. Follow the steps on this page to set the password that you desire.

68 Audio Settings

- Before you begin, place the DVD/VCR in DVD mode.
Press the DVD/VCR OUTPUT button so that the red DVD light appears on the front of the DVD/VCR.

1

While playback is stopped, press the DVD button, then press the SETUP button. The setup screen will appear.

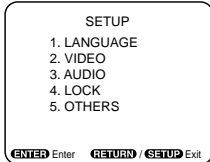

2

Press the Number 3 button to select AUDIO.

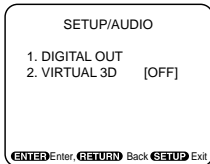

3

Press the corresponding Number button to select an item: DIGITAL OUT or VIRTUAL 3D.

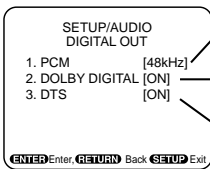

- Sets the sample rate for playing a disc recorded with high sound quality
- Select when a Dolby Digital decoder is connected.
- Select when a DTS decoder is connected.

To change the DIGITAL OUT settings, go to step 4.

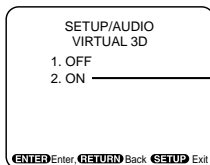

- Select ON to activate the 3D effect.

To change the VIRTUAL 3D setting, press the corresponding Number button, then go to step 5.

This unit employs TruSurround system **TruSurround**™ of SRS Labs, Inc. as the VIRTUAL 3D technology.

TruSurround and the  symbol are trademarks of SRS Labs, Inc. in the United States and selected foreign countries.

TruSurround technology is incorporated under license from SRS Labs, Inc.

2-3

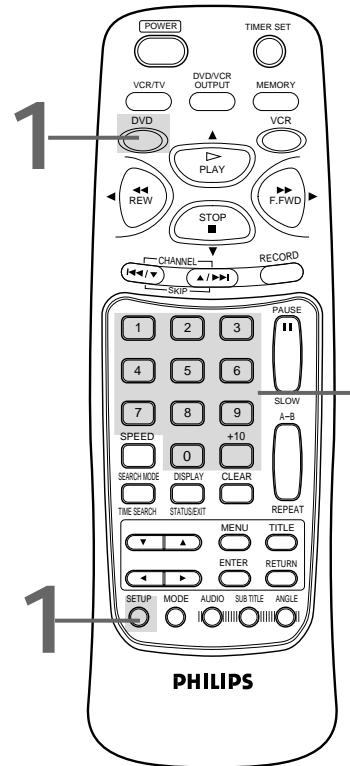

Helpful Hint

- To enjoy Dolby Digital Surround or DTS Surround sound, you must have the DVD/VCR connected to a Dolby Digital or DTS decoder. Details are on page 14.

4

To change the PCM, DOLBY DIGITAL, or DTS settings, press the corresponding Number button to select the desired item, then press the Number button to choose the setting (i.e. ON or OFF).

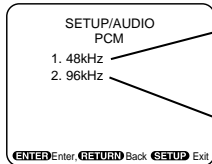

- Audio signals are converted to 48 kHz/16 bit signals when playing a DVD recorded with high sound quality (48 kHz/20 bit/24 bit, 96 kHz).
- Sound is reproduced at 96 kHz if a DVD is recorded with high sound quality. If you are playing 48 kHz discs or if 4:3 LETTER BOX is selected, sound is reproduced at 48 kHz.

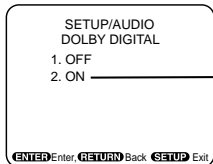

- Select ON when a Dolby Digital decoder is used.

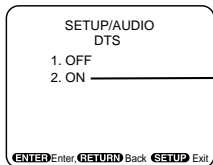

- Select ON when a DTS decoder is used.

5

Press the SETUP button to remove the menu.

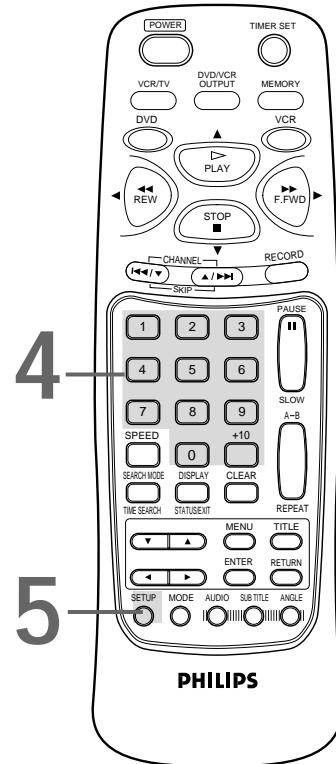

70 Language Settings

- Before you begin, place the DVD/VCR in DVD mode.
Press the DVD/VCR OUTPUT button so that the red DVD light appears on the front of the DVD/VCR.

DVD

1

While playback is stopped, press the DVD button, then press the SETUP button. The setup screen appears.

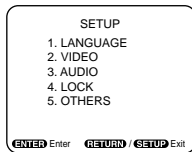

2

Press the Number 1 button to select LANGUAGE.

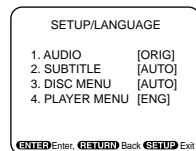

3

Press a Number button to select an item: AUDIO, SUBTITLE, DISC MENU, or PLAYER MENU.

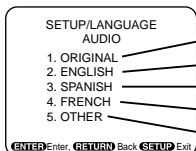

- The original language of each disc will be selected.
- Voice is played back in English.
- Voice is played back in Spanish.
- Voice is played back in French.
- You can select other languages for audio playback.

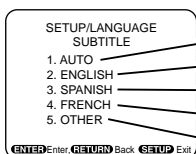

- Subtitles are shown in the automatically selected language.
- Subtitles are shown in English.
- Subtitles are shown in Spanish.
- Subtitles are shown in French.
- You can select other languages for subtitles.

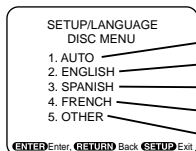

- The disc menu is shown in the automatically selected language.
- The disc menu appears in English.
- The disc menu appears in Spanish.
- The disc menu appears in French.
- You can select other languages for the disc menu.

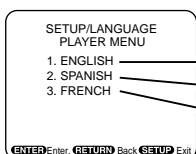

- The on-screen display and DVD Player menus appear in English.
- The on-screen display and DVD Player menus appear in Spanish.
- The on-screen display and DVD Player menus appear in French.

Go to step 4 to change the settings within AUDIO, SUBTITLE, DISC MENU or PLAYER MENU.

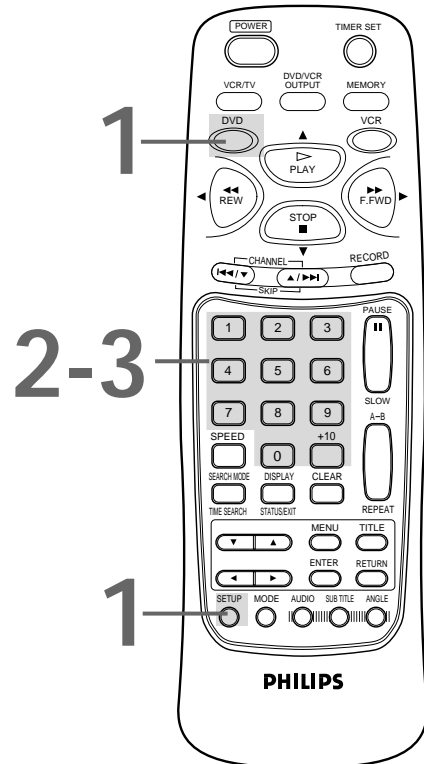

Helpful Hints

- If the original or automatic settings for AUDIO and SUBTITLE are the same language, the subtitles will not be shown.
- Language settings for AUDIO, SUBTITLE, and DISC MENU are not available with some discs. Use the AUDIO and SUBTITLE buttons instead to select different languages for the audio and subtitles. Details are on pages 62 and 63.
- Not all discs provide different languages for audio, subtitles, or disc menus.

4

Press a Number button to select a setting.

- If OTHER is selected on the AUDIO, SUBTITLE or DISC MENU screen, the COUNTRY CODE screen will appear. Press four Number buttons to enter the country code you desire, then press the ENTER button. Refer to the list on page 72. The codes are listed alphabetically, according to language.
- You can only select other languages for AUDIO, SUBTITLE, and DISC MENU if the language is available on the Disc.

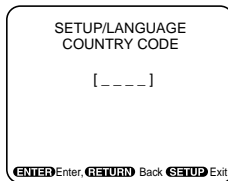

5

Press the SETUP button to remove the menu.

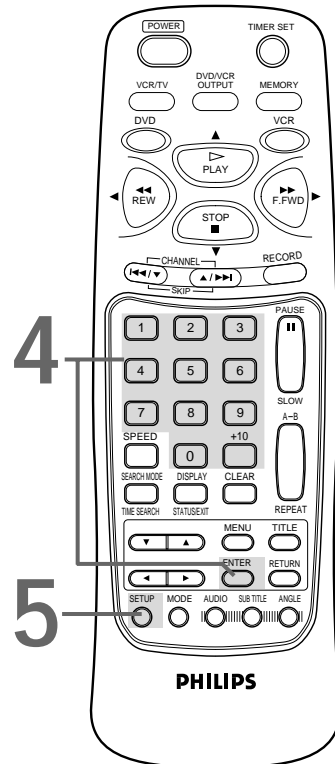

Helpful Hint

- If you accidentally set the PLAYER MENU LANGUAGE to French or Spanish and need English:
 - 1) Press the DVD button, then press the SETUP button.
 - 2) Press the Number 1 button (IDIOMA or LANGUE).
 - 3) Press the Number 4 button (MENÚ EN PANTALLA or MENU SUR ÉCRAN).
 - 4) Press the Number 1 button (INGLÉS or ANGLAIS).
 - 5) Press the SETUP button to remove the menu.

72 Language Settings (cont'd)

<u>Language</u>	<u>Country Code</u>	<u>Language</u>	<u>Country Code</u>	<u>Language</u>	<u>Country Code</u>
A-B		I-K		S	
Abkhazian	4748	Icelandic	5565	Samoan	6559
Afar	4747	Indonesian	5560	Sangho	6553
Afrikaans	4752	Interlingua	5547	Sanskrit	6457
Albanian	6563	Interlingue	5551	Serbian	6564
Amharic	4759	Inupiak	5557	Serbo-Croatian	6554
Arabic	4764	Irish	5347	Sesotho	6566
Armenian	5471	Italian (ITA)	5566	Setswana	6660
Assamese	4765	Japanese (JPN)	5647	Shona	6560
Aymara	4771	Javanese	5669	Sindhi	6550
Azerbaijani	4772	Kannada	5760	Singhalese	6555
Bangla	4860	Kashmiri	5765	Siswat	6565
Bashkir	4847	Kazakh	5757	Slovak	6557
Basque	5167	Kinyarwanda	6469	Slovenian	6558
Bengali	4860	Kirghiz	5771	Somali	6561
Bhutani	5072	Kirundi	6460	Spanish (SPA)	5165
Bihari	4854	Korean (KOR)	5761	Sundanese	6567
Bislama	4855	Kurdish	5767	Swahili	6569
Breton	4864			Swedish	6568
Bulgarian	4853	L-N			
Burmese	5971	Laothian	5861	T	
Byelorussian	4851	Latin	5847	Tagalog	6658
		Latvian	5868	Tajik	6653
C-E		Lettish	5868	Tamil	6647
Cambodian	5759	Lingala	5860	Tatar	6666
Catalan	4947	Lithuanian	5866	Telugu	6652
Chinese (CHI)	7254	Macedonian	5957	Thai	6654
Corsican	4961	Malagasy	5953	Tibetan	4861
Croatian	5464	Malay	5965	Tigrinya	6655
Czech	4965	Malayalam	5958	Tonga	6661
Danish	5047	Maltese	5966	Tsonga	6665
Dutch (DUT)	6058	Maori	5955	Turkish	6664
English (ENG)	5160	Marathi	5964	Turkmen	6657
Esperanto	5161	Moldavian	5961	Twi	6669
Estonian	5166	Mongolian	5960	U-Z	
		Nauru	6047	Ukrainian	6757
F-H		Nepali	6051	Urdu	6764
Faroese	5261	Norwegian	6061	Uzbek	6772
Fiji	5256			Vietnamese	6855
Finnish	5255	O-R		Volapuk	6961
French (FRE)	5264	Occitan	6149	Welsh	4971
Frisian	5271	Oriya	6164	Wolof	6961
Gaelic (Scots)	5350	Oromo (Afan)	6159	Xhosa	7054
Galician	5358	Panjabi	6247	Yiddish	5655
Georgian	5747	Pashto	6265	Yoruba	7161
German (GER)	5051	Persian	5247	Zulu	7267
Greek	5158	Polish	6258		
Greenlandic	5758	Portugese	6266		
Guarani	5360	Pushto	6265		
Gujarati	5367	Quechua	6367		
Hausa	5447	Rhaeto-Romance	6459		
Hebrew	5569	Romanian	6461		
Hindi	5455	Russian	6467		
Hungarian	5467				

Video Settings 73

- Before you begin, place the DVD/VCR in DVD mode.
Press the DVD/VCR OUTPUT button so that the red DVD light appears on the front of the DVD/VCR.

1

When playback is stopped, press the DVD button, then press the SETUP button. The setup screen will appear.

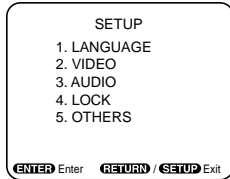

2

Press the Number 2 button to select VIDEO.

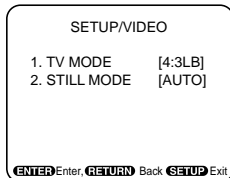

3

Press the corresponding Number button to select an item: TV MODE or STILL MODE.

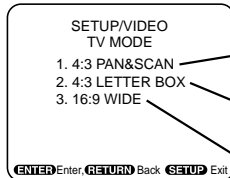

- Full-height pictures are shown, with one or both sides trimmed.
- Wide screen (full-width) pictures are shown, with black bars at top and bottom.
- Select if a wide screen TV is connected to the DVD Player.

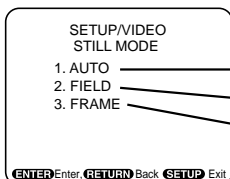

- AUTO is normally selected.
- Select if pictures are blurred in auto mode.
- Select to show Still pictures in high resolution.

4

Press the corresponding Number button to select a setting.

5

Press the SETUP button to remove the menu.

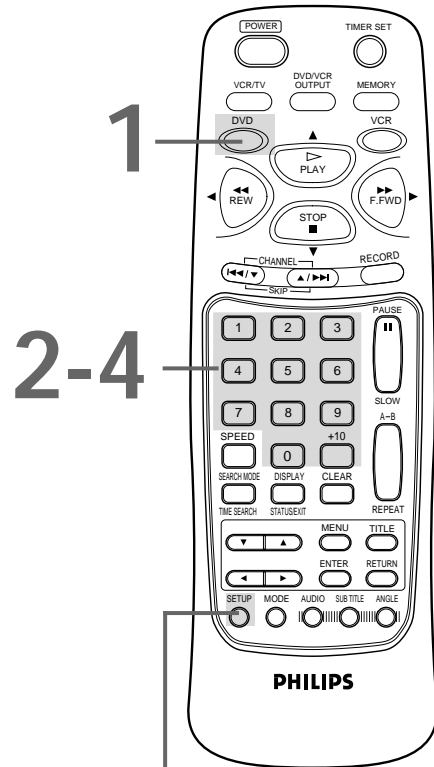

1,5

Helpful Hint

- You may select a different TV MODE setting only if it is available on the Disc.

74 Other Menu Settings

- Before you begin, place the DVD/VCR in DVD mode.
Press the DVD/VCR OUTPUT button so that the red DVD light appears on the front of the DVD/VCR.

1

When disc playback is stopped, press the DVD button, then press the SETUP button. The setup screen will appear.

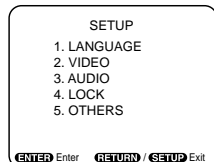

2

Press the Number 5 button to select OTHERS.

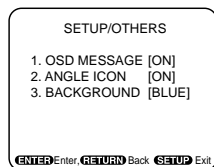

3

Press the corresponding Number button to select an item: OSD MESSAGE, ANGLE ICON, or BACKGROUND.

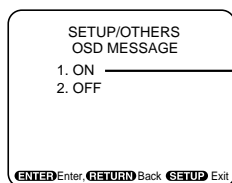

- Select ON to display messages on the screen, such as PLAY, STOP, etc.

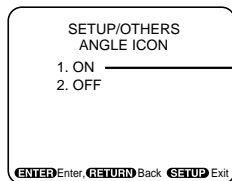

- Select ON to display the angle icon.

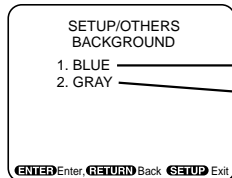

- Turns the Player menu background to blue
- Turns the Player menu background to gray

4

Press a Number button to select a setting.

5

Press the SETUP button to remove the menu.

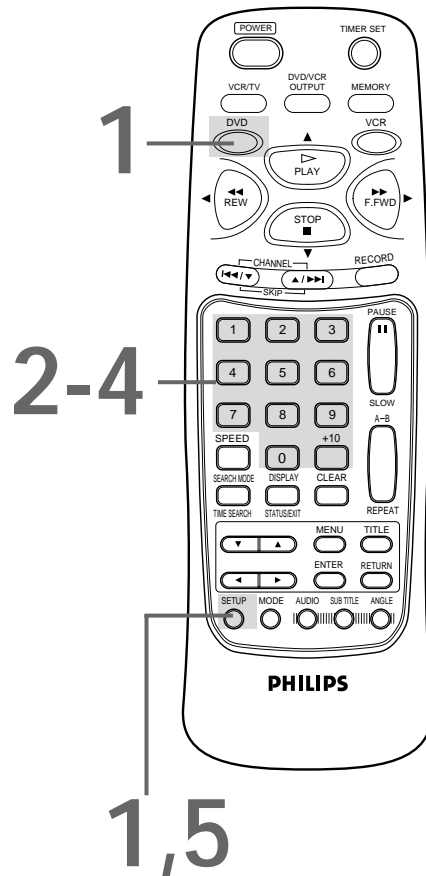

Care and Maintenance / Specifications 75

Care and Maintenance

Cleaning the DVD/VCR

- Wipe the front panel and other exterior surfaces of the DVD/VCR with a soft, slightly damp cloth.
- Never use a solvent, thinner, benzene or alcohol to clean the DVD/VCR. Do not spray insecticide liquid near the DVD/VCR. Such chemicals may discolor the surface or damage the DVD/VCR.

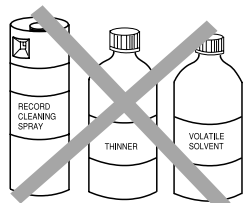

Don't use cleaners.

Cleaning a Disc

- Use a soft, dry cloth to wipe the Disc.
- Wipe the Disc in a straight line from the center to the edge. Never wipe the Disc in a circular motion.

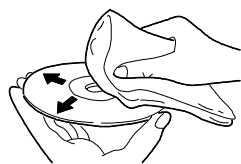

Wipe Discs from the center to the edge.

- Do not use detergent or abrasive cleaning agents.
- Handle the Discs so that fingerprints and dust do not adhere to the surfaces of the Discs.

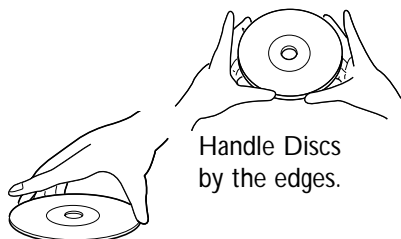

Handle Discs by the edges.

- Always store the Disc in its protective case when it is not in use.

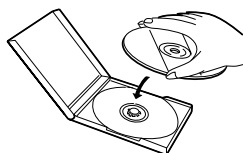

Keep the Disc in its case.

Checking the Laser

- If the DVD/VCR does not operate as described in this owner's manual, the laser may be dirty. Consult an Authorized Service Center for inspection and cleaning of the laser.

Specifications

Video Heads

Four heads - Hi-Fi

Antenna

VHF/UHF - 75 ohm external antenna terminal

VHF Output Signal

Channel 03 or 04 (switchable)
75 ohms unbalanced

Tuner Broadcast Channels

VHF 2-13, UHF 14-69

Cable TV Channels

1-125

Product Type

Digital Video Disc Player & Video Cassette Recorder

Playable Discs

DVD-Video
Audio CD

Color System

NTSC

Frequency Response

DVD (linear sound):
20 Hz to 22 kHz (sample rate: 48 kHz)
20 Hz to 44 kHz (sample rate: 96 kHz)
Audio CD: 20 Hz to 20 kHz

Signal-to-Noise Ratio (S/N Ratio)

Audio CD:
110 dB EIAJ (Electronic Industries Association of Japan)

Dynamic Range

DVD (linear sound): 95 dB
Audio CD: 94 dB (EIAJ)

Total Distortion Factor

Audio CD: 0.007% (EIAJ)

Wow and Flutter

Below the measurement limitation
(±0.001% W PEAK) (EIAJ)

Power Requirement

120V AC +/- 10%, 60 Hz +/- 0.5%

Power Consumption

Power on: 37 W
Standby (power off): 4 W

Operating Temperature

41°F (5°C) to 104°F (40°C)

Relative Humidity

30% to 80%

Dimensions

17-1/8" (W) x 4-1/16" (H) x 12-11/16" (D)
(435mm x 103mm x 323mm)

Weight

11.0 lbs. (5.0 kg.)

NOTE: Designs and specifications are subject to

76 Helpful Hints

If you are having problems with your product, check this list of problems and possible solutions before requesting service. You may be able to solve the problem yourself.

If you need to call a customer service representative, please know the model number and serial number of your product before you call. This information is displayed on the back of the product. Also, please take a moment to identify the problem you are having, and be prepared to explain this to the representative. If you believe the representative will need to help you with operations, please stay near the product. Our representatives will be happy to assist you.

The DVD/VCR has no power.

- Make sure the power cord is connected completely to an AC (alternating current) outlet.
- Press the POWER button to turn on the DVD/VCR. "HELLO" will appear briefly on the display panel as the power is turning on.

The remote control will not operate the DVD/VCR.

- Aim the remote control directly at the DVD/VCR's remote sensor. *Details are on page 26.*
- Remove all obstacles between the remote control and the DVD/VCR.
- Inspect and/or replace the batteries in the remote control. *Details are on page 15.*
- Use the remote control within 23 feet of the DVD/VCR.
- Press the DVD button, then try the other DVD feature buttons. (Press the DVD/VCR OUTPUT button so that the red DVD light appears on the front of the DVD/VCR. This means the DVD/VCR is in DVD mode.)
- Press the VCR button, then try the other VCR feature buttons. (Press the DVD/VCR OUTPUT button so that the green VCR light appears on the front of the DVD/VCR. This means the DVD/VCR is in VCR mode.)
- In VCR mode, make sure the VCR/TV light appears on the front of the DVD/VCR. If it does not, press the VCR/TV button once.

No picture in DVD mode.

- Make sure the video cable is connected correctly. You may connect either the yellow video cable (supplied), an optional S-Video cable, or optional component video cables. *Details are on pages 12-14.*
- Make sure the TV is set to the correct Video In channel (usually the AUX IN, A/V IN, Auxiliary In, Component Video In or S-Video In channel). Check your TV owner's manual for details.
- Insert a Disc that is playable on this DVD/VCR. *Details are on page six.*

Disc cannot be played.

- Insert a playable Disc. *Details are on page six.*
- Place the Disc correctly in the recesses in the Disc tray. If the Disc is one-sided, place the Disc in the tray with the label facing up. If the Disc is two-sided, make sure the side you want to play is facing up.
- Clean the Disc.
- Cancel the parental lock, enter the password, or change the control level. *Details are on pages 66-67.*
- Make sure the Disc is labelled for use in Region 1 or ALL regions. *Details are on page six.*

No sound

- Connect the audio cables firmly. Make sure the cables are connected to the AUDIO IN jacks on the TV or audio equipment. *Details are on pages 12-14.*
- Check the audio settings of the DVD/VCR. *Details are on pages 62 and 68-69.*
- Turn on the power of the audio equipment and make sure it is set to the correct channel, usually Auxiliary IN. Refer to the owner's manual of the audio equipment for details.
- Check the audio settings of the Disc. For example, you may have selected "soundtrack" playback on a DVD. Only the music of the movie will play, not the characters' dialog; music might not be recorded throughout the entire DVD.

Distorted picture

- Connect the DVD/VCR directly to the TV. *Details are on pages 8-14.*
- There are some cases where the picture may be distorted slightly; this is not a malfunction of the DVD/VCR.

The camera angle cannot be changed.

- The DVD might not contain segments recorded from different camera angles. See if multiple angles are available. *Details are on page 64.*

The audio or subtitle language cannot be changed.

- The DVD does not contain audio or subtitles in the desired language. Not all DVDs contain audio or subtitles in multiple languages. See if other languages are available. *Details are on pages 62-63.*

"No feature" symbol appears on the screen, prohibiting an operation.

- That operation is currently prohibited by the DVD/VCR or is not available on the Disc. *Details are on page five.*

The DVD/VCR switches to VCR mode automatically.

- The DVD/VCR will switch to VCR mode automatically if disc playback is paused or stopped for more than 30 minutes (and no buttons are pressed on the remote control or the DVD/VCR).

A screen saver appears on the TV screen.

- The DVD whale will appear on the TV screen if Disc playback is stopped for more than one minute (and no buttons are pressed on the remote control or the DVD/VCR). The DVD whale moves around on the screen to prevent damage to your TV's picture tube. A prolonged still image, including TV station identification logos or video games, may damage the picture tube.

78 Helpful Hints (cont'd)

Power Failure

- Timer recordings, the clock setting, the language selection, and channel setup may be lost if the power fails for more than one minute. Follow the steps on pages 16 and 20. Then, see pages 36-38 to reprogram your timer recordings.

A TV program cannot be recorded.

- Put the DVD/VCR in VCR mode. Press the DVD/VCR OUTPUT button so that the green VCR light appears on the front of the DVD/VCR.
- Check the connections between the DVD/VCR, TV, antenna/cable, and Cable Box/Direct Broadcast System (if applicable). *Details are on pages 8-11.*
- Make sure the tape has a record tab. *Details are on page seven.*
- Check the TV/VCR position. *Details are on page 25.*
- Check the CH3/CH4 switch. *Details are on pages 8-11.* Or, if you connected the DVD/VCR to the TV using audio and video cables, select the correct audio and video in channel at the TV. *Details are on page 12.*

The DVD/VCR will not perform a timer recording.

- Make sure the recording start and stop times are set correctly. *Details are on pages 36-39.*
- Make sure a tape is in the DVD/VCR and the tape has a record tab. *Details are on page seven.* If, after programming a timer recording, you press the TIMER SET button without putting a tape in the DVD/VCR, the TIMER SET light will blink.
- If the record tab on a tape is missing, the DVD/VCR will eject the tape. The TIMER SET light will blink.
- Press the TIMER SET button to put the DVD/VCR in standby mode for the timer recording. The TIMER SET light should appear on the front of the DVD/VCR.
- Make sure the clock is set. *Details are on page 20.*
- The DVD/VCR may not perform or continue a timer recording if a power failure of more than one minute occurs.
- If you have a Cable Box/Direct Broadcast System, timer recordings are programmed differently. *Details are on page 10.*
- Finish programming a timer recording at least five minutes before the recording is set to begin.
- 12 p.m. is noon; 12 a.m. is midnight.

There is no picture or the picture is noisy or contains streaks during video cassette tape playback.

- Put the DVD/VCR in VCR mode. Press the DVD/VCR OUTPUT button so that the green VCR light appears on the front of the DVD/VCR.
- Make sure the TV is on the same channel as the DVD/VCR's CH3/CH4 switch. Or, if you connected the DVD/VCR to the TV using audio and video cables, select the correct audio and video in channel at the TV. *Details are on page 12.*
- Make sure the DVD/VCR is in VCR position. Press the VCR/TV button so that the VCR/TV light appears on the front of the DVD/VCR.
- Make sure channel 03 or 04 is properly adjusted at the TV.
- Adjust the tracking. *Details are on page 45.*
- TVs placed too close to the DVD/VCR can cause interference during tape playback. Move the DVD/VCR away from the TV.

The Number buttons won't work for channels above 69.

- Enter channel numbers as a two-digit number. If you want to select channels 100 and above, enter channel numbers as a three-digit number. *Details are on page 30.*

TV programs cannot be watched normally.

- Put the DVD/VCR in VCR mode, then put it in TV position. Press the DVD/VCR OUTPUT button so that the green VCR light appears. Then, press the VCR/TV button so that the VCR/TV light disappears from the front of the DVD/VCR. *Details are on page 29.*
- Check the connections between the DVD/VCR, TV, antenna/cable, and Cable Box/Direct Broadcast System (if applicable). *Details are on pages 8-11.*

Tape cannot be inserted.

- Insert the tape, window side up, with the record tab facing you.
- Make sure a tape isn't already in the DVD/VCR by pressing the STOP/EJECT button on the DVD/VCR.
- Gently push on the center of the tape when putting it in the DVD/VCR. Never force the tape into the DVD/VCR.
- If a timer recording is programmed and the DVD/VCR is in standby mode for the timer recording, you can not insert a tape without a record tab.

Tape cannot be removed.

- Make sure the power plug is completely connected to a power outlet.
- You have set a timer recording. Press the TIMER SET button to temporarily cancel standby mode. Then, press the STOP/EJECT button on the DVD/VCR to eject the tape. Be sure to insert a tape and press the TIMER SET button to put the DVD/VCR in standby mode for the timer recording.
- Unplug the DVD/VCR power cord for five minutes. Then, plug in the power cord again, then press the POWER button on the DVD/VCR. If the tape does not eject, press the STOP/EJECT button on the DVD/VCR three to five times. If the tape still does not eject, you may need to have an authorized servicer remove the tape.

DVD/VCR ejects the tape when the RECORD button is pressed or when the TIMER SET button is pressed to set a timer recording.

- Make sure the tape has a record tab. *Details are on page seven.*

Poor reception

- You may need to tune your TV again.

The motor (cylinder) rotates even when the tape playback is stopped.

- To enable the quick play mechanism, the cylinder will rotate for about five minutes. This is normal. The quick play mechanism allows the tape mechanism to switch from Stop mode to Play mode in one second.

Direct Broadcast System Hookups

- Watching one TV channel while recording another may not be possible if you have a DBS hookup. You may have to set your TV to channel 03 or 04, then make your channel selections at the DBS.
- With many DBS hookups, if you use accessory audio and video cables to connect your DVD/VCR to your TV, you will have to put your DVD/VCR in Line Input mode (channel 001 or 002).

Line Input mode

- If you accidentally enter Line Input mode (AV FRONT or AV REAR will appear on your TV screen briefly), press the CHANNEL ▲/▼ buttons or use the Number buttons to select another channel.

Hi-Fi Stereo Sound

- During playback, Hi-Fi audio may temporarily revert to normal audio when you adjust tracking. This is normal.
- When connecting the DVD/VCR to a stereo TV, you will only get stereo sound if you use audio cables to connect the DVD/VCR AUDIO OUT jacks on the DVD/VCR to the AUDIO IN jacks on your TV, and if the TV is in Line (Auxiliary) Input mode.
- When you connect the DVD/VCR AUDIO OUT jacks on the DVD/VCR to the AUDIO IN jacks on your TV, the stereo light on the TV might not glow. But, as long as the status display indicates you are receiving a stereo signal, you are receiving a stereo signal. This is normal. *Details are on page 46.*
- Only tapes recorded in Hi-Fi audio will play back in Hi-Fi audio. Tapes recorded in normal audio will play back in monaural audio.

Cleaning the Video Heads

- Your DVD/VCR automatically cleans the video heads of the VCR each time you insert a tape. However, the heads may become dirty. If so, use a commercially-available head cleaner or have an authorized servicer clean the video heads. Eventually, the heads may need to be replaced.

The playback picture is too dim, too bright, or fluctuates in brightness.

- Some programs may be broadcast with copyright protection technology in order to protect the rights of copyright owners. This technology is used on programs that are recorded on video tapes or Digital Video Discs (DVDs), as well as some programs broadcast by antenna/cable/satellite television channels. Programs broadcast with copyright protection technology may not record clearly. Likewise, if you play a tape that is a recording of a copyright protected program, the picture may not be clear. Tapes of copyright protected programs may have a picture that is dark or dim, or the brightness of the picture may fluctuate. Therefore, you should avoid recording or playing copies of copyright protected programs. This DVD/VCR incorporates copyright protection technology that is protected by method claims of certain U.S. patents and other intellectual property rights owned by Macrovision Corporation and other rights owners. Use of this copyright protection technology must be authorized by Macrovision Corporation and is intended for home and other limited viewing uses only, unless otherwise authorized by Macrovision Corporation. Reverse engineering or disassembly is prohibited.

80 Limited Warranty

Digital Video Disc Player / Video Cassette Recorder Combination 90 days Free Exchange / 91 days–One Year Reduced-Cost Exchange

WHO IS COVERED?

You must have proof of the date of purchase to exchange your product. A sales receipt or other document showing the date that you purchased the product is considered such proof.

WHAT IS COVERED?

Warranty coverage begins the day you buy your product. For 90 days thereafter, you may exchange the defective product for a new or renewed product at the store from which it was purchased or through Philips. Either exchange is made at no cost to you.

From 91 days to one year from the date of purchase, you will pay a preset exchange fee to obtain a new or renewed product. Follow the exchange procedures on the next page. This exchange opportunity ends one year after the date of purchase. The replacement product is covered only for the warranty period of the original product. When the warranty on the original product expires, the warranty on all replaced products also expires.

WHAT IS EXCLUDED?

Your warranty does not cover:

- shipping charges to return defective product.
- labor charges for installation or setup of the product, adjustment of customer controls on the product, and installation or repair of antenna systems outside of the product.
- product repair and/or part replacement because of improper installation, abuse, neglect, misuse, accident, unauthorized repair or other cause not within the control of Philips Consumer Electronics.
- reception problems caused by signal conditions or cable or antenna systems outside the product.
- a product that requires modification or adaptation to enable it to operate in any country other than the country for which it was designed, manufactured, approved and/or authorized, or repair of products damaged by these modifications.
- incidental or consequential damages resulting from the product. (Some states do not allow the exclusion of incidental or consequential damages, so the above exclusion may not apply to you. This includes, but is not limited to, prerecorded material, whether copyrighted or not copyrighted.)
- damage caused by the use of non-VHS tapes or tapes that have not been tested and labeled for use in two, four, six, and eight hour VHS recorders.
- a product that is used for commercial or institutional purposes (including but not limited to rental purposes).

WHERE IS EXCHANGE AVAILABLE?

Warranty exchange is available in all countries where the product is officially distributed by Philips Consumer Electronics. In countries where Philips Consumer Electronics does not distribute the product, the local Philips service organization will attempt to exchange the product, although there may be a delay if the appropriate product is not readily available.

MAKE SURE YOU KEEP...

Please keep your sales receipt or other document showing proof of date of purchase. Attach it to the owner's manual and keep both nearby. Also keep the original box and packing material in case you need to return your product.

BEFORE EXCHANGING THE PRODUCT...

Please check your owner's manual before exchanging the product. Adjustments of the controls discussed there may save you time and money.

LIMITATION OF LIABILITY AND REMEDY...

Philips is not liable under any circumstances for any direct, indirect, special, incidental, or consequential damages, howsoever incurred, even if notified of the possibility of such damages.

To the extent permitted by local law, the remedies provided in this warranty statement are your sole and exclusive remedy.

This limited warranty gives you specific legal rights, and you may also have other rights which vary from state/province to state/province.

TO EXCHANGE YOUR PRODUCT IN THE U.S.A., PUERTO RICO, OR U.S. VIRGIN ISLANDS...

Follow the instructions stated previously in the "What is Covered" section, or refer to the exchange instructions on the next page.

In the U.S.A., Puerto Rico, and U.S. Virgin Islands, all implied warranties, including the implied warranties of non-infringement, merchantability and fitness for a particular purpose, are specifically disclaimed, and to the extent inconsistent with law of the locality of the user, limited in duration to the duration of this express warranty. Because some states do not allow limitations on how long an implied warranty may last, this limitation may not apply to you.

TO EXCHANGE A PRODUCT IN CANADA...

Please contact Philips at:

1-800-661-6162 (French Speaking)

1-800-363-7278 (English Speaking)

In Canada, this warranty is given in lieu of all other warranties. There are no other warranties, express or implied, including any implied warranties of merchantability or fitness for a particular purpose.

TO GET OUT-OF-WARRANTY EXCHANGE...

In the U.S.A., Puerto Rico, or U.S. Virgin Islands, contact Philips Service Solutions Group at 1-800-531-0039 to obtain the cost of out-of-warranty exchange.

REMEMBER...

Please record below the model and serial numbers found on the product. Also, please fill out and mail your warranty registration card promptly. It will be easier for us to notify you if necessary.

MODEL # _____
SERIAL # _____

Philips Service Solutions Group, P.O. Box 2976, Longview, Texas 75606, (903) 242-4800

EL6473E002 /3-01

Limited Warranty (cont'd) 81

EXCHANGE INSTRUCTIONS

If your product is defective, you may be able to exchange it at the store from which it was purchased. Most stores display a Return Policy. If not, ask the manager or sales associate how many days you have to exchange a product with them. After the store's return period has expired, or if the store does not have an exchange program, you may exchange the product with Philips if you have your original sales receipt.

To exchange your product with Philips (per the warranty conditions stated previously), remember:

- If you exchange the product within 90 days of the original purchase, there is no cost to you.
- If you exchange the product more than 90 days after but less than one year after the day of original purchase, contact Philips Service Solutions Group (PSSG) at 1-800-531-0039 to determine the preset cost for exchange.
- After 12 months from the day of original purchase, contact PSSG at 1-800-531-0039 for information regarding out-of-warranty exchange.
- If you do not have your original sales receipt, or if you have any questions, call PSSG at 1-800-531-0039.

To obtain a replacement product from Philips:

1. Contact PSSG at 1-800-531-0039 to determine the cost for exchange.
2. Complete the Exchange Form below.
3. Pack the product and its accessories in the original box or a suitable alternative. You will receive replacement accessories with your replacement product. For packing details, call 1-800-531-0039.
4. Put the completed Exchange Form, a copy of the original sales receipt, and the proper payment amount into an envelope. **DO NOT SEND CASH.** Do not staple or clip these items together. Label the envelope "Return Documents Enclosed." Place this envelope in the box with the product.
5. Seal the box with packing tape and return the product via United Parcel Service (UPS), insured and freight prepaid, to:

Philips Recovery Center
Rojas 6
12420 Mercantile Avenue
El Paso, TX 79928
ATTENTION: DVD/VCR COMBINATION EXCHANGE

A replacement will be sent to you via UPS within 48 business hours of Philips' receipt of the product.

EXCHANGE FORM

Your Address (street address to which replacement should be delivered, no P.O. boxes allowed):

Name: _____

Street Address: _____

Apt. #: _____

City: _____

State/Province: _____

Zip Code/Postal Code: _____

Phone (day): _____

Phone (night): _____

Exchange Fee: _____ **+ Sales Tax:** _____ **= Total:** _____

Method of Payment: (Check one. Please, no cash or CODs.)

_____ Check/Money order Check/Money order No. _____

	Account number	Expiration date
_____ American Express	_____	_____
_____ Visa	_____	_____
_____ Novus/Discover	_____	_____
_____ Mastercard	_____	_____

Signature: _____

Detailed reason for return, use additional paper if necessary: _____

Model Number _____ Serial Number _____

Remember, the return box should include the following:

- The product,
- Completed Exchange Form and sales receipt,
- Accessories supplied with the product, and
- Payment, if applicable.

82 Glossary

AUDIO IN/OUT Jacks: jacks located on the front and back of the DVD/VCR which are used to receive audio from another source (IN) or to send audio to another system (OUT).

Automatic Channel Setup: process in which the DVD/VCR memorizes all available TV channels. Then, when you press the CHANNEL ▲/▼ buttons, you only scan through channels you receive.

Bands: settings that allow you to tune channels.

- **Antenna** – VHF (very high frequency; channels 2-13) and UHF (ultra high frequency; channels 14-69).
- **Cable** – all standard channels can be received without a Cable Box.

Cable Box/DBS Output Channel: 03 or 04.

CD: Compact Disc (audio)

Coaxial jack: Used to send digital audio to a decoder or amplifier, allowing you to adjust the volume at the decoder or amplifier. This connection provides the 5.1 channel surround sound as heard in movie theaters.

COMPONENT VIDEO OUT Jacks: jacks located on the back of the DVD/VCR which are used to send high-quality video to a TV with Component Video In jacks.

Dolby Digital: A surround sound system that provides 5.1 channel sound as used in movie theaters.

DTS: Digital Theater Systems. This is a surround sound system, but it is different from Dolby Digital. The formats were developed by different companies.

Dubbing: copying a video cassette tape using another VCR.

DVD: Digital Video Disc.

Frame: a still picture.

HQ: high quality; a feature in the VCR circuitry which provides enhanced picture detail.

Line Input: The channel to which you set your DVD/VCR during video cassette tape dubbing. If you use the AUDIO and VIDEO In jacks on the front of the DVD/VCR, select channel 002 (AV FRONT). If you use the AUDIO and VIDEO IN jacks on the back of the DVD/VCR, select 001 (AV REAR). If you accidentally enter Line Input mode, press the CHANNEL ▲/▼ buttons or use the Number buttons to select another channel.

OPTICAL DIGITAL AUDIO OUT Jack: Converts electrical signals into optical signals before sending the audio to the amplifier. Optical audio is not prone to external electrical influences and has less noise, which reduces adverse effects on external equipment. Be sure to keep the protective cap on the jack when the jack is not being used. This keeps dust out of the jack.

OTR: One-Touch Recording; a timed recording on the VCR that starts immediately and records for 30 minutes to eight hours.

Remote Control: the small unit that came with your DVD/VCR; allows you to operate your DVD/VCR from a distance.

RF coaxial cable: A cable supplied with your DVD/VCR. Use it to connect your DVD/VCR to your TV (or Cable Box or DBS). The supplied cable is a snap-on type. However, you may use a screw-on type if you prefer.

Special Effects: forward and reverse searching; a still picture; slow motion playback.

S-Video: Produces a clearer picture by sending separate signals for the luminance and the color. If you connect an optional S-Video cable, you will not need to use the supplied yellow video cable.

Tape Speeds: how fast the video cassette tape travels during a recording or playback.

- **SP** (standard play) – fastest tape speed (recording time for a T120 tape is approximately two hours); best picture quality.
- **LP** (long play) – average tape speed; playback only.
- **SLP** (super long play) – slowest tape speed (recording time for a T120 tape is approximately six hours).

VCR: video cassette recorder.

VIDEO IN/OUT Jacks: jacks located on the front and back of the DVD/VCR which are used to receive video from another source (IN) or to send video to another system (OUT).

ac power cord	27	dolby digital decoder/ dts decoder	14	rf coaxial cable	9-11, 40, 46, 82
accessories	84	dolby surround compatible amplifier	14	safety precautions	3
angle button	31, 64	s-video	12	screen saver	50, 77
ant-in (antenna in) jack	8-14, 27	stereo	13	search buttons	86
ant-out (antenna out) jack	9-11, 27	tv	8-14	search mode/time search button	28, 43, 55-57
arrow buttons	31	with cable box/dbs	10-11	searching	44, 54
audio button	31, 62	with stereo tv	12	second audio broadcast receiving	46-47
audio cd	6	without cable box/dbs	8-9	recording	46-47
audio in/out jacks	12-13, 27, 40, 46	language (dvd)	70-72	sensor (remote)	26
automatic playback	45	language selection (vcr)	22	settings (dvd) audio	68-69
rewind, eject	45	line input mode	17, 40, 82	language	70-72
a-b repeat	59	long play	38, 82	other	74
a-b repeat button	29, 59	lp	38, 82	video	73
batteries	15	memory button	29, 42	setup button	28, 66-74
bit rate	68-69	menu button	29	skip/channel buttons	30, 55
blue background	49	menus	5, 51	slow button	30, 44
camera angle	64	mode button	30, 60-61	motion	44, 53
cassette compartment	25	number buttons	30	slp	38, 82
ch3/ch4 switch	8-11, 27	on-screen status displays (vcr)	23	sound mode	62
channel adding	18	on-screen display (discs)	65	sp	38, 82
deleting	18	one-touch recording	35	speed button	31
reviewing	19	open/close button	26, 50	sqpb	32
selection	30	optical jack	14, 27, 82	standard play	38, 82
setup	16-17	output button	26	status display (vcr)	23
▲/▼ buttons	26, 30, 45	parental lock	66-67	stereo broadcast receiving	46-47
chapters	6, 56	password	67	recording	46-47
clear button	30, 42, 60	pause button	30, 44, 52-53	hookups	46
clock setting	20	play button	26, 31, 32, 50	stereo TV hookups	12
coaxial jack	14, 27, 82	playing discs	50	still picture	44, 52
component video out jacks	13, 27, 82	playing tapes	32	stop button	28
connections	8-14	power button	26, 28	stop/eject button	26
contents, table of	4	cord	27	subtitle button	29, 63
controls dvd/vcr	26	light	25	super high speed searching	44
remote	28-31	program (audio cd)	60	super long play	38, 82
copyright protection	40, 79	random playback	61	s-video out jack	12, 27
counter only mode	23	real-time counter	42	table of contents	4
cst. in light	25	rear panel	27	tape duplication	40
daylight-savings time	21	record button	26, 31, 33, 35	eject	26, 45
display/status/exit button	23, 30, 65	record light	25	speed	38, 82
display panel	24-25	recording basic	33	timer recording cancelling	39
duplication	40	one channel/ watching another	34	checking	39
dvd button	28	prevention	7	setting	36-38
dvd video	6	timer	36-39	timer set button	26, 29, 38
dvd/vcr output button	28	remote control buttons	28-31	timer set light	25
enter button	29	sensor	26	title button	28, 51
ejecting a tape	79	using	15, 28, 30	titles	6, 51, 56
fast forward	44, 54	repeat button	29, 58	tracking	45
front panel	26	repeat play (tape)	41	tracks	6, 55
f.fwd button	26, 31, 44, 53, 54	repeat playback (discs)	58	tv hookups	8-14
glossary	82	rerecording	40	tv position	25, 29, 34
head cleaner	7, 79-81	resuming play	52	vcr position	25, 29
helpful hints	76-79	return button	28	vcr/tv button	29
hi-fi stereo sound system	48	reverse searching	44, 54	vcr/tv light	25
hookups amplifier with digital in jacks/ md deck/dat deck	14	rew(ind) button	26, 28, 44, 54	video in/out jacks	12, 14, 26-27, 40, 46

SUPPLIED ACCESSORIES

The following items are supplied with your DVD/VCR; they are provided to help you use or set up your DVD/VCR.

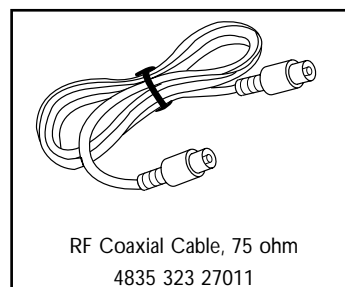
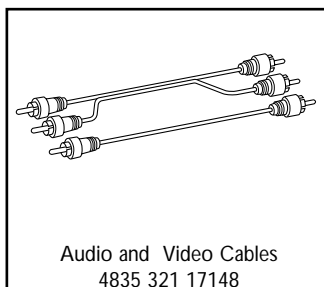
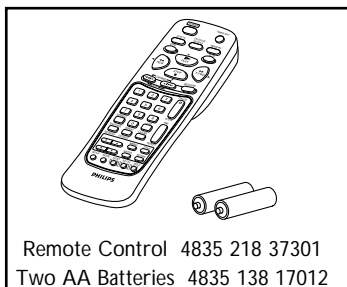

OPTIONAL ACCESSORIES

The following additional items are not provided with your DVD/VCR, but they are designed for use with your new DVD/VCR. To order these optional accessories, contact us at:

Philips Parts & Accessories Marketing Department
401 East Old Andrew Johnson Highway
P.O. Box 555
Jefferson City, TN 37760
1-800-851-8885.

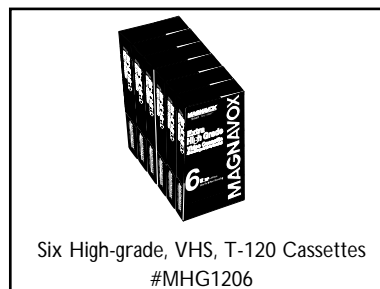
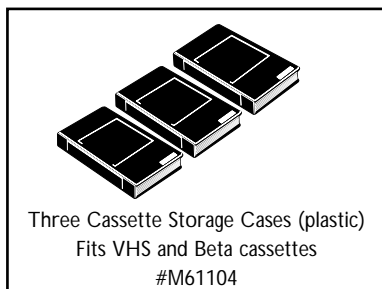

This owner's manual is made of recyclable materials.
Remember to recycle!

IB8251E004
Printed in China
0VMN02575 / H9000UD * *

Free Manuals Download Website

<http://myh66.com>

<http://usermanuals.us>

<http://www.somanuals.com>

<http://www.4manuals.cc>

<http://www.manual-lib.com>

<http://www.404manual.com>

<http://www.luxmanual.com>

<http://aubethermostatmanual.com>

Golf course search by state

<http://golfingnear.com>

Email search by domain

<http://emailbydomain.com>

Auto manuals search

<http://auto.somanuals.com>

TV manuals search

<http://tv.somanuals.com>