

Video Cassette Recorder

VR407/55
VR607/55

Instructions for use



PAL



PHILIPS

Congratulations on purchasing your new VCR. Spare a few moments to read this instruction manual to get better results, and to avoid any costly mistakes.

WARNING : DANGEROUS VOLTAGE INSIDE
WARNING : TO PREVENT FIRE OR SHOCK HAZARD, DO NOT EXPOSE THIS UNIT TO RAIN OR MOISTURE.

- The POWER button does not completely shut off the mains power from the unit, but switches operating current on or off only.
- The rating plate is on the rear of the unit.

When the equipment is installed in a cabinet or a shelf, make sure that it has sufficient space on all sides to allow for ventilation (10 cm or more on both sides, on top and at the rear.)

When discarding batteries, environmental problems must be considered and the local rules or laws governing the disposal of these batteries must be followed strictly.

Failure to heed the following precautions may result in damage to the VCR, remote control or video cassette.

1. **DO NOT place the VCR . . .**
 - ... in an environment prone to extreme temperatures or humidity.
 - ... in direct sunlight.
 - ... in a dusty environment.
 - ... in an environment where strong magnetic fields are generated.
 - ... on a surface that is unstable or subject to vibration.
2. **DO NOT block the VCR's ventilation openings or holes.**
(If the ventilation openings or holes are blocked by a newspaper or cloth, etc., the heat may not be able to get out.)
3. **DO NOT place heavy objects on the VCR or remote control.**
4. **DO NOT place anything which might spill on top of the VCR or remote control.**
(If water or liquid is allowed to enter this equipment, fire or electric shock may be caused.)
5. **DO NOT expose the apparatus to dripping or splashing.**
6. **DO NOT use this equipment in a bathroom or places with water. Also DO NOT** place any containers filled with water or liquids (such as cosmetics or medicines, flower vases, potted plants, cups, etc.) on top of this unit.
7. **DO NOT place any naked flame sources, such as lighted candles, on the apparatus.**
8. **AVOID violent shocks to the VCR during transport.**

Safety Precaution

Features

- SmartPicture
- Child Lock
- Automatic Operations
- Index Search
- One Touch Recording
- On Screen Display
- Timer Recording

Let's make things better

Description of Controls

Front panel

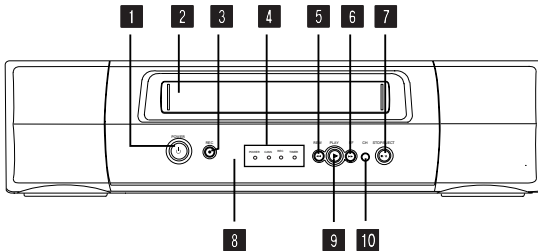

- 1 POWER button (☞P.13)
- 2 Cassette Compartment
- 3 REC ● button (☞P.8, P.11)
- 4 Display Window (see below)
- 5 ◀◀ REW/CH- button (☞P.4, P.5, P.8, P.10, P.12)
- 6 ▶▶ FF/CH+ button (☞P.4, P.5, P.8, P.10, P.12)
- 7 STOP/EJECT ■/▲ button (☞P.4, P.8, P.10)
- 8 IR (infrared) remote sensor
- 9 PLAY ► button (☞P.8, P.9, P.10)
- 10 CH button (☞P.5, P.6, P.8, P.9, P.14)

Rear panel

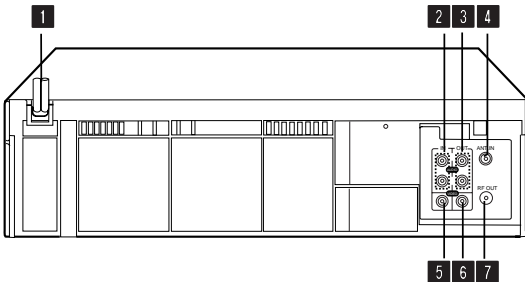

- 1 AC power cord
- 2 AUDIO IN (input) jacks (☞P.4, P.14)
- 3 AUDIO OUT (output) jacks (☞P.4, P.14)
- 4 ANT. (antenna) IN (input) terminal (☞ P.4)
- 5 VIDEO IN (input) jacks (☞P.4, P.14)
- 6 VIDEO OUT (output) jack (☞P.4, P.14)
- 7 RF OUT (output) terminal (to TV) (☞P.4)

Note:
VR407/55 has single AUDIO IN/OUT jack.

Display Window

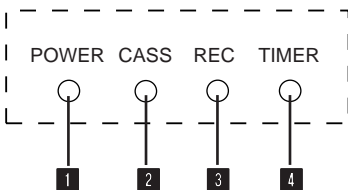

- 1 POWER indicator
- 2 CASS(ette) indicator
- 3 REC(ording) indicator
- 4 TIMER indicator

On- Screen Display

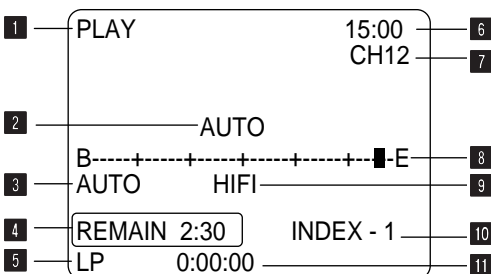

- 1 Operation mode
- 2 SmartPicture Setting
- 3 Colour Mode
- 4 Remaining tape length
- 5 Tape Speed
- 6 Current Time
- 7 Channel Number
- 8 Tape position indicator
- 9 Sound output mode (for VR607/55 only)
- 10 Index Number
- 11 Time counter

Remote Control

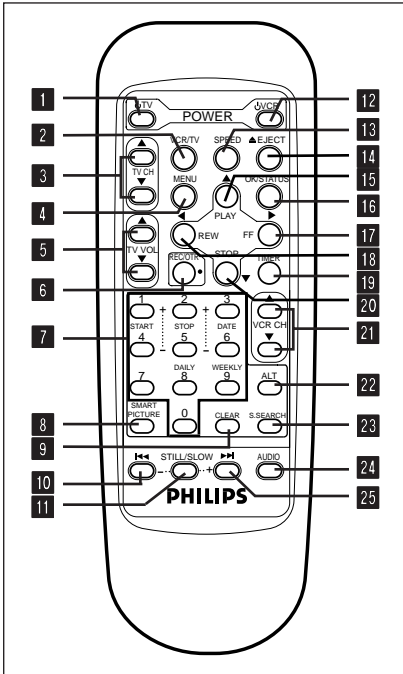

Buttons **1**, **3**, **5**, and **22** can be used to operate some of PHILIPS TVs. Button **22** is used to go back to the previously selected channel on TV.

To insert the batteries:

Install two AA batteries R6 (SUM-3)/AA - matching the polarity indicated inside the battery compartment.

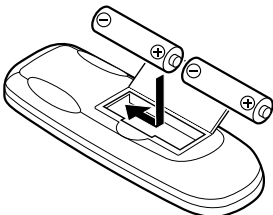

- 1** TV (POWER) button
- 2** VCR/TV button (≈P.7)
- 3** TV CH (channel) ▲ / ▼ button
- 4** MENU button
- 5** TV VOL (volume) ▲ / ▼ buttons
- 6** REC (record)/OTR ● button (≈P.8, P.11, P.14)
- 7** NUMBER buttons (0, 1, 2, 3, 4, 5, 6, 7, 8 and 9) (≈P.12, P.13)
- 8** SMARTPICTURE button (≈P.12)
- 9** CLEAR button (≈P.14)
- 10** STILL/SLOW - / ◀◀ button (≈P.8)
- 11** STILL/SLOW button (≈P.8, P.9)
- 12** VCR (POWER) button (≈P.13)
- 13** SPEED button (≈P.7, P.13)
- 14** ▲ EJECT button (≈P.8)
- 15** PLAY / ▲ button (≈P.8)
- 16** OK/STATUS button
- 17** FF ▶▶ button (≈P.8)
- 18** REW / ◀ button (≈P.8)
- 19** TIMER button (≈P.13)
- 20** STOP / ▼ button (≈P.8)
- 21** VCR CH (channel) ▲ / ▼ button (≈P.6, P.9, P.12, P.13)
- 22** ALT button
- 23** S.(Skip) SEARCH button (≈P.9)
- 24** AUDIO button (VR607/55 only) (≈P.11)
- 25** STILL/SLOW + / ▶▶▶ button (≈P.8)

CAUTION

On Battery Replacement

Do not mix old and new batteries. (Also never mix alkaline batteries with manganese batteries.)

Getting Connected Up

VCR to TV Connection Using RF Cable

- 1 Disconnect the antenna or cable from the TV.
- 2 Connect the antenna or cable to the ANT. IN terminal on the back of the VCR.
- 3 Connect the VCR to the TV using the RF coaxial cable.
- 4 Plug the AC power cords of the VCR and TV into the AC outlets.

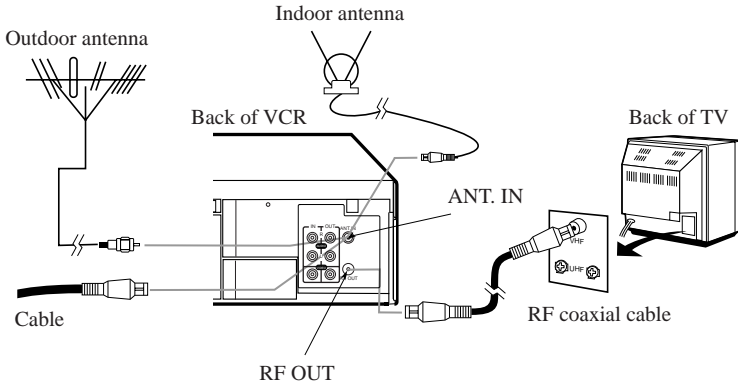

CAUTION

Do not plug the AC power cords until all connections are completed.

Note:

VR407/55 has single AUDIO IN/OUT jack.

To watch a picture from this VCR on the TV, select UHF E36 channel (video channel of this VCR when shipped from the factory).

If you want to change video channel, see "Setting the Video Channel." (P.5)

VCR to TV Connection Using AUDIO/VIDEO Cable

If your TV has audio/video connectors, complete the connection below to get better pictures and sounds when playing back a tape. To watch a picture from this VCR on the TV, select the AV mode on the TV.

Note:

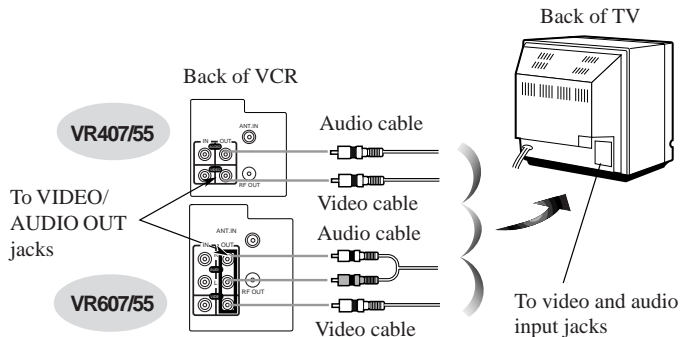

Even if you are using this AV connection, you must also complete the RF connection above.





Setting Up

Setting the Video Channel

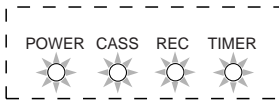

This VCR is designed to send picture and sound signal on UHF channel E36 (between E28 to E60) to the TV, through the RF coaxial cable.

- 1 Make sure the VCR is turned off and no cassette is inserted.
- 2 Press STOP/EJECT  /  on the front panel for more than 5 seconds. All four indicators on the display window will blink.



- 3 Press PLAY  or STOP  on the remote control to select the TV system. The indicators represent the TV system as described in the table below.

TV System	Country	Indicator			
		POWER	CASS	REC	TIMER
B/G	West Europe, ASEAN countries, New Zealand	blink	blink	blink	blink
D/K	China, Russia, East Europe	blink	blink	blink	off
I	Hong Kong, South Africa, United Kingdom	blink	blink	off	off

- 4 Press OK/STATUS.
- 5 Turn on the TV, and tune it to UHF channel E36.
 - If two vertical white bars appear clearly on the TV screen, press OK/STATUS and go to step 6.
 - If the two vertical white bars do not appear clearly, press PLAY  or STOP  on the remote control to set the video channel to any vacant channel between channel 28 to 60.
 - The indicators tell channel position. The indicators light and blink at different speed by the channel position as shown in the table in the next column. The POWER indicator blinks and the REC indicator lights up regardless of the channel number.

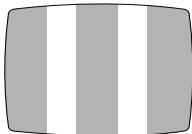

Test signal
(two vertical white bars)

- 6 Press OK/STATUS. The CASS and TIMER indicator will turn off. You will now enter the Language Setting mode explained on the next column.

CHANNEL	CASS indicator	TIMER indicator	Blinking Speed
60		light	fast
51 - 59		blink	↑
50		light	
41 - 49		blink	
40		light	
37 - 39		blink	slow
36	light	light	—
31 - 35	blink		slow
30	light		↓
29	blink		
28	light		fast



To watch a picture from this VCR on the TV, select the same channel you have selected as the video channel on the TV.



Note:

If you use only external video input (AV) mode to watch the picture from this VCR, you can turn off the video channel output. To turn off the video output channel, press VCR CH  until CASS and TIMER indicators on the display window are off.

Menu Operations

Before operating the VCR, be familiar with the menu operations first because most of the features built into the VCR can be available only on the menus.



- 1 Press MENU to display the main menu screen.
- 2 Press PLAY  or STOP  to select a desired feature on the menu, then press OK/STATUS.
- 3 When you select a feature, go to the section in this manual and follow the instructions described there.

To go back to the previous menu screen, press REW . To change the setting of a menu item, press FF . Press MENU to exit.

Initial Set Up

For the first time you turn on this VCR, some basic settings must be done first before going on to further operations.

1 Select the Language

- 1 Press POWER. The language selection screen appears.
- 2 Press PLAY  or STOP  to select either "ENGLISH", or "中文" (Chinese).
- 3 Press OK/STATUS.

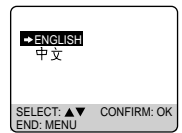

To Reset the Channels

If you want to re-do the channel setting, follow the procedure below;

- 1 Press MENU.
- 2 Press PLAY ▲ or STOP ▼ to select "TUNER SET UP" then press OK/STATUS.
- 3 Press PLAY ▲ or STOP ▼ to select "AUTO TUNER SET UP" then press OK/STATUS.
- 4 Press PLAY ▲ or STOP ▼ to select the appropriate TV system [(BG, DK, I)] of your residential area.
- 5 Press OK/STATUS. Auto programming starts. When it ends, programmed channels, frequencies and TV systems are shown on the display.
- 6 Press MENU to exit.

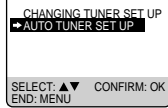
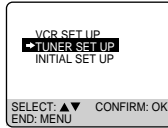

To Delete or Edit Receivable Channels

- 1 Press MENU.
- 2 Press PLAY ▲ or STOP ▼ to select "TUNER SET UP", then press OK/STATUS.
- 3 Press PLAY ▲ or STOP ▼ to select "CHANGING TUNER SET UP", then press OK/STATUS.

The programmed channel information list appears.

CH	FRO	SYS	CH	FRO	SYS
01	150	BG	07	229	BG
02	165	BG	08	237	BG
03	195	BG	09	355	BG
04	205	BG	10	365	BG
05	213	BG	11	374	BG
06	221	BG	12	384	BG

SELECT: ▲▼ DELETE: CLEAR
CHANGE CH: OK
END: MENU

- 4 Press PLAY ▲ or STOP ▼ until the desired channel setting flashes.

4.1: TO DELETE UNWANTED CHANNELS:

Press CLEAR. Repeat this step until you delete all unwanted channels.

* If you have accidentally deleted a channel, press REW ◀.

4.2: TO EXCHANGE CHANNEL POSITION:

Press OK/STATUS **once** so that the channel number flashes. Using the number button on the remote control, enter the other channel number that you want to exchange with, then press OK/STATUS.

4.3: TO FINE-TUNE CHANNELS

Press OK/STATUS **twice** so that the frequency indication flashes. Press PLAY ▲ or STOP ▼ to fine-tune the station until you get the best possible picture, then press OK/STATUS.

4.4: TO CHANGE THE TV SYSTEM:

This is necessary if no sound comes out on the channel.

Press OK/STATUS **three times** so that the TV system indication flashes. Press PLAY ▲ or STOP ▼ to select the appropriate TV system (BG, DK, I) so that the sound comes out, then press OK/STATUS.

- 5 Press MENU to exit.

Manual Channel Setting

- 1 Repeat steps 1-3 of "To delete or edit receivable channels" on the left column.
- 2 Press PLAY ▲ or STOP ▼ until a vacant channel in which you want to store a new channel starts flashing, then press OK/STATUS.
- 3 Press PLAY ▲ or STOP ▼ to select the search starting band, then press OK/STATUS.

VHF L: Starts searching from the VHF L band.

VHF H: Starts searching from the VHF H band.

UHF: Starts searching from the UHF band.

Searching starts, and when a station is tuned in, searching stops and the tuned frequency is shown on the TV.

- 4 Press PLAY ▲ or STOP ▼ to select "STORE CHANNEL", then press OK/STATUS.

The programmed channel information list appears again with the settings of the newly tuned channel flashing.

If you do not want to store the channel, select "CONTINUE SEARCH", then press OK/STATUS so that the search starts again.

- 5 Press MENU to exit.



Basic Operations

Playback

1 On TV

- 1 Turn on the TV.
- 2 Select the video channel (or AV mode).

2 On VCR

Insert a cassette. The VCR turns on.

- If the record tab on a cassette is removed, playback will start automatically.
- If a cassette is already in the VCR, turn on the VCR.

3 Start Playback

Press PLAY.

To pause playback and view still picture, **press STILL/SLOW.**

Press PLAY to resume playback.

To rapidly locate a particular scene
Press FF (or ►► FF/CH+ on the front panel) or
REW (or ◀◀ REW/CH- on the front panel)
during playback.

(No sound comes out.)

Press PLAY to resume playback.

To stop playback,

Press STOP (or STOP/EJECT ■/▲ on the front panel)

To rewind the tape,

Press REW (or ◀◀ REW/CH- on the front panel)
when the tape is not running.

To fast forward the tape,

Press FF (or ►► FF/CH+ on the front panel) when
the tape is not running.

To eject the tape,

Press ▲ EJECT (or STOP/EJECT ■/▲ on the
front panel).

To turn off the VCR,

Press ⏻ VCR (or POWER on the front panel).

1 On TV

- 1 Turn on the TV.
- 2 Select the video channel (or AV mode).

2 On VCR

Insert a cassette with the record tab in place.

The VCR turns on.

To rewind the tape, press REW ◀.

To reset time counter, press CLEAR.

3 Select Tape Speed

Press SPEED until the desired tape speed (SP or
LP) appears on the screen.

4 Select a Channel

Press CH ▲/▼ or Number buttons to select the
channel to record.

5 Start Recording

Press REC/OTR ●.

To pause recording

**Press STILL/SLOW briefly. To resume
recording, press the same button again.**

To stop recording

Press STOP .

To watch another TV programme while record-
ing

**Select a different channel you want to
watch on the TV.**

**You can watch the programme of the
selected channel on the TV, without
affecting recording on the VCR.**

- When a tape reaches its end during recording, the
recording stops and CASS indicator blinks on the
display window.

Recording

When using this VCR, an index mark is always
marked at the beginning of every recording. This
index marks make it easier for you to search for the
beginning of the recordings. See Index Search on
page 9.

To prevent accidental erasure:

Break off the record tab with a
screwdriver.

To record again, cover the hole
with adhesive tape.

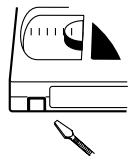

Advanced Operations

Special Effect Playbacks

Are you familiar with tape playback? If so, you are ready to enjoy the special effect playback features described below.

To skip playback for a certain period

Press **S**. **SEARCH** button 1 to 4 times during playback to search forward for 30 seconds by the time counter reading.

Each time you press the button, the search time increases as follows:

30→60→90→120 sec.

The VCR automatically resumes normal playback after searching for the specified period.

To view a still picture

Press **STILL/SLOW** briefly during playback.

Playback is frozen and a still picture appears.

Press the **STILL/SLOW** button repeatedly to advance the still picture frame by frame.

To resume playback, press **PLAY**.

To view a slow motion picture

Press **STILL/SLOW** for more than 2 seconds during playback.

To decrease the forward slow motion speed, press **STILL/SLOW -**.

To increase the slow motion speed, press **STILL/SLOW +**.

To resume playback, press **PLAY**.

Notes:

- No sound comes out during special effect playbacks.
- If you keep viewing slow motion and still pictures for more than 5 minutes, the VCR automatically stops to protect the tape and video heads.
- During special effect playbacks, some noise bars will appear on the TV screen.

Tracking Adjustments

Auto tracking

Each time a tape is inserted, auto tracking starts working and continuously analyses the signal to adjust for optimum picture quality during playback. So, there is no need for you to minimize noises in most tapes during playback.

Manual tracking

- **During normal playback:**
If auto tracking cannot eliminate noises well during playback, press **VCR CH ▲/▼**.
- **During a slow motion picture:**
Press **VCR CH ▲/▼** to minimize noises in the slow motion picture.
- **During a still picture:**
Press **VCR CH ▲/▼** to reduce jitter in the still picture.

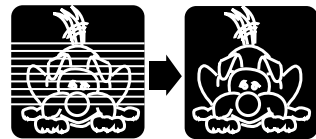

To cancel manual tracking, stop the tape, eject the tape, then re-insert it.

Note:

If you keep pressing **VCR CH ▲/▼** button, you might get “USE CLEANING CASSETTE” message on the screen. Please disregard this message and re-adjust the tracking. However, if the message appears automatically (without pressing **VCR CH ▲/▼**), this indicates that your video heads are dirty.

Index Search

You can locate an index marked at the beginning of each recording on a tape recorded on this VCR (or an indexed tape).

Press **▶▶|** or **|◀◀** repeatedly until the appropriate number is displayed on the TV screen before starting play.

Rapid forward or reverse search begins.

When it finds the designated index, playback starts automatically.

- Locate an index number by pressing the button repeatedly, indicating how many index marks ahead of or behind that recording you want is from the tape's current position.
- Up to ±9th index mark from the current position on the tape can be located.

Automatic Operations

Eject cassette

You can eject the tape simply by pressing STOP/EJECT ■/▲ on the front panel even while the VCR is turned off.

When you press STOP/EJECT ■/▲ on the front panel, the VCR automatically turns on, ejects the tape, then turns off.

Auto playback

When a tape is inserted, the VCR turns on. If the record tab is removed, playback begins.

Auto rewind

When a tape reaches its end during playback or fast forwarding, the VCR rewinds the tape and stops.

Memory rewind power off

When you press POWER during rewinding, the VCR turns off after rewinding is completed.

Repeat Playback

When you press and hold PLAY ► for more than 5 seconds, you can play back the same tape repeatedly (100 times).

When the tape runs to its end, the VCR automatically rewinds the tape, and starts playback.

Child Lock

With this function, you can prevent the VCR operations from being misused.

To use Child Lock

When the VCR is turned on, press and hold POWER on the remote control for more than 10 seconds to turn off the VCR.

The POWER indicator will blink on the display window.

While POWER indicator on the display window is blinking, you cannot turn on the VCR by pressing POWER on the VCR.

To cancel Child Lock

Press and hold POWER on the remote control for more than 10 seconds to turn on the VCR.

The POWER indicator on the display window will stop blinking and the VCR is turned on.

You can also cancel the child lock function by unplugging the AC power cord.

SmartPicture

You can make the picture softer or sharper or distinct the picture when playing back the tape. SmartPicture is set to AUTO when you receive the VCR.

1 Select SmartPicture Mode

- 1 Press SMARTPICTURE button. The current setting will appear on the screen for about 5 seconds.

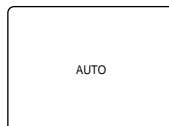

- 2 While the current setting appears, press the SMARTPICTURE button repeatedly, the setting changes as follows.

AUTO:

Normally select this mode.

DISTINCT:

Select this mode when you want the distinct picture. The picture detail is emphasized.

SOFT:

Select this mode when you want the soft picture. The signal noise of the picture is softened.

SHARP:

Select this mode when you want the sharp picture. The picture edge is emphasized.

Note:

- It is recommended that the SmartPicture is set to "SOFT" if playback picture is noisy.

Selecting Monitor Sound

(For VR607/55 only)

If you want to change the sound you listen to while playing back a HiFi stereo or bilingual tape, press **AUDIO** repeatedly.

Each time you press the button, the sound changes as follows:

HiFi stereo → HiFi left channel → HiFi right channel → Monaural sound on normal audio track.

HIFI:

Normally select this mode.

You can play back a HiFi tape in HiFi stereo mode and monaural tape in monaural mode.

HIFI L:

Select this mode when you want to play back the sound recorded on HiFi left channel (usually main language) of a bilingual programme.

HIFI R:

Select this mode when you want to play back the sound recorded on HiFi right channel (usually sub-language) of a bilingual programme.

NORMAL MONO:

Select this mode when you want to play back the sound recorded on the normal audio track of the tape.

Note:

- The connections described in "VCR to AV TV Connection" (*P.4) are required for HiFi stereo playback.

One Touch Recording (OTR)

The OTR function lets you quickly specify how long you want a recording to continue. You do not have to programme the timer.

Make sure....

- The record tab on the cassette is not removed.
- Your VCR, TV and antenna are connected correctly.

1 On TV

- Turn on the TV.
- Select the video channel (or AV mode).

2 On VCR

Insert a cassette with the record tab in place.

The VCR turns on.

- If a cassette is already in the VCR, turn on the VCR.

3 Select Channel

Press **CH ▲/▼** or **Number** buttons to select the channel to record.

- You can also use the **◀◀ REW/CH-** and **▶▶ FF/CH+** on the front panel. However, press **CH** before pressing these buttons.

4 Start OTR

Press **REC/OTR ●** twice.

Recording starts immediately, and the **REC** indicator will blink on the display.

This indicates that the VCR will automatically shut off after 30 minutes of recording.



5 Select Recording Length

Press **REC/OTR ●** repeatedly until the desired recording length appears.

Each time you press the button, recording length increases in 30-minute intervals.

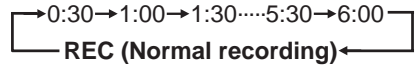

To check time remaining during an OTR

Press **OK/STATUS**.

To change the recording length during an OTR

Press **REC/OTR ●** repeatedly until the desired length appears.

To cancel an OTR

Press **STOP ■** to stop recording before the preset recording length is reached. If you want to cancel the OTR mode but continue recording, press **REC/OTR ●** several times until "OTR" changes to "REC" on the TV screen.

Notes:

- During recording, the displayed time counts down. When "0:00" is reached, recording stops and the VCR turns off automatically.
- If an OTR is engaged during pause, the displayed time counts down normally, but recording does not begin until you cancel the pause.

Using On-Screen Display

You can display the VCR operating status on the TV screen.

1 Select VCR Set Up Mode

- 1 Press VCR.
- 2 Press MENU.
- 3 Press PLAY ▲ or STOP ▼ to select "VCR SET UP" then press OK/STATUS.

2 Select On-Screen Mode

- 1 Press PLAY ▲ or STOP ▼ to select "ON SCREEN MODE".
- 2 Press FF ►. Each time you press the button, the setting changes.

ON:

When you press a tape running button (Stop, Play, etc.), the VCR status appears for 5 seconds.

COUNTER:

When you press a tape running button, the VCR operating status appears for 5 seconds. After 5 seconds, the VCR status disappears except the time counter.

OFF:

The VCR operating status does not appear even if you press a tape running button.

3 Finish Setting

Press MENU.

To display the VCR status on the TV screen manually, press OK/STATUS. The VCR status appears for about 5 seconds.

- If "ON SCREEN MODE" is set to "OFF," no VCR status appears though you press OK/STATUS.

Timer Recording

To record while you're away, follow step 1 — 9 below.

FOR EACH STEP BELOW, YOU NEED TO FINISH WITHIN 60 SECONDS; OTHERWISE, PROGRAMMING WILL HAVE TO BE RESTARTED FROM STEP 1.

1 Select Timer Mode

Press TIMER. The Timer Recording menu appears.

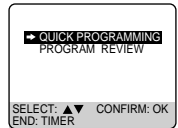

2 Select Programme mode

Press PLAY ▲ or STOP ▼ to select "QUICK PROGRAMMING", then press OK/STATUS. The Quick Programming menu appears.

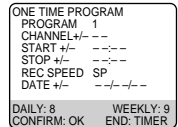

- If you have already set 8 programmes, "ALL PROGRAMS IN USE" appears and goes back to the Timer Recording menu. If this happens, delete unwanted programmes.

3 Select Channel

Press VCR CH ▲ or ▼ to enter the TV channel.

- You can also use the ◀◀ REW/CH- and ►► FF/CH+ on the front panel. However, press CH before pressing these buttons. Otherwise, it functions as REW or FF.
- Holding down VCR CH ▲ or ▼ rapidly scans through the channels.
- To record from external line input, press VCR CH ▲ or ▼ until "A/V REAR" appears on the TV screen.

4 Select Start Time

Press START + or - (Number button 1 or 4).

- Each time you press the button, the set time changes by one-minute intervals. If you hold the button, the set time changes by 30-minute intervals.

5 Select Stop Time

Press STOP + or - (Number button 2 or 5).

- Each time you press the button, the set time changes by one-minute intervals. If you hold the button, the set time changes by 30-minute intervals.

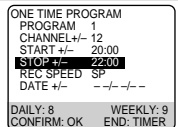

6 Select Tape Speed

Press **SPEED**.

- Each time you press the button, the tape speed alternates between SP or LP.

7 Select Start Date

Press **DATE +** or **-** (Number button 3 or 6).

- The year and day of the week are displayed automatically.

8 Confirm Programme

Press **TIMER** or **OK/STATUS**.

“PROGRAM WAS COMPLETED” appears on the TV screen.

After 5 seconds, the above message disappears, and the normal TV picture resumes. The **TIMER** indicator lights up on the display.

- If “PROGRAM NOT COMPLETED” appears, try again from step 1.
- If “PROGRAM NOT COMPLETED/PROGRAM OVERLAP” appears on the TV screen, the timer recording you just programmed overlaps another timer recording. See next column for details.

If you want to store other programmes, repeat steps 1 to 8.

9 Finish Settings

Press **VCR** (or **POWER** on the front panel) to turn off the VCR.

The VCR must be turned off for a timer recording to take place. If you forget to turn off the VCR, **PLEASE TURN OFF VCR FOR TIMER RECORDING** flashes on your TV screen two minutes before a timer recording starts. To remove the message, press the **CLEAR** button.

If you want to record the same programme daily, press **DAILY** (Number button 8) during step 3 through 7. (Press the button again to cancel.)

The VCR will record a TV programme every day (Monday through Friday) at the same time and length. (Daily Recording)

If you want to record the same programme weekly, press **WEEKLY** (Number button 9) during step 3 through 7. (Press the button again to cancel.)

The VCR will record a TV programme once a week at the same day, time and length. (Weekly Recording)

If you want to cancel the currently set programme, press **CLEAR**.

After a timer recording has taken place

Press **VCR** (or **POWER** on the front panel) to turn on the VCR. You can operate your VCR normally.

To stop a started timer recording
Press **VCR** (or **POWER** on the front panel).

Recording stops and the VCR turns off.

If it is a Daily or Weekly Recording, future recordings will be carried out as programmed.

When two programs overlap

The Program Review screen will appear with a magenta line blinking on the newly set timer recording while the other overlapped program blinking.

- 1 Press **PLAY** ▲ or **STOP** ▼ to move the magenta line among the two overlapping programs.

- 2 Press **OK/STATUS** to view the detail information of the program you want to change.

- 3 Go to step 4 through 8 to modify the selected program. To cancel any timer recording, press **CLEAR**.

- If you do not modify the overlapping programs, the VCR will record the earlier program completely. Only the remaining part of the later program will be recorded.
- If the **START** time for the two programs are the same, the lower program number will be recorded.

PR	CH	START	STOP	DATE
1	12	20:00	22:00	20/07
2	20	11:00	11:30	15/10
3	24	15:00	16:00	10/08
4	45	21:00	23:00	FRI
5				
6				
7				
8				

ONE TIME PROGRAM	
PROGRAM	1
CHANNEL +/-	12
START +/-	20:00
STOP +/-	22:00
REC SPEED	SP
DATE +/-	20/07/01
	FRIDAY
ERASE: CLEAR	
NEXT: OK	END: TIMER

Useful function for Timer Recording:

Auto Tape Speed

With this function activated, the VCR can change the tape speed and record the programme in LP mode if not enough tape remains for recording in SP mode.

- 1 Press **MENU**.
- 2 Press **PLAY** ▲ or **STOP** ▼ to select “VCR SET UP” then press **OK/STATUS**.
- 3 Press **PLAY** ▲ or **STOP** ▼ to select “TIMER REC SPEED.”
- 4 Press **FF** ►.

Each time you press the button, the setting changes.

AUTO:

Select this to allow the VCR to change the tape speed from SP to LP when there is not enough tape length remaining.

MANUAL:

Select this not to allow the VCR to change the tape speed.

- 5 Press **MENU** to exit from the menu operations.

To check, edit or erase the programmes

- 1 Press **TIMER**.
- 2 Press **PLAY ▲** or **STOP ▼** to select "PROGRAM REVIEW" then press **OK/STATUS**.
- 3 Press **OK/STATUS** repeatedly to view the more detailed programme information.

- When you press the button for the first time, the detailed programme information for Programme 1 appears. By pressing this button repeatedly, you can review the detailed information of all other programmes.

- 4 If you want to change the programme setting shown on the TV screen, press the following buttons:

- VCR CH ▲/▼ : Changes the channel.
- START +/- : Changes the start time.
- STOP +/- : Changes the stop time.
- SPEED : Changes the tape speed.
- DATE +/- : Changes the date.

If you want to erase the programme setting shown on the TV screen, press **CLEAR**. The detailed information of the next programme appears.

- 5 If necessary, press **TIMER** to exit from the menu operations.

Note:

- This function does not work for OTR (One Touch Recording).

How to see the programme list

- ① Programme numbers
- ② Preset channel numbers
- ③ Start time
- ④ Stop time
- ⑤ Start date

	①	②	③	④	⑤
	PR	CH	START	STOP	DATE
1	12	20:00	22:00	W10/06	
2	25	10:00	10:45	MON	
3	03	15:00	15:15	D16/10	
4	45	23:30	23:00	DAILY	
5					
6					
7					
8					
	NEXT: OK			END: TIMER	

"D" stands for "DAILY," and "W" stands for "WEEKLY."

- If the programme has worked once for the Daily recording, "DAILY" will be shown instead of the start date.
- If the programme has worked once for the Weekly recording, the day of the week (in this example, "MON") will be shown instead of the start date.

Note:

- Even if a power failure occurs, the VCR keeps your timer programs. However, the clock time and other menu settings are lost if it lasts for more than 3 minutes. As a result, when the power is supplied again to this VCR after the power failure, set the clock time and turn off the VCR.

Each timer program you have made will start unless its start time already passes.

Tape Duplication

Dubbing from any VCR (or camcorder) to another is simple.

Explanations on this page uses this VCR as the recording VCR.

Refer also the manual supplied with the other VCR (for playback)

- 1 **Connect the recording VCR (this VCR) and the playing VCR.**
- 2 **Connect the recording VCR (this VCR) to the TV.**

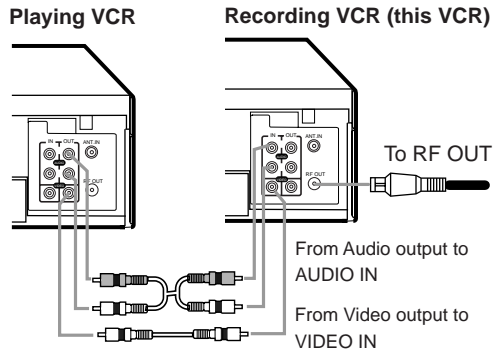

Note:

VR407/55 has single AUDIO IN/OUT jack.

- 1 Insert a source tape in the playing VCR and a blank tape in the recording VCR.
 - If a tape without the record tab is inserted in the playing VCR, playback automatically starts. In this case, press the STOP button.
- 2 Turn the channel on the TV to your video channel.
- 3 Press **VCR CH ▲** or **▼**, pointing the remote control at this VCR, to select the external line input. Select "AV IN" on the TV screen.
- 4 Press **SPEED**, pointing the remote control at this VCR, until the desired tape speed (SP or LP) appears on the screen.
- 5 Press the **PLAY ►** button on the playing VCR.
- 6 Press **REC/OTR ●** at this VCR.

Remember: Press the buttons in steps 5 and 6 simultaneously to avoid missing any of the recording.

Before Requesting Service

Power

No power.

Correction

- Check that the AC power cord is correctly connected to an AC outlet.
- Check that the VCR is turned on.

Recording & Playback

TV programme cannot be recorded.

Correction

- Check the connections between the VCR, the antenna and the TV.
- Make sure that the record tab on the back of the cassette is not removed.

Timer recording cannot be performed.

- Set the timer on-time and timer off-time correctly.
- Make sure that the VCR is turned off after setting is made.
- Timer recording may not be performed or stopped if a power interruption occurs before or during timer recording.

There is no playback picture, or the playback picture is noisy or contains streaks.

- Select your video channel correctly.
- Adjust the tracking slowly in either direction.

During a still or slow motion picture, the picture may contain some vertical jitter when using a TV which has an automatic vertical hold control.

- Try to change to another tape, you may not have this problem.

If the top of your playback picture waves back and forth excessively.

- Because the VCR playback signal is not as stable as an off-the-air TV signal, the top of your TV screen may be bent or unstable during playback. You may have better result if the A/V input is used.

During playback, "USE CLEANING CASSETTE" appears on the screen.

- The video heads are dirty. Use a head cleaner.

Remote Control

The remote control cannot work.

Correction

- Aim the remote control directly at the remote sensor on the VCR.
- Avoid all obstacles which may interfere with the signal path.
- Inspect or replace the batteries.
- Make sure batteries are inserted correctly.

Miscellaneous

A cassette cannot be inserted.

Correction

- Insert the cassette with the window side up and the record tab facing you.

The cassette does not eject.

- Check that a cassette tape is not already inserted. Press **▲ EJECT**.
- Check that the AC power cord is correctly connected to an AC outlet.

The cassette ejects when you press **REC/OTR ●**.

- Check that the record tab on the back of the cassette is not removed.

Specifications

General

Mains voltage

Mains frequency

Power consumption

Ambient temperature

Relative humidity

Dimensions (WxHxD)

Mass

Position for use

Video output channel

Possible number of TV channel

Number of pre-programmable memory blocks

Number of days in advance

AC 110 V – 240 V

50 Hz/60 Hz

VR407/55: 14W

VR607/55: 16W

+5° C to +40° C

10 % to 80 %

Approx. 360 mm x 94 mm x 251 mm

Approx. 3.0 kg

Horizontal

UHF E36 (adjustable between E28 — E60)

99

8

365 or every day, or every week

Tuner

Aerial input

VHF L:

VHF H:

UHF:

B/G, D/K, I, K1

42 MHz — 175 MHz

175 MHz — 470 MHz

470 MHz — 870 MHz

CATV

Video

Input (VIDEO IN)

Output (VIDEO OUT)

Resolution

Signal/noise ratio

0.5 V(p-p) to 2.0 V(p-p), 75 ohms

1.0 V(p-p) ±0.2 V(p-p), 75 ohms

Better than 240 lines

Better than 43 dB

Audio

Input (AUDIO IN)

Output (AUDIO OUT)

-8 dBs, 50 k ohms (0 dBs=0.775 Vrms)

-8 dBs, 1 k ohms (0 dBs=0.775 Vrms)

Accessories supplied

Remote control unit

RF coaxial cable

Batteries – R6(SUM-3)/AA

(only for checking operations)

Design and specification are subject to change without notice.

Free Manuals Download Website

<http://myh66.com>

<http://usermanuals.us>

<http://www.somanuals.com>

<http://www.4manuals.cc>

<http://www.manual-lib.com>

<http://www.404manual.com>

<http://www.luxmanual.com>

<http://aubethermostatmanual.com>

Golf course search by state

<http://golfingnear.com>

Email search by domain

<http://emailbydomain.com>

Auto manuals search

<http://auto.somanuals.com>

TV manuals search

<http://tv.somanuals.com>