

PHILIPS



VCR

VIDEO CASSETTE RECORDER

VR202
VR302

INSTRUCCIONES DE MANEJO

MODO DE EMPREGO

GEBRUIKSAANWIJZING

MODE D'EMPLOI

OPERATING INSTRUCTIONS



PHILIPS

(E) Instrucciones de manejo

¡Atención!

- Abrase siempre antes que nada esta página.

(P) Modo de emprego

Atenção!

- Abra sempre em primeiro lugar esta página desdobrável.

(NL) Gebruiksaanwijzing

Attentie!

- Altijd eerst deze flap openslaan.

(F) Mode d'emploi

Attention!

- Commencez toujours par ouvrir ce rabat.

(GB) Operating instructions

Attention!

- Always open this flap page first.

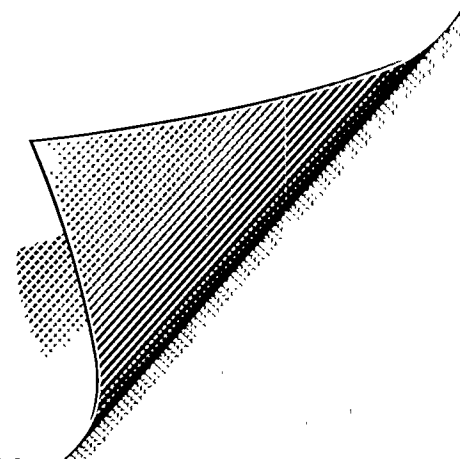

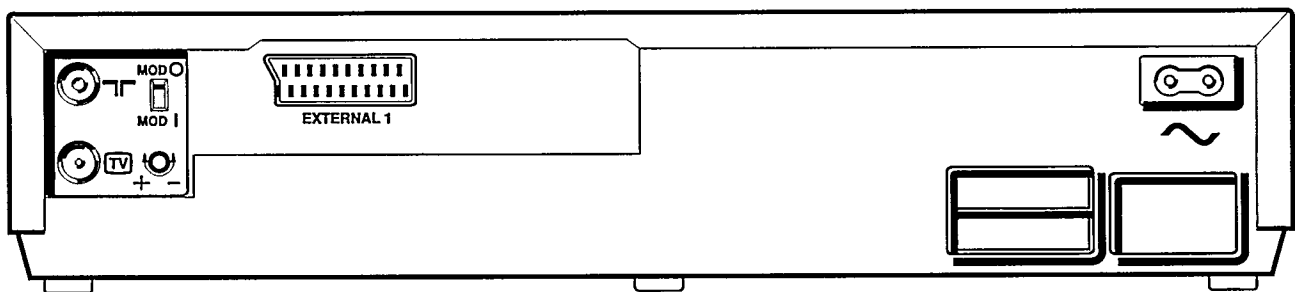
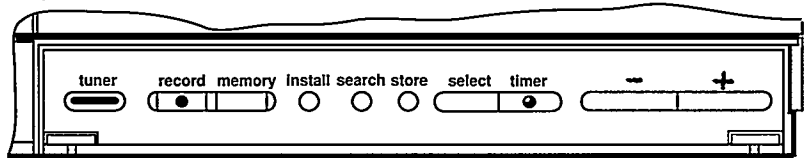
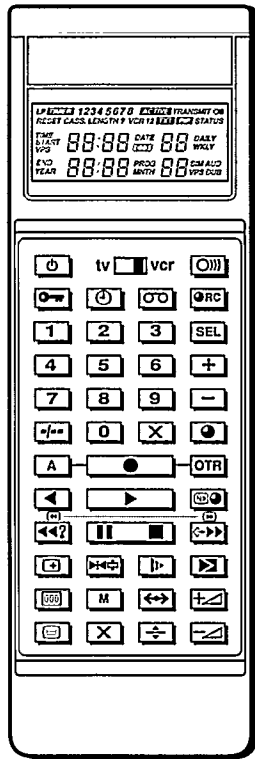
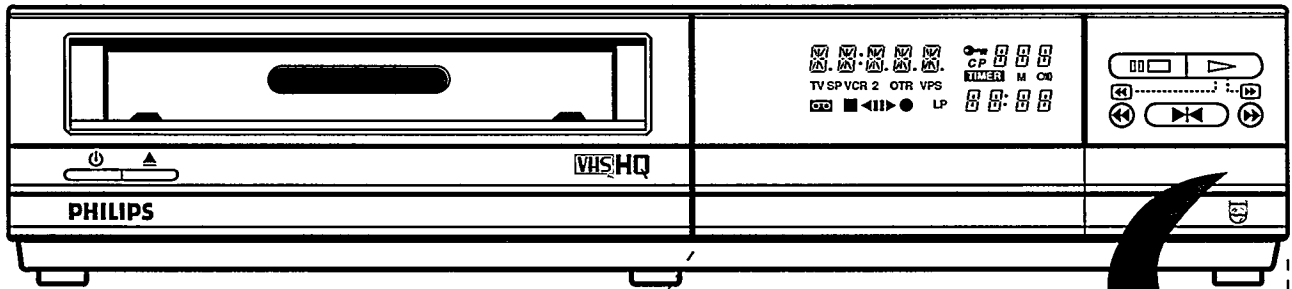
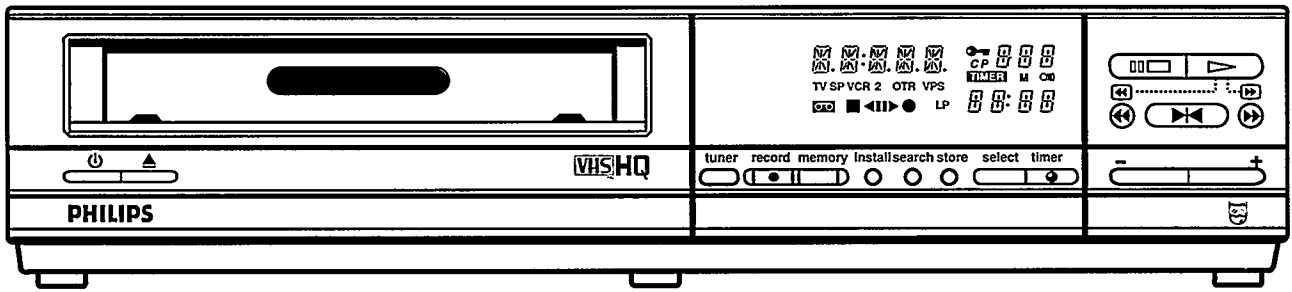

INTRODUCTION

May we take this opportunity to congratulate you on the purchase of this new Video Cassette Recorder (VCR). You are now the owner of one of the most sophisticated and simple-to-use home video recorders on the market.

Naturally, you can't wait to get it working, but before you do, spare a few moments to read through this operating manual. The time you spend reading through it and familiarising yourself with the operation of the video recorder will be repaid by trouble-free operation and even greater satisfaction at successful recordings and playbacks.

This video recorder also features:

- **Language choice.** You have a choice of 4 display languages: English, German, Italian or French.
- **Child lock.** This will prevent unauthorized operating of your video recorder.
- **Battery back up.** If a power failure occurs, all important data will remain stored in the video recorder memory for up to 1 month.
- **2 video heads.** Outstanding picture quality has been achieved by means of 'laser adjustment'.
- **3 video heads.** With this function you will have a perfect still picture and perfect slow motion (only for type VR 302).
- **Tape counter indication in real time.** It is possible to select one of the following indications: tape counter, time used or time left.
- **Autotracking.** At the touch of a button, your video recorder will find the optimum video head tracking position. By using this feature, you may improve the picture quality of hired recordings.

This video record employs the VHS system. You can use cassettes with a playing time of up to 300 minutes. Only use cassettes of a well-known brand which display the VHS symbol. This will enable you to achieve optimum picture quality:





CONTENTS































Chapter		Page
	INTRODUCTION	
1	BUTTONS, CONTROLS, CONNECTIONS Safety instructions	2
2	INSTALLATION Connecting the mains and the aerial Connecting to your TV set Setting the display language and the clock	3
3	STORING TV CHANNELS	5
4	THE REMOTE CONTROL Setting the clock TV and VCR controller in one Switching from VCR1 to VCR2	7
5	PLAYING A CASSETTE Tape position	8
6	HOW CAN I RECORD DIRECTLY OTR Recording (instant recording) Auto-assembling	11
7	HOW DO I PROGRAMME A TIMED RECORDING? Programming on the video recorder Programming on the remote control Correcting/cancelling a TIMER-block	12
8	OTHER RECORDING POSSIBILITIES Recording from an external source	16
9	PARTICULAR FUNCTIONS AND EXTRAS Tuner mode Interrupting a function Child lock Automatic switch-off Auto-dimmer The control buttons + / - and 0-9	17
10	INFORMATION ON VIDEO CASSETTES	18
11	BEFORE YOU CALL FOR TECHNICAL ASSISTANCE	19
12	TECHNICAL DATA, ACCESSORIES	19

SUMMARY OF BUTTONS, CONTROLS AND CONNECTIONS





1

Detailed information concerning the various functions is given in the relevant sections.



If symbols only appear on the video recorder or differ from the symbols on the remote control they are marked in negative in the text. (e.g.  instead of .

Symbols on the video recorder	Symbols on the remote control	Function
		Switch off (Stand by)
		Cassette eject
TUNER		Tuner mode
		Record (on the remote control A and  simultaneously)
MEMORY	M	Tape counter memory
INSTALL		Installation
SEARCH		Search for a TV channel
STORE		Store a TV channel
SELECT	SEL	Function select
		TIMER programming
-	-	Down
+	+	Up
		Rewind / Picture search backward
		Still picture, frame advance
		Wind / Picture search forward
		Pause/Stop
		Play
	TV/VCR	TV/VCR selector
		Transmit
		Child lock
		Set clock on the remote control
		Tape length selector
		TIMER programming via remote control
	0-9	Digit buttons
	-/--	One or more digits entry
	X	Reset / cancel
	OTR	One Touch Recording (instant recording) on the remote control A and OTR simultaneously
		Play reverse
		Fast motion
		No function
		Slow motion (VR 302)
		Auto tracking
		Time used, time left or tape counter selector
		Searching for a tape position (GOTO)

Rear side of the video recorder:

	Aerial input socket
	Aerial output socket
	Channel control
EXTERNAL 1	AV-Euroconnector 1 (21-pin)
	Mains socket
MOD I/O	MOD selector (modulator on = I)

Extra functions if TV/VCR selector is in the 'TV' position (only for specially equipped TV sets):

	Personal preference button
	TV volume up (independent of the position of TV/VCR)
	TV volume down (independent of the position of TV/VCR)

Note: On some TV sets (with TXT) it is also possible to use the yellow TXT-buttons.

Safety Instructions

The manufacturer cannot be held responsible for damage which is incurred by not using the video recorder in compliance with the national guarantee conditions, safety instructions or precautions.

- First check if your supply voltage is the same as that written on the type plate at the rear of the video recorder.
- Caution! Do not open the casing, risk of electric shock. No user serviceable parts are to be found inside. If the video recorder is connected to the mains there are still parts of it in operation. To switch off the video recorder completely you must disconnect it from the mains.
- Ensure that air can circulate freely through the ventilation openings of the video recorder. Do not place the video recorder on soft surfaces.
- Do not place the video recorder close to a source of heat (radiator, etc.)
- Do not expose this video recorder to rain or moisture. Ensure that no objects or fluids pass through the ventilation openings. If liquid is split into the video recorder, disconnect the video recorder from the mains and consult a qualified service technician.

Precautions

- Before connecting the video recorder to the mains, it should be allowed to acclimatise for at least three hours after unpacking. Do not use your video recorder immediately after moving it from a cold to a warm location or vice versa, after heating a cold room or under conditions of high humidity.
- Ensure that there is a vertical distance of at least 20 cm between the video recorder and the TV set.
- Do not place the video recorder near appliances generating strong magnetic fields (e.g. motors, loud speakers and transformers).
- Do not use the video recorder in dusty places or where it may be subject to vibration.
- During heavy thunderstorms we recommend disconnection of the mains supply and of the aerial.
- Do not poke fingers or insert objects into the cassette loading slot, as this might cause injury and/or damage to the mechanism. Take special care with children.
- If you transport your video recorder, be sure to remove the video cassette and avoid sudden or violent jolts.

INSTALLATION: HOW DO I CONNECT THE VIDEO RECORDER TO THE TV SET?

2



Your video recorder is a sort of 'TV set without a screen'. It must therefore be connected to both the aerial and the TV set in order for you to be able to view recorded cassettes.

Connecting to the mains

- 1 Insert the female plug of the mains lead into the mains socket  at the rear of the video recorder.
- 2 The other plug at the other end of the mains lead must be inserted into the wall socket.

Further instructions for use:

- The video recorder should remain connected to the mains at all times to ensure that timed recordings can be made. The power consumption in the stand by mode is very low.

No additional control button is required to activate the video recorder. It will switch itself on when a cassette is loaded or when any of the tape transport buttons are pressed (e.g.  ).

- If the video recorder has been switched off by pressing the button , the display will only show the time e.g.:

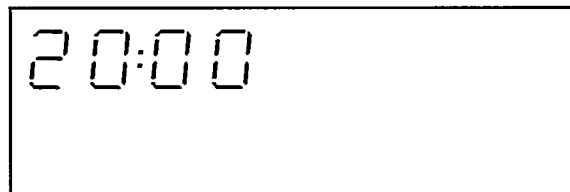

- This video recorder has an emergency switch off button. When you press this button , all video recorder functions are interrupted. If you get into operating difficulties, you may use this button to cancel the function and start again from the beginning.

Connecting the aerial

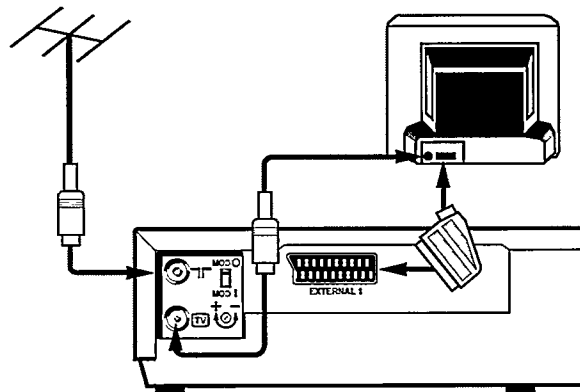

Remove the aerial cable from your TV set and plug it into the socket **TV** at the back of the video recorder.

Take the aerial cable supplied and connect it to the socket **TV** on the video recorder and to the aerial input socket on your TV.

Both sets are now connected to the aerial.

Connecting to your TV set

The connection to the TV set can be made in two different ways. The kind of connection you choose depends on the TV model you possess.

Method 1:

If your TV set has a 21-pin AV-Euroconnector:



We suggest that you use an AV-Eurocable. This will guarantee the best possible connection between the TV set and the video recorder. Consult your dealer for the correct cable.

- 1 Connect the corresponding AV-Euro socket on the TV set and the video recorder socket **EXTERNAL 1** using an AV-Eurocable.
- 2 Set the **MOD I/O** selector at the rear of the video recorder in position **O**.
- 3 If you wish to play back a cassette, all you have to do is to select programme 'AV' (= Audio Video-input) on the TV set. On specially equipped TV sets the switching takes place automatically.

Method 2:

If your TV set isn't provided with a 21-pin AV-Euroconnector:

The aerial cable which is already in place, will act as the connection between the TV set and the video recorder.

In order to play the cassette (i.e. to produce the image on the screen) a programme number for the video recorder must be stored in the TV set. This works in the same way as storing a TV channel.

For example BBC 1 can be stored on number '1', BBC 2 on number '2', ITV on number '3' and so on.

If your TV set has a number reserved for the video recorder, then select this number.

If your TV set hasn't a special programme number reserved for the video recorder playback, you could, for example, choose programme number '8'.

Next, you have to select the right 'frequency', this works in the same way as tuning in to a radio station. The video recorder transmits 'its programme' on the UHF channel 37.

Your TV set must be adjusted to receive this channel.

And this is how to go about it:

- 1 Switch on the TV set and select the programme number you wish to reserve for the video playback (e.g. programme number '8').
- 2 Remove the aerial cable from the aerial socket **TV**.
- 3 Switch off the video recorder by pressing button **⏻** and press the button **INSTALL**. A language indication will appear on the display, e.g. 'ENGL'.
The video recorder is now transmitting an installation test picture, which the TV set should receive.
- 4 Tune the TV set to the UHF range (band IV-V) until this test picture appears on the screen. You will find it around channel 37.

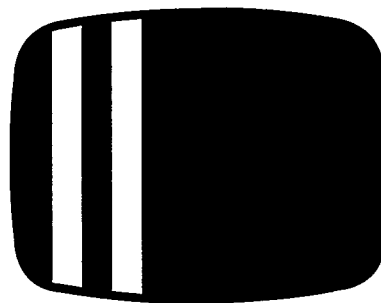

In order to find out how to select the right channel on the TV set, please consult the operating instructions of your TV set.

- 5 Replace the aerial cable in the aerial socket **TV**.
Switch off the video recorder by pressing button **⏻**.
You have now tuned the video recorder into the TV set.



Please note:

It is possible that in your reception area UHF channel 37 is already occupied by another TV channel. In this case you will have picture disturbances in the channels stored on the TV set. Proceed in this way:

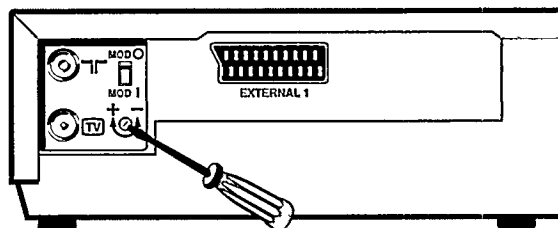
- 1 Switch on the video recorder by pressing button **INSTALL** and check if the picture quality of all the TV channels stored in the TV set is unchanged.
- 2 If the reception of any TV channel is now of poor picture quality, switch the video recorder off for a control and check all the TV channels again.
- 3 If the disturbances of the picture quality only appear when the video recorder is switched on, use a small screwdriver to turn the **+Ⓢ-** channel control at the rear of the video recorder.





- 4 Tune the TV set once more following the instructions from step 1 to 5 until you see the installation test picture again.

- 5 Check again all the TV channels stored on the TV set. If necessary repeat the +- channel adjustment until all picture disturbances disappear.
- 6 Finally switch off the video recorder pressing button .

Selecting the display language, setting the clock and the date

In order to operate your video recorder easily, you have a choice of four display languages: English, German, Italian or French. The correct clock setting is important for carrying out timed recordings.

And this is how to go about it:

- 1 Press the button  to switch the video recorder off. Now press the button **INSTALL**. Press the buttons + or - to select the language indication of your choice e.g. 'ENGL'.
- 2 Press the button **INSTALL** again. The display now shows 'TIME'. Press the buttons + or - to set the time. You may also use the digit buttons 0-9.
- 3 Press the button **INSTALL** again. The display shows 'YEAR'. Now set the year.
- 4 Press the button **INSTALL** again. The display shows 'MONTH'. Now set the month.
- 5 Press the button **INSTALL** again. The display shows 'DATE'. Set the date.
- 6 Press the button **INSTALL** once again. The setting of the display language and of the clock is now completed.
- 7 Press button  to switch off the video recorder.

Please note:

- The test picture is displayed on the TV screen during the time when the installation procedure is followed.
- You can also set the time and the date on the remote control and then transmit the data to the video recorder by pressing button .

STORING TV CHANNELS

In chapter 2 you connected your TV set to the video recorder, so that you may play a cassette. In order to be able to record a TV programme, you first have to store every TV channel on the video recorder.

It is possible to store up to 42 TV channels!

Each TV channel has to get a number.

We advise you to use the same programme numbers for the TV channels on the video recorder as those on your TV set. Afterward this will make operating the video recorder a great deal easier.

The following is an example in which your TV set has the association listed below:

TV channel BBC 1	=	programme number 1
TV channel BBC 2	=	programme number 2
TV channel ITV	=	programme number 3
video recorder	=	programme number 8
or		
video recorder	=	programme number 'AV'

If your TV set is already installed, these associations will already be stored. Now make the same association on the video recorder between a TV channel and a programme number.

You have two possibilities:

- If you do not know which channel number corresponds to the particular TV channel you want to store: Read the section '**Automatic channel search**'.
- If you know which channel number corresponds to the particular TV channel you want to store: Read the section '**Direct channel storage**'.

Please note: If you store a TV channel on a programme number that has already been used, the original channel will be deleted.

Automatic channel search

- 1 Switch on the TV set and select the programme number for the video recorder (in our example number '8' or 'AV').
- 2 Switch on the video recorder by pressing button .
- 3 Press button **SEARCH**. The video recorder will search for a TV channel. The display will show e.g.:

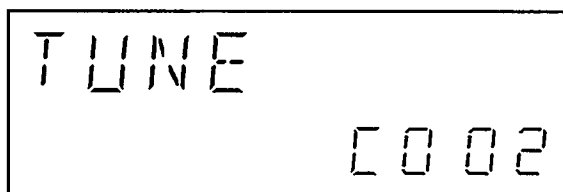

- When the automatic channel search finds a TV channel, its picture appears on the TV screen. The display will show e.g.:

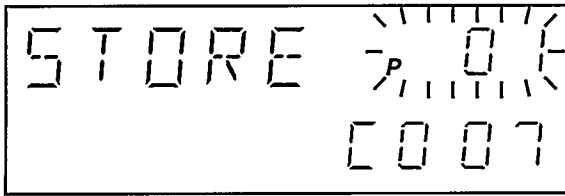

- Press button **SEARCH** again if it isn't the desired TV channel or if the picture quality is poor. The video recorder will search for the next TV channel.

- 4 The video recorder will propose a programme number (e.g. P 01) in which to store the TV channel. If you wish to store it in another programme number, press buttons **+** or **-** to change the programme numbers. If it is for instance the TV channel 'BBC2', then in our example it would be number '2'.

A tip: If the reception of the TV channel is not optimum, then we advise that you operate button **▶** to start the automatic fine tuning.

Please note: During the first installation the video recorder proposal for a programme number starts with '01'. It increases automatically by one number every time you store a channel.

- 5 If the programme number is correct and the TV channel reception is good, store them by pressing button **STORE**.
- 6 Repeat steps 3 to 5 until all the desired TV channels are stored.

Direct channel storage

- 1 Switch on the TV set and select the programme number for the video recorder (in our example number '8' or 'AV').
- 2 Switch on the video recorder by pressing button **■**.
- 3 The video recorder will show a programme number as a memory position (in our diagram, for example, this is 'P 01'). If you would rather store another number press buttons **+** or **-** to change the programme number.
- 4 Press button **STORE**. The display will show a flashing channel number (in our diagram, for example, this is 'C 02').

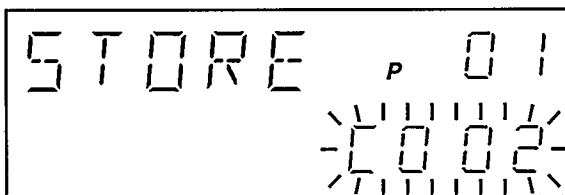

Enter the desired channel number in 3 digits by pressing buttons **+** or **-** or the digit buttons **0-9** (e.g. '027' for 'channel 27').

- 5 The image of the TV channel received will appear on the TV screen.
- If it isn't the desired TV channel or if the picture quality is poor, enter another channel number.

A tip: If the reception of the TV channel is not optimum, then we advise that you operate button **▶** to start the automatic fine tuning.

- As soon as the right TV channel is found, store it by pressing button **STORE**.

- 6 Repeat steps 3 to 5 until all the desired TV channels are stored.

Availability table for special cable TV

If you possess cable TV equipment with special availability, you must enter the already defined channel numbers for the special channels.

Proceed as described in section 'Direct channel storage' and enter the channel numbers of the following table at step 4.

Further information about the channel numbers is available from your cable TV supplier.

Special channel/channel number					
S1	080	S11	090	S21	100
S2	081	S12	091	S22	101
S3	082	S13	092	S23	102
S4	083	S14	093	S24	103
S5	084	S15	094	S25	104
S6	085	S16	095	S26	105
S7	086	S17	096	S27	106
S8	087	S18	097	S28	107
S9	088	S19	098	S29	108
S10	089	S20	099	S30	109
				S31	110
				S32	111
				S33	112
				S34	113
				S35	114
				S36	115
				S37	116
				S38	117
				S39	118
				S40	119
				S41	120

THE REMOTE CONTROL

4

You have now prepared your video recorder for playback and recording.

All the remaining functions and extras can be operated from a comfortable position by using the remote control for the daily operation of your video recorder.

How do I insert the batteries?

- 1 Open the cover on the back of the remote control unit.
- 2 Insert the batteries as indicated in the battery holder and close the cover.

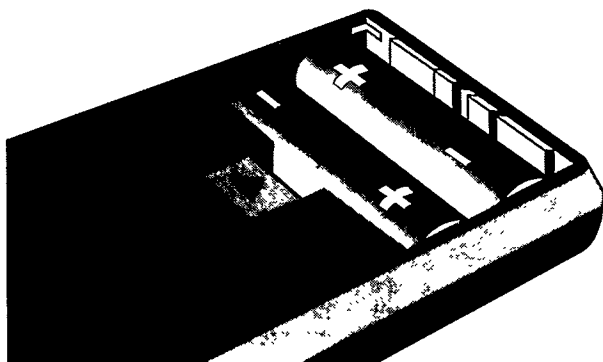

How do I set the clock and the date?

Should the clock not be correctly adjusted (after having changed the batteries, for example), all the data will flash on the remote control display.

- 1 Press button on the remote control. The remote control display will show, e.g.:

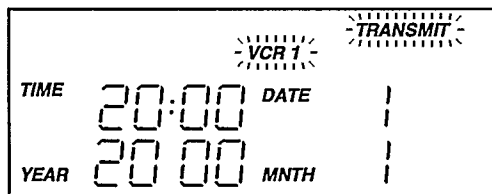

If you don't want to change the displayed data, press button on the remote control.

- 2 If you wish to correct the displayed data, press button again. The display will show, e.g.:

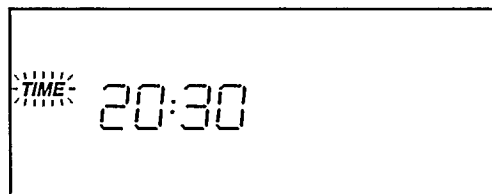

Set the precise time by pressing buttons **+** or **-**. You may also use the digit buttons **0-9**.

The clock will start again after step 3 has been completed.

- 3 Press button again. The display will show, e.g.:

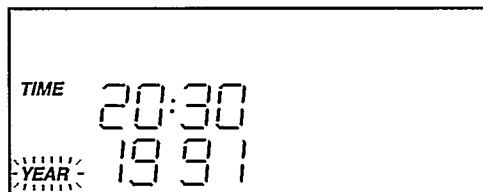

Now set the correct year.

- 4 Press button again. The display will show, e.g.:

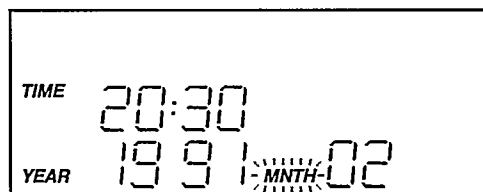

Now set the correct month.

- 5 Press button again. The display will show, e.g.:

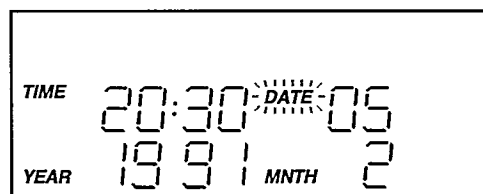

Now set the correct date.

- 6 Press button once more to complete setting the clock. The data is now stored in the remote control. The display will show, e.g.:

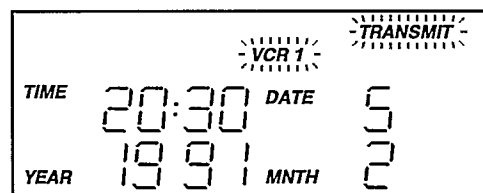

- 7 If you wish to adapt these time settings to the video recorder press button . In this way you transmit the settings to the video recorder. If the transmission is accepted the video recorder display will show, e.g.:

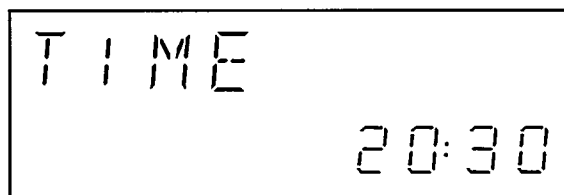

Please also note: You can also set the clock on the video recorder by using button **INSTALL** on the video recorder.

Some other functions featured by this remote control

TV and VCR controller in one:

If your TV set is specially equipped for receiving the transmission code of this remote control, you can also activate some TV functions.

How do I control the video recorder functions?



- Set the selector **TV/VCR** to position 'VCR'.
- Aim the remote control at the video recorder and press the required button.

How do I control the TV functions?



- Set the selector **TV/VCR** to position 'TV'.
- Aim the remote control at the TV set and press the required TV function button.

Switching from VCR 1 to VCR 2

You may use this function if you have two video recorders which accept the same transmission code. Changing the remote control code on both this video recorder and this remote control unit will prevent the unintentional activation of the wrong video recorder.

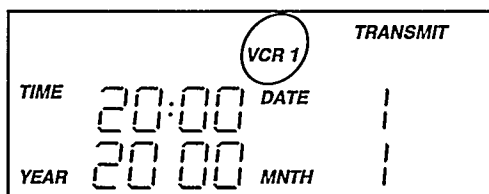
- 1 Switch off the video recorder by pressing button . Now press button **INSTALL** on the video recorder. The video recorder display will show the chosen language indication, e.g. 'ENGL'.
- 2 Press button  on the remote control. The remote control display will show e.g.:



- 3 Press button **SEL** on the remote control. The remote control display will show 'VCR 2'.
- 4 Press button  to transmit the data to the video recorder. Also the video recorder display will now show 'VCR 2'. The clock settings are also transmitted.
- 5 Press button  to switch off the video recorder.

If you wish to change the set back to 'VCR 1', just follow the same sequence. The display will again show 'VCR 1'.

PLAYING A RECORDED CASSETTE

5

In chapter 2 you will have connected your TV set to the video recorder.

Playing a cassette will now be very easy and unproblematic.

- 1 Switch on the TV set and select the programme number reserved for playing the video.
- 2 Insert the cassette into the cassette slot with the title label facing you and the window facing upward. Push the cassette in the center until it is pulled inside automatically.

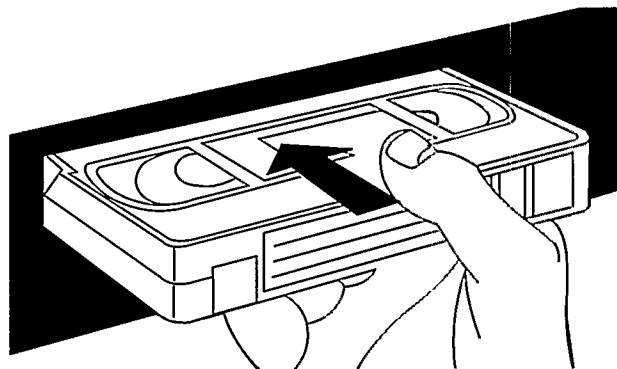

Inserting a cassette will switch on the video recorder automatically. The symbol  appears on the display.

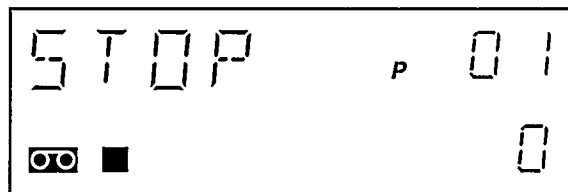

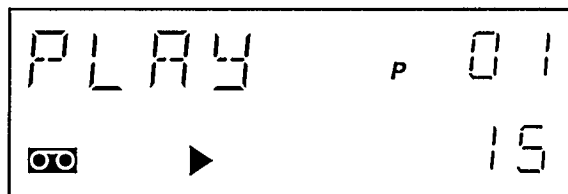

- 3 Press button . The display will show, e.g.:

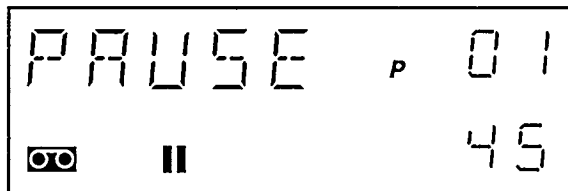

The recorded image will appear on the TV screen.

- 4 Press button  when you wish to interrupt the playback. The display will show, e.g.:



- 5 Press button  if you wish to eject the cassette.

Please also note the following:

- When the tape reaches the end during playback, it automatically rewinds to the beginning.
- If you load a cassette which has the erase tab removed, the video recorder will start playing the cassette automatically. You may then omit step ③.

How do I correct picture disturbances (Auto-tracking)?

If the playback picture and/or sound quality of hired cassettes is poor, the video head tracking position may be easily adjusted:

- 1 Press button ►.
- 2 Press button ►. The video recorder will automatically find the best playback quality within a few seconds. The sound is muted.

The automatically found optimum of very poor recordings can sometimes be improved as follows:

- 1 Press button ►.
- 2 Press button ►.
- 3 Then press button ► at the very moment when the best playback quality has been reached.

Other playback functions and particular features

Wind and rewind:

- 1 Press button ■.
- 2 Press button ◀◀ or ▶▶. The tape will rewind or wind at high speed.
- 3 Press button ■ or ► when the required tape position is reached.

Searching with picture:

- 1 Press button ►.
- 2 Press button ◀◀ or ▶▶. The tape will play forwards or backwards at 7 times the normal speed, displaying the recorded image but without sound.
- 3 Press button ► again when the required tape position is reached.

Note:

The picture is affected by interferences whilst it rewinds or winds at speed. This does not indicate a malfunction.

Still picture:

- 1 Press button ►.
- 2 Press button ►◀. The picture will stand still. Each time you press this button, the tape will advance by one step.
- 3 Press button ► for normal playback.

Please note:

Still pictures can sometimes present vertical vibrations. Press and hold button ► until the vibration disappears. If the optimum position has been passed, press and hold button ► again. This adjustment for still pictures only has to be done once since the video recorder will store the adjustment details automatically.

Important! With hired cassettes of poor quality the still picture may nevertheless be affected by interference. This is not caused by your video recorder.

Fast motion:

- 1 Press button ►. The recording is shown in fast motion.
- 2 Press button ► again for normal playback.

Play reverse at normal speed:

This function is very convenient if you wish to go back to a particular scene.

- 1 Press button ◀. The sound is muted.
- 2 If you wish to return to normal playback, press button ►.

Special functions - only for video recorder type VR302

Slow motion:

- 1 Press button ►. The recording is shown in slow motion. The sound is muted.
- 2 Press button ► to return to normal playback.

Variable slow motion:

- 1 Press button ►. The recording is shown in slow motion.
- 2 If buttons + or - is then pressed the slow motion speed can be changed in 4 steps, i.e. 1/6, 1/10, 1/14, 1/18 of the normal playback speed. During slow motion the sound is muted.
- 3 Press button ► to return to normal playback speed.

Note: The slow motion speed selected using buttons + or - stored until it is changed again.

Superslow motion:

With this set you can see the recorded programme in superslow motion of exceptional quality.

- 1 Press button ►.
- 2 Press and hold button ►◀. The recording will be shown in superslow motion.

Variable picture search:

- 1 Press button ►.
- 2 By pressing buttons + or - you can regulate the picture search speed either forwards or backwards.
- 3 Press button ► for normal playback speed.

How do I know where I am on the cassette tape?

It is always handy to know for how long a cassette has been played or how long is still left. The video recorder allows three different ways of finding this out.

First of all, you must select the tape length of the inserted cassette. This is necessary if the correct playing time is to be indicated.

- 1 Press button \odot on the remote control. The remote control display will show a cassette tape length, e.g.:

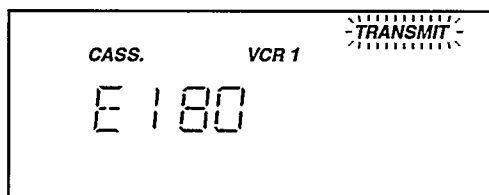

- 2 Press buttons + or - on the remote control to select the correct tape length. You can choose from amongst any of the following settings, which will appear in this order: E30, E60, E90, E105, E120, E 150, E180, E195, E200, E210, E240, E260, E300, EC30, EC45, E30, etc.
- 3 Press button \odot on the remote control to transmit the cassette tape length to the video recorder. If the transmission is accepted the video recorder display will show, e.g.:

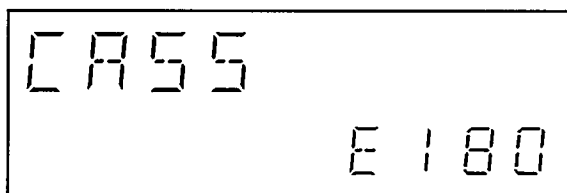

- 4 By pressing button \square you will be able to select one of the following indications of your choice:

- time used = \sqcup
- time left = \sqsubset
- tape counter = tape position

You can switch between these indications during rewinding, winding, recording or playing a cassette.

If you wish to reset the tape counter indication to '0', press the button X.

Two additional things to note:

- Sometimes the actual tape length can be longer than indicated, e.g. 185 minutes instead of the indicated 180 minutes (E180).
- The time indication will only be correct with european PAL/SECAM-VHS cassettes. Cassettes manufactured for use on NTSC VHS machines will show incorrect times.

How can I find a particular position on the tape?

It's possible that you may have recorded two or more different programmes on the same cassette. So as not to have to search for too long, your video recorder has an automatic search function (GOTO).

Searching for a tape position (GOTO):

- 1 Press button \leftrightarrow on the remote control.
- 2 Press the digit buttons 0-9 to enter the desired position to which you would like the tape to go.
- 3 You may now select the function to be started from that point, e.g. ■, ► or ●. The video recorder will rewind or wind the tape to the tape position which you have entered and will automatically begin the chosen function starting from that point.

Here is another tip: If you have recorded different programmes on a cassette, always write down the tape position where the recording starts (e.g. tape counter '3450'). You will easily be able to find the corresponding position by using the 'GOTO function'.

The video recorder also has a tape counter memory (MEMORY):

If you want to rewind to a particular tape position, you can first store this position in the memory:

- 1 Press button M. The tape position is now stored.
- 2 Press button ► to start playback.
- 3 Press button ■.
- 4 Press button ◀◀. The tape will rewind to the stored position.

Please note: The stored position is cancelled if button M is pressed again.

HOW CAN I RECORD DIRECTLY?

6

The easiest way of recording is to record directly from a TV programme which is being broadcast.

And this is how to go about it:

- 1 Load a cassette. The video recorder will switch on automatically.
Press buttons **+** or **-** or the digit buttons **0-9** to select the programme number you wish to record from.
- 2 Press button **●** when you want the recording to begin. The video recorder display will show e.g.:

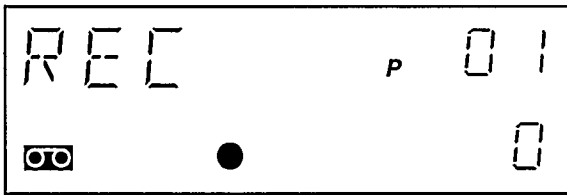

The video recorder will record your chosen TV programme.

It is important to note the following:

Whilst operating the remote control, you must always press the button **●** and the button **A** simultaneously, this is in order to prevent accidentally starting a recording.

- 3 If you wish to interrupt or to stop the recording, press button **■**.

Can I switch the TV set off while recording?

In order to record TV programmes, your video recorder has its own tuner. This means that during a recording you can use the TV set independently of the video recorder. You may switch it off, switch it on again or change the programme number without disturbing the recording which is taking place. If you wish to control what you are recording, then select on the TV set the programme number for the video recorder.

Some general notes:

- If while recording a TV programme you wish to select a different TV channel and record a programme from there, you must first interrupt the original recording by pressing the button **■**.
Select the new programme number and start the recording by pressing button **●**.
- Should you forget to load a cassette before starting a recording, the display will warn you by showing the following:

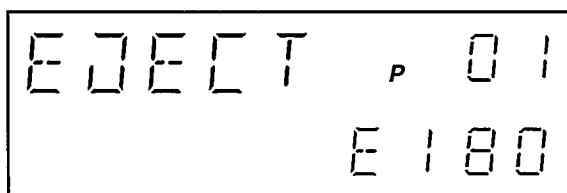

- If you accidentally load a protected cassette, for example a cassette hired from a video shop, then when you go to begin a recording, the display will warn you by indicating the following:

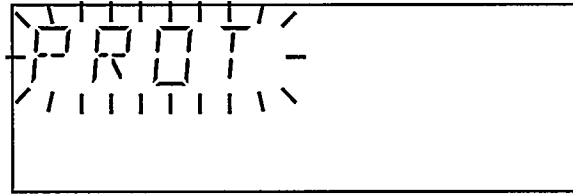

After awhile the cassette will be ejected.

- If the end of the tape is reached during recording, the cassette will be ejected automatically and the video recorder will switch itself off.
- The previous recording on a cassette is automatically erased when you make a new recording.

Instant recording with automatic switch off (OTR: One Touch Recording)

Even if you are recording directly, it is not necessary for you to wait for the programme to end. It is possible to give the video recorder an automatic switch-off time. The time when you wish the recording to stop can be chosen in intervals of 30 minutes.

- 1 Load a cassette and press buttons **+** or **-** or the digit buttons **0-9** select the TV channel from which you wish to record.
- 2 Now press the buttons **A** and **OTR** simultaneously when you wish to start the recording. The video recorder display will show, e.g.:

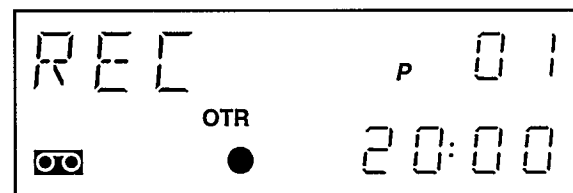

The time shown is the time at which the recording will stop, this is always the current time + 30 minutes. In this example, the time is 7.30 p.m.

- 3 If you wish the recording time to be lengthened, press again the buttons **A** and **OTR** simultaneously. Each time you press these buttons, the recording time is extended by 30 minutes.

If you have pressed the buttons **A** and **OTR** too often, press button **X** to return to the previous stopping time, that is, the present time + 30 minutes.

Please note:

- If you wish to stop the OTR recording before the programmed stopping time is reached, press button **■** or button **⏪**.
- If you have started a manual recording, you may later change over to an OTR-recording, for instance if you wish to go to bed.

With the auto-assembling function you may join single recordings without picture disturbances such as 'flickering'. If you wish to set the auto-assembling function into operation, then the video recorder must be in 'PAUSE' position.

- 1 Press the button ► and immediately afterwards interrupt the playback by pressing button ■. 'PAUSE' will be indicated on the video recorder display.
- 2 Now start the recording as usual by pressing button ●.

HOW DO I PROGRAMME A TIMED RECORDING?

7

In the following chapter we will guide you through the different possibilities of programming your video recorder, so that it will switch itself on automatically, record the TV programme you have chosen and then switch itself off automatically, all of this up to 1 month in advance.

What information is needed by the video recorder?

For every timed recording you must give the video recorder the following information:

- the starting time of the recording
- the ending time of the recording
- the date on which the recording is to be made
- the programme number of the corresponding TV channel

Information necessary for timed recordings is stored in a so-called TIMER block.

Your video recorder can store up to 6 different TIMER blocks.

It is important to note the following:

The automatic time-switch (TIMER) will only switch the video recorder on automatically if it is switched off at the moment the timed recording has to start.

Always make sure that the video recorder is switched off before a timed recording must start. If necessary press button ⏻.

How to programme the video recorder

You have a choice of 2 different kinds of timed recording:

- You can either enter the data which is necessary for the timed recording directly into the video recorder or alternatively also with the help of the buttons on the remote control. We will refer to this possibility as 'Programming on the video recorder'.
- You can enter the data which is necessary for the timed recording into the remote control and finally transmit it to the video recorder. We will refer to this possibility as 'Programming on the remote control'.

Programming on the video recorder

You can also enter the data for a timed recording directly into the video recorder. It is possible to use either the buttons on the video recorder or the buttons on the remote control.

Next, you must enter step by step all of the data which is necessary for the timed recording. You may use the digit buttons 0-9 or the buttons + or -.

- Press button **1**. You must now select a TIMER-block.
The display will show, e.g.:

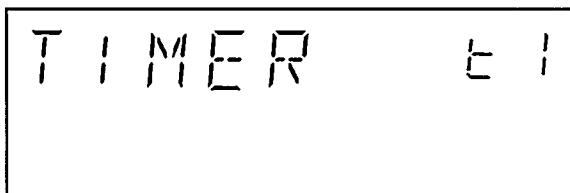

The indication 't1' shows the next free TIMER-block, in this case TIMER-block number '1'.

- If you wish to store the data in another TIMER-block, e.g. TIMER-block '4', enter the corresponding number.

- Press button **2**.
The video recorder display will show, e.g.:

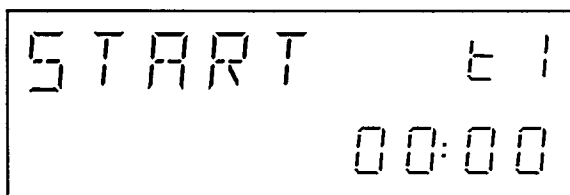

Now enter the starting time of the recording.

A tip:
If you press button **X**, the starting time will automatically be set to 20:00.

- Press button **3** again.
The video recorder display will show, e.g.:

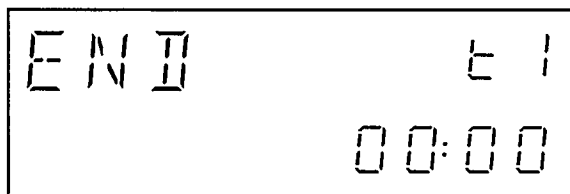

Now enter the ending time of the recording.

A tip:
If you press button **X**, then the starting time is automatically transferred as ending time and displayed as such.

- Press button **4** again.
The video recorder display will show, e.g.:

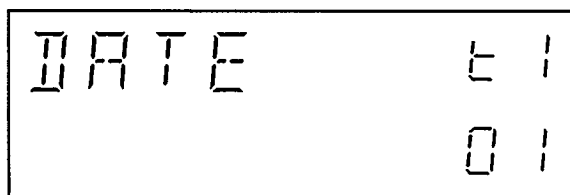

If the display shows another indication, e.g. 'DAILY' or 'WKLY', press button **SEL** one or more times until the display shows 'DATE'.

Now enter the date of the recording.

Please note:

- It is possible to programme a recording 31 days (1 month) in advance.
- If, for example, today is the 16th of March and you programme the date as '14', the recording will be made on the 14th of April.
- For a TV programme starting at midnight, i.e. at 00:00, enter the date of the following day as the recording date.

- Press button **5**.
The video recorder display will show, e.g.:

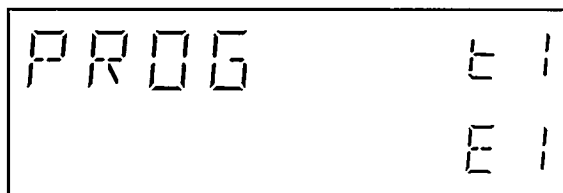

Now enter the programme number of the TV channel from which you wish to record.

- Press button **6** once more to complete the programming.
For awhile the video recorder display will show the following confirmation e.g.:

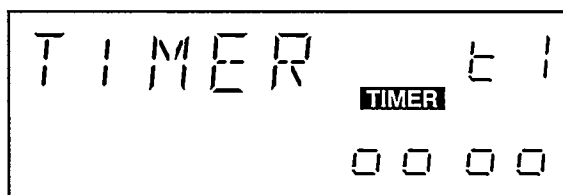

Programming a recording which takes place daily or weekly:

Some TV programmes are broadcast every day or every week at the same time e.g. a serial story in the early evening programme. You do not need to programme it every time, if you wish to record all episodes.

You may programme a recording which will take place daily or weekly at step **4**, entering the date of the recording.

If you wish to repeat the recording at the same time every day:

- Programme the TIMER-block as usual introducing the starting time and the ending time (steps **1** to **3**).

- When entering the date of the recording press button **SEL** until the indication 'DATE' is replaced on the display by the following:

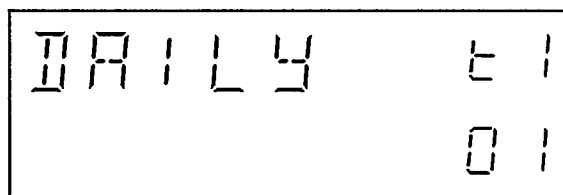

- Now press buttons **+** or **-** to enter the date, on which the first recording is to be made.
- Conclude the programming sequence as usual following steps **5** to **6**.

If you wish to repeat the recording on the same day and at the same time every week:

- Programme the TIMER-block as usual introducing the starting time and the ending time (steps **1** to **3**).

- When entering the date of the recording press button **SEL** until the indication 'DATE' is replaced on the display by the following:

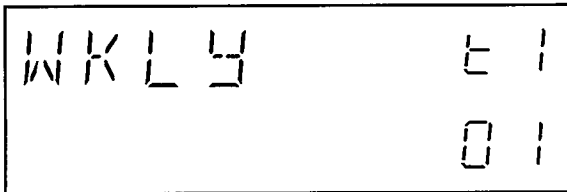

- Now press buttons **+** or **-** to enter the date, on which the first recording is to be made.
- Conclude the programming sequence as usual following steps **5** to **6**.

An important note:

- Before a timed recording starts, you may switch the video recorder on and use it normally.
- If you are using the video recorder at the moment when the timed recording is due to start, the indication 'TIMER' will flash on the display. This means that the video recorder cannot start the timed recording.
- In this case insert the cassette on which you wish to record and switch off the video recorder by pressing button **⏻**; the recording will automatically start.
- The indication 'TIMER' will stop flashing.

Some more notes:

- When a timed recording is taking place, the video recorder cannot be used manually. You may, however, cancel the timed recording by pressing button **⏻**.
- When the tape reaches the end during a timed recording, the cassette will be ejected automatically and the video recorder switches itself off.
- If you forget to load a cassette after programming a timed recording, then the display will warn you by showing 'EJECT'.
- If after programming a timed recording you load a protected cassette, then the indication 'PROT' will flash for awhile on the display. Afterwards the cassette will be ejected.
- If you wish to re-use information previously stored on a TIMER-block, all you have to do is to re-programme the date.
- If a TIMER-block number is already occupied, the display will show e.g.:

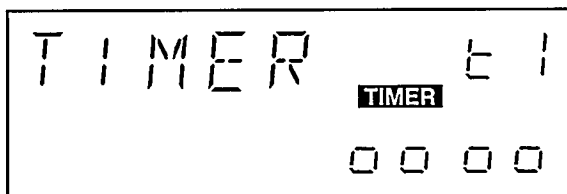

- If all TIMER-block numbers are programmed, the display will show the indication 'FULL' and then after awhile:

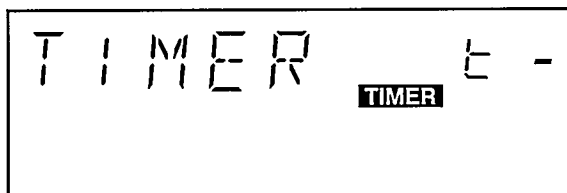

Programming on the remote control

You can enter the data which is necessary for the timed recording into the remote control. To do this you follow the same procedure as for programming on the video recorder.

The remote control display shows all the programming steps. To enter the data use the digit buttons **0-9**. Finally transmit the programmed data to the video recorder by simple one-button operation.

- 1 Press button **RC**.
First select one free TIMER-block.
The remote control display will show, e.g.:

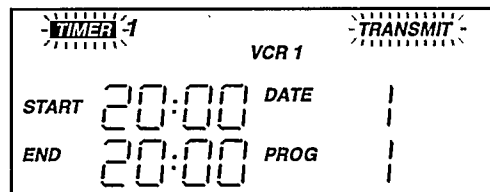

- If you select TIMER-block number '0' and you finally transmit the data to the video recorder, the TIMER data will be stored there automatically in the first free TIMER-block. The display on the remote control will no longer show a number.
- If you select TIMER-block numbers '1' to '6', while transmitting the TIMER data they will automatically occupy the corresponding block number in the video recorder.

- 2 Press button **RC** again.
The display will show e.g.:

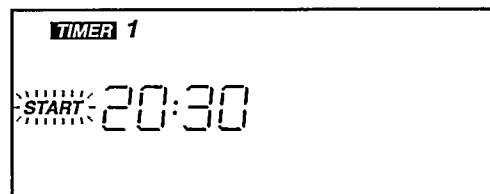

Now enter the starting time of the recording.

- 3 Press button **RC**.
The display will show e.g.:

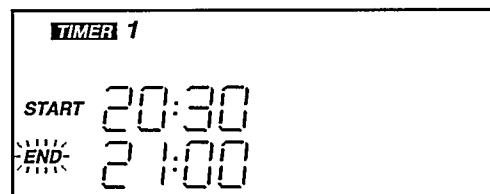

Now enter the ending time of the recording.

- 4 Press button **RC** again.
The display will show, e.g.:

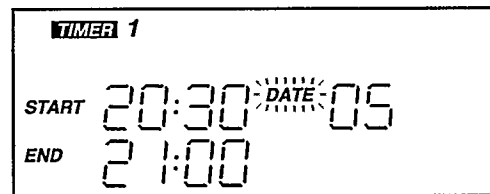

Now enter the date of the recording.

If the display shows another indication, e.g. 'DAILY' or 'WKLY', press button **SEL** one or more times until the display shows 'DATE'.

- 5 Press button **RC**.
The display will show, e.g.:

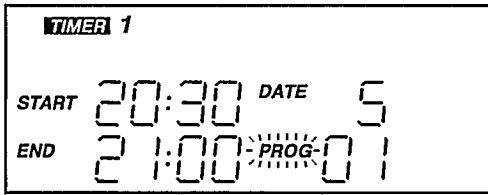

Now enter the programme number of the TV channel from which you wish to record.

- 6 Press button **RC** once more to complete the timer programming.
The display will show, e.g.:

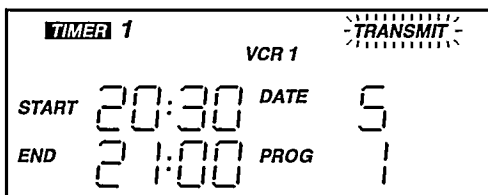

Please note:

You may now proceed with the programming of other TIMER-blocks and then with transmitting them one by one, to the video recorder.

- 7 Transmit the data to the video recorder. To do this, aim the remote control at the video recorder and press the button **O**). The recording details are now being transmitted to the video recorder.
The video recorder display shows the symbol **O**).

- If the transmission is accepted the video recorder display will show, e.g.:

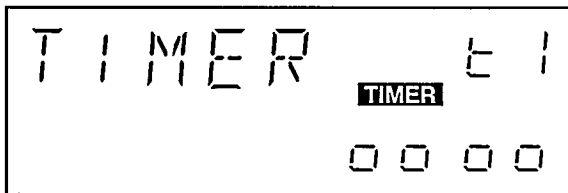

The programming sequence is concluded.

- If an error occurred while either programming on the remote control or during the transmission, the indication 'ERROR' will appear on the video recorder display.

Should this be the case then go back and check all the data you have entered and transmit it again.

Programming a recording which takes place daily or weekly:

You may programme a recording which will take place daily or weekly at step 4, entering the date of the recording.

If you wish to repeat the recording at the same time every day:

- Programme the TIMER-block as usual introducing the starting time and the ending time (steps 1 to 3).
- When entering the date of the recording press button **SEL** until the indication 'DAILY' appears on the display:

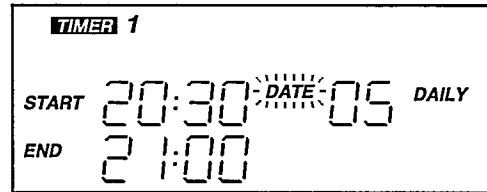

- Now press the digit buttons 0-9 to enter the date, on which the first recording is to be made.
- Conclude the programming sequence as usual following steps 5 to 7.

If you wish to repeat the recording on the same day and at the same time every week:

- Programme the TIMER-block as usual introducing the starting time and the ending time (steps 1 to 3).
- When entering the date of the recording press button 0-9 until the indication 'WKLY' appears on the display:

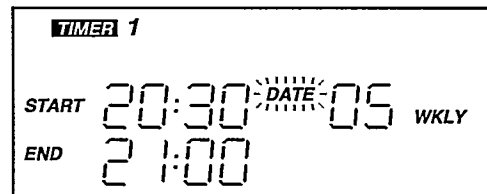

- Press now the digit buttons 0-9 to enter the date, on which the first recording is to be made.
- Conclude the programming sequence as usual following steps 5 to 7.

Please note:

- If during the programming sequence a button is not pressed for 1 minute, you have to start the programming of this TIMER-block from the beginning again.
- The content of the TIMER-blocks remains stored in the remote control. You may therefore recall any of the TIMER-blocks to check it or correct it as and when you please.

How do I recall and transmit stored TIMER-blocks?

- 1 Press button **RC**.
The TIMER-block you used last, will appear on the remote control display. All its programming details will be displayed.
- 2 Using buttons **+** or **-** you may recall the other TIMER-blocks.
- 3 By pressing button **O**) you may now transmit all stored TIMER-blocks one by one to the video recorder.

How can I check or correct TIMER-block details

- 1 Press button **●** on the video recorder or button **●RC** on the remote control.
- 2 Press buttons **+** or **-** or the digit buttons **0-9** to select the required TIMER-block to be checked or corrected.
- 3 Now press button **●** repeatedly. The display shows the starting time, the ending time, the date and the programme number one after another.
You can change the details by pressing buttons **+** or **-** or the digit buttons **0-9**.
- 4 Finally, press button **●** or **●RC** once more.
- 5 If you have used the remote control, transmit the changed programming details to the video recorder by pressing button **○**.

How can I cancel a TIMER-block

- 1 Press button **●** on the video recorder or button **●RC** on the remote control.
- 2 Press buttons **+** or **-** or the digit buttons **0-9** to select the required TIMER-block to be cancelled.
- 3 Press button **X**. The TIMER-block has now been cancelled.
- 4 If you have used the remote control, transmit the data to the video recorder by pressing button **○**, so that here too the block will be cancelled.

OTHER RECORDING POSSIBILITIES

8

Recording from an external source

With this video recorder it is possible to make recordings from external sources, as for example copying onto this video recorder from another video recorder. To do this you need a 21-pin AV-euroconnector. Your dealer can advise you which cable to use.

- 1 Connect this video recorder to the other set, from which you wish to make a recording, e.g. to a second video recorder. For this connect the corresponding 21-pin sockets on both sets (socket **EXTERNAL 1**) using an AV-Eurocable.

A note: In the following description this video recorder is to serve as the one on which is being recorded and will be referred to as **VCR B**.

The second video recorder will be used for playback and will be referred to as **VCR A**.

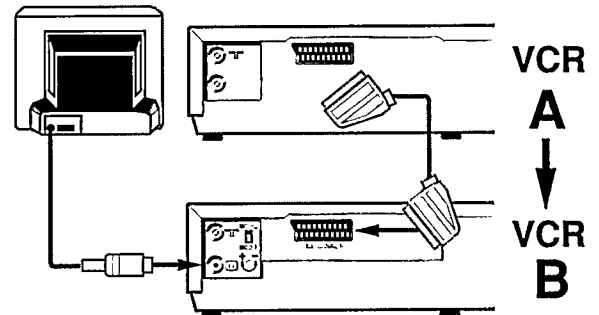

- 2 Insert the pre-recorded cassette into **VCR A** and a cassette into **VCR B**.
- 3 Select the programme number 'E1' on **VCR B**. 'E1' is next to programme number 'P 01'. Select it by pressing buttons **+** or **-**.
- 4 To start the recording press the record button **●** on **VCR B** and the play button **▶** on **VCR A**.
- 5 When you want to finish copying, press the stop button **■** on both video recorders.

PARTICULAR FUNCTIONS AND EXTRAS

9

Apart from the functions that have already been described, your video recorder has other special functions and extras designed to make operating the video recorder as convenient as possible. In the following chapter we will tell you more about them.

Your video recorder as an extension of your TV set (Tuner-mode)

You may also use your video recorder for the reception of TV channels (Tuner). This is practical if your TV set has no remote control or if it has less programme number locations than the number of the TV channels actually received.

And this is how to go about it:

- 1 Switch on the TV set and select the programme number reserved for the video recorder playback.
- 2 Press button **TUNER**. The display will show e.g.:

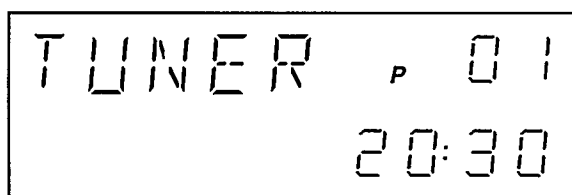

- 3 Press buttons **+** or **-** or the digit buttons **0-9** to select the TV channel you wish to watch on the TV screen.
- 4 Press button **⏻** to switch off the video recorder when you don't want to watch TV any more.

Attention! Timed recordings cannot be carried out when 'TUNER' (Tuner-mode) is indicated by the display.

Emergency switch off

You can interrupt all the functions of this video recorder by pressing button **⏻**. Only the child lock function (see below) cannot be interrupted.

Child lock

With this function you may prevent the unauthorized operation of your video recorder as all the button functions are blocked. If a button is pressed then 'IGNOR' flashes for awhile on the display. But don't worry: Timed recordings can be carried out when the child lock is active and cannot be interrupted.

- 1 To use the child lock first switch off the video recorder. Press and hold the button **🔑** for a couple of seconds, until the display shows the symbol **🔒**. The child lock is now switched on.
- 2 If you wish to switch off the child lock, press button **🔑** again. The symbol **🔒** disappears from the display.

Automatic switch-off

If the video recorder isn't operated for longer than about 8 minutes during one of the following functions, the function will be switched off. This avoids tape wear and reduces unnecessary power consumption.

The video recorder is:

- in STOP after 8 minutes it switches off
- in EJECT after 8 minutes it switches off
- in PAUSE after 8 minutes it switches off
- in STILL after 8 minutes it switches to PLAY
- in SCAN 7 after 8 minutes it switches to PLAY
- in SLOW after 8 minutes it switches to PLAY (VR302)

Auto-dimmer

You may choose the brightness of the display indication when the video recorder is switched off.

Switch the video recorder off and select the brightness of your choice by pressing buttons **+** or **-**.

The buttons **+** / **-** and **0-9**

You have already got to know some of the functions of these buttons. Here follows a short summary.

Using the buttons **+** or **-** or the digit buttons **0-9** you can:

- select a TV programme number
- enter a time or number indication
- select channel numbers

If you wish to enter more digits programme numbers:

- 1 Press button **↵**. The video recorder display shows '---'.
- 2 Enter the required number.
- 3 If you wish to return to single digit entry press button **↵** again. The video recorder display shows again '---'.

VHS cassettes can be used on one side only. Previous recordings on a videocassette are automatically erased when you re-record on the cassette.

You may prevent accidental erasing of an important recording by breaking off the erase tab on the rear edge of the cassette with a screwdriver.

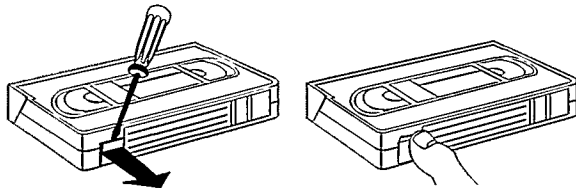

If you decide to record on the tape again, cover the hole from which the tab was removed with adhesive tape.

Replace any partly detached adhesive tape.

What you should do:

Buy only high quality cassettes. Cassettes of inferior quality make your video recorder and the valuable video heads dirty.

Do not:

dismantle the cassette
touch the tape
drop or shake the cassette

Storing cassettes:

Always rewind the tape to the beginning before storage. Always store the cassette **in its case and vertically**.

Keep the cassettes away from:

extreme humidity
dust
bright sunlight and heating sources
magnetic sources, as loudspeakers, transformers, magnets and so on.

Symptom	Possible cause
The video recorder does not respond to any button being pressed.	No power supply. The child lock is activated. Technical disturbance: disconnect from the mains for 30 sec. Timed recording is taking place.
No playback functions are possible	No recording on the cassette. The end of tape has been reached. The programme number for the video recorder has not been selected or correctly stored.
Video recorder playback quality is poor	For hired recordings: use the 'Auto-tracking' button. Poor quality or badly worn cassette. Loose aerial cable/ AV-Euroconnector. The  channel control hasn't been properly adjusted.
Recording is not possible	TV channel hasn't been stored. A wrong programme number has been chosen. Cassette is protected against erasure.
Timed recording does not start	Recording data is incorrect. Clock on the video recorder isn't correctly set. Cassette is protected against erasure. The end of tape has been reached. Video recorder was in 'Tuner mode'.
Remote control does not work	Batteries are exhausted. Influence from fluorescent lamps or bright sunlight. TV/VCR selector is in TV position. VCR1/VCR2 definition is wrong.

TECHNICAL DATA *
ACCESSORIES

12

General

Mains voltage	220 to 240 V
Mains frequency	48 to 52 Hz
Power consumption	16 W typical (9 W typ.in standby)
Wind/rewind time	240 sec. typical for E-180
Ambient temperature during operation	+ 10 °C to +35 °C
Humidity	20% to 80%
Dimensions	420 x 350 x 89 mm (incl.feet)
Weight	6,5 kg approx.
Position for use	max. 15° inclination on all sides
Video resolution	> 240 lines
Audio	80Hz-10KHz (< 8dB)

This product complies with the Radio Interference requirements of the Council Directive (82/499/EEC).

* Data subject to change without notice.

Packed with this video recorder are:

- Aerial cable
- Remote control unit and batteries
- Mains cable

NOTES

NOTES

NOTES

NOTES

NOTES

NOTES

- GB** IDENTITY CARD This card, together with the terms of guarantee (to be provided by your dealer), forms the full certificate of guarantee for this appliance.
- D** GERÄTE-KENNKARTE Diese Karte ist, zusammen mit den Garantiebestimmungen, die Ihr Händler Ihnen aushändigt, Ihr Garantieschein für dieses Gerät.
- F** CARTE D'IDENTIFICATION Associée aux conditions de garantie (qui vous sont remises par le revendeur), cette carte constitue le certificat de garantie de cet appareil.
- NL** IDENTIFICATIEKAART Deze kaart vormt, samen met de garantievoorwaarden (welke door uw dealer verstrekt worden), het garantiebewijs voor dit apparaat.
- I** CARTE D'IDENTIFICAZIONE Questa cartolina rappresenta insieme alle condizioni di garanzia (da consegnare dal vostro rivenditore) il documento di garanzia per questo apparecchio.
- E** TARJETA DE IDENTIFICACIÓN La garantía de este aparato se compone de esta tarjeta y de las condiciones de garantía que le entregará su concesionario.
- P** CARTÃO DE IDENTIFICAÇÃO Este cartão, em conjunto com as condições de garantia em vigor (explicadas pelo seu vendedor) constituem o certificado de garantia do seu aparelho.
- DK** I.D. KORT Dette kort, udfyldt af Deres forhandler, er tilstrækkelig garantidokumentation for dette apparat.
- N** IDENTIFIKASJOKORT Dette kort, sammen med garantibetingelsene (som De får av forhandleren) utgjør garantibeviset for dette apparat.
- S** IDENTIFIKERINGSKORT Detta kort tillsammans med garantivilkoren, som Du får av radiohandlaren, utgör ett fullständigt garantibevis för denna produkt.
- SP** TUNNISTUSKORTTI Tämään laitteen takuutodistus muodostuu tästä kortista ja takuehdoista (jälleenmyyjä antaa mukaan).
- GR** ΔΕΛΤΙΟ ΤΑΥΤΟΤΗΤΑΣ Η καρτέλλα αυτή μαζί με τους όρους εγγυησης (που θα προμηθευθείτε από το κατάστημα που αγοράσατε την συσκευή), αποτελούν το πλήρες πιστοποιητικό εγγυησης της συσκευής σας.



PHILIPS



3103 166 03831

Free Manuals Download Website

<http://myh66.com>

<http://usermanuals.us>

<http://www.somanuals.com>

<http://www.4manuals.cc>

<http://www.manual-lib.com>

<http://www.404manual.com>

<http://www.luxmanual.com>

<http://aubethermostatmanual.com>

Golf course search by state

<http://golfingnear.com>

Email search by domain

<http://emailbydomain.com>

Auto manuals search

<http://auto.somanuals.com>

TV manuals search

<http://tv.somanuals.com>