

PHILIPS **MAGNAVOX**

Video Cassette Recorder

VRX360AT 
Easy Taping.

Owner's Manual

IMPORTANT!

Return Your Warranty Registration Card
Within 10 Days. See Why Inside.

Return your Warranty Registration card today to ensure you receive all the benefits you're entitled to.

Once your PHILIPS MAGNAVOX purchase is registered, you're eligible to receive all the privileges of owning a PHILIPS MAGNAVOX product. So complete and return the Warranty Registration Card enclosed with your purchase at once. And take advantage of these important benefits.

Warranty Verification

Registering your product within 10 days confirms your right to maximum protection under the terms and conditions of your PHILIPS MAGNAVOX warranty.

Owner Confirmation

Your completed Warranty Registration Card serves as verification of ownership in the event of product theft or loss.

Model Registration

Returning your Warranty Registration Card right away guarantees you'll receive all the information and special offers which you qualify for as the owner of your model.

PHILIPS MAGNAVOX

Congratulations on your purchase, and welcome to the "family!"

Dear PHILIPS MAGNAVOX product owner:

Thank you for your confidence in PHILIPS MAGNAVOX. You've selected one of the best-built, best-backed products available today. And we'll do everything in our power to keep you happy with your purchase for many years to come.

As a member of the PHILIPS MAGNAVOX "family," you're entitled to protection by one of the most comprehensive warranties and outstanding service networks in the industry.

What's more, your purchase guarantees you'll receive all the information and special offers for which you qualify, plus easy access to accessories from our convenient home shopping network.

And most importantly you can count on our uncompromising commitment to your total satisfaction.

All of this is our way of saying welcome-and thanks for investing in a PHILIPS MAGNAVOX product.



Sincerely,

Robert Minkhorst
President and Chief Executive Officer

P.S. Remember, to get the most from your PHILIPS MAGNAVOX product, you must return your Warranty Registration Card within 10 days. So please mail it to us right now!



Know these

safety symbols



 This "bolt of lightning" indicates uninsulated material within your unit may cause an electrical shock. For the safety of everyone in your household, please do not remove product covering.

 The "exclamation point" calls attention to features for which you should read the enclosed literature closely to prevent operating and maintenance problems.

WARNING: TO PREVENT FIRE OR SHOCK HAZARD, DO NOT EXPOSE THIS EQUIPMENT TO RAIN OR MOISTURE.

CAUTION: To prevent electric shock, match wide blade of plug to wide slot, and fully insert.

ATTENTION: Pour éviter les chocs électriques, introduire la lame la plus large de la fiche dans la borne correspondante de la prise et pousser jusqu'au fond.

For Customer Use

Enter below the Serial No. which is located on the rear of the cabinet. Retain this information for future reference.

Model No. _____
Serial No. _____

PHILIPS MAGNAVOX visit our World Wide Web Site at <http://www.magnavox.com>

Welcome to your VCR owner's manual.

This manual has seven sections: *Setting Up Your VCR*; *Description of Controls*; *Basic Operations*; *Recording*; *Playing*; *Stereo Features*; and *Information You May Need*. The instructions explain all of the VCR's features, which are listed below. You cannot hurt your VCR by trying the features! So read on – and relax.

Features

- HQ (High Quality) System
- Automatic Channel Programming
- On-Screen Displays in English or Spanish
- Display Panel
- MTS (Multi-Channel Television Sound) System
- Hi-Fi Stereo Sound System
- Automatic Tracking Adjustment
- One Touch Recording
- Unattended (Timer) Recording
- Special Effects Playback: Forward and Reverse Searching; Still; Slow Motion
- Remote Control With Capability to Operate TV, Cable Box, and Digital Satellite System
- Repeat Playback
- Automatic Operation Features
- Real Time Counter
- Daylight-Saving Time
- The VCR Plus+ Programming System
- Time Search Function
- Automatic Head Cleaner

Safety Precautions

Warning: To prevent fire or shock hazard, do not expose this equipment to rain or moisture.

FCC Warning: Any unauthorized changes or modifications to this equipment void the user's authority to operate it.

This VCR, equipped with a HQ (High Quality) system, is compatible with existing VHS (video home system) equipment. Philips Consumer Electronics Company recommends that you use only video cassette tapes that have been tested and inspected for use in two, four, six, and eight hour VCRs, and which are labeled with the **VHS** mark. The use of tapes that have not been inspected for use in two, four, six, and eight hour VCRs may result in poor picture quality and excessive deposits on the video heads, which may not be covered by the warranty if damage occurs.

Note to the Cable TV System Installer: This reminder is provided to call the Cable TV system installer's attention to Article 820-40 of the National Electrical Code, which provides guidelines for proper grounding – in particular, specifying that the cable ground shall be connected to the grounding system of the building, as close to the point of cable entry as possible.

Copyright 1997 Philips Consumer Electronics Company. All rights reserved.

VCR Plus+ and PlusCode are trademarks of Gemstar Development Corporation. The VCR Plus+ system is manufactured under license from Gemstar Development Corporation.

Helpful Hint

- Before doing anything else, record the VCR's model and serial numbers in the spaces provided on page two. These numbers will help us assist you if you ever call for help.

4 Table of Contents

Setting Up Your VCR

| | |
|--|-------|
| Introduction | 3 |
| Table of Contents | 4 |
| Before Using Your VCR | 5 |
| Hookups Without a Cable Box | 6-7 |
| Hookups With a Cable Box | 8-9 |
| Hookups With a Stereo TV | 10 |
| Turning on Your VCR | 11 |
| Channel Memory | 12-14 |
| Setting the Clock | 15 |
| Daylight-Saving Time Selection | 16 |
| Language Selection | 17 |
| Setting the Remote to Operate a TV | 18 |
| Setting the Remote to Operate a Cable Box/Digital Satellite System | 19 |

Description of Controls

| | |
|---------------------------|-------|
| Remote Control Buttons | 20-21 |
| On-Screen Status Displays | 22 |
| VCR Display Panel | 23 |
| Front Panel | 24 |
| Rear Panel | 25 |

Basic Operations

| | |
|-----------|----|
| Playing | 26 |
| Recording | 27 |

Recording

| | |
|---|-------|
| Recording One Channel/Watching Another | 28 |
| One Touch Recording | 29 |
| Timer Recording | 30-33 |
| Setting Up the VCR Plus+ Programming System | 34-35 |
| Timer Recording With the VCR Plus+ Programming System | 36-37 |
| Rerecording (Tape Duplication) | 38 |

Playing

| | |
|------------------------------|----|
| Repeat Playback | 39 |
| Time Search | 40 |
| Real Time Counter Memory | 41 |
| Special Effects Playback | 42 |
| Automatic Operation Features | 43 |

Stereo Features

| | |
|---------------------------------------|-------|
| Multi-Channel Television Sound System | 44-45 |
| Hi-Fi Stereo Sound System | 46-47 |

Information You May Need

| | |
|----------------------|-------|
| Helpful Hints | 48-49 |
| Glossary | 50 |
| Specifications | 51 |
| Limited Warranty | 52 |
| Index | 53 |
| Supplied Accessories | 56 |

Before Using Your VCR 5

Putting Batteries in the Remote Control

1

Remove the battery compartment lid on the bottom of the remote control by sliding it in the direction of the arrow.

2

Insert two AA batteries inside the battery compartment with their polarities (+ and – ends) aligned as indicated.

3

Replace the battery compartment lid.

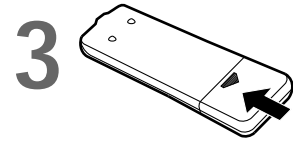
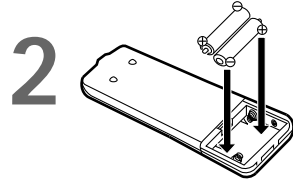
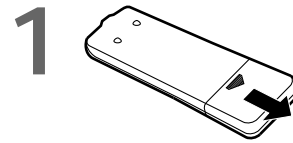

Using the Remote Control

- Point the remote control at the VCR's remote sensor (see page 24) when using the remote control to operate the VCR. Point the remote control at the TV when using the remote control to operate the TV. Point the remote control at the Cable Box or Digital Satellite System when using the remote control to operate the Cable Box or Satellite System.
- Do not put objects between the remote control and the VCR.
- Before you use the remote control to operate your VCR, you must first press the VCR button.
- Before you use the remote control to operate your TV, you must first press the TV button.
- Before you use the remote control to operate your Cable Box or Digital Satellite System, you must first press the CABLE/DSS button.

Erasure Prevention

Video cassette tapes have record tabs to ensure that recordings are not accidentally erased.

1

To prevent accidental erasure, break off the tab with a screwdriver.

2

To record again, cover the hole with cellophane tape.

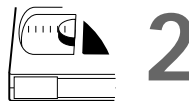
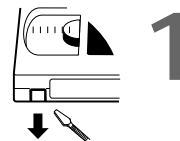

VCR maintenance

- In this VCR, use only tapes with the **VHS** mark.
- Make sure any light adhesive stick-on notes are removed from the video cassette tape before putting the tape in the VCR. Removable labels like these can jam the VCR.
- Periodic maintenance is required to maintain your VCR's excellent performance. This VCR has an Automatic Head Cleaner. However, the video heads will eventually require replacement, which should be performed only by an authorized service center.

Helpful Hints

- The remote control and its batteries are supplied.
- Do not mix alkaline and manganese batteries.
- Do not mix old and new batteries.

6 Hookups Without a Cable Box

The basic VCR/TV connection – antenna/cable to VCR to TV – is shown below. If you have a Cable Box or a descrambler box, please refer to pages eight-nine. If you have a Stereo TV, please go to page 10. After you hook up the VCR, please go to page 11 to turn on the VCR.

1

Disconnect the antenna or cable from your TV.

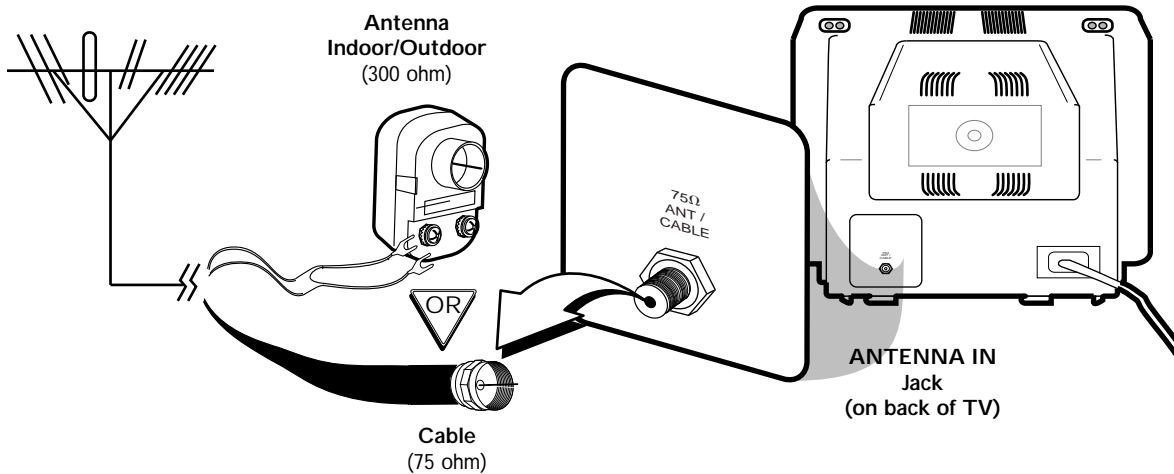

2

Connect the antenna or cable to the ANT(enna) IN jack of your VCR.

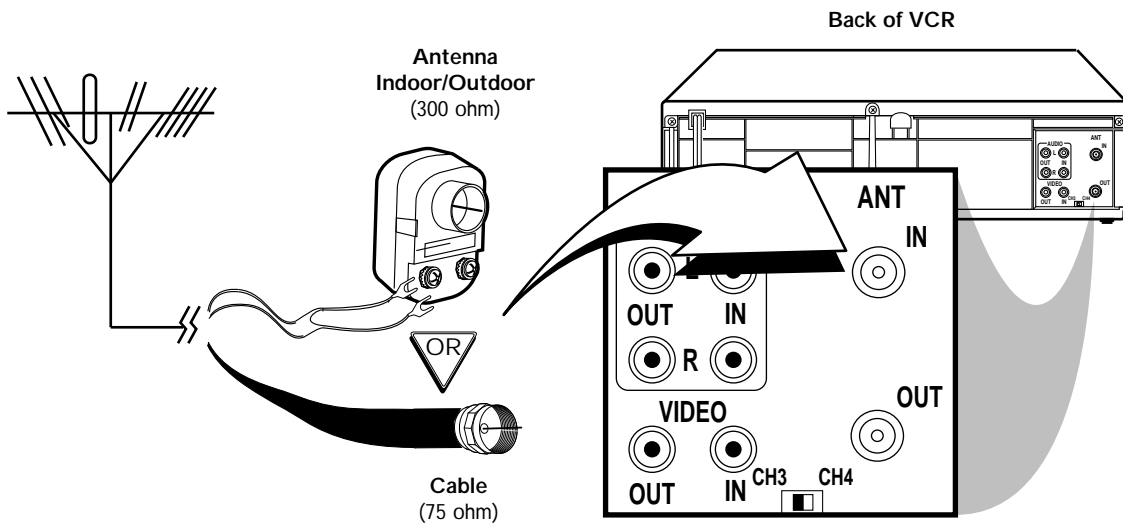

Hookups Without a Cable Box (cont'd) 7

3

Connect the RF coaxial cable (supplied) to the **OUT** jack on the back of the VCR and to the **ANTENNA IN** Jack on the TV. (You may use either a snap-on type or screw-on type of coaxial cable, whichever you prefer. A snap-on type is supplied.)

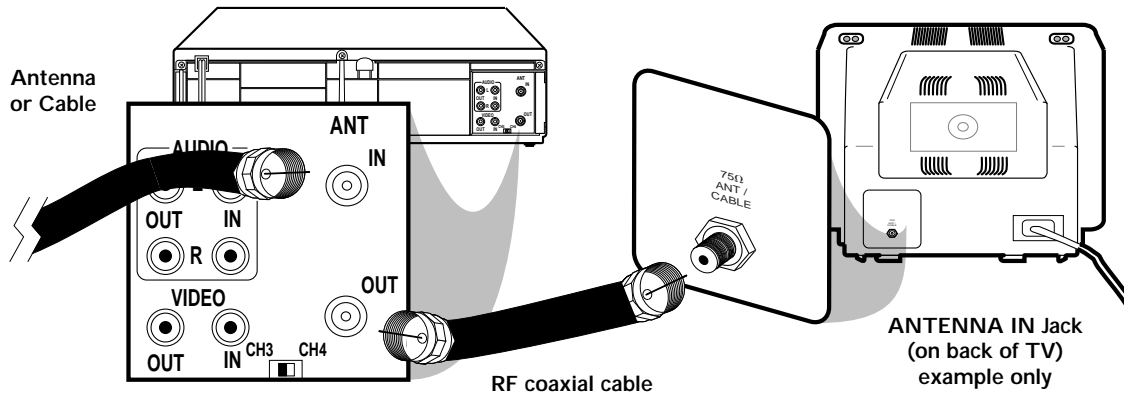

4

Plug in the TV and the VCR.

5

Set the CH3/CH4 switch on the back of the VCR to CH3 or CH4, whichever channel is not used or least used in your area. To operate your VCR with your TV, **set the TV to the same channel**. For example, when playing a tape, if the CH3/CH4 switch is set to CH3, the TV should be on channel 3.

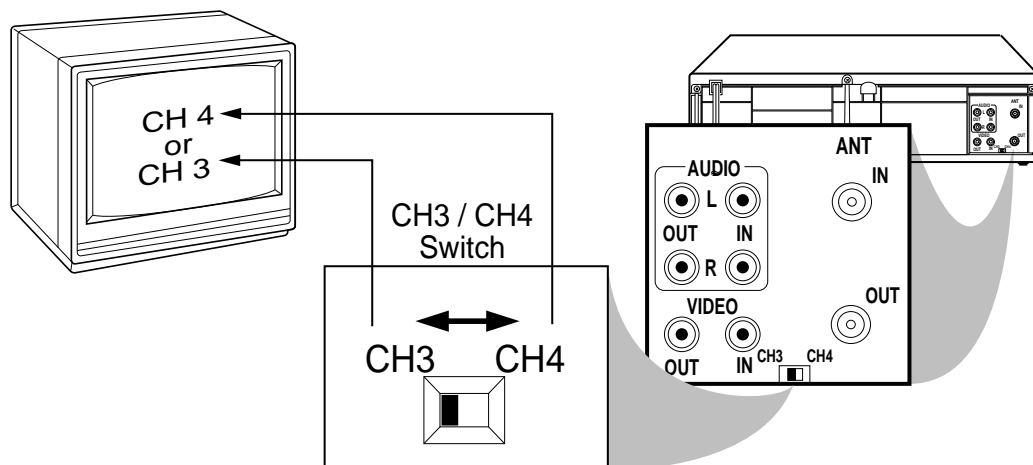

6

You are ready to turn on the VCR. Please go to page 11 before turning on the VCR.

8 Hookups With a Cable Box

This connection allows you to view any channel. After you connect the Cable Box, VCR, and TV as shown below, the features described on this page will be available.

1. Connect Cable signal to IN Jack on Cable Box.

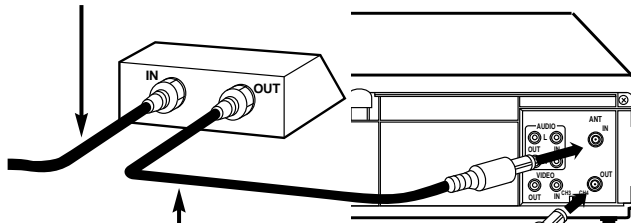

2. Use RF coaxial cable (supplied) to connect OUT Jack on Cable Box to ANT(enna) IN Jack on VCR.

3. Use a second RF coaxial cable to connect the OUT jack on the VCR to the TV's ANTENNA IN Jack.

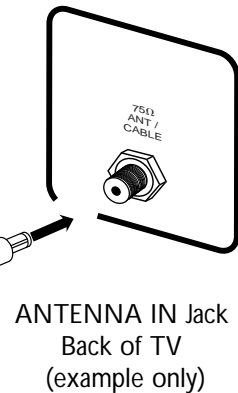

Recording and Viewing a Scrambled or Unscrambled Channel

1

With the VCR on and in VCR position (the VCR light will appear on the display panel), use the **CHANNEL (Up/Down) buttons** to set the VCR to the Cable Box output channel (channel 3 or 4).

2

Set the TV to the same channel to which you set the VCR.

3

Select the channel you want to watch or record at the Cable Box.

Watching TV With the VCR Off

1

Use the TV channel selector to set the TV to the Cable Box output channel (channel 3 or 4).

2

Select the channel you want to watch at the Cable Box.

Timer Recordings

With this connection, you may set a timer recording as described on pages 30-33. However, you must remember the following:

- You can only program a timer recording for one channel at a time.
- Set the TV and the VCR to the Cable Box output channel (channel 3 or 4).
- When you are prompted to enter the channel you want to record, select channel 3 or 4 (the Cable Box output channel). (This is step 5 on page 31.)
- Set your Cable Box to the channel you want to record.
- Leave the Cable Box on while you are recording.

Helpful Hints

- With this hookup, channels cannot be changed at the VCR. You must select channels at the Cable Box.
- You can not view a channel other than the one you are recording (the instructions on page 28 do not work with this hookup).
- You cannot program channels with this hookup (as discussed on page 12).

Hookups With a Cable Box (cont'd) 9

This connection allows you to program an unattended recording of more than one unscrambled channel and to watch one channel while recording another. After you connect the VCR, Cable Box, and TV as shown below, the features on this page will be available.

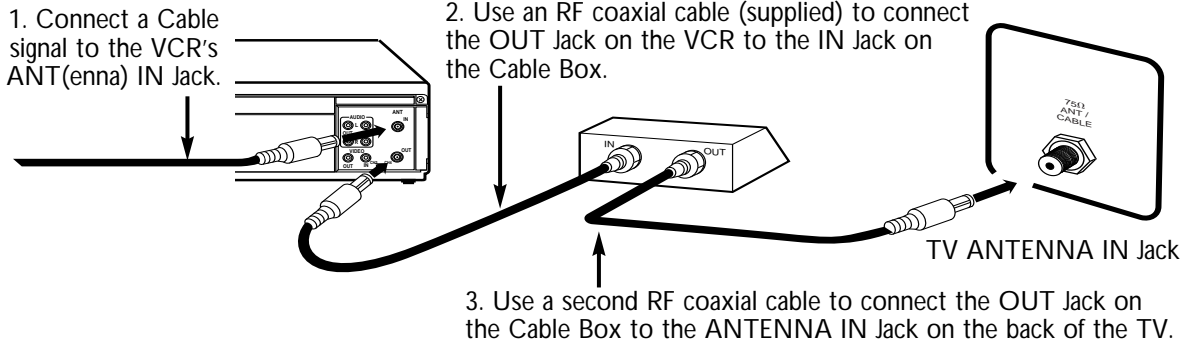

Recording One Channel/Watching Another

1

Put the Cable Box on the same channel as the VCR's CH3/CH4 switch. Then, with the VCR in VCR position (the VCR light will appear on the display panel), use the **CHANNEL (Up/Down) buttons** to select the channel you want to record. Start the recording.

2

Press the **VCR/TV** button once to put the VCR in TV position.

3

Use the TV channel selector to **put the TV on the Cable Box output channel (channel 3 or 4)**.

4

Select the channel you want to watch at the Cable Box.

Playing a Tape

1

Press the **VCR/TV** button to put the VCR in VCR position (the VCR light will appear on the display panel).

2

Make sure the Cable Box is on the same channel as the VCR's CH3/CH4 switch.

3

Use the TV channel selector to **put the TV on the Cable Box output channel (channel 3 or 4)**.

4

Press the **PLAY** button to play the tape.

Helpful Hint

- You cannot record scrambled channels with this connection.

10 Hookups With a Stereo TV

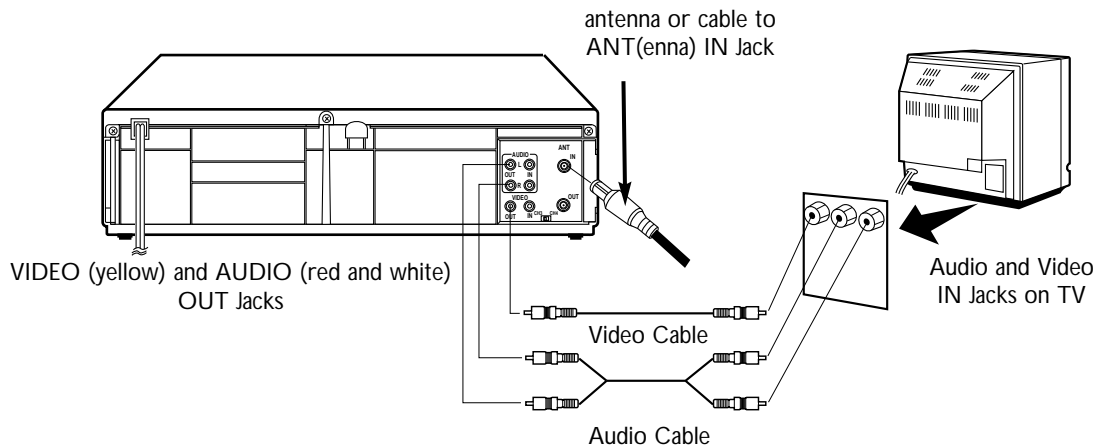

- Audio and Video cables are not supplied.

1

Connect the antenna or cable to the ANT(enna) IN Jack on the back of the VCR.

2

Connect a video cable to the yellow VIDEO OUT Jack on the back of the VCR. Then, connect the other end of the video cable to the VIDEO IN Jack on your TV.

3

Connect an audio cable to the red and white AUDIO OUT Jacks on the back of the VCR. Then, connect the other end of the audio cable to the AUDIO IN Jacks on your TV.

4

Turn on your TV, making sure it is in Line Input mode. Please refer to your TV owner's manual for details.

Helpful Hints

- A stereo audio cable (not supplied) is used here to deliver audio to the TV's left and right channels.
- The TV must be in Line Input mode. Please refer to your TV owner's manual.

Turning on Your VCR 11

Before turning on your VCR, make sure there are batteries in the remote control and the VCR and TV are connected correctly.

- Follow the steps on this page only when you plug the VCR power cord into the wall outlet for the first time.
- You may not be able to program channels at step 5 if you are using a Cable Box.

1

Turn the TV on. Set it to the same channel as the CH3/CH4 switch on the back of the VCR.

2

Press the VCR button, then the POWER button to turn on the VCR. The VCR light and the PWR. light will appear on the VCR display panel. The language select display screen shown below will appear. (If it does not appear, follow the steps on page 12 to program channels and page 17 to select a language.)

TO SELECT PUSH NO. SHOWN
1 ENGLISH ON
2 ESPAÑOL

MAKE SELECTION OR
PUSH MENU TO CONTINUE

3

Press the Number 1 button to select English on-screen displays. ON will appear to the right of ENGLISH on-screen. Or, press the Number 2 button for Spanish on-screen displays. SI will appear to the right of ESPAÑOL on-screen.

4

Press the MENU button. The channel program display shown below will appear. The display will disappear after about 60 seconds if you do not press any buttons.

CONNECT ANTENNA OR CABLE
TO VCR
THEN . . .
PUSH CH UP KEY

OR . . .
FOR PLAY ONLY – PUSH STOP

5

Press the CHANNEL (Up) button to begin automatic channel programming. AUTO SET PROCEEDING PLEASE WAIT will appear on-screen. The VCR will place all of the channels you receive into its memory, so when you scan through channels using the CHANNEL (Up/Down) buttons, you'll only scan through channels that you receive. When all channels are programmed, CHANNELS ARE SET will appear on-screen briefly. Then the TV will go to the lowest channel programmed.

1 Turn on the TV.

2

3

5

4

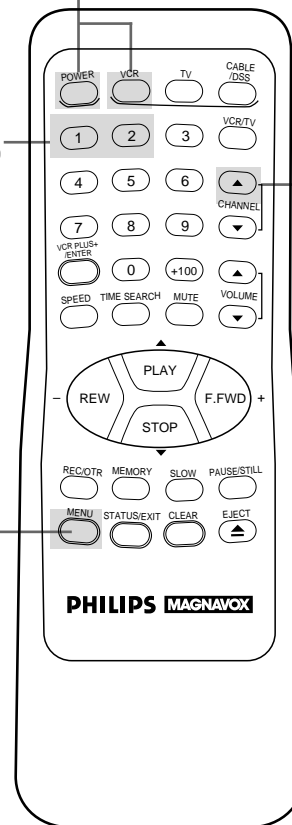

Helpful Hints

- To skip this feature and play a tape immediately, insert a tape with its record tab removed. Or, to skip step 3, press the MENU button. All on-screen displays will be in English. To skip step 5, press the STOP button. Channels will not be programmed, and CHANNELS NOT SET will appear on-screen.
- If you try to program channels when there is no antenna or cable connected to the VCR, programming will appear to take place, but eventually a NO TV SIGNALS message will appear on-screen. Connect an antenna or cable to the VCR and try again. You may need to follow the steps on page 12.

12 Channel Memory

Programming Channels

Although your VCR may automatically memorize the channels you receive when you turn it on for the first time, this function lets you reprogram channels.

1

Press the **VCR** button, then the **MENU** button to bring up the main menu display.

TO SELECT PUSH NO. SHOWN

- 1 PROGRAM
- 2 VCR SET UP
- 3 TUNER SET UP
- 4 SET CLOCK

TO END PUSH EXIT

2

Press the **Number 3** button to select TUNER SET UP.

TO SELECT PUSH NO. SHOWN

- 1 TV
- 2 CABLE TV ON
- 3 AUTO PROGRAMMING ON
- 4 ADD/DELETE CH
- 5 CH MEMORY REVIEW ON
- 6 TV STEREO ON
- 7 2ND AUDIO

TO END PUSH EXIT

3

Press the **Number 1** button to select **TV** (if you have an antenna) or the **Number 2** button to select **CABLE TV** (if you have a cable connection). ON will appear to the right of your selection.

4

Press the **Number 3** button to select **AUTO PROGRAMMING**. MEMORIZED CHANNEL / PLEASE WAIT will appear on-screen. The VCR will place all the channels you receive into its memory.

5

Wait for a few minutes while the VCR programs channels. When programming is complete, CHANNELS ARE SET will appear on-screen. Then the programming of the lowest channel number placed in the VCR's memory will appear on-screen. Now when you press the **CHANNEL** (Up/Down) buttons, you will scan only through channels you receive.

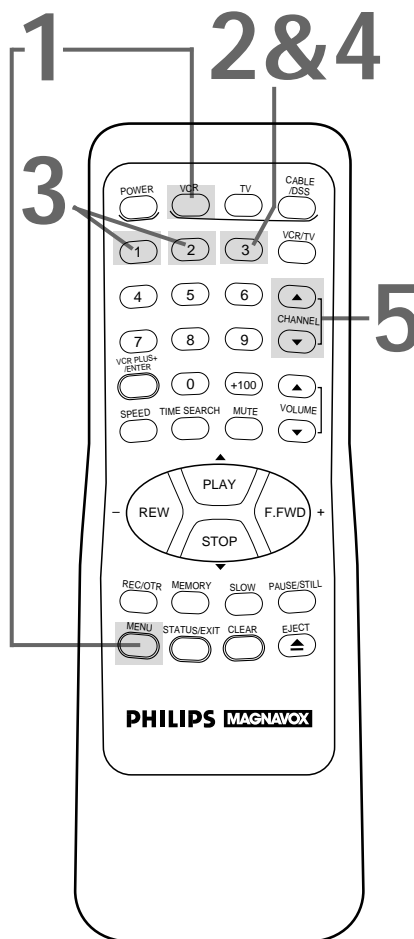

Helpful Hints

- You can not enter the TUNER SET UP menu when you are in Line Input mode (channel 00).
- Line Input mode will always be stored in the VCR's memory as channel 00. When you select channel 00 with the CHANNEL (Up/Down) buttons or the Number buttons, A/V IN will appear on the screen briefly.
- You may not be able to program channels if you are using a Cable Box.
- To switch between TV and CABLE TV selection, repeat the steps on this page.

Adding/Deleting Channels

1

Press the **VCR** button, then the **MENU** button to bring up the main menu display.

2

Press the **Number 3** button to select TUNER SET UP.

3

Press the **Number 4** button to select ADD/DELETE CH.

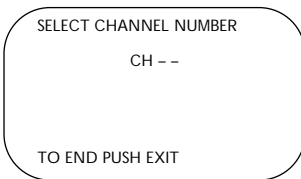

4

Within 60 seconds, press the **Number** buttons to enter the desired channel number.

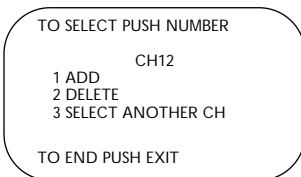

5

Within five seconds, press the **Number 1** button to add that channel or the **Number 2** button to delete that channel. Press the **Number 3** button to leave that channel unchanged and select another channel.

If you do not make a choice within five seconds, you will return to the previous menu display. If this happens, continue from step 4.

6

Press the **STATUS/EXIT** button to exit. The programming of the channel you added or deleted will appear.

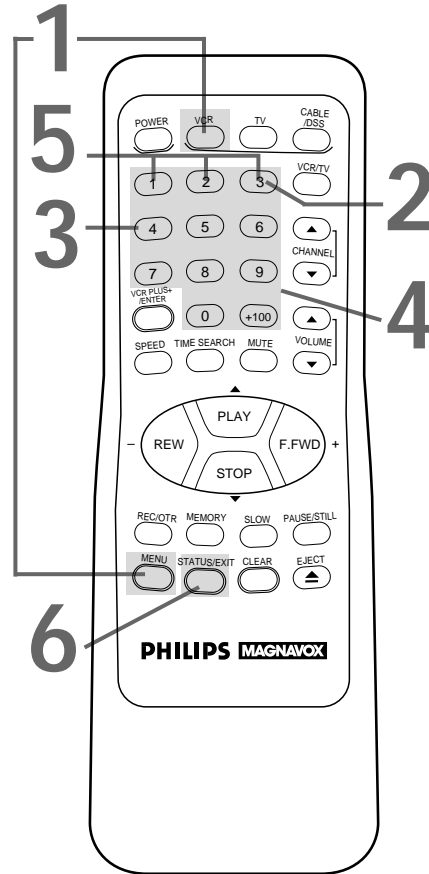

14 Channel Memory (cont'd)

Reviewing Programmed Channels

1

Press the **VCR** button, then the **MENU** button to bring up the main menu display.

TO SELECT PUSH NO. SHOWN

- 1 PROGRAM
- 2 VCR SET UP
- 3 TUNER SET UP
- 4 SET CLOCK

TO END PUSH EXIT

2

Press the **Number 3** button to select TUNER SET UP.

TO SELECT PUSH NO. SHOWN

- 1 TV
- 2 CABLE TV ON
- 3 AUTO PROGRAMMING
- 4 ADD/DELETE CH
- 5 CH MEMORY REVIEW
- 6 TV STEREO ON
- 7 2ND AUDIO

TO END PUSH EXIT

3

Press the **Number 5** button to select CH MEMORY REVIEW. A list of programmed channels will appear on-screen.

- If all the programmed channels don't fit on the screen, press the Number 1 button to see the remaining channels. Then press the Number 2 button to return to the first screen of channels.
- If you do not press any buttons within 10 seconds, you will either go to the next screen of channels or you will return to the previous menu display.

4

Press the **STATUS/EXIT** button twice to exit.

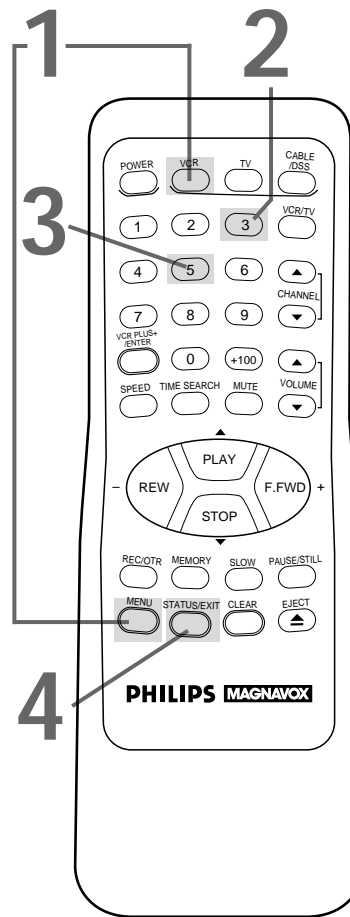

Setting the Clock 15

Setting the Clock

Follow the steps below to set your VCR's clock. Make sure:

- The VCR is on and the VCR light appears on the display panel. (If it does not, press the VCR/TV button once.)
- You make each entry within 60 seconds of the previous entry. If you do not, you may start over.

1

Press the **VCR** button, then the **MENU** button to bring up the main menu display.

TO SELECT PUSH NO. SHOWN
1 PROGRAM
2 VCR SET UP
3 TUNER SET UP
4 SET CLOCK

TO END PUSH EXIT

2

Press the **Number 4** button to select SET CLOCK. Then, press the **Number 1** button to select SET CLOCK.

SET CLOCK

1 SET CLOCK
2 DAYLIGHT SVG TIME [ON]

TO SELECT PUSH NO. SHOWN
TO END PUSH EXIT

3

Press two **Number** buttons for the hour(s) and two **Number** buttons for the minute(s). Then press **1** for AM or **2** for PM. For example, for 2:15 PM, press 02, 15, 2.

TIME 02 :15 PM
MONTH --/--/--

TO CORRECT PUSH CLEAR
TO END PUSH EXIT

4

Press two **Number** buttons for the month, two **Number** buttons for the day, and two **Number** buttons for the year. For example, for July 1, 1997, press 07, 01, 97. The day of the week will appear automatically.

TIME 02 :15 PM
DATE 07 / 01 / 97
TUE.

TO CORRECT PUSH CLEAR
TO END PUSH EXIT

5

Press the **STATUS/EXIT** button to start the clock. The screen will return to the program you were watching.

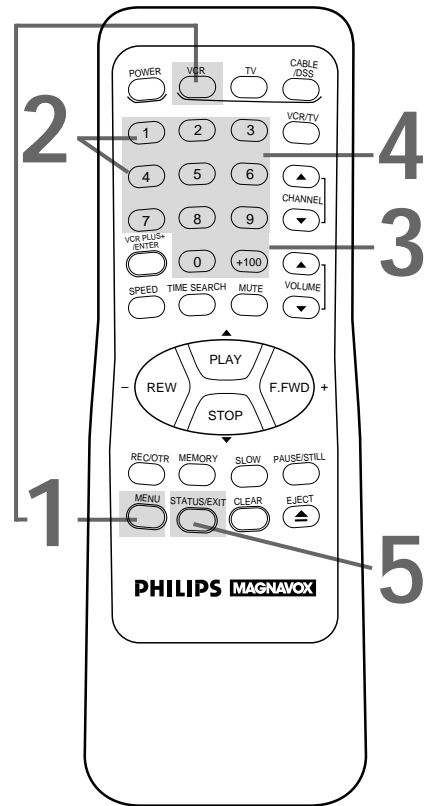

Helpful Hints

- Enter a 0 before a single digit number.
- Entries that do not match the VCR's internal calendar will cause a question mark (?) to appear on-screen.
- To make corrections, press the CLEAR button until the space for the number you want to correct is flashing. Then enter the correct number.
- The current time will appear on the VCR display panel when the clock is set. The current time will also appear on-screen if you press the STATUS/EXIT button. (See page 22 for details.)
- To reset the clock, follow the steps on this page.
- Power failures that last for more than one minute can cause you to lose your clock setting. If this happens, repeat the steps on this page.
- If you press the STATUS/EXIT button while you are setting the clock, the TV screen will return to the program you were watching. If this happens, start over.

16 Daylight-Saving Time Selection

Daylight-Saving Time Selection

You may program the VCR so its clock will automatically move forward one hour in April and turn back one hour in October. Daylight-Saving Time is set to ON prior to shipment from the factory.

You may turn Daylight-Saving Time ON or OFF by following the steps below.

1

With the clock set, **press the VCR button, then the MENU button** to bring up the main menu display.

TO SELECT PUSH NO. SHOWN
1 PROGRAM
2 VCR SET UP
3 TUNER SET UP
4 SET CLOCK

TO END PUSH EXIT

2

Press the Number 4 button to select SET CLOCK.

SET CLOCK
1 SET CLOCK
2 DAYLIGHT SVG TIME [ON]

TO SELECT PUSH NO. SHOWN
TO END PUSH EXIT

3

Press the Number 2 button so that ON or OFF appears to the right of DAYLIGHT SVG TIME.

SET CLOCK
1 SET CLOCK
2 DAYLIGHT SVG TIME [ON]

TO SELECT PUSH NO. SHOWN
TO END PUSH EXIT

4

Press the STATUS/EXIT button to exit.

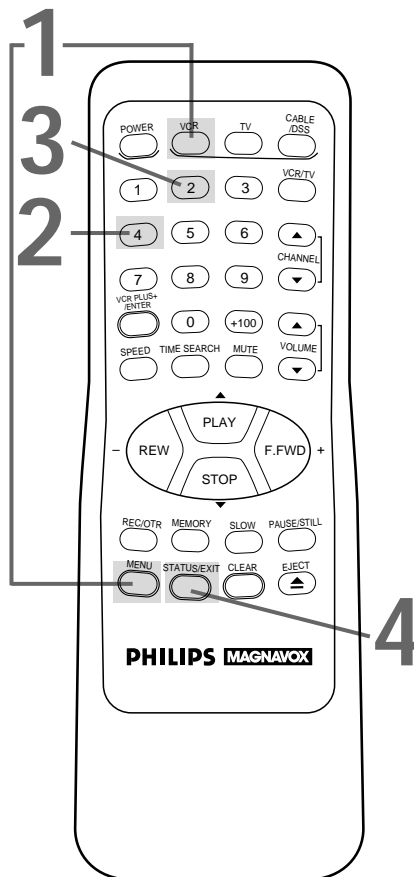

Language Selection 17

Language Selection

Follow the steps below to change the language of the on-screen displays.

1

Press the **VCR** button, then the **MENU** button to bring up the main menu display.

TO SELECT PUSH NO. SHOWN

- 1 PROGRAM
- 2 VCR SET UP
- 3 TUNER SET UP
- 4 SET CLOCK

TO END PUSH EXIT

2

Press the **Number 2** button to select VCR SET UP.

TO SELECT PUSH NO. SHOWN

- 1 REPEAT PLAY OFF
- 2 ON SCREEN MODE
- 3 AUDIO OUT
- 4 LANGUAGE
- 5 VCR PLUS+ REF. MAP

TO END PUSH EXIT

3

Press the **Number 4** button to select LANGUAGE.

TO SELECT PUSH NO. SHOWN

- 1 ENGLISH ON
- 2 ESPAÑOL

MAKE SELECTION OR
PUSH MENU TO CONTINUE

4

Press the **Number 1** button if you want the on-screen displays in English. ON will appear to the right of ENGLISH on-screen. **Or**, press the **Number 2** button if you want the on-screen displays in Spanish. SI will appear to the right of ESPAÑOL on-screen.

5

Press the **MENU** button to exit.

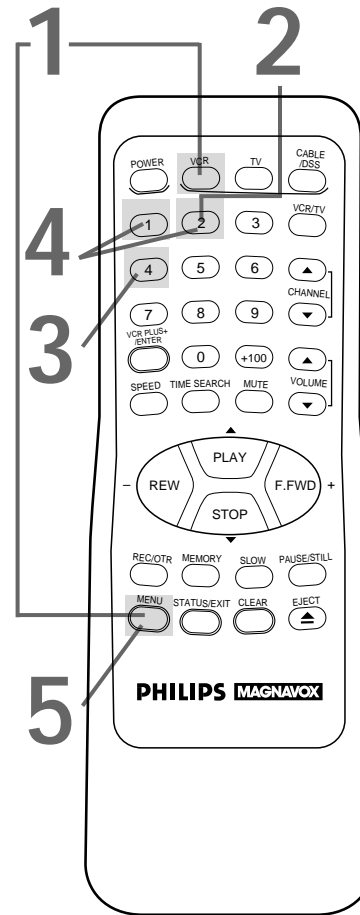

Helpful Hint

- If you accidentally select Spanish on-screen displays and need English on-screen displays:
 1. Press the VCR button.
 2. Press the MENU button.
 3. Press the Number 2 button to select PREPARE LA VCR.
 4. Press the Number 4 button to select LENGUAJE.
 5. Press the Number 1 button to select ENGLISH.
 6. Press the MENU button to exit.

18 Setting the Remote to Operate a TV

Your VCR remote control **may** operate your TV. If the remote control doesn't operate your TV now, follow the steps below to program your remote control.

1

Point the remote control at your TV and **press the TV button**. Then, **press the POWER button**. If your TV turns on or off, try the other TV buttons (see pages 20 - 21). If your TV doesn't turn on or off, or if the other buttons don't work, go to step 2.

2

Find the brand of your TV on the list below, and remember the two-digit number to the right of it.

| TV CODES | | | |
|-----------------|-----------------|------------------|-------------|
| EMERSON |14 | PHILCO |14 |
| FISHER |11 | PHILIPS |01 |
| GE |10 | PHILIPS MAGNAVOX | .01, 02, 03 |
| GOLDSTAR |04 | QUASAR |07 |
| HITACHI |12 | RCA |10 |
| JVC |05 | SAMSUNG |17 |
| MAGNAVOX |01, 02, 03 | SANYO |11 |
| MARANTZ |13 | SEARS |08, 11 |
| MITSUBISHI |13 | SHARP |16 |
| MONTGOMERY WARD |14 | SONY |09 |
| PANASONIC |07 | TOSHIBA |08 |
| PANASONIC-GAOO |07 | ZENITH |06, 15 |

3

Press and release the MUTE button.

4

Within 30 seconds after releasing the MUTE button, **press and release the TV button**.

5

Within 30 seconds after releasing the TV button, **use the Number buttons to enter the two-digit code for your TV brand**. For example, if you have a Zenith TV, press Number buttons 1, 5.

6

Try step 1 again. If the remote control works your TV, you're finished. If the remote control still doesn't work your TV, repeat steps 2 - 5, using another code.

There is no guarantee that the remote will work your TV.

1&6 Find your TV code.

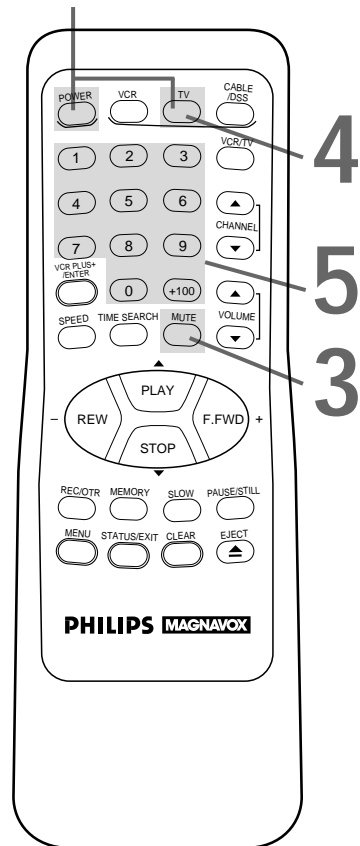

Helpful Hints

- Although the remote control that comes with your VCR will work most Magnavox TVs, as well as many TVs sold under other brand names, it is possible that the remote control will not operate your TV.
- The remote control may only operate some features of your TV. For example, the remote control may turn on the TV power, but it may not change channels at the TV.
- If you can not change the channels at the TV by using the Number buttons, press the VCR PLUS+/ENTER button after you press the Number buttons. It may change channels at the TV.
- If you had to program the remote control to operate your TV here, whenever you replace the batteries in the remote control, you will have to program the remote control again.

Setting the Remote to Operate a Cable Box/Digital Satellite System 19

Your VCR remote control **may** operate your Cable Box or Digital Satellite System. If the remote control doesn't operate your Cable Box or Satellite System now, follow the steps below to program your remote control.

1

Point the remote control at your Cable Box or Satellite System and press the **CABLE/DSS** button. Then, press the **POWER** button. If your Cable Box or Satellite System turns on or off, try the other Cable Box/Satellite System buttons (see pages 20 - 21 for details). If your Cable Box or Satellite System doesn't turn on or off, or if the other buttons don't work, go to step 2.

2

Find the brand of your Cable Box or Satellite System on the list below, and remember the two-digit number to the right of it.

| CABLE BOX CODES | |
|---|---|
| HAMLIN21, 22 | PIONEER11, 12 |
| JERROLD01, 02, 03,04, 05, 06, 07 | SCIENTIFIC ATLANTA08, 09, 10 |
| OAK16, 17, 18 | TOCOM23, 24, 25 |
| PANASONIC19, 20 | ZENITH13, 14, 15 |

| SATELLITE SYSTEM CODES | |
|------------------------|-----------------|
| MAGNAVOX26, 27 | RCA28 |

3

Press and release the **MUTE** button.

4

Within 30 seconds after releasing the MUTE button, press and release the **CABLE/DSS** button.

5

Within 30 seconds after releasing the CABLE/DSS button, use the **Number** buttons to enter the two-digit code for your Cable Box or Satellite System. For example, if you have a Zenith Cable Box, press Number buttons 1, 3.

6

Try step 1 again. If the remote control works your Cable Box or Satellite System, you're finished. If the remote control still doesn't work your Cable Box or Satellite System, repeat steps 2 - 5, using a different code.

There is no guarantee that the remote control will work your Cable Box or Satellite System.

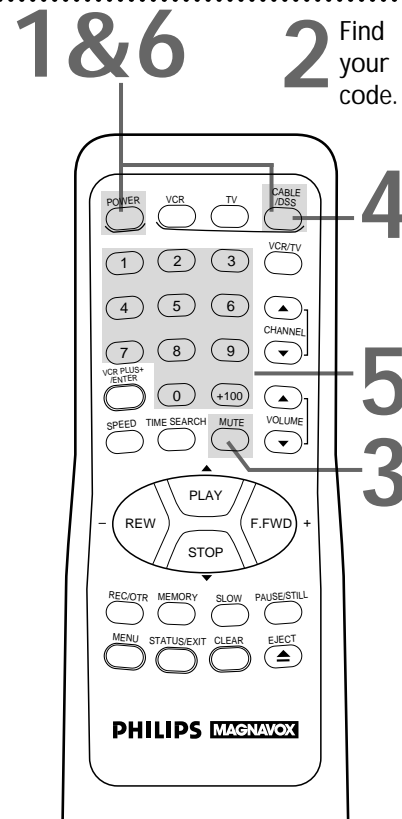

Helpful Hints

- Although the remote control that comes with your VCR will work most Cable Boxes and Satellite Systems, it is possible that the remote control will not operate your Cable Box or Satellite System.
- The remote control may only operate some features of your Cable Box or Satellite System. For example, some Cable Boxes may only be turned on at the Cable Box, therefore the remote control will not be able to turn on the Cable Box.
- If you can not change the channels at the Cable Box by using the Number buttons, press the VCR PLUS+/ENTER button after you press the Number buttons. It may change channels at the Cable Box.
- If you had to program the remote control to operate your Cable Box or Satellite System here, whenever you replace the batteries in the remote control, you will have to program the remote control again.

20 Remote Control Buttons

POWER Button

Press to turn on or off the VCR, TV, Cable Box, or Digital Satellite System. (You must first press the VCR, TV, or CABLE/DSS button.)

Details are on pages 18-19.

Number Buttons

Use to select channels at the VCR, TV, Cable Box, or Digital Satellite System; to select on-screen menus; and to program VCR functions (such as setting the clock).

Channels 1 - 9 ●

To select, press 0, then press the channel you want. For example, to select channel 7, press 0, 7.

Channels 100 and above ●

To select, press the +100 button, then press the last two digits of the channel you want. For example, to select channel 117, press the +100 button, 1, 7.

VCR PLUS+/ENTER Button

Press to set a Timer Recording with the VCR Plus+ programming system. *Details are on pages 34-37.*

When in TV or Cable Box mode, press after pressing the Number buttons to select a channel.

Details are on pages 18-19.

(Tape) SPEED Button

Press to select the recording speed (SP, LP or SLP). *Details are on pages 32 and 50.*

TIME SEARCH Button

Press to fast forward or rewind the tape a specific length of time.

Details are on page 40.

REW(ind) Button

When tape playback is stopped, press to rewind the tape at high speed. During playback, press to rewind the tape while the picture stays on-screen. *Details are on page 42.*

Or, if you have a Magnavox TV, press when in TV mode to adjust (decrease) the picture controls in the TV menu system.

MEMORY Button

Press to memorize a tape position at which the real time counter was set to 0:00:00. *Details are on page 41.*

REC(ord)/OTR Button

Press once to start a recording. *Details are on page 27.*

Or, press three to 18 times to start a one touch recording (an immediate recording, 30 minutes to eight hours long) of the channel you are watching. *Details are on page 29.*

MENU Button

Press to bring up the main menu display. Or, if you have a Magnavox TV, press the TV button, then press to display the Magnavox TV menu.

STATUS/EXIT Button

Press to see the on-screen status display or to remove status displays. *Details are on page 22.* Press to exit on-screen menus.

Or, if you have a Magnavox TV, press when in TV mode to see a status display or to remove the Magnavox TV menu.

PLAY Button

Press to play a tape. Also, press to release Slow, Search or Still mode and to return to normal playback. *Details are on page 42.*

Or, if you have a Magnavox TV, press when in TV mode to move up one row or selection in the Magnavox TV menu.

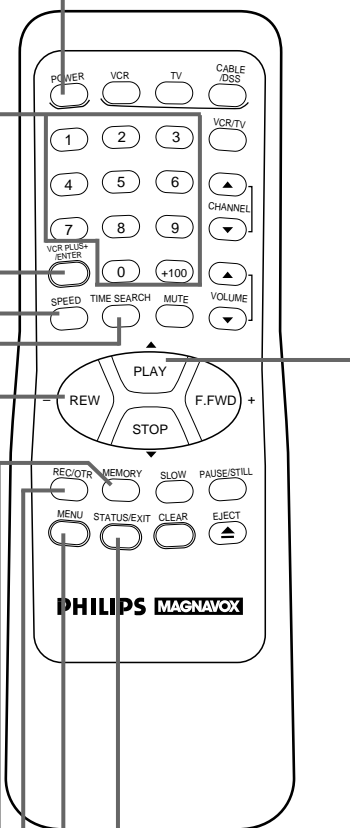

Helpful Hint

- Press the VCR button before pressing other VCR buttons; press the TV button before pressing other TV buttons; press the CABLE/DSS button before pressing other Cable Box/Satellite System buttons.

Remote Control Buttons (cont'd) 21

CABLE/DSS Button
Press to operate the Cable Box or Digital Satellite System. *Details are on page 19.*

TV Button
Press to operate the TV. *Details are on page 18.*

VCR Button
Press to operate the VCR.

VCR/TV Button
Use to select the signal that your TV receives.

VCR Position ●
Use to watch a tape, to watch a program while recording it, or to watch a TV broadcast using the CHANNEL (Up/Down) or Number buttons. If the VCR light appears on the display panel of the VCR, it is in VCR position.

TV Position ●
Use to watch TV or to watch one program while recording another. *Details are on page 28.* If the VCR light does not appear on the display panel of the VCR, it is in TV position.

CHANNEL (Up/Down) Buttons
Press to scan up or down through the VCR, TV, Cable Box, or Digital Satellite System's channels after the channels have been programmed.

VOLUME (Up/Down) Buttons
Press to increase or decrease the TV's volume. *Details are on page 18.*

MUTE Button
Press to eliminate the TV's sound. Press again to restore the volume. *Details are on page 18.*

STOP Button
Press to stop the tape. Or, if you have a Magnavox TV, press when in TV mode to move down one row or selection in the Magnavox TV menu.

SLOW Button
During tape playback, press to view the picture in slow motion. Press again to resume normal playback.

CLEAR Button
Press to erase incorrect data when programming VCR functions. Also, press to reset the real time counter. *Details are on page 41.*

EJECT Button
When playback is stopped, press to eject the tape.

PAUSE/STILL Button
In Record mode, press to temporarily stop the recording (pause). Press a second time to resume normal recording. *Details are on page 27.* You can not pause a one touch recording that is set for a specific length of time. During playback, press to freeze the picture (still). Press a second time to resume normal playback. *Details are on page 42.*

F.FWD (Fast Forward) Button
When in Stop mode, press to fast forward the tape at high speed. When in Play mode, press to fast forward while the picture stays on-screen. *Details are on page 42.*
Or, if you have a Magnavox TV, press when in TV mode to adjust (increase) the picture controls in the TV menu system.

Helpful Hint

- Shaded buttons may also operate features of your TV, Cable Box, or Satellite System.

22 On-Screen Status Displays

A status display, which includes the current time, channel, and other information (see illustration) will appear when you press the STATUS/EXIT button or certain function buttons. The contents of the status display may vary. There are three status display modes:

ON SCREEN ON:

- When you press the STOP button or the PLAY button, the status display appears for five seconds.

COUNTER ONLY:

- When you press the STOP button or the PLAY button, the status display appears for five seconds. After five seconds, only the counter will remain on-screen. Press the STATUS/EXIT button to remove it.

ON SCREEN OFF:

- The status display will not appear when you press function buttons.
- You must press the STATUS/EXIT button to see the status display.

To select a status display mode, follow the steps below.

1

Press the VCR button, then the MENU button to bring up the main menu display.

TO SELECT PUSH NO. SHOWN

- 1 PROGRAM
- 2 VCR SET UP
- 3 TUNER SET UP
- 4 SET CLOCK

TO END PUSH EXIT

2

Press the Number 2 button to select VCR SET UP.

TO SELECT PUSH NO. SHOWN

- 1 REPEAT PLAY OFF
- 2 ON SCREEN MODE
- 3 AUDIO OUT
- 4 LANGUAGE
- 5 VCR PLUS+ REF. MAP

TO END PUSH EXIT

3

Press the Number 2 button to select ON SCREEN MODE.

TO SELECT PUSH NO. SHOWN

- 1 ON SCREEN ON ON
- 2 COUNTER ONLY
- 3 ON SCREEN OFF

TO END PUSH EXIT

4

Press the Number 1 button to select ON SCREEN ON, the Number 2 button to select COUNTER ONLY, or the Number 3 button to select ON SCREEN OFF. ON will appear beside the selected status display mode.

5

Press the STATUS/EXIT button to exit.

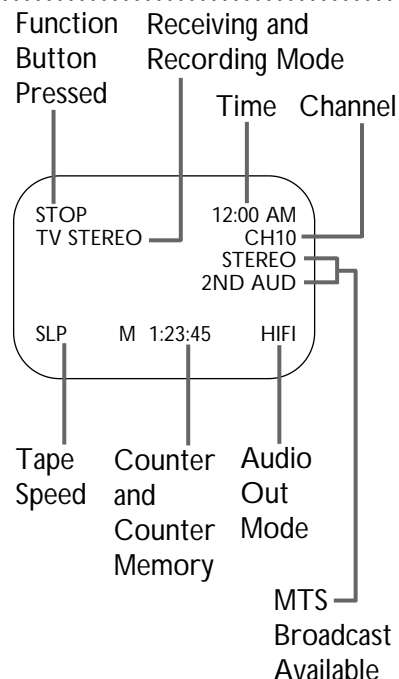

Helpful Hints

- If the channel you select has no broadcast, the screen will become solid blue. The screen will remain blue until you select an active channel.
- You may bring up the status display at any time by pressing the STATUS/EXIT button. (The exception is when viewing a still picture or a slow motion picture, or when F.FWD or REW(ind) is pressed during playback.)
- Channel numbers (when tuned) are displayed for a few seconds.

VCR Display Panel 23

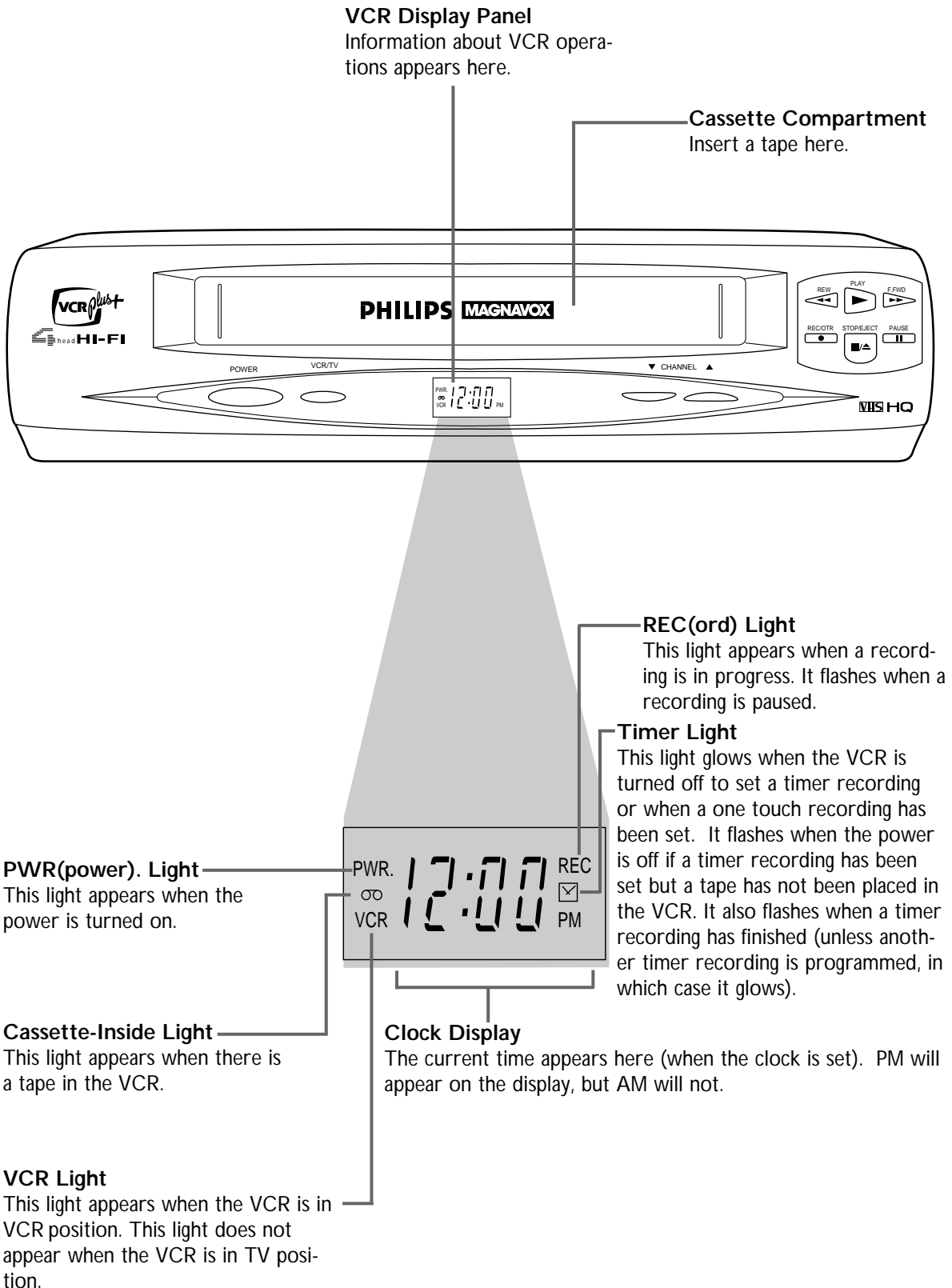

24 Front Panel

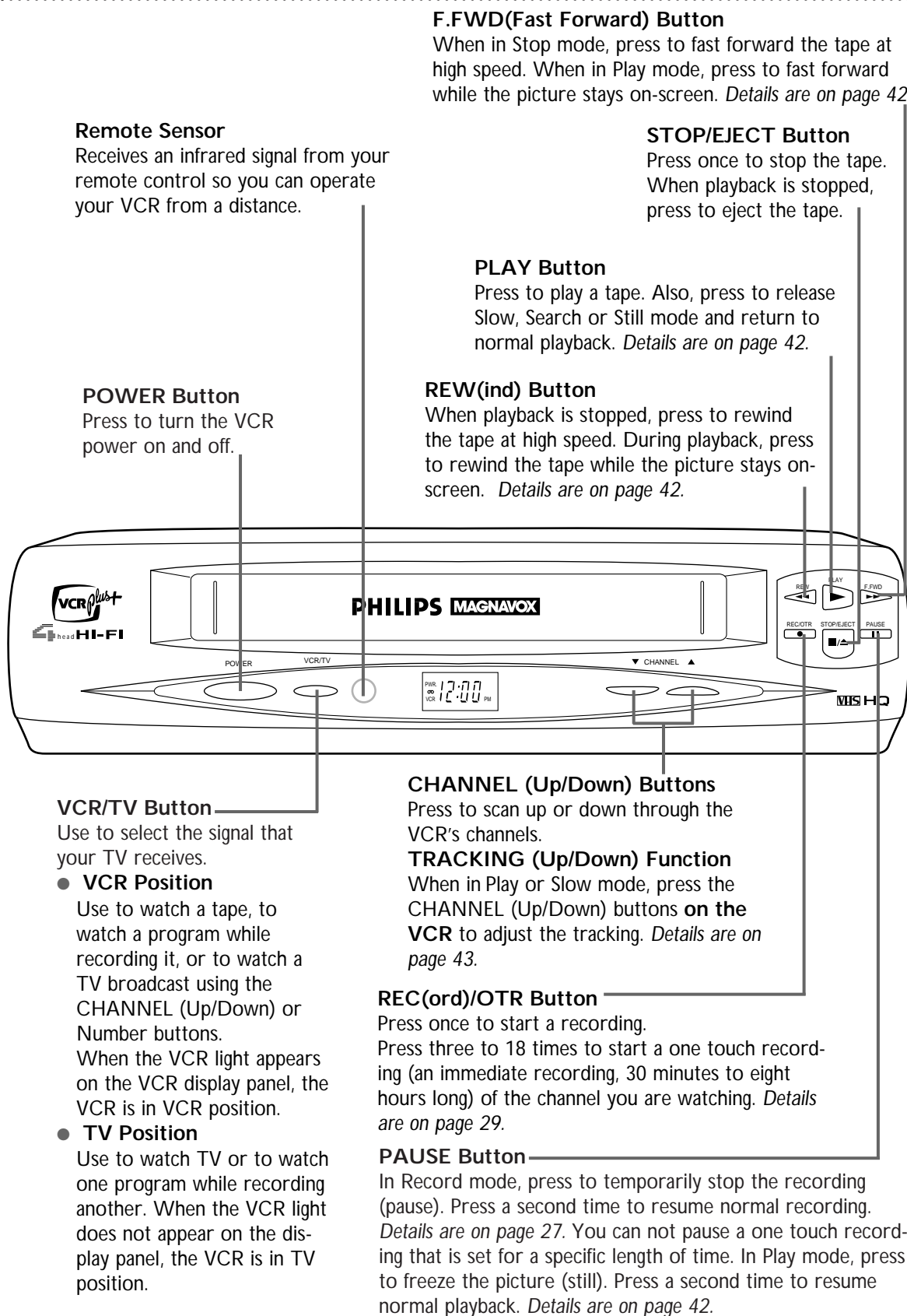

Remote Sensor

Receives an infrared signal from your remote control so you can operate your VCR from a distance.

POWER Button

Press to turn the VCR power on and off.

VCR/TV Button

Use to select the signal that your TV receives.

● VCR Position

Use to watch a tape, to watch a program while recording it, or to watch a TV broadcast using the CHANNEL (Up/Down) or Number buttons.

When the VCR light appears on the VCR display panel, the VCR is in VCR position.

● TV Position

Use to watch TV or to watch one program while recording another. When the VCR light does not appear on the display panel, the VCR is in TV position.

F.FWD(Fast Forward) Button

When in Stop mode, press to fast forward the tape at high speed. When in Play mode, press to fast forward while the picture stays on-screen. *Details are on page 42.*

STOP/EJECT Button

Press once to stop the tape. When playback is stopped, press to eject the tape.

PLAY Button

Press to play a tape. Also, press to release Slow, Search or Still mode and return to normal playback. *Details are on page 42.*

REW(ind) Button

When playback is stopped, press to rewind the tape at high speed. During playback, press to rewind the tape while the picture stays on-screen. *Details are on page 42.*

CHANNEL (Up/Down) Buttons

Press to scan up or down through the VCR's channels.

TRACKING (Up/Down) Function

When in Play or Slow mode, press the CHANNEL (Up/Down) buttons **on the VCR** to adjust the tracking. *Details are on page 43.*

REC(ord)/OTR Button

Press once to start a recording.

Press three to 18 times to start a one touch recording (an immediate recording, 30 minutes to eight hours long) of the channel you are watching. *Details are on page 29.*

PAUSE Button

In Record mode, press to temporarily stop the recording (pause). Press a second time to resume normal recording. *Details are on page 27.* You can not pause a one touch recording that is set for a specific length of time. In Play mode, press to freeze the picture (still). Press a second time to resume normal playback. *Details are on page 42.*

Rear Panel 25

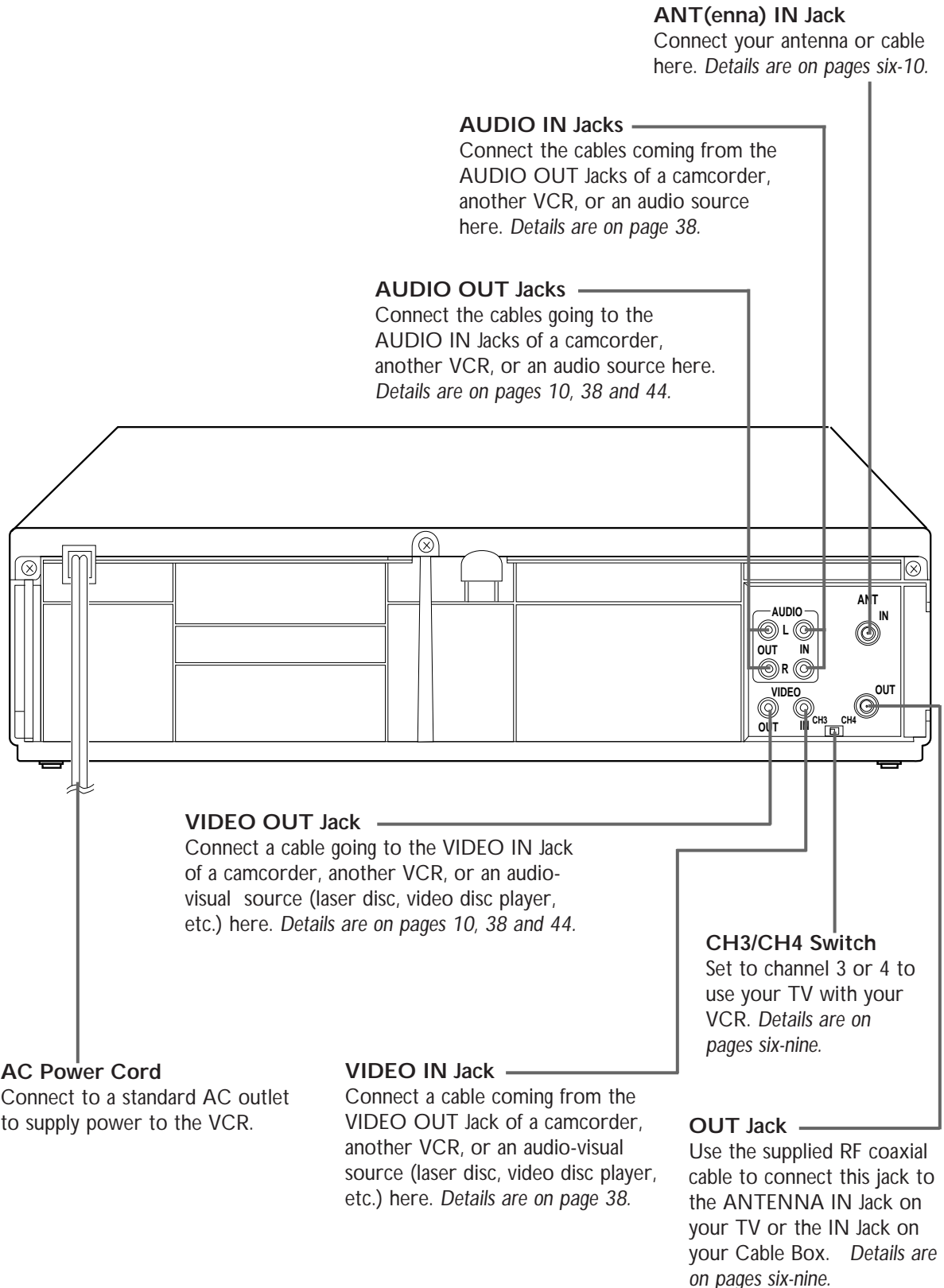

26 Playing

Read and follow the steps below to play a tape.

1

Turn the TV on and set it to channel 3 or 4, whichever the CH3/CH4 switch on the back of the VCR is set to.

2

Insert a tape in the VCR. The power will come on. The VCR will place itself in VCR position automatically (the VCR light and the Cassette-Inside light on the display panel of the VCR will appear). If the tape's record tab has been removed, playback will start automatically.

3

If playback does not start automatically, press the **PLAY** button to start playback.

4

Press the **STOP** button on the remote control or the STOP/EJECT button on the VCR once to stop playback.

5

Press the **REW(ind)** button on the remote control or the REW(ind) button on the VCR to rewind the tape.

6

When playback is stopped, press the **EJECT** button on the remote control or the STOP/EJECT button on the VCR again to remove the tape.

1 Turn on the TV.

2 Insert a tape in the VCR.

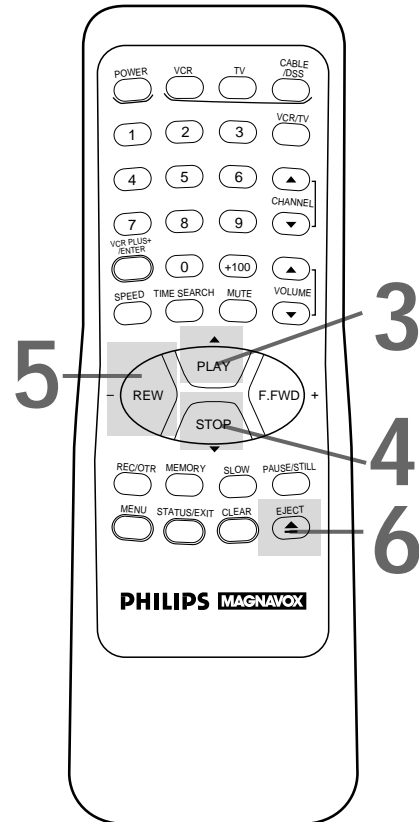

Helpful Hints

- If the tape you want to play is already in the VCR, make sure the VCR power is on and the VCR is in VCR position. (The VCR light will appear on the display panel.) Press the VCR button, then press the PLAY button.
- Other playback options and features are on pages 39 - 43.

Recording 27

Read and follow the steps below to record a television program.

1

Turn the TV on and set it to channel 3 or 4, whichever the CH3/CH4 switch on the back of the VCR is set to.

2

Insert a tape with its record tab intact (see page five) in the VCR. The power will come on, and the Cassette-Inside light will appear.

3

Press the VCR button on the remote control.

4

If the VCR light appears on the display panel of the VCR, go to step 5. If the VCR light does not appear, press the VCR/TV button once.

5

Press the (Tape) SPEED button on the remote control until the desired tape speed (see pages 32 and 50 for details) appears on the TV screen. The tape speed will disappear from the screen after about five seconds.

6

Press the CHANNEL (Up/Down) buttons or the Number buttons to select the channel to be recorded.

7

Press the REC(ord)/OTR button once to start recording. The REC light will appear on the VCR's display panel.

If the REC(ord)/OTR button is pressed when there is not a tape in the VCR, NO CASSETTE will flash on-screen.

8

To pause the recording (for example, during commercials), press the PAUSE/STILL button on the remote control or the PAUSE button on the VCR once. The REC light will flash.

To start recording again, press the REC(ord)/OTR button or the PAUSE/STILL button again. The REC light will come on again.

9

To stop recording, press the STOP button on the remote control.

1

 Turn on the TV.

2

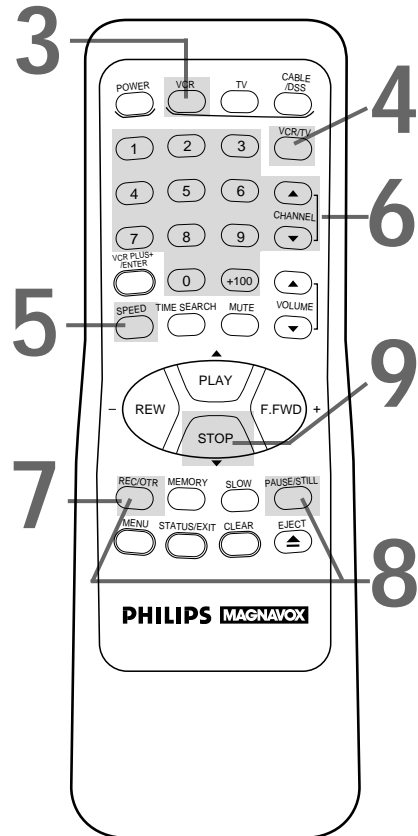
 Insert a tape in the VCR.

Helpful Hints

- If the REC(ord)/OTR button is pressed while a tape without a record tab is in the VCR, the VCR will eject the tape and PROTECTED CASSETTE CANNOT RECORD will flash on-screen.
- Other recording options are on pages 28-38.
- You can change the tape speed while the VCR is recording, but some distortion will appear on the tape.
- The VCR will record in a preset volume.

28 Recording One Channel/Watching Another

1

Start a recording (see page 27).

2

Press the VCR button.

3

Press the **VCR/TV** button to put the VCR in TV position. The VCR light will disappear from the VCR's display panel.

4

Press the **TV** button, then press the **CHANNEL (Up/Down)** or **Number** buttons to choose the channel you want to watch. Or, use the TV remote control to select the channel you want to watch.

5

To return to the channel being recorded, press the **TV** button, then use the **Number** buttons to select channel 03 or 04 (whichever channel the CH3/CH4 switch on the back of the VCR is set to).

Or, if the VCR remote control doesn't operate your TV, use the TV remote control to select channel 3 or 4.

6

Press the VCR button.

7

Press the **VCR/TV** button to put the VCR in VCR position. The VCR light will appear on the display panel. The channel being recorded will appear on-screen.

8

Press the **STOP** button to stop the recording.

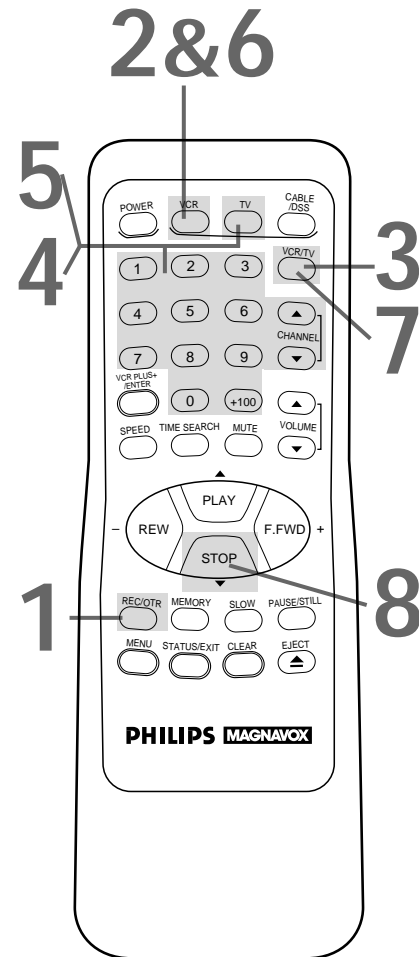

Helpful Hints

- If your remote control operates your TV, press the TV button, then use the CHANNEL (Up/Down) buttons on the remote control to select TV channels. See page 18 for details.
- If you use a Cable Box or Satellite System hookup, you may not be able to watch one channel while recording another. See pages eight-nine for details.
- If you don't receive channels, check your hookups, then follow the instructions above carefully.

One Touch Recording 29

The one touch recording (OTR) function allows you to set an immediate timed recording 30 minutes to eight hours long without setting the timer. Before you begin, make sure:

- Channels are programmed.
- The desired recording speed (SP, LP, SLP) has been selected with the (Tape) SPEED button. (Details are on pages 32 and 50.)
- There is a tape in the VCR. Make sure the tape's record tab is intact and the tape is long enough to record the program(s).
- The VCR light appears on the display panel of the VCR. (If it does not, press the VCR/TV button once.)

Starting an OTR

1

Press the **VCR** button, then the **CHANNEL (Up/Down)** buttons or the **Number** buttons to select the channel you want to record.

2

Press the **REC(ord)/OTR** button repeatedly until the desired recording length (30 minutes to eight hours) appears in the upper left corner of the screen. Recording will begin immediately. The REC light and the Timer light will appear on the display panel.

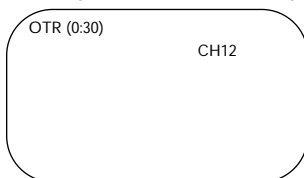

3

To stop an OTR before recording is finished, press the **STOP** button or the **POWER** button. To cancel the OTR but continue recording, press the **REC(ord)/OTR** button until REC appears in the upper left corner of the screen. The REC light will remain on the display panel of the VCR, but the Timer light will disappear.

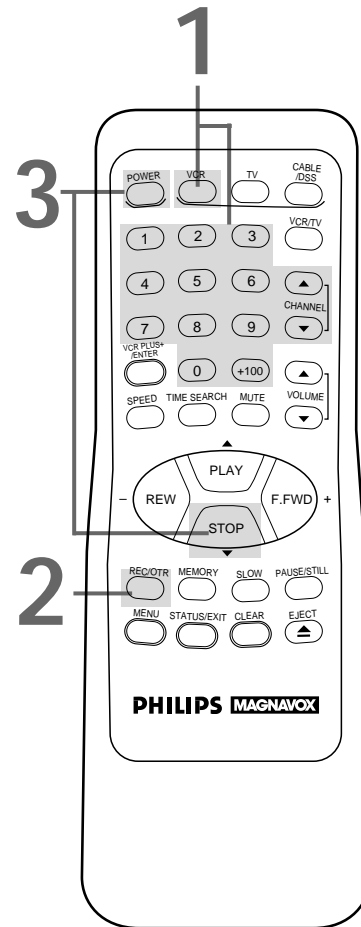

Helpful Hints

- To check the time remaining for an OTR after the OTR has been set, press the **STATUS/EXIT** button.
- To change the recording length while an OTR is in progress, press the **REC(ord)/OTR** button until the desired length appears on-screen.
- If you begin an OTR when a recording is paused, the OTR will begin.
- You can not pause recording (for example, during commercials) during an OTR.
- If the preset time for a timer recording comes up during an OTR, the OTR has priority.
- If the end of the tape is reached during an OTR, recording will stop. The VCR will eject the tape, then turn itself off.

30 Timer Recording

Follow the steps below to program your VCR to record TV programs while you're away from home. You can program up to eight timer recordings. For each one, the VCR will turn itself on, record, and turn itself off automatically.

If you are using a Cable Box, timer recordings may be programmed differently. Read pages eight-nine before proceeding. Before you begin make sure:

- Channels are programmed.
- The clock is set.
- There is a tape in the VCR. Make sure the tape's record tab is intact and the tape is long enough to record the program(s).
- The VCR light appears on the display panel of the VCR. If it does not, press the VCR/TV button once.

Complete each step within 60 seconds of completing the previous step. If you don't, start again at step 1.

1

Press the VCR button, then the MENU button to bring up the main menu display.

TO SELECT PUSH NO. SHOWN

- 1 PROGRAM
- 2 VCR SET UP
- 3 TUNER SET UP
- 4 SET CLOCK

TO END PUSH EXIT

2

Press the Number 1 button on the remote control to select PROGRAM.

TO SELECT PUSH NO. SHOWN

- 1 ONCE
- 2 DAILY
- 3 WEEKLY
- 4 PROGRAM REVIEW

TO END PUSH EXIT

3

Select a once, daily or weekly recording.

- Press the Number 1 button to select ONCE. The VCR will record a TV program on any day you choose, up to 12 months away.
- Press the Number 2 button to select DAILY. The VCR will record every day from Monday to Friday – starting at the same time and for the same length of time.
- Press the Number 3 button to select WEEKLY. The VCR will record on the same day, at the same time, and for the same length of time every week (for example, every Tuesday from 2-3 p.m.).

**Daily
Recording
Menu
Screen**

DAILY PROGRAM (MON-FRI)
PROGRAM -1 2 3 4 5 6 7 8-

SELECT PROGRAM NUMBER
TO END PUSH EXIT

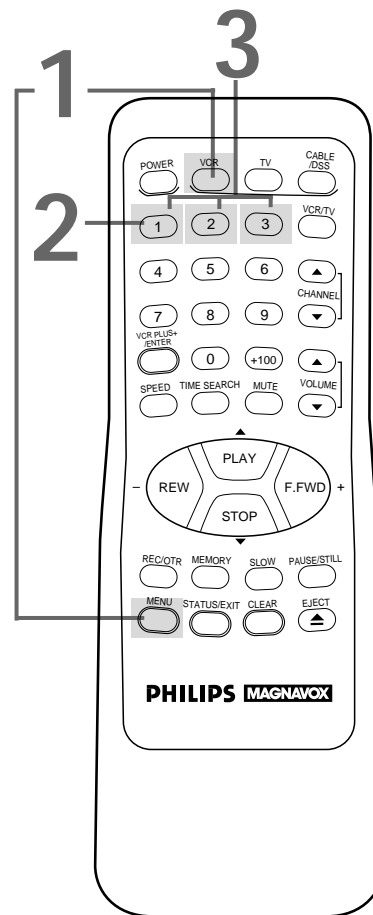

Helpful Hints

- If you need to make corrections while programming a timer recording, press the CLEAR button until the cursor is flashing on the item you want to change. Then enter the correct information.
- If the end of the tape is reached during a timer recording, recording will stop. The VCR will eject the tape and turn itself off.

4

Use the Number buttons (1 - 8) to select a slot in which to store the timer recording. There are eight timer recording slots. Open slots will flash on-screen.

NOTE: If you enter a number for a slot that has already been used to store a timer recording, PREVIOUSLY SET PROGRAM will appear on-screen for a few seconds. Then information about the program in that slot will be displayed on-screen. If this happens, press the STATUS/EXIT button twice. Then start again at step 1. (If you do not press any buttons within 60 seconds, you will return to the previous menu.)

5

Enter the channel you want to record.

- If you have a basic antenna or cable hookup (as shown on pages six-seven) enter the channel of the TV program you want to record. (You must enter a 0 before all single digit channels.)
- If you are recording from line input, press 0, 0. A/V IN will appear on-screen.
- If you are using a Cable Box, enter the Cable Box output channel (channel 03 or 04). See page eight for details.

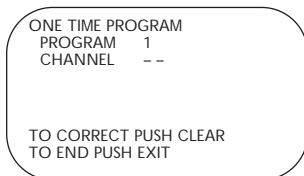

6

Enter the recording's start time.

Press two Number buttons for the hour you want the recording to begin. Press two Number buttons for the minute(s) you want the recording to begin. Press 1 for AM or 2 for PM. For example, for 9:30 PM, press 09, 30, 2.

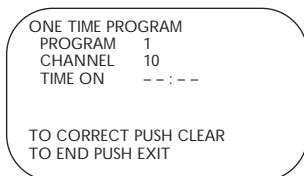

7

Enter the recording's stop time.

Follow the instructions in step 6 to set the recording's stop time (AM or PM will be set automatically).

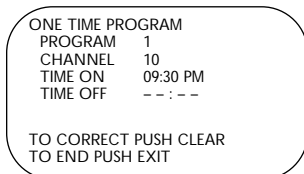

Instructions continue on page 32.

4-7

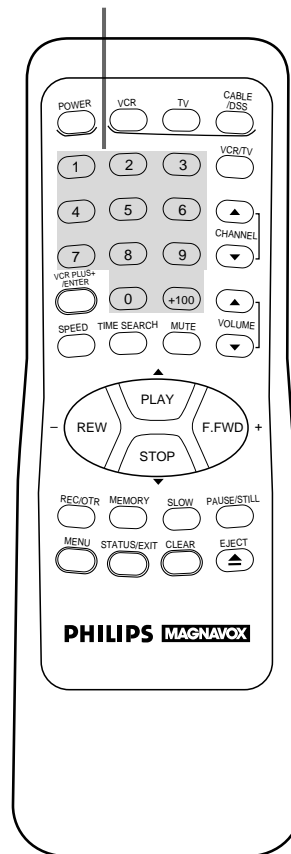

Helpful Hint

- Entries that do not match the VCR's internal clock or calendar will cause a question mark to appear on-screen.

32 Timer Recording (cont'd)

8

Press the Number 1 button to record in SP speed, press the Number 2 button to record in LP speed, or press the Number 3 button to record in SLP speed. For details, see the chart below. You cannot use the (Tape) SPEED button at this time.

ONE TIME PROGRAM
 PROGRAM 1
 CHANNEL 10
 TIME ON 09:30 PM
 TIME OFF 11:00 PM
 REC SPEED SLP
 SP=1 LP=2 SLP=3

TO CORRECT PUSH CLEAR
 TO END PUSH EXIT

9

Press two Number buttons for the month and two Number buttons for the day you want to record the program. For example, for July 10, 1997, press 07, 10. The day of the week and the year will be displayed automatically (you cannot program the VCR to record more than one year in advance).

ONE TIME PROGRAM
 PROGRAM 1
 CHANNEL 10
 TIME ON 09:30 PM
 TIME OFF 11:00 PM
 REC SPEED SLP
 START DATE 07/10/97
 THU.

TO CORRECT PUSH CLEAR
 TO END PUSH EXIT

10

Press the **STATUS/EXIT** button. PROGRAM WAS COMPLETED PLEASE TURN OFF VCR FOR TIMER RECORDING will appear on-screen (if PROGRAM NOT COMPLETED appears, try again from step 1). In three seconds the on-screen display will disappear.

11

Turn off the VCR power. The Timer light will appear. **The VCR must be turned off for a timer recording to take place.** (If the timer recording will take place several hours or days from now, you may use the VCR until time for the recording. Just turn off the VCR a few minutes before the recording starts.) If you forget to turn off the VCR, PLEASE TURN OFF VCR FOR TIMER RECORDING flashes on your TV screen two minutes before a timer recording starts. Remove the message by pressing the CLEAR button.

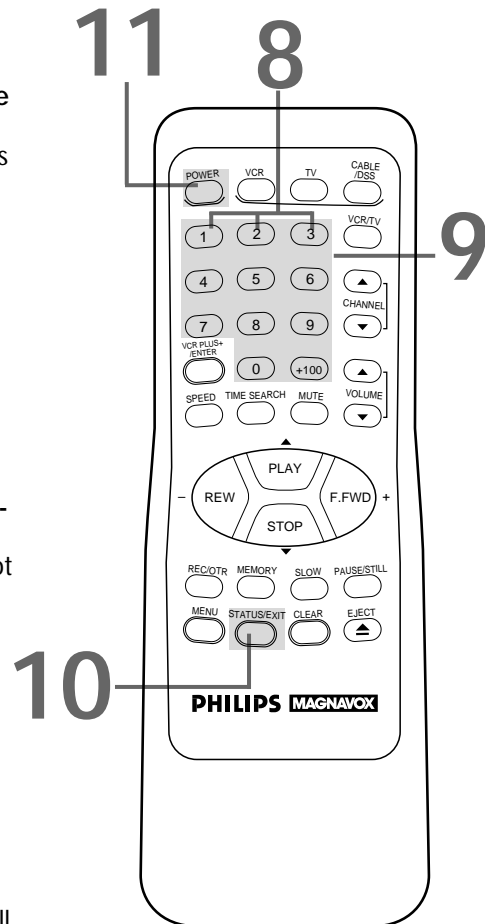

The VCR must be off for a timer recording to take place! Make sure there is a tape in the VCR.

| Tape Speed | Maximum Record/Playback Time | | | |
|--------------------------|------------------------------|--------------------|--------|--------|
| | Type | T160 | T120 | T60 |
| SP (Standard Play) | | 2 hrs. 40 mins. | 2 hrs. | 1 hr. |
| LP (Long Play) | | 5 hrs. 20 mins. | 4 hrs. | 2 hrs. |
| SLP (Super Long Play) | | 8 hrs. | 6 hrs. | 3 hrs. |

This chart shows the recording/playback time for three types of video cassettes (T160, T120, and T60). There are three playback speeds: SP, LP, and SLP. During playback, the VCR selects the tape speed automatically. When recording, you can change the tape speed using the (Tape) SPEED button (see pages 20 and 27).

Reviewing or Cancelling Timer Recordings

1

Press the **VCR** button, then the **POWER** button to turn on the VCR.

2

Make sure the VCR light appears on the display panel of the VCR. If it does not, press the **VCR/TV** button.

3

Press the **MENU** button.

4

Press the **Number 1** button to select **PROGRAM**.

5

Press the **Number 4** button to select **PROGRAM REVIEW**. The timer recording information for the program in the lowest numbered slot will appear on-screen. If there are no timer recordings set, nothing will happen when you press the **Number 4** button.

6

Press the **Number 1** button repeatedly to review all programmed timer recordings. If you don't press the **Number 1** button in 10 seconds, the VCR will automatically display information about the next programmed timer recording. This will continue until all filled positions have been displayed. Then the menu will disappear.

7

To cancel the timer recording displayed, press the **CLEAR** button. Either the display will disappear or information about other timer recordings will appear. If you do not press any other buttons, the display will disappear after all timer recordings have been displayed.

8

Repeat steps 3-6 to make sure you have cleared the correct timer recording.

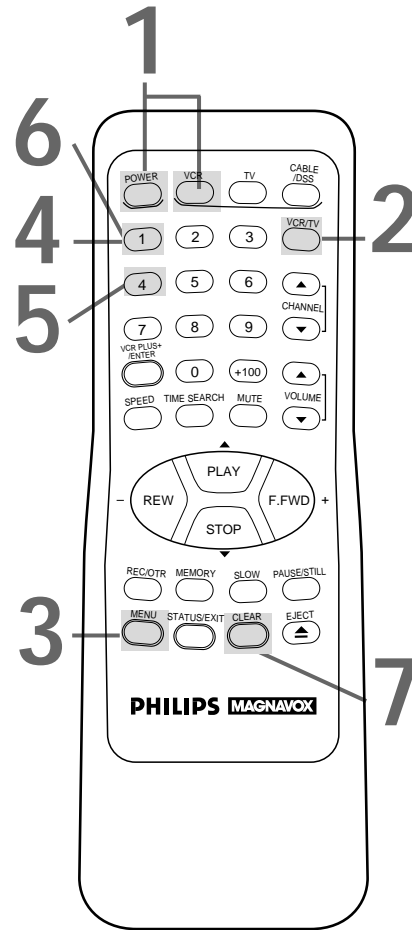

Helpful Hints

- **CLASH** may flash on the screen when you finish setting a timer recording, then the **PROGRAM** menu will appear. This means that the timer recording you just programmed and another timer recording overlap, and thus the current timer recording will not be carried out. In this case, cancel one of the overlapping timer recordings by following the instructions on this page.
- If the preset time for a timer recording comes up during an **OTR**, the **OTR** has priority.
- To stop a started timer recording, press the **STOP/EJECT** button on the VCR.
- If the power fails for more than one minute, programmed timer recordings will be lost. If this occurs, reset the VCR's clock before re-programming the timer recording(s).

See page 48 for more notes.

34 Setting Up the VCR Plus+ Programming System

1

First, fill in the boxes on this page. It will only take a few minutes, and you must do it if you want the VCR Plus+ programming system to work properly.

Since the channel numbers of the stations you receive may not be the same as the station numbers, and since channel numbers differ from area to area, you must program the VCR with your local channel information. To fill in the boxes, you will need 1) a cable channel line-up list, if applicable (you can request one from your cable company), and 2) a chart that lists VCR Plus+ channel numbers, which you can find in your TV guide or the TV listings of your local newspaper.

| TV Channels | | |
|----------------------------------|---------------|--------------|
| Local TV Stations (call letters) | VCR PLUS+ CH. | CABLE/TV CH. |
| | | |
| | | |
| | | |
| | | |
| | | |
| | | |
| | | |
| | | |
| | | |
| | | |
| | | |
| | | |
| | | |
| | | |
| | | |
| | | |
| | | |
| | | |
| | | |
| | | |
| | | |
| | | |

| CABLE Channels | | |
|----------------------------------|---------------|--------------|
| Local TV Stations (call letters) | VCR PLUS+ CH. | CABLE/TV CH. |
| | | |
| | | |
| | | |
| | | |
| | | |
| | | |
| | | |
| | | |
| | | |
| | | |
| | | |
| | | |
| | | |
| | | |
| | | |
| | | |
| | | |
| | | |
| | | |
| | | |
| | | |
| | | |
| | | |

Setting Up the VCR Plus+ Programming System (cont'd) 35

2

Now, compare the channel numbers you have written in the VCR PLUS+ CH. and CABLE/TV CH. columns. You'll notice that some stations have VCR Plus+ and Cable/TV channel numbers that are the same, and other stations have channel numbers that do not match. Where the channel numbers DO NOT match, you must tell the VCR the VCR Plus+ and Cable/TV channel numbers according to the following steps.

- Make each entry within 60 seconds of the previous entry.

3

Press the VCR button, then the MENU button.

4

Press the Number 2 button to select VCR SET UP.

TO SELECT PUSH NO. SHOWN
 1 REPEAT PLAY OFF
 2 ON SCREEN MODE
 3 AUDIO OUT
 4 LANGUAGE
 5 VCR PLUS+ REF. MAP

TO END PUSH EXIT

5

Press the Number 5 button to select VCR PLUS+ REF. MAP.

VCR PLUS+ CROSS REF. MAP
 VCR PLUS+ CABLE/TV
 98 98
 99 99
 1 -----> 1
 2 2

TO SELECT CH PUSH CH UP/
 DOWN THEN ENTER CH NO.
 TO END PUSH EXIT

6

Look at the boxes you filled in on page 34. **For stations whose VCR Plus+ and Cable/TV channels do not match, press the CHANNEL (Up/Down) buttons until the arrow is beside the VCR Plus+ channel you need. Then, press the Number buttons to enter the corresponding Cable/TV channel from your list.** (Enter a "0" before single-digit channels.) Continue this process until you have entered all the stations on your list.

VCR PLUS+ CROSS REF. MAP
 VCR PLUS+ CABLE/TV
 98 98
 99 99
 1 -----> 23
 2 2

TO SELECT CH PUSH CH UP/
 DOWN THEN ENTER CH NO.
 TO END PUSH EXIT

7

Press the STATUS/EXIT button to exit.

2

Examine the lists on page 34.

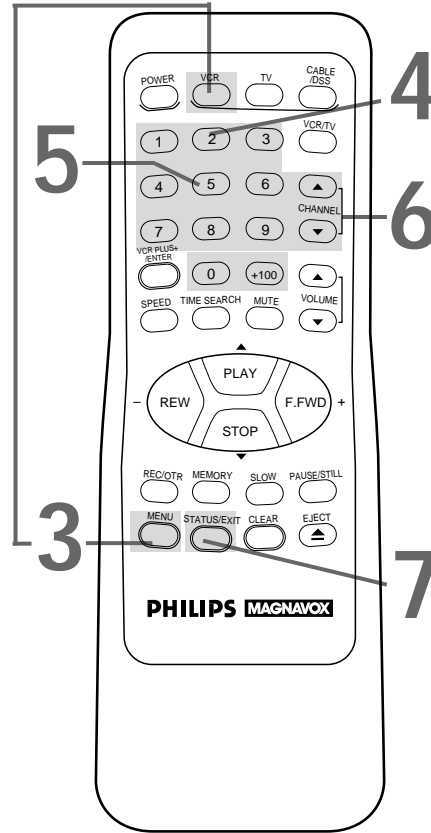

Helpful Hints

- To correct a Cable/TV channel number, repeat the steps on this page.
- To clear a Cable/TV channel number, repeat steps 3-5 on this page. Then, press the CHANNEL (Up/Down) buttons to select it. Then press the CLEAR button. Press the STATUS/ EXIT button to exit.
- Always enter a "0" before single-digit channels.
- To select line input for the Cable/TV channel, press 0,0. AUX will appear on-screen.
- When you receive the VCR from the factory, all the VCR Plus+ channel numbers and Cable/TV channel numbers are the same.

36 Timer Recording With the VCR Plus+ Programming System

Follow the steps below to program a timer recording using the PlusCode programming numbers in your TV guide. Before you begin, make sure:

- Channels are programmed (page 12).
- The VCR Plus+ and Cable/TV channel numbers are entered (pages 34-35).
- The clock is set (page 15).
- There is a tape in the VCR. Make sure the tape's record tab is intact and the tape is long enough to record the program(s).
- The VCR light appears on the display panel of the VCR. If it does not, press the VCR/TV button once.

Complete each step within 60 seconds of completing the previous step. If you don't, you may return to step 1.

1

Press the **VCR** button, then the **VCR PLUS+/ENTER** button on the remote control. The on-screen display shown below will appear.

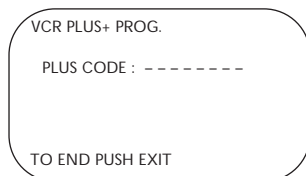

2

Use the **Number** buttons to enter the **PlusCode programming number** of the program you wish to record (this number is different for every program, and it can be four to eight digits long). Finally, press the **VCR PLUS+/ENTER** button.

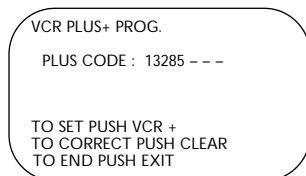

3

To record the program once, **press the Number 1 button to select ONCE**. To record the same program every day from Monday through Friday, **press the Number 2 button to select DAILY**. To record the same program every week on the same day (such as every Saturday), **press the Number 3 button to select WEEKLY**.

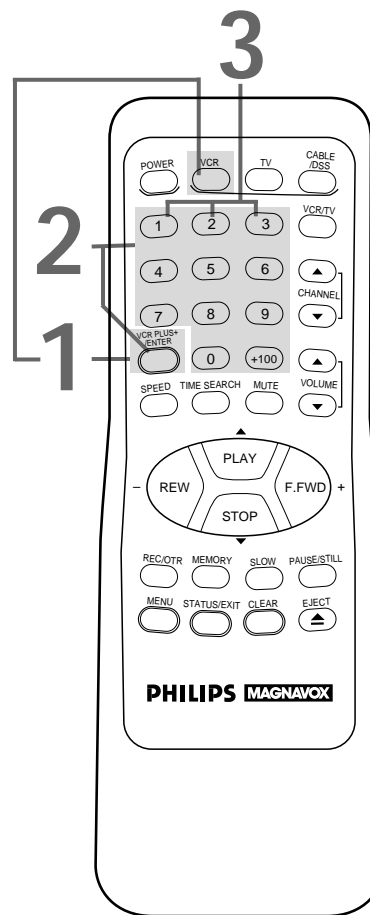
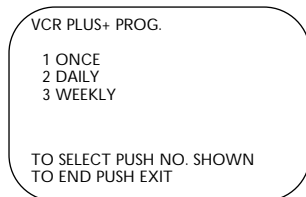

Helpful Hints

- *ALL PROGRAMS IN USE* will appear on-screen at step 1 if all timer recording slots are full. See page 33 to clear a timer recording slot.
- If *CODE ERROR* flashes after you enter the PlusCode programming number and press the VCR PLUS+/ENTER button, the number you entered was incorrect or too short. If this happens, enter the correct number.
- *CLASH* may flash on the screen at step 2 or at step 5. This means that the timer recording you just programmed and another timer recording overlap, and thus the current timer recording will not be carried out.
- If the end of the tape is reached during a timer recording, recording will stop. The VCR will eject the tape and turn itself off.

Timer Recording With the VCR Plus+ Programming System (cont'd) 37

4

Press the **Number 1** button to record in SP speed, press the **Number 2** button to record in LP speed, or press the **Number 3** button to record in SLP speed. For details, see pages 32 and 50.

You cannot use the (Tape) SPEED button at this time. Your choice will appear to the right of REC SPEED (but SP=1, LP=2, and SLP=3 will continue to flash).

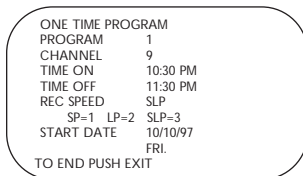

5

Press the **STATUS/EXIT** button. PROGRAM WAS COMPLETED / PLEASE TURN OFF VCR FOR TIMER RECORDING should appear on the screen. After three seconds, the on-screen display will disappear.

6

Press the **POWER** button to turn off the VCR power. The Timer light will appear. The Timer light will flash if there is not a tape in the VCR.

If the timer recording will take place several hours or days from now, you may use the VCR until time for the recording. Just turn off the VCR a few minutes before the recording starts.

The VCR must be turned off for a timer recording to take place. If you forget to turn off the VCR, PLEASE TURN OFF VCR FOR TIMER RECORDING flashes on your TV screen two minutes before a timer recording starts. You can remove the message by pressing the CLEAR button.

The VCR must be off for a timer recording to take place! Make sure there is a tape in the VCR.

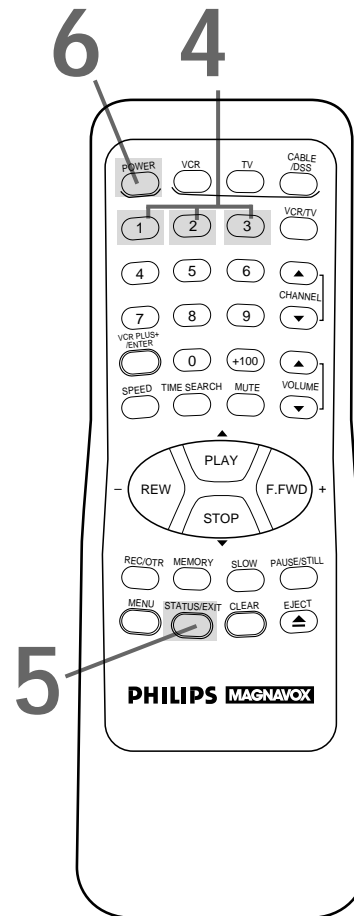

Helpful Hints

- To quit the VCR Plus+ programming system at any time, press the STATUS/EXIT button. The display will disappear from the TV screen.
- If the preset time for a timer recording comes up during an OTR, the OTR has priority.
- To stop a started timer recording, press the STOP/EJECT button on the VCR.
- If the power fails for more than one minute, programmed timer recordings may be lost. Reset the clock before re-programming the timer recordings.
- If you have a Cable Box, timer recordings are programmed differently. See page eight for details.

See page 48 for more notes.

38 Rerecording (Tape Duplication)

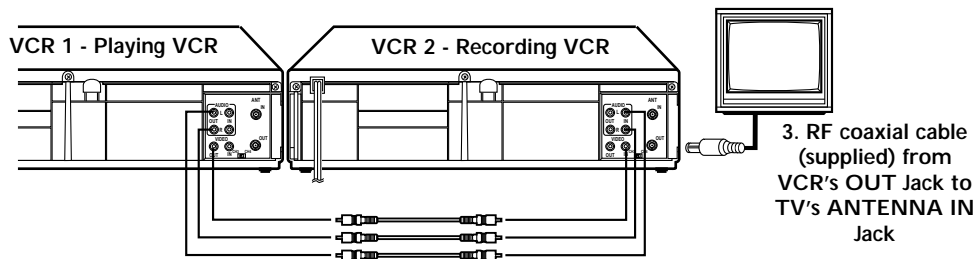

1. Audio cables from AUDIO OUT Jacks of VCR 1 to AUDIO IN Jacks of VCR 2
2. Video cable from VIDEO OUT Jack of VCR 1 to VIDEO IN Jack of VCR 2

- Audio and Video cables are not supplied.

The instructions on this page show you how to copy tapes. The illustration uses two VCRs just like yours. Different VCRs may operate differently.

NOTE: Unauthorized recording of copyrighted television programs, video tapes, or other materials may infringe on the rights of copyright owners and violate copyright laws.

1

Make the connections shown above.

2

VCR 1 will play your tape. **Insert a prerecorded tape in VCR 1.** If the tape does not have a record tab, playback begins. If this happens, press the STOP/EJECT button on VCR 1 once.

3

VCR 2 will record your tape. **Insert a blank tape in VCR 2.** Make sure the VCR 2 power is on and VCR 2 is in VCR position. (The VCR light will appear on the display panel of VCR 2. If it does not, press the VCR/TV button once.)

4

Turn the TV on and set it to channel 3 or 4, whichever channel the CH3/CH4 switch on VCR 2 is set to.

5

Point the remote control at VCR 2. Press the Number buttons 0, 0. A/V IN will appear on-screen.

6

Point the remote control at VCR 2. Use the (Tape) SPEED button to select SP, LP or SLP.

7

Press the PLAY button on VCR 1 and the REC(ord)/OTR button on VCR 2 at the same time.

To stop recording, press the STOP/EJECT button on VCR 1, then press the STOP/EJECT button on VCR 2.

Repeat Playback 39

Repeat Playback

Follow the steps below to program the VCR to play a tape over and over.

1

Press the **VCR** button, then the **MENU** button to bring up the main menu display.

TO SELECT PUSH NO. SHOWN

- 1 PROGRAM
- 2 VCR SET UP
- 3 TUNER SET UP
- 4 SET CLOCK

TO END PUSH EXIT

2

Press the **Number 2** button to select VCR SET UP.

TO SELECT PUSH NO. SHOWN

- 1 REPEAT PLAY OFF
- 2 ON SCREEN MODE
- 3 AUDIO OUT
- 4 LANGUAGE
- 5 VCR PLUS+ REF. MAP

TO END PUSH EXIT

3

Press the **Number 1** button so that ON appears to the right of REPEAT PLAY on-screen.

4

Press the **STATUS/EXIT** button to exit. Now, when a tape has finished playing, the VCR will rewind it and start playback again. (TV programming will appear while the tape is rewinding.)

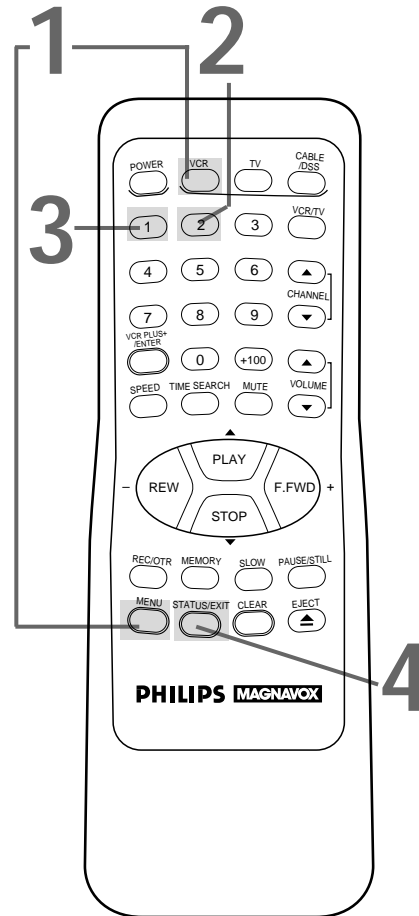

Helpful Hints

- The VCR will stay in Repeat Play mode until you cancel Repeat Play mode. To do this, follow steps 1 - 2 above. At step 3, press the Number 1 button so that OFF appears to the right of REPEAT PLAY on-screen. Press the STATUS/EXIT button to exit.
- The real time counter memory does not function during Repeat Play mode.

40 Time Search

Time Search

Follow the steps below to program the VCR to search forward or backward a specific length of time.

1

Press the **VCR** button, then the **TIME SEARCH** button to bring up the Time Search display.

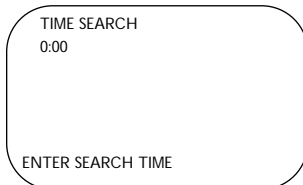

2

Within 10 seconds, use the **Number** buttons to enter the desired length of time you want to skip forward or backward. For example, for 1 hour, 25 minutes, press Number buttons 1, 2, 5. Or, for five minutes, press Number buttons 0, 0, 5. If you do not make an entry within 10 seconds, the VCR will exit Time Search mode.

3

Within 10 seconds, press the **F.FWD** button or the **REW(ind)** button to skip forward or backward. The VCR will fast forward or rewind the tape the specified length of time, then begin playback. (The time counts down on-screen as the searching progresses.)

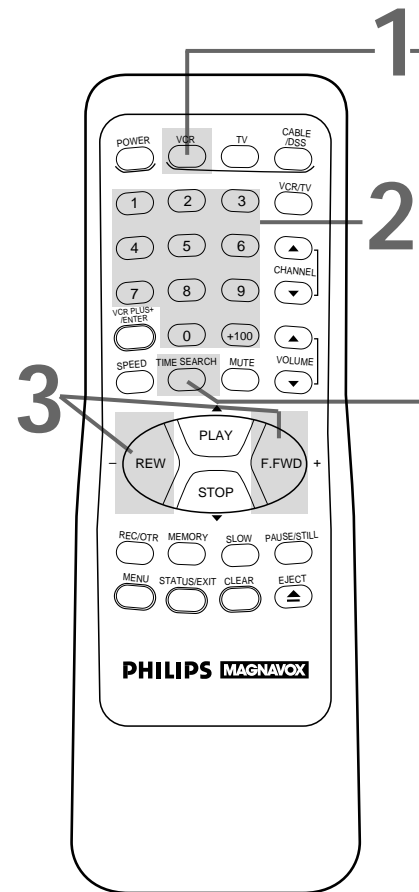

Helpful Hints

- You can not enter the Time Search display when you are in Recording mode.
- You can remove the Time Search display by pressing the **TIME SEARCH** button once again.
- To cancel the Time Search when the VCR is fast forwarding or rewinding, press the **STOP** button once or the **TIME SEARCH** button twice.
- If you want to search for more than 59 minutes, you must enter the length of time in hours and minutes. For example, to search forward 70 minutes, press 1,1,0 at step 2.

Real Time Counter Memory 41

Real Time Counter Memory

Follow the steps below to reset the real time counter to zero at a tape location you want to refer to later.

1

Play, fast forward, or rewind a tape to the location that you would like to refer to later. Press the **STOP** button on the remote control or the **STOP/EJECT** button on the VCR to stop the tape.

2

Press the **STATUS/EXIT** button. The status display will appear on-screen for about five seconds.

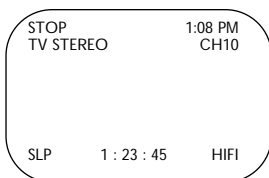

3

While the status display is still on-screen, press the **CLEAR** button to reset the real time counter to zero.

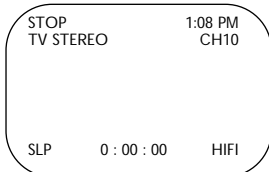

4

While the counter is still on-screen, press the **MEMORY** button so that **M** appears to the left of the real time counter on-screen.

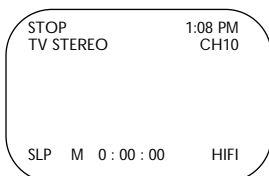

5

To go to a tape location where the real time counter was reset to zero, press the **REW(ind)** button or the **F.FWD (Fast Forward)** button when tape playback is stopped. When the tape reaches the point at which the real time counter was reset to zero, the tape will stop. Press the **PLAY** button to watch the tape.

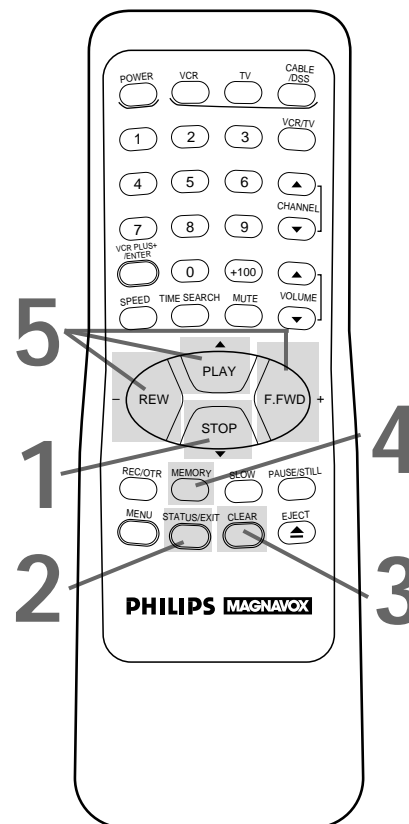

Helpful Hints

- The **MEMORY** button does not function if Repeat Play is set to **ON**. To turn Repeat Play **OFF**, see Helpful Hints on page 39.
- To erase a Real Time Counter Memory, press the **MEMORY** button until the **M** disappears from the screen.
- You may only set the real time counter to zero at one location at a time. If you try to set the real time counter to zero at a second location, the previous real time counter to zero setting will be erased.

42 Special Effects Playback

Forward and Reverse Searching (SP/LP/SLP)

1

During tape playback, press and release the F.FWD (Fast Forward) button or the REW(ind) button. A fast forward or reverse picture search will begin.

2

To return to playback, press the PLAY button.

Super High Speed Searching (LP/SLP)

1

During tape playback, press the F.FWD (Fast Forward) button or the REW(ind) button, then press again. The VCR will now search in super high speed.

2

To return to normal playback, press the PLAY button.

Viewing a Still Picture

1

During tape playback, press the PAUSE/STILL button on the remote control or the PAUSE button on the VCR. A still picture (frozen image) will appear on-screen.

2

To release the still picture and return to normal playback, press the PLAY button or press the PAUSE/STILL button again.

Viewing a Slow Motion Picture

1

During tape playback, press the SLOW button. The tape will play in slow motion.

2

To release slow motion playback and return to normal playback, press the PLAY button or press the SLOW button again.

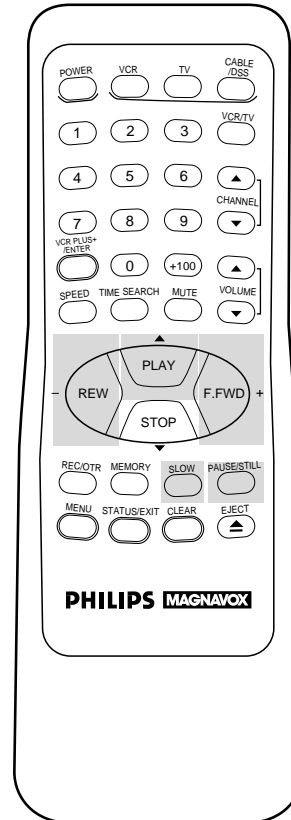

Helpful Hints

- Slow and Still modes will automatically switch to Stop mode after five minutes to protect the VCR and the tape from damage.
- SP/LP/SLP means this feature will work with tapes recorded in Standard Play, Long Play, or Super Long Play.
- LP/SLP means this feature will work with tapes recorded in Long Play or Super Long Play. For details about tape speed, see pages 32 and 50.
- If a still picture vibrates vertically, stabilize it by pressing the CHANNEL (Up/Down) buttons on the VCR (any other vertical jitter should be removed with your TV's vertical hold control, if your TV has one).

Automatic Playback

When you put a tape in the VCR, the power will come on automatically. If the tape's record tab is missing, playback will begin.

If a timer recording is set, the power will not come on automatically when you insert a tape with the record tab intact.

If a timer recording is set and the VCR power is off, the VCR will eject the tape if the record tab is missing.

Automatic Rewind, Eject, Off

When a tape is played, fast forwarded, or recorded to its end, the VCR will rewind the tape, go into the Stop mode, eject the tape, then turn itself off.

If the real time counter memory is set, the VCR will only rewind to the point at which the counter is set to zero, then stop. The VCR will not eject the tape automatically or shut itself off.

If the end of the tape is reached during an OTR or timer recording, recording will stop. Then, the VCR will eject the tape and turn itself off. The VCR will not rewind the tape.

Tape Eject

A tape can be ejected with the VCR power on or off (but the VCR must be plugged in). If a Timer Recording is programmed, a tape can only be ejected with the power on. Make sure you insert a tape and turn off the power for the Timer Recording.

Automatic Tracking Adjustment

The VCR continually adjusts tracking automatically to give you the best possible picture quality. With some recordings, however, you may get a better picture using the manual tracking controls (see below).

Manual Tracking

To adjust the tracking manually, press the CHANNEL (Up/Down) buttons **on the VCR** during tape playback.

NOTES:

- This function is controlled only by the buttons **on the VCR**. The CHANNEL (Up/Down) buttons on the remote control will not adjust tracking.
- To return tracking to the position it was in when the VCR was shipped from the factory, press the CHANNEL (Up) and CHANNEL (Down) buttons **on the VCR at the same time**.
- Tracking is returned to auto tracking when a tape is inserted, or when the STOP button is pressed to halt playback.
- When the VCR is in Slow mode, auto tracking will not work. Instead, use the CHANNEL (Up/Down) buttons **on the VCR** to reduce noise lines in slow motion playback.
- Manual tracking will not operate when the VCR is in Still mode. If you want to reduce noise lines in a still picture, place the VCR in Slow mode. Use the CHANNEL (Up/Down) buttons **on the VCR** to remove the noise lines. Then return to Still mode.

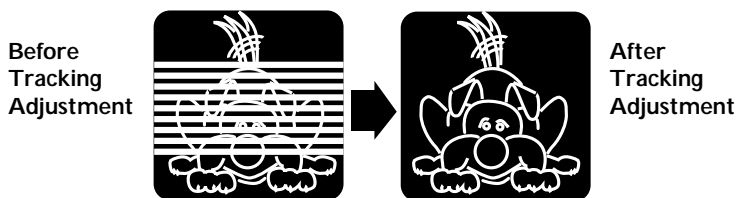

44 Multi-Channel Television Sound System

Your VCR can play recordings broadcast in Hi-Fi (high fidelity) stereo, which produces a crisp, clear sound from two sources. Your VCR also can play tapes recorded in a second audio (usually, that means your program is recorded in a second language). Of course, your VCR will play tapes recorded in monaural (single-source) sound as well.

Your VCR also will record in Hi-Fi stereo or in second audio, so when you play back that tape on the VCR, it will be in stereo or second audio. If you play back the tape on a VCR that can't play back tapes in stereo or second audio, the VCR will automatically play the tape in monaural sound.

Read the directions on this page to familiarize yourself with your VCR's stereo and second audio setups. Then follow the directions on page 45 to record in stereo or second audio and the directions on pages 46-47 to play back tapes recorded in Hi-Fi stereo.

Understanding On-Screen Displays

When you receive a signal from a channel you're watching, portions of the on-screen display shown below will appear when you press the STATUS/EXIT button on the remote control.

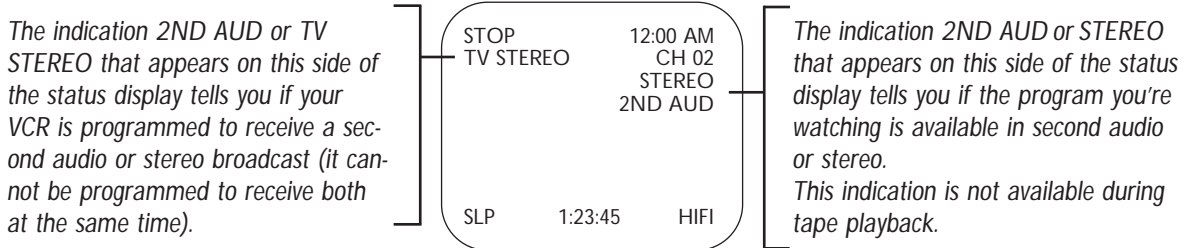

Specifically...

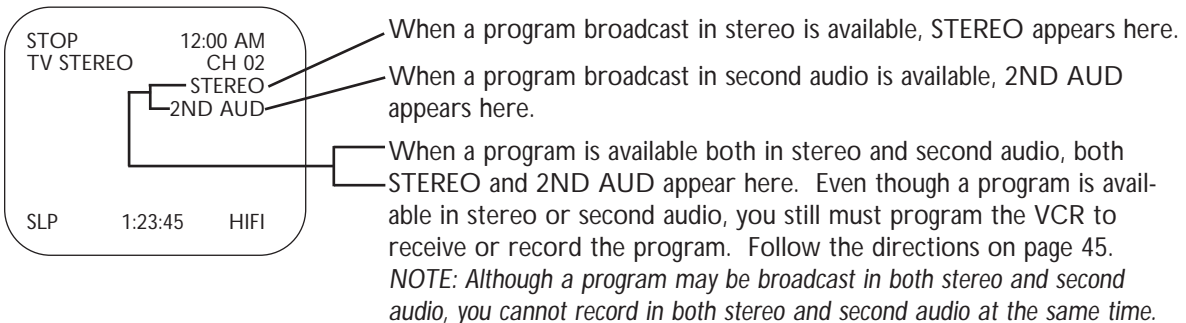

To record and play back programs broadcast in stereo, even if you have a Mono Speaker TV, just use one of the connections shown, then follow the steps on pages 45-47.

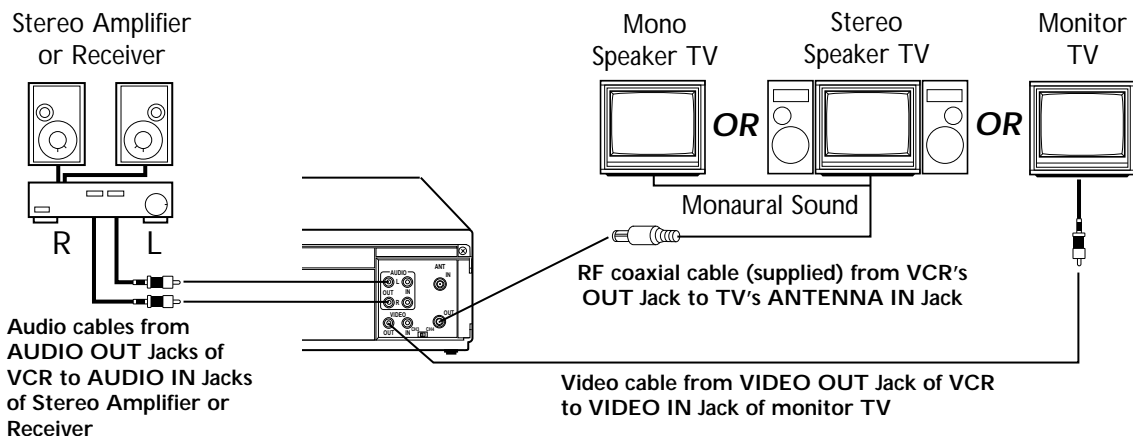

Multi-Channel Television Sound System (cont'd) 45

1

Press the **VCR** button, then the **MENU** button to bring up the main menu display.

2

Press the **Number 3** button to select TUNER SET UP.

TO SELECT PUSH NO. SHOWN
1 TV
2 CABLE TV ON
3 AUTO PROGRAMMING ON
4 ADD/DELETE CH
5 CH MEMORY REVIEW ON
6 TV STEREO ON
7 2ND AUDIO
TO END PUSH EXIT

3

Press the **Number 6** button to select TV STEREO or the **Number 7** button to select 2ND AUDIO. ON will appear to the right of your selection.

4

Press the **STATUS/EXIT** button to exit.

5

To play a tape, press the **PLAY** button. Or, to record, select the channel to be recorded using the **CHANNEL** (Up/Down) buttons, then go to step 6.

6

Press the **REC(ord)/OTR** button to start recording.

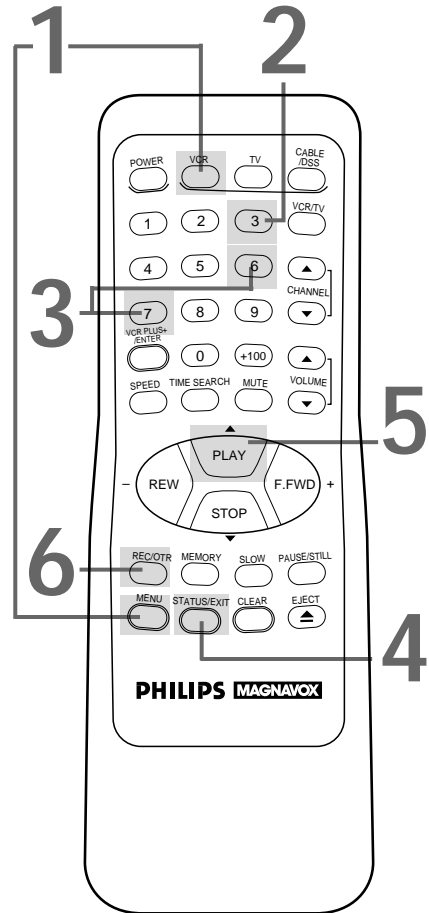

Helpful Hints

- You can only receive and record in stereo or second audio programs that are broadcast in second audio or stereo. You can only play in stereo or second audio tapes that were recorded in stereo or second audio. Please see page 44 to determine if the program you want to watch/record is being broadcast in stereo or second audio.
- If you select second audio when second audio is not available, the VCR will record normal audio.

46 Hi-Fi Stereo Sound System

Multi-Channel Television Sound system broadcasts are automatically recorded in Hi-Fi stereo sound. To play in Hi-Fi stereo tapes recorded in Hi-Fi stereo, however, you'll need to follow the steps below.

1

Press the **VCR** button, then the **MENU** button to bring up the main menu display.

2

Press the **Number 2** button to select VCR SET UP.

TO SELECT PUSH NO. SHOWN
1 REPEAT PLAY OFF
2 ON SCREEN MODE
3 AUDIO OUT
4 LANGUAGE
5 VCR PLUS+ REF. MAP

TO END PUSH EXIT

3

Press the **Number 3** button to select AUDIO OUT.

TO SELECT PUSH NO. SHOWN
1 HIFI ON
2 MONO

TO END PUSH EXIT

4

Press the **Number 1** button to select HIFI. ON will appear to the right of HIFI on-screen.

TO SELECT PUSH NO. SHOWN
1 HIFI ON
2 MONO

TO END PUSH EXIT

5

Press the **STATUS/EXIT** button to exit.

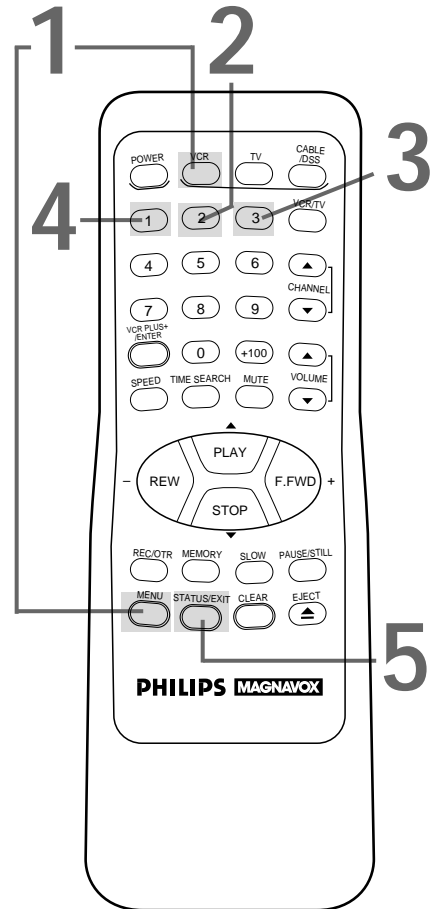

Helpful Hints

- All programs are automatically recorded in both Hi-Fi stereo sound and in monaural sound.
- The audio level of a tape recorded in Hi-Fi stereo will differ from the audio level of a tape not recorded in Hi-Fi stereo.
- Normally, HIFI should be selected from the AUDIO OUT menu for playback with Hi-Fi sound. But, you can change the selection to MONO if you want monaural audio playback. To do this, follow steps 1 - 3 above. At step 4, press the Number 2 button to select MONO. Press the STATUS/EXIT button to exit. HIFI will disappear from the status display.
- If you play non-Hi-Fi tapes while the VCR is set to HIFI, HIFI will disappear from the status display and the tape will play in monaural sound. Please see additional notes on page 49.

Hi-Fi Stereo Sound System (cont'd) 47

6

Press the **MENU** button to bring up the main menu display.

7

Press the **Number 3** button to select TUNER SET UP.

TO SELECT PUSH NO. SHOWN

- 1 TV
 - 2 CABLE TV ON
 - 3 AUTO PROGRAMMING ON
 - 4 ADD/DELETE CH
 - 5 CH MEMORY REVIEW
 - 6 TV STEREO ON
 - 7 2ND AUDIO
- TO END PUSH EXIT

8

Press the **Number 6** button to select TV STEREO. ON will appear to the right of TV STEREO on-screen.

9

Press the **STATUS/EXIT** button to exit.

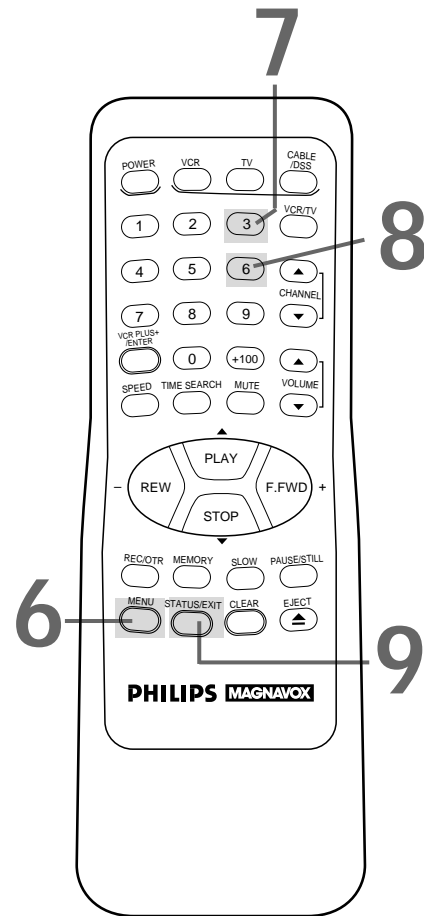

48 Helpful Hints

If you are having problems with your VCR, check the following list of problems and possible solutions before requesting service. You may be able to solve the problem yourself.

No power

- Make sure the power plug is completely connected to an AC (alternating current) outlet.
- Make sure the power is turned on.

Power Failure

- Timer recordings and the clock setting may be lost if the power fails for more than one minute. See page 15 to reset your clock. See pages 30-37 to reprogram your timer recordings.

A TV program cannot be recorded.

- Check the connections between the VCR, TV, antenna/cable, and Cable Box/Digital Satellite System (if applicable) (pages six-10).
- Make sure the tape has a record tab (page five).
- Check the TV/VCR position (page 24).
- Check the CH3/CH4 switch (pages six-nine).

The VCR will not perform a timer recording.

- Make sure the recording start and stop times are set correctly (pages 30-37).
- Make sure a tape is in the VCR and the tape has a record tab (page five). If, after programming a timer recording, you turn off the VCR power without putting a tape in the VCR, the Timer light will blink.
- If the record tab on a tape is missing, the VCR will eject the tape. The Timer light will blink.
- Make sure the VCR power is off.
- Make sure the clock is set (page 15).
- The VCR may not perform or continue a timer recording if a power interruption of more than one minute occurs during the timer recording, even if the power comes back on afterward.
- If you have a Cable Box, timer recordings are programmed differently. (See page eight for details.)
- It is best to finish programming a timer recording at least five minutes before the recording is scheduled to begin.
- 12 PM is noon; 12 AM is midnight.

The VCR did not record the complete OTR or timer recording.

- The end of the tape was reached before the end of the recording. The VCR will eject the tape and turn itself off.

Satellite Hookups

- Watching one TV channel while recording another may not be possible if you have a satellite hookup. You may have to set your TV to channel 3 or 4, then make your channel selections at the satellite converter box.
- With many satellite hookups, if you use accessory audio and video cables to connect your VCR to your TV, you will have to put your VCR in Line Input mode. To enter Line Input mode, press 0, 0 on the VCR's remote control. A/V IN will appear on your TV screen briefly.

Line Input mode

- If you accidentally enter Line Input mode (A/V IN will appear on your TV screen briefly), press the CHANNEL (Up/Down) buttons or use the Number buttons to select another channel.

Daylight-Saving Time

- When automatic Daylight-Saving Time is set, the clock time will change automatically as follows: on the first Sunday in April, from 2 AM to 3 AM; on the last Sunday in October, from 2 AM to 1 AM.
- During the April time change, a timer recording programmed to start between 2 AM and 3 AM will not record. A timer recording programmed to end between 2 AM and 3 AM will end when the clock moves forward (2 AM).
- During the October time change, a recording cannot be started between the second 1 AM and 1:59 AM.

The motor (cylinder) rotates even when the VCR is in Stop mode.

- To enable the quick play mechanism, the cylinder will rotate for about five minutes. This is normal.

There is no playback picture or the playback picture is noisy or contains streaks.

- Make sure the TV and the Cable Box, if applicable, are on the same channel as the VCR's CH3/CH4 switch (pages six-nine).
- Make sure the VCR is in VCR position (page 24). The VCR light will appear on the display panel of the VCR when the VCR is in VCR position.
- Make sure channel 3 or 4 is properly adjusted at the TV.
- Adjust the tracking (page 43).

The Number buttons won't work for channels above 69.

- Select CABLE TV at the TUNER SET UP menu (page 12), then let the VCR program the channels.

Tape cannot be inserted.

- Insert the tape, window side up, with the record tab facing you.
- Make sure a tape isn't already in the VCR by pressing the STOP/EJECT button on the VCR.
- Gently push on the center of the tape when putting it in the VCR. Never force the tape into the VCR.
- If a timer recording is programmed and the VCR power is off, you can not insert a tape without a record tab.

Tape cannot be removed.

- Make sure the power plug is completely connected to an AC (alternating current) outlet.
- You have set a timer recording. Turn the VCR power on, then eject the tape. Be sure to insert a tape and turn off the power for your timer recording.

VCR ejects the tape when the REC(ord)/OTR button is pressed or when the VCR power is turned off to set a timer recording.

- Make sure the tape has a record tab (page five).

Channels above 13 cannot be received.

- Select CABLE TV at the TUNER SET UP menu (page 12), then let the VCR program the channels.

Poor reception

- You may need to tune your TV again.

The VCR cannot be controlled with the remote control.

- Make sure the VCR light appears on the VCR display panel. If it does not, press the VCR/TV button once.
- Aim the remote control directly at the VCR's remote sensor (page 24).
- Remove all obstacles between the remote control and the VCR.
- Inspect and/or replace the batteries in the remote control (page five).
- Press the VCR button, then try the other VCR function buttons.

TV programs cannot be watched normally.

- Put the VCR in TV position. (Press the VCR/TV button so that the VCR light disappears from the display panel. For details see pages 21 and 24.)
- Check the connections between the VCR, TV, antenna/cable, and Cable Box/Digital Satellite System (if applicable). (See pages six-10 for details.)

Hi-Fi Stereo Sound

- During playback, Hi-Fi audio may temporarily revert to normal audio when you adjust tracking. This is normal.
- When connecting the VCR to a stereo TV, you will only get stereo sound if you use audio cables to connect the AUDIO OUT jacks on the VCR to the AUDIO IN jacks on your TV, and if the TV is in Line (Auxiliary) Input mode.
- When you connect the AUDIO OUT jacks on the VCR to the AUDIO IN jacks on your TV, the stereo light on the TV might not glow. But, as long as the status display indicates you are receiving a stereo signal, you are receiving a stereo signal. This is normal.
- If Hi-Fi audio continually reverts to normal audio during playback, you may want to change AUDIO OUT to MONO at step 4 on page 46.
- Only tapes recorded in Hi-Fi audio will play back in Hi-Fi audio. Tapes recorded in normal audio will

50 Glossary

AUDIO IN/OUT Jacks: jacks located on the back of the VCR which are used to record audio from another source (IN) or to send audio to another source (OUT).

Automatic Channel Programming: process in which the VCR scans all available channels and places the ones you receive in its memory. Then, when you push the CHANNEL (Up/Down) buttons, you only scan through channels you receive.

Bands: settings that allow you to tune channels.

- **Antenna** – VHF (very high frequency; channels 2 - 13) and UHF (ultra high frequency; channels 14 - 69).
- **Cable** – all standard channels can be received without a Cable Box.

Cable Box Output Channel: Channel 3 or 4.

Dubbing: copying a tape using a second VCR.

Frame: a single still picture.

HQ: high quality; a feature in the VCR circuitry which provides enhanced picture detail.

Line Input: The channel to which you set your VCR during dubbing. The line input channel is always channel 00.

If you accidentally enter Line Input mode (A/V IN will appear on your TV screen briefly), press the CHANNEL (Up/Down) buttons or use the Number buttons to select another channel.

Mode: a VCR operation.

OTR: one touch recording; programming a timed recording that starts immediately and records for 30 minutes to eight hours, whichever you specify.

Remote Control: the small electronic unit that came with your VCR; allows you to operate your VCR from a distance. You may be able to operate your TV, Cable Box or Digital Satellite System with the remote control.

RF coaxial cable: The cable supplied with your VCR. Use it to connect your VCR to your TV (or Cable Box, if applicable). The supplied cable is a snap-on type. However, you may also use a screw-on type if you prefer.

Special Effects: forward and reverse searching; viewing a still picture; slow motion.

Tape Speeds: how fast the tape travels during a recording.

- **SP** (standard play) – fastest tape speed (recording time for a T120 tape is approximately two hours); best picture quality.
- **LP** (long play) – average tape speed (recording time for a T120 tape is approximately four hours).
- **SLP** (super long play) – slowest tape speed (recording time for a T120 tape is approximately six hours).

VCR: video cassette recorder.

VIDEO IN/OUT Jacks: jacks located on the back of the VCR which are used to record video from another source (IN) or send video to another source (OUT).

Video Heads

Four heads – Hi-Fi

Video Signal

EIA standards; NTSC color

Antenna

VHF/UHF – 75 ohm external antenna terminal

VHF Output Signal

Channel 3 or 4 (switchable)
75 ohms unbalanced

Power Requirement

120V AC; 60Hz

Power Consumption

20W

Operating Temperature

41°F (5°C) to 104°F (40°C)

Relative Humidity

10% to 80%

Weight

6.17 lbs. (2.8 kg.)

Dimensions

14-3/16" (W) x 3-1/16" (H) x 9-1/16" (D)
(360 mm x 92mm x 230mm)

Tuner Broadcast Channels

VHF 2-13, UHF 14-69

Cable TV Channels

2 – 13

Midband: A – 1

Superband: J – W

Hyperband: A-5 – A-1

Special Channel: 5A

Ultraband: 37 – 94, 100 – 125

NOTE: Designs and specifications are subject to change without notice.

**RENEWED
90 DAY
LIMITED WARRANTY**

| | | |
|---------------------------------------|--------------------------------------|---------------------------------------|
| ac power cord.....25 | memory button.....20, 41 | stereo |
| accessories56 | menu button20 | broadcast |
| ant(enna) in jack6-10, 25 | mts broadcast stereo system....44-45 | receiving.....44-45 |
| audio in/out jacks.....10, 25, 38, 50 | mute button.....21 | recording.....44-45 |
| automatic | | hookups.....44 |
| playback.....43 | number buttons20 | still picture.....42 |
| rewind, eject, off.....43 | | stop button21 |
| batteries5 | on screen off mode.....22 | stop/eject button24 |
| cable/dss button5, 19, 21 | on screen on mode.....22 | super high speed searching42 |
| cassette compartment.....23 | on screen status displays22 | super long play32, 50 |
| cassette-inside light23 | one touch recording.....29 | table of contents.....4 |
| ch3/ch4 switch6-9, 25 | out jack.....6-9, 25 | tape |
| channel | | duplication.....38 |
| above 100.....20 | pause button.....24 | eject.....21, 24, 43 |
| adding.....13 | pause/still button.....21, 27, 42 | speed.....32, 50 |
| deleting.....13 | play button20, 24, 26, 42 | time (setting).....15 |
| memory.....12 | playing.....26 | time search button.....20, 40 |
| programming.....12 | power | timer |
| reviewing.....14 | button.....20, 24 | light.....23 |
| up/down buttons.....21, 24, 43 | cord.....25 | recording |
| clear button.....21, 41 | pwr(power). light.....23 | cancelling.....33 |
| clock display.....23 | rear panel25 | checking.....33 |
| clock setting.....15 | rec/otr button.....20, 24, 27, 29 | setting.....30-32 |
| connections.....6-10 | rec(ord) light.....23 | with the vcr plus+ |
| contents, table of.....4 | recording | programming system....34-37 |
| controls | basic.....27 | tracking.....43 |
| remote.....20-21 | one channel/ | tv |
| vcr.....23-25 | watching another.....28 | button.....5, 18, 21 |
| counter only mode.....22 | timer.....30-33 | controls.....5, 18, 20-21 |
| daylight-saving time16 | with the vcr plus+ | hookups6-10 |
| display panel.....23 | programming system.....34-37 | position.....21, 24 |
| duplication.....38 | remote control | vcr |
| eject button.....21 | buttons.....20-21 | button.....5, 21 |
| erase prevention5 | sensor.....24 | light.....23 |
| f.fwd button.....21, 24, 42 | using.....5 | plus+ |
| front panel.....24 | repeat playback39 | programming system.....34-37 |
| glossary.....50 | rerecording38 | plus+/enter button.....20, 34-37 |
| helpful hints.....48-49 | rew(ind) button.....20, 24 | position.....21, 24 |
| hi-fi stereo sound system46-47 | rf coaxial cable.....6-9, 38, 50 | vcr/tv button.....21, 24 |
| hookups | safety precautions.....3 | video in/out jacks.....10, 25, 38, 50 |
| with cable box.....8-9 | satellite hookups.....48 | volume up/down buttons.....21 |
| with stereo tv.....10 | searching.....42 | warranty.....52 |
| without cable box.....6-7 | second audio broadcast | |
| language selection.....11, 17 | receiving.....44-45 | |
| line input mode.....12, 38, 50 | recording.....44-45 | |
| long play.....32, 50 | sensor (remote).....24 | |
| lp.....32, 50 | slow | |
| | button21 | |
| | motion.....42 | |
| | slp32, 50 | |
| | sp32, 50 | |
| | speed button.....20 | |
| | standard play.....32, 50 | |
| | status display.....22 | |
| | status/exit button.....20, 22 | |

SUPPLIED ACCESSORIES

Check to be sure the items on this page are packed with your VCR. These accessories are provided to help you use or set up your VCR.

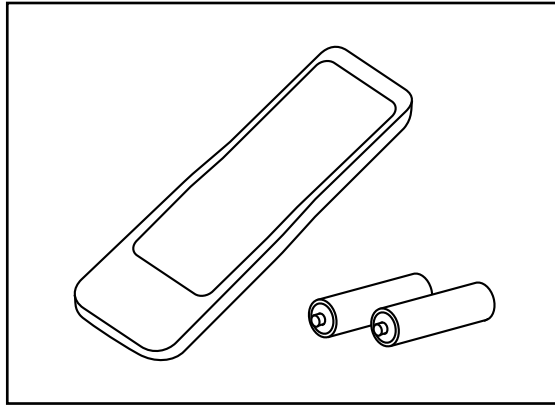

**Remote Control (4835 218 37192)
Two "AA" Batteries (4835 138 17012)**

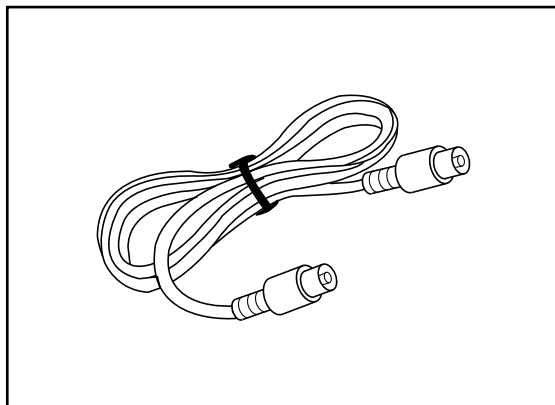

RF Coaxial Cable, 75 ohm (4835 323 27011)

If any of these items are not included, or if you need to replace an item, contact Philips Service Company at the address below.

***Philips Service Company
P.O. Box 967
Greeneville, TN 37744-0967***

Or, call 1-800-851-8885.

Free Manuals Download Website

<http://myh66.com>

<http://usermanuals.us>

<http://www.somanuals.com>

<http://www.4manuals.cc>

<http://www.manual-lib.com>

<http://www.404manual.com>

<http://www.luxmanual.com>

<http://aubethermostatmanual.com>

Golf course search by state

<http://golfingnear.com>

Email search by domain

<http://emailbydomain.com>

Auto manuals search

<http://auto.somanuals.com>

TV manuals search

<http://tv.somanuals.com>