

# Fluorescent lamps

# TL-E /TL-E Pro



Fluorescent lighting is efficient and economical. The efficacy (lumen/watt) of all fluorescent lamps is high compared to most other light sources and they can be used with a wide range of luminaires for various purposes. TL-E are low-pressure mercury discharge lamps with a clear tubular envelope. The tube wall is internally covered with a mixture of fluorescent powders. TL-E /80 colours are produced with a tri-phosphor coating, which leads to a good colour rendering and a higher efficacy. TL-E /80 colours are used in 'human applications', like schools, offices, shops, theatres and so on. TL-E Standard colours are produced with a halophosphor coating, which results in an average colour rendering.

The colour designation of TL-E lamps creates a certain atmosphere. It varies from cool white to warm white. The colour designation is determined by the colour temperature of the lamp. TL-E lamps can be operated on conventional and HF gear. A specialty is the TL-EM-RS lamp in 40W rating, provided with an external ignition strip connected to one of the electrodes via a high ohm resistor. TL-EM-RS lamps can be used in outdoor applications (ambient temperature of -18 °C). Many decorative luminaires are available for TL-E lamps because of their special circular shape. An added advantage is the provision of non-directional light, i.e. light which does not emphasize either the length or width of the area to be lighted.

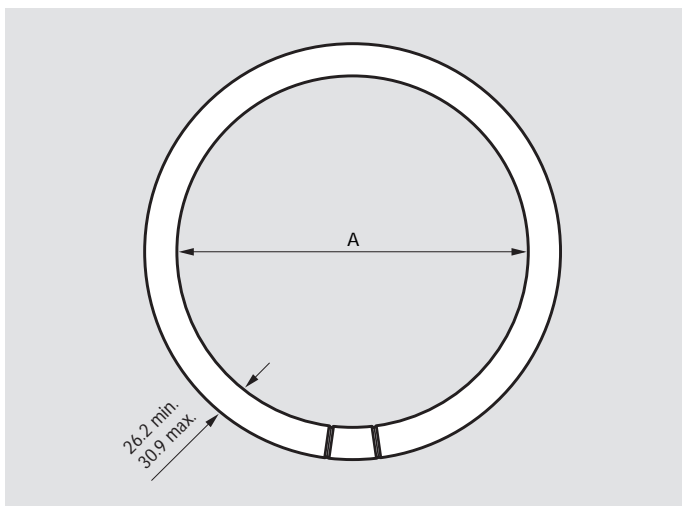

Dimensions in mm

Type	A min.	A max.
TL-E 22W	147.6	157.2
TL-E 32W	236.5	246.1
TL-E 40W	338.1	347.7

Commercial name	Type	Cap/ base	Lamp voltage V	Lamp current A	Colour designation	Correlated colour temperature K	Lumen output lm	Average luminance cd/cm <sup>2</sup>	Nett weight g	EOC
<b>TL-EM RS STANDARD COLOURS</b>										
TL-E	TL-EM 40W /29 RS	G10q	110	0.42	WARM WHITE	2900	2800	0.75	333	611086
<b>TL-E STANDARD COLOURS</b>										
TL-E	TL-E 22W /29	G10q	62	0.40	WARM WHITE	2900	1300	0.85	220	284723
TL-E	TL-E 22W /33	G10q	62	0.40	COOL WHITE	4100	1250	0.85	220	559425
TL-E	TL-E 22W /54	G10q	62	0.40	COOL DAYLIGHT	6200	1050	0.70	220	633903
TL-E	TL-E 32W /25	G10q	81	0.45	COOL WHITE	4000	1800	0.65	250	284983
TL-E	TL-E 32W /29	G10q	81	0.45	WARM WHITE	2900	2100	0.80	250	284709
TL-E	TL-E 32W /33	G10q	81	0.45	COOL WHITE	4100	2050	0.80	250	559562
TL-E	TL-E 32W /54	G10q	81	0.45	COOL DAYLIGHT	6200	1750	0.65	250	633873
TL-E	TL-E 40W /25	G10q	110	0.42	COOL WHITE	4000	2500	0.65	333	285003
TL-E	TL-E 40W /29	G10q	110	0.42	WARM WHITE	2900	2950	0.80	333	284686
TL-E	TL-E 40W /33	G10q	110	0.42	COOL WHITE	4100	2900	0.80	333	284549
TL-E	TL-E 40W /54	G10q	110	0.42	COOL DAYLIGHT	6200	2500	0.65	333	559913
<b>TL-E SUPER /80 COLOURS</b>										
TL-E Pro	TL-E 32W /830	G10q	81	0.45	WARM WHITE	3000	2300	0.85	250	559678
TL-E Pro	TL-E 32W /840	G10q	81	0.45	COOL WHITE	4000	2300	0.85	250	559685
TL-E Pro	TL-E 40W /830	G10q	110	0.42	WARM WHITE	3000	3200	0.85	333	284761
TL-E Pro	TL-E 40W /840	G10q	110	0.42	COOL WHITE	4000	3200	0.85	333	284747

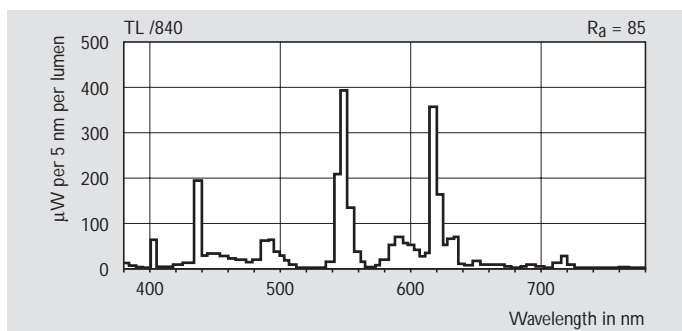
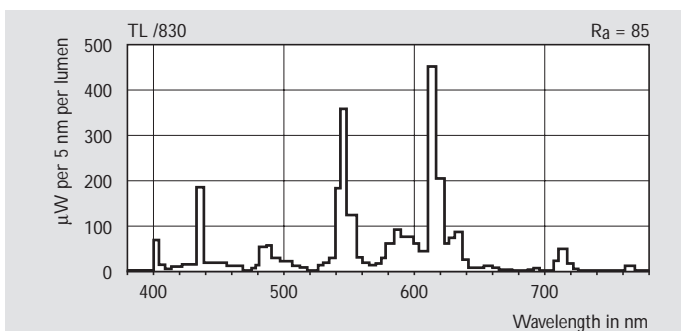
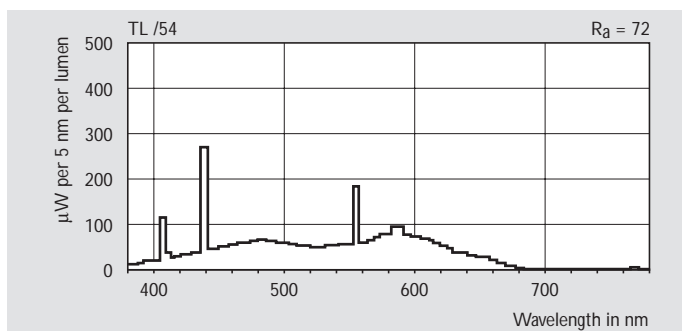
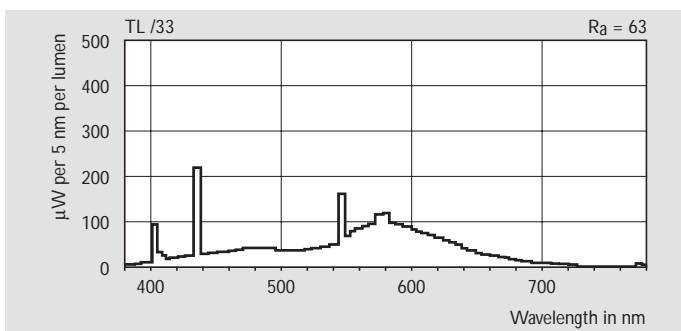
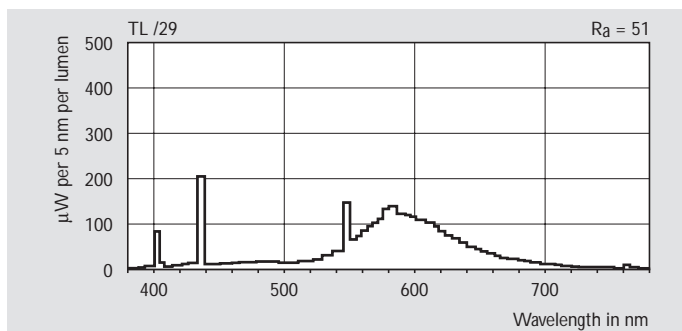
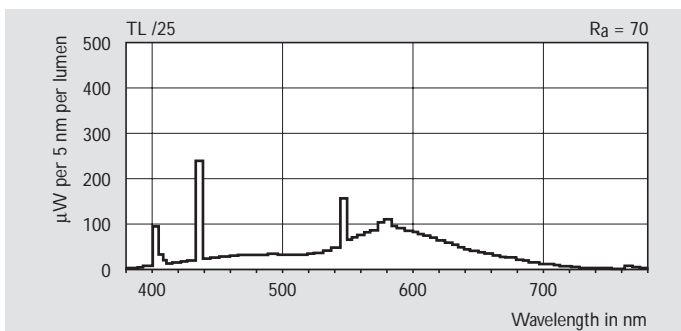

Spectral power distributions

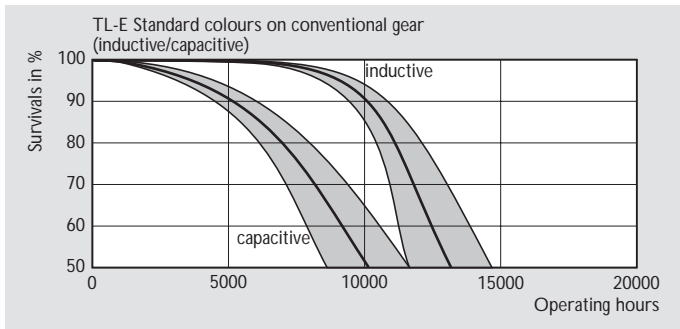

Life expectancy

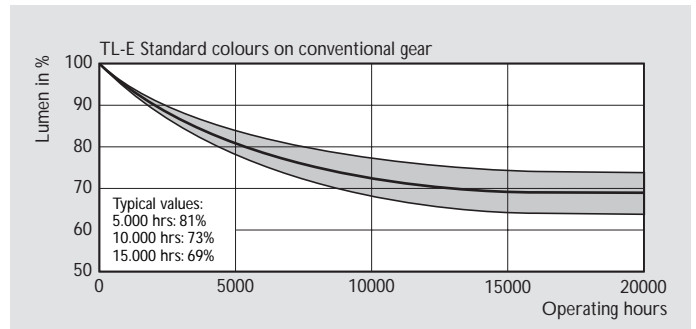

Lumen maintenance

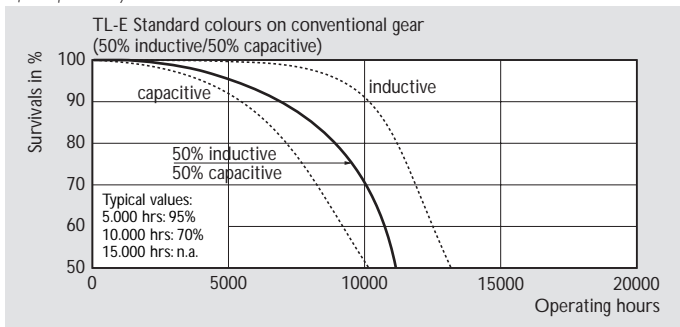

Life expectancy

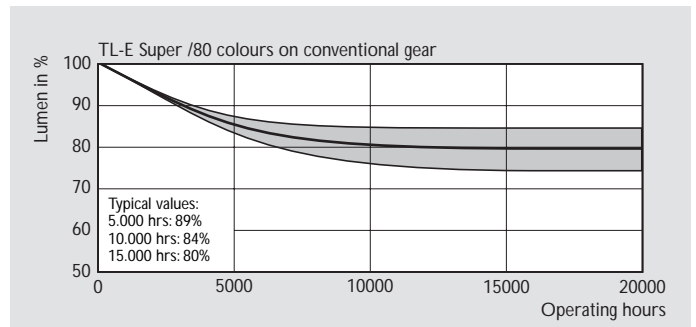

Lumen maintenance

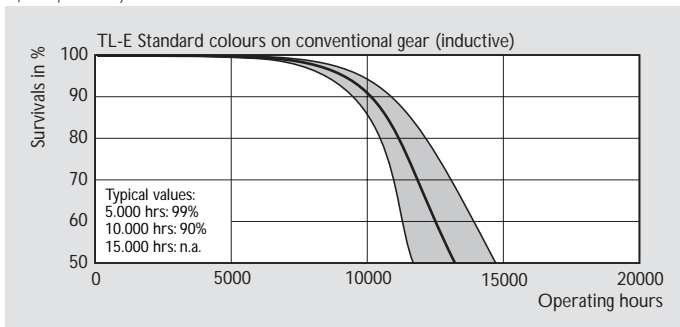

Life expectancy

## Free Manuals Download Website

<http://myh66.com>

<http://usermanuals.us>

<http://www.somanuals.com>

<http://www.4manuals.cc>

<http://www.manual-lib.com>

<http://www.404manual.com>

<http://www.luxmanual.com>

<http://aubethermostatmanual.com>

Golf course search by state

<http://golfingnear.com>

Email search by domain

<http://emailbydomain.com>

Auto manuals search

<http://auto.somanuals.com>

TV manuals search

<http://tv.somanuals.com>