





pm1400

Professional Stereo Power Amplifier

# Safety Information

 <p><b>CAUTION</b> RISK OF ELECTRIC SHOCK DO NOT OPEN</p> 	 <p>The lightning flash with arrowhead symbol within an equilateral triangle is intended to alert the user to the presence of uninsulated "dangerous voltage" within the product's enclosure that may be of sufficient magnitude to constitute a risk of electric shock to persons.</p>
<p>CAUTION: TO REDUCE THE RISK OF ELECTRIC SHOCK DO NOT REMOVE COVER (OR BACK) NO USER-SERVICEABLE PARTS INSIDE REFER SERVICING TO QUALIFIED SERVICE PERSONNEL</p>	 <p>The exclamation point within an equilateral triangle is intended to alert the user of the presence of important operating and maintenance (servicing) instructions in the literature accompanying the appliance.</p>

# Table Of Contents

Introduction.....	1	Bridged Mono.....	8
Unpacking and Paperwork.....	1	Parallel Mono.....	8
Features and Specifications .....	2	70V Distribution Systems.....	9
Controls and Functions.....	4	Clipping Eliminator .....	9
Installation		Level Defeat.....	9
Location and General Precautions.....	6	Power ON Sequencing.....	9
Mechanical Considerations.....	6	Remote Turn-On of	
Rear Support for Road Applications.....	6	One or More Amplifiers .....	10
Thermal Considerations.....	6	Operating Tips	
AC Power Considerations.....	6	Using the pm1400.....	11
Magnetic Leakage		Accessory Options .....	11
Considerations.....	7	Servicing Instructions.....	12
Input Wiring.....	7	In Case of Difficulty.....	13
Input Sensitivity.....	7	Care and Service Assistance.....	14
Output Wiring.....	8	Warranty Information.....	15
Installation (continued)			
Polarity.....	8		
Dual Mono.....	8		

# Introduction

pm1400

Congratulations on your purchase of a new Carver Professional Power Amplifier. It is backed by state-of-the-art engineering and manufacturing techniques to bring you the best in quality craftsmanship and reliable performance. The pm1400 is specially designed for pro sound applications. It's rugged construction and low profile make it ideal for sustaining the abuses of the road with reliability and space-saving economy. The pm1400 is rated at 700 watts per channel into 4 ohms and 475 watts per channel into 8 ohms. In bridged mono operation it is rated at 1400 watts into 8 ohms. The sophisticated protection circuits designed into this amplifier will protect your system should an unexpected fault occur. They also protect the amplifier from excessive temperature, continuous current limiting and shorted outputs. The balanced input uses a high quality, high common-mode rejection differential amplifier for exceptional hum and noise rejection. The sequencing feature allows a rack of amplifiers to be powered up from a remote location. The daisy-chain connection scheme causes each amplifier to turn on in sequence, preventing the large in-rush current that can occur when an entire rack of amplifiers is turned on simultaneously. This power amplifier was designed and manufactured by people with a lifetime commitment to providing the world's finest components for music and sound reproduction. Thanks for placing your confidence in Carver Professional. We know your amplifier will provide many years of dependable service and reliable sound reproduction.

## Unpacking and Paperwork

Carefully unpack the amplifier and keep the original carton and packing materials for future moving, shipment or long-term storage. After opening the box, please check for any visible signs of damage that were not apparent from the outside of the box. If you do encounter what appears to be concealed damage, please consult your Carver Professional Dealer before installing the unit.

### Important Paperwork

Make sure to save your sales receipt. Your receipt is extremely important to establish the duration of your Limited Warranty, and for insurance purposes. Next, make a note of the serial number which is located on the back of the amplifier. Record it in the space provided below for convenient reference.

Serial Number: \_\_\_\_\_

Purchased at: \_\_\_\_\_

Date: \_\_\_\_\_

Finally, take a moment to fill out and return the Warranty Registration Card packed with the amplifier and return it to Carver Professional. This will allow us to keep you informed about new products as they become available.

# pm1400

- 475W per channel into 8 ohms  
700W per channel into 4 ohms  
1400W into 8 ohms, bridged mono
- XLR and 1/4" TRS input connectors
- Accepts balanced or unbalanced lines
- Multi-way binding post output connectors
- Independent CH 1 and CH 2 Level Controls with 11 detented positions
- External Level Control Defeat Switch
- Dual Mono mode for operating both channels with a single mono input
- Bridged Mono mode for combining the power of both channels into a single higher powered channel
- Input sensitivity set at 1.5Vrms from factory. Internally configurable to 0.775Vrms.
- Internally configurable input polarity
- Internal connection points for add-on accessories
- Power ON Sequencer
- High Efficiency Class H Amplifier
- Power on muting
- Independent CH 1/CH 2 Speaker relays will instantaneously disconnect if one of the following fault conditions are detected:
  - D.C. Offset
  - Over Temperature
  - Short Circuit
- Additional protection circuitry includes:
  - Clipping Eliminator
  - AC Line Fuse
- Power Connected/Standby indicator
- 7 LED display per channel, including Power Ready and Clip/Protect indicators
- 2-speed Fan cooled
- 70-volt stereo direct drive operation
- C/UL, CE 1997, CSA approved



<b>Continuous Average Output Power, both channels driven:</b>	475 watts per channel into 8 ohms from 20Hz to 20kHz, with no more than 0.1% THD; 700 watts per channel into 4 ohms at 1kHz, with no more than 0.1% THD	<b>Signal-to-Noise Ratio:</b>	>100dB, A-weighted, ref. to rated power into 4 ohms
<b>Bridged-mono operation:</b>	1400 watts into 8 ohms at 1kHz, with no more than 0.1% THD	<b>Slew Rate:</b>	40V / $\mu$ S (Bandwidth limited)
<b>Dual-mono operation:</b>	950 watts into 8 ohms, 1400 watts into 4 ohms from 20Hz to 20kHz, with no more than 0.1% THD	<b>CMRR:</b>	>80dB @ 1kHz
<b>Dynamic Headroom:</b>	>2.0dB	<b>Power Consumption:</b>	40W at idle 800W with musical program 1500W at full power into 8 ohms (continuous) 2400W at full power into 4 ohms (continuous)
<b>Frequency Response:</b>	20Hz to 20kHz ( $\pm$ 0.75dB)	<b>Power Requirements:</b>	120V AC / 60Hz (USA and Canada) Other volt-ages as required for export
<b>Channel Separation:</b>	>65dB @ 1kHz	<b>Fusing:</b>	15 amp slo-blo (120V / 60Hz) 8 amp slo-blo (230V / 50Hz)
<b>Damping Factor:</b>	>400	<b>Sequence Receive Terminal:</b>	+7V to +15V DC 50mA min. current requirement
<b>Input Impedance:</b>	25 kilohms unbalanced 50 kilohms balanced	<b>Display:</b>	7 LED indicators per channel 1 green READY, 5 yellow SIGNAL, 1 red CLIP / PROTECT
<b>Sensitivity:</b>	Low: 1.5VRMS for rated power into 4 ohms 116mVRMS for 1W into 4 ohms High: 0.775VRMS for rated power into 4 ohms 53mVRMS for 1W into 4 ohms	<b>Size (H x W x D):</b>	3.50" (2U) x 19" x 13.25" 89mm x 483mm x 337mm
<b>Input Overload:</b>	+18dB	<b>Net Weight:</b>	34.2lbs. (15.5kgs)
<b>IM Distortion:</b>	<0.1%	<b>Shipping Weight:</b>	39lbs. (17.73kgs)
<b>Gain:</b>	High: 36.7dB ( $\pm$ 0.5dB) Low: 30.7dB ( $\pm$ 0.5dB)	Due to ongoing research and development, all specifications and features effective 7/98 are subject to change without notice.	

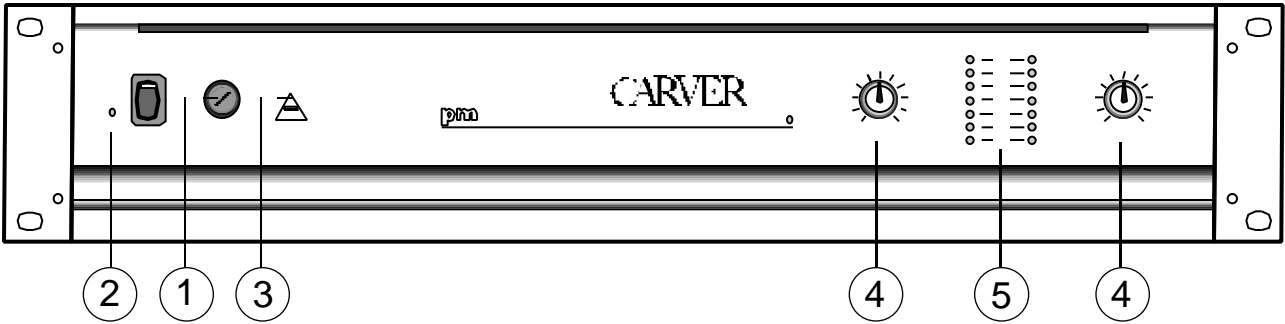

# Controls And Functions

## 1. POWER SWITCH

When this switch is engaged, the power turns ON and the READY indicators illuminate. Be sure all connections are made and double-checked before switching the power amplifier on.

## 2. STANDBY LED

This indicator illuminates when the power switch is turned OFF. It also lets you know when the amplifier is connected to AC power. When the power switch is OFF and the amplifier is plugged into an AC outlet, the LED illuminates to indicate that AC power is available and the amplifier can be powered up. When the power switch is ON, the LED turns off.

## 3. AC POWER FUSE

This protects the amplifier from catastrophic failures that could damage internal circuitry. Repeated fuse blowing is a sign of internal distress. See page 14 for information on authorized Carver Professional Service.

**Caution:** Always replace with the same type and value fuse indicated next to the fuseholder.

## 4. CH1 / CH2 LEVEL CONTROLS

These controls are used to adjust the input level of each channel. When the controls are fully clockwise the amplifier operates at maximum gain. Turning the controls counter-clockwise attenuates the input signal. The Level controls can be bypassed. See back panel for Level Defeat Switch.

**Note:** A precision attenuator is available as an option for the pm1400, which can be installed inside the amplifier (see page 11). Contact your Carver Professional Dealer for details.

## 5. CH1 / CH2 STATUS INDICATORS

These LEDs display information about the operation of the amplifier.

**READY** – These LEDs illuminate green when the power is on and the amplifier is ready to operate. The READY LEDs illuminate red when the power switch is first turned on (while the power supply is stabilizing prior to the speaker output relays switching in), or when the amplifier is in protect mode.

**SIGNAL** – These LEDs illuminate yellow when a signal is present at the Speaker Output jacks to provide an indication of output power relative to full power (0dB).

**CLIP/PROTECT** – These LEDs illuminate red when the power switch is first turned on, when the output begins to clip, or whenever there is a fault condition detected that causes the output relay(s) to disengage. These fault conditions include excessive DC Offset, excessive heatsink temperature and short circuits at the speaker output(s).

**Note:** The relays operate independently for each channel. Therefore, it is possible for one channel to operate normally while the other is in “protect” mode.

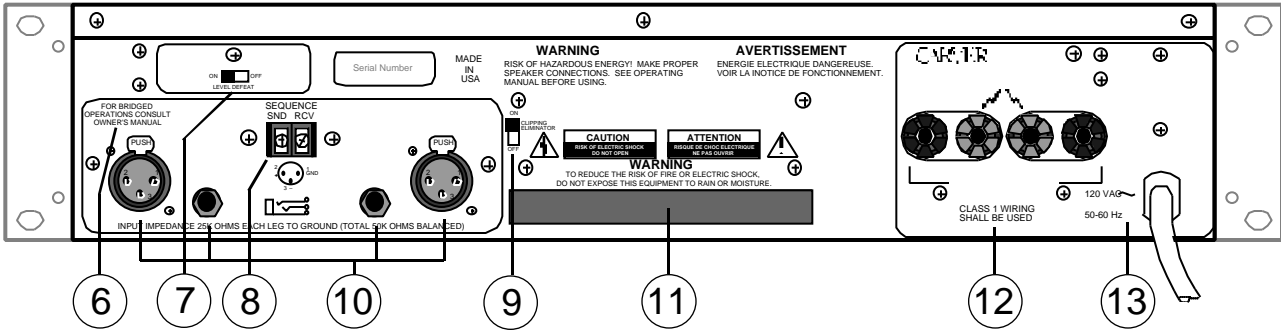

### 6. BRIDGED OPERATION

The STEREO/MONO switch is located just behind the input panel. This switch is used to select between NORMAL STEREO operation, DUAL MONO operation, or BRIDGED MONO operation. For NORMAL STEREO operation, use CH 1 and CH 2 inputs. For DUAL MONO or BRIDGED MONO operation, use CH 2 input only (see page 12 for instructions on how to access the Stereo/Mono switch, and page 8 for more information about Bridged Operation).

### 7. LEVEL DEFEAT SWITCH

Locks the amplifier at its full gain capacity (see page 12 for more information).

### 8. SEQUENCE SND/RCV

These barrier strip screw terminals are used to link multiple amplifiers for sequenced turn-on. Connect the SND (SEND) terminal of the first amplifier to the RCV (RECEIVE) terminal of the second amplifier. Connect the SND terminal of the second amplifier to the RCV terminal of the third amplifier, and so on (see page 9 and 10 for more information on Power ON sequencing).

### 9. CLIPPING ELIMINATOR SWITCH

The Clipping Eliminator circuit can be activated with a switch located to the right of the input panel. Moving the switch down will deactivate the Clipping Eliminator, allowing the amplifier to clip when driven beyond its maximum output capability. (See page 9 for additional information on the clipping eliminator circuit.)

### 10. CH1 / CH2 INPUT CONNECTORS

There are two methods for making input connections to the amplifier. 1/4-inch TRS (Tip-Ring-Sleeve) connections are provided as well as professional XLR connectors. They can be used with balanced signals or unbalanced signals (see Input Wiring on page 7 for more information).

**Note:** A high-quality input transformer option is available for the pm1400 power amplifiers. Contact your Carver Professional Dealer for details.

### 11. FAN EXHAUST

This opening releases hot air from inside the amplifier. Be sure this vent is clear of obstructions for maximum cooling efficiency.

### 12. CH1 / CH2 SPEAKER OUTPUTS

Multi-way binding posts are used to connect the loudspeakers to the amplifier outputs. The red terminals are the signal connection (+) and the black terminals are the signal return connection (-). The black terminals are internally tied together and to signal ground.

### 13. POWER CORD

Connect to a properly configured outlet providing the line voltage specified for your model.

# Installation

## Location and General Precautions

Observe the following precautions when choosing a location for your amplifier.

**A.** Do not expose the unit to rain or moisture. If a fluid or foreign object should enter the unit, disconnect the power plug and contact an authorized dealer or service center. Do not pull out the plug by pulling on the cord; grasp the plug firmly.

**B.** Protect from heat and allow adequate ventilation. Place away from direct sources of heat, such as heating vents and radiators. All components produce some heat during operation, so make sure that the ventilation holes are not covered and that air is allowed to circulate freely behind, beside and above the unit. Excessive heat is the single greatest source of both short-term and long-term component failure.

## Mechanical Considerations

The pm1400 requires two rack space units (3.5") and a depth of 15" inside the rack, including the rear supports. Secure the unit mechanically using four screws with washers to prevent marring the front panel. Neoprene rubber washers are a good choice because they grip the screw head and prevent them from backing out when vibrated or transported.

## Rear Support for Road Applications

If the pm1400 is rack-mounted and the rack is transported, mechanical support for the rear of the amplifier is required. This could take the form of a shelf across the rear of the amplifier or brackets that engage the rear of the unit. This practice is recommended for all electronic instruments.

## Thermal Considerations

When the pm1400 is used free-standing, no thermal considerations are necessary other than keeping the ventilation holes open. If the amplifiers are rack-mounted, ensure that adequate ventilation exists in front of and behind the amplifier. When several amplifiers are mounted together in a rack, you may need to provide air inlets from the outside of the rack. The pm1400 is fan cooled. The fan is internally mounted so that it draws air in from the front and exhausts it out the rear. This allows cool air from outside the amplifier to flow over and cool the power supply components located in front of the heatsinks before being warmed by the heat-producing output devices, thus providing optimum cooling efficiency. The pm1400 may be stacked directly on top of other amplifiers without spacer panels. If the amplifiers are used with other amplifiers, ensure that the heat output from the other amplifiers doesn't interfere with the ventilation of the pm1400 (or vice versa).

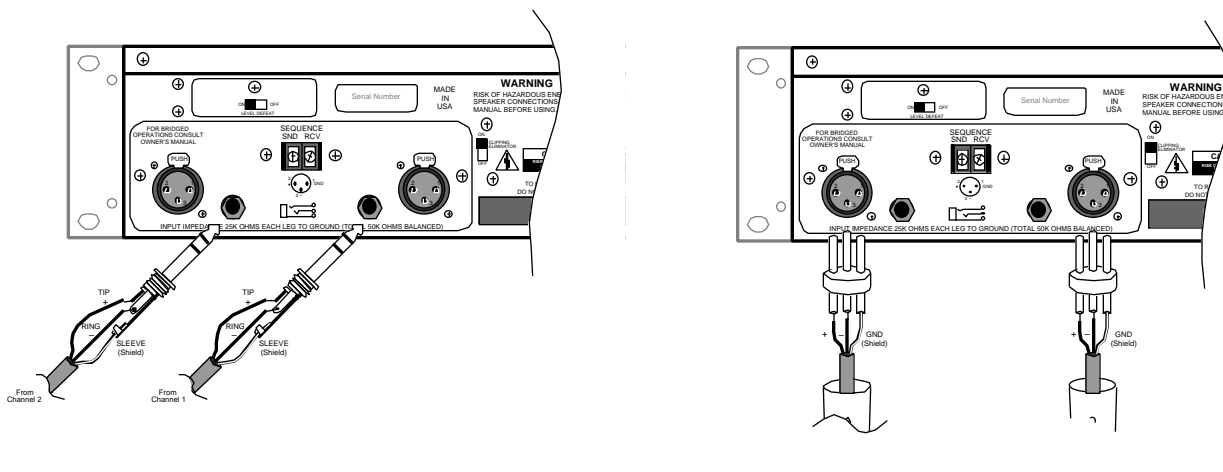



## AC Power Considerations

Ensure that the pm1400 is plugged into an outlet capable of supplying the correct voltage specified for your model and enough current to allow full-power operation of all the amplifiers plugged into it. The current demand of a power amplifier varies depending on several factors, including the impedance of the load, the output level of the amplifier, and the crest factor and duty cycle of the program material. Under typical conditions reproducing rock music, with both channels driven into a 4 ohm load to the point where musical peaks are just at the clipping point, the amplifiers require the following average currents:

**pm1400:** 6.7 amps for 120V versions, 3.5 amps for 230V versions

## Magnetic Leakage Considerations

The pm1400 may be mounted without concern for magnetic flux leakage, within the confines of common sense. For example, it's not a good idea to mount any power amplifier near a microphone input transformer or magnetic storage media.

**Input Wiring** (see your Carver Professional dealer for information on Carver Professional Accessories)

The 1/4-inch phone jacks and XLR connectors for the input signal can be used with either unbalanced 2-conductor or balanced 3-conductor cables. Use shielded coaxial cable to conduct the signal from the source (i.e. mixer, equalizer, CD player) to the amplifier.

**For balanced operation:**

**1/4-inch phone jack:** Use a 3-conductor TRS 1/4" phone plug. The tip of the plug carries the (+, hot, non-inverting) side of the signal, the ring carries the (-, low, inverting) side of the signal and the sleeve is ground (see Figure 3A).

**XLR:** Use a male XLR connector. Pin 2 carries the (+, hot, non-inverting) side of the signal, Pin 3 carries the (-, low, inverting) side of the signal, and Pin 1 is ground (see Figure 3B).

**For unbalanced operation:**

**1/4-inch phone plug:** Use a 2-conductor (Tip-Sleeve) 1/4" phone plug. The tip of the plug carries the signal and the sleeve is ground. The ring connection in the jack is automatically grounded by the sleeve (see Figure 4A). **XLR:** Pin 2 carries the (+, hot, non-inverting) side of the signal, and Pin 1 is ground. Short Pin 3 to Pin 1 in order to reference the input differential amplifier for the correct gain (see Figure 4B). **Note:** The gain remains the same regardless of whether the input is balanced or unbalanced. Note: The polarity of the balanced inputs can be reversed by changing four jumpers located on the Input Board. See page 13 for more information.

## Input Sensitivity

The input sensitivity of the amplifiers are set at the factory to 1.5VRMS for rated output. The input sensitivity can be changed to 0.775VRMS by adding two jumpers on the Main Amplifier Board. See page 12 of this owner's manual for more information.

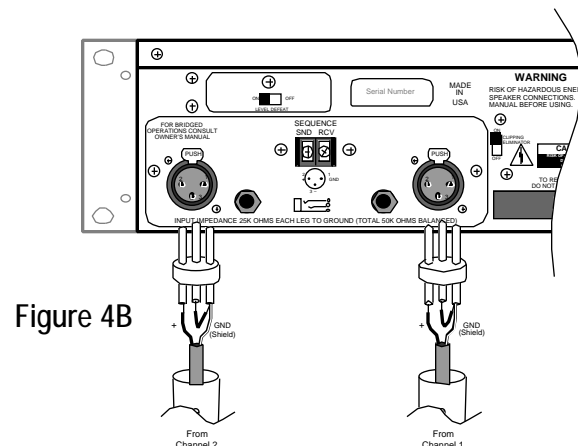
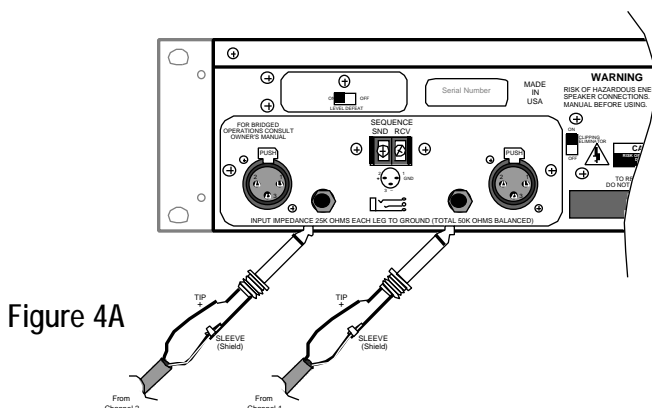

**Output Wiring** (see your Carver Professional Dealer for information on Carver Professional Accessories)  
Use heavy gauge wire for speaker connections. The greater the distance between the amplifier and the speakers, the larger the diameter the wire should be to minimize power losses across the wire and improve the damping of the speaker. Wire thickness specifications (or gauges) get larger as the wire gets thinner; thus 14-gauge wire is thicker than 16-gauge wire. Use the following as a guide: up to 25 ft. use 16 gauge, up to 40 ft. use 14 gauge, up to 60 ft. use 12 gauge, up to 100 ft. use 10 gauge, up to 150 ft. use 8 gauge, up to 250 ft. use 6 gauge.

This will insure that the resistance of the speaker wire is less than 5% of 4 ohms, resulting in a transmission loss of less than 0.5 dB. The multi-way binding posts can accept spade lug, bare wire or banana connections. Be sure that all the fine strands of the wire are twisted together and contained within the connector. If even one strand is loose and can touch the adjacent terminal, a short circuit may result. Class I (NEC) wiring must be used.

### **Polarity**

Loudspeakers must be connected with consistent polarity for correct phasing between them. Incorrect phasing will do no physical harm, but frequency response will be affected. The key is to make sure that both speakers connected to the speaker terminals are hooked up the same way. Connect (-) at the speaker outputs to (-) on the back of the speaker, and (+) at the speaker outputs to (+) on the back of the speaker.

### **Dual Mono**

The Stereo/Mono switch is located on the Input Board which is connected to the input panel. Connect the input signal to CH2 input (CH1 input becomes disabled). Connect the speakers to the Speaker Outputs on the amplifier in the same way that you would for normal stereo operation. Both speaker outputs will carry the signal that is connected to the CH2 input.

### **Bridged Mono**

The Stereo / Mono switch is located on the Input Board which is connected to the input panel. Connect the input signal to CH2 input (CH1 input becomes disabled). Connect the speaker(s) to the two (+) speaker terminals. The CH2 (+) terminal is the hot (non-inverting) side, and the CH1 (+) terminal is the low (-, inverting) side. When connected in this way, each channel "sees" one-half the impedance of the speaker that is connected between them. If an 8 ohm speaker is used, each channel will see a 4 ohm load. Therefore it is not recommended that any total speaker load lower than 8 ohms be connected in this mode of operation. Use Dual Mono operation for lower impedances. **Note:** Be sure to set both of the input level controls to the exact same setting for equal power distribution per channel. Switching the Level Defeat Switch off is a handy way to insure that both channels are operating at the same level.

**CAUTION:** In bridged mono operation, the output connections are actually a balanced output configuration. This means that both output conductors have voltage present (neither one should be grounded).

## 70V Distribution Systems

The pm1400 has sufficient output voltage capability in stereo mode to drive 70-volt distribution systems without using a step-up transformer at the amplifier. In this configuration, the pm1400 delivers up to 475 watts per channel to the 70-volt system, depending on the impedance of the total system. As with all 70-volt systems, transformers are still required at each loudspeaker. The pm1400 can deliver 475 watts per channel into an 8 ohm impedance (61.6V line voltage). The price for going direct is having to calculate the new transformer tap values at the new line voltage. Since watts are proportional to the square of the voltage, compute the correction factor by taking the ratio of the square of the line voltages. Then multiply each tap value by this correction factor. For example, choose a transformer that has taps at 10W, 5W and 2.5W when used in a 70.7 volt distribution. Its new tap values when used with a pm1400 are computed as follows:

1. *Complete correction factor K:*

$$K = 61.6V^2/70.7V^2$$

$$K = .7591$$

2. *Apply to tap value:*

marked tap value \* K=new tap value

$$10W * .7591 = 7.591W$$

$$5W * .7591 = 3.796W$$

$$2.5W * .7591 = 1.898W$$

When used in a 70V distribution system, this transformer's new tap values are 7.6W, 3.8W and 1.9W. Note that the 3dB power relationship between each tap still holds true. Similarly, maximum amplifier loading occurs when the sum of the NEW tap values equals the amplifier's output power (475W)

## Clipping Eliminator

This circuit prevents the input signal from exceeding the point where it would drive the amplifier into hard clipping. It has no effect on the signal until it reaches the point where clipping would occur. The larger the input signal the more the signal is reduced to keep the output just below clipping. The Clipping Eliminator circuitry is inactive when the unit is shipped from the factory, but can be activated with the Clipping Eliminator Switch located to the right of the input panel. **Note:** If the Input Level control(s) are turned down far enough, a sufficiently large input signal can drive the input differential amplifier into clipping. The Clipping Eliminator circuit cannot remedy this kind of clipping. Likewise, it has no effect on clipping that occurs prior to the amplifier inputs (at the mixer or equalizer stage, for example).

## Level Defeat

The Level controls can be defeated with a switch located above the input panel. See page 12 for more information.

## Power ON Sequencing

The Sequencer allows remote turn-on of any number of pm1400 amplifiers (or other Carver Professional amplifiers equipped with sequencing capability). In multiple amplifier applications, the power-on for each

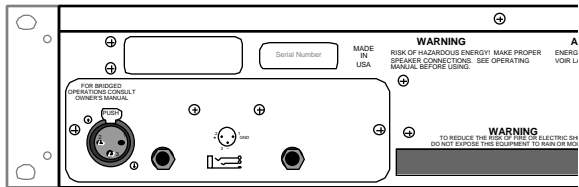

# Operating Tips

## Using the pm1400

Once the amplifier has been installed and wired into the system, you are ready to use it. Here are some tips to help you get the most from it.

- Verify that the switches (Stereo / Mono, Clipping Eliminator and Level Defeat) have been set to the mode that you want.
- When you power the system up for the first time (out of the carton), it's a good idea to start with all of the amplifier level controls turned down (counter clockwise), then advance them slowly, one at a time, so that you can confirm that each amplifier channel is operating normally.
- Be sure that the Input Level controls are set sufficiently high to allow the preceding device to drive the amplifier to full output. For most installations, this is wide open (fully clockwise).
- Once you have established settings, it is a good idea to mark them down, either on paper, or on pieces of tape or sticky-dots attached to the amplifier's panel.
- In bi-amplified (multi-amp) systems, it is a good idea to start with the low-frequency amplifiers turned off or down, and to check each frequency range from highest to lowest to ensure that each loudspeaker component is operating correctly.

## Accessory Options

The amplifiers have internal connections for installing a variety of accessories to provide additional features for specific applications. Some of the options available are:

- A precision attenuator which provides attenuation in 0.5dB increments down to -60dB. Settings are made with a series of DIP switches on the module. (Order model AT2)
- A programmable two-way electronic crossover that outputs the high frequencies through one channel and the low frequencies through the other channel. (Order model CX2)
- High quality balanced input transformers for applications that require electrical isolation. (Order model XFK)

Contact your local Carver Professional Authorized Dealer for information on these and other accessory modules that are available for the pm1400 amplifier.

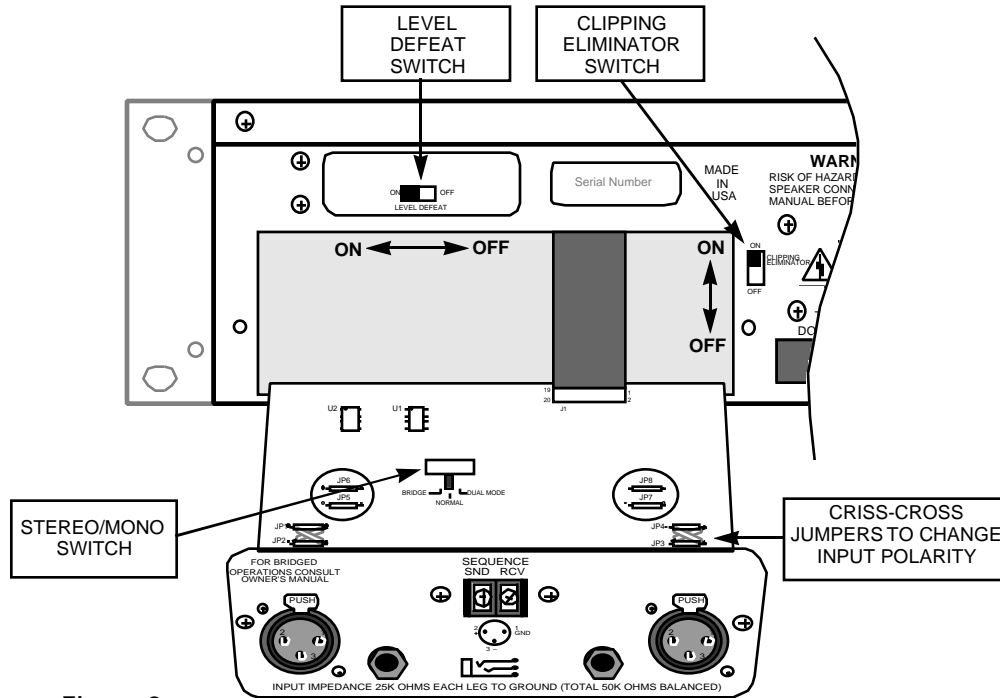

Figure 8

# Servicing Instructions

**CAUTION:** To reduce the risk of electric shock, do not perform any servicing other than that contained in the Operating Instructions unless you are qualified to do so. Refer all servicing to qualified service personnel.

## To remove the input panel and input board:

1. Be sure the amplifier is switched OFF and UNPLUGGED from the AC socket.
2. Remove the two screws located on either side of the input panel.
3. Carefully pull the input board out of the chassis.
4. See Figure 8 for the locations of the Level Defeat Switch, Stereo/Mono Switch, Clipping Eliminator Switch and Input Polarity jumpers. See Figure 9 for the location of the Input Sensitivity jumpers.

## To reinstall the input board and input panel:

5. Carefully insert the input board back into the access hole in the chassis.
6. Reinstall the two screws to secure the input panel.

### Stereo/Mono Switch

The Stereo/Mono Switch is located on the input board, which is attached to the input panel (see Figure 8). Leave the switch centered for normal stereo operation, move it to the left for Bridged Mono operation, and move it to the right for Dual Mono operation.

### Level Defeat Switch

The Level controls can be bypassed by moving the switch located just above the input panel. This will lock the amplifier into full gain (as if the Level pots were fully clockwise). Moving the switch to the right will return the Level controls to normal operation.

### Input Sensitivity Modification

The input sensitivity of the amplifier is set at the factory to 1.5VRMS for rated output. To increase the sensitivity by 6dB to 0.775VRMS, simply install jumpers JP100 (CH 1) and JP200 (CH2), which are located on the Main Amplifier Board (see Figure 9).

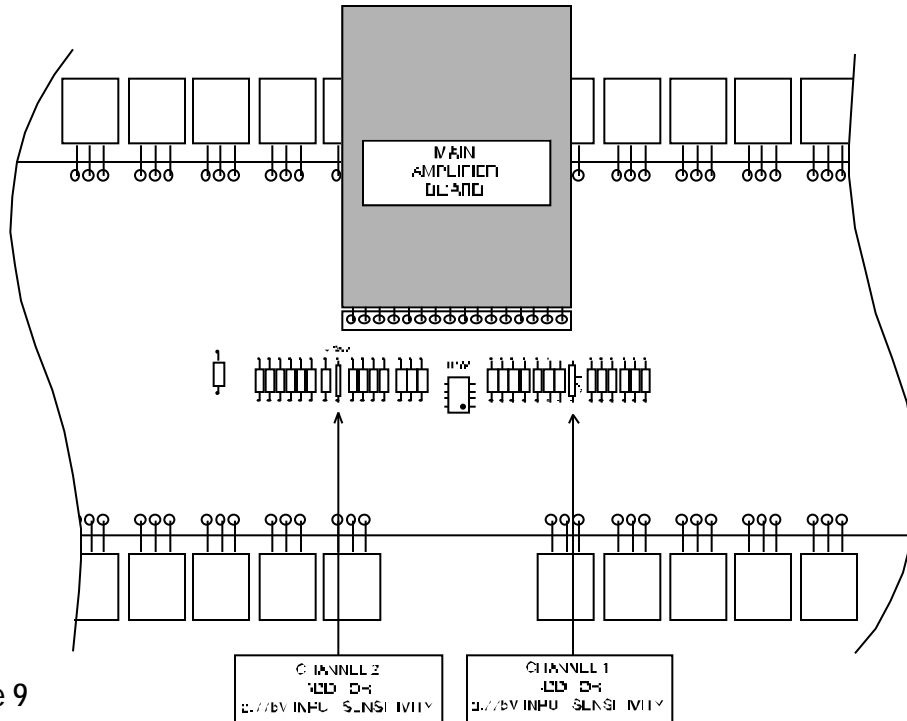

Figure 9

### Input Polarity

The XLR input connectors on the pm1400 are shipped from the factory with pin 2 hot (+), as indicated on the rear panel. The polarity of the balanced inputs can be reversed by changing four jumpers located on the Input Board. Cross-wire JP3 and JP4 to change the input polarity of CH 1 and cross-wire JP1 and JP2 to change CH2 (see Figure 8).

# In Case of Difficulty

If you're having trouble or suspect a problem with the pm1400, try some simple troubleshooting before contacting an Authorized Carver Professional Service Center.

### No Sound, No Power

This is usually an indication of a power supply problem, either the power line itself or the amplifier's power supply.

1. pm1400 power is switched off.
2. Linecord is disconnected.
3. Poor fit between the plug and AC receptacle.
4. Power off at AC receptacle (check with tester or lamp).
5. The amplifier is plugged into a switched outlet. Verify that the outlet is live.
6. pm1400 fuse has blown. Check and replace fuse.
7. The thermal breaker in the power transformer has opened. Allow amplifier to cool and the breaker will reset itself.

### Power On, Low Output or No Output

Low or no output problems are usually signal-source, bad cable or partial output short circuit related. If the items listed below check out, then the problem may be internal to the pm1400.

1. The Input Level controls are set too low.
2. Move the input connections to another amplifier that you know is working to verify that it is not a source problem.
3. Check the speaker connections. Be sure that there are no small strands of wire touching similar strands coming from the other wire in the cable.
4. Make sure the speakers are functioning correctly.
5. If you are using bridged-mono mode, ensure that the Stereo/Mono switch is set correctly.
6. Use a voltmeter to determine if the power line voltage is dropping excessively when the amplifier is driven hard.

### Playback Is Mixed with Hum

1. Check or replace the connecting cables.
2. Make sure that each screw terminal connection is tight.
3. Signal cables may have been routed too closely to AC cables, power transformers, motors or other EMI inducing device.
4. Try connecting another source to the power amplifier inputs. If the hum stops, the problem lies with the original source component.

### Distortion

Distortion is usually caused by excessive loss in the input controls (the mixer/equalizer/crossover can't produce enough output), overdriving resulting in output clipping, or current limiting caused by excessively low load impedances.

1. Check the setting of the Input Level controls. If set too low, the preceding piece of equipment may not have sufficient output to overcome the loss.
2. Check the speaker connections and verify that all screw connections are tight and that there are no stray strands of wire to cause short circuits.
3. Verify that the total load impedance presented to the amplifier is within the limits described in this manual for the mode of operation selected.

# Care and Service Assistance

**Care:** Wipe off the pm1400's front panel and chassis from time to time with a soft, dry cloth. If you have something stubborn to remove, use a mild dish soap or detergent sparingly applied to a soft cloth. Don't use alcohol, ammonia, or other strong solvents.

**Service Assistance:** We suggest that you read the Limited Warranty completely to fully understand your warranty/service coverage. Please promptly complete and return the Warranty Registration Card. Also be sure to save the sales receipt in a safe place. It will be necessary for warranty service. If your CARVER Professional product should require service, you may contact the CARVER Professional Technical Service Department by calling (503) 978-3363 or by writing to us at the Factory address shown below. We will then direct you to the nearest in our national network of Authorized Warranty Service Centers or give you detailed instructions on how to return the product to us for prompt action. If you should have questions or comments, please write to the Factory address given below. Please include the model and serial number of your Carver Professional product, your complete address and a daytime phone number.

**Carver Professional**  
 Service Department  
 P.O. Box 83189  
 Portland, OR 97283  
 Phone 503.978.3363 • Fax 503.978.3302

Carver Professional reserves the right to improve its products at any time. Therefore, specifications are subject to change without notice.



# Warranty Information

## Professional Power Amplifiers: 5 years

pmm1400

### NOTE:

The following warranty is exclusive to the United States and its possessions and territories. Please see your Carver Professional dealer or distributor for the correct warranty information in your area or locale.

### WHAT IS COVERED:

THIS WARRANTY COVERS DEFECTS IN MATERIAL AND WORKMANSHIP ONLY. This Limited Warranty DOES NOT extend to: 1) Damage caused by shipment, 2) damage caused by accident, misuse, abuse, failure to perform owner maintenance, or operation contrary to the instructions in the Carver Professional owner's manual, 3) units on which the serial number has been defaced, modified or removed and 4) damage resulting from modification or attempted repair by any other person than authorized by Carver Professional.

### WHAT WE WILL PAY FOR:

Carver Professional will pay all labor and material expenses for items covered under this Limited Warranty. See the next section concerning shipping charges.

### WHAT YOU MUST DO TO OBTAIN WARRANTY SERVICE:

In the event your Carver Professional product requires service, contact your Carver Professional authorized dealer / contractor **or** contact Carver Professional (ATTN: Customer Service Dept.) 9300 N. Decatur, Portland, OR 97203 or call the Customer Service Department directly at (503) 978-3363. You will be directed to an Authorized Carver Service Station or receive instructions to ship the unit to the factory. Please save the original shipping carton and packing materials in case shipping is required. **Please do not ship Parcel Post.** Include a complete description of the problem, the associated components and connections, and a copy of the purchase receipt. Initial shipping costs are not paid by Carver Professional. Return shipping costs will be pre-paid if repairs were covered by the scope of this warranty.

### YOU MUST RETAIN AND PROVIDE YOUR SALES RECEIPT TO OBTAIN COVERAGE UNDER THIS LIMITED WARRANTY.

The Warranty Period begins from the date of first consumer purchase from an Authorized Carver Professional Dealer. **LIMITATIONS OF IMPLIED WARRANTIES:** All implied warranties for merchantability and fitness for a particular purpose are limited in duration to the warranty period for your product, unless otherwise provided by the state law.

### EXCLUSION OF CERTAIN DAMAGES:

In no event shall Carver Professional be liable for property or any other incidental or coincidental damages which may result from the failure of this product. If your Carver Professional product proves defective in material or workmanship, the liability of Carver Professional shall be limited to the repair or replacement, at the option of Carver Professional, of any defective part.

### STATE LAWS MAY DIFFER:

Some states do not allow limitations on how long an implied warranty lasts and/or do not allow the exclusion or limitation of incidental or consequential damages, so the above limitations may not apply to you. This warranty gives you specific legal rights, and you may have other rights which vary from state to state.

### OTHER IMPORTANT PROVISIONS:

Carver Professional reserves the right to make changes in design and improvements to its products without the responsibility of installing such changes to improvements on products previously sold by Carver Professional. We suggest that you attach your purchase receipt to this Warranty and keep both documents in a safe place. Thank you for your choice of a Carver Professional Amplifier.

**DECLARATION OF CONFORMITY**

We CARVER PROFESSIONAL INTERNATIONAL  
(supplier's name)  
9300 N. DECATUR, PORTLAND, OR 97203 USA  
(address)

declare under our sole responsibility that the product  
pm1400

(name, type or model, lot, batch or serial number, possibly sources and numbers of items)  
to which this declaration relates is in conformity with the following standard(s) or other normative document(s)  
EN55013

(title and /or number and date if issue of the standard(s) or other normative document(s)  
(if applicable) following the provisions of  
89/336/EEC/EMC

Directive  
PORTLAND,OR USA April 25, 1997  
(Place and date of issue)



(name and signature or equivalent  
marking of authorized person)



† **180 DAY**  
Performance  
Guarantee



† **5 Year**  
Warranty

† available in North America only.

A Division Of Phoenix Gold International, Inc.

9300 North Decatur • Portland OR 97203 • Tel: 503.288.2008 • Fax: 503.978.3302

## Free Manuals Download Website

<http://myh66.com>

<http://usermanuals.us>

<http://www.somanuals.com>

<http://www.4manuals.cc>

<http://www.manual-lib.com>

<http://www.404manual.com>

<http://www.luxmanual.com>

<http://aubethermostatmanual.com>

Golf course search by state

<http://golfingnear.com>

Email search by domain

<http://emailbydomain.com>

Auto manuals search

<http://auto.somanuals.com>

TV manuals search

<http://tv.somanuals.com>