

FREE-TO-AIR **SIRD-FTA** **DIGITAL SATELLITE RECEIVER**



Installation and Operation Manual

TABLE OF CONTENTS

1. General information	3
1.1 Safety Instructions	3
1.2 General Features	4
1.3 Accessories	5
2. Controls and Functions	6
2.1 Front Panel	6
2.2 Rear Panel	7
2.3 Remote Control Unit	8
3. Receiver Connections	10
3.1 Connecting to Antenna and Dish	10
3.2 Connecting to TV and VCR using SCART Support	11
3.3 Connecting to TV and VCR using RCA Support	12
3.4 Connecting to TV and VCR using RF Support and RCA	13
3.5 Connecting to Second Receiver	14
3.6 Connecting DiSEqC Switch Box	15
3.7 Connecting to Digital Amplifier	16
4. Main Menu	17
4.1 Setting TV Channels	17
4.2 Setting Radio Channels	23
4.3 Installation Settings	24
4.4 System Settings	34
4.5 Parental Control Settings	38
4.6 Game Selections and Settings	39
5. General View Functions	40
6. Updating Software	43
7. Troubleshooting	44
8. Glossary	46
9. Technical Specifications	48
10. Menu Structure	50

1.1 Safety Instructions

Read the following recommended safety precautions before using this Receiver. Refer to other provided manuals and instructions for equipment that will be connected to this Receiver.

Placing the Receiver

- Place the Receiver indoors to prevent exposure to lightning, rain and direct sunlight.
- Do not place the Receiver on soft furnishings or carpets.
- Allow plenty of space around the Receiver for sufficient ventilation.
- Do not place the Receiver where it may be exposed to direct sunlight or near a heater.
- Do not cover the Receiver or place it on a unit that emits heat.
- Do not stack other electronic equipment on top of the Receiver.

Preventing Electrical Shock and Equipment Damage

- Do not overload wall outlets, extension cords or convenience receptacles because this can increase the risk of fire or electrical shock.
- The ground of the LNB cable must be connected to the system ground for the satellite dish. Grounding procedures should comply with local regulations.
- Do not connect or modify cables when the Receiver is plugged in.
- Do not open the Receiver casing; it will cause a hazard.
- Do not use any attachments that are not recommended because they may cause hazards or damage the equipment.
- Do not use the Receiver if it has been dropped or the casing has been damaged. Disconnect the Receiver immediately and take it to a qualified service center.

Cleaning the Receiver

- Unplug the Receiver from the wall outlet before cleaning.
- Use a soft cloth and a mild solution of dish-washing liquid to clean the casing.
- Never allow liquids, spray or other materials to come into contact with vents or the inside of the Receiver.
- Do not immerse the Receiver in water.

Repairing the Receiver

- Do not attempt to repair this Receiver yourself. It will void your warranty and could cause an electrical shock or equipment damage. Take the Receiver to a qualified service center.

GENERAL INFORMATION

1.2 General Features

Note: The features of your Receiver may differ from those listed below, depending on where you purchased your Receiver. Not all of these features may be available.

- Fully MPEG-2 & DVB Compliant
- Input Frequency 950-2150MHz
- Supports SCPC & MCPC from C-/Ku-Band
- LNB Input Tuner with Loop-Through IF Signal
- Tuner Symbol Rate: 1-45 MS/s
- Fast Booting
- Quick Channel Changing
- Max. 4000 Channels (TV and Radio) Programmable
- User-Friendly, 256-Color On-Screen Display
- Multi-Language On-Screen Display Supported
- Supports Electronic Program Guide
- Radio Channel Background Display
- Favorite Channel List Programmable
- Parental Lock Function
- 8-Step Volume Control
- Automatic Detection of Forward Error Correction
- Simple Video Converter (PAL-NTSC-SECAM)
- Windows-based Software Download Program Supported by RS232 Serial Port
- Channel List Transfer Enabled from Receiver or PC
- Supports 4:3, 16:9 and Teletext VBI
- 7-Segment, 4-Digit Display
- 7 Front Panel Controls
(Power On/Off, Menu, Channel Up/Down, Volume Up/Down, OK)
- LNB Polarity Controls
 - a. DiSEqC 1.0 & 1.2 with 500mA Max. LNB Power
 - b. 22kHz Switching Control
- 2 SCART Outputs (TV or VCR)
- 3 RCA Outputs (Video, Audio L/R)
- Wide Phase-Locked Loop RF Modulator (PAL BG/I/DK, NTSC M)

1.3 Accessories

Package Contents:

- Digital Satellite Receiver
- Remote Control
- Audio/Video Cable
- User's Manual
- Maintenance Card

Throughout this manual you will notice that the operation of your Receiver is based on a series of user-friendly on-screen displays and menus. These menus will help you get the most from your Receiver, guiding you through installation, channel selection, viewing and many other functions.

All functions can be performed using the buttons on the remote control, and some functions can also be performed using the controls on the Receiver front panel.

Please be aware that installing new software may change the functionality of the Receiver. Should you experience any problem with the operation of your Receiver, please consult the appropriate section of this manual, including the troubleshooting section, or call your dealer or a customer service agent.

CONTROLS AND FUNCTIONS



2.1 Front Panel

1. **POWER:** Turns on the working mode or puts the Receiver in standby mode.
2. **Display (4-Digit/7-Segment):** Indicates operating status of the Receiver.
3. **Remote Sensor:** Detects infrared signal from remote control.
4. **VOL+/-:** Changes volume and settings or moves cursor in the menus.
5. **MENU:** Enters the main menu or exits all menus.
6. **OK:** Selects an item in the menu and confirms it.
7. **CH+/-:** Changes channels or moves up and down in the menus.

Front Panel Display

U 52	RF CHANNEL	LOAD	LOADER MODE
E007	FLASH ROM ERROR	HELLO	OPENING GREETINGS
ERR	ERROR	-ES-	UPDATE WAITING
00:25	STANDBY/TIME	ADD1	RECEIVE DATA
0001	TV/RADIO MODE	.	SIGNAL IS RECEIVED
-End	UPDATING IS FINISHED		NO SIGNAL IS RECEIVED

CONTROLS AND FUNCTIONS

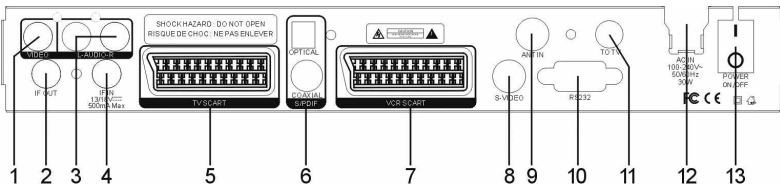

2.2 Rear Panel

Note: The rear panel on your Receiver may differ from the one pictured and described in this manual, depending on where you purchased your Receiver. Not all of the ports pictured in this section may be available. If you need assistance in identifying your specific equipment configuration, contact your authorized dealer.

1. **VIDEO OUTPUT**
2. **IF OUT:** IF output from LNB to other digital tuner
3. **AUDIO OUTPUT**
4. **IF IN:** IF input from LNB to digital tuner
5. **TV SCART:** SCART output to TV
6. **S/PDIF**
7. **VCR SCART:** SCART output to VCR or second Receiver
8. **S-VIDEO**
9. **ANT IN:** Input from terrestrial antenna
10. **RS232:** Serial port to upgrade software
11. **To TV:** Output to TV
12. **AC POWER INPUT**
13. **POWER ON/OFF**(1- ON; 0-OFF)

CONTROLS AND FUNCTIONS

2.3 Remote Control Unit



CONTROLS AND FUNCTIONS

2.3 Remote Control Unit

Note: The remote control for your Receiver may differ slightly from the one pictured and described in this manual, depending on where you purchased your Receiver. If you need assistance in identifying the remote control buttons for specific commands, contact your authorized dealer.

Refer to the numbers shown on the picture.

1. **POWER:** To turn on the working mode or to place the unit on standby mode.
2. **SAT:** To select the satellite channel list.
3. **ZOOM:** To increase the picture size.
4. **OK:** To select an item in the menu and confirm it.
5. **CH+/-:** To switch the channels and view the channel information.
6. **EXIT:** To cancel or exit from the menu.
7. **MENU:** To enter into the main menu or exit all menus.
8. **FAV:** To switch the receiver to the favorite channel list.
9. **RECALL:** To return to the previous channel selected.
10. **EPG:** To view the current channel information and Electronic Program Guide.
11. **MUTE:** To mute (minimize) the volume level.
12. **Alphanumeric character keypad:** To input channel number to select a channel directly, or to input other data in the menu.
13. **FAV+/-:** To switch through the favorite channels.
14. **VOL+/-:** To adjust the volume level, change settings or move left and right in the menu.
15. **AUDIO:** To select the audio mode: left, right, or stereo and audio language in the menu. (Note: Exit all menus before using the audio key.)
16. **PGUP:** To move cursor a page up in the menu or channel list.
17. **PGDW:** To move cursor a page down in the menu or channel list.
18. **INFO:** To view current program information.
19. **TV/RADIO:** To switch the receiver between TV and Radio modes.
20. **PAUSE:** To pause a picture in TV mode.

RECEIVER CONNECTIONS

3.1 Connecting to Antenna and Dish

This Receiver works only with a satellite dish that can access free-to-air programming. The diagram below shows the basic connections required for the satellite LNB, TV and other possible connections on the rear panel. (Consult the following pages for additional connections.) If you need assistance to identify your specific equipment configuration, contact your authorized dealer.

Instructions:

1. Connect satellite input cable to Receiver "IF In."
2. Connect cable from Receiver's "Out to TV" to TV's "In from Antenna."
3. Connect outdoor antenna cable to Receiver's "Antenna In."

For safety reasons, keep equipment unplugged from power sources until all cables are properly connected.

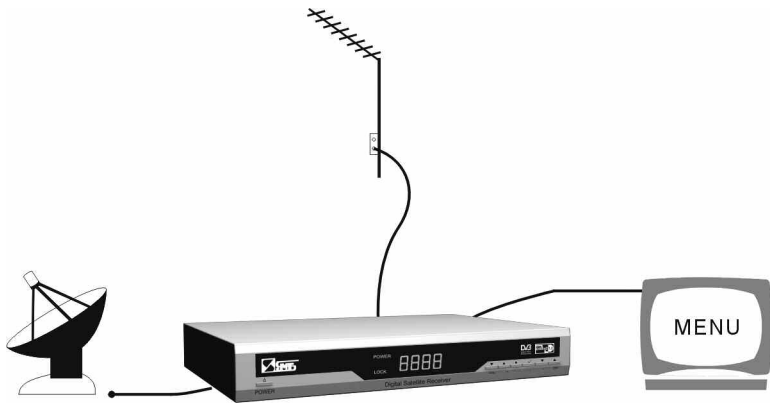

RECEIVER CONNECTIONS

3.2 Connecting to TV and VCR using SCART Support

Note: These instructions apply to a Receiver with both TV and VCR SCART ports. If you need assistance in identifying your specific equipment configuration, contact your authorized dealer.

Instructions:

1. Connect satellite input cable to Receiver's "IF In."
 2. Connect cable from Receiver's "TV SCART" to TV's "SCART."
 3. Connect cable from Receiver's "VCR SCART" to VCR's "Video In" SCART.
- For safety reasons, keep equipment unplugged from power sources until all cables are properly connected.

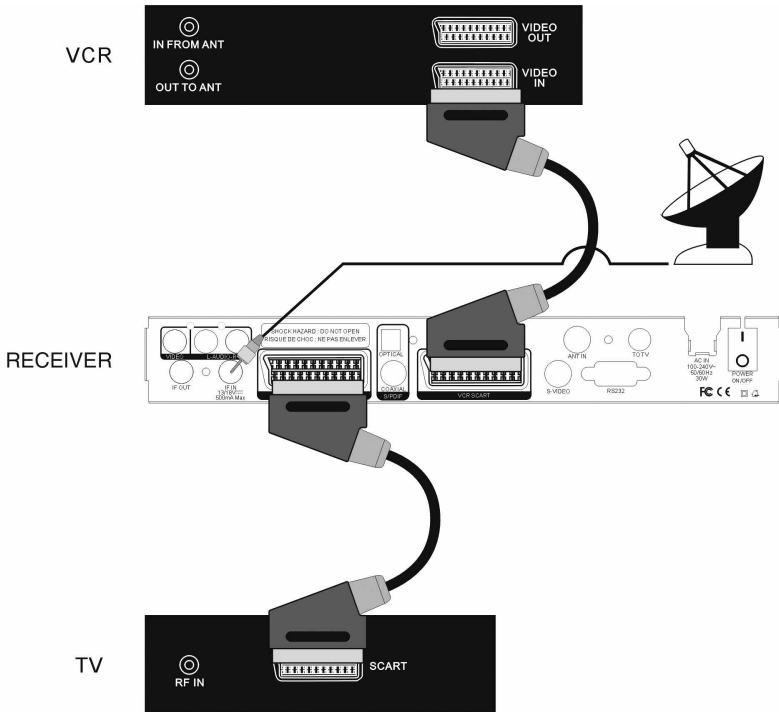

RECEIVER CONNECTIONS

3.3 Connecting to TV and VCR using RCA Support

Instructions:

1. Connect satellite input cable to Receiver's "IF In."
2. Match colors of three-plug RCA cable to Receiver's RCA video and audio outputs and plug them in. Then connect cable to matching colors on TV's video and audio inputs.
3. Match colors of three-plug RCA cable to TV's video and audio outputs and plug them in. Then connect cable to matching colors on VCR's video and audio inputs.

For safety reasons, keep equipment unplugged from power sources until all cables are properly connected.

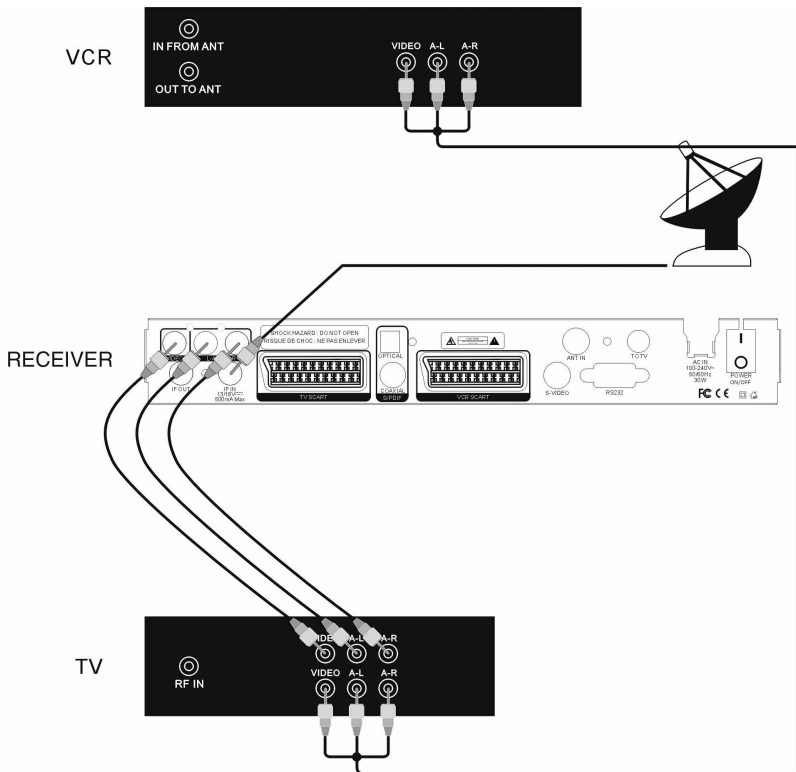

RECEIVER CONNECTIONS

3.5 Connecting to Second Receiver

Note: These instructions apply to a Receiver with SCART ports. If you need assistance in identifying your specific equipment configuration, contact your authorized dealer.

Instructions:

1. Connect satellite input cable to Receiver's "IF In."
2. Connect cable from primary Receiver's "TV SCART" to TV's "SCART."
3. Connect cable from primary Receiver's "IF Out" to second Receiver's "LNB In."
4. Connect cable from primary Receiver's "VCR SCART" to second Receiver's "Video In."

For safety reasons, keep equipment unplugged from power sources until all cables are properly connected.

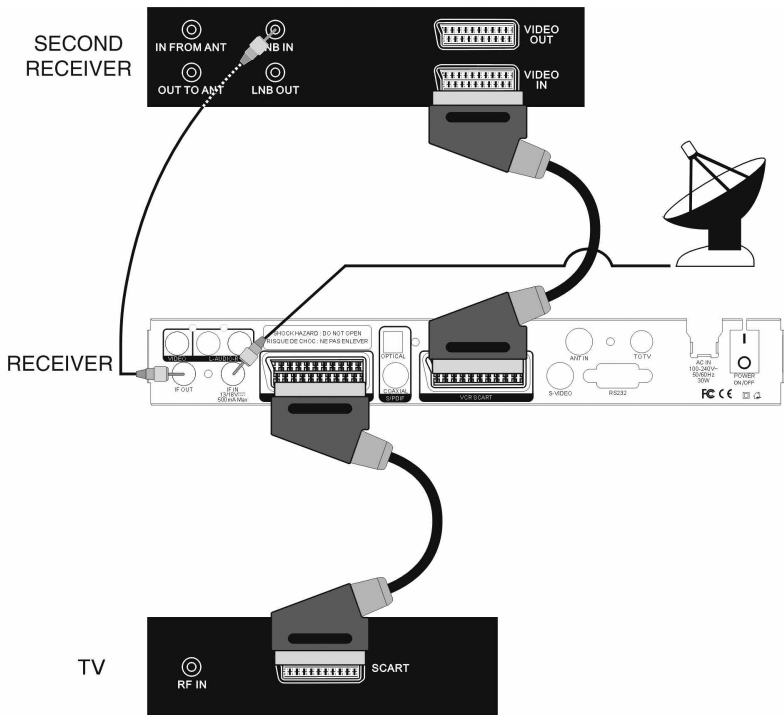

RECEIVER CONNECTIONS

3.6 Connecting DiSEqC Switch Box

Instructions:

1. Connect up to four satellite input cables to DiSEqC Switch Box inputs.
2. Connect DiSEqC Switch Box output cable to Receiver's "IF In."

For safety reasons, keep equipment unplugged from power sources until all cables are properly connected.

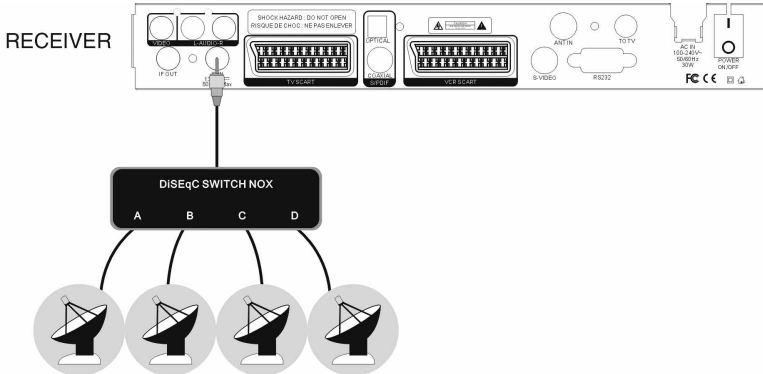

RECEIVER CONNECTIONS

3.7 Connecting to Digital Amplifier

Note: These instructions apply to a Receiver with both SCART and S/PDIF ports. If you need assistance in identifying your specific equipment configuration, contact your authorized dealer.

Instructions:

1. Connect satellite input cable to Receiver's "IF In."
2. Connect cable from Receiver's "TV SCART" to TV's "SCART."
3. Connect cable from Receiver's "S/PDIF" to digital audio converter or amplifier's "S/PDIF."
4. Connect cable from digital audio converter or amplifier's "L" and "R" audio to match speaker's "L" and "R" audio.

For safety reasons, keep equipment unplugged from power sources until all cables are properly connected.

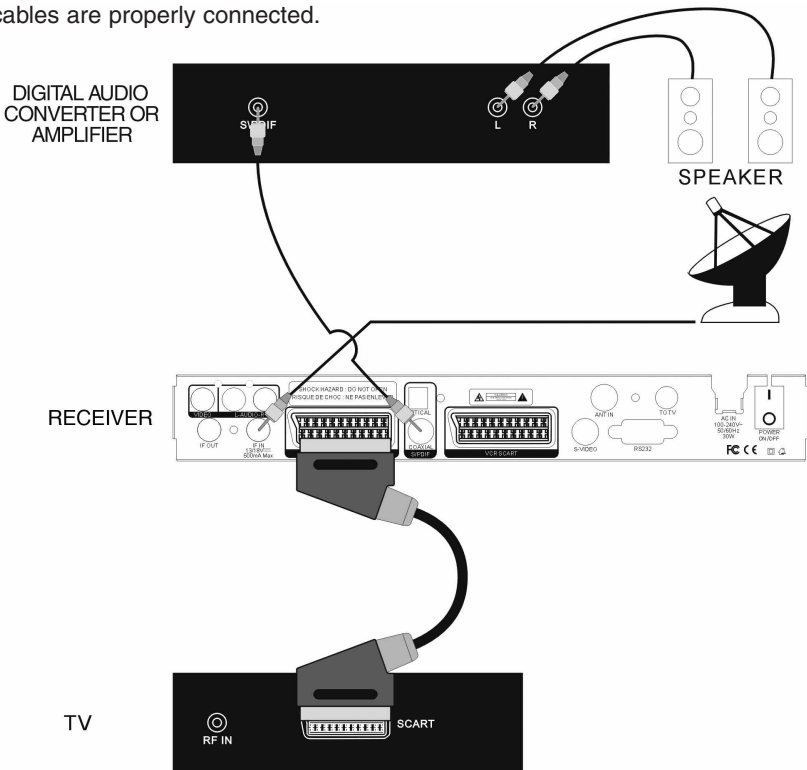

4.1 Setting TV Channels

Press the **MENU** button on your remote control to view the Main Menu on the screen. It has six categories: TV Channel, Radio Channel, Installation, System, Parental Control and Game. See figure below.

Scroll up and down by using **CH+/-**. Pressing the **OK** button always confirms your selection and takes you to the next step. Go back to the previous step by pressing **EXIT**. Exit all menus to watch TV by pressing **MENU**.



Scroll **CH+/-** until you select <TV Channel> then press **OK**, Sub-menus are displayed in the following figure. It has seven categories: Edit Channels, Set Favorites, Sort By FTA, Sort By Satellite, Sort By Transponder, Sort By Favorite and Sort By Alphabet.

Note: Before proceeding with these settings, you must first press the MENU button to enter the Main Menu.



MAIN MENU

Edit Channels

Scroll **CH+/-** until you select <Edit Channels>, then press **OK**. While you are watching TV, you can view the Channel List (shown in the figure below). You can also identify the satellite and transponder of the selected TV channel.

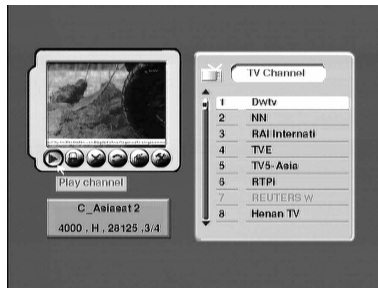

A. Lock

The Lock command lets you block a channel so it cannot be viewed. Select the Lock command by using **VOL+/-**. Once the channel is locked, you will be asked to enter a PIN code before you can view the program.

- Select the "Lock channel" icon by using **VOL+/-**.
- Select a channel you want to lock by using **CH+/-**, then press **OK**. You will be asked to input your password. The default factory password is "0000." Input the password, and the channel will be marked with , as shown in the figure below.
- To cancel, press **OK** and input password again.
- Press **EXIT** to return to the previous menu.



B. Delete

The Delete command allows you to remove a channel from the channel list by using **CH+/-**.

- Select "Delete channel" icon by using **VOL+/-**.
- Select a channel you want to delete by using **CH+/-**, and press **OK**. The channel will be marked with **X**. To cancel, press **OK** again.
- The channel will be automatically deleted when you exit the menu.

C. Move

The Move command allows you to place a channel in a different position on the channel list. After selecting this command, a small input box will appear on the screen. Input a number between 1 to the total number of the existing channels by using **numeric** keys on the remote control. After pressing **OK**, the selected channel will be moved to the new location specified by your input.

- Select "Move channel" icon by using **VOL+/-**.
- Select a channel you want to move by using **CH+/-**, and press **OK**. The sub-menu will appear as shown in the following figure.

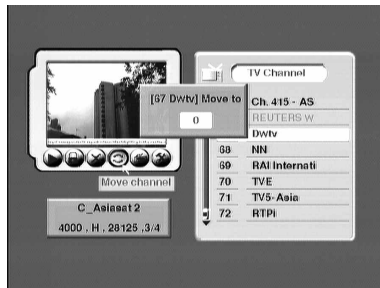

To move the channel to a new position, press **numeric** keys and then press **OK** to confirm it.

- Press **EXIT** to return to the previous menu.

D. Rename

The Rename command lets you change the name of the channel as it appears in the channel list. Select the channel whose name needs to be modified, then press **OK** on the selected "Rename" command option.

- Select the "Rename channel" icon by using **VOL+/-**.
- Select a channel you want to rename by using **CH+/-**, and press **OK**. The sub-menu will appear as shown in the following figure.



MAIN MENU

- c. Press **alphanumeric** character key to rename channel.
- d. Press **OK** key to confirm it.
 - Back space: Press **VOL-** to delete character one by one.
 - Cancel: Press **AUDIO** to delete all added characters.
- e. Press **EXIT** to return to the previous menu.

Note: Pressing "1" switches between capitalization and lower case of the alphabet.

E. Modify PIDs

This command allows you to modify the PID values of the selected channel.

- a. Select "Modify channel" icon by using **VOL+/-**.
- b. Select a channel you want to modify the PID by using **CH+/-**.
- c. Press **OK**. The sub-menu will appear as shown in the following figure.

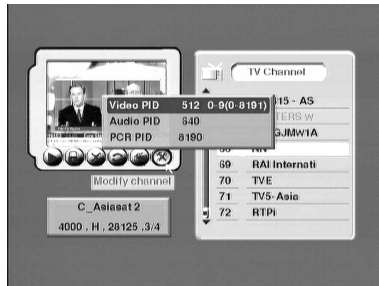

Press **CH+/-**, **VOL+/-** and **numeric** keys to input the data.

Note: Video, Audio and PCR PIDs are mandatory. You can find PID values from satellite information resources.

Set Favorites

Select <Set Favorites> by using **CH+/-**. Press **OK** to view the sub-menu as shown in the figure atop the next page. There are seven categories of favorites channels: Movie, Music, News, Kids, Education, Sport and Entertainment.



A. Movie

- Select the "Movie" icon by using **VOL+/-**, then press **FAV**. The sub-menu will appear as shown in the following figure.

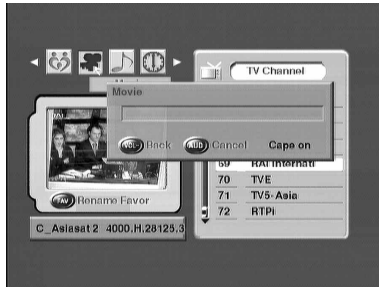

The operation to rename favorite channels is the same as "rename channel" (see page 19).

- Select your favorite channel by using **CH+/-**, and press **OK**. The channel will be marked with ♥. To cancel your selection, press **OK** again.
- Press **EXIT** to return to the previous menu.
- Exit all menus, then press **FAV** button to view the favorite channels list.

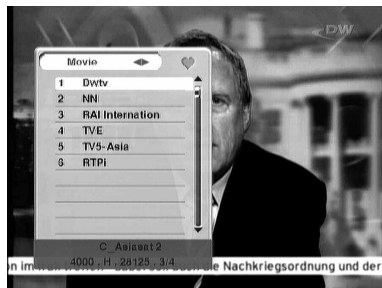
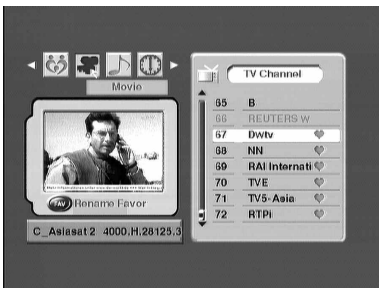

B. The operation for selecting the Music, News, Kids, Education, Sport and Entertainment channels is the same as for selecting Movie.

MAIN MENU

Sort By FTA

Select <Sort By FTA> by using **CH+/-**. Press **OK** to view the sub-menu as shown in the following figure.



All the FTA channels are listed first, then the scrambled channels.

Sort By Satellite

Select <Sort By Satellite> by using **CH+/-**. Press **OK** to view the sub-menu, similar to the one shown in <Sort By FTA> image above.

Sort the channels by satellite sequence.

Sort By Transponder

Select <Sort By Transponder> by using **CH+/-**. Press **OK** to view the sub-menu, similar to the one in <Sort By FTA> image above.

Sort the channels by transponder sequence.

Sort By Favorite

Select <Sort By Favorite> by using **CH+/-**. Press **OK** to view the sub-menu, similar to the one in <Sort By FTA> image above.

The Favorite Channels are listed first, then the non-favorite channels.

Sort By Alphabet

Select <Sort By Alphabet> by using **CH+/-**. Press **OK** to view the sub-menu, similar to the one in <Sort By FTA> image above.

Sort the channels from A(a) to Z(z).

4.2 Setting Radio Channels

Select <Radio channel> by using **CH+/-** in <Main Menu>. The result will be the sub-menu as shown in the following figure.



The operation for radio channels is the same as TV channels. To switch between TV and radio modes, press **TV/RADIO** on the remote control. Increase or decrease the volume by using **VOL+/-** either on the remote control or on the Receiver's front panel when watching TV or listening to the radio. When watching a channel, the video from the current channel is frozen as soon as **PAUSE** is pressed. Press **PAUSE** again to continue watching.

MAIN MENU

4.3 Installation Settings

Select <Installation> in <Main Menu> by using **CH+/-**, press **OK**, you will see the sub-menu as shown in the following figure. It has four items: Satellite Search, Transponder Search, Satellite Setting and Transponder Setting.



Satellite Search

Select <Satellite Search> by using **CH+/-**. Press **OK** to view the sub-menu as shown in the following figure.

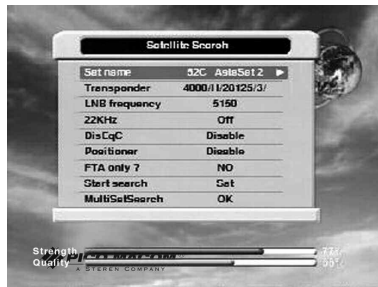

A. Sat name

Select <Sat name>, then press **VOL+**. Select satellite by using **CH+/-** or **PGUP/PGDW**. Press **OK** to confirm it.

B. Transponder

Select a valid transponder in the satellite to check the signal. Select <Transponder>, then press **VOL+**. Select transponder by using **CH+/-** or **PGUP/PGDW**. Press **OK** to confirm it.

C. LNB frequency

You can select the predefined LNB frequency by using **VOL+/-**. Manually enter a specific frequency in MHz unit by pressing **numeric** keys.

D. 22kHz

If you are using two antennas connected to a 22kHz tone switch box, you can either supply 22kHz by setting "ON" or select antenna by setting "OFF."
If the LNB frequency is set to universal, the 22kHz will operate automatically.

E. 0/12V

If you are using two antennas connected to an antenna switch box. you can either pick up 12V by setting "ON" or select antenna by setting "OFF."

F. DiSEqC

If the DiSEqC box is DiSEqC 1.0, the positioner should be set at Disable, then select antenna input LNB1-LNB4, Burst A or Burst B. If the DiSEqC box is DiSEqC1.2, the positioner should be set at Enable, then select Moto to set data.

G. Positioner

Disable: using DiSEqC 1.0

Enable: using DiSEqC 1.2

- Select <Positioner> by using **CH+/-**.
- Select <Enable> by using **VOL+/-**. Press **OK** to view the sub-menu as shown in the following figure.

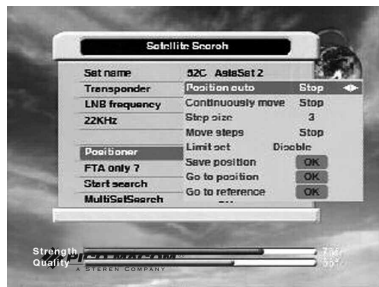

Positioner Settings

1. Position Auto

- Select <Position auto>. Then select the direction by using **VOL+/-**.
- During moving, press any key if you want to stop.
- When you find the signal, it will stop automatically.
- After finding the signal, use <Move steps> to find the best position.
- When you have the best position of the dish, select <Save position> to save.

MAIN MENU

2. Continuously Move

Select <Continuously Move>. Then select the direction by using **VOL+/-**.
By pressing **VOL+/-**, the dish will move. The motor stops after releasing **VOL+/-**.

3. Step Size

You can set the step size from 1 to 10 for move steps.

4. Move Steps

Select the direction by using **VOL+/-**.
The dish moves step by step.
Adjust the dish to the best position.

5. Limit Set

Select <Limit Set>. Then select direction limit by using **VOL+/-**. Press **OK**, then set the East Limit, West Limit or Disable the limit.

6. Save Position

Save the position of the satellite.

7. Go to Position

Press <OK> for the motor to return to the last position of the satellite.

8. Go to Reference

This provides a list of factory settings.

H. FTA Only

FTA Only <Yes> to search only free-to-air channels.
FTA Only <No> to search all channels.

I. Start Search

- a. Select <Start search> by using **CH+/-**.
- b. Select Sat/TP/Network by using **VOL+/-**.
 - Sat: Search satellite channels
 - TP: Search transponder channels
 - Network: Network search of the satellite
- c. Press **OK** to view the sub-menu as shown in the figure atop next page.



J. MultiSat Search

With DiSEqC1.0, you can scan up to four satellites that you have selected.

- Select <MultiSat search> by using **CH+/-**.
- Select satellites by using **VOL+** to view the sub-menu as shown in the following figure.

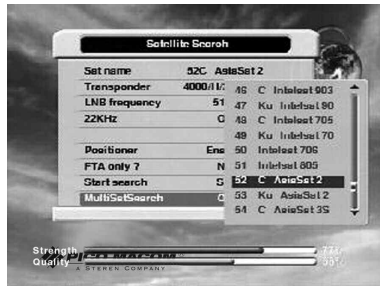

- Select satellites by using **CH+/-** or **PGUP/PGDW**. Press **OK** to view the sub-menu as shown in the following figure.



- Press **EXIT**, then press **OK** to search the channels of four satellites continuously.

MAIN MENU

Transponder Search

Check the transponder signal and search channels.

Select <Transponder Search> by using **CH+/-**. Press **OK** to view the sub-menu as shown in the following figure.

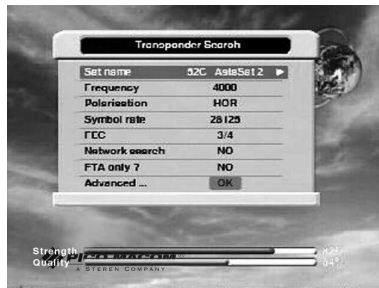

A. Sat name

To select <Sat name>, press **VOL+**. Select satellite by using **CH+/-** or **PGUP/PGDW**, then press **OK** to confirm it.

B. Frequency

Select a valid transponder in the satellite or input the frequency (0-20000 MHz).

C. Polarization

Select the polarization of transponder between HOR and VER by using **VOL+/-**.

D. Symbol rate

Press **numeric** keys to enter your required value manually.

E. FEC (Forward Error Correction)

Select the FEC of transponder by using **VOL+/-**. Available options are Auto, 1/2, 2/3, 3/4, 5/6 and 7/8.

F. Network search

Select <YES> for a network search of the transponder.

Select <NO> to search only the transponder channels.

G. FTA Only

Select FTA Only <Yes> to search only free-to-air channels.

Select FTA Only <No> to search all channels.

H. Advanced Search

Press **OK** to enter the advanced search menu. Input the Video PID, Audio PID and PCR PID to add a channel.

D. Move

The Move command allows you to place a satellite in a different position on the satellite list. After selecting this command, a small input box will appear on the screen. Input a number between 1 and the total number of the existing satellites by using **numeric** keys on the remote control. After pressing **OK**, the selected satellite will be moved to the new location specified by your input.

- Select <Move> by using **VOL+/-**.
- Select a satellite you want by using **CH+/-** or **PGUP/PGDW**.
- Press **OK** to view the sub-menu as shown in the following figure.



To move the satellite to a new position, press the **numeric** keys, then press **OK** to confirm it.

MAIN MENU

Transponder Setting

Select <Transponder Setting> by using **CH+/-**. Press **OK** to view the sub-menu as shown in the following figure.

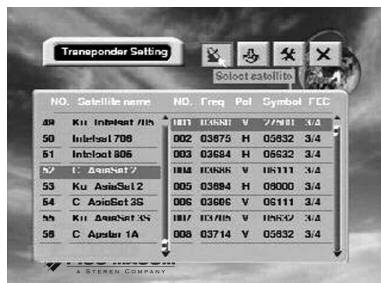

A. Select satellite

- Select "Select satellite" icon by using **VOL+/-**.
- Select a satellite you want by using **CH+/-** or **PGUP/PGDW**.
- Press **EXIT** to return to the previous menu.

B. Add Transponder

This command allows you to add one or more transponders for the selected satellite.

- Select a satellite for which you want to add a transponder by using **CH+/-** or **PGUP/PGDW**.
- Select "Add Transponder" icon by using **VOL+/-**.
- Press **OK** to view the sub-menu as shown in the following figure.



C. Edit Transponder

The Edit command lets you change the parameters of a transponder. Select the transponder item you want to edit from the list on the right side of the screen.

- Select "Edit Transponder" icon by using **VOL+/-**.
- Select a transponder you want to edit by using **CH+/-**.
- Press **OK** to view the sub-menu as shown in the following figure.



- Change the parameters, then press **OK**.

D. Delete Transponder

This command allows you to delete an existing transponder of the selected satellite.

- Select "Delete Transponder" icon by using **VOL+/-**.
- Select a transponder you want to delete by using **CH+/-**.
- Press **OK** to view the sub-menu as shown in the following figure.

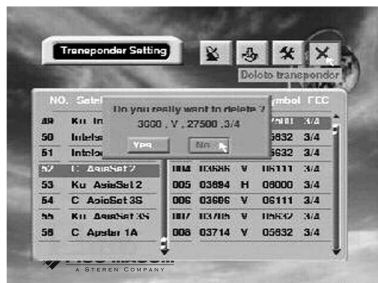

Select <Yes> by using **VOL+/-**, then press **OK** to delete the transponder, or else cancel the operation.

MAIN MENU

4.4 System Settings

Select <System> in <Main Menu> by using **CH+/-**. Press **OK** to view the sub-menu as shown in the following figure. It has six items: System, OSD (On-Screen Display), Time Adjust, Reset All, Reset Channels and About DVB.



System

Select <System> by using **CH+/-**. Press **OK** to view the sub-menu as shown in the following figure.



A. Menu Language

System supports English, German, Polish, Farsi and Arabic. Press **VOL+/-** to select the desired language for menu.

B. Audio Language

Select the first language to listen if this language is supported by the current program. The language depends on the transmission of the audio signal.

C. RF Channel

If your TV is connected through an RF modulator (UHF), select the output channel number you want.

D. RF System

The RF system is set at NTSC M.

E. TV System

Select your TV type between PAL, NTSC and SECAM by using **VOL+/-**.

F. TV Screen Format

Select your TV aspect ratio of output video either 4:3 or 16:9 by using **VOL+/-**.

On-Screen Display (OSD)

Select <OSD> in <System> by using **CH+/-**. Press **OK** to view the sub-menu as shown in the following figure.

**A. Menu Color**

Select your favorite color of the menu by using **VOL+/-**.

B. Transparency

You can adjust the transparency of the menu from 1 to 10 by using **VOL+/-**.

MAIN MENU

Time Adjust

Select <Time Adjust> in <System> by using **CH+/-**. Press **OK** to view the sub-menu as shown in the following figure.



A. Set Turn On, Turn Off and Turn Channel ON or OFF by using **CH+/-** or **VOL+/-**.

Note: "Time Display": Set On and the current time will appear on the left top of the screen.

B. Set Current Time, Turn On Time, Turn Off Time and Turn Channel Time by using **CH+/-**, **VOL+/-** and **numeric** keys. Press **OK** to return to the previous menu.

Reset All

Select <Reset All> in <System> by using **CH+/-**. Press **OK** to view the sub-menu as shown in the following figure.



Select <Yes> by using **VOL+/-**. Press **OK**, and all data and settings will be reset to factory default.

Reset Channels

Select <Reset Channels>. Press **OK** to view the sub-menu as shown in the following figure.



Select <Yes> by using **VOL+/-**. Press **OK**, and all revised channel data and settings will be lost.

About DVB

To check the information of your Receiver's hardware and software, select <About DVB> in the <System Menu> by using **CH+/-**. View the sub-menu as shown in the following figure.



Press **EXIT** to return to the previous menu.

MAIN MENU

4.5 Parental Control Settings

Select <Parental Control> in the <Main Menu> by using **CH+/-**. Press **OK**, and you will be asked to enter your password. Input your password to view the sub-menu as shown in the following figure.



Note: Default password is 0000. If you forget the password you changed to, please check with your dealer.

- Password Lock: Select <YES> by using **VOL+/-**.
- Edit Channel Lock: Select <YES> by using **VOL+/-**.
- Installation Lock: Select <YES> by using **VOL+/-**.
- System Lock: Select <YES> by using **VOL+/-**.
Press **OK** to confirm.

Note: When you have created a password for Edit Channel, Installation and System in the Main Menu, you must input the password.

- Change Password: Select <YES> by using **VOL+/-**.
 - a. Input new password, and input again to confirm.
 - b. Press **EXIT** to return to the previous menu.

4.6 Game Selections and Settings

Select <Game> in the <Main Menu> by using **CH+/-**. Press **OK** to view the sub-menu as shown in the following figure. It has 2 games: Tetris and Snake.



Tetris

Select <Tetris> in <Game> by using **CH+/-**. Press **OK** to view the sub-menu as shown in the following figure.

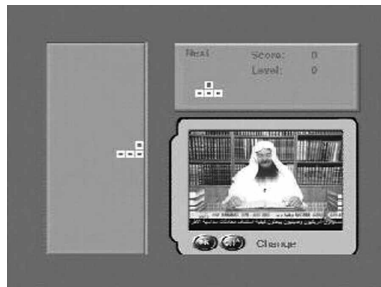

Press **OK** or **CH+** to change the direction of diamonds. Press **EXIT** to return to the previous menu.

Snake

Select <Snake> in <Game> by using **CH+/-**. Press **OK** to view the sub-menu as shown in the figure atop the next page.

MAIN MENU

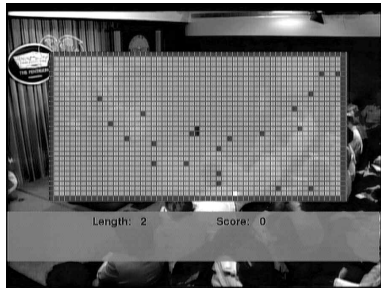

Press **VOL+/-** and **CH+/-** to make the snake move up, down, left and right. If the snake moves through a yellow icon, it adds length. If it moves through a blue icon, the game is over. Press **EXIT** to return to the previous menu.

5 General View Functions

The following section describes the basic functions of your Receiver that can be accessed while watching satellite TV or listening to the radio.

5.1 Volume

To increase or decrease the volume, use **VOL+/-** either on the remote control or on the front panel when watching TV or listening to the radio.

5.2 Pause

When watching a channel, the video from the current channel is frozen as soon as **PAUSE** is pressed. Press **PAUSE** again to resume watching.

5.3 EPG

The Receiver provides Electronic Program Guide functions for you to get access to the TV Guide Channel, which shows information on current and future programs.

To view the EPG data, press **EPG** on your remote control while watching a channel. The **Program Guide** window will be displayed. You can see the channel list on the left side and the program schedule next to the channel name. The time related to the program schedule is also displayed, as shown in the figure atop the next page.

GENERAL VIEW FUNCTION



5.4 TV/Radio

While watching the channel, switch between TV and radio modes by using **TV/RADIO** on the remote control.

5.5 SAT

If you searched channels from more than one satellite and want to have a channel list for each satellite, press **SAT** key several times. The channel list of each satellite will be displayed.



5.6 Audio

If a program is broadcast in more than one language, the desired language can be selected directly by using **AUDIO** on the remote control. The <AUDIO Setting> menu lets you select the appropriate audio language and audio mode. **VOL+/-** can also be used to switch among the options.

Note: This setting depends on the transmission of the audio signal.

GENERAL VIEW FUNCTION

5.7 Info

While watching the channel, press **INFO** on the remote control. The channel name appears along with the satellite name. Two dynamic bars reflecting signal strength and signal quality of the current channel also appear.

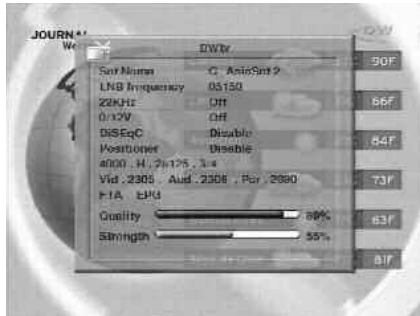

UPDATE SOFTWARE

Updating Software (Receiver to Receiver)

Note: These instructions apply to primary and secondary receivers with SCART ports. If you need assistance in identifying your specific equipment configuration, contact your authorized dealer.

- a. Connect primary and second receivers with RS232C cable.
- b. Power on the primary Receiver so it remains in standby mode.
- c. After starting successfully, turn on second Receiver to begin update.
- d. The display panel of the primary Receiver will blink the letter "H."
- e. Input the password "123" by remote control to update the software.
- f. After the update, "-End" and "OK" will display on each panel.
- g. Turn off the second Receiver, disconnect the RS232C cable and restart.

Note: Input the password "123" to update the software.
Input the password "456" to update the data.
Input the password "789" to update the software and data.
Input the password "369" to copy the whole flash.

Updating Software (Computer to Receiver)

- a. Connect your PC and Receiver with RS232C cable.
- b. Turn on the Receiver so it remains in standby mode.
- c. Startup the software of "STB5518.exe" on your PC, press "Select" key, select "*.bin" then select port. Press "start" on your PC. Upgrade will begin.
- d. After upgrade, "-End" will display on the Receiver panel.
- e. Turn off the Receiver, disconnect RS232C Cable and restart.

Note: You need a 9-pin twisted RS-232C cable (pin-2 to pin-3, pin-3 to pin-2, pin-5 to pin-5). You cannot turn off the secondary Receiver until it displays "-End" and "OK" on the panel.

Note: Due to a new modification of flash to 16M, you need to press the **POWER** button to put Receiver in standby mode before you update the software from computer or Receiver (primary Receiver only).

TROUBLESHOOTING

PROBLEM	POSSIBLE CAUSE	WHAT TO DO
The display on the front panel does not light up.	Main cable is not connected.	Check that the main cable is plugged into the power socket.
No sound or picture. But the front panel red light is on.	The unit is in stand-by mode.	Press the standby button.
No sound or picture	The satellite dish is not pointing at the satellite.	Adjust the dish. Check the signal level on the antenna setup menu.
	No signal or weak signal.	Check the cable connections, LNB and other equipment connected between the LNB and the Receiver, and/or adjust the dish.
Bad picture/ blocking error.	The satellite dish is not pointing at the satellite.	Adjust the dish.
	Signal is too strong.	Connect a signal attenuator to the LNB input.
	Satellite dish is too small.	Check that the main cable is plugged into the power socket.
	LNB noise factor too high.	Change to an LNB with a lower noise factor.
	The LNB is faulty.	Change the LNB.
No picture appears on the TV screen.	The system is connected by SCART leads or RCA leads, and TV is not in AV/EXIT mode.	If the system is connected by SCART leads or RCA leads, switch the TV to the appropriate AV input.

TROUBLESHOOTING

PROBLEM	POSSIBLE CAUSE	WHAT TO DO
No picture appears on the TV screen.	The system is connected using RF leads.	Check the UHF channel in your system and tune the UHF channel properly.
There is interference on your digital satellite channels.	The system is connected using RF leads and the output channel of the Receiver interferes with an existing terrestrial channel or video signal.	Change the Receiver output channel to a more suitable channel, or connect the system using SCART leads.
The remote control is not working.	Batteries exhausted.	Change the batteries.
	Remote control is incorrectly aimed.	Aim the remote control at the Receiver or check that nothing blocks the front panel.

GLOSSARY

Access

Authorization to use the coding system to purchase/order TV programs.

AGC

Automatic Gain Control. A circuit that automatically adjusts signal levels.

Audio system

With digital satellite reception, the sound is transmitted in packages and is selected either in a special audio mode or pre-selected by using the installation setup. This makes it possible to select between several different languages in a film. The number of choices is dependent on what is available in the signal.

DVB

The Digital Video Broadcast group was created to establish a technical framework for the introduction of digital video broadcasting systems.

EPG

Electronic Program Guide. Software that enables viewers to navigate easily among the large number of channels provided by digital technology, in order to select the service they desire.

FEC

Forward Error Correction. Correction of faulty bits in the received signal.

GHz

The prefix giga means billion, and Hertz means cycles per second. Signals in the GHz range are often called microwaves.

LNB (low-noise block converter) or LNBF

An electronic unit mounted on the satellite dish. It receives the signals reflected by the dish and converts them to signals that can be used by the Receiver.

L.O.

Local oscillator part of the LNB. It converts from the satellite frequency down to a frequency acceptable for the Receiver.

MHz

The prefix mega means million, and Hertz means cycles per second.

MPEG

Moving Picture Experts Group. Body established by the International Standards Organization to provide the basis for a picture coding and compression system.

Network

A number of digital channels transmitted from one source. Grouped under separate headings in the channel list.

Parental control

A feature that allows parents to "lock" programs that they consider unsuitable for children. A "locked" channel or program can only be "unlocked" with the special parental access code.

PCR

Program Clock Reference. Timing information corresponding to a particular satellite channel on a digital frequency. The PCR must be entered when adding new channels.

Polarization

Polarization allows several programs to be fit into the same frequency band. The signals from a satellite are transmitted either with linear (vertical or horizontal) polarization or circular (right or left) polarization.

RF

Radio frequency (known as HF in some countries).

RS232

A serial communications standard data port.

Satellite dish

A dish-shaped antenna (reflector) to receive signals from a satellite. The dish focuses the signals into the LNB.

SCART

A 21-pin connector used for connection of the Receiver, VCR and TV. Also named Euroconnector or Peritel connector.

Scrambled satellite TV program

Some satellite TV programs are transmitted in scrambled form. A Smartcard, and possibly a conditional access (CA) module, will be needed to view such programs.

Service provider

Company that packages a number of programs and/or services and distributes them to customers.

SNR

Signal-to-noise ratio. A measure of signal quality.

Symbol rate

Size of the digital package transmission.

SW

Software. Instructions that enable an electronic device (such as a computer or satellite receiver) to operate and perform certain functions or applications.

TP

Transponder. A component of a satellite that receives uplinked signals (such as programming channels) from Earth-based transmitter dishes and downlinks them to other Earth-based satellite receive dishes.

VCR

Video Cassette Recorder.

TECHNICAL SPECIFICATIONS

Note: The specifications for your Receiver may differ from those described below, depending on where you purchased your Receiver. If you need assistance in identifying your specific equipment specifications, contact your authorized dealer.

VIDEO

Decoding	MPEG-2 & MPEG-1 compatible
Bit rate	Max 15Mbps
Output	PAL/NTSC/SECAM
Aspect ratio	4:3, 16:9
Active pixel	720x480 @ 30fps; 720x576 @ 25fps
Output connector	RCA, TV SCART, VCR SCART, S-Video

AUDIO

Decoding	MPEG-2/MPEG-1 layer I & II
Mode	Mono, Dual, Stereo, Joint stereo
Bit rate	Max 384kbps
Output connector	RCA, SCART, S/PDIF (Coaxial, Optical)

DEMODULATOR

Demodulation	QSPK
Symbol rate	SCPC/MCPC
Outer code	RS (204, 188, 8)
Inner code	All DVB rates
Energy dispersion	DVB-S recommendation

INPUT SIGNAL

Frequency	950MHz-2150MHz
Input level	-65dBm to -25dBm
Channel bandwidth	36MHz
Input socket	F-type connector

RF MODULATOR

Input	IEC 169-24 Male x 1
Output	IEC 169-24 Female x 1
Band	UHF
TV Standard	PAL BG/I/DK, NTSC M
Output Channel	21-69 (PAL), 14-83 (NTSC)

TECHNICAL SPECIFICATIONS

LNB CONTROL

Power supply	13/18V (500mA max) polarization with short circuit protection
Polarized control	13/18V polarization (vertical/horizontal)
DiSEqC control	DiSEqC 1.0 and DiSEqC 1.2

MISCELLANEOUS

Supply voltage	100-240VAC 50-60Hz
Power consumption	30 watts max
Operating temperature	+5°C to +40°C
Storage temperature	-20°C to +70°C
Dimensions (WxDxH)	290 x 190 x 40.5mm
Weight	2.1kg

MENU STRUCTURE

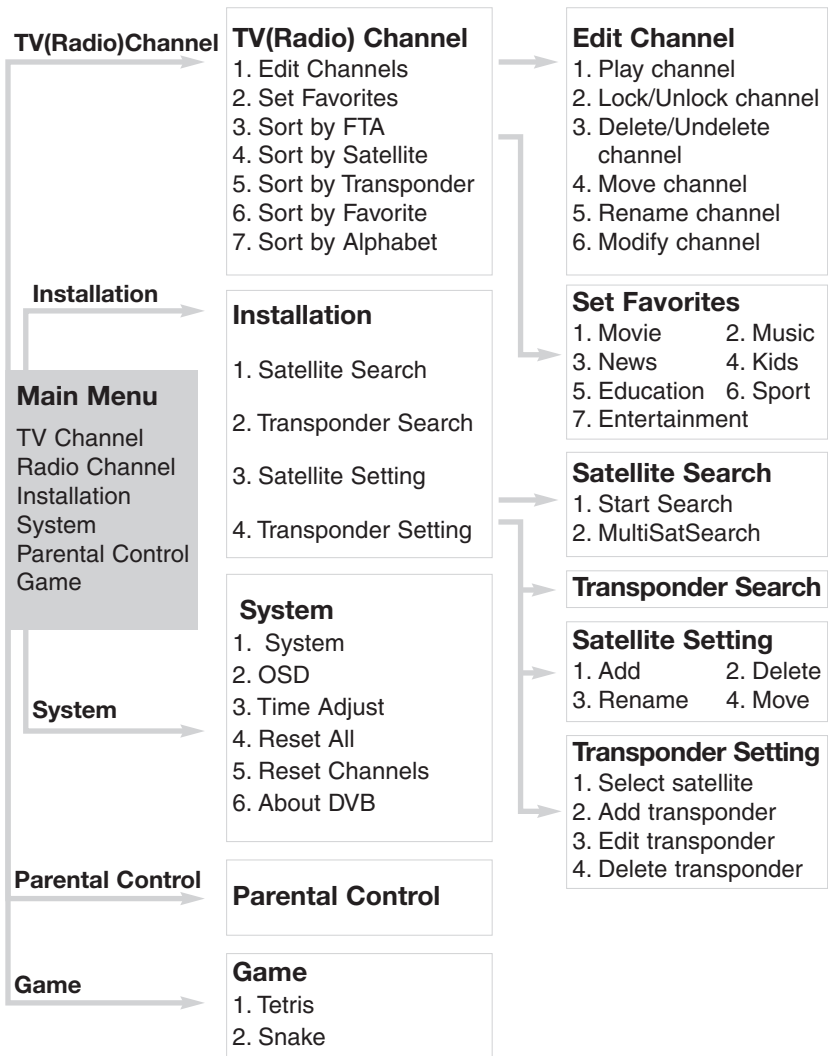



355 Parkside Drive
San Fernando, California 91340

Sales: 800-421-6511 Phone: 818-493-4300 Fax: 818-493-4433
www.**picomacom**.com sales@picomacom.com
Download from [Www.Somanuals.com](http://www.Somanuals.com). All Manuals Search And Download.

Free Manuals Download Website

<http://myh66.com>

<http://usermanuals.us>

<http://www.somanuals.com>

<http://www.4manuals.cc>

<http://www.manual-lib.com>

<http://www.404manual.com>

<http://www.luxmanual.com>

<http://aubethermostatmanual.com>

Golf course search by state

<http://golfingnear.com>

Email search by domain

<http://emailbydomain.com>

Auto manuals search

<http://auto.somanuals.com>

TV manuals search

<http://tv.somanuals.com>