

# Operation Manual

## CDS-P4000

Pioneer



### Dear Customer:

Selecting fine audio equipment such as the unit you've just purchased is only the start of your musical enjoyment. Now it's time to consider how you can maximize the fun and excitement your equipment offers. This manufacturer and the Electronic Industries Association's Consumer Electronics Group want you to get the most out of your equipment by playing it at a safe level. One that lets the sound come through loud and clear without annoying blaring or distortion – and, most importantly, without affecting your sensitive hearing.

Sound can be deceiving. Over time your hearing "comfort level" adapts to higher volumes of sound. So what sounds "normal" can actually be loud and harmful to your hearing. Guard against this by setting your equipment at a safe level BEFORE your hearing adapts.

#### To establish a safe level:

- Start your volume control at a low setting.
- Slowly increase the sound until you can hear it comfortably and clearly, and without distortion.

#### Once you have established a comfortable sound level:

- Set the dial and leave it there.

Taking a minute to do this now will help to prevent hearing damage or loss in the future. After all, we want you listening for a lifetime.

### We Want You Listening For A Lifetime

Used wisely, your new sound equipment will provide a lifetime of fun and enjoyment. Since hearing damage from loud noise is often undetectable until it is too late, this manufacturer and the Electronic Industries Association's Consumer Electronics Group recommend you avoid prolonged exposure to excessive noise. This list of sound levels is included for your protection.

#### Decibel

Level	Example
30	Quiet library, soft whispers.
40	Living room, refrigerator, bedroom away from traffic.
50	Light traffic, normal conversation, quiet office.
60	Air conditioner at 20 feet, sewing machine.
70	Vacuum cleaner, hair dryer, noisy restaurant.
80	Average city traffic, garbage disposals, alarm clock at two feet.

### THE FOLLOWING NOISES CAN BE DANGEROUS UNDER CONSTANT EXPOSURE

90	Subway, motorcycle, truck traffic, lawn mower.
100	Garbage truck, chain saw, pneumatic drill.
120	Rock band concert in front of speakers, thunderclap.
140	Gunshot blast, jet plane.
180	Rocket launching pad.

Information courtesy of the Deafness Research Foundation.



Printed in Japan  
Imprimé au Japon

Download from [www.Somanuals.com](http://www.Somanuals.com). All Manuals Search And Download.

**PIONEER CORPORATION**  
4-1, MEGURO 1-CHOME, MEGURO-KU, TOKYO 153-8654, JAPAN

**PIONEER ELECTRONICS (USA) INC.**  
P.O. Box 1760, Long Beach, California 90801, U.S.A.  
TEL: (800) 421-1404

**PIONEER EUROPE NV**  
Haven 1087. Keetberglaan 1, B-9120 Melsele, Belgium  
TEL: (0) 3/570.05.11

**PIONEER ELECTRONICS AUSTRALIA PTY. LTD.**  
178-184 Boundary Road, Braeside, Victoria 3195, Australia  
TEL: (03) 9586-6300

**PIONEER ELECTRONICS OF CANADA, INC.**  
300 Allstate Parkway, Markham, Ontario L3R OP2, Canada  
TEL: (905) 479-4411

**PIONEER ELECTRONICS DE MEXICO, S.A. de C.V.**  
San Lorenzo 1009 3er. Piso Desp. 302  
Col. Del Valle Mexico, D.F. C.P. 03100  
TEL: 5-688-52-90

Published by Pioneer Corporation.  
Copyright © 2001 by Pioneer Corporation.  
All rights reserved.

Publication de Pioneer Corporation.  
Copyright © 2001 Pioneer Corporation.  
Tous droits de reproduction et de traduction réservés.

<KSNZF/01A00000>

### Key Finder

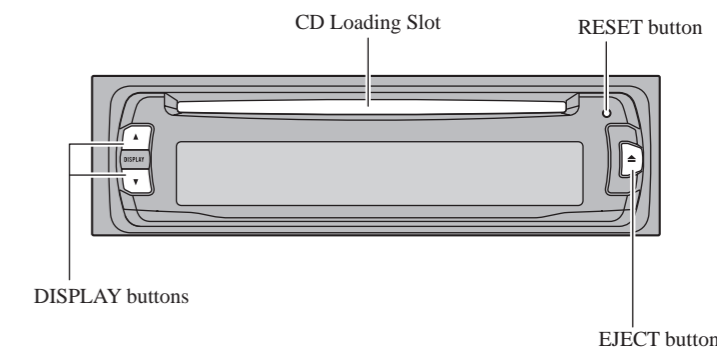

### Specifications

#### General

Power source	14.4 V DC (10.8 – 15.1 V allowable)
Grounding system	Negative type
Max. current consumption	1 A
Dimensions	
(DIN) (mounting size)	178 (W) × 50 (H) × 153 (D) mm [7 (W) × 2 (H) × 6 (D) in.]
(nose)	188 (W) × 58 (H) × 20 (D) mm [7-3/8 (W) × 2-1/4 (H) × 3/4 (D) in.]
(D) (mounting size)	178 (W) × 50 (H) × 153 (D) mm [7 (W) × 2 (H) × 6 (D) in.]
(nose)	170 (W) × 46 (H) × 15 (D) mm [6-3/4 (W) × 1-3/4 (H) × 5/8 (D) in.]
Weight	1.2 kg (2.7 lbs.)

#### CD player

System	Compact disc audio system
Usable discs	Compact disc
Signal format	Sampling frequency: 44.1 kHz Number of quantization bits: 16; linear
Frequency characteristics	5 – 20,000 Hz (±1 dB)
Signal-to-noise ratio	94 dB (1 kHz) (IHF-A network)
Dynamic range	92 dB (1 kHz)
Number of channels	2 (stereo)

#### Note:

- Specifications and the design are subject to possible modification without notice due to improvements.

## Before Using This Product

### About This Manual

Operate this CD Player with a Head Unit connected. For details concerning operation, refer to the back page of this manual.

### Important

The serial number of this device is located on the bottom of this product. For your own security and convenience, be sure to record this number on the enclosed warranty card.

### Resetting the Microprocessor

The microprocessor must be reset under the following conditions:  
When using this product for the first time after installation.  
When the machine fails to operate properly.  
When strange (incorrect) messages appear on the display.

- To reset the microprocessor, press the **RESET** button with a pen tip or other pointed instrument.

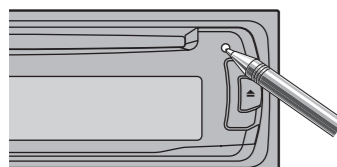

### Precaution

**CAUTION: USE OF CONTROL OR ADJUSTMENT OR PERFORMANCE OF PROCEDURES OTHER THAN THOSE SPECIFIED HEREIN MAY RESULT IN HAZARDOUS RADIATION EXPOSURE.**

**CAUTION: THE USE OF OPTICAL INSTRUMENTS WITH THIS PRODUCT WILL INCREASE EYE HAZARD.**

- Keep this manual handy as a reference for operating procedures and precautions.
- Protect the product from moisture.

### After-sales Service for Pioneer Products

Please contact the dealer or distributor from where you purchased the product for its after-sales service (including warranty conditions) or any other information. In case the necessary information is not available, please contact the companies listed below:

Please do not ship your product to the companies at the addresses listed below for repair without advance contact.

#### ■ U.S.A.

Pioneer Electronics Service, Inc.  
CUSTOMER SERVICE  
DEPARTMENT  
P.O. Box 1760  
Long Beach, CA 90801  
800-421-1404

#### ■ CANADA

Pioneer Electronics of Canada, Inc.  
CUSTOMER SATISFACTION  
DEPARTMENT  
300 Allstate Parkway  
Markham, Ontario L3R 0P2  
(905) 479-4411  
1-877-283-5901

For warranty information please see the Limited Warranty sheet included with your product.

## Using the CD Player

### Playing the CD Player

The CD player plays one standard 12 cm or 8 cm CD at a time. Do not use any adapter when playing a 8 cm CD.

1. Insert the disc with the label side up.

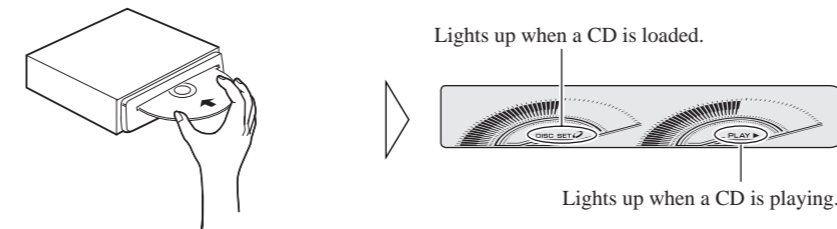

2. For details concerning operation, refer to the back page of this manual.

3. Remove the disc.



#### Note:

- A disc left partially inserted after ejection may incur damage or fall out.
- If a disc cannot be inserted fully or playback fails, make sure the recorded side is down. Press the EJECT button and check the disc for damage before reinserting it.
- If a CD is inserted with the recorded side up, it will be ejected automatically after a few moments.
- If the CD player cannot operate properly, an error message (such as "ERROR-14") appears on the head unit display. Refer to "CD Player Troubleshooting".
- Do not insert anything other than a CD into the CD Loading Slot.

## Display Modes

### Level Indicator Display

This product has eight display patterns (Mode 1 to Mode 8) from which you can choose one at a time.

- Selecting the Level Indicator display.

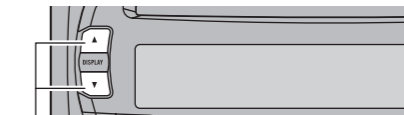

Each press changes the Display ...

Each press of the DISPLAY button changes the display in the following order:

Mode 1 ↔ Mode 2 ↔ Mode 3 ↔ Mode 4 ↔ Mode 5  
↔ Mode 6 ↔ Mode 7 ↔ Mode 8 ↔ Mode 1 ...

**Mode 1, Mode 2, Mode 3 and Mode 4**  
Segments light from left to right according to the audio level.

Example: Mode 1



**Mode 5**  
Segments light from the center, and expand towards the sides according to the audio level.

Example: Mode 5

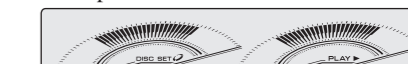

**Mode 6**  
Display shows segments rotating from left to right.

Example: Mode 6



**Mode 7**  
Depending on the audio level, different segments light up.

Example: Mode 7

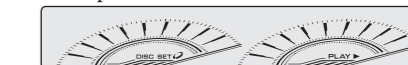

**Mode 8**  
Display turns off except for the "DISC SET" and "PLAY" indications.

Example: Mode 8



## Operating with Different Head Units

This CD Player can be operated only with a separately sold Head Unit. Instructions in this Operation Manual use a “KEH-P6010” Head Unit as an example.

### Head Unit-Group 1

This group of Head Units features a FUNCTION button you can use to call up a Function Menu to operate functions. Operation using this group of Head Units is the same as with the “KEH-P6010”, operate following the instructions in this manual.

#### Examples of Group 1 Head Units

KEH-P601      KEH-P690      KEH-P5900

### Head Unit-Group 2

This group of Head Units does not feature a FUNCTION button. However, the units allow different direct operation of functions with dedicated buttons such as a RPT button. When using the CD Player with this group of Head Units, refer to the Function Compatibility Chart for Head Unit Group 2.

#### Examples of Group 2 Head Units

KEH-P4010      KEH-P490      KEH-P4900      KEH-P1010\*

\* This Unit does not feature the “Random Play” and “Scan Play” functions.

#### Note:

- The Operation Manual for an individual Head Unit may feature different instructions for operating a CD Player. In such case, refer to those instructions.

## Function Compatibility Charts

Each function operation described can be executed by pressing the corresponding buttons on the Head Unit or the remote controller.

### Head Unit Group 2

Function name	Button	Operation
Source Switching	SOURCE, SOURCE/OFF	:Select
Repeat Play	RPT LOCAL/BSM LOCAL/BSM (Hold for 2 seconds)	:Select
Random Play	RPT (Hold for 2 seconds) LOCAL/BSM (Hold for 2 seconds)	:Select
Scan Play	PAUSE/BSM (Hold for 2 seconds) PAUSE/SCAN (Hold for 2 seconds)	:Select
Pause	PAUSE/BSM PAUSE/SCAN LOCAL/BSM	:Select
Track Search	◀ or ▶ (Hold for 0.5 seconds or less)	:Select
Fast Forward/Reverse	◀ or ▶ (Continue pressing)	:Select

## Key Finder

Operate CD Player functions with the buttons shown below.

### Head Unit (e.g. KEH-P6010)

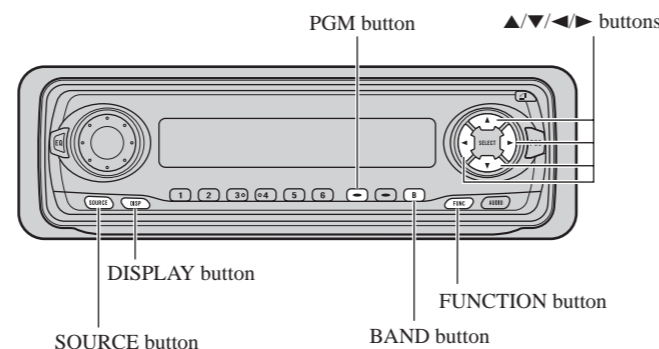

#### Note:

- For details concerning operation using the Remote Controller, refer to the Operation Manual of the Head Unit.

## Basic Operation of CD Player

### Selecting the CD Player Source

- Press the SOURCE button repeatedly until the CD Player is selected.

The CD Player starts playing.

### Track Search and Fast Forward/Reverse

- You can select between Track Search or Fast Forward/Reverse by pressing the ◀/▶ button for a different length of time.

Track Search	0.5 seconds or less
Fast Forward/Reverse	Continue pressing

#### Note:

- If the CD player cannot operate properly, an error message such as “ERROR-14” is displayed. Refer to “CD Player Troubleshooting”.

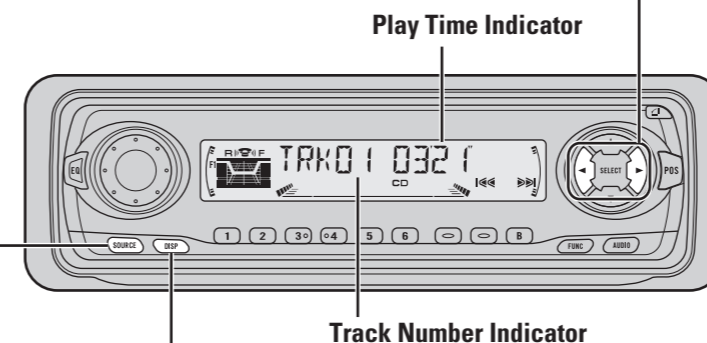

### Displaying Disc Titles

- Press the DISPLAY button to change the Disc Title display of the current disc.

#### Note:

- This function is available only when the Head Unit is connected to a Multi-CD player.
- If you switch displays when no disc titles have been input, “NO TITLE” is displayed.
- Repeat the preceding operation to return to the normal display.

## Entering the Function Menu

The Function Menu lets you operate simple functions for the CD player.

#### Note:

- After entering the Function Menu, if you do not perform an operation within about 30 seconds, the Function Menu is automatically canceled.

- Select the desired mode in the Function Menu. (Refer to “Function Menu functions”.)

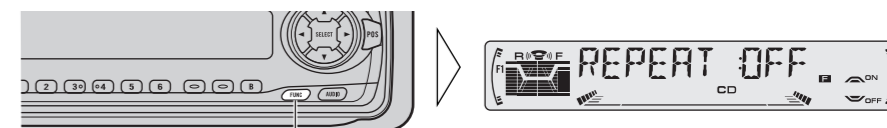

Each press changes the Mode ...

- Operate a mode. (e.g. Repeat Play)

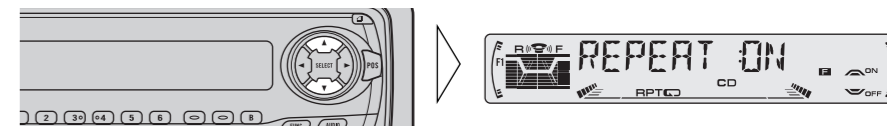

The button used and the operation it performs are indicated by the key guidance indicator. Press the ▲ button to switch the key guidance indicator ON, and the ▼ button to switch it OFF.

- Cancel the Function Menu.

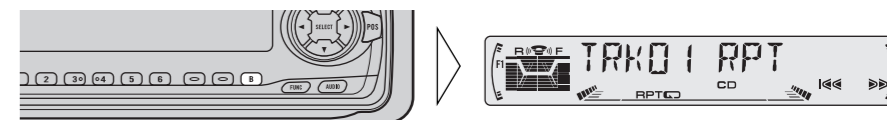

## Using the CD Player

### Function Menu Functions

The following chart shows functions in the CD Player Function Menu. This chart shows the function operation and button for each function.

#### ■ CD Player

Function name (Display)	Button	Operation
Repeat Play (REPEAT)	▲ ▼	:ON :OFF
Random Play (RANDOM)	▲ ▼	:ON :OFF
Scan Play (T-SCAN)	▲ ▼	:ON :OFF
Pause (PAUSE)	▲ ▼	:ON :OFF

#### Note:

- With some Head Units, the Function Menu may feature a CD Sound Quality Adjustment (COMP) function. When you combine this CD player with such a Head Unit, if "NO COMP" is displayed, it indicates that the CD Sound Quality Adjustment function is not available.

### Repeat Play (REPEAT)

Repeat Play plays the same track repeatedly.

- Press the **FUNCTION** button and select the Repeat mode (REPEAT) in the Function Menu.
- Switch the Repeat Play ON/OFF with the ▲/▼ buttons.



#### Note:

- If you perform Track Search or Fast Forward/Reverse, Repeat Play is automatically canceled.

### Random Play (RANDOM)

Random Play plays the tracks on a CD in random order for variety.

- Press the **FUNCTION** button and select the Random mode (RANDOM) in the Function Menu.
- Switch the Random Play ON/OFF with the ▲/▼ buttons.



### Scan Play (T-SCAN)

Scan Play plays the first 10 seconds or so of each track on a CD in succession.

- Press the **FUNCTION** button and select the Scan mode (T-SCAN) in the Function Menu.
- Switch the Scan Play ON with the ▲ button.
- When you find the desired track, cancel the Scan Play by pressing the ▼ button.

If the Function Menu has been canceled automatically, select the Scan mode in the Function Menu again.

#### Note:

- Scan Play is canceled automatically after all the tracks on a disc have been scanned.

### Pause (PAUSE)

Pause pauses the currently playing track.

- Press the **FUNCTION** button and select the Pause mode (PAUSE) in the Function Menu.
- Switch the Pause ON/OFF with the ▲/▼ buttons.

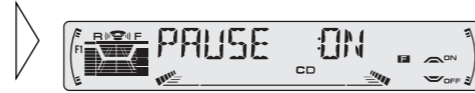

#### Note:

- You can also switch the Pause function ON/OFF by pressing the PGM button.

### Disc Title Input (TITLE IN)

The CD player's Disc Title Input function is possible for up to 100 discs when a Multi-CD player is installed.

The connected Head Unit's Operation Manual features details concerning operation. Refer to "Disc Title Input" in the manual's "Using Multi-CD Players" section.

## CD Player and Care

### Precaution

- Play only CDs bearing the Compact Disc Digital Audio mark.



- This product is designed for use with conventional, fully circular CDs only. Use of shaped CDs are not recommended for this product.



- Check all CDs before playing and discard cracked, scratched or warped discs.
- Normal playback of CD-R discs other than those recorded with a music CD recorder may not be possible.
- Playback of music CD-R discs, even those recorded with a music CD recorder, may not be possible with this product due to disc characteristics or scratches or dirt on the disc. Dirt or condensation on the lens inside this product may also prevent playback.
- This product conforms to the track skip function of the CD-R disc. The tracks containing the track skip information are skipped over automatically.
- Read the precautions with the CD-R discs before using.

- Wipe dirty or damp discs outward from the center with a soft cloth.



- Avoid touching the recorded (iridescent) surface when handling discs.
- Store discs in their cases when not in use.
- Keep discs out of direct sunlight and high temperatures.
- Do not affix labels or apply chemicals to discs.
- Condensation may collect inside the player when using the heater in cold weather, interfering with playback. Turn it off for an hour or so and wipe damp discs with a soft cloth.
- Road shocks may interrupt CD playback.

## CD Player Troubleshooting

### Error Message

When problems occur with CD playback, an error message appears on the head unit display. Refer to the table below to identify the problem, then take the suggested corrective action. If the error persists, contact your dealer or your nearest PIONEER Service Center.

Message	Possible cause	Recommended action
ERROR- 11, 12, 17, 30	Dirty disc.	Clean the disc.
ERROR- 11, 12, 17, 30	Scratched disc.	Replace the disc.
ERROR- 14	Unrecorded CD.	Check the disc.
ERROR- 10, 11, 12, 14, 17, 30, A0	Electrical or mechanical problem.	Turn the ignition ON and OFF, or switch to a different source, then back to the CD player.
ERROR- 44	All tracks are setting track skip.	Replace the disc.
HEAT	CD player overheating.	Discontinue play until the machine temperature drops.

## Free Manuals Download Website

<http://myh66.com>

<http://usermanuals.us>

<http://www.somanuals.com>

<http://www.4manuals.cc>

<http://www.manual-lib.com>

<http://www.404manual.com>

<http://www.luxmanual.com>

<http://aubethermostatmanual.com>

Golf course search by state

<http://golfingnear.com>

Email search by domain

<http://emailbydomain.com>

Auto manuals search

<http://auto.somanuals.com>

TV manuals search

<http://tv.somanuals.com>