

***Pioneer***

**COMPACT DISC RECORDER**

**PDR-609**

**Operating Instructions**



# IMPORTANT



The lightning flash with arrowhead symbol, within an equilateral triangle, is intended to alert the user to the presence of uninsulated "dangerous voltage" within the product's enclosure that may be of sufficient magnitude to constitute a risk of electric shock to persons.

## CAUTION

RISK OF ELECTRIC SHOCK  
DO NOT OPEN



CAUTION:  
TO PREVENT THE RISK OF ELECTRIC SHOCK, DO NOT REMOVE COVER (OR BACK). NO USER-SERVICEABLE PARTS INSIDE. REFER SERVICING TO QUALIFIED SERVICE PERSONNEL.

The exclamation point within an equilateral triangle is intended to alert the user to the presence of important operating and maintenance (servicing) instructions in the literature accompanying the appliance.

# IMPORTANT SAFETY INSTRUCTIONS

**READ INSTRUCTIONS** — All the safety and operating instructions should be read before the product is operated.

**RETAIN INSTRUCTIONS** — The safety and operating instructions should be retained for future reference.

**HEED WARNINGS** — All warnings on the product and in the operating instructions should be adhered to.

**FOLLOW INSTRUCTIONS** — All operating and use instructions should be followed.

**CLEANING** — Unplug this product from the wall outlet before cleaning. The product should be cleaned only with a polishing cloth or a soft dry cloth. Never clean with furniture wax, benzene, insecticides or other volatile liquids since they may corrode the cabinet.

**ATTACHMENTS** — Do not use attachments not recommended by the product manufacturer as they may cause hazards.

**WATER AND MOISTURE** — Do not use this product near water — for example, near a bathtub, wash bowl, kitchen sink, or laundry tub; in a wet basement; or near a swimming pool; and the like.

**ACCESSORIES** — Do not place this product on an unstable cart, stand, tripod, bracket, or table. The product may fall, causing serious injury to a child or adult, and serious damage to the product. Use only with a cart, stand, tripod, bracket, or table recommended by the manufacturer, or sold with the product. Any mounting of the product should follow the manufacturer's instructions, and should use a mounting accessory recommended by the manufacturer.

**CART** — A product and cart combination should be moved with care. Quick stops, excessive force, and uneven surfaces may cause the product and cart combination to overturn.



**VENTILATION** — Slots and openings in the cabinet are provided for ventilation and to ensure reliable operation of the product and to protect it from overheating, and these openings must not be blocked or covered. The openings should never be blocked by placing the product on a bed, sofa, rug, or other similar surface. This product should not be placed in a built-in installation such as a bookcase or rack unless proper ventilation is provided or the manufacturer's instructions have been adhered to.

**POWER SOURCES** — This product should be operated only from the type of power source indicated on the marking label. If you are not sure of the type of power supply to your home, consult your product dealer or local power company.

**LOCATION** — The appliance should be installed in a stable location.

**NONUSE PERIODS** — The power cord of the appliance should be unplugged from the outlet when left unused for a long period of time.

## GROUNDING OR POLARIZATION

● If this product is equipped with a polarized alternating current line plug (a plug having one blade wider than the other), it will fit into the outlet only one way. This is a safety feature. If you are unable to insert the plug fully into the outlet, try reversing the plug. If the plug should still fail to fit, contact your electrician to replace your obsolete outlet. Do not defeat the safety purpose of the polarized plug.

● If this product is equipped with a three-wire grounding type plug, a plug having a third (grounding) pin, it will only fit into a grounding type power outlet. This is a safety feature. If you are unable to insert the plug into the outlet, contact your electrician to replace your obsolete outlet. Do not defeat the safety purpose of the grounding type plug.

**POWER-CORD PROTECTION** — Power-supply cords should be routed so that they are not likely to be walked on or pinched by items placed upon or against them, paying particular attention to cords at plugs, convenience receptacles, and the point where they exit from the product.

**OUTDOOR ANTENNA GROUNDING** — If an outside antenna or cable system is connected to the product, be sure the antenna or cable system is grounded so as to provide some protection against voltage surges and built-up static charges. Article 810 of the National Electrical Code, ANSI/NFPA 70, provides information with regard to proper grounding of the mast and supporting structure, grounding of the lead-in wire to an antenna discharge unit, size of grounding conductors, location of antenna-discharge unit, connection to grounding electrodes, and requirements for the grounding electrode. See Figure A.

**LIGHTNING** — For added protection for this product during a lightning storm, or when it is left unattended and unused for long periods of time, unplug it from the wall outlet and disconnect the antenna or cable system. This will prevent damage to the product due to lightning and power-line surges.

**POWER LINES** — An outside antenna system should not be located in the vicinity of overhead power lines or other electric light or power circuits, or where it can fall into such power lines or circuits. When installing an outside antenna system, extreme care should be taken to keep from touching such power lines or circuits as contact with them might be fatal.

**OVERLOADING** — Do not overload wall outlets, extension cords, or integral convenience receptacles as this can result in a risk of fire or electric shock.

**OBJECT AND LIQUID ENTRY** — Never push objects of any kind into this product through openings as they may touch dangerous voltage points or short-out parts that could result in a fire or electric shock. Never spill liquid of any kind on the product.

**SERVICING** — Do not attempt to service this product yourself as opening or removing covers may expose you to dangerous voltage or other hazards. Refer all servicing to qualified service personnel.

**DAMAGE REQUIRING SERVICE** — Unplug this product from the wall outlet and refer servicing to qualified service personnel under the following conditions:

- When the power-supply cord or plug is damaged.
- If liquid has been spilled, or objects have fallen into the product.
- If the product has been exposed to rain or water.
- If the product does not operate normally by following the operating instructions. Adjust only those controls that are covered by the operating instructions as an improper adjustment of other controls may result in damage and will often require extensive work by a qualified technician to restore the product to its normal operation.
- If the product has been dropped or damaged in any way.
- When the product exhibits a distinct change in performance — this indicates a need for service.

**REPLACEMENT PARTS** — When replacement parts are required, be sure the service technician has used replacement parts specified by the manufacturer or have the same characteristics as the original part. Unauthorized substitutions may result in fire, electric shock, or other hazards.

**SAFETY CHECK** — Upon completion of any service or repairs to this product, ask the service technician to perform safety checks to determine that the product is in proper operating condition.

**WALL OR CEILING MOUNTING** — The product should not be mounted to a wall or ceiling.

**HEAT** — The product should be situated away from heat sources such as radiators, heat registers, stoves, or other products (including amplifiers) that produce heat.

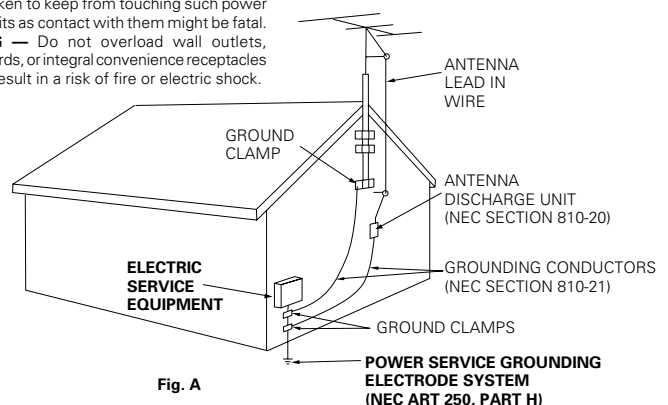

Fig. A

NEC — NATIONAL ELECTRICAL CODE

**WARNING:** TO PREVENT FIRE OR SHOCK HAZARD, DO NOT EXPOSE THIS APPLIANCE TO RAIN OR MOISTURE.

**[For U.S. model]**

### IMPORTANT NOTICE

The serial number for this equipment is located in the rear. Please write this serial number on your enclosed warranty card and keep it in a secure area. This is for your security.

**[For Canadian model]**

**CAUTION:** TO PREVENT ELECTRIC SHOCK DO NOT USE THIS (POLARIZED) PLUG WITH AN EXTENSION CORD, RECEPTACLE OR OTHER OUTLET UNLESS THE BLADES CAN BE FULLY INSERTED TO PREVENT BLADE EXPOSURE

**ATTENTION:** POUR PREVENIR LES CHOCS ELECTRIQUES NE PAS UTILISER CETTE FICHE POLARISEE AVEC UN PROLONGATEUR, UNE PRISE DE COURANT OU UNE AUTRE SORTIE DE COURANT, SAUF SI LES LAMES PEUVENT ETRE INSERES A FOND SANS EN LAISSER AUCUNE PARTIE A DECOUVERT.

**[For Canadian model]**

This Class B digital apparatus complies with Canadian ICES-003.

**[Pour le modèle Canadien]**

Cet appareil numérique de la classe B est conforme à la norme NMB-003 du Canada.

**[For U.S. model]**

**DANGER – LASER RADIATION WHEN OPEN.**

**AVOID DIRECT EXPOSURE TO BEAM.**

This caution can be found on the rear panel of the unit.

Thank you for buying this Pioneer product.

Please read through these operating instructions so you will know how to operate your model properly. After you have finished reading the instructions, put them away in a safe place for future reference.

In some countries or regions, the shape of the power plug and power outlet may sometimes differ from that shown in the explanatory drawings. However, the method of connecting and operating the unit is the same.

### CAUTION:

- Use of controls or adjustments or performance of procedures other than those specified herein hazardous radiation exposure.
- The use of optical instruments with this product will increase eye hazard.

**NOTE:** This equipment has been tested and found to comply with the limits for a Class B digital device, pursuant to Part 15 of the FCC Rules. These limits are designed to provide reasonable protection against harmful interference in a residential installation. This equipment generates, uses, and can radiate radio frequency energy and, if not installed and used in accordance with the instructions, may cause harmful interference to radio communications. However, there is no guarantee that interference will not occur in a particular installation. If this equipment does cause harmful interference to radio or television reception, which can be determined by turning the equipment off and on, the user is encouraged to try to correct the interference by one or more of the following measures:

- Reorient or relocate the receiving antenna.
- Increase the separation between the equipment and receiver.
- Connect the equipment into an outlet on a circuit different from that to which the receiver is connected.
- Consult the dealer or an experienced radio/TV technician for help.

### CAUTION:

This product satisfies FCC regulations when shielded cables and connectors are used to connect the unit to other equipment. To prevent electromagnetic interference with electric appliances such as radios and televisions, use shielded cables and connectors for connections.

### Information to User

Alteration or modifications carried out without appropriate authorization may invalidate the user's right to operate the equipment.

## IMPORTANT

### FOR USE IN THE UNITED KINGDOM

The wires in this mains lead are coloured in accordance with the following code:

Blue : Neutral  
Brown : Live

If the plug provided is unsuitable for your socket outlets, the plug must be cut off and a suitable plug fitted.

The cutoff plug should be

disposed of and must not be inserted into any 13 amp socket as this can result in electric shock. The plug or adaptor of the distribution panel should be provided with a 5 amp fuse. As the colours of the wires in the mains lead of this appliance may not correspond with coloured markings identifying the terminals in your plug, proceed as follows:

The wire which is coloured blue must be connected to the terminal which is marked with the letter N or coloured black.

The wire which is coloured brown must be connected to the terminal which is marked with the letter L or coloured red.

Do not connect either wire to the earth terminal of a three-pin plug.

#### NOTE

After replacing or changing a fuse, the fuse cover in the plug must be replaced with a fuse cover which corresponds to the colour of the insert in the base of the plug or the word that is embossed on the base of the plug, and the appliance must not be used without a fuse cover. If lost, replacement fuse covers can

**This product complies with the Low Voltage Directive (73/23/EEC, amended by 93/68/EEC), EMC Directives (89/336/EEC, 92/31/EEC and 93/68/EEC).**

## INFRINGEMENT OF COPYRIGHT [For U.K. model]

Recording and playback of copyrighted material may require consent. See the Copyright Design and Patent Act 1988.

### CAUTION

This product contains a laser diode of higher class than 1. To ensure continued safety, do not remove any covers or attempt to gain access to the inside of the product.

Refer all servicing to qualified personnel.

The following caution label appears on your unit.

Location: Rear of the unit.

**CLASS 1  
LASER PRODUCT**



### Dear Customer:

Selecting fine audio equipment such as the unit you've just purchased is only the start of your musical enjoyment. Now it's time to consider how you can maximize the fun and excitement your equipment offers. This manufacturer and the Electronic Industries Association's Consumer Electronics Group want you to get the most out of your equipment by playing it at a safe level. One that lets the sound come through loud and clear without annoying blaring or distortion-and, most importantly, without affecting your sensitive hearing.

Sound can be deceiving. Over time your hearing "comfort level" adapts to higher volumes of sound. So what sounds "normal" can actually be loud and harmful to your hearing. Guard against this by setting your equipment at a safe level BEFORE your hearing adapts.

#### To establish a safe level:

- Start your volume control at a low setting.
- Slowly increase the sound until you can hear it comfortably and clearly, and without distortion.

#### Once you have established a comfortable sound level:

- Set the dial and leave it there.

Taking a minute to do this now will help to prevent hearing damage or loss in the future. After all, we want you listening for a lifetime.

### We Want You Listening For A Lifetime

Used wisely, your new sound equipment will provide a lifetime of fun and enjoyment. Since hearing damage from loud noise is often undetectable until it is too late, this manufacturer and the Electronic Industries Association's Consumer Electronics Group recommend you avoid prolonged exposure to excessive noise. This list of sound levels is included for your protection.

#### Decibel

#### Level Example

30	Quiet library, soft whispers
40	Living room, refrigerator, bedroom away from traffic
50	Light traffic, normal conversation, quiet office
60	Air conditioner at 20 feet, sewing machine
70	Vacuum cleaner, hair dryer, noisy restaurant
80	Average city traffic, garbage disposals, alarm clock at two feet.

#### THE FOLLOWING NOISES CAN BE DANGEROUS UNDER CONSTANT EXPOSURE

90	Subway, motorcycle, truck traffic, lawn mower
100	Garbage truck, chain saw, pneumatic drill
120	Rock band concert in front of speakers, thunderclap
140	Gunshot blast, jet plane
180	Rocket launching pad

Information courtesy of the Deafness Research Foundation.



# Contents

## 1 Before You Start

Feature of the PDR-609 CD recorder .....	6
Checking what's in the box .....	6
Using this manual .....	6
Hints on installation .....	6
Putting the batteries in the remote control .....	7
Avoiding condensation problems .....	7
Care and maintenance .....	7
Cleaning external surfaces .....	7
Moving the unit .....	7
Storing optical cable .....	7
Handling discs .....	7
Storing discs .....	8
Discs to avoid .....	8
CD lens cleaner .....	8
About CD, CD-R and CD-RW discs .....	8
Playback-only CDs .....	8
CD-Recordable discs .....	8
CD-Rewritable discs .....	8
Consumer-use discs .....	8
Recording and finalizing discs .....	9
Recording copyright material .....	9

## 2 Connecting Up

Connecting up for digital playback & recording .....	10
About optical and coaxial jacks .....	10
Using the digital inputs .....	10
Using the digital outputs .....	10
CD text compatible components .....	10
Connecting up for analog playback & recording .....	11
Connecting other Pioneer  components .....	11

## 3 Controls and Displays

Front panel .....	12
Remote control .....	13
Display .....	14

## 4 Getting Started

Switching on for the first time .....	15
Selecting tracks directly .....	16
Using the menu features .....	16
Showing CD text information .....	16
Showing disc information .....	17
Introduction to CD recording .....	17
Digital recording restrictions .....	17
Recording modes .....	18
Miscellaneous information .....	18
Digital recording from DAT .....	18
Digital signal interruptions .....	18
Power interruptions .....	18

Recording one track from a source .....	19
Recording all tracks from a source .....	20
Automatically recording and finalizing a disc .....	21
Manual recording .....	22
Setting the digital recording level .....	23
Setting the analog recording level .....	24
Setting the balance .....	25
Finalizing a disc .....	26

## 5 More Playback Features

Programming the track order .....	27
Clearing the playlist .....	27
Clearing a track from the playlist .....	27
Checking what's in the playlist .....	27
Replacing a track in the playlist .....	27
Playing tracks at random .....	28
Repeating tracks .....	28
Fading in and fading out .....	28
Playing a disc with skip IDs .....	28
Skipping unwanted tracks .....	29
Setting skip IDs .....	29
Clearing skip IDs .....	29

## 6 More Recording Features

Using CD text .....	30
Editing CD text .....	31
Copying track names to other tracks .....	32
Automatically numbering tracks .....	33
Manually numbering tracks .....	33
Starting tracks in time increments .....	34
Recording fade ins and fade outs .....	34
Setting the fade length .....	34
Recording a fade in .....	34
Recording a fade out .....	34
Recording blank sections .....	35
Checking what's at the end of a disc .....	35
Monitoring a source .....	36
Checking for digital copy protection .....	36
Erasing a CD-RW disc .....	37
When a non-finalized disc is loaded .....	37
When a finalized disc is loaded .....	38
Reinitializing a disc .....	38

## 7 Additional Information

Understanding display messages .....	39
Troubleshooting .....	40
Display messages relating to playback .....	40
Display messages relating to recording .....	41
Specifications .....	43

## Features of the PDR-609 CD recorder

### Create your own audio CDs

At last, there's a convenient and affordable way to make your own audio CDs. Create your own original recordings, or put together compilations of your favorite tracks from your existing CDs. Other uses include making high-quality recordings from radio or satellite broadcasts, and making personal copies of CDs, MDs, etc. to keep in the car, keeping the originals safe at home. The CD text feature of the PDR-609 allows you put text information on your recordings to easily identify and select from the contents.

### Make digital recordings from any source

The PDR-609 can accept digital input via optical or coaxial cable, meaning that you can connect it to almost any other digital audio component. Also, thanks to the built in sampling rate converter, you can make direct digital recordings from satellite (usually 32kHz), DCC and DAT (up to 48kHz), as well as CD and MD (both 44.1kHz). A sampling rate converter 'through' feature (for 44.1kHz sources only) enables you to record HDCD and DTS encoded CDs too. Analog sources are also catered for with the analog line inputs, suitable for connection to standard audio components such as cassette decks and turntables.

### Use both ordinary recordable CDs and rewritable CDs

Ordinary recordable CDs (CD-R) can be recorded on just once, but the relatively cheap cost of blank discs and the ability to play the recorded discs on any ordinary CD player\* make them ideal for many applications. Compact Disc Rewritable, or CD-RW, is a more recent type of recordable CD that allows erasing and re-recording of the disc. Although the blank discs are more expensive, this ability to use the discs over and over gives them the edge in terms of flexibility over CD-R\*\*.

\* While most CD players should have no problems with

CD-R discs, if the laser pickup is dirty (from prolonged exposure to tobacco smoke, for example), the player may not be able to read some CD-R discs.

\*\* At the time of writing, most ordinary CD players cannot play CD-RW discs. Check in the instructions that came with the player for compatibility.

## Checking what's in the box

Make sure that you've received the following supplied accessories with your PDR-609 CD Recorder:

- |                           |                               |
|---------------------------|-------------------------------|
| 1 Two sets of audio cords | 3 Two 'AA' size R6P batteries |
| 2 AC power cord           | 4 Remote control unit         |

- Also included in the box is your warranty card and this instruction manual.

## Using this manual

This manual is for the PDR-609 CD Recorder. It is split into two sections: the first shows how to set up the CD recorder; the second takes you through each stage of operation. Set up, which starts here, shows you how to get your new CD recorder up and running with the rest of your stereo system.

In the second section of the manual, starting on page 16, you'll learn how to use the various features of the recorder. The final part of the manual provides reference information on display messages you might encounter during use, a troubleshooting section, and technical specifications.

## Hints on installation

We want you to enjoy using the PDR-609 for years to come, so please bear in mind the following points when choosing a suitable location for it:

### Do...

- ✓ Use in a well-ventilated room.
- ✓ Place on a solid, flat, level surface, such as a table, shelf or stereo rack.

### Don't...

- ✗ Use in a place exposed to high temperatures or humidity, including near radiators and other heat-generating appliances.
- ✗ Place on a window sill or other place where the player will be exposed to direct sunlight.
- ✗ Use in an excessively dusty or damp environment.
- ✗ Place directly on top of an amplifier, or other component in your stereo system that becomes hot in use.
- ✗ Use near a television or monitor as you may experience interference—especially if the television uses an indoor antenna.
- ✗ Use in a kitchen or other room where the player may be exposed to smoke or steam.
- ✗ Place on an unstable surface, or one that is not large enough to support all four of the unit's feet.

## Putting the batteries in the remote control

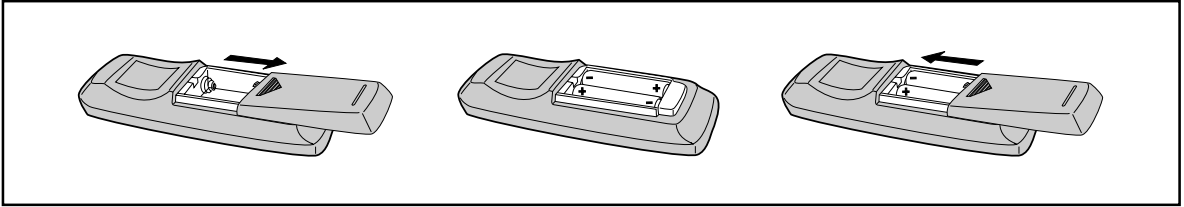

- Turn over the remote control, then press and slide the battery compartment cover off.
- Put in the batteries supplied, taking care to match the plus and minus ends of each battery with the markings inside the compartment.
- Slide the cover back on, and your remote is ready for use.

### Caution!

Incorrect use of batteries can result in hazards such as leakage and bursting. Please observe the following:

- Don't mix new and old batteries together
- Don't use different kinds of battery together—although they may look similar, different batteries may have different voltages.
- Make sure that the plus and minus ends of each battery match the indications in the battery compartment.
- Remove batteries from equipment that isn't going to be used for a month or more.
- When disposing of used batteries, please comply with governmental regulations or environmental public institution's rules that apply in your country or area.

## Avoiding condensation problems

Condensation may form inside the player if it is brought into a warm room from outside, or if the temperature of the room rises quickly. Although the condensation won't damage the player, it may temporarily impair its performance. For this reason you should leave it to adjust to the warmer temperature for about an hour before switching on and using.

## Care and maintenance

### Cleaning external surfaces

To clean the compact disc recorder, wipe with a soft, dry cloth. For stubborn dirt, wet a soft cloth with a mild detergent solution made by diluting one part detergent to 5 or 6 parts water, wring well, then wipe off the dirt. Use a dry cloth to wipe the surface dry. Do not use volatile liquids such as benzene and thinner which may damage the surfaces.

### Moving the unit

If you need to move the unit, first switch it off and unplug from the wall outlet. **Never lift or move the unit during playback or recording**—the disc rotates at a high speed and may be damaged.

### Storing optical cable

When storing optical cable, coil loosely as shown at right. The cable may be damaged if bent around sharp corners.

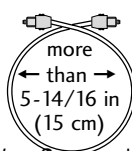

## Handling discs

When holding CDs of any type, take care not to leave fingerprints, dirt or scratches on the disc surface. Hold the disc by its edge or by the center hole and edge. Damaged or dirty discs can affect playback and/or recording performance. Take care also not to scratch the label side of the disc. Although not as fragile as the recording side, scratches can still result in a disc becoming unusable.

Should a disc become marked with fingerprints, dust, etc., clean using a soft, dry cloth, wiping the disc lightly from the center to the outside edge. If necessary, use a cloth soaked in alcohol, or a commercially available CD cleaning kit to clean a disc more thoroughly. Never use benzine, thinner or other cleaning agents, including products designed for cleaning vinyl records.

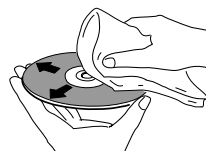

Wipe lightly from the center of the disc using straight strokes.



Don't wipe the disc surface using circular strokes.

# 1 Before you start

## Storing discs

Although CD, CD-R and CD-RW discs are more durable than vinyl records, you should still take care to handle and store discs correctly. When you're not using a disc, return it to its case and store upright. Avoid leaving discs in excessively cold, humid, or hot environments (including under direct sunlight).

When labeling discs, use a felt-tip pen sold for marking CDs. Don't glue paper or put stickers onto the disc, or use a pencil, ball-point pen or other sharp-tipped writing instrument. These could all damage the disc.

For more detailed care information see the instructions that come with discs.

## Discs to avoid

CDs spin at high speed inside the player during playback and recording. If you can see that a disc is cracked, chipped, warped, or otherwise damaged, don't risk using it in your CD recorder or player—you could end up damaging the unit.

The PDR-609 is designed for use with conventional, fully circular CD's only. Use of shaped CD's is not recommended for this product. Pioneer disclaims all liability arising in connection with the use of shaped CD's.

## CD lens cleaner

The compact disc recorder's pickup lens should not become dirty in normal use, but if for some reason it should malfunction due to dirt or dust, consult your nearest Pioneer authorized service center. Although lens cleaners for compact disc recorders are commercially available, we do not recommend using them since some may damage the lens.

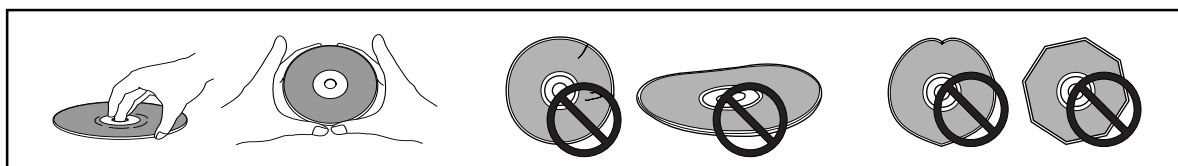

## About CD, CD-R and CD-RW discs

The PDR-609 is compatible with three types of compact disc:

### Playback-only CDs

This unit will playback any ordinary audio CDs carrying the Compact Disc Digital Audio mark shown right.



### CD-Recordable discs

Recordable CDs, or CD-R, carry the mark shown right, and are 'write once'. This means that having recorded something on the disc it is permanent—it can't be re-recorded or erased.



### CD-Rewritable discs

Rewritable CDs, or CD-RW, carry the mark shown right. As the name indicates, you can erase and re-record material on these discs so that they can be used over and over again.



### CD TEXT discs

CD Text discs, carry the mark shown right. These are commercially available discs that will display the disc title, artist name, and track titles of the disc when played in a CD text compatible player.



## Consumer-use discs

The PDR-609 is only compatible with special consumer-use CD-R and CD-RW discs. These are clearly marked **For Music Use Only, For Consumer, or For Consumer Use**. Other types of CD-R or CD-RW discs, such as those available for computer-based CD recorders, will not work with this recorder.

Pioneer has checked the following branded discs for compatibility with this recorder (as of May 2000):

- Eastman Kodak Company
- Fuji Photo Film Co., Ltd.
- Hitachi Maxell, Ltd.
- Mitsui Chemicals, Inc.
- Sony Corporation
- Ritek Corporation
- Taiyo Yuden Co., Ltd.
- TDK Corporation
- Verbatim Corporation
- Pioneer Corporation

Sample discs from the following makers have also been checked for compatibility (as of May 2000):

- Mitsubishi Chemical Corporation\*
- Ricoh Company, Ltd.\*

\* At the time of writing, discs branded under these names are not available.

**Note:** Discs from all of the above makers may also be sold under different brand names.



## Recording and finalizing discs

Unlike other recording media, recordable CDs have a number of distinct states, and what you can do with a disc depends on the current state of the disc. The figure below shows the three states—blank, partially recorded, and finalized—and summarizes what's possible (✓) and impossible (✗) in each.

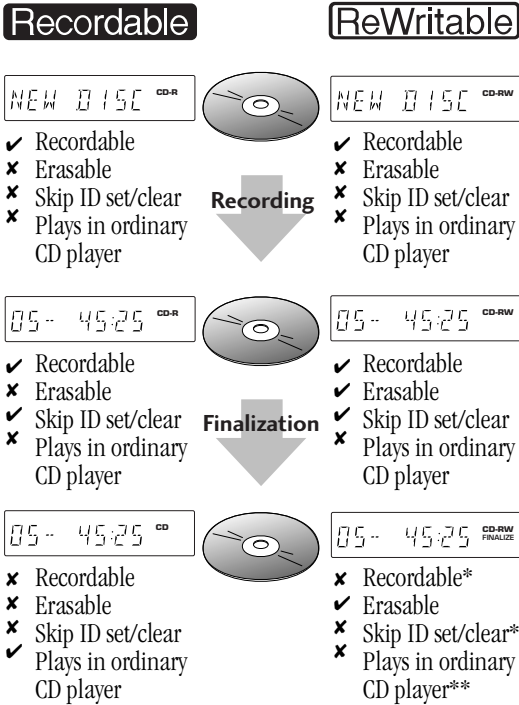

\* Once the CD-RW has been erased, it becomes recordable again and skip IDs can be set and cleared.

\*\* In general, current CD players cannot play CD-RW discs. However, this situation may change.

The process of finalization fixes the contents of a CD-R in place for good by creating a Table of Contents (TOC, for short) at the beginning of the disc which tells other players exactly what's on the disc and where to find it. See *Finalizing a disc* on page 42 for more on finalization.

## Recording copyright material

The price of a consumer-use disc includes a copyright fee that has been paid to the copyright owner (in countries where the copyright fee collection system has been established based on their respective copyright laws). This means that you can use these discs to record music and other material for your personal use. If you want to use a disc for anything other than personal use, you must get permission from the copyright owner (note that copyright laws vary from country to country; check the copyright-related laws in your particular country for more information).

Broadcast programs, CDs, other recorded media (cassettes, vinyl records, etc.) and musical performances are all protected by copyright laws. You must get permission from the copyright owner if you sell, transfer, distribute or lease a disc recorded from the above mentioned sources, or if you use it as part of a business (such as for background music in a store).

*Keep in mind the following when using the remote control unit:*

- Make sure that there are no obstacles in between the remote and the remote sensor on the unit.
- Use within the operating range and angle, as shown in the diagram below.
- Remote operation may become unreliable if strong sunlight or fluorescent light is shining on the unit's remote sensor.
- Remote controllers for different devices can interfere with each other. Avoid using remotes for equipment located near this unit while using the PDR-609.
- Replace the batteries when you notice a fall off in the operating range of the remote.

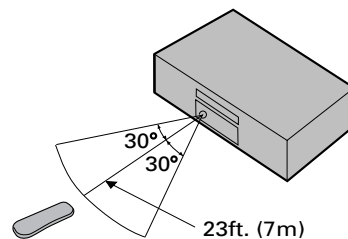

### PDR-609 CD-Recorder

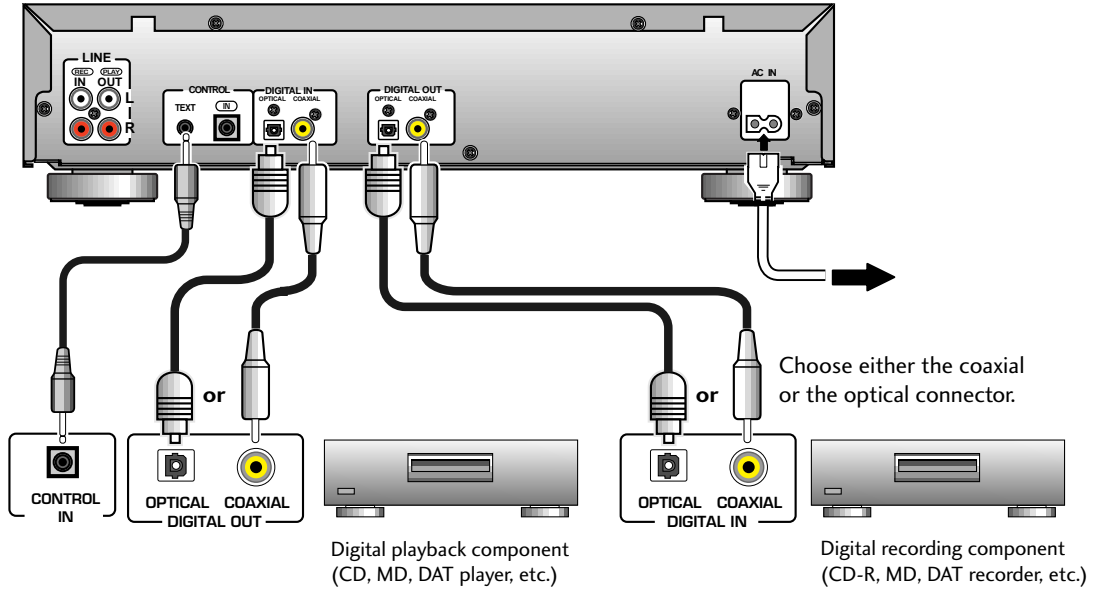

Before making or changing the connections, switch off the power and disconnect the power cord from the AC outlet.

**Note:** It is not possible to daisy-chain several units together for digital duplication.

## Connecting up for digital playback & recording

The diagrams on these pages show possible connections with various other components in your system. Before you start connecting your system, make sure that all the components are switched off and disconnected from the wall outlet.

### About optical and coaxial jacks

The PDR-609 has both optical and coaxial jacks for both digital input and output. There's no need to connect both, but since some equipment has only one type of connector—and you can only connect like with like—having both on this unit can be an advantage.

To use the optical jack, you'll need an optical cable. These are readily available at audio dealers. When buying, check that the cable is no longer than 3m.

Pull out the dust cap and store it in a safe place for future use. Check that both optical plug and socket are free from dust—if necessary, clean with a soft, dry cloth. The optical lead will only go in one way, so match up the jack and the plug before inserting fully.

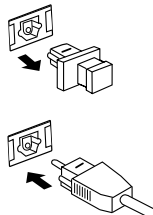

When connecting optical leads, take care not to bend the

cable around sharp corners as this can damage the cable. Likewise, when storing optical cable, coil loosely (as shown on page 8).

If you're using one of the coaxial-type digital connectors you'll need a lead with an RCA/phono plug at each end (the same type of connector as the Video cable).

### Using the digital inputs

To make direct digital recordings on the PDR-609 you'll need to connect the digital output of a source (like a CD, MD, or DAT player) to one of the digital inputs on this unit. To make recordings from analog sources (like a turntable or cassette deck) it's usually easiest to connect this player to your amplifier/receiver's tape inputs and outputs—see page 15 for more on this.

### Using the digital outputs

If you have another digital recorder, such as a MD or DAT recorder, you might want to use the PDR-609 as a digital source. In this case, connect one of the digital outputs of the PDR-609 to a similar digital input on your other digital recorder.

### CD text compatible components

If you wish to record CD text as well as audio information from an external CD player (compatible with CD text), you must connect the **CONTROL IN** on the unit to the **CONTROL TEXT** jack on the PDR-609 using a commercially available cord with a mono mini-plug. At the time of writing, the Pioneer PD-F1009 is the only CD player that can perform this operation.

**Note:** Make sure that at least one set of analog terminals is connected to the amplifier when using CD text control cords.

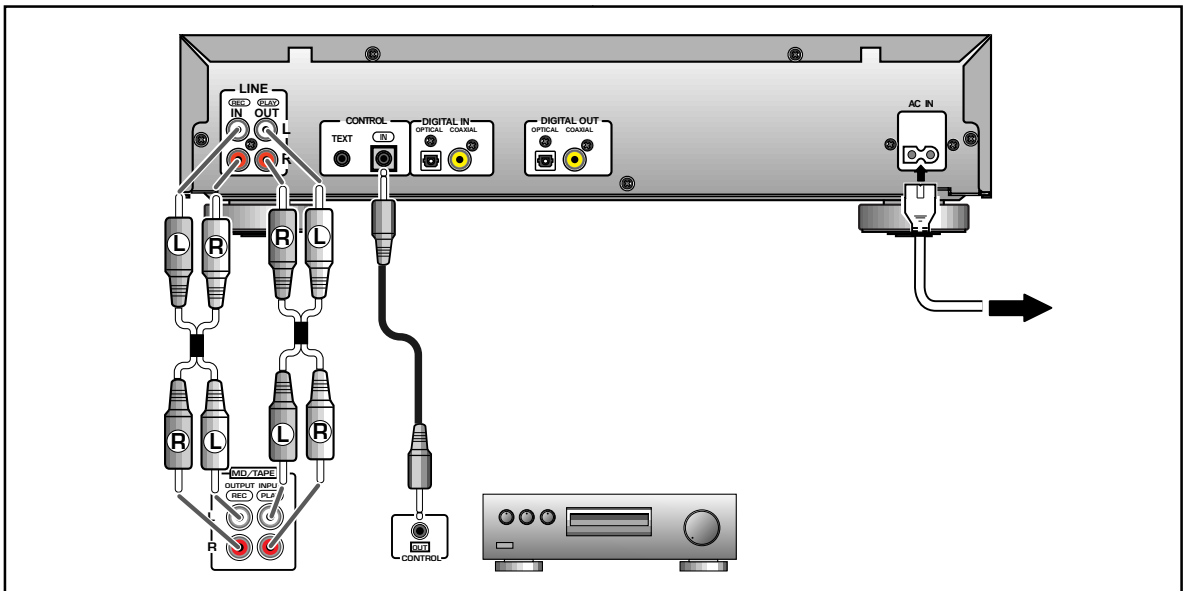

## Connecting up for analog playback & recording

Before you start, make sure that all the components are switched off and disconnected from the wall outlet.

Next, connect this unit to your amplifier/receiver using the two sets of supplied audio leads—one set for playback, the other for recording. On the rear panel of your amplifier find an unused set of inputs/outputs for a tape/md recorder (check the instruction manual that came with your amplifier if you're unsure about which terminals to use).

Using this set up you can make recordings from any other component connected to the amplifier, via the analog inputs of this unit.

## Connecting other Pioneer components

If you are using a Pioneer amplifier or receiver that has this feature, you can control this unit with the multi-remote controller that came with your amplifier/receiver. The advantage of this is that you can use a single remote control to operate several components. Check the instruction manual that came with your amplifier or receiver for more information on using its remote as a multi-controller.

Use a commercially available cord with a mono mini-plug at either end to connect the **CONTROL OUT** terminal of the amplifier/receiver to the **CONTROL IN** terminal of this unit.

**Note:** Make sure that at least one set of analog terminals is connected to the amplifier when using  control cords.

## POWER-CORD CAUTION

Handle the power cord by the plug part. Do not pull out the plug by tugging the cord, and never touch the power cord when your hands are wet, as this could cause a short circuit or electric shock. Do not place the unit, a piece of furniture, or other object on the power cord or pinch the cord in any other way. Never make a knot in the cord or tie it with other cords. The power cords should be routed so that they are not likely to be stepped on. A damaged power cord can cause a fire or give you an electric shock. Check the power cord once in a while. When you find it damaged, ask your nearest Pioneer authorized service center or your dealer for a replacement.

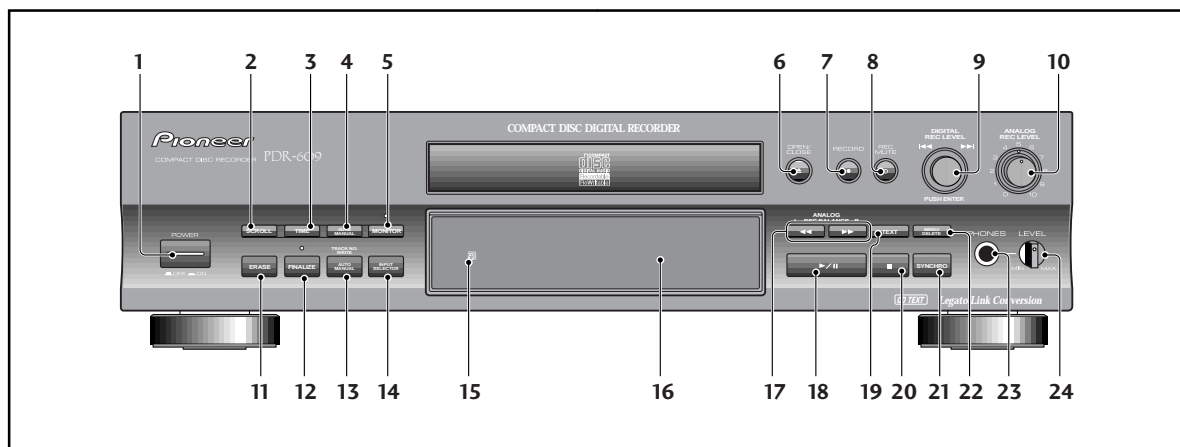

## Front panel

- 1 POWER switch (p.15)**  
Switches power to the unit on and off.
- 2 SCROLL (p. 16)**  
Press to scroll through long names in CD text.
- 3 TIME (p.17)**  
Switches the display mode (elapsed track time, remaining track time, total disc playing time, etc.)
- 4 DISPLAY/CHARA (p.16,30)**  
Press to switch between display modes (disc title, artist name, track title) (p.16), and between upper- and lower-case characters while using CD text (p.30).
- 5 MONITOR (p.23-25,36)**  
Press to monitor the selected input and display digital source information. Indicator lights up to remind you when you are monitoring.
- 6 OPEN/CLOSE ▲ (p.15)**  
Press to open or close the disc tray.
- 7 RECORD ● (p.22–25)**  
Press to enter record-pause mode for setting input levels, etc.
- 8 REC MUTE ○ (p.35)**  
Records a blank section on a disc (for space between tracks, etc.)
- 9 DIGITAL REC LEVEL / |◀◀ ▶▶| (Jog dial)**  
Turn the jog dial to: set the digital recording level (p.23); skip tracks (p.15); select options in the menu (p.23,25,33-35); cycle through characters in CD text (p.30); select tracks to erase (p.38-39).  
Push the jog dial to: start playback (stop mode only) (p.15); input track numbers (during programming) (p.27); select characters in CD text (p.30); confirm menu settings (p.16).
- 10 ANALOG REC LEVEL (p.24)**  
Sets the recording level for analog-input recording.
- 11 ERASE (p.38–39)**  
Press to start erasing tracks, or to re-initialize a disc.
- 12 FINALIZE (p.26)**  
Press to start the disc finalization process (to make recordable CDs playable on ordinary CD players). Indicator lights up during finalization.
- 13 AUTO/MANUAL (p.33–34)**  
Switches between automatic and manual track numbering when recording a disc.
- 14 INPUT SELECTOR (p.19–24,37)**  
Switches between the analog, optical digital and coaxial digital inputs.
- 15 Remote sensor (p.9)**
- 16 Character display (p.14)**
- 17 ◀▶ / REC BALANCE (p.15,25,30)**  
Press and hold for fast-reverse and fast-forward playback (p.15). Use when recording to set left and right input levels (p.25). Use to move cursor back and forth across character display while using CD text (p.30).
- 18 ▶/II (p.15,19-22)**  
Press to play, pause, or resume playing, a disc. Also use to start recording from record-pause mode.
- 19 NAME (p.30–32)**  
Use to cycle through CD text naming options.
- 20 ■ (p.16,19–22)**  
Press to stop playback or recording.
- 21 SYNCHRO (p.19–21)**  
Press to start recording on detection of an input signal.
- 22 MENU/DELETE (p.16,23,25,30,33,35)**  
Press to cycle through the preference menu options (p.16, 23, 25,33,35). Press to delete characters while editing CD text (p.30).
- 23 PHONES jack**  
Plug in a pair of stereo headphones for private listening or monitoring.
- 24 LEVEL**  
Use to adjust the phones volume.

## Remote control

### 1 **○ REC MUTE (p.35)**

Records a blank section on a disc (for space between tracks, etc.)

### 2 **● REC (p.22–25)**

Press to enter record-pause mode.

### 3 **TIME (p.17)**

Switches the display mode (elapsed track time, remaining track time, total disc playing time, etc.)

### 4 **DISPLAY/CHARA**

Press to switch between display modes (disc title, artist name, track title) (p.16), and between upper- and lower-case characters while using CD text (p.30).

### 5 **SCROLL (p.16)**

Press to scroll through long names in CD text.

### 6 **MARK / 10/0**

Press to choose symbol characters when using CD text. As a numeric key, this represents zero.

### 7 **MENU/DELETE (p.16,23,25,30,33,35)**

Press to cycle through the preference menu options. Press to delete characters while editing CD text.

### 8 **◀◀ (p.15)**

Press to skip backward tracks. Also performs those operations assigned to turning the jog dial (see page 12).

### 9 **Playback control (p.15–16,19–22) / ENTER**

▶ Press to play, or resume playing, a disc.

◀◀ and ▶▶ Press and hold for fast-reverse and fast-forward playback, and to move cursor position using CD text.

■ Press to stop playback or recording.

ENTER Confirm playback, recording, menu settings (p.16), and characters in CD text (p.30).

### 10 ←

Press to skip backward index points.

### 11 **RANDOM (p.28)**

Press to start random playback.

### 12 **REPEAT (p.28)**

Use to set the repeat mode (current track, disc, or repeat off).

### 13 **PROGRAM (p.27)**

Use to program the playback order of tracks on a disc.

### 14 **FADER (p.28,34)**

Press to fade in or fade out during playback or recording.

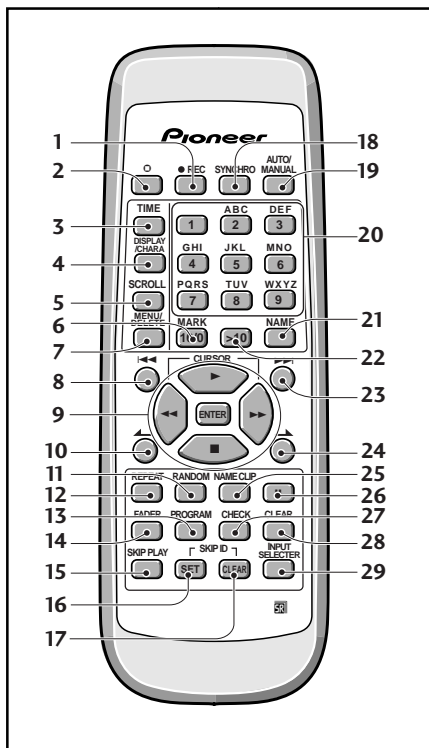

### 15 **SKIP PLAY (p.28)**

Press to switch skip play on and off.

### 16 **SKIP ID SET (p.29)**

Instructs the player to skip a particular track on playback.

### 17 **SKIP ID CLEAR (p.29)**

Clears the above setting.

### 18 **SYNCHRO (p.19–21)**

Press to start recording on detection of an input signal.

### 19 **AUTO/MANUAL (p.33–34)**

Switches between automatic and manual track numbering when recording a disc.

### 20 **Number / Letter buttons (p.16,27,30)**

Use to jump directly to track numbers for playback, selecting track numbers for editing / programming, and selecting letters when using CD text.

### 21 **NAME (p.30–32)**

Use to cycle through CD text naming options.

### 22 **>10 (p.16,27)**

Use to select track numbers over 10.

### 23 **▶▶ (p.15)**

Press to skip forward tracks. Also performs those operations assigned to turning the jog dial (see page 12).

### 24 ←

Press to skip forward index points.

### 25 **NAME CLIP (p.32)**

Press to copy the current CD text to the recorder's memory.

### 26 **|| (p.15,22)**

Press to pause playback or recording.

### 27 **CHECK (p.27)**

Press repeatedly to step through the program playlist.

### 28 **CLEAR (p.27)**

Press to clear the last track in a programmed playlist.

### 29 **INPUT SELECTOR (p.19–24,37)**

Switches between the analog, optical digital and coaxial digital inputs.

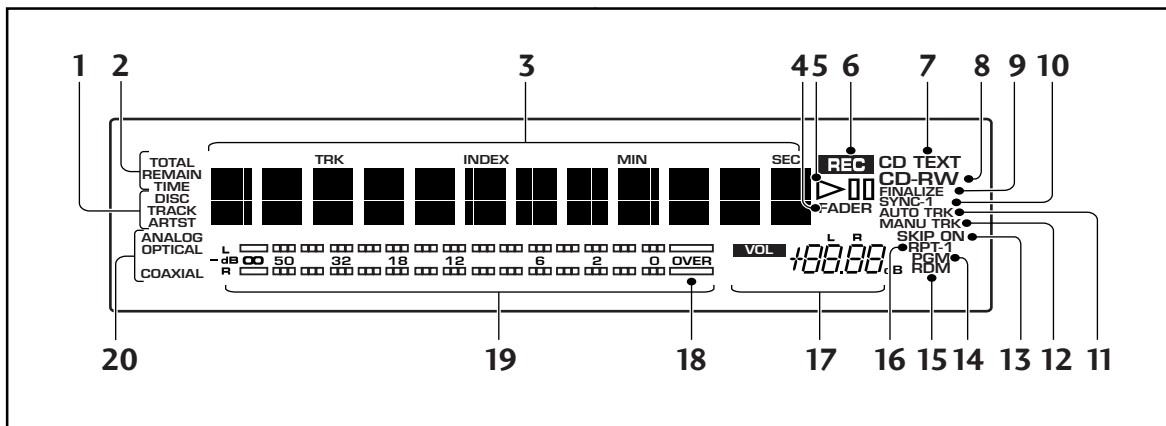

## Display

### 1 CD text indicators (p.16)

- DISC** Lights up when disc information is displayed.
- TRACK** Lights up when track information is displayed.
- ARTST** Lights up when artist information is displayed.

### 2 TOTAL / REMAIN / TIME (p.17)

Indicates whether the current displayed time is elapsed, remaining, or total time for a disc or individual tracks.

### 3 Message/time display

#### 4 FADER (p.28,34)

Blinks during fade in or fade out.

#### 5 ► (p.15–16) Lights up during playback.

⏸ (p.15,22) Lights during play- or record-pause.

#### 6 REC (p.22–25,34)

Lights up to when recording or record-paused. Blinking display indicates record muting.

#### 7 CD TEXT (p.15,30,31)

Lights if the CD currently loaded contains CD text.

#### 8 CD / CD-R / CD-RW (p.15)

Indicates the type of disc currently loaded.

#### 9 FINALIZE (p.21,26)

Lights up if the CD-RW currently loaded has been finalized. Also blinks during automatic finalization recording (p.21,26).

#### 10 SYNC / SYNC-1 (p.19–21)

Lights up when the recorder is in automatic synchro recording mode.

#### 11 AUTO TRK (p.33)

Lights when automatic track numbering is on during recording.

#### 12 MANU TRK (p.34)

Lights up when manual track numbering is on during recording.

### 13 SKIP ON (p.28)

Lights up to indicate that a disc contains skip IDs. When setting or clearing skip IDs, the word **SKIP** blinks.

### 14 PGM (p.27)

Lights up when program-play is active.

### 15 RDM (p.28)

Lights up when random-play is active.

### 16 RPT / RPT-1 (p.28)

Lights up when repeat play is active.

### 17 Recording level balance (p.16,23,25)

Displays the digital recording volume. If the balance has been changed, the indicator (**L** or **R**) of the louder channel lights up. Both indicators light when the balance is unchanged. Track numbers are displayed while using CD text.

### 18 OVER indicator (p.24)

Indicates that the input signal overloaded the disc during recording.

### 19 Recording level meter (p.19–24)

Displays the input level during recording, or the recorded level during playback.

### 20 ANALOG (p.19–24,37)

Lights when the analog input is selected.

#### OPTICAL (p.19–24,37)

Lights when the optical digital input is selected.

#### COAXIAL (p.19–24,37)

Lights when the coaxial digital input is selected.

## Switching on for the first time

The next few pages take you through switching on the PDR-609, playing discs, and doing some basic recording. Before proceeding with this section you should have at least connected your recorder to an amplifier. (If you haven't, turn to pages 10–11 for more on connecting the PDR-609 to other components in your system.)

### 1 Switch the POWER to **ON**.

The record indicator flashes, and the main display panel lights up.

- Also make sure that your amplifier is switched on and the input function set to the PDR-609.

### 2 Press **OPEN/CLOSE** to open the disc tray.

### 3 Load a pre-recorded audio CD.

Place the disc in the disc tray label-side up.

- The disc tray has guides for both CD singles (8cm) and regular CDs (12cm). Do not use an adaptor when playing CD singles: it could damage the recorder.

- Never load more than one disc at a time.

### 4 Press **OPEN/CLOSE** to close the disc tray.

Once the recorder has found out what is on the disc, the display will show track and disc information or, depending on the disc, CD text.

If the disc does not contain CD text, you should see a display that looks something like this:

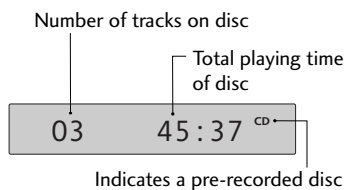

- Pressing **▶** (**▶/||** on the front panel) will also close the disc tray (but you won't see the above display).

If the disc contains CD text, the **CD TEXT** indicator lights up and the entire disc title automatically scrolls across the display. The first 12 characters of the disc title remain, as seen in the display below:

BEST CLASSIC <sup>CD TEXT</sup>  
CD

You can switch CD text information displays by pressing **DISPLAY/CHARA**.

See page 16 for more on CD text displays.

Pressing **TIME** allows you to switch to the disc and track time information displays.

See page 17 for more on time displays.

### 5 Press **▶** to start the disc playing.

Pressing **▶/||** or the jog dial on the front panel also starts playback.

### 6 To pause playback, press **||** (or **▶/||** again).

To resume playback, press either **||** again, or **▶** (**▶/||**). The recorder only remains paused for 10 minutes, then it stops.

### 7 To fast-reverse or fast-forward, press and hold **◀◀** or **▶▶**.

### 8 To skip back or forward to another track, press **◀◀** or **▶▶** (on the front panel, turn the jog dial).

Pressing **▶▶** once skips to the start of the next track on the disc. Further presses take you to subsequent tracks.

Pressing **◀◀** once takes you to the beginning of the current track. Further presses skip to the start of previous tracks.

You can use **◀◀** or **▶▶** while the disc is paused or stopped as well. The track number changes while the disc remains paused/stopped.

### 9 To skip back or forward index markers, press **◀** or **▶** on the remote control.

Because most CDs don't have index markers, you will generally see **01** in the index display for each track.

### 10 To stop playback, press **■**.

Take out the CD from the disc tray before switching off the unit.

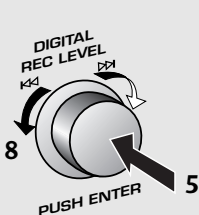
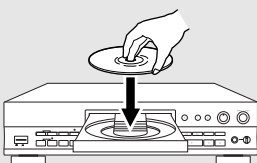
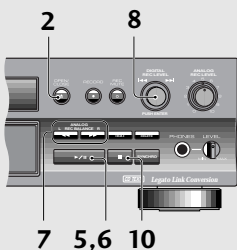
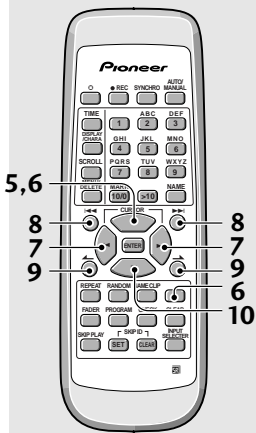

Number buttons



DISPLAY/CHARA



DISPLAY/CHARA

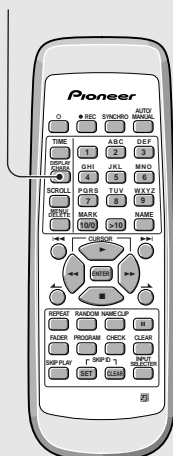

## Selecting tracks directly

If you want to start directly from a track other than the first, just enter the track number from the remote control. If you do the same thing during playback, the recorder immediately jumps to that track on the disc.

- **While a disc is stopped, paused or playing, enter the track number you want to play.** The recorder jumps directly to that track. If the recorder was stopped, the track then starts playing.

For track numbers 1 to 10, use the corresponding number button.

For track numbers over 10, press the **>10** button, then enter the track number. For example, to select track 28:



## Using the menu features

Several features of the CD recorder can be accessed by using the **MENU/DELETE** key. This menu is like a selection of preferences that will stay in memory even if the system is turned off (see note below). The jog dial cycles you through the features listed below (refer to the page numbers listed to set your preferences in the menu).

- Digital volume (p.23)
- Balance (p.25)
- Silence threshold for auto track numbering (p.33)
- Time increment recording (p.35)
- Fade length (p.35)

**Note:** The time increment will default to **OFF** when: recording is stopped; auto track numbering is turned off; power is switched off.

## Showing CD text information

If the CD contains text information, you can see this in the display during both playback and when the disc is stopped. The **DISPLAY/CHARA** button switches between the different text displays. When a disc with text is loaded into the recorder, the entire disc title automatically scrolls across the display. The first 12 characters of the disc title remain. Press **SCROLL** at any time to see the full title scroll across the display.

- **During playback, press DISPLAY/CHARA to switch the display.** There are three different displays. Press **DISPLAY/CHARA** repeatedly to switch between them:

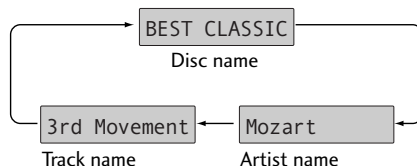

- **While stopped, press DISPLAY/CHARA to switch the display.** There are two different displays. Press **DISPLAY/CHARA** repeatedly to switch between them:

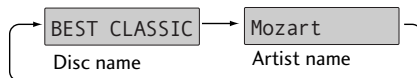



## Showing disc information

The PDR-609 can display various kinds of disc and track information during both playback and recording. The **TIME** button switches between the different time display modes. Additionally, while stopped, individual track information is available from the track skip buttons (◀◀ and ▶▶), or by turning the jog dial.

- **During playback, press TIME to switch the display mode.**

There are three different displays. Press **TIME** repeatedly to switch between them:

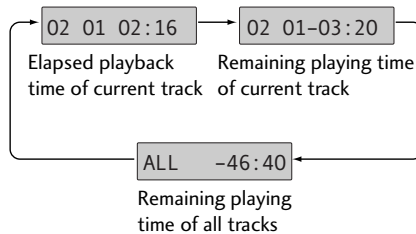

- **During recording, press TIME to switch the display mode.**

There are two different displays. Press **TIME** repeatedly to switch between them:

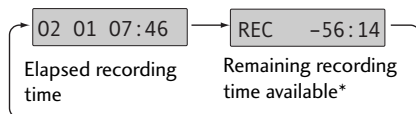
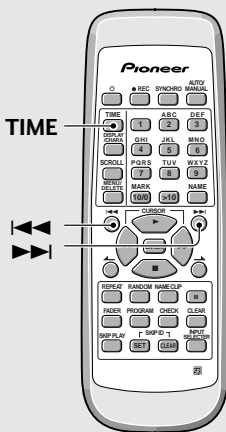

- **While stopped, press TIME to switch the display mode.**

There are two different displays. Press **TIME** repeatedly to switch between them:

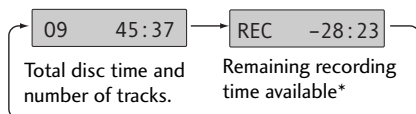

\* Although compatible with 80 minute discs, the remaining recording time display will not accurately show 80 minutes for blank discs.

## Introduction to CD recording

The PDR-609 is designed to let you make extremely high quality digital recordings onto recordable compact discs. For flexibility, you can use either rewritable discs (CD-RW) or write-once discs (CD-R). For more general information on the discs you can and can't use with this recorder, see *About CD, CD-R and CD-RW Discs* on page 10. The following 2-page overview gives you some idea of what the PDR-609 is capable of, and also provides guidance on what to avoid and things to be careful of when recording. We strongly recommend that you read these pages fully before proceeding to the more detailed instructions on the following pages.

## Digital recording restrictions

This unit has been designed exclusively for recording and playback of audio discs—you can't record other CD formats, such as computer CD-ROMs or Dolby Digital (AC-3).

If you record from a disc format such as CD+graphics, Video-CD, or other format that includes both digital audio and video or text, you will only be able to record the audio part of the disc.

In addition to standard audio CDs, this recorder will record DTS encoded audio CDs and HDCD format CDs (in this case, the recording level must be set to **0dB**).

Almost all commercial digital source material is protected by copyright laws. For this reason, the PDR-609 uses special consumer-use blank CD-R and CD-RW discs on which a copyright fee has already been paid. A further restriction comes in the form of SCMS (an acronym for Serial Copy Management System).



This generally allows just one generation of digital recording. In other words, you can make a digital recording from an original source (such as a commercial CD), but you can't then make further digital recordings from that copy. Most digital recording equipment uses the SCMS system, including CD and MD recorders, and DAT decks. You may also find that you can't record certain DVD discs as the digital output of the DVD player can be disabled by the disc.

Of course, if you do encounter SCMS or other digital-copy restrictions, you can always record through the analog inputs of the PDR-609. To check whether a source is digital-copy protected, see *Checking for Digital Copy Protection* on page 60.

### Recording modes

The recorder is equipped with a set of analog input terminals, as well as both optical and coaxial digital inputs. This means that the PDR-609 is compatible with almost all audio sources—analogue or digital. It even has a built in sampling rate converter making it ideal for recording DAT tapes or satellite broadcasts, for example, which are often at sampling rates different to that of CD. Since CDs are always recorded at a sampling rate of 44.1kHz, sample rate conversion is completely automatic—if the recorder senses a digital signal at either 32 or 48kHz, it will convert it to 44.1kHz. Note that this recorder can't convert 96kHz digital sources (such as some DAT tapes and DVD discs).

### Miscellaneous information

- The minimum recordable time is four seconds.
- Usually, track numbers are recorded onto the disc automatically when recording. If you decide to switch off this feature (for example, when you're recording from a satellite broadcast), be sure to input track markers as recording is taking place—you can't add them after recording is complete. See pages 33 for more on manual and automatic track numbering.
- The maximum number of tracks on a disc is 99.

### Digital recording from DAT

If you're recording a DAT tape that was recorded using the DAT machine's auto ID function, the IDs on the tape are slightly after the beginning of the actual recording. This can cause problems for the CD recorder:

- The start of the track may not be recorded.
- The track number will be recorded on the disc after the start of the track.
- The beginning of the next track on the DAT is unintentionally recorded.

To avoid these problems, we recommend recording start IDs on the DAT manually, if possible. If this is not possible, or if there are no start IDs on the DAT, we recommend using manual track numbering while recording to CD to ensure that new tracks are starting in the right places. Refer to the instructions for your DAT recorder for more information.

You might also encounter problems if you try to synchro-record all tracks from a DAT that is set to program play. If you want to record a DAT in program play mode, use the 1-track synchro recording mode—see pages 20 for how to do this.

### Digital signal interruptions

Sources of signal interruption include power or source component failure, accidental disconnection of the interconnect cord, and interruption of digital satellite broadcasts. In all these cases, if the signal resumes within about five seconds, the result will just be a blank section on the disc. If the interruption is longer than five seconds, the recorder displays the error message: **DIN UNLOCK** and recording is paused.

### Power interruptions

Never switch off the PDR-609 while it's recording, or while the display shows **PMA REC** (Program Memory Area Recording). If there's a power failure, or you accidentally disconnect the power from the wall outlet while recording is in process, you'll lose at least part of the recording.

After recording, always remove the disc from the recorder before switching the power off. Failure to do this could result in you losing some of the recorded material on the disc.

## Recording one track from a source

If you want to record just a single track, or a few selected tracks, from a digital (CD, MD, DCC or DAT) or an analog source, the recorder can start and stop automatically. With digital recording, there's no need to worry about recording levels—you'll get a perfect digital copy of the original (if you want to change the digital recording level, see pages 23).

If you are recording from a noisy analog source, such as a vinyl record, or from a source with long quiet sections, the recorder may not recognize the end of the track. In this case, we recommend using manual recording (see pages 22).

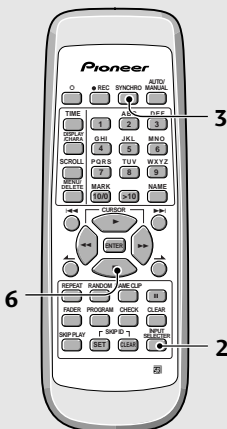
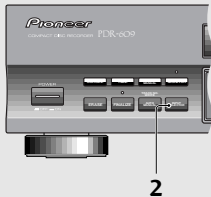
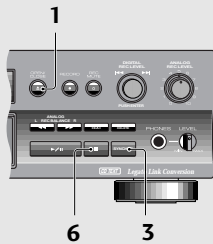

### 1 Load a CD-R or CD-RW disc.

Check the display to make sure that there's enough space on the disc for what you want to record.

### 2 Press INPUT SELECTOR to choose an input.

Pressing **INPUT SELECTOR** repeatedly switches the active input:

#### Analog - Optical - Coaxial

The recorder's display indicates the current input.

### 3 Make sure that the source is not playing, then press SYNCHRO.

Press **SYNCHRO** repeatedly to change the recording mode:

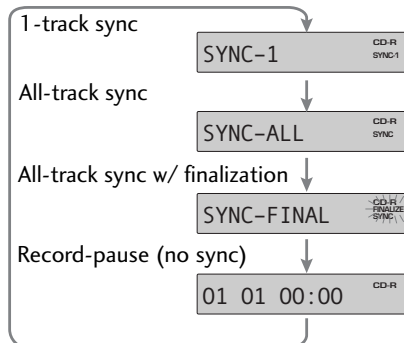

Synchro recording will not work if the source is already playing!

The **SYNC-1** indicator will start to blink when the recorder is ready.

SYNC-1



The display shows the 1-track sync mode, with the **SYNC-1** indicator blinking to show that recording can start.

### 4 Play the source.

The recorder starts recording automatically.

### 5 The recorder pauses recording after recording one track.

If you're recording a CD or MD, recording pauses automatically when the track changes or there is more than five seconds of silence on the source.

If you're recording from DCC or DAT tape, recording pauses when the recorder encounters a new start ID or there is more than five seconds of silence on the source. (See also *Digital recording from DAT* on page 18.)

If you're recording from analog, recording pauses automatically when there is more than two seconds of silence on the source.

### 6 If you're done, press ■.

To record further tracks, simply repeat steps 3 to 5.

After pressing **■**, the display shows **PMA REC** while it records the track information to the disc.

**Note:** If you want to record CD text information, you must record the entire disc (See *Automatically recording and finalizing a disk* on page 21). Text will not be copied when you record an individual track.

If you find that synchro recording does not seem to work, see the troubleshooting section on pages 40–42 for possible remedies.

## Recording all tracks from a source

If you want to copy all the tracks from a source, use this mode. Like the 1-track synchro recording mode, the recorder starts and stops automatically. When recording from MD or CD, you can play the source in either normal play mode, or program play if you'd like the recorded tracks in a different order to the original. We do not recommend recording from a DAT in program play mode—use the 1-track synchro recording mode if you want to record the tracks in a different order.

If you are recording from a noisy analog source, such as a vinyl record, or from a source with long quiet sections, the recorder may not recognize the end of tracks. In this case, you can still use this mode, but it may be better to use manual track numbering (see page 33).

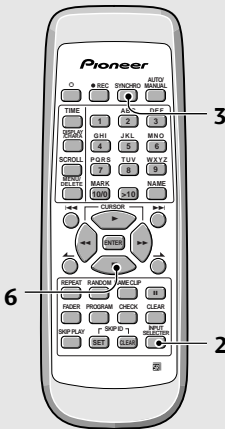
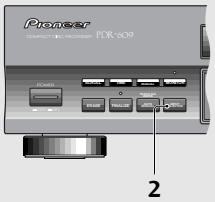
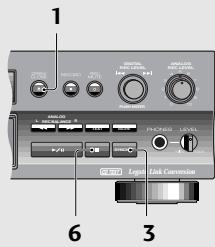

### 1 Load a CD-R or CD-RW disc.

Check the display to make sure that there's enough space on the disc for what you want to record.

### 2 Press INPUT SELECTOR to choose an input.

Pressing **INPUT SELECTOR** repeatedly switches the active input:

#### Analog - Optical - Coaxial

The recorder's display indicates the current input.

### 3 Make sure that the source is not playing, then press SYNCHRO twice.

Press **SYNCHRO** repeatedly to change the recording mode:

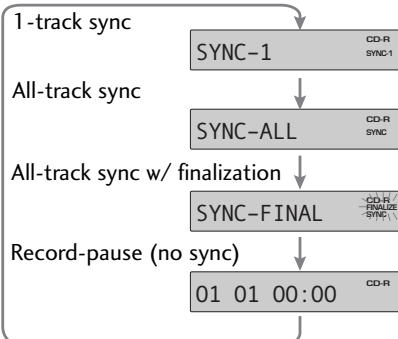

Synchro recording won't work if the source is already playing!

The recorder goes into all-sync record pause and the **SYNC** indicator starts to blink.



The display shows the all-track sync mode, with the **SYNC** indicator blinking to show that recording can start.

### 4 Play the source.

The recorder starts recording automatically.

### 5 After recording all tracks from the source, the recorder goes into record-pause.

After the recorder encounters about five seconds of continuous silence, it assumes the end of the source has been reached and goes into record-pause and the display shows the **SYNC ALL** message again.

**Be careful!** If the recorder detects another signal or start ID (DAT or DCC) it will start recording again!

- The recorder will enter record-pause if the digital signal is interrupted for more than 5 seconds—see *Digital signal interruptions* on page 18.

### 6 Press ■ to finish recording.

After pressing **■**, the display shows **PMA REC** while it records the track information to the disc.

**Note:** If you find that synchro recording does not seem to work, see the troubleshooting section on pages 40-42 for possible remedies.

## Automatically recording and finalizing a disc

This is a variation on all-track synchro recording on the previous page. After all tracks on the source material have been recorded, the recorder automatically finalizes the disc.

You can also copy CD text digitally as long as: it has not been copy-protected by the manufacturer; the disc you want to copy is not in program-play mode; you use a completely blank CD-R.

### 1 Load a CD-R or CD-RW disc.

Check the display to make sure that there's enough space on the disc for what you want to record.

### 2 Press INPUT SELECTOR to choose an input.

Pressing **INPUT SELECTOR** repeatedly switches the active input:

#### Analog - Optical - Coaxial

The display indicates the current input.

### 3 Make sure that the source is not playing, then press SYNCHRO three times.

Press **SYNCHRO** repeatedly to change the recording mode:

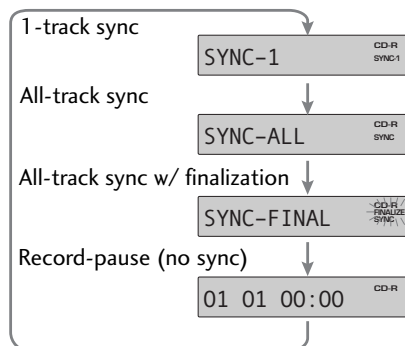

Synchro recording won't work if the source is already playing!

The recorder goes into all-sync record pause and the **SYNC** and **FINALIZE** indicators start to blink.

SYNC-FINAL



The display shows all-track sync with finalization, with the **SYNC** and **FINALIZE** indicators blinking to show that recording can start.

**Note:** If You want to record CD text information as well, press **NAME** after pressing **SYNCHRO**. The **CD TEXT** indicator will light.

### 4 Play the source.

Recording starts automatically.

If you press **SYNCHRO** during recording, the recorder will finish recording without finalizing the CD-R.

### 5 After recording all tracks on the source, the recorder starts finalizing the disc.

After the recorder encounters about five seconds of continuous silence, it assumes the end of the source has been reached and goes into all-sync record-pause.

**Be careful:** If the recorder detects another signal or start ID (DAT or DCC) it will start recording again!

If the recorder detects no signal for one minute, finalization starts (no more recording is possible after this so make sure that there aren't any spaces of more than one minute during the source you're recording). See *Automatically numbering tracks* on page 33 to set the silence threshold.

Finalization takes about two minutes, during which time none of the buttons are operative.

Never turn the power off during finalization!

- If a digital signal is interrupted, the recorder continues recording. However, if no signal has been detected within five seconds, the recorder pauses recording and will not finalize the disc—see *Digital signal interruptions* on page 18.

- If the recorder reaches the end of the disc, the recorder begins finalization.

**Note:** If you find that synchro recording does not seem to work, see the troubleshooting section on pages 40–42 for possible remedies.

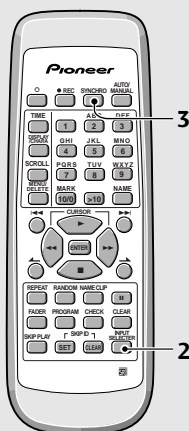
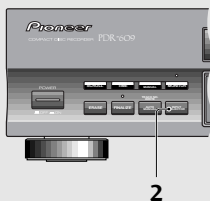

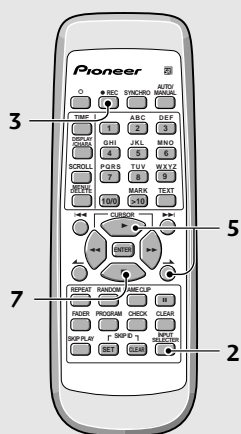
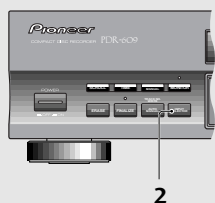
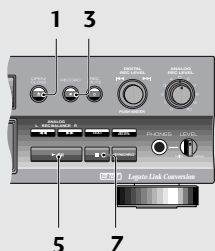

## Manual recording

Use the manual recording method with a source where syncho recording is not suitable. For example, if you are recording from either radio, or a digital satellite, synchro recording is not possible since there are no track numbers or start IDs to signal the start and end points of the recording. Manual recording is also useful with a noisy analog source, such as a vinyl record, or from a source with long quiet sections, where the recorder may not recognize the end of tracks.

### 1 Load a CD-R or CD-RW disc.

Check the display to make sure that there's enough space on the disc for what you want to record.

### 2 Press INPUT SELECTOR to choose an input.

Pressing **INPUT SELECTOR** repeatedly switches the active input:

#### Analog - Optical - Coaxial

The recorder's display indicates the current input.

### 3 Press RECORD ● (● REC on the remote control).

The recorder goes into record-pause. The (You can also press **MONITOR**.)

### 4 Start playing the source to check it's recordable.

With a digital source, if the source is copy-protected using SCMS, the message **Can't COPY** appears. In either case, you won't be able to record digitally—use the analog inputs instead.

If necessary, set the recording level (see pages 23).

If the signal appears OK, stop the source.

### 5 Check that the time display reads 00:00, then press II or ► (►/II on the front panel) to start recording.

If you pressed **MONITOR** in step 3, you'll need to press **RECORD ●** here, then **II** or **► (►/II)** to start recording.

### 6 Restart playback of the source material.

If the **AUTO TRACK** indicator is lit in the display then the recorder will start a new track each time it detects a sound after at least two seconds of continuous silence. (To switch off auto track numbering see *Manually numbering tracks* on page 33.)

### 7 When you're done, press ■.

After pressing **■**, the display shows **PMA REC** while it records the track information to the disc.

## Setting the digital recording level

One of the advantages of digital-to-digital recording is that you don't have to set recording levels—and risk distortion by overloading the disc. If you're recording commercial material from CD or MD, the digital level has already been optimized and you don't need to change it. If you're making a digital copy of a CD, DAT or MD that was not commercially produced and that was consistently under-recorded, you can boost the overall level by up to +20dB. Remember though, that any peaks in the original recording run the risk of distorting the copy.

If you record digital satellite broadcasts, you may also have cause to boost the recording volume since the volume of some broadcasts is relatively low, but again, if there are any peaks in the broadcast, you run the risk of momentary distortion.

It's also possible to reduce the digital recording volume, but in most cases, this is not desirable. However, if you're putting together a mix CD (various tracks compiled from different sources), and there is a track which stands out as generally louder than the others, then you might want to reduce the level of that track. Note that this feature will not get rid of distortion on the source material.

Once changed, the new digital recording level remains until you change it again, or reset it. Each digital input has its own level which can be set independently.

**NOTE:** If you are recording DTS encoded audio CDs or HDCD format CDs, the digital recording level must be set to 0.0dB for recording.

### 1 Make sure one of the digital inputs is selected.

Pressing **INPUT SELECTOR** repeatedly switches the active input:

#### Analog - Optical - Coaxial

The recorder's display indicates the current input.

### 2 Make sure the recorder is stopped, then press **RECORD** (● **REC** on the remote control).

The recorder goes into record-pause. (You can also press **MONITOR**.)

### 3 Press **MENU/DELETE**.

### 4 Turn the jog dial until **D. VOL** appears in the display, then press to **ENTER**.

If there is nothing connected to the selected digital input, the message **DIN UNLOCK** appears in the display. The display shows current digital recording level.

D. VOL 0.0dB

### 5 Turn the jog dial or press **◀◀** or **▶▶** on the remote control to adjust the recording level up or down.

- The maximum adjustment possible is between **MIN**(silence) and +20dB.
- Pressing the jog dial (**ENTER**) and holding for 3 seconds resets to 0dB.

### 6 Press the jog dial (**ENTER**) to confirm the digital recording level.

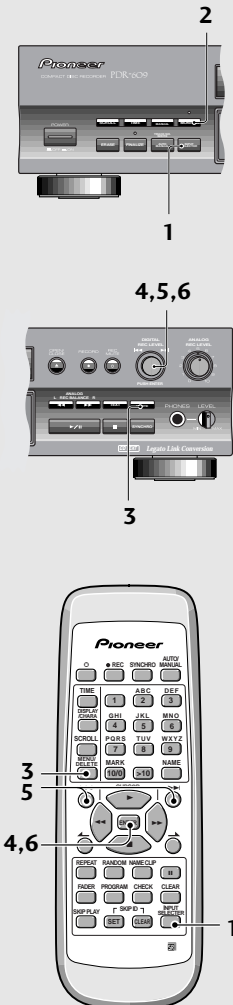

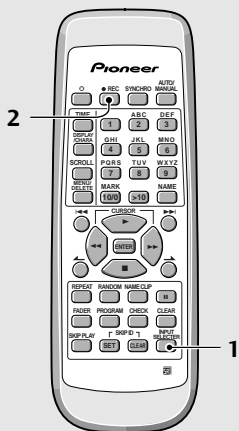
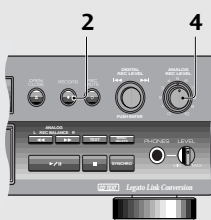
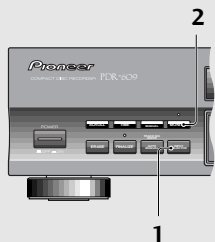

## Setting the analog recording level

Compared to analog tape, the distortion that you get from overloading a CD is much less tolerable, and something you'll definitely want to avoid.

What you want to aim for is a level where the loudest sound from your source material is recorded onto the CD at a level just below the point where it overloads (where it produces an unpleasant, buzzy distortion).

### 1 Press INPUT SELECTOR to choose the analog input.

Pressing INPUT SELECTOR repeatedly switches the active input:

#### Analog - Optical - Coaxial

The recorder's display indicates the current input.

### 2 Make sure the recorder is stopped, then press RECORD ● (● REC on the remote control).

The recorder goes into record-pause. (You can also press MONITOR.)

### 3 Start playing the source.

### 4 Adjust the recording level using the ANALOG REC LEVEL control.

Don't let the recording level to reach the red OVER indicator!

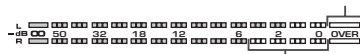

The maximum recording level should be in this area.

When you're happy with the recording level, stop the source.



## Setting the balance

You can increase the relative volume of the right or left channel for both recording and playback. However, it is generally not necessary to change the balance of a commercially recorded source.

- 1 Press **INPUT SELECTOR** to choose an input.

Pressing **INPUT SELECTOR** repeatedly switches the active input:

### Analog - Optical - Coaxial

The recorder's display indicates the current input.

- 2 Make sure the recorder is stopped, then press **RECORD** (● **REC** on the remote control).

The recorder goes into record-pause. (You can also press **MONITOR**.)

- 3 Press **MENU/DELETE**.

- 4 Turn the jog dial until **BALANCE** appears in the display, then press to **ENTER**.

- 5 Adjust the balance using the **REC BALANCE** buttons (◀◀ and ▶▶).

You can adjust the balance from 0dB (default) to around 5dB in either direction for digital recording, and up to around 7dB for analog recording.

- Pressing the jog dial (**ENTER**) and holding for 3 seconds resets to center position.

- 6 Press the jog dial (**ENTER**) to confirm the balance.

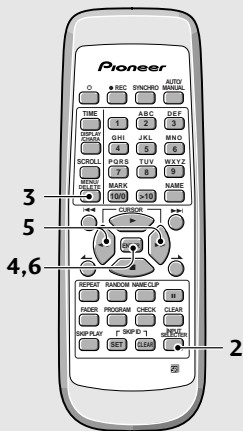
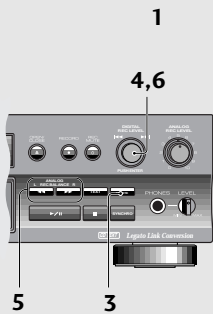
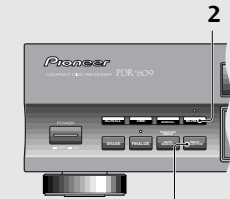

## Finalizing a disc

Before you can play a CD-R on an ordinary CD player, the disc must go through a process called finalization. Once finalized, a CD-R disc is no longer recordable, nor will you be able to set or clear skip IDs. Finalization is not reversible for CD-Rs so be absolutely sure that everything on the disc is the way you want it before you start.

CD-RW discs can also be finalized, although you can still erase the disc afterward and reuse it, so it's not anything like as final as it is with a CD-R disc. A finalized CD-RW disc can only be played on a CD player that is compatible with CD-RW discs (at present, these are very few).

### Caution!

Finalization takes a couple of minutes. During this time never switch off the power to the unit—the disc may become unusable as a result.

#### 1 Load the CD-R or CD-RW you want to finalize.

Check that the disc is free from dust, dirt and scratches—if necessary, clean the disc, following the guidelines on page 8.

#### 2 Press FINALIZE.

The **FINALIZE** indicator lights. After a short while you should see a display something like this:

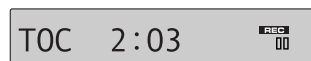

The display shows how long finalization will take—the exact time taken depends on the disc.

Press ■ here to cancel finalization.

#### 3 Press II (▶/II) on the front panel) to start finalization.

Finalization takes about two minutes; you'll see how long there is still to go in the display. The player stops when finished.

For a CD-R, the CD-R indicator now changes to simply CD.

For a CD-RW, the finalize indicator lights in the display.

None of the controls on the player or the remote have any effect during finalization. If, however, the recorder hasn't managed to finalize the disc within 10 minutes, you can abort the operation by pressing ■. If you do this, the disc won't be playable on an ordinary CD player.

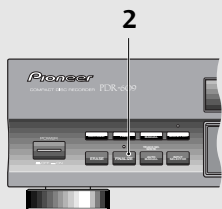

## Programming the track order

Programming the track order means telling the player precisely which tracks, and in what order, you want played. You can program a playlist of up to 24 tracks, playing tracks more than once if you like.

The playlist you program applies only to the disc in the player at the time: as soon as you eject that disc the playlist is lost.

- 1 Make sure the player is stopped, then press PROGRAM.** The PGM indicator lights and the display prompts you to enter the first track in the program:



As you program tracks, the total running time of the program is displayed here.

- 2 Enter the track numbers in the order you want them played.**

There are three ways to enter track numbers:

- **Using the number buttons**

For track numbers 1 to 10, use the corresponding number button.

For track numbers over 10, press the >10 button, then enter the track number. For example, to select track 28:



- **Using the track skip buttons**

Use the ◀◀ and ▶▶ buttons to select a track; press PROGRAM to enter it into the playlist.

- **Using the jog dial**

Turn the jog dial to select a track; push to enter it into the playlist.

- 3 Press ▶ (▶/II on the front panel) to start playback.**

You must press PROGRAM if you want to enter another track after you have started playback.

## Clearing the playlist

Since the program only applies as long as the disc is in the player, you can clear it by simply ejecting the disc. Alternatively, press ■ while the disc is stopped.

## Clearing a track from the playlist

Delete the last (most recently) programmed step by pressing CLEAR. Press repeatedly to clear several steps (if the program is playing while you're doing this, you can't clear steps beyond the one that is currently playing).

## Checking what's in the playlist

While the disc is stopped, you can check the contents of the playlist using CHECK on the remote control. Each press steps through the playlist, showing the step number and the corresponding track number.



Programmed step number

Programmed track number

## Replacing a track in the playlist

While checking the playlist (see above), you can change the track number for the step you're on using either the number keys, the ◀◀ and ▶▶ buttons, or the jog dial.

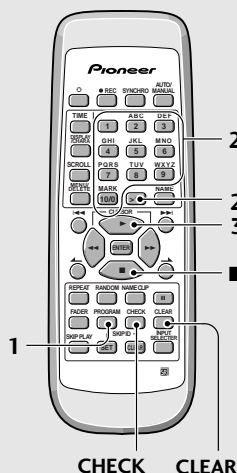
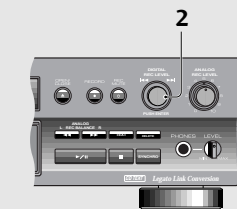



RANDOM

REPEAT

## Playing tracks at random

Selecting random play leaves the track order of the disc up to the player. Each track on the disc is played just once, but in a random order.

**Press RANDOM during playback or when the disc is stopped.**

The **RDM** indicator lights up in the display and random playback starts.

- Pressing **■** cancels random play.

## Repeating tracks

Using the repeat play function you can repeat either the current track over and over, or the entire disc.

- **To repeat the current track, press REPEAT once.**

The **RPT-1** indicator lights up in the display and the current track repeats until you either press **■**, or press **REPEAT** twice. Either way, repeat is canceled.

You can use repeat track in normal, program or random play modes.

- **To repeat the whole disc, press REPEAT twice.**

The **RPT** indicator lights up in the display and the CD repeats until you press either **■** or **REPEAT** again (in which case the disc continues playing to the end, then stops).

You can use repeat disc in normal, random or program play modes.



FADER

SKIP PLAY

## Fading in and fading out

Use the fader feature to fade the volume down gradually and pause playback, or to have the player fade in the volume when you resume playback. You can also set the length of time over which you want to fade in or fade out (See *Setting the fade length* on page 34).

**Note:** You can only hear the fades through the analog outputs.

- 1 **Press FADER during playback to pause the disc.**

The fader indicator in the display blinks and the volume fades to zero. The player then pauses playback.

- 2 **Press FADER to resume playback of a paused disc.**

The fader indicator in the display blinks and the volume starts to fade in.

## Playing a disc with skip IDs

If you're not sure whether a disc has skip IDs programmed, look for the **SKIP ON** indicator in the display when you load a disc—it will light automatically if one or more are present.

- 1 **Load a disc.**

The **SKIP ON** indicator lights up if there are any skip IDs on the disc. This means the player won't play those tracks that are marked by skip IDs.

- 2 **Press SKIP PLAY to switch skip play on/off, then press ► (►/II on the front panel).**

When you turn off skip play, the player ignores the skip IDs and plays all tracks on the disc.

- If there were no skip IDs on the disc in the first place, the **SKIP PLAY** button has no effect.

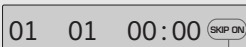

The **SKIP ON** indicator lights if there are skip IDs present on the disc.

## Skipping unwanted tracks

Although you can't erase tracks on a CD-R disc, you can set what are called 'skip IDs'. These tell a CD player (though not all recognize skip IDs) not to play a particular track, and to skip to the next one on the disc.

You can also set skip IDs on CD-RWs, although it's probably a less useful feature since erasing the last track is possible should you make a mistake in recording.

If you make a mistake when setting a skip ID, you can clear it, but be careful: you can set up to 21 skip IDs per disc, but repeatedly setting and clearing skip IDs will reduce this number.

## Setting skip IDs

- 1 Press **SKIP ID SET** during playback (or paused playback) of the track you want to skip.

If there's no room left on the disc to record another skip ID, the display will show the message **FULL**.

- 2 The display prompts you to confirm.

Press **SKIP ID SET** again to confirm. To cancel, press either **SKIP ID CLEAR** or **▶/||**.

- Use the **◀◀** and **▶▶** buttons/jog dial to skip to other tracks that don't have skip IDs set. When you press **SKIP ID SET**, it will be for the track that is currently playing.
- If there's no room left on the disc to record a skip ID, the display will show the message **SKIP FULL**.

- 3 Set further skip IDs by repeating steps 1 and 2.

- 4 When you're finished, stop the disc and press **OPEN/CLOSE**.

Until you eject the disc, the recorder stores the skip ID information in its memory. On pressing **▶**, the recorder writes the skip ID information onto the disc.

- 3 The display prompts you to confirm.

Press **SKIP ID CLEAR** again to confirm. To cancel, press either **SKIP ID SET** or **▶/||**.

- Use the **◀◀** and **▶▶** buttons/jog dial to move between tracks that have skip IDs set. When you press **SKIP ID CLEAR**, it will be for the track that is currently playing.
- If there's no room left on the disc to clear a skip ID, the display will show the message **SKIP FULL**.

- 4 Clear further skip IDs by repeating steps 2 and 3.

- 5 When you're finished, stop the disc and press **▶**.

Until you eject the disc, the recorder stores the changes in skip ID information in its memory. On pressing **▶**, the recorder writes the new skip ID information onto the disc.

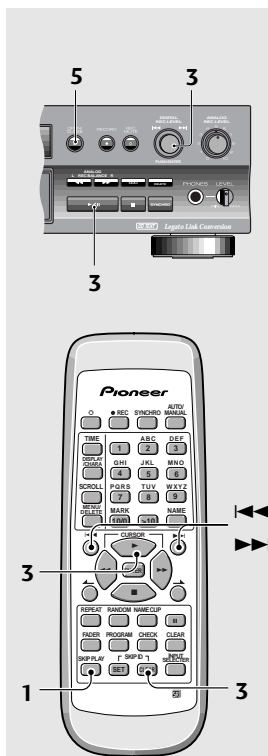
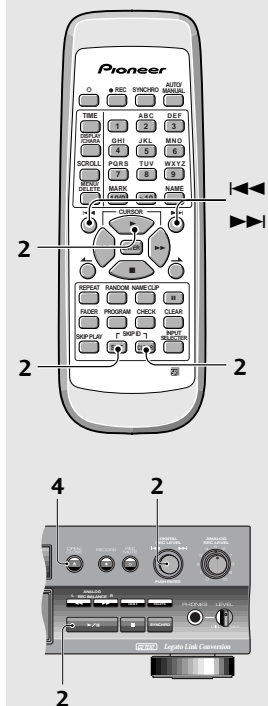

## Clearing skip IDs

- 1 Press **SKIP PLAY** to switch off skip play mode.

The **SKIP ON** indicator in the display disappears.

- If the **SKIP ON** indicator did not light up when you loaded the disc then there are no skip IDs present on that disc.

- 2 Press **SKIP ID CLEAR** during playback (or paused playback) of the track you no longer need a skip ID for.

If this track doesn't have a skip ID, the player jumps to the next track that does and starts playback of that track.

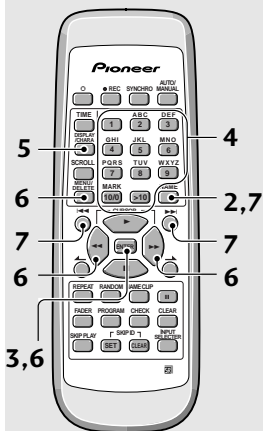
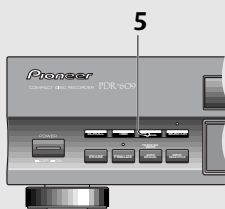
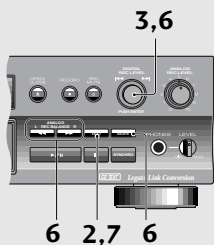

0! " # \$ % & ' ( ) \* + , - . / < = > ? @ [ ] ^ \_ ' { } <space>

## Using CD text

You can name a CD-R or CD-RW so that when you load the disc into the player, the disc name, track title, or artist name can appear in the display. Each title can be up to 120 characters long, including spaces. You can store all the text (up to 2000 characters) for up to three non-finalized discs in the recorder at one time. This is useful when you want to edit the text during another recording session with the same disc.

**Be careful:** When you set text for a fourth disc, the oldest text information (for the first disc) is deleted from memory. Text with CD-RW discs is deleted when you erase the corresponding track.

Once you finalize a CD-R, the text information cannot be changed. Finalized CD-Rs containing CD text can still be played on ordinary (non-CD text compatible) CD players, however the CD text will not appear in the display.

### 1 Make sure the disc you want to name is loaded into the recorder and is stopped.

**For track names:** Before proceeding to step 2, you must choose the track you want to name by turning the jog dial. You can also name tracks during playback.

### 2 Press NAME.

Press **NAME** to switch between disc and artist name:

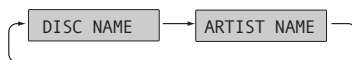

### If you are naming a track, go to step 3.

The default is disc title. Press **■** at any time to exit.

### 3 Wait two seconds after making your selection, or press ENTER.

If the disc doesn't already have a name, the character display is blank, with a blinking cursor on the first character.

If the disc is already named, the character display shows the name (or the first 12 characters if it is too long to be displayed completely), with a blinking cursor under the first character.

### 4 Select/change the character at the current cursor position by turning the jog dial.

See below for the complete list of letters, numbers, and symbols available.

If you're using the remote control, use numbers keys 1-9 for numbers and the letters shown above each key. Press a key repeatedly to cycle through the letters and numbers on that key.

Characters available for disc and track names:

**ABCDEFGHIJKLMNOPQRSTUVWXYZ**

**abcdefghijklmnopqrstuvwxyz**

**1234567890**

**!"#\$%&'()\*+,-./<=>?**

**@[]^\_ '{ } <space>**

### 5 Change between uppercase, lowercase, and numbers/symbols by pressing DISPLAY/CHARA.

The case of the character at the current cursor position changes between upper- and lowercase and numbers/symbols with each press.

### 6 Confirm the character and move the cursor to the next character position by pressing the jog dial (or ►►).

For the remote, move the cursor to the next character position by pressing **ENTER**.

- Move the cursor backwards or forwards along the display using **◀◀** and **►►**.
- Insert a new character into a name by moving the cursor to the character position you want and repeating steps 4-6.

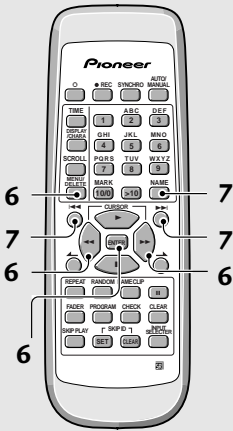
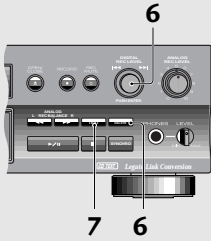

- Erase the character at the current cursor position by pressing **MENU/DELETE**.

The characters on either side of the current cursor position close to fill up the gap.

## 7 Press NAME again to enter the text and return to the title selection display.

If you are inputting a track title, you must assign it to a track number using **◀◀** or **▶▶**, or the corresponding number on the remote control. Pressing **NAME** twice takes you back to the previous menu (step 2).

**Note:** After you have finished setting the names you want in CD text, be sure to eject the disc or, if you have finished all the recording and editing that you want to do, finalize the disc as shown on page 26.

## Editing CD text

The CD recorder can store information for up to three discs at one time. When an unfinalized CD-R containing CD text is loaded, this text will automatically return to memory. Before finalizing the CD-R, you can go back and edit the text as many times as you like, or until you input CD text for a fourth disc (this will erase the oldest information in memory).

### 1 Load the CD-R or CD-RW you wish to edit.

### 2 Press NAME.

Choose the name you wish to edit as in steps 1–3 of *Using CD text*.

### 3 Edit the text.

See step 6 of *Using CD text*.

### 4 Eject or finalize the disc.

See *Finalizing a disc* on page 26 if you have finished all the recording and editing that you want to do.

## Copying track names to other tracks

If you need to name several tracks with similar names—several parts of one suite, for example—you can name the first one using the procedure detailed above, then simply copy that name to the other tracks and edit them as required. This can save you a lot of time over naming each track individually. The recorder stores the last three names you've copied using the name clip function in its memory (up to 40 characters each). When you copy another track name, the oldest one is deleted from memory.

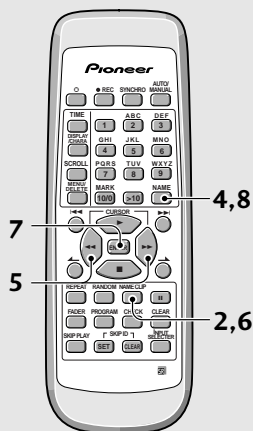

### 1 Go to the track with the name you want to copy.

Use one of the usual methods—track skip, direct selection, etc.

### 2 Press NAME CLIP to copy the currently displayed into memory.

The display should confirm that the track name has been copied.

- You cannot copy the names of commercially recorded discs.

### 3 Go to the track that you want to copy the name to.

### 4 Press NAME to start editing the current track name.

### 5 Move the cursor to the position you want to insert the copied name.

Use the ◀◀ and ▶▶ buttons to move the cursor around the character display.

### 6 Press NAME CLIP again.

The most recently clipped name appears.

### 7 Use the jog dial to select one of the previous three names stored, then press the jog dial (ENTER).

On the remote, use the ◀◀ and ▶▶ buttons to select a name, then press ENTER.

The display flashes **Name Insert** briefly and the selected name is inserted at the point you chose.

- Edit the name further if necessary.

### 8 Press NAME to leave the track name mode.



## Automatically numbering tracks

If you're recording from CD, MD, DCC or DAT, you can usually let the recorder number the tracks automatically as they change on the source material. When recording other digital or analog sources, the recorder will start a new track if it detects more than 2 seconds of silence. However if you're recording a noisy vinyl record or a classical recording with long quiet sections, the recorder may not always recognize the gap between tracks. For this reason you can adjust the level of sound that the recorder regards as 'silence'.

Each input (analog, coaxial and optical) has its own threshold level, which can be set independently.

**Note:** The minimum analog threshold level is **-66dB**.

- 1 When the recorder is stopped, press **MENU/DELETE**.
- 2 Turn the jog dial until **A.LVL** appears in the display, then press to **ENTER**.

The display shows the current 'silence' threshold for automatic track numbering. The default is **-54dB**.

- 3 Turn the jog dial (**◀◀** and **▶▶** on the remote) to change the threshold level.

Turning the dial cycles through the following levels:

**-78dB to -66dB** – Use these levels if you find the recorder is putting in new track numbers during very quiet sections of classical music, for example.

**-60dB to -48dB** – A 'mid' level suitable for most recordings.

**-42dB to -24dB** – If you find that the recorder is not putting in new track numbers because the original source is too noisy.

- 4 Press the jog dial (**ENTER**) to confirm the new level.

If the **AUTO TRK** indicator is not lit, press **AUTO/MANUAL** to switch it on. To check that tracks will start at the correct points on the recording, see *Monitoring a source* on page 36.

- 2 Start recording.

You can use manual numbering in any record mode, but it is best suited to manual digital-input or analog-input recording (see page 18 for more on these recording modes).

- 3 Press **RECORD** ● at any point you want a new track to start.

CD tracks must be at least four seconds long—the recorder won't let you start a new track less than four seconds into the current track.

## Manually numbering tracks

Although automatic track numbering is the default mode of the recorder, you can number tracks manually as recording is taking place. In some cases—such as recording from digital satellite or Laserdisc, or from an analog source—auto track numbering may not work reliably (in these cases, a new track is started after the recorder detects two seconds of silence), and it's better to use manual track numbering.

**Remember:** It is not possible to edit track numbers after recording.

- 1 Make sure automatic track numbering is switched **OFF**. If the **AUTO TRK** indicator is lit, press **AUTO/MANUAL** to switch it off.

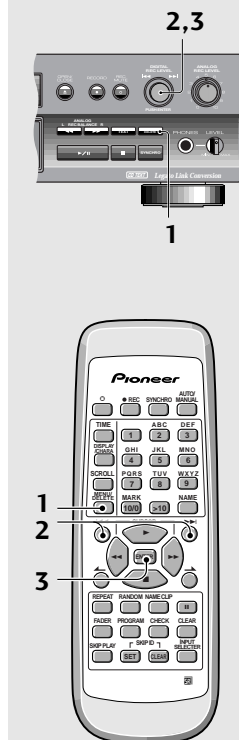

## 6 More recording features

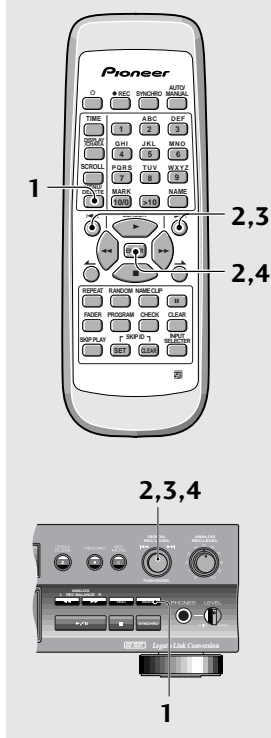

### Starting tracks in time increments

If you aren't able to set track numbers automatically during recording (a radio program with interviews, for example), you might want to have the recorder start tracks after every three minutes or so. This will make it easier to listen back to sections of the recording at a later date. You can set the time to one, three, or five minutes.

**Note:** The time increment will default to **OFF** when: recording is stopped; auto track numbering is turned off; power is turned off.

- 1 When the recorder is stopped, press **MENU/DELETE**.
- 2 Turn the jog dial (◀◀ and ▶▶ on the remote) until **T. INC.** appears in the display, then press to **ENTER**.  
The display shows the current time increment: one, three, five minutes, or **OFF**. The default is **OFF**.
- 3 Turn the jog dial (◀◀ and ▶▶ on the remote) to change the time increment.
- 4 Press the jog dial to **ENTER**.

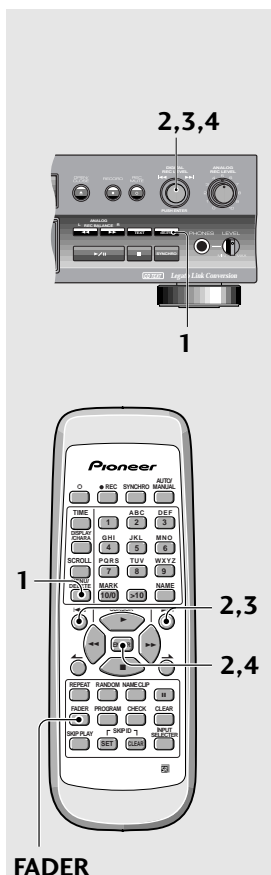

### Recording fade ins and fade outs

Sometimes, for example if you're recording just an excerpt from something, it may be better to fade in the recording, then fade out again at the end, rather than start and end abruptly. You can also set longer or shorter fade times so that they match the fades on other songs in your mix. Note that you can't record a fade in when in synchro recording mode (although you can record a fade out).

### Setting the fade length

- 1 Press **MENU/DELETE**.
- 2 Turn the jog dial until **FADER** appears in the display, then press to **ENTER**.
- 3 Use the jog dial (◀◀ and ▶▶ on the remote) to set the length of the fade (in seconds). Each turn will take you forward (or back) one second. The default is 5 seconds.
- 4 Press the jog dial (**ENTER**) to confirm the new fade length.

### Recording a fade in

- With the source playing, press **FADER** during record-pause mode to fade in. Recording starts with a gradual fade in.

### Recording a fade out

- Press **FADER** during recording to fade out.  
After recording the fade out, the recorder goes into record-pause mode. This happens in either normal or synchro record mode.
- You can also just press ■ if you don't need a fade out.

If you record a fade out during all-track sync mode, the synchro mode is canceled after the fade out (see pages 19–21 for more on synchro recording).

**Note:** If the recorder runs out of recording space on the disc before the source has finished, it will automatically record a fade out and stop recording.

### 1 While recording or during record-pause mode, press **○ REC MUTE**.

A blank space of about four seconds is recorded, then the recorder goes into record-pause mode.

- If you press and hold **○ REC MUTE**, you can record a blank for as long as you hold down the button.
- Pressing **○ REC MUTE**, (without holding) in record-pause mode records four seconds of silence from the current position. Use this to create a space between tracks when recording in 1-track synchro mode, for example.

### 2 Press **■** to finish the recording session.

## Recording blank sections

This feature is useful wherever you need some blank space recorded on the disc, for instance, at the end of a recording session so that the next track doesn't follow the last too closely. Note that you can't start a recording with a muted section; only after a recording has started, or at the end of a recording.

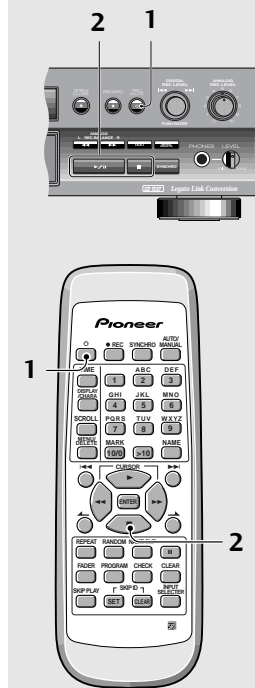

## Checking what's at the end of a disc

You don't have to record a whole disc at once. Until you finalize the disc, further recording is possible from the end of the last track you recorded (assuming there are fewer than 99 tracks already on the disc). Here's how to check what's on the last recorded section of the disc before recording new material:

### 1 Press **● RECORD**.

The recorder goes into record-pause mode.

### 2 Press and hold **◀◀**.

You'll hear the last recorded track in reverse. Release the button and the track plays normally to the end.

While the track is playing you can use the **◀◀** and **▶▶**.

If you press **● RECORD** again while the track's playing, the recorder jumps to the end of the track and goes into record-pause.

When the track has played out, the recorder automatically enters record-pause again.

### 3 Once the player is back in record-pause mode you can go ahead and record normally.

If you decide you don't want to record, just press **■**.

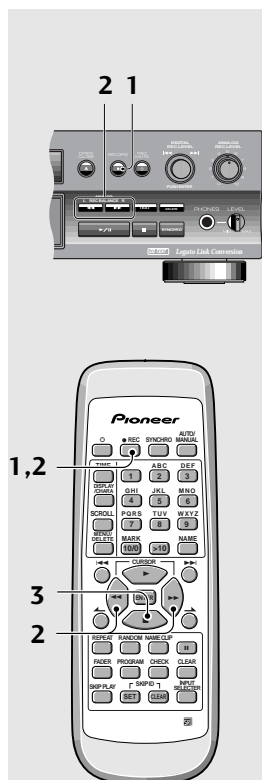

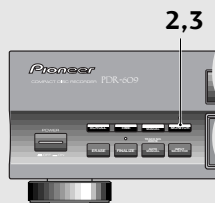

### Monitoring a source

When recording, or in record-pause mode, the source signal is always available for monitoring through a connected amplifier or through a pair of headphones plugged into the PDR-609's phones jack. Even if you're not recording, you can still monitor—useful for cueing up for the next recording and also for checking that tracks are starting in the proper places during automatic track numbering.

#### 1 Start the source component playing.

Make sure that the input selector is set to the correct input.

#### 2 Press MONITOR.

The indicator above the **MONITOR** button lights up.

If the source is copy protected, the message **Can't COPY** appears (see the following page for more on this).

- When automatic track numbering has been selected, the **TRACK** indicator will light for 2 seconds at track start points. See *Automatically numbering tracks* on page 33 if you find the recorder can't recognize the gaps between tracks.
- When monitoring through a digital output, you cannot hear changes you make in the recording level or balance.

#### 3 To switch off monitoring, press MONITOR again.

The monitor indicator switches off.

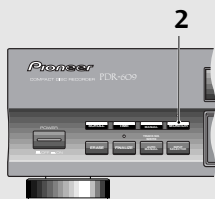

### Checking for digital copy protection

Using the **MONITOR** button, you can also check whether or not a digital source is copy-protected with SCMS (Serial Copy Management System). SCMS allows you to make digital copies of original sources for your own use, but prevents further digital copies being made from the copy (see page 27 for more on SCMS).

#### 1 Start playing the digital source.

Make sure that the input selector is set to the correct digital input.

#### 2 Press MONITOR.

The display shows **Can't COPY** if the source is digital-copy protected.

- Press **MONITOR** again to switch monitoring off.

## Erasing a CD-RW disc

Although more expensive than CD-R discs, the great advantage of CD-RW is that the discs can be erased and reused. Various erase options are available depending on whether the disc has been finalized.

A third, special option, erases (re-initializes) the whole disc. This process takes quite a long time to complete and should be used for recovering damaged discs, not for erasing tracks from a healthy disc.

### Caution!

Never switch off the power during CD-RW erasing - your disc may become unusable.

If the message **CHECK DISC** appears any time during any erase process, press **▲**, take out the disc, clean it, then try the erase command again.

Be sure to remove the disc from the recorder before switching off the power, otherwise the erase operation will not be completed.



## When a non-finalized disc is loaded

### 1 Press **ERASE**.

The display shows **ERASE LAST?**.

- Press **■** to cancel last track erase here.

### 2 Use the jog dial or press **◀◀** and **▶▶** on the remote control to change the erase option.

Switch between:

**ERASE LAST?** – erase just the last track

**ERASE ALL?** – erase all tracks

**ERASE 02-[LAST TRACK]?** – erase track 2 and all subsequent tracks

**ERASE 03-[LAST TRACK]?** – erase track 3 and all subsequent tracks

Keep turning the jog dial or press **◀◀** and **▶▶** on the remote control to change the number of tracks to erase.

### 3 Press **II** (**▶/II** on the front panel) to start erasing.

The process takes just a few seconds.

During this time, the function indicator lights.

### 4 Eject or finalize the disc.

You must eject, then re-insert the disc if you want to record any new tracks. See *Finalizing a disc* on page 26 if you have finished all the recording and editing that you want to do.



### When a finalized disc is loaded

**Be careful:** When you erase the TOC, the CD text information for the disc is also copied to memory for editing purposes, erasing the oldest text information stored (as explained on page 30).

- 1 Press ERASE.**  
The display shows **ERASE TOC?**.  
Press ■ to cancel erase here.
- 2 Use the jog dial or ◀◀ and ▶▶ buttons on the remote control to change the erase option.**  
Switch between:  
**ERASE TOC?** – erase the table of contents (returns disc to a non-finalized state)  
**ERASE ALL?** – erase all tracks
- 3 Press II (▶/II on the front panel) to start erasing.**  
The function indicator lights and the display shows **ERASE**, and the time remaining to completion.  
You can halt this erase process by holding down the ■ button for 10 seconds.
- 4 Eject the disc.**  
You must eject, then re-insert the disc if you want to record any new tracks.

### Reinitializing a disc

- 1 Press and hold ERASE for about four seconds.**  
The recorder prompts you to confirm with the message **INITIALIZE?**.  
Press ■ to cancel all disc erase here.
- 2 Press II (▶/II on the front panel) to start erasing.**  
The process takes about 40 minutes, depending on the disc. During this time, the display shows **ERASE**, followed by the remaining time to completion.  
You can halt this erase process by holding down the ■ button for 10 seconds.
- 3 Eject the disc.**  
You must eject, then re-insert the disc if you want to record any new tracks.

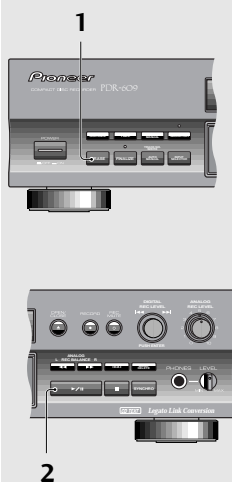

## Understanding display messages

Below is a list of messages you'll see during normal operation of the PDR-609 together with a brief explanation of what they mean. If you need more information, turn to the page indicated.

**Note:** In the table below, \*\* indicates a track number.

Message	Description	Reference
<b>TOC READ</b>	The recorder is reading the disc's TOC (Table of Contents). Wait for the message to disappear.	p. 15
<b>SYNC-1</b>	The unit is in 1-track automatic digital recording mode. Recording starts when the recorder detects the digital source input signal.	p. 19
<b>SYNC-ALL</b>	The unit is in all-track automatic digital recording mode. Recording starts when the recorder detects the digital source input signal.	p. 20
<b>PMA REC</b>	The recorder is writing TOC data to the disc's PMA (Program Memory Area). Never turn off the power while this display is showing.	
<b>** SKIP SET</b>	Confirm that you want to set a skip ID by pressing the <b>SKIP ID SET</b> button.	p. 29
<b>** SKIP CLR</b>	Confirm that you want to set a skip ID by pressing the <b>SKIP ID CLEAR</b> button.	p. 29
<b>ERASE LAST?</b>	Confirm that you want to erase the last track of a CD-RW disc by pressing ►/   (   on the remote control).	p. 37
<b>ERASE ALL?</b>	Confirm that you want to erase all tracks on a CD-RW disc by pressing ►/   (   on the remote control).	p. 37
<b>ERASE TOC?</b>	Confirm that you want to erase the TOC of a finalized CD-RW disc to return it to a non-finalized state. After doing this, you can record more material on the disc.	p. 38
<b>ERASE ** - ** ?</b>	Confirm that you want to erase tracks recorded on a CD-RW disc .	p. 37
<b>INITIALIZE?</b>	Confirm that you want to re-initialize the CD-RW disc by pressing ►/   (   on the remote control).	p. 38

### Troubleshooting

Below is a list of messages mainly related to playback and recording problems, together with a brief explanation and a page reference where you can find more information:

Display	Cause	Remedy
<b>CHECK DISC</b>	The disc is damaged or dirty.	Take out the disc and check for dust, dirt, scratches, etc. Clean as necessary.
	The disc is loaded upside down.	Take out the disc and reload it label-side up. If the same message is displayed again after the disc is reloaded, unplug the power cord and plug it in again. If the same message is still displayed, please contact a Pioneer authorized service center.
<b>CHECK (blinking display)</b>	A system error occurred, perhaps due to noise or static electricity.	Unplug the power cord and plug it in again. If the same message is displayed again, please contact a Pioneer authorized service center.

### Display messages relating to playback

Display	Cause	Remedy
<b>NEW DISC</b>	A blank disc is loaded.	Only recording is possible on blank CD-R or CD-RW discs. Playback is not possible.
<b>NO DISC</b>	An attempt is made to start playback without loading a disc.	Open the tray and check that a disc is loaded.



## Display messages relating to recording

**Note:** In the table below, \*\* indicates a track number.

Display	Cause	Remedy
<b>Can't COPY</b>	The input signal is digital-copy protected with SCMS.	Record the source through the analog inputs.
<b>Can't SYNC</b>	This appears when the <b>SYNCHRO</b> button is pressed when the input selector is set to a digital input, and the source selected is not recognized as CD, MD, DCC, or DAT.	Record the source manually, or record through the analog input.
<b>DIN UNLOCK</b>	The digital source was interrupted.  The source is not audio, or is an incompatible format (e.g. a CD-ROM).	Check that the digital input cable is connected properly and that the power of the source player is on. Check that the source is a regular music source.
<b>CHECK INPUT?</b>	The source player was already playing when the <b>SYNCHRO</b> button was pressed.	Stop the source player. After a short time, <b>SYNC-1</b> or <b>SYNC-ALL</b> is displayed, and the recorder goes into synchro-record-pause mode.
<b>** SET UP</b>	The unit is preparing to record.	Wait until the message disappears.
<b>REPAIR</b>	The recorder was switched off/unplugged after recording without ejecting the disc. The recorder could not write essential recording information onto the disc.	While <b>REPAIR</b> is displayed, the recorder automatically examines the recorded area of the disc and updates the track numbers and recording time data. This process takes about 40 minutes for a fully recorded disc. Finalization or further recording is possible once the <b>REPAIR</b> message disappears.
<b>REC FULL</b>	No more recording is possible because the available recording time of the disc has been used up, or 99 tracks have already been recorded on the disc.	Use another disc, or erase the CD-RW disc.
<b>pro DISC</b>	The loaded disc is a CD-R or CD-RW disc for professional use without the <b>CONSUMER USE</b> designation.	Load a CD-R or CD-RW disc that is designated as being for consumer use.

### If digital synchro-recording fails to operate correctly, check the following:

- Pause playback of the source, then press the DIGITAL SYNCHRO button again.
  - If you're recording from a portable CD player, etc., make sure that the shock-protection feature is switched off.
- Start playback of the source component once you see the SYNCHRO indicator start to blink.
- If none of the above solves the problem, use manual digital recording to record.
  - Digital synchro-recording uses a digital sub-signal contained in the source player's digital output. Digital synchro-recording will not work when recording from the following devices:
    - CD players whose digital output does not include a sub-signal
    - Portable CD, MD or DVD players which do not output a digital signal when stopped.

## 7 Additional information

It's often easy to mistake incorrect operation for trouble and malfunction of the unit. If you think there is something wrong with the component, check the points below first. If the problem persists, contact your nearest Pioneer-authorized service center and have them check over the unit.

Symptom	Cause	Remedy
<b>Power cannot be turned on.</b>	The power cord is unplugged from the wall outlet.  The power was turned off from the component (stereo amplifier, audio timer, etc.) to which it is connected.	Plug the power cord into a power outlet.  Turn on the component supplying the power to the recorder.
<b>No sound is heard during playback.</b>	The recorder is not connected up properly.	Check all connections, especially to the amplifier (p.10–11)
<b>Cannot record.</b>	The recorder is not connected up properly. The CD-R or CD-RW disc in use has already been finalized. The input selection is incorrect.  The analog <b>REC LEVEL</b> control is set too low.	Check all connections (p.10–11) Use a non-finalized disc or erase the CD-RW disc (p.36) Select the input connected to the source component you're recording from. Increase the recording level (p.23–24)
<b>Recorded sound is distorted.</b>	The analog <b>REC LEVEL</b> control is set too high.  Signal connections are incorrect. There is interference from a TV set.  The disc is damaged or warped. The disc is extremely dirty.	Reduce the analog recording level (p.24) Check all connections (p.10–11) Turn the TV power off or install this unit further away from the TV. Use another disc. Clean the disc.
<b>Remote control operation is impossible.</b>	The remote control batteries are exhausted.  There is an obstacle between the remote control unit and main unit. The remote control unit is being operated outside the remote controllable range.	Replace both of the remote control batteries with new ones. Remove the obstacle.  Operate in the remote controllable range (p.9)
<b>Some tracks are skipped without being played.</b>	The <b>SKIP PLAY</b> button is set to on	Set the <b>SKIP PLAY</b> button to off (p.28)
<b>Skip playback does not occur.</b>	The <b>SKIP PLAY</b> button is set to off.	Set the <b>SKIP PLAY</b> button to on (p.28)
<b>The recorder does not recognize the end of tracks during sync recording.</b>	The level that the recorder regards as 'silence' is set either too low, or too high.	Set the silence threshold to a suitable level for automatically numbering tracks (p.33)
<b>A recorded CD-R disc cannot be played on other CD players.</b>	The disc has not been finalized after recording. When such a disc is loaded, the CD-R indicator lights up. The pickup lens of the other CD player is dirty, impairing its ability to play CD-R discs.	Finalize the disc (p.26)  Try the disc on a different CD player. If it plays OK then get the pickup lens on the original player cleaned.

# Specifications

## 1 General

Model .....	Compact disc audio system
Applicable discs .....	CDs, CD-Rs and CD-RWs
Power supply .....	AC 120 V, 60 Hz (U.S and Canadian models) AC 220-240 V, 50/60 Hz (U.K model)
Power consumption .....	13 W (U.S and Canadian models) 14 W (U.K model)
Operating temperature .....	+5 °C to +35 °C (+41 °F to +95 °F)
Weight (without package) .....	3.5 kg (7 lb 12 oz)
Max. dimensions .....	420 (W) × 295 (D) × 105 (H) mm 16 9/16(W) × 11 10/16 (D) × 4 3/16 (H) in.

## 2 Audio unit

Frequency characteristics .....	2 Hz to 20 kHz
Playback S/N .....	108 dB (EIAJ) (U.S and Canadian models) 112 dB (EIAJ) (U.K model)
Playback dynamic range .....	98 dB (EIAJ)
Playback total harmonic distortion .....	0.002 % (EIAJ) (U.S and Canadian models) 0.0017 % (EIAJ) (U.K model)
Playback channel separation .....	98 dB
Recording S/N .....	92 dB
Recording dynamic range .....	92 dB
Recording total harmonic distortion .....	0.005 % (EIAJ) (U.S and Canadian models) 0.004 % (EIAJ) (U.K model)
Output voltage .....	2 V
Wow-flutter .....	Less than measurement limit (±0.001 % W.PEAK) (EIAJ))
Number of channels .....	2 channels (stereo)
Digital output:	
Coaxial output .....	0.5 Vp-p ±20 % (75 Ω)
Optical output .....	-15 to -21 dBm (wavelength: 660 nm) Frequency deflection: Level 2 (standard mode)

\*Recording specification values are for the LINE input (analog)

## 3 Input jacks

Optical digital input jack  
Coaxial digital input jack  
Audio LINE input jack  
Control IN jack

## 4 Output jacks

Optical digital output jack  
Coaxial digital output jack  
Audio LINE output jack  
Control Text jack

## 5 Accessories

- Remote control unit ..... 1
- Size AA/R6P dry cell batteries ..... 2
- Audio cord ..... 2
- AC power cord ..... 1
- Operating Instructions ..... 1
- Warranty card ..... 1

**NOTE :** The specifications and design of this product are subject to change without notice, due to improvements.

## [For U.S. and Canadian models only]

Should this product require service in the U.S.A. and you wish to locate the nearest Pioneer Authorized Independent Service Company, or if you wish to purchase replacement parts, operating instructions, service manuals, or accessories, please call the number shown below.

8 0 0 – 4 2 1 – 1 4 0 4

Please do not ship your product to Pioneer without first calling the Customer Service Department at the above listed number for assistance.

PIONEER ELECTRONICS SERVICE, INC.  
CUSTOMER SERVICE DEPARTMENT  
P.O. BOX 1760, LONG BEACH,  
CA 90801-1760, U.S.A.

For warranty information please see the Limited Warranty sheet included with your product.

Should this product require service in Canada, please contact a Pioneer Canadian Authorized Dealer to locate the nearest Pioneer Authorized Service Company in Canada.  
Alternatively, please contact the Customer Service Department at the following address:

Pioneer Electronics of Canada, Inc.  
Customer Service Department  
300 Allstate Parkway, Markham, Ontario L3R OP2  
(905) 479-4411  
1-877-283-5901

For warranty information please see the Limited Warranty sheet included with your product.

Si ce produit doit être réparé au Canada, veuillez vous adresser à un distributeur autorisée Pioneer au Canada pour obtenir le nom de la Société de Service Autorisée Pioneer le plus près de chez vous. Ou encore, veuillez communiquer avec le Service de Clientèle de Pioneer:

Pioneer électroniques du Canada, Inc.  
Département de service aux consommateurs  
300 Allstate Parkway, Markham, Ontario L3R OP2  
(905) 479-4411  
1-877-283-5901

Pour obtenir des renseignements sur la garantie, veuillez vous reporter au feuillet sur la Garantie Limitée qui accompagne le produit.

Published by Pioneer Corporation.  
Copyright © 2000 Pioneer Corporation.  
All rights reserved.

---

**PIONEER CORPORATION** 4-1, Meguro 1-Chome, Meguro-ku, Tokyo 153-8654, Japan  
**PIONEER ELECTRONICS [USA] INC.** P.O. BOX 1540, Long Beach, California 90801-1540, U.S.A.  
**PIONEER ELECTRONICS OF CANADA, INC.** 300 Allstate Parkway, Markham, Ontario L3R OP2, Canada  
**PIONEER EUROPE NV** Haven 1087, Keetberglaan 1, B-9120 Melsele, Belgium TEL: 03/570.05.11  
**PIONEER ELECTRONICS AUSTRALIA PTY. LTD.** 178-184 Boundary Road, Braeside, Victoria 3195, Australia, TEL: [03] 9586-6300  
**PIONEER ELECTRONICS DE MEXICO S.A. DE C.V.** San Lorenzo 1009 3er Piso Desp. 302 Col. Del Valle Mexico D.F. C.P. 03100  
TEL: 5-688-52-90

## Free Manuals Download Website

<http://myh66.com>

<http://usermanuals.us>

<http://www.somanuals.com>

<http://www.4manuals.cc>

<http://www.manual-lib.com>

<http://www.404manual.com>

<http://www.luxmanual.com>

<http://aubethermostatmanual.com>

Golf course search by state

<http://golfingnear.com>

Email search by domain

<http://emailbydomain.com>

Auto manuals search

<http://auto.somanuals.com>

TV manuals search

<http://tv.somanuals.com>