

Pioneer

Operation Manual

CD RDS RECEIVER

DEH-9300SD

Made for



iPod



iPhone



English

Thank you for purchasing this PIONEER product.

To ensure proper use, please read through this manual before using this product. It is especially important that you read and observe **WARNING**s and **CAUTION**s in this manual. *Please keep the manual in a safe and accessible place for future reference.*

01 Before You Start

- About this unit **3**
- In case of trouble **3**
- Demo mode **3**
- Reverse mode **4**
- Sound muting **4**
- About this manual **4**

02 Operating this unit

- Head unit **5**
- Optional remote control **5**
- Basic Operations **6**
- Menu operations identical for function settings/audio adjustments/initial settings/lists **6**
- Tuner **6**
- CD/CD-R/CD-RW and external storage devices (USB, SD) **9**
- iPod **11**
- Audio Adjustments **13**
- Initial Settings **15**
- Other Functions **16**

Additional Information

- Troubleshooting **18**
- Error messages **18**
- Handling guidelines **20**
- Compressed audio compatibility (disc, USB, SD) **21**
- iPod compatibility **23**
- Sequence of audio files **23**
- Copyright and trademark **23**
- Specifications **25**

Before You Start



If you want to dispose this product, do not mix it with general household waste. There is a separate collection system for used electronic products in accordance with legislation that requires proper treatment, recovery and recycling.

Private households in the member states of the EU, in Switzerland and Norway may return their used electronic products free of charge to designated collection facilities or to a retailer (if you purchase a similar new one).

For countries not mentioned above, please contact your local authorities for the correct method of disposal.

By doing so you will ensure that your disposed product undergoes the necessary treatment, recovery and recycling and thus prevent potential negative effects on the environment and human health.

About this unit

The tuner frequencies on this unit are allocated for use in Western Europe, Asia, the Middle East, Africa and Oceania. Use in other areas may result in poor reception. The RDS (radio data system) function only operates in areas with broadcasting RDS signals for FM stations.

CAUTION

This product is a class 1 laser product classified under the Safety of laser products, IEC 60825-1:2007, and contains a class 1M laser module. To ensure continued safety, do not remove any covers or attempt to gain access to the inside of the product. Refer all servicing to qualified personnel.

CLASS 1 LASER PRODUCT

CAUTION—CLASS 1M INVISIBLE LASER RADIATION WHEN OPEN, DO NOT VIEW DIRECTLY WITH OPTICAL INSTRUMENTS.

CAUTION

- Do not allow this unit to come into contact with liquids. Electrical shock could result. Also, damage to this unit, smoke, and overheating could result from contact with liquids.
- The Pioneer CarStereo-Pass is for use only in Germany.
- Always keep the volume low enough to hear outside sounds.
- Avoid exposure to moisture.
- If the battery is disconnected or discharged, any preset memory will be erased.

In case of trouble

Should this product fail to operate properly, please contact your dealer or nearest authorized Pioneer Service Station.

Demo mode

Important

- Failure to connect the red lead (ACC) of this unit to a terminal coupled with ignition switch on/off operations may lead to battery drain.

Before You Start

- Remember that if the feature demo continues operating when the car engine is turned off, it may drain battery power.

The demo automatically starts when the ignition switch is set to ACC or ON while the unit is turned off. Turning off the unit does not cancel demo mode. To cancel the demo mode, press **DISP/↔/SCRL**. Press **DISP/↔/SCRL** again to start. Operating the demo while the ignition switch is set to ACC may drain battery power. 

audio players are indicated, they are collectively referred to as “USB storage devices.”

- In this manual, iPod and iPhone will be referred to as “iPod”. 

Reverse mode

If you do not perform an operation within about 30 seconds, screen indications start to reverse, and then continue reversing every 10 seconds. Pressing button **BAND/ESC** when power to this unit is turned off while the ignition switch is set to ACC or ON cancels the reverse mode. Press button **BAND/ESC** again to start the reverse mode. 

Sound muting

Sound is muted automatically when:

- A call is made or received using a cell phone connected to this unit.
- Voice guidance is output from a connected Pioneer navigation unit.

The sound is turned off, **MUTE** is displayed and no audio adjustments, except volume control, are possible. Operation returns to normal when the phone connection or the voice guidance is ended. 

About this manual

- In the following instructions, USB memories, USB portable audio players, and SD memory cards are collectively referred to as “external storage devices (USB, SD).” If only USB memories and USB portable

Operating this unit

Head unit

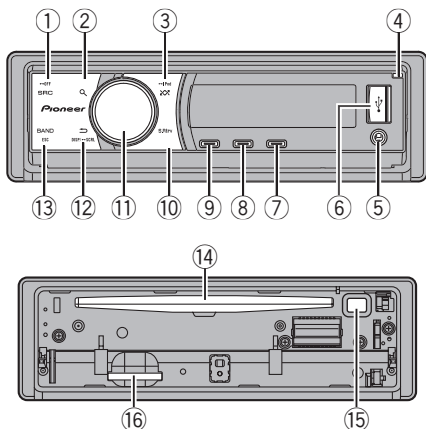

Part	Part
① SRC/OFF	⑨ ↔/LOC
② 🔍 (list)	⑩ S.Rtrv
③ 🎧/ iPod	⑪ MULTI-CONTROL (M.C.)
④ Open button	⑫ DISP/🔄/SCRL
⑤ AUX input jack (3.5 mm stereo jack)	⑬ BAND/ESC
⑥ USB port	⑭ Disc loading slot
⑦ TA/NEWS	⑮ ▲ (eject)
⑧ MUTE/CLOCK	⑯ SD memory card slot
	⑰ Remove the front panel to access the SD memory card slot.

CAUTION

Use an optional Pioneer USB cable (CD-U50E) to connect the USB audio player/USB memory as any device connected directly to the unit will protrude out from the unit and may be dangerous. Do not use unauthorized products. ■

Optional remote control

The remote control CD-R320 is sold separately.

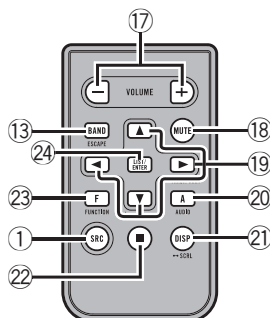

Part	Operation
⑰ VOLUME	Press to increase or decrease volume.
⑱ MUTE	Press to mute. Press again to unmute.
⑲ ▲/▼/◀▶	Press to perform manual seek tuning, fast forward, reverse and track search controls. Also used for controlling functions.
⑳ AUDIO	Press to select an audio function.
㉑ DISP/SCRL	Press to select different displays. Press and hold to scroll through the text information.
㉒ II	Press to pause or resume playback.
㉓ FUNCTION	Press to select functions. Press and hold to recall the initial setting menu when the sources are off.
㉔ LIST/ENTER	Press to display the disc title, track title, folder, or file list depending on the source. While in the operating menu, press to control functions.



Basic Operations

Important

- Handle gently when removing or attaching the front panel.
- Avoid subjecting the front panel to excessive shock.
- Keep the front panel out of direct sunlight and high temperatures.
- To avoid damaging the device or vehicle interior, remove any cables and devices attached to the front panel before detaching it.

Removing the front panel to protect your unit from theft

- 1 Press the open button to open the front panel.
- 2 Grip the left side of the front panel and pull it gently outward.
- 3 Always keep the detached front panel in a protection device such as a protection case.

Re-attaching the front panel

- 1 Reattach the front panel by holding it upright to the unit and clipping it securely into the mounting hooks.

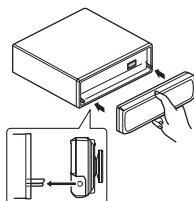

Turning the unit on

- 1 Press **SRC/OFF** to turn the unit on.

Turning the unit off

- 1 Press and hold **SRC/OFF** until the unit turns off.

Selecting a source

- 1 Press **SRC/OFF** to cycle between:
TUNER (tuner)—**CD** (built-in CD player)—**USB** (USB)/**IPOD** (iPod)—**SD** (SD memory card)—**AUX** (AUX)

Adjusting the volume

- 1 Turn **M.C.** to adjust the volume.

Note

When this unit's blue/white lead is connected to the vehicle's auto-antenna relay control terminal, the vehicle's antenna extends when this unit's

source is turned on. To retract the antenna, turn the source off.

Menu operations identical for function settings/audio adjustments/initial settings/lists

Returning to the previous display
 Returning to the previous list/category (the folder/category one level higher.)

- 1 Press **DISP/↔/SCRL**.

Returning to the main menu
 Returning to the top tier of the list/category.

- 1 Press and hold **DISP/↔/SCRL**.

Returning to the ordinary display
 Canceling the initial setting menu

- 1 Press **BAND/ESC**.

Returning to the ordinary display from the list/category

- 1 Press **BAND/ESC**.



Tuner

Basic Operations

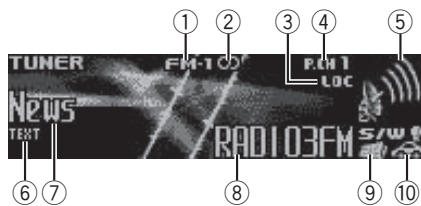

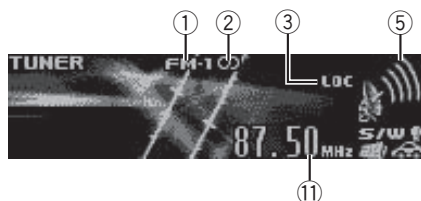

RDS



Non-RDS or MW/LW

Operating this unit

- ① Band indicator
- ②  (stereo) indicator
- ③ **LOC** indicator
Appears when local seek tuning is on.
- ④ Preset number indicator
- ⑤ Signal level indicator
- ⑥ **TEXT** indicator
Shows when the radio text is received.
- ⑦ PTY label indicator
- ⑧ Program service name
- ⑨ News () indicator
Appears when the set news program is received.
- ⑩ TP () indicator
Appears when a TP station is tuned in.
- ⑪ Frequency indicator

Selecting a band

- ① Press **BAND/ESC** until the desired band (**FM-1**, **FM-2**, **FM-3** for FM or **MW/LW**) is displayed.

Manual tuning (step by step)

- ① Push **M.C.** left or right.

Seeking

- ① Push and hold **M.C.** left or right.
You can cancel seek tuning by pushing **M.C.** left or right.
While pushing and holding **M.C.** left or right, you can skip stations. Seek tuning starts as soon as you release **M.C.**

Storing and recalling stations for each band

1 Press (list).

The preset screen is displayed.

2 Use **M.C.** to store the selected frequency in the memory.

Turn to change the preset number. Press and hold to store.

3 Use **M.C.** to select the desired station.

Turn to change the station. Press to select.

- All stations stored for FM bands can be recalled from each independent FM band.
- You can also change the station by pushing **M.C.** up or down.
- To return to the ordinary display, press **BAND/ESC** or  (list).

Using PI Seek

If the tuner cannot find a suitable station, or the reception status deteriorates, the unit automatically searches for a different station with the same programming. During the search, **PI seek** is displayed and the sound is muted.

Using Auto PI Seek for preset stations

When preset stations cannot be recalled, the unit can be set to perform PI Seek during preset recall.

- The default setting for Auto PI Seek is off.
Refer to **Auto PI** (*auto PI seek*) on page 15.

Using radio text

Displaying radio text

You can display the currently received radio text and the three most recent radio texts.

- 1 Press and hold **DISP/↔/SCRL** to display radio text.
 - You can cancel radio text display by pressing **DISP/↔/SCRL**, **TA/NEWS**, **SRC/OFF** or **BAND**.
 - When no radio text is received, **NO TEXT** appears in the display.
- 2 Push **M.C.** left or right to recall the three most recent radio texts.
- 3 Push **M.C.** up or down to scroll.

Storing and recalling radio text

You can store data from up to six radio text transmissions to the **RT Memo 1** to **RT Memo 6** keys.

- 1 Display the radio text you want to store in the memory.
- 2 Press **Q** (list).
The preset screen is displayed.
- 3 Use **M.C.** to store the selected radio text.
Turn to change the preset number. Press and hold to store.
- 4 Use **M.C.** to select the desired radio text.
Turn to change the radio text. Press to select.
 - To return to the ordinary display, press **BAND/ESC** or **Q** (list).

- The tuner automatically stores the three latest radio text broadcasts received, replacing the oldest text with the newest text.

Advanced operations using special buttons

Receiving traffic announcements

Regardless of the source you are listening to, you can receive traffic announcements automatically with TA (traffic announcement standby).

- 1 Tune in to a TP or enhanced other network's TP station.
- 2 Press **TA/NEWS** to turn traffic announcement standby on or off.
- 3 Use **M.C.** to adjust the TA volume when a traffic announcement begins.
The newly set volume is stored in the memory and will be recalled for subsequent traffic announcements.
- 4 Press **TA/NEWS** while a traffic announcement is being received to cancel the announcement.
The tuner returns to the original source but remains in the standby mode until **TA/NEWS** is pressed again.

Using news program interruption

When a news program is broadcast from a PTY code news station, the unit automatically switches to the news broadcast station. When the news program ends, reception of the previous program resumes.

- 1 Press and hold **TA/NEWS** to turn news program interruption on or off.
A news program can be canceled by pressing **TA/NEWS**.

Local seek tuning

- 1 Press **↔/LOC** repeatedly to select the desired setting.
FM: **Level 1—Level 2—Level 3—Level 4**
MW/LW: **Level 1—Level 2**
The highest level setting allows reception of only the strongest stations, while lower levels allow the reception of weaker stations.

Function settings

- 1 Press **M.C.** to display the main menu.
- 2 Turn **M.C.** to change the menu option and press to select **FUNCTION**.
- 3 Turn **M.C.** to select the function.

After selecting, perform the following procedures to set the function.

Operating this unit

BSM (best stations memory)

BSM (best stations memory) automatically stores the six strongest stations in the order of their signal strength.

- Press **M.C.** to turn BSM on.
To cancel, press **M.C.** again.

Regional (regional)

When AF is used, the regional function limits the selection of stations to those broadcasting regional programs.

- Press **M.C.** to turn the regional function on or off.

Local (local seek tuning)

Local seek tuning lets you tune in to only those radio stations with sufficiently strong signals for good reception.

- Press **M.C.** to turn local on.
 - To cancel, press **M.C.** again.
- Push **M.C.** left or right to select the desired setting.
For details, refer to *Local seek tuning* on the previous page.

PTY search (program type selection)

You can tune in to a station using PTY (program type) information.

- Press **M.C.** to display the setting mode.
- Push **M.C.** left or right to select the desired setting.
News&Inf—Popular—Classics—Others
- Press **M.C.** to begin the search.
The unit searches for a station broadcasting that type of program. When a station is found, its program service name is displayed.
PTY (program type ID code) information is listed in the following section. Refer to this page.
To cancel the search, press **M.C.** again.
The program of some stations may differ from that indicated by the transmitted PTY.
If no station is broadcasting the type of program you searched for, **NOT FOUND** is displayed for about two seconds and then the tuner returns to the original station.

Traffic (traffic announcement standby)

- Press **M.C.** to turn traffic announcement standby on or off.

AF (alternative frequencies search)

When the tuner cannot get a good reception, the unit automatically searches for a different station in the same network.

- Press **M.C.** to turn AF on or off.

News (news program interruption)

- Press **M.C.** to turn the NEWS function on or off.

PTY list

News&Inf

News (News), **Affairs** (Current affairs), **Info** (Information), **Sport** (Sports), **Weather** (Weather), **Finance** (Finance)

Popular

Pop Mus (Popular music), **Rock Mus** (Rock music), **Easy Mus** (Easy listening), **Oth Mus** (Other music), **Jazz** (Jazz), **Country** (Country music), **Nat Mus** (National music), **Oldies** (Oldies music), **Folk mus** (Folk music)

Classics

L. Class (Light classical), **Classic** (Classical)

Others

Educate (Education), **Drama** (Drama), **Culture** (Culture), **Science** (Science), **Varied** (Varied), **Children** (Children's), **Social** (Social affairs), **Religion** (Religion), **Phone In** (Phone in), **Touring** (Travel), **Leisure** (Leisure), **Document** (Documentaries)



CD/CD-R/CD-RW and external storage devices (USB, SD)

Basic Operations

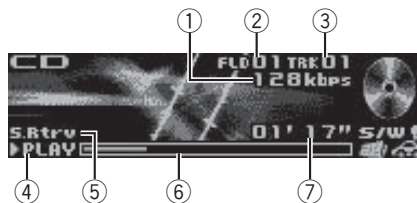

- Bit rate/sampling frequency indicator

Operating this unit

Shows the bit rate or sampling frequency of the current track (file) when the compressed audio is playing.

- When playing back VBR (variable bit rate)-recorded AAC files, the average bit rate value is displayed. However, depending on the software used to decode AAC files, **VBR** may be displayed.
- ② Folder number indicator
Shows the folder number currently playing when the compressed audio is playing.
 - ③ Track number indicator
 - ④ **PLAY/PAUSE** indicator
 - ⑤ **S.Rtrv** indicator
Appears when Sound Retriever function is on.
 - ⑥ Song time (progress bar)
 - ⑦ Play time indicator

Playing a CD/CD-R/CD-RW

- ① Press the open button to open the front panel.
- ② Insert the disc into the disc loading slot with the label side up.

Ejecting a CD/CD-R/CD-RW

- ① Press the open button to open the front panel.
- ② Press **▲** (eject).

Playing songs on a USB storage device

- ① Open the USB connector cover.
- ② Plug in the USB storage device using a USB cable.

Stopping playback of files on a USB storage device

- ① You may disconnect the USB storage device at any time.

Playing songs on an SD memory card

- ① Press the open button to open the front panel.
- ② Remove the front panel.
- ③ Insert an SD memory card into the SD card slot. Insert it with the contact surface facing down, and press on the card until it clicks and completely locks into place.
- ④ Re-attach the front panel.
- ⑤ Press **SRC/OFF** to select **SD** as the source. Playback will start.

Stopping playback of files on an SD memory card

- ① Press the open button to open the front panel.
- ② Remove the front panel.
- ③ Press on the SD memory card until it clicks. The SD memory card is ejected.
- ④ Pull out the SD memory card.
- ⑤ Re-attach the front panel.

Selecting a folder

- ① Push **M.C.** up or down.

Selecting a track

- ① Push **M.C.** left or right.

Fast forwarding or reversing

- ① Push and hold **M.C.** left or right.

Returning to root folder

- ① Press and hold **BAND/ESC**.

Switching between compressed audio and CD-DA

- ① Press **BAND/ESC**.

Notes

- When playing compressed audio, there is no sound during fast forward or reverse.
- Disconnect USB storage devices from the unit when not in use.

Displaying text information

Selecting the desired text information

- ① Press **DISP/↔/SCRL**.

Scrolling the text information to the left

- ① Press and hold **DISP/↔/SCRL**.

Notes

- Depending on the version of iTunes used to write MP3 files to a disc or media file types, incompatible text stored within an audio file may be displayed incorrectly.
- Text information items that can be changed depend on the media.

Selecting and playing files/ tracks from the name list

1 Press **🔍 (list)** to switch to the file/track name list mode.

2 Use **M.C.** to select the desired file name (or folder name).

Changing the file or folder name

- ① Turn **M.C.**

Playing

- ① When a file or track is selected, press **M.C.**

Operating this unit

Viewing a list of the files (or folders) in the selected folder

- 1 Press **M.C.**.

Playing a song in the selected folder

- 1 Press and hold **M.C.**.

Advanced operations using special buttons

Playing tracks in random order

- 1 Press **⏮/iPod** to turn random play on or off.
Tracks in a selected repeat range are played in random order.

Selecting a repeat play range

- 1 Press **↔/LOC** to cycle between the following:
CD/CD-R/CD-RW
- **Disc repeat** – Repeat all tracks
 - **Track repeat** – Repeat the current track
 - **Folder repeat** – Repeat the current folder
- External storage device (USB, SD)**
- **All repeat** – Repeat all files
 - **Track repeat** – Repeat the current file
 - **Folder repeat** – Repeat the current folder

Enhancing compressed audio and restoring rich sound (sound retriever)

- 1 Press **S.Rtrv** to cycle between:
- OFF (off)—1—2**
- 1** is effective for low compression rates, and **2** is effective for high compression rates.

Function settings

1 Press M.C. to display the main menu.

2 Turn M.C. to change the menu option and press to select FUNCTION.

3 Turn M.C. to select the function.

After selecting, perform the following procedures to set the function.

Play mode (repeat play)

- 1 Press **M.C.** to select a repeat play range.
For details, refer to *Selecting a repeat play range* on this page.

Random mode (random play)

- 1 Press **M.C.** to turn random play on or off.

Pause (pause)

- 1 Press **M.C.** to pause or resume.

Sound Retriever (sound retriever)

Automatically enhances compressed audio and restores rich sound.

- 1 Press **M.C.** to select the desired setting.
For details, refer to *Enhancing compressed audio and restoring rich sound (sound retriever)* on this page.

iPod

Basic Operations

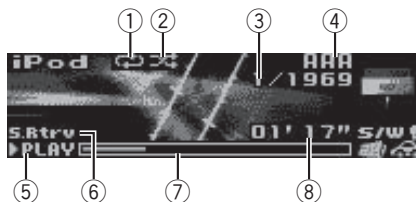

- 1 Repeat indicator
- 2 Shuffle indicator
- 3 Song number indicator
- 4 iPod name
- 5 **PLAY/PAUSE** indicator
- 6 **S.Rtrv** indicator
- 7 Song time (progress bar)
- 8 Play time indicator

Playing songs on an iPod

- 1 Open the USB connector cover and plug in an iPod using the iPod Dock Connector to USB Cable.

Selecting a track (chapter)

- 1 Push **M.C.** left or right.

Fast forwarding or reversing

- 1 Push and hold **M.C.** left or right.

Operating this unit

Notes

- The iPod cannot be turned on or off when the control mode is set to **AUDIO**.
- Disconnect headphones from the iPod before connecting it to this unit.
- The iPod will turn off about two minutes after the ignition switch is set to OFF.

Displaying text information

Selecting the desired text information

- 1 Press **DISP/⇨/SCRL**.

Scrolling the text information to the left

- 1 Press and hold **DISP/⇨/SCRL**.

Browsing for a song

1 Press **Q (list) to switch to the top menu of the list search.**

2 Use M.C. to select a category/song.

Changing the name of the song or category

- 1 Turn **M.C.**

Playlists (playlists)—**Artists** (artists)—**Albums** (albums)—**Songs** (songs)—**Podcasts** (podcasts)
—**Genres** (genres)—**Composers** (composers)—**Audiobooks** (audiobooks)

Playing

- 1 When a song is selected, press **M.C.**

Viewing a list of songs in the selected category

- 1 When a category is selected, press **M.C.**

Playing a song in the selected category

- 1 When a category is selected, press and hold **M.C.**

Searching the list by alphabet

- 1 When a list for the selected category is displayed, press **Q** to switch to alphabet search mode.
- 2 Turn **M.C.** to select a letter.
- 3 Press **M.C.** to display the alphabetical list.

Advanced operations using special buttons

Selecting a repeat play range

- 1 Press **↺/LOC** to cycle between the following:
 - **Repeat One** – Repeat the current song
 - **Repeat All** – Repeat all songs in the selected list

Playing all songs in random order (shuffle all)

- 1 Press **↻/iPod** to turn shuffle all on.

Playing songs related to the currently playing song
You can play songs from the following lists.

- Album list of the currently playing artist
 - Song list of the currently playing album
 - Album list of the currently playing genre
- 1 Press and hold **M.C.** to switch to link play mode.
 - 2 Push **M.C.** left or right to change the mode; press to select.
 - **Artist** – Plays an album of the artist currently being played.
 - **Album** – Plays a song from the album currently being played.
 - **Genre** – Plays an album from the genre currently being played.

The selected song/album will be played after the currently playing song.

- The selected song/album may be canceled if you operate functions other than link search (e.g. fast forward and reverse).
- Depending on the song selected to play, the end of the currently playing song and the beginning of the selected song/album may be cut off.

Operating this unit's iPod function from your iPod
This function is not compatible with the following iPod models.

- iPod nano 1st generation
 - iPod 5th generation
- 1 Press **↻/iPod** and hold to switch the control mode.
 - **iPod** – This unit's iPod function can be operated from the connected iPod.
 - **AUDIO** – This unit's iPod function can be operated from this unit.

Enhancing compressed audio and restoring rich sound (sound retriever)

- 1 Press **S.Rtrv** to cycle between:
 - OFF** (off)—**1**—**2**
 - 1** is effective for low compression rates, and **2** is effective for high compression rates.

Operating this unit

Function settings

1 Press M.C. to display the main menu.

2 Turn M.C. to change the menu option and press to select FUNCTION.

3 Turn M.C. to select the function.

After selecting, perform the following procedures to set the function.

Play mode (repeat play)

- ① Press **M.C.** to select a repeat play range.
For details about the settings, refer to *Selecting a repeat play range* on the previous page.

Shuffle mode (shuffle)

- ① Press **M.C.** to select your favorite setting.
- **Shuffle Songs** – Play back songs in the selected list in random order.
 - **Shuffle Albums** – Play back songs from a randomly selected album in order.
 - **Shuffle OFF** – Cancel random play.

Shuffle all (shuffle all)

- ① Press **M.C.** to turn shuffle all on.
To turn off, set **Shuffle mode** in the **FUNCTION** menu to off.

Link play (link play)

- ① Push **M.C.** left or right to change the mode; press to select.
For details about the settings, refer to *Playing songs related to the currently playing song* on the previous page.

Control mode (control mode)

- ① Press **M.C.** to select your favorite setting.
For details about the settings, refer to *Operating this unit's iPod function from your iPod* on the previous page.

PAUSE (pause)

- ① Press **M.C.** to pause or resume.

Audiobooks (audiobook speed)

- ① Press **M.C.** to select your favorite setting.
- **Faster** – Playback at a speed faster than normal
 - **Normal** – Playback at normal speed
 - **Slower** – Playback at a speed slower than normal

Sound Retriever (sound retriever)

- ① Press **M.C.** to select the desired setting.
For details, refer to *Enhancing compressed audio and restoring rich sound (sound retriever)* on the previous page.

Notes

- Switching the control mode to **iPod** pauses song playback. Operate the iPod to resume playback.
- The following functions are still accessible from the unit even if the control mode is set to **iPod**.
 - Volume
 - Fast forward/reverse
 - Track up/down
 - Pausing
 - Switching the text information
- When the control mode is set to **iPod**, operations are limited as follows:
 - Only **Control mode** (control mode), **PAUSE** (pause) and **Sound Retriever** (sound retriever) functions are available.
 - The browse function cannot be operated from this unit.

Audio Adjustments



- ① Audio display
Shows the audio adjustment status.

1 Press M.C. to display the main menu.

2 Turn M.C. to change the menu option and press to select AUDIO.

Operating this unit

3 Turn M.C. to select the audio function.

After selecting, perform the following procedures to set the audio function.

Fader/Balance (fader/balance adjustment)

- 1 Push **M.C.** up or down to adjust the front/rear speaker balance.
 - The front/rear speaker balance cannot be adjusted when the rear output setting is **Rear SP:S/W**. Refer to **S/W control** (rear output and subwoofer setting) on page 16.
- 2 Push **M.C.** left or right to adjust the left/right speaker balance.

Powerful (equalizer recall)

- 1 Push **M.C.** left or right to select an equalizer curve.
Powerful—Natural—Vocal—Custom1—Custom2—Flat—Super bass

100 Hz (equalizer adjustment)

You can adjust the currently selected equalizer curve setting as desired. Adjusted equalizer curve settings are stored in **Custom1** or **Custom2**.

- A separate **Custom1** curve can be created for each source. If you make adjustments when a curve other than **Custom2** is selected, the equalizer curve settings will be stored in **Custom1**.
 - A **Custom2** curve that is common for all sources can be created. If you make adjustments when the **Custom2** curve is selected, the **Custom2** curve will be updated.
- 1 Recall the equalizer curve you want to adjust.
 - 2 Push **M.C.** left or right to select the equalizer band to adjust.
100Hz—315Hz—1.25kHz—3.15kHz—8kHz
 - 3 Push **M.C.** up or down to adjust the equalizer curve.
+6 to -6 is displayed as the equalizer curve is increased or decreased.

LOUD (loudness)

Loudness compensates for deficiencies in the low and high-frequency ranges at low volume.

- 1 Press **M.C.** to turn loudness on or off.
- 2 Push **M.C.** left or right to select the desired setting.
Low (low)—**Mid** (mid)—**High** (high)

Sub W.1 (subwoofer on/off setting)

This unit is equipped with a subwoofer output which can be turned on or off.

- 1 Press **M.C.** to turn subwoofer output on or off.
- 2 Push **M.C.** left or right to select the phase of subwoofer output.
Push **M.C.** left to select reverse phase and **Reverse** appears in the display. Push **M.C.** right to select normal phase and **Normal** appears in the display.

Sub W.2 (subwoofer adjustment)

The cut-off frequency and output level can be adjusted when the subwoofer output is on. Only frequencies lower than those in the selected range are outputted from the subwoofer.

- 1 Push **M.C.** left or right to select the cut-off frequency.
50Hz—63Hz—80Hz—100Hz—125Hz
- 2 Push **M.C.** up or down to adjust the output level of the subwoofer.
Each time **M.C.** is pushed up or down, subwoofer level increases or decreases. **+6 to -24** is displayed as the level is increased or decreased.

Bass (bass boost)

- 1 Push **M.C.** up or down to select a desired level.
0 to +6 is displayed as the level is increased or decreased.

HPF (high pass filter adjustment)

When you do not want low sounds from the subwoofer output frequency range to play from the front or rear speakers, turn on the HPF (high pass filter). Only frequencies higher than those in the selected range are output from the front or rear speakers.

- 1 Press **M.C.** to turn high pass filter on or off.
- 2 Push **M.C.** left or right to select the cut-off frequency.
50Hz—63Hz—80Hz—100Hz—125Hz

SLA (source level adjustment)

SLA (Source Level Adjustment) lets you adjust the volume level of each source to prevent radical changes in volume when switching between sources.

- When selecting FM as the source, you cannot switch to **SLA**.
- Settings are based on the FM volume level, which remains unchanged.
- The MW/LW volume level can also be adjusted with this function.

- 1 Push **M.C.** up or down to adjust the source volume.
Adjustment range: **+4 to -4**



Operating this unit

Initial Settings

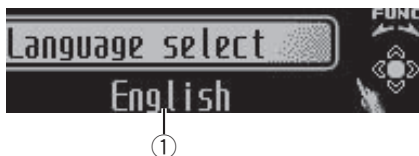

- ① Function display
- Shows the function status.

1 Press and hold SRC/OFF until the unit turns off.

2 Press M.C. and hold until the initial setting menu appears in the display.

3 Turn M.C. to select the initial setting.

After selecting, perform the following procedures to set the initial setting.

Language select (multi-language)

For your convenience, this unit equips multiple language display. You can select the language best suited to your first language.

- ① Press **M.C.** to select the language.

English—Français—Italiano—Español—Deutsch—Nederlands—РУССКИЙ

Calendar (setting the date)

- ① Push **M.C.** left or right to select the segment of the calendar display you wish to set.
Year—Day—Month
- ② Push **M.C.** up or down to set the date.

Clock (setting the clock)

- ① Push **M.C.** left or right to select the segment of the clock display you wish to set.
Hour—Minute
- ② Push **M.C.** up or down to put a clock right.
- You can match the clock to a time signal by pressing **M.C.**
 - If **00** to **29**, the minutes are rounded down. (e. g., **10:18** becomes **10:00**.)
 - If **30** to **59**, the minutes are rounded up. (e.g., **10:36** becomes **11:00**.)

EngineTime alert (elapsed time display setting)

This setting allows you to measure the length of time that elapses from when the machine is turned on and display the amount of elapsed time per set period. Also, you will hear alarm.

- ① Press **M.C.** to select your favorite setting.

OFF—15Minutes—30Minutes

FM step (FM tuning step)

Normally, the FM tuning step employed by seek tuning is 50 kHz. When AF or TA is on, the tuning step automatically changes to 100 kHz. It may be preferable to set the tuning step to 50 kHz when AF is on.

- ① Press **M.C.** to display the setting mode.

- ② Turn **M.C.** to select the FM tuning step.

50kHz (50 kHz)—100kHz (100 kHz)

Auto PI (auto PI seek)

The unit can automatically search for a different station with the same programming, even during preset recall.

- ① Press **M.C.** to turn Auto PI seek on or off.

USB plug&play (plug and play)

This setting allows you to switch your source to **USB/IPOD** automatically.

- ① Press **M.C.** to turn the plug and play function on or off.

- **ON** – When USB storage device/iPod is connected, the source is automatically switched to **USB/IPOD**. If you disconnect your USB storage device/iPod, this unit's source is turned off.
- **OFF** – When USB storage device/iPod is connected, the source does not switch to **USB/IPOD** automatically. Please manually change the source to **USB/IPOD**.

Warning tone (warning tone setting)

If the front panel is not detached from the head unit within four seconds of turning off the ignition, a warning tone sounds. You can turn off the warning tone.

- ① Press **M.C.** to turn the warning tone on or off.

AUX (auxiliary input)

Activate this setting when using an auxiliary device connected to this unit.

- ① Press **M.C.** to turn auxiliary setting on or off.

Dimmer (dimmer setting)

To prevent the display from being too bright at night, the display is automatically dimmed when the car's headlights are turned on. You can turn the dimmer on or off.

- ① Press **M.C.** to turn dimmer on or off.

Operating this unit

Brightness (display brightness setting)

- 1 Push **M.C.** left or right to adjust the brightness level.
- 0** to **15** is displayed as the level is increased or decreased.
- When dimmer is functioning, the brightness level can be adjusted **0** to **10**.

S/W control (rear output and subwoofer setting)

This unit's rear output (rear speaker leads output and RCA rear output) can be used for full-range speaker (**Rear SP:F.Range**) or subwoofer (**Rear SP:S/W**) connection. If you switch the rear output setting to **Rear SP:S/W**, you can connect a rear speaker lead directly to a subwoofer without using an auxiliary amp.

- 1 Press **M.C.** to switch the rear output setting.
- When no subwoofer is connected to the rear output, select **Rear SP:F.Range** (full-range speaker).
 - When a subwoofer is connected to the rear output, select **Rear SP:S/W** (subwoofer).
 - Even if you change this setting, there will be no output unless you turn the subwoofer output on (refer to **Sub W.1** (subwoofer on/off setting) on page 14).
 - If you change this setting, subwoofer output in the audio menu will return to the factory settings.
 - Both rear speaker lead outputs and RCA rear output are switched simultaneously in this setting.

Mute (muting or attenuation setting)

- 1 Press **M.C.** to switch the telephone muting/attenuation.
- The sound is muted or attenuated. **MUTE** or **ATT** are displayed and no audio adjustment is possible.
 - Sound from this system returns to normal when the muting or attenuation is canceled.

Demonstration (demo display setting)

- 1 Press **M.C.** to turn the demo display on or off.
- You can also turn on or off feature demo by pressing **DISP** while this unit is turned off. For more details, refer to *Demo mode* on page 3.

Reverse mode (reverse mode setting)

- 1 Press **M.C.** to turn the reverse mode on or off.
- You can also turn on or off reverse mode by pressing **BAND** while this unit is turned off. For more details, refer to *Reverse mode* on page 4.

Ever-scroll (scroll mode setting)

When ever scroll is set to ON, recorded text information scrolls continuously in the display. Set to OFF if you prefer the information to scroll just once.

- 1 Press **M.C.** to turn the ever scroll on or off.



Other Functions

Using an AUX source

1 Insert the stereo mini plug into the AUX input jack.

2 Press **SRC/OFF** to select AUX as the source.

Note

AUX cannot be selected unless the auxiliary setting is turned on. For more details, refer to **AUX** (auxiliary input) on the previous page.

Clock display

● Press and hold **MUTE/CLOCK** to select the desired setting.

Clock off—clock display—elapsed time display

Mute

1 Press **MUTE/CLOCK** to cut the sound.

2 To cancel it, press **MUTE/CLOCK** again.

Using different entertainment displays

You can enjoy entertainment displays while listening to each sound source.

1 Press **M.C.** to display the main menu.

2 Turn **M.C.** to change the menu option and press to select **ENTERTAINMENT**.

Operating this unit

3 Turn M.C. to change the display.

Background visual—genre—background picture 1—background picture 2—background picture 3—background picture 4—simple display—movie screen 1—movie screen 2—calendar

- Genre display changes depending on the genre of music.
- Genre display may not operate correctly depending on the application used to encode audio files.

Additional Information

Troubleshooting

Symptom	Cause	Action (Reference page)
The display automatically returns to the ordinary display.	You did not perform any operation within about 30 seconds.	Perform operation again.
The repeat play range changes unexpectedly.	Depending on the repeat play range, the selected range may change when another folder or track is being selected or during fast forwarding/reversing.	Select the repeat play range again.
A subfolder is not played back.	Subfolders cannot be played when Folder repeat (folder repeat) is selected.	Select another repeat play range.
NO XXXX appears when a display is changed (NO TITLE , for example).	There is no embedded text information.	Switch the display or play another track/file.
The display is illuminated when the unit is turned off.	Demo mode is on.	<ul style="list-style-type: none"> • Press DISP/↔ /SCRL to cancel demo mode. • Turn off the demo display setting.
The unit is malfunctioning. There is interference.	You are using a device, such as a cellular phone, that transmits electric waves near the unit.	Move electrical devices that may be causing the interference away from the unit.



Error messages

When you contact your dealer or your nearest Pioneer Service Center, be sure to note the error message.

Built-in CD Player

Message	Cause	Action
ERROR-07, 11, 12, 17, 30	The disc is dirty. The disc is scratched.	Clean the disc. Replace the disc.
ERROR-10, 11, 12, 15, 17, 30, A0	There is an electrical or mechanical error.	Turn the ignition switch OFF and back ON, or switch to a different source, then back to the CD player.
ERROR-15	The inserted disc is blank	Replace the disc.
ERROR-23	Unsupported CD format	Replace the disc.
FORMAT READ	Sometimes there is a delay between the start of playback and when you start to hear any sound.	Wait until the message disappears and you hear sound.
NO AUDIO	The inserted disc does not contain any playable files.	Replace the disc.
SKIPPED	The inserted disc contains DRM protected files.	Replace the disc.
PROTECT	All the files on the inserted disc are embedded with DRM.	Replace the disc.

External storage device (USB, SD)/iPod		
Message	Cause	Action
NO DEVICE	When plug and play is off, no USB storage device or iPod is connected.	<ul style="list-style-type: none"> • Turn the plug and play on. • Connect a compatible USB storage device/iPod.
FORMAT READ	Sometimes there is a delay between the start of playback and when you start to hear any sound.	Wait until the message disappears and you hear sound.

Additional Information

Message	Cause	Action
NO AUDIO	There are no songs.	Transfer the audio files to the USB storage device and connect.
	The connected USB storage device has security enabled	Follow the USB storage device instructions to disable the security.
SKIPPED	The connected USB storage device contains files embedded with Windows Media™ DRM 9/10	Play an audio file not embedded with Windows Media DRM 9/10.
PROTECT	All the files in the USB storage device are embedded with Windows Media DRM 9/10	Transfer audio files not embedded with Windows Media DRM 9/10 to the USB storage device and connect.
NOT COMPATIBLE	The connected USB storage device is not supported by this unit.	<ul style="list-style-type: none"> • Connect a USB Mass Storage Class compliant device. • Disconnect your device and replace it with a compatible USB storage device.
	Non-compatible iPod	Disconnect your device and replace it with a compatible iPod.
	Non-compatible SD storage device	Remove your device and replace it with a compatible SD storage device.

Message	Cause	Action
CHECK USB	The USB connector or USB cable has short-circuited.	Check that the USB connector or USB cable is not caught in something or damaged.
	The connected USB storage device consumes more than 500 mA (maximum allowable current).	Disconnect the USB storage device and do not use it. Turn the ignition switch to OFF, then to ACC or ON and then connect only compliant USB storage devices.
	The iPod operates correctly but does not charge	Make sure the connection cable for the iPod has not shorted out (e.g., not caught in metal objects). After checking, turn the ignition switch OFF and back ON, or disconnect the iPod and reconnect.
ERROR-19	Communication failed.	<ul style="list-style-type: none"> • Perform one of the following operations. <ul style="list-style-type: none"> –Turn the ignition switch OFF and back ON. –Disconnect or eject the external storage device. –Change to a different source. Then, return to the USB or SD source. • Disconnect the cable from the iPod. Once the iPod's main menu is displayed, reconnect the iPod and reset it.
	iPod failure	Disconnect the cable from the iPod. Once the iPod's main menu is displayed, reconnect the iPod and reset it.

Additional Information

Message	Cause	Action
ERROR-23	USB storage device was not formatted with FAT12, FAT16 or FAT32	USB storage device should be formatted with FAT12, FAT16 or FAT32.
ERROR-16	The iPod firmware version is old.	Update the iPod version.
	iPod failure	Disconnect the cable from the iPod. Once the iPod's main menu is displayed, reconnect the iPod and reset it.
STOP	There are no songs in the current list.	Select a list that contains songs.
Not found	No related songs	Transfer songs to the iPod.



Handling guidelines

Discs and player

Use only discs that feature either of the following two logos.



Use 12-cm discs. Do not use 8-cm discs or an adapter for 8-cm discs.

Use only conventional, fully circular discs. Do not use shaped discs.



Do not insert anything other than a CD into the CD loading slot.

Do not use cracked, chipped, warped, or otherwise damaged discs as they may damage the player.

Unfinalized CD-R/CD-RW discs cannot be played back.

Do not touch the recorded surface of the discs.

Store discs in their cases when not in use.

Do not attach labels, write on or apply chemicals to the surface of the discs.

To clean a CD, wipe the disc with a soft cloth outward from the center.

Condensation may temporarily impair the player's performance. Let it rest for about one hour to adjust to a warmer temperature. Also, wipe any damp discs off with a soft cloth.

Playback of discs may not be possible because of disc characteristics, disc format, recorded application, playback environment, storage conditions, and so on.

Road shocks may interrupt disc playback.

External storage device (USB, SD)

Address any questions you have about your external storage device (USB, SD) to the manufacturer of the device.

Do not leave the external storage device (USB, SD) in places with high temperatures.

Depending on the external storage device (USB, SD), the following problems may occur.

- Operations may vary.
- The storage device may not be recognized.
- Files may not be played back properly.

USB storage device

Connections via USB hub are not supported.

Do not connect anything other than a USB storage device.

Firmly secure the USB storage device when driving. Do not let the USB storage device fall onto the floor, where it may become jammed under the brake or accelerator pedal.

Depending on the USB storage device, the following problems may occur.

- The device may generate noise in the radio.

Additional Information

SD memory card

This unit supports only the following types of SD memory cards.

- SD
- miniSD
- microSD
- SDHC

Keep the SD memory card out of the reach of children. Should the SD memory card be swallowed, consult a doctor immediately.

Do not touch the connectors of the SD memory card directly with your fingers or with any metal device.

Do not insert anything other than an SD memory card into the SD card slot. If a metal object (such as a coin) is inserted into the slot, the internal circuits may break and cause malfunctions.

When inserting a miniSD or microSD, use an adapter. Do not use an adapter which has metal parts other than the connectors exposed.

Do not insert a damaged SD memory card (e.g. warped, label peeled off) as it may not be ejected from the slot.

Do not try to force an SD memory card into the SD card slot as the card or this unit may be damaged.

When ejecting an SD memory card, press it and hold it until it clicks. It is dangerous for you to release your finger immediately after you press on the card as the card may shoot out of the slot and hit you in the face, etc. If the card shoots out of the slot, it may become lost.

iPod

To ensure proper operation, connect the dock connector cable from the iPod directly to this unit.

Firmly secure the iPod when driving. Do not let the iPod fall onto the floor, where it may become jammed under the brake or accelerator pedal.

About iPod settings

- When an iPod is connected, this unit changes the EQ (equalizer) setting of the iPod to off in order to optimize the acoustics. When you disconnect the iPod, the EQ returns to the original setting.
- You cannot set Repeat to off on the iPod when using this unit. Repeat is automatically changed to All when the iPod is connected to this unit.

Incompatible text saved on the iPod will not be displayed by the unit.

DualDiscs

DualDiscs are two-sided discs that have a recordable CD for audio on one side and a recordable DVD for video on the other.

Since the CD side of DualDiscs is not physically compatible with the general CD standard, it may not be possible to play the CD side with this unit.

Frequent loading and ejecting of a DualDisc may result in scratches on the disc. Serious scratches can lead to playback problems on this unit. In some cases, a DualDisc may become stuck in the disc loading slot and will not eject. To prevent this, we recommend you refrain from using DualDisc with this unit. Please refer to the information from the disc manufacturer for more detailed information about DualDiscs.

CAUTION

Do not leave the discs/external storage device (USB, SD) or iPod in places with high temperatures. 

Compressed audio compatibility (disc, USB, SD)

WMA

File extension: .wma

Bit rate: 48 kbps to 320 kbps (CBR), 48 kbps to 384 kbps (VBR)

Sampling frequency: 32 kHz, 44.1 kHz, 48 kHz

Windows Media Audio Professional, Lossless, Voice/DRM Stream/Stream with video: Not compatible

MP3

File extension: .mp3

Bit rate: 8 kbps to 320 kbps (CBR), VBR

Sampling frequency: 8 kHz to 48 kHz (32 kHz, 44.1 kHz, 48 kHz for emphasis)

Compatible ID3 tag version: 1.0, 1.1, 2.2, 2.3, 2.4 (ID3 tag Version 2.x is given priority over Version 1.x.)

M3u playlist: Not compatible

MP3i (MP3 interactive), mp3 PRO: Not compatible

Additional Information

WAV

File extension: .wav

Quantization bits: 8 and 16 (LPCM), 4 (MS ADPCM)

Sampling frequency: 16 kHz to 48 kHz (LPCM), 22.05 kHz and 44.1 kHz (MS ADPCM)

AAC

Compatible format: AAC encoded by iTunes

File extension: .m4a

Sampling frequency: 11.025 kHz to 48 kHz

Transmission rate: 16 kbps to 320 kbps, VBR

Apple Lossless: Not compatible

AAC file bought from the iTunes Store (.m4p file extension): Not compatible

Supplemental information

Only the first 32 characters can be displayed as a file name (including the file extension) or a folder name.

This unit may not operate correctly depending on the application used to encode WMA files.

There may be a slight delay when starting playback of audio files embedded with image data.

Russian text to be displayed on this unit should be encoded in one of the following character sets:

- Unicode (UTF-8, UTF-16)
- A character set other than Unicode that is used in a Windows environment and is set to Russian in the multi-language setting

Disc

Playable folder hierarchy: up to eight tiers (A practical hierarchy is less than two tiers.)

Playable folders: up to 99

Playable files: up to 999

File system: ISO 9660 Level 1 and 2, Romeo, Joliet

Multi-session playback: Compatible

Packet write data transfer: Not compatible

Regardless of the length of blank sections between the songs from the original recording, compressed audio discs play with a short pause between songs.

External storage device (USB, SD)

Playable folder hierarchy: up to eight tiers (A practical hierarchy is less than two tiers.)

Playable folders: up to 1 500

Playable files: up to 15 000

Playback of copyright-protected files: Not compatible

Partitioned external storage device (USB, SD): Only the first playable partition can be played.

There may be a slight delay when starting playback of audio files on a USB storage device with numerous folder hierarchies.

SD memory card

There is no compatibility for Multi Media Cards (MMC).

Compatibility with all SD memory cards is not guaranteed.

This unit is not compatible with SD-Audio.



CAUTION

Pioneer accepts no responsibility for data lost on USB memory/USB portable audio players/SD memory cards/SDHC memory cards, even if that data is lost while this unit is used. 

Additional Information

iPod compatibility

This unit supports only the following iPod models. Supported iPod software versions are shown below. Older versions may not be supported.

- iPhone 4 (software version 4.0)
- iPhone 3GS (software version 4.0)
- iPhone 3G (software version 4.0)
- iPhone (software version 3.1.3)
- iPod nano 5th generation (software version 1.0.2)
- iPod nano 4th generation (software version 1.0.4)
- iPod nano 3rd generation (software version 1.1.3)
- iPod nano 2nd generation (software version 1.1.3)
- iPod nano 1st generation (software version 1.3.1)
- iPod touch 3rd generation (software version 4.0)
- iPod touch 2nd generation (software version 4.0)
- iPod touch 1st generation (software version 3.1.3)
- iPod classic 160GB (software version 2.0.4)
- iPod classic 120GB (software version 2.0.1)
- iPod classic (software version 1.1.2)
- iPod 5th generation (software version 1.3)

Depending on the generation or version of the iPod, some functions may not be available.

Operations may vary depending on the software version of iPod.

When using an iPod, an iPod Dock Connector to USB Cable is required.

A Pioneer CD-IU50 interface cable is also available. For details, consult your dealer.

About the file/format compatibility, refer to the iPod manuals.

Audio Book, Podcast: Compatible



CAUTION



Pioneer accepts no responsibility for data lost on the iPod, even if that data is lost while this unit is used. 

Sequence of audio files

The user cannot assign folder numbers and specify playback sequences with this unit.

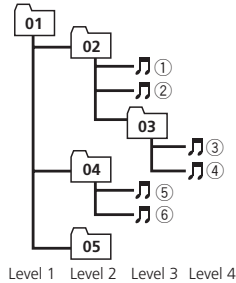
Example of a hierarchy



 Folder
 Compressed audio file
 01 to 05: Folder number
 ① to ⑥: Playback sequence

Disc

Folder selection sequence or other operation may differ depending on the encoding or writing software.

External storage device (USB, SD)

The playback sequence is the same as the recorded sequence in the external storage device (USB, SD).

To specify the playback sequence, the following method is recommended.

- ① Create a file name that includes numbers that specify the playback sequence (e.g., 001xxx.mp3 and 099yyy.mp3).
- ② Put those files into a folder.
- ③ Save the folder that contains the files to the external storage device (USB, SD).

However, depending on the system environment, you may not be able to specify the playback sequence.

For USB portable audio players, the sequence is different and depends on the player. 

Copyright and trademark

iTunes

Apple and iTunes are trademarks of Apple Inc., registered in the U.S. and other countries.

Additional Information

MP3

Supply of this product only conveys a license for private, non-commercial use and does not convey a license nor imply any right to use this product in any commercial (i.e. revenue-generating) real time broadcasting (terrestrial, satellite, cable and/or any other media), broadcasting/streaming via internet, intranets and/or other networks or in other electronic content distribution systems, such as pay-audio or audio-on-demand applications. An independent license for such use is required. For details, please visit <http://www.mp3licensing.com>.

WMA

Windows Media is either a registered trademark or trademark of Microsoft Corporation in the United States and/or other countries. This product includes technology owned by Microsoft Corporation and cannot be used or distributed without a license from Microsoft Licensing, Inc.

SD memory card

SD Logo is a trademark of SD-3C, LLC.
miniSD Logo is a trademark of SD-3C, LLC.
microSD Logo is a trademark of SD-3C, LLC.
SDHC Logo is a trademark of SD-3C, LLC.

iPod & iPhone

iPhone, iPod, iPod classic, iPod nano, and iPod touch are trademarks of Apple Inc., registered in the U.S. and other countries.

“Made for iPod” and “Made for iPhone” mean that an electronic accessory has been designed to connect specifically to iPod or iPhone, respectively, and has been certified by the developer to meet Apple performance standards.

Apple is not responsible for the operation of this device or its compliance with safety and regulatory standards. 

Additional Information

Specifications

General

Power source	14.4 V DC (10.8 V to 15.1 V allowable)
Grounding system	Negative type
Maximum current consumption	10.0 A
Dimensions (W × H × D):	
DIN	
Chassis	180 mm × 50 mm × 168 mm
Nose	188 mm × 58 mm × 17 mm
D	
Chassis	178 mm × 50 mm × 168 mm
Nose	170 mm × 48 mm × 17 mm
Weight	1.6 kg

Audio

Maximum power output	50 W × 4 50 W × 2/4 Ω + 70 W × 1/2 Ω (for subwoofer)
Continuous power output	22 W × 4 (50 Hz to 15 000 Hz, 5% THD, 4 Ω load, both channels driven)
Load impedance	4 Ω to 8 Ω × 4 4 Ω to 8 Ω × 2 + 2 Ω × 1
Preout maximum output level	4.0 V
Equalizer (5-Band Graphic Equalizer):	
Frequency	100/315/1.25k/3.15k/8k Hz
Gain	±12 dB
HPF:	
Frequency	50/63/80/100/125 Hz
Slope	-12 dB/oct
Subwoofer (mono):	
Frequency	50/63/80/100/125 Hz
Slope	-18 dB/oct
Gain	+6 dB to -24 dB
Phase	Normal/Reverse
Bass boost:	
Gain	+12 dB to 0 dB

CD player

System	Compact disc audio system
Usable discs	Compact disc
Signal-to-noise ratio	94 dB (1 kHz) (IEC-A network)
Number of channels	2 (stereo)
MP3 decoding format	MPEG-1 & 2 Audio Layer 3
WMA decoding format	Ver. 7, 7.1, 8, 9, 10, 11, 12 (2ch audio) (Windows Media Player)
AAC decoding format	MPEG-4 AAC (iTunes encoded only) (.m4a) (Ver. 9.2 and earlier)

WAV signal format	Linear PCM & MS ADPCM (Non-compressed)
-------------------------	----------------------------------------

USB

USB standard specification	USB 2.0 full speed
Maximum current supply	500 mA
USB Class	MSC (Mass Storage Class)
File system	FAT12, FAT16, FAT32
MP3 decoding format	MPEG-1 & 2 Audio Layer 3
WMA decoding format	Ver. 7, 7.1, 8, 9, 10, 11, 12 (2ch audio) (Windows Media Player)
AAC decoding format	MPEG-4 AAC (iTunes encoded only) (.m4a) (Ver. 9.2 and earlier)
WAV signal format	Linear PCM & MS ADPCM (Non-compressed)

SD

Compatible physical format	Version 2.00
Maximum memory capacity	32 GB (for SD and SDHC)
File system	FAT12, FAT16, FAT32
MP3 decoding format	MPEG-1 & 2 Audio Layer 3
WMA decoding format	Ver. 7, 7.1, 8, 9, 10, 11, 12 (2ch audio) (Windows Media Player)
AAC decoding format	MPEG-4 AAC (iTunes encoded only) (.m4a) (Ver. 9.2 and earlier)
WAV signal format	Linear PCM & MS ADPCM (Non-compressed)

FM tuner

Frequency range	87.5 MHz to 108.0 MHz
Usable sensitivity	9 dBf (0.8 μV/75 Ω mono, S/N: 30 dB)
Signal-to-noise ratio	72 dB (IEC-A network)

MW tuner

Frequency range	531 kHz to 1 602 kHz (9 kHz)
Usable sensitivity	25 μV (S/N: 20 dB)
Signal-to-noise ratio	62 dB (IEC-A network)

LW tuner

Frequency range	153 kHz to 281 kHz
Usable sensitivity	28 μV (S/N: 20 dB)
Signal-to-noise ratio	62 dB (IEC-A network)

Note

Specifications and the design are subject to modifications without notice. ■

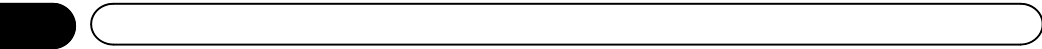

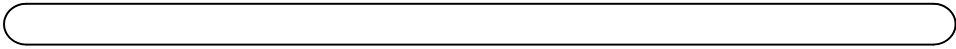

<http://www.pioneer.eu>

Visit www.pioneer.co.uk (or www.pioneer.eu) to register your product.

PIONEER CORPORATION

1-1, Shin-ogura, Saiwai-ku, Kawasaki-shi,
Kanagawa 212-0031, JAPAN

PIONEER ELECTRONICS (USA) INC.

P.O. Box 1540, Long Beach, California 90801-1540, U.S.A.
TEL: (800) 421-1404

PIONEER EUROPE NV

Haven 1087, Keetberglaan 1, B-9120 Melsele, Belgium/Belgique
TEL: (0) 3/570.05.11

PIONEER ELECTRONICS ASIACENTRE PTE. LTD.

253 Alexandra Road, #04-01, Singapore 159936
TEL: 65-6472-7555

PIONEER ELECTRONICS AUSTRALIA PTY. LTD.

5 Arco Lane, Heatherton, Victoria, 3202 Australia
TEL: (03) 9586-6300

PIONEER ELECTRONICS OF CANADA, INC.

300 Allstate Parkway, Markham, Ontario L3R 0P2, Canada
TEL: 1-877-283-5901
TEL: 905-479-4411

PIONEER ELECTRONICS DE MEXICO, S.A. de C.V.

Bldv.Manuel Avila Camacho 138 10 piso
Col.Lomas de Chapultepec, Mexico, D.F. 11000
TEL: 55-9178-4270

先鋒股份有限公司

台北市內湖區瑞光路407號8樓
電話：(02) 2657-3588

先鋒電子（香港）有限公司

香港九龍尖沙咀海港城世界商業中心
9樓901-6室
電話：(0852) 2848-6488

Published by Pioneer Corporation.
Copyright © 2010 by Pioneer Corporation.
All rights reserved.

Free Manuals Download Website

<http://myh66.com>

<http://usermanuals.us>

<http://www.somanuals.com>

<http://www.4manuals.cc>

<http://www.manual-lib.com>

<http://www.404manual.com>

<http://www.luxmanual.com>

<http://aubethermostatmanual.com>

Golf course search by state

<http://golfingnear.com>

Email search by domain

<http://emailbydomain.com>

Auto manuals search

<http://auto.somanuals.com>

TV manuals search

<http://tv.somanuals.com>