

High power CD player with FM/MW/LW tuner

Manual

DEH-P3110

Pioneer



Installation	4	Audio Adjustment	21
Installation with the Rubber Bush	5	Selecting the Equalizer Curve	21
Removing the Unit	5	Entering the Audio Menu	21
Connecting the Units	6	Audio Menu Functions	22
Connection Diagram	8	• Balance Adjustment (FADER)	
Key Finder	10	• Equalizer Curve Adjustment (EQ-LOW/MID/HIGH)	
• Head Unit		• Equalizer Curve Fine Adjustment	
Before Using This Product	11	• Loudness Adjustment (LOUD)	
About This Product	11	• Front Image Enhancer Function (FIE)	
About This Manual	11	• Source Level Adjustment (SLA)	
Precaution	11	Detaching and Replacing	
In Case of Trouble	11	the Front Panel	28
Basic Operation	12	Theft Protection	28
To Listen to Music	12	• Detaching the Front Panel	
Basic Operation of Tuner	13	• Replacing the Front Panel	
• Manual and Seek Tuning		Other Functions	29
• Preset Tuning		Setting the Time	29
• Band		Time Display	30
Basic Operation of Built-in CD Player	14	• Displaying the Time	
• Eject		Using the PROGRAM Button (PGM-FUNC) .	30
• Track Search and Fast Forward/Reverse		• Setting the PROGRAM Button	
• Disc Loading Slot		• Using the PROGRAM Button	
Corresponding Display Indications		Cellular Telephone Muting	32
and Buttons	15	CD Player and Care	33
Entering the Function Menu	16	Precaution	33
Function Menu Functions	17	Built-in CD Player's Error Message	34
Tuner Operation	18	Specifications	35
• Local Seek Tuning (LOCAL)			
• Best Stations Memory (BSM)			
Using the Built-in CD Player	19		
• Repeat Play (REPEAT)			
• Random Play (RANDOM)			
• Scan Play (T-SCAN)			
• Pause (PAUSE)			

Installation

Note:

- Before finally installing the unit, connect the wiring temporarily, making sure it is all connected up properly, and the unit and the system work properly.
- Use only the parts included with the unit to ensure proper installation. The use of unauthorized parts can cause malfunctions.
- Consult with your nearest dealer if installation requires the drilling of holes or other modifications of the vehicle.
- Install the unit where it does not get in the driver's way and cannot injure the passenger if there is a sudden stop, like an emergency stop.
- The semiconductor laser will be damaged if it overheats, so don't install the unit anywhere hot — for instance, near a heater outlet.
- If installation angle exceeds 60° from horizontal, the unit might not give its optimum performance.

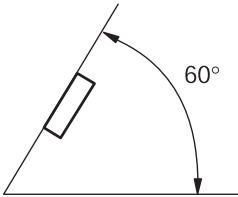

Installation with the Rubber Bush

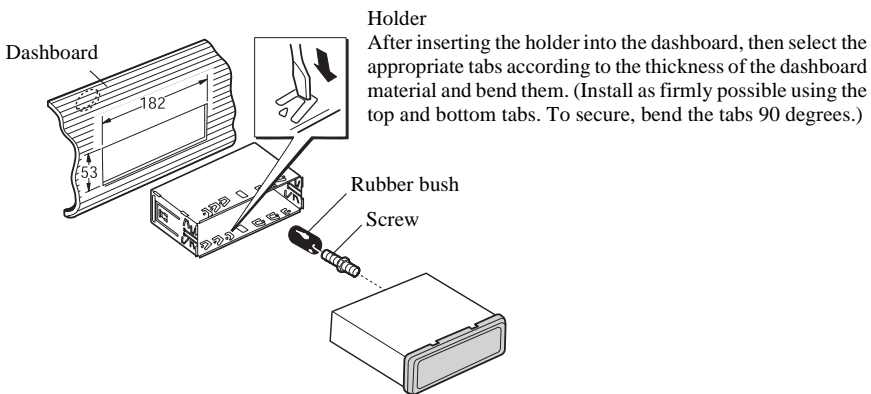

Removing the Unit

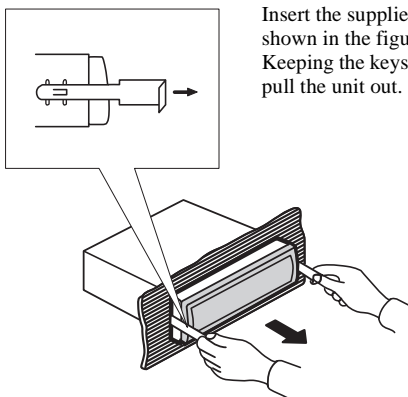

Connecting the Units

- This unit is for vehicles with a 12-volt battery and negative grounding. Before installing it in a recreational vehicle, truck or bus, check the battery voltage.
- To avoid shorts in the electrical system, be sure to disconnect the ⊖ battery cable before beginning installation.
- Refer to the owner's manual for details on connecting the power amp and other units, then make connections correctly.
- Secure the wiring with cable clamps or adhesive tape. To protect the wiring, wrap adhesive tape around them where they lie against metal parts.
- Route and secure all wiring so it cannot touch any moving parts, such as the gear shift, handbrake and seat rails. Do not route wiring in places that get hot, such as near the heater outlet. If the insulation of the wiring melts or gets torn, there is a danger of the wiring short-circuiting to the vehicle body.
- Don't pass the yellow lead through a hole into the engine compartment to connect to the battery. This will damage the lead insulation and cause a very dangerous short.
- Do not shorten any leads. If you do, the protection circuit may fail to work when it should.
- Never feed power to other equipment by cutting the insulation of the power supply lead of the unit and tapping into the lead. The current capacity of the lead will be exceeded, causing overheating.
- When replacing fuse, be sure to use only fuse of the rating prescribed on this unit.
- Since a unique BPTL circuit is employed, never wire so the speaker leads are directly grounded or the left and right ⊖ speaker leads are common.
- The black lead is ground. Please ground this lead separately from the ground of high-current products such as power amps.

If you ground the products together and the ground becomes detached, there is a risk of damage to the products or fire.

- Speakers connected to this unit must be high-power types with minimum rating of 45 W and impedance of 4 to 8 ohms. Connecting speakers with output and/or impedance values other than those noted here may result in the speakers catching fire, emitting smoke, or becoming damaged.
- When this product's source is switched ON, a control signal is output through the blue/white lead. Connect to an external power amp's system remote control or the car's Auto-antenna relay control terminal. (Max. 300 mA 12 V DC.) If the car features a glass antenna, connect to the antenna booster power supply terminal.

- When an external power amp is being used with this system, be sure not to connect the blue/white lead to the amp's power terminal. Likewise, do not connect the blue/white lead to the power terminal of the auto-antenna. Such connection could cause excessive current drain and malfunction.
- To avoid short-circuiting, cover the disconnected lead with insulating tape. Especially, insulate the unused speaker leads without fail. There is a possibility of short-circuiting if the leads are not insulated.
- If this unit is installed in a vehicle that does not have an ACC (accessory) position on the ignition switch, the red lead of the unit should be connected to a terminal coupled with ignition switch ON/OFF operations. If this is not done, the vehicle battery may be drained when you are away from the vehicle for several hours.



ACC position

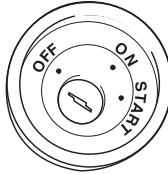

No ACC position

- Cords for this product and those for other products may be different colors even if they have the same function. When connecting this product to another product, refer to the supplied Installation manuals of both products and connect cords that have the same function.

Connection Diagram

This product conforms to new cord colors.

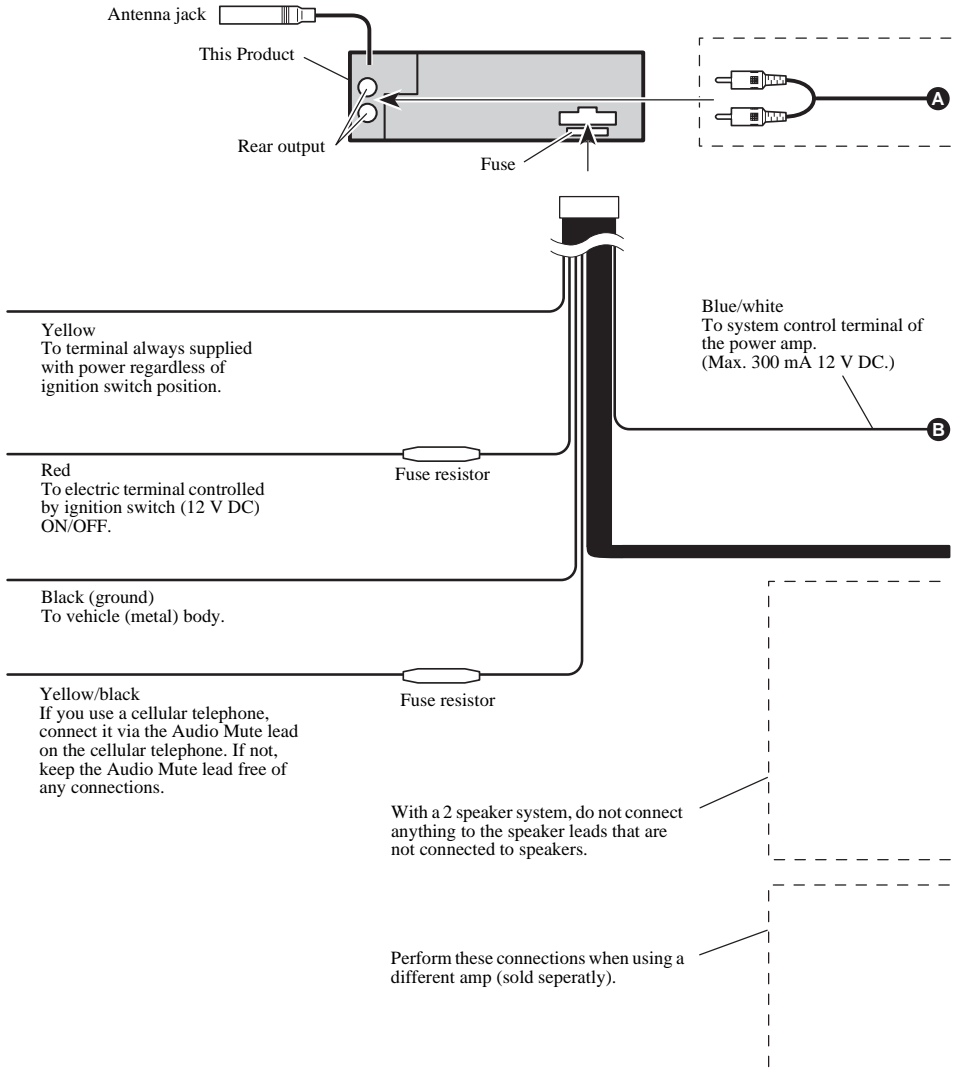

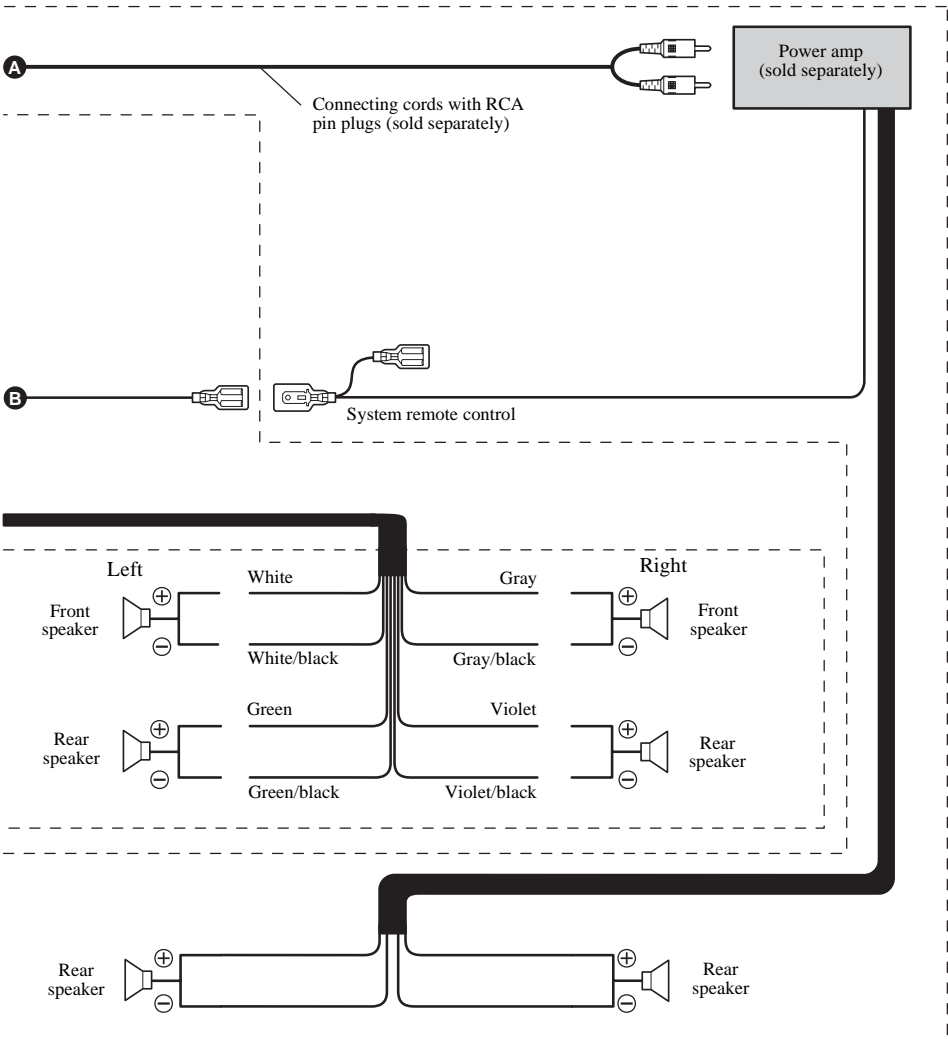

■ Head Unit

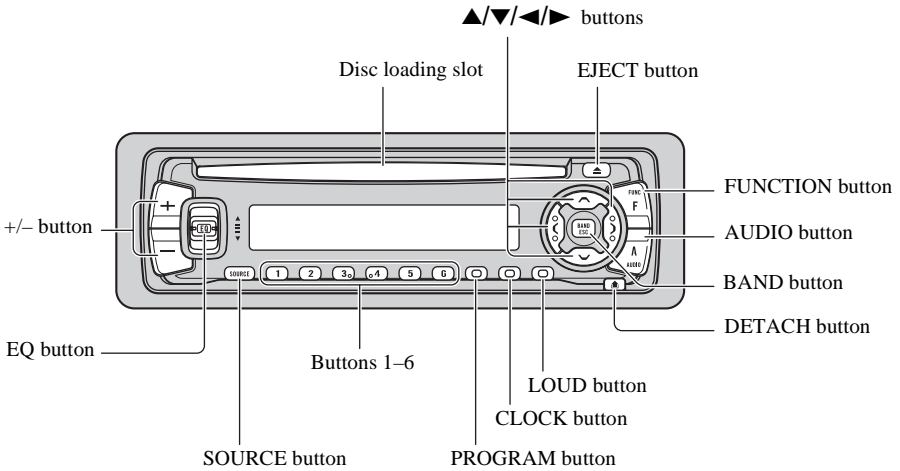

About This Product

The tuner frequencies on this product are allocated for use in Europe, Asia, the Middle East, Africa and Oceania. Use in other areas may result in improper reception.

About This Manual

This product features a number of sophisticated functions ensuring superior reception and operation. All are designed for the easiest possible use, but many are not self-explanatory. This operation manual is intended to help you benefit fully from their potential and to maximize your listening enjoyment.

We recommend that you familiarize yourself with the functions and their operation by reading through the manual before you begin using this product. It is especially important that you read and observe the “Precaution” on this page and in other sections.

Precaution

CAUTION: USE OF CONTROL OR ADJUSTMENT OR PERFORMANCE OF PROCEDURES OTHER THAN THOSE SPECIFIED HEREIN MAY RESULT IN HAZARDOUS RADIATION EXPOSURE.

CAUTION: THE USE OF OPTICAL INSTRUMENTS WITH THIS PRODUCT WILL INCREASE EYE HAZARD.

- Keep this manual handy as a reference for operating procedures and precautions.
- Always keep the volume low enough for outside sounds to be audible.
- Protect the product from moisture.
- If the battery is disconnected, the preset memory will be erased and must be reprogrammed.

In Case of Trouble

Should this product fail to operate properly, contact your dealer or nearest authorized Pioneer Service Station.

To Listen to Music

The following explains the initial of operations required before you can listen to music.

Note:

- Loading a disc in this product. (Refer to page 14.)

1. Select the desired source (e.g. Tuner).

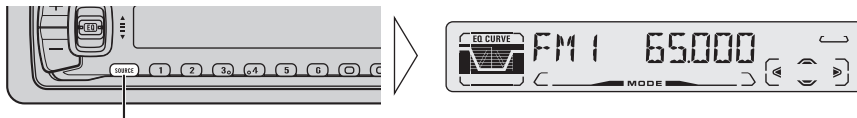

Each press changes the Source ...

Each press of the SOURCE button selects the desired source in the following order:

Built-in CD player → Tuner

Note:

- The sound source will not change if no disc is set in this product.
- When this product's blue/white lead is connected to the car's Auto-antenna relay control terminal, the car's Auto-antenna extends when this product's source is switched ON. To retract the antenna, switch the source OFF.

2. Raise or lower the volume.

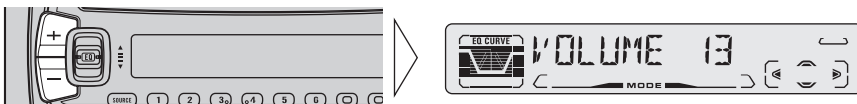

3. Turn the source OFF.

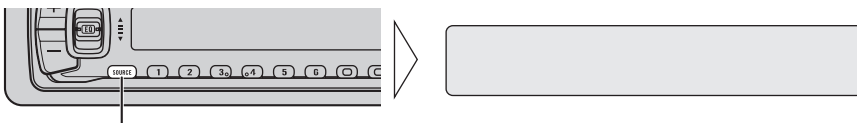

Hold for 1 second

Basic Operation of Tuner

Manual and Seek Tuning

- You can select the tuning method by changing the length of time you press the ◀/▶ button.

Manual Tuning (step by step)	0.5 seconds or less
Seek Tuning	0.5 seconds or more

Note:

- If you continue pressing the button for longer than 0.5 seconds, you can skip broadcast stations. Seek Tuning starts as soon as you release the button.
- Stereo indicator "◉" lights when a stereo station is selected.

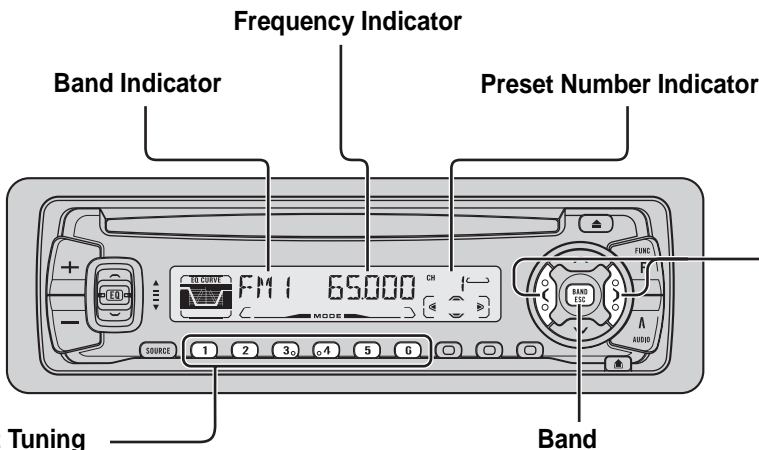

Preset Tuning

- You can memorize broadcast stations in buttons 1 through 6 for easy, one-touch station recall.

Preset station recall	2 seconds or less
Broadcast station preset memory	2 seconds or more

Note:

- Up to 18 FM stations (6 in FM1, FM2 and FM3) and 6 MW/LW stations can be stored in memory.
- You can also use the ▲ or ▼ buttons to recall broadcast stations memorized in buttons 1 through 6.

FM-1 → FM-2 → FM-3
→ MW/LW

Note:

- The FM bands cover different frequency ranges as below:
FM1: 65 — 74 MHz
FM2, FM3: 87.5 — 108 MHz

Basic Operation of Built-in CD Player

Eject

Note:

- The CD function can be turned ON/OFF with the disc remaining in this product. (Refer to page 12.)
- A disc left partially inserted after ejection may incur damage or fall out.

Disc Loading Slot

Note:

- The Built-in CD player plays one standard 12 cm or 8 cm (single) CD at a time. Do not use an adapter when playing 8 cm CD.

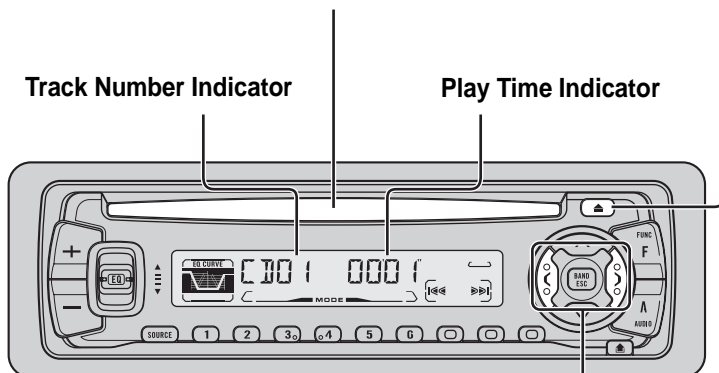

Track Number Indicator

Play Time Indicator

Track Search and Fast Forward/Reverse

- You can select between Track Search or Fast Forward/Reverse by pressing the ◀▶ button for a different length of time.

Track Search	0.5 seconds or less
Fast Forward/Reverse	Continue pressing

Note:

- If a disc cannot be inserted fully or playback fails, make sure the recorded side is down. Press the EJECT button and check the disc for damage before reinserting it.
- If a CD is inserted with the recorded side up, it will be ejected automatically after a few moments.
- If the Built-in CD player cannot operate properly, an error message (such as "ERROR-14") appears on the display. Refer to "Built-in CD Player's Error Message" on page 34.

Corresponding Display Indications and Buttons

This product's display features Key Guidance Indicators. These light to indicate which of the ▲/▼/◀/▶, FUNCTION and AUDIO buttons you can use. When you're in the Function Menu (refer to next section) or Audio Menu (refer to page 21), they also make it easy to see which ▲/▼/◀/▶ buttons you can use to switch functions ON/OFF, switch repeat selections and perform other operations.

Indicator and corresponding buttons are shown below.

■ Head Unit

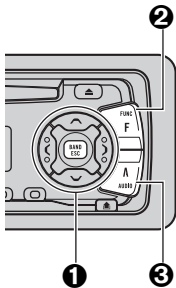

■ Display

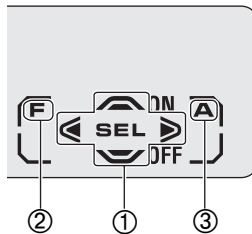

When ① is lit in the display, perform appropriate operations with the ① buttons.

When ② is lit in the display, it indicates that you are in the Function Menu, Time setting mode (refer to page 29) or PROGRAM button's setting mode (refer to page 30). You can switch between each of these menus and between different modes in the menu using button ② on the head unit.

When ③ is lit in the display, it indicates you are in the Audio Menu. You can switch between modes in the Audio Menu using button ③ on the head unit.

Entering the Function Menu

The Function Menu lets you operate simple functions for each source.

Note:

- After entering the Function Menu, if you do not perform an operation within about 30 seconds, the Function Menu is automatically canceled.

1. Select the desired mode in the Function Menu. (Refer to next section, "Function Menu Functions".)

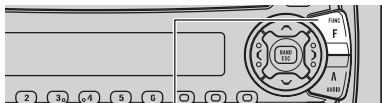

Each press changes the Mode ...



2. Operate a mode. (e.g. Repeat Play)



The button used and the operation it performs are indicated by the key guidance indicator. Press the ▲ button to switch the key guidance indicator ON, and the ▼ button to switch it OFF.

3. Cancel the Function Menu.



Function Menu Functions

The following chart shows functions for each source in the Function Menu.

The chart also shows indications for each function, operations and buttons used to perform operations. For more details, or when you want to know about an operation, refer to the page number indicated in the chart.

■ Tuner

Function name (Display)	Button : Operation	Page
Best Stations Memory (BSM)	▲: ON ▼: OFF	18
Local Seek Tuning (LOCAL)	1 ▲: ON ▼: OFF 2 ◀ or ▶: Select (Sensitivity)	18

■ Built-in CD Player

Function name (Display)	Button : Operation	Page
Repeat Play (REPEAT)	▲: ON ▼: OFF	19
Random Play (RANDOM)	▲: ON ▼: OFF	19
Scan Play (T-SCAN)	▲: ON ▼: OFF	20
Pause (PAUSE)	▲: ON ▼: OFF	20

Tuner Operation

■ Local Seek Tuning (LOCAL)

When Local mode is ON, you can only select broadcast stations providing strong reception.

1. Press the **FUNCTION** button and select the **Local mode (LOCAL)** in the **Function Menu**.

2. Switch the **Local ON/OFF** with the **▲/▼** buttons.



3. Select the desired **Local Seek sensitivity** with the **◀/▶** buttons.



FM : LOCAL 1 ↔ LOCAL 2 ↔ LOCAL 3 ↔ LOCAL 4

MW/LW : LOCAL 1 ↔ LOCAL 2

Note:

- The LOCAL 4 setting allows reception of only the strongest stations, while lower settings let you receive progressively weaker stations.

■ Best Stations Memory (BSM)

The BSM function stores stations in memory automatically.

1. Press the **FUNCTION** button and select the **BSM mode (BSM)** in the **Function Menu**.

2. Switch the **BSM ON** with the **▲** button.

The stations with the strongest signals will be stored under buttons 1– 6 and in order of their signal strength.



- To cancel the process, press the **▼** button in the **Function Menu** before memorization is complete.



Using the Built-in CD Player

■ Repeat Play (REPEAT)

Repeat Play plays the same track repeatedly.

1. Press the **FUNCTION** button and select the Repeat mode (REPEAT) in the Function Menu.
2. Switch the Repeat Play ON/OFF with the ▲/▼ buttons.

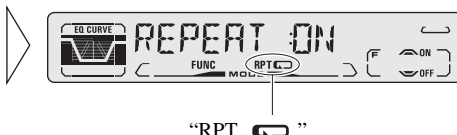

Note:

- If you perform Track Search or Fast Forward/Reverse, Repeat Play is automatically canceled.

■ Random Play (RANDOM)

Random Play plays the tracks on a CD in random order for variety.

1. Press the **FUNCTION** button and select the Random mode (RANDOM) in the Function Menu.
2. Switch the Random Play ON/OFF with the ▲/▼ buttons.



Using the Built-in CD Player

■ Scan Play (T-SCAN)

Scan Play plays the first 10 seconds or so of each track on a CD in succession.

1. Press the **FUNCTION** button and select the Scan mode (**T-SCAN**) in the Function Menu.

2. Switch the Scan Play **ON** with the **▲** button.



3. When you find the desired track, cancel the Scan Play with the **▼** button.



If the Function Menu is automatically canceled at this time, select the Scan mode in the Function Menu once more.

Note:

- Scan Play is canceled automatically after all the tracks on a disc have been scanned.

■ Pause (PAUSE)

Pause pauses the currently playing track.

1. Press the **FUNCTION** button and select the Pause mode (**PAUSE**) in the Function Menu.

2. Switch the Pause **ON/OFF** with the **▲/▼** buttons.



Selecting the Equalizer Curve

You can switch between Equalizer curves.

- Move the EQ button up or down to select the desired Equalizer curve.

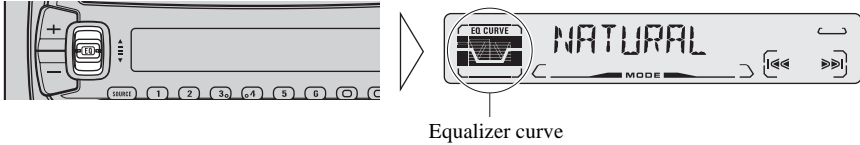

Equalizer curve

POWERFUL ↔ NATURAL ↔ VOCAL ↔ CUSTOM ↔ EQ FLAT ↔ SUPER BASS

Note:

- “CUSTOM” stores an equalizer curve you have made adjustments to. (Refer to “Equalizer Curve Adjustment” on page 23 and “Equalizer Curve Fine Adjustment” on page 24.)
- You can create different “CUSTOM” curves for different sources.

Entering the Audio Menu

With this Menu, you can adjust the sound quality.

Note:

- After entering the Audio Menu, if you do not perform an operation within about 30 seconds, the Audio Menu is automatically canceled.

1. Select the desired mode in the Audio Menu.

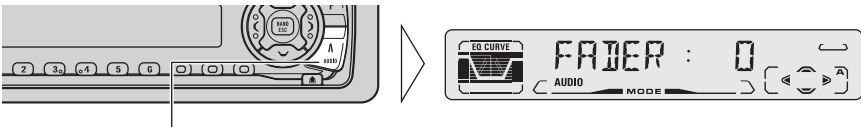

Each press changes the Mode ...

2. Operate a mode.

3. Cancel the Audio Menu.

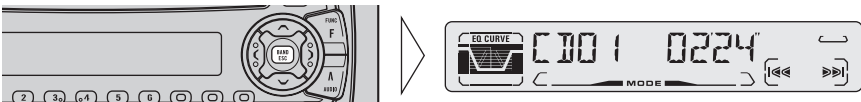

Audio Menu Functions

The Audio Menu features the following functions.

■ **Balance Adjustment (FADER)**

This function allows you to select a Fader/Balance setting that provides ideal listening conditions in all occupied seats.

1. Press the **AUDIO** button and select **Fader/Balance mode (FADER)** in the Audio Menu.

2. Adjust front/rear speaker balance with the **▲/▼** buttons.

“FADER :F15” – “FADER :R15” is displayed as it moves from front to rear.



3. Adjust left/right speaker balance with the **◀▶** buttons.

“BAL :L 9” – “BAL :R 9” is displayed as it moves from left to right.



Note:

- “FADER : 0” is the proper setting when 2 speakers are in use.

■ **Equalizer Curve Adjustment (EQ-LOW/MID/HIGH)**

You can adjust the currently selected equalizer curve settings as desired. Adjusted equalizer curve settings are memorized in “CUSTOM”.

1. Press the **AUDIO** button and select the **Equalizer mode**

(EQ-LOW/MID/HIGH) in the Audio Menu.

2. Select the band you want to adjust with the **◀/▶** buttons.

EQ-LOW ↔ EQ-MID ↔ EQ-HIGH



3. Boost or attenuate the selected band with the **▲/▼** buttons.

The display shows “+6” – “-6”.



Note:

- If you make adjustments when a curve other than “CUSTOM” is selected, the newly adjusted curve will replace the previous adjusted curve. Then a new curve with “CUSTOM” appears on the display while selecting the equalizer curve. (Refer to page 21.)

■ Equalizer Curve Fine Adjustment

You can adjust the center frequency and the Q factor (curve characteristics) of each currently selected curve band (EQ-LOW/MID/HIGH). Adjusted equalizer curve settings are memorized in "CUSTOM".

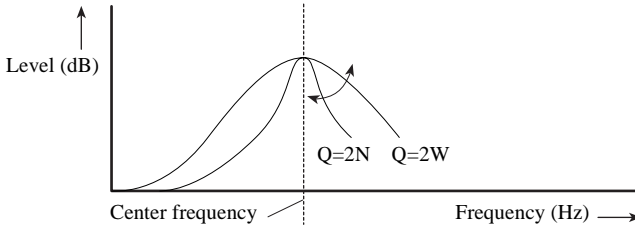

1. Press the **AUDIO** button for 2 or more seconds to select Equalizer Curve Fine Adjustment.

2. Press the **AUDIO** button to select the desired band for adjustment.



3. Select the desired frequency with the **◀/▶** buttons.

LOW: 40 ↔ 80 ↔ 100 ↔ 160 (Hz)
 MID: 200 ↔ 500 ↔ 1K ↔ 2K (Hz)
 HIGH: 3K ↔ 8K ↔ 10K ↔ 12K (Hz)



4. Select the desired Q factor with the **▲/▼** buttons.

2N ↔ 1N ↔ 1W ↔ 2W



Note:

- If you make adjustments when a curve other than "CUSTOM" is selected, the newly adjusted curve will replace the previous adjusted curve. Then a new curve with "CUSTOM" appears on the display while selecting the equalizer curve. (Refer to page 21.)

■ Loudness Adjustment (LOUD)

The Loudness function compensates for deficiencies in the low and high sound ranges at low volume. You can select a desired Loudness level.

1. Press the **AUDIO** button and select the Loudness mode (**LOUD**) in the Audio Menu.

2. Switch the Loudness function ON/OFF with the ▲/▼ buttons.



3. Select the desired level with the ◀/▶ buttons.

LOW ↔ MID ↔ HI



Note:

- You can also switch the Loudness function ON/OFF by pressing the LOUD button. However, you cannot change the level.

■ Front Image Enhancer Function (FIE)

The F.I.E. (Front Image Enhancer) function is a simple method of enhancing front imaging by cutting mid- and high-range frequency output from the rear speakers, limiting their output to low-range frequencies. You can select the frequency you want to cut.

Precaution:

When the F.I.E. function is deactivated, the rear speakers output sound of all frequencies, not just bass sounds. Reduce the volume before disengaging F.I.E. to prevent a sudden increase in volume.

1. Press the **AUDIO** button and select the **F.I.E. mode (FIE)** in the Audio Menu.

2. Switch the **F.I.E. function ON/OFF** with the **▲/▼** buttons.



3. Select the desired frequency with the **◀/▶** buttons.

100 ↔ 160 ↔ 250 (Hz)



Note:

- After switching the F.I.E. function ON, select the Fader/Balance mode in the Audio Menu, and adjust front and rear speaker volume levels until they are balanced.
- Switch the F.I.E. function OFF when using a 2-speaker system.

■ **Source Level Adjustment (SLA)**

The SLA (Source Level Adjustment) function prevents radical leaps in volume when switching between sources. Settings are based on the FM volume, which remains unchanged. (Since the FM volume is the control, SLA is not possible in the FM modes.)

The MW/LW and CD levels can all be adjusted.

- 1. Compare the FM volume with the volume of the other source.
(e.g. Built-in CD player)**
- 2. Press the AUDIO button and select the SLA mode (SLA) in the Audio Menu.**
- 3. Increase or decrease the level with the ▲/▼ buttons.**

The display shows “+4” – “-4”.



Theft Protection

The front panel of the head unit is detachable to discourage theft.

■ Detaching the Front Panel

1. Eject the front panel.



2. To remove the front panel, pull its right-hand side toward you.

Take care not to grip it tightly or drop it.

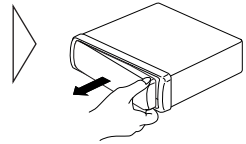

3. Use the protective case provided to store/carry the detached front panel.

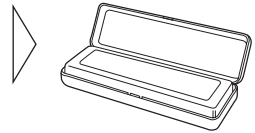

■ Replacing the Front Panel

● Replace the front panel by clipping it into place.

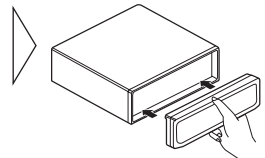

Precaution:

- Never use force or grip the display tightly when removing or replacing the front panel.
- Avoid subjecting the front panel to excessive shocks.
- Keep the front panel out of direct sunlight and high temperatures.

Setting the Time

This is the mode for setting the time on the unit's clock display. (Refer to page 30 for details concerning the clock display.)

1. Switch the sources OFF.
2. Enter the Time setting mode.

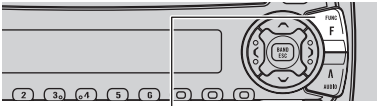

Hold for 2 seconds



3. Select "Hour" or "Minute" with the ◀/▶ buttons.



4. Set as desired time with the ▲/▼ buttons.

As soon as you switch to "Minute", the seconds start counting from 00.



5. Cancel the Time Setting mode.

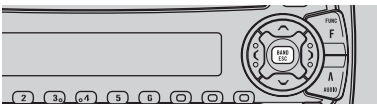

Note:

- Holding down the FUNCTION button for 2 seconds also cancels the Time Setting mode.

Time Display

■ Displaying the Time

- To turn the time display ON.



The time display disappears temporarily when you perform another operation, but the time indication returns to the display after 25 seconds.

Note:

- When the sources are OFF, the Time appears on the display. Pressing the CLOCK button switches the Time display ON/OFF.

Using the PROGRAM Button (PGM-FUNC)

The PROGRAM button can memorize one of the functions in the Function Menu. It is possible to memorize a different function for each source.

■ Setting the PROGRAM Button

1. Enter the PROGRAM button's setting mode (PGM-FUNC).



Hold for 2 seconds

2. Select the function you want to memorize in the PROGRAM button.

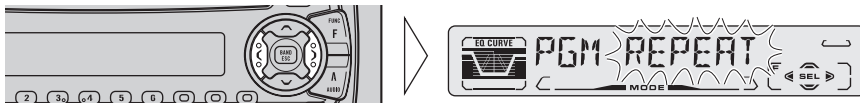

3. Memorize the function in PROGRAM button.



Pressing the BAND button cancels the PROGRAM button's setting mode.

■ Using the PROGRAM Button

The PROGRAM button operates in a different way depending on the function programmed (memorized).

● Use the PROGRAM button.



■ Tuner

Function Name (Display)	Press	Hold for 2 seconds
Best Stations Memory (BSM)	OFF	ON
Local Seek Tuning (LOCAL)	ON/OFF	Entering the Local Seek Sensitivity mode

■ Built-in CD Player

Function Name (Display)	Press	Hold for 2 seconds
Pause (PAUSE)	ON/OFF	—
Repeat Play (REPEAT)	ON/OFF	—
Random Play (RANDOM)	ON/OFF	—

Cellular Telephone Muting

Sound from this system is muted automatically when a call is made or received using a cellular telephone connected to this product.

- The sound is turned off, "MUTE" is displayed and no audio adjustment is possible. Operation returns to normal when the phone connection is ended.



Precaution

- Play only CDs bearing the Compact Disc Digital Audio mark.



- This product is designed for use with conventional, fully circular CDs only. Use of shaped CDs are not recommended for this product.

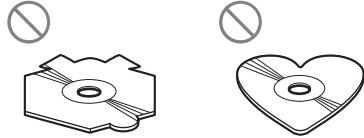

- Check all CDs before playing and discard cracked, scratched or warped discs.
- Playback by this product of a CD-R disc recorded on a CD recorder may not be possible due to characteristics of the disc, scratches or dirt on the disc, or dirt or condensation on this product's optical pickup lens.
- Read the precautions with the CD-R discs before using.

- Wipe dirty or damp discs outward from the center with a soft cloth.

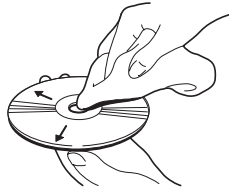

- Avoid touching the recorded (iridescent) surface when handling discs.
- Store discs in their cases when not in use.
- Keep discs out of direct sunlight and high temperatures.
- Do not affix labels or apply chemicals to discs.
- Condensation may collect inside the player when using the heater in cold weather, interfering with playback. Turn it off for an hour or so and wipe damp discs with a soft cloth.
- Road shocks may interrupt CD playback.

Built-in CD Player's Error Message

When problems occur with CD playback, an error message appears on the display. Refer to the table below to identify the problem, then take the suggested corrective action. If the error persists, contact your dealer or your nearest PIONEER Service Center.

Message	Possible cause	Recommended action
ERROR- 11, 12, 17, 30	Dirty disc.	Clean the disc.
ERROR- 11, 12, 17, 30	Scratched disc.	Replace the disc.
ERROR- 14	Unrecorded CD.	Check the disc.
ERROR- 10, 11,12, 14, 17, 30, A0	Electrical or mechanical problem.	Turn the ignition ON and OFF, or switch to a different source, then back to the CD player.
HEAT	CD player overheating.	Discontinue play until the machine temperature drops.

General

Power source	14.4 V DC (10.8 – 15.1 V allowable)
Grounding system	Negative type
Max. current consumption	10.0 A
Dimensions	
(mounting size)	178 (W) × 50 (H) × 159 (D) mm
(front face)	188 (W) × 58 (H) × 19 (D) mm
Weight	1.5 kg

Amplifier

Maximum power output	45 W × 4
Continuous power output	27 W × 4
	(DIN45324, +B = 14.4 V)
Load impedance	4 Ω (4 – 8 Ω allowable)
Preout maximum output level/output impedance	2.2 V/1 kΩ
Equalizer (3-Band Parametric Equalizer)	
(Low)	Frequency: 40/80/100/160 Hz Q Factor: 0.35/0.59/0.95/1.15 (+6 dB when boosted) Level: ±12 dB
(Mid)	Frequency: 200/500/1k/2k Hz Q Factor: 0.35/0.59/0.95/1.15 (+6 dB when boosted) Level: ±12 dB
(High)	Frequency: 3.15k/8k/10k/12.5k Hz Q Factor: 0.35/0.59/0.95/1.15 (+6 dB when boosted) Level: ±12 dB
Loudness contour	
(Low)	+3.5 dB (100 Hz), +3 dB (10 kHz)
(Mid)	+10 dB (100 Hz), +6.5 dB (10 kHz)
(High)	+11 dB (100 Hz), +11 dB (10 kHz) (volume: -30 dB)

CD player

System	Compact disc audio system
Usable discs	Compact disc
Signal format	Sampling frequency: 44.1 kHz Number of quantization bits: 16; linear
Frequency characteristics	5 – 20,000 Hz (±1 dB)
Signal-to-noise ratio	94 dB (1 kHz) (IEC-A network)
Dynamic range	90 dB (1 kHz)
Number of channels	2 (stereo)

FM tuner

Frequency range	65 – 70 MHz 87.5 – 108 MHz
Usable sensitivity	11 dBf (1.0 μV/75 W, mono, S/N: 30 dB)
50 dB quieting sensitivity	17 dBf (1.9 μV/75 Ω, mono)
Signal-to-noise ratio	70 dB (IEC-A network)
Distortion	0.3% (at 65 dBf, 1 kHz, stereo)
Frequency response	30 – 15,000 Hz (±3 dB)
Stereo separation	40 dB (at 65 dBf, 1 kHz)

MW tuner

Frequency range	531 – 1,602 kHz
Usable sensitivity	18 μV (S/N: 20 dB)
Selectivity	50 dB (±9 kHz)

LW tuner

Frequency range	153 – 281 kHz
Usable sensitivity	30 μV (S/N: 20 dB)
Selectivity	50 dB (±9 kHz)

Note:

- Specifications and the design are subject to possible modification without notice due to improvements.

France: tapez 36 15 PIONEER

PIONEER ELECTRONIC CORPORATION

1-4-1 MEGURO, MEGURO-KU, TOKYO 153-8654, JAPAN

PIONEER ELECTRONICS (USA) INC.

P.O. Box 1760, Long Beach, California 90801, U.S.A.

TEL: (800) 421-1404

PIONEER ELECTRONIC (EUROPE) N.V.

Haven 1087 Keetberglaan 1, 9120 Melsele, Belgium

TEL:(0) 3/570.05.11

PIONEER ELECTRONICS AUSTRALIA PTY. LTD.

178-184 Boundary Road, Braeside, Victoria 3195, Australia

TEL: (03) 580-9911

PIONEER ELECTRONICS OF CANADA, INC.

300 Allstate Parkway, Markham, Ontario L3R 0P2, Canada

TEL: (905) 479-4411

PIONEER ELECTRONICS DE MEXICO, S.A. de C.V.

San Lorenzo Num 1009 3er piso Desp. 302

Col. Del Valle, Mexico D.F. C.P. 03100

TEL: 5-688-52-90

Published by Pioneer Electronic Corporation. Copyright © 1999 by Pioneer Electronic Corporation. All rights reserved.

Printed in Belgium

Free Manuals Download Website

<http://myh66.com>

<http://usermanuals.us>

<http://www.somanuals.com>

<http://www.4manuals.cc>

<http://www.manual-lib.com>

<http://www.404manual.com>

<http://www.luxmanual.com>

<http://aubethermostatmanual.com>

Golf course search by state

<http://golfingnear.com>

Email search by domain

<http://emailbydomain.com>

Auto manuals search

<http://auto.somanuals.com>

TV manuals search

<http://tv.somanuals.com>