

Operation Manual

CD RECEIVER

DEH-P6000UB

SUPER  **TUNER III D**

English

Thank you for buying this Pioneer product.

Please read through these operating instructions so you will know how to operate your model properly. *After you have finished reading the instructions, keep this manual in a safe place for future reference.*

01 Before You Start

- Information to User **5**
- For Canadian model **5**
- About this unit **5**
- After-sales service for Pioneer products **7**
- Visit our website **7**
- In case of trouble **7**
- Protecting your unit from theft **7**
 - Removing the front panel **8**
 - Attaching the front panel **8**
- Resetting the microprocessor **8**
- About the demo mode **8**
- Use and care of the remote control **9**
 - Installing the battery **9**
 - Using the remote control **9**

02 Operating this unit

- What's What **10**
 - Head unit **10**
 - Remote control **11**
- Basic Operations **12**
 - Power ON/OFF **12**
 - Selecting a source **12**
 - Adjusting the volume **12**
- Tuner **13**
 - Basic Operations **13**
 - Storing and recalling broadcast frequencies **13**
 - Introduction of advanced operations **13**
 - Storing the strongest broadcast frequencies **14**
 - Tuning in strong signals **14**
- Built-in CD Player **15**
 - Basic Operations **15**
 - Selecting a track directly **16**
 - Displaying text information on disc **16**
 - Selecting tracks from the track title list **16**

- Selecting files from the file name list **17**
- Introduction of advanced operations **17**
- Selecting a repeat play range **17**
- Playing tracks in random order **17**
- Scanning folders and tracks **18**
- Pausing playback **18**
- Using Sound Retriever **18**
- Using disc title functions **18**
- Playing songs on USB portable audio player/USB memory **19**
 - Basic Operations **19**
 - Selecting an audio file directly in the current folder **20**
 - Displaying text information of an audio file **20**
 - Selecting files from the file name list **20**
 - Introduction of advanced operations **20**
- Playing songs on iPod **21**
 - Basic Operations **21**
 - Browsing for a song **22**
 - Displaying text information on iPod **22**
 - Introduction of advanced operations **22**
 - Playing songs in a random order (shuffle) **23**
 - Playing all songs in a random order (shuffle all) **23**
 - Selecting songs from album list of currently playing artist **23**
 - Operating this unit's iPod function from your iPod **24**
 - Changing audiobook speed **24**

03 Audio Adjustments

- Introduction of audio adjustments **25**
- Using balance adjustment **25**

- Using the equalizer **25**
 - Recalling equalizer curves **25**
 - Adjusting equalizer curves **26**
 - Adjusting 7-band graphic equalizer **26**
- Adjusting loudness **27**
- Using subwoofer output **27**
 - Adjusting subwoofer settings **27**
- Boosting the bass **28**
- Using the high pass filter **28**
- Adjusting source levels **28**

04 Initial Settings

- Adjusting initial settings **29**
- Selecting the display language **29**
- Setting the date **29**
- Setting the clock **30**
- Switching the warning tone **30**
- Switching the face auto open **30**
- Switching the auxiliary setting **30**
- Switching the dimmer setting **30**
- Adjusting the brightness **31**
- Setting the rear output and subwoofer controller **31**
- Switching the sound muting/attenuation **31**
- Switching the feature demo **32**
- Switching the reverse mode **32**
- Switching the ever scroll **32**
- Activating the BT Audio source **32**
- Entering PIN code for Bluetooth wireless connection **33**
- Displaying system version for repair **33**

05 Other Functions

- Using the AUX source **34**
 - About AUX1 and AUX2 **34**
 - AUX1 source: **34**
 - AUX2 source: **34**
 - Selecting AUX as the source **34**
 - Setting the AUX title **34**
- Using the external unit **34**

- Selecting the external unit as the source **34**
- Basic operation **35**
- Using the functions allocated to 1 to 6 keys **35**
- Advanced operations **35**
- Turning the clock display on or off **35**
- Switching the display indication and button illumination **35**
- Using different entertainment displays **36**
- Using the PGM button **36**

06 Available accessories

- Playing songs on iPod **37**
 - Basic operation **37**
 - Displaying text information on iPod **37**
 - Browsing for a song **37**
 - Introduction of advanced operations **37**
 - Playing songs in a random order (shuffle) **38**
- Bluetooth Audio **38**
 - Basic Operations **38**
 - Function and operation **39**
 - Connecting a Bluetooth audio player **39**
 - Playing songs on Bluetooth audio player **40**
 - Stopping playback **40**
 - Disconnecting a Bluetooth audio player **40**
 - Displaying BD (Bluetooth Device) address **40**
- Bluetooth Telephone **40**
 - Basic Operations **40**
 - Setting up for hands-free phoning **41**
 - Making a phone call **42**
 - Taking a phone call **42**
 - Function and operation **42**
 - Connecting a cellular phone **43**

- Disconnecting a cellular phone **44**
- Registering a connected cellular phone **44**
- Deleting a registered phone **44**
- Connecting to a registered cellular phone **45**
- Using the phone book **45**
- Using the call history **47**
- Using preset numbers **48**
- Making a call by entering phone number **48**
- Clearing memory **48**
- Setting automatic rejecting **49**
- Setting automatic answering **49**
- Switching the ring tone **49**
- Echo canceling and noise reduction **49**
- XM tuner **49**
 - Listening to XM Satellite Radio **49**
 - Selecting an XM channel directly **50**
 - Switching the XM display **50**
 - Storing and recalling broadcast stations **50**
 - Switching the XM channel select mode **51**
 - Displaying the Radio ID **51**
- SIRIUS Satellite Radio tuner **51**
 - Listening to SIRIUS Satellite Radio **51**
 - Selecting a SIRIUS channel directly **52**
 - Switching the SIRIUS display **52**
 - Storing and recalling broadcast stations **52**
 - Introduction of advanced operations **53**
 - Selecting the SIRIUS channel select mode **53**
 - Using the Game Alert function **53**
 - Displaying the Radio ID **54**
 - Using Instant Replay function **55**
- Multi-CD Player **55**
 - Basic Operations **55**
 - Using CD TEXT functions **55**
 - Introduction of advanced operations **56**
 - Using compression and bass emphasis **56**
 - Using ITS playlists **57**
 - Using disc title functions **58**
- DVD Player **59**
 - Basic Operations **59**
 - Selecting a disc **60**
 - Selecting a folder **60**
 - Introduction of advanced operations **60**
- TV tuner **61**
 - Basic Operations **61**
 - Storing and recalling broadcast stations **61**
 - Storing the strongest broadcast stations sequentially **62**
- **Additional Information**
 - Error messages **63**
 - Handling guideline of discs and player **64**
 - Dual Discs **65**
 - Compressed audio compatibility **65**
 - USB audio player/USB memory **65**
 - USB audio player/USB memory compatibility **65**
 - Handling guideline and supplemental information **66**
 - iPod **67**
 - About handling the iPod **67**
 - About iPod settings **67**
 - Compressed audio files on the disc **67**
 - Example of a hierarchy **68**
 - Specifications **69**

Before You Start

Information to User

Alteration or modifications carried out without appropriate authorization may invalidate the user's right to operate the equipment.



For Canadian model

This Class B digital apparatus complies with Canadian ICES-003.



About this unit

The tuner frequencies on this unit are allocated for use in North America. Use in other areas may result in poor reception.

WARNING

Handling the cord on this product or cords associated with accessories sold with the product may expose you to chemicals listed on proposition 65 known to the State of California and other governmental entities to cause cancer and birth defects or other reproductive harm. ***Wash hands after handling.***

CAUTION:
USE OF CONTROL OR ADJUSTMENT OR PERFORMANCE OF PROCEDURES OTHER THAN THOSE SPECIFIED HEREIN MAY RESULT IN HAZARDOUS RADIATION EXPOSURE.

CAUTION:
THE USE OF OPTICAL INSTRUMENTS WITH THIS PRODUCT WILL INCREASE EYE HAZARD.

CAUTION

- Do not allow this unit to come into contact with liquids. Electrical shock could result.

Also, damage to this unit, smoke, and overheating could result from contact with liquids.

- Keep this manual handy as a reference for operating procedures and precautions.
- Always keep the volume low enough so that you can hear sounds from outside the vehicle.
- Protect this unit from moisture.
- If the battery is disconnected or discharged, the preset memory will be erased and must be reprogrammed.

Important (Serial number)

The serial number is located on the bottom of this unit. For your own security and convenience, be sure to record this number on the enclosed warranty card.

About WMA



The Windows Media™ logo printed on the box indicates that this unit can play back WMA data.

Windows Media and the Windows logo are trademarks or registered trademarks of Microsoft Corporation in the United States and/or other countries.

- This unit may not operate correctly depending on the application used to encode WMA files.

Before You Start

About MP3

Supply of this product only conveys a license for private, non-commercial use and does not convey a license nor imply any right to use this product in any commercial (i.e. revenue-generating) real time broadcasting (terrestrial, satellite, cable and/or any other media), broadcasting/streaming via internet, intranets and/or other networks or in other electronic content distribution systems, such as pay-audio or audio-on-demand applications. An independent license for such use is required. For details, please visit <http://www.mp3licensing.com>.

About AAC

This unit plays back AAC files encoded by iTunes®. iTunes is a trademark of Apple Inc., registered in the U.S. and other countries.

Portable audio player compatibility

- Inquire at the manufacturer about your USB portable audio player/USB memory.

This unit corresponds to the following.

- USB MSC (Mass Storage Class) compliant portable audio player and memory
 - WMA, MP3, AAC and WAV file playback
- For details about the compatibility, refer to *USB audio player/USB memory compatibility* on page 65.

iPod® compatibility

This unit can control and listen to songs on an iPod.

- This unit supports only an iPod with Dock Connector.
- This unit supports only the following iPods. Supported iPod software versions are shown below. Older versions of iPod software may not be supported.
 - iPod fifth generation (software version 1.2.1)
 - iPod nano first generation (software version 1.3.1)
 - iPod nano second generation (software version 1.1.3)

- iPod nano third generation (software version 1.0.2)
- iPod classic (software version 1.0.2)
- iPod touch (software version 1.1.1)

For maximum performance, we recommend that you use the latest version of the iPod software.

- Operations may vary depending on the software version of iPod.
- When using an iPod, iPod Dock Connector to USB Cable is required.
- Pioneer CD-IU50 interface cable is also available. For details, consult your dealer.
- This unit can control previous generations iPod models with a Pioneer iPod adapter (e.g. CD-IB100II). For details concerning operation with the iPod adapter, refer to *Playing songs on iPod* on page 37.
- iPod is a trademark of Apple Inc., registered in the U.S. and other countries.

About the SAT RADIO READY mark



The SAT RADIO READY mark printed on the front panel indicates that the Satellite Radio Tuner for Pioneer (i.e., XM tuner and Sirius satellite tuner which are sold separately) can be controlled by this unit. Please inquire to your dealer or nearest authorized Pioneer service station regarding the satellite radio tuner that can be connected to this unit. For satellite radio tuner operation, please refer to the satellite radio tuner owner's manual.

- The system will use direct satellite-to-receiver broadcasting technology to provide listeners in their cars and at home with crystal-clear sound seamlessly from coast to coast. Satellite radio will create and package over 100 channels of digital-quality music, news, sports, talk and children's programming.
- "SAT Radio", the SAT Radio logo and all related marks are trademarks of Sirius Satellite Radio inc., and XM Satellite Radio Inc.

Before You Start

CAUTION

- Pioneer accepts no responsibility for data lost on the USB portable audio player/USB memory even if that data is lost while using this unit.
- Pioneer accepts no responsibility for data lost on the iPod even if that data is lost while using this unit. 

After-sales service for Pioneer products

Please contact the dealer or distributor from where you purchased this unit for after-sales service (including warranty conditions) or any other information. In case the necessary information is not available, please contact the companies listed below:

Please do not ship your unit to the companies at the addresses listed below for repair without advance contact.

U.S.A.

Pioneer Electronics (USA) Inc.
CUSTOMER SUPPORT DIVISION
P.O. Box 1760
Long Beach, CA 90801-1760
800-421-1404

CANADA

Pioneer Electronics of Canada, Inc.
CUSTOMER SATISFACTION DEPARTMENT
300 Allstate Parkway
Markham, Ontario L3R 0P2
1-877-283-5901
905-479-4411

For warranty information please see the Limited Warranty sheet included with this unit. 

Visit our website

Visit us at the following site:

<http://www.pioneerelectronics.com>

- 1 Register your product. We will keep the details of your purchase on file to help you refer to this information in the event of an insurance claim such as loss or theft.
- 2 Receive updates on the latest products and technologies.
- 3 Download owner's manuals, order product catalogues, research new products, and much more. 

In case of trouble

Should this product fail to operate properly, contact your dealer or nearest authorized Pioneer Service Station. 

Protecting your unit from theft

The front panel can be detached to deter theft.

- If the front panel is not detached from the head unit within five seconds of turning off the ignition, a warning tone sounds.
- You can turn off the warning tone. See *Switching the warning tone* on page 30.
- You can turn off the face auto open. See *Switching the face auto open* on page 30.



Important

- Handle gently when removing or attaching the front panel.
- Avoid subjecting the front panel to excessive shock.
- Keep the front panel out of direct sunlight and high temperatures.
- A few seconds after turning the ignition switch to on or off, the front panel automatically moves. When this happens, your fingers may become jammed in the panel, so keep your hands away from it.

Before You Start

Removing the front panel

1 Press and hold OPEN to open the front panel.

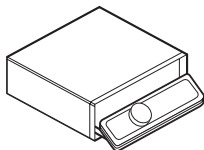

2 Slide and remove the front panel toward you.

Take care not to grip it too tightly or to drop the front panel and protect it from contact with water or other fluids to prevent permanent damage.

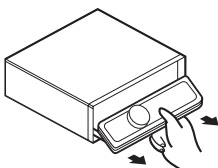

3 Put the front panel into the provided protective case for safe keeping.

Attaching the front panel

1 Make sure the inner cover is closed.

2 Replace the front panel by clipping it into place.

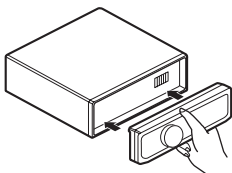

Resetting the microprocessor

The microprocessor must be reset under the following conditions:

- Prior to using this unit for the first time after installation
- If the unit fails to operate properly
- When strange or incorrect messages appear on the display

● Press **RESET** with a pen tip or other pointed instrument.

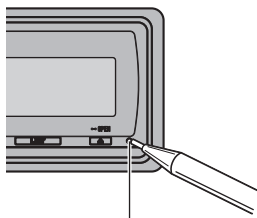

RESET button



About the demo mode

This unit features two demonstration modes. One is the reverse mode, the other is the feature demo mode.

Important

The red lead (ACC) of this unit should be connected to a terminal coupled with ignition switch on/off operations. If this is not done, the vehicle battery may be drained.

Reverse mode

If you do not perform an operation within about 30 seconds, screen indications start to reverse, and then continue reversing every 10 seconds. Pressing **BAND** when power to this unit is turned off while the ignition switch is set to ACC or ON cancels the reverse mode. Press **BAND** again to start the reverse mode.



Before You Start

Feature demo mode

The feature demo automatically starts when power to this unit is turned off while the ignition switch is set to ACC or ON. Press **DISP** during feature demo operation to cancel the feature demo mode. Press **DISP** again to start. Remember that if the feature demo continues operating when the car engine is turned off, it may drain battery power. 

Use and care of the remote control

Installing the battery

Slide the tray on the back of the remote control out and insert the battery with the plus (+) and minus (-) poles aligned properly.

- When using for the first time, pull out the film protruding from the tray.

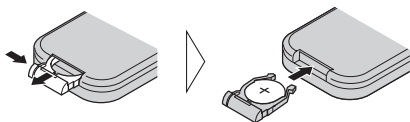

WARNING

Keep the battery out of the reach of children. Should the battery be swallowed, consult a doctor immediately.

CAUTION

- Use one **CR2025 (3V)** lithium battery.
- Remove the battery if the remote control is not used for a month or longer.
- There is a danger of explosion if the battery is incorrectly replaced. Replace only with the same or equivalent type.
- Do not handle the battery with metallic tools.
- Do not store the battery with metallic objects.
- If the battery leaks, wipe the remote control completely clean and install a new battery.
- When disposing of used batteries, comply with governmental regulations or environmen-

tal public institutions' rules that apply in your country/area.

- "Perchlorate Material – special handling may apply.
See www.dtsc.ca.gov/hazardouswaste/perchlorate. (Applicable to California, U.S.A.)"

Using the remote control

Point the remote control in the direction of the front panel to operate.

- The remote control may not function properly in direct sunlight.

Important

- Do not store the remote control in high temperatures or direct sunlight.
- Do not let the remote control fall onto the floor, where it may become jammed under the brake or accelerator pedal. 

Operating this unit

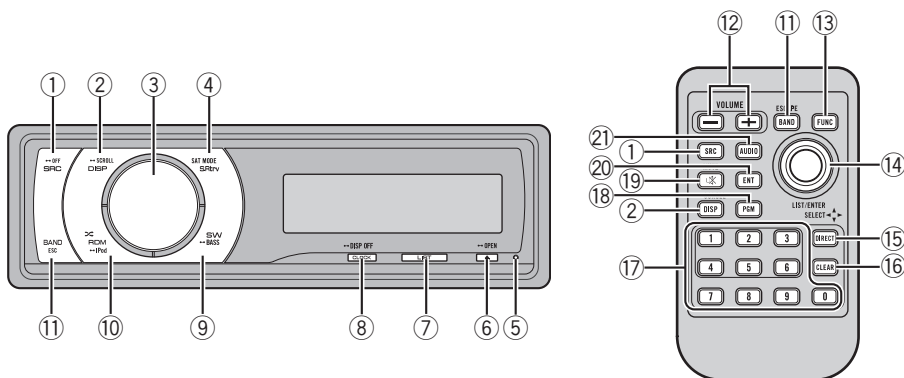

What's What

Head unit

① SRC/OFF button

This unit is turned on by selecting a source. Press to cycle through all the available sources.

② DISP/SCROLL button

Press to select different displays. Press and hold to scroll the text information.

③ MULTI-CONTROL

Move to perform manual seek tuning, fast forward, reverse and track search controls. Also used for controlling functions. Turn to increase or decrease the volume.

④ S.Rtrv/SAT MODE button

Press to switch Sound Retriever settings. When XM tuner or SIRIUS tuner is selected as the source, press to change the channel select mode. When SIRIUS tuner is selected as the source, press and hold to perform the Instant Replay mode.

⑤ RESET button

Press to reset the microprocessor.

⑥ EJECT/OPEN button

Press to eject a CD from your built-in CD player. Press and hold to open or close the front panel.

⑦ LIST button

Press to display the disc title list, track title list, folder list, file list or preset channel list depending on the source.

⑧ CLOCK/DISP OFF button

Press to change to the clock display. Press and hold to turn the display indication and button illumination off or on.

⑨ SW/BASS button

Press to switch to subwoofer setting menu. When operating subwoofer menu, press to switch setting. Press and hold to switch to bass boost menu.

⑩ RDM/iPod button

Press to turn random function on or off while using CD or USB.

Operating this unit

While using iPod, press this button to shuffle all tracks.

Press and hold to switch the control mode while using an iPod connected USB connector of this unit.

If using the iPod with an interface adapter (CD-IB100II), press to switch the shuffle function.

⑪ BAND/ESC button

Press to select among three FM bands and one AM band.

Press to return to the ordinary display when operating menu.

Remote control

Operation is the same as when using the buttons on the head unit.

⑫ VOLUME buttons

Press to increase or decrease the volume.

⑬ FUNCTION button

Press to select functions.

⑭ Thumb pad

Move to perform manual seek tuning, fast forward, reverse and track search controls. Also used for controlling functions.

Functions are the same as

MULTI-CONTROL except for volume control.

Press to display the disc title list, track title list, folder list, file list or preset channel list depending on the source.

⑮ DIRECT button

Press to directly select the desired track.

⑯ CLEAR button

Press to cancel the input number when **0** to **9** are used.

⑰ 0 to 9 buttons

Press to directly select the desired track, preset tuning or disc. Buttons **1** to **6** can operate the preset tuning for the tuner or disc number search for the multi-CD player.

⑱ PGM button

Press to operate the preprogrammed functions for each source. (Refer to *Using the PGM button* on page 36.)

⑲ MUTE button

Press to turn off the sound. To turn on the sound, press again.

⑳ ENT button

Press to change to the entertainment display.

㉑ AUDIO button

Press to select various sound quality controls. 

Basic Operations

Power ON/OFF

Turning the unit on

- Press **SRC** to turn the unit on.

Turning the unit off

- Press **OFF** and hold until the unit turns off.

Selecting a source

You can select a source you want to listen to. To switch to the built-in CD player, load a disc in the unit (refer to page 15).

- Press **SRC** repeatedly to switch between the following sources.
XM tuner—SIRIUS tuner—Tuner—Television—DVD player/Multi-DVD player—Built-in CD player—Multi-CD player—iPod—USB—External unit 1—External unit 2—AUX1—AUX2—BT Audio—BT Telephone



Notes

- In the following cases, the sound source will not change.
 - When no unit corresponding to the selected source is connected.
 - When there is no disc or magazine in the player.
 - When the iPod is not connected to this unit.
 - When AUX (auxiliary input) is set to off (refer to page 30).
 - When the **BT Audio** source is set to off (refer to *Activating the BT Audio source* on page 32).
- AUX1 is set to on by default. Turn off the AUX1 when not in use (refer to *Switching the auxiliary setting* on page 30).
- Charging the portable audio player using car's DC power source while connecting it to

AUX input may generate noise. In this case, stop charging.

- External unit refers to a Pioneer product (such as ones available in the future) that, although incompatible as a source, enables control of basic functions with this unit. Two external units can be controlled with this unit. When two external units are connected, the external unit is automatically allocated to external unit 1 or external unit 2 by this unit.
- When this unit's blue/white lead is connected to the vehicle's auto-antenna relay control terminal, the vehicle's antenna extends when this unit's source is turned on. To retract the antenna, turn the source off.

Adjusting the volume

- Turn **MULTI-CONTROL** to adjust the sound level. 

Operating this unit

Tuner

Basic Operations

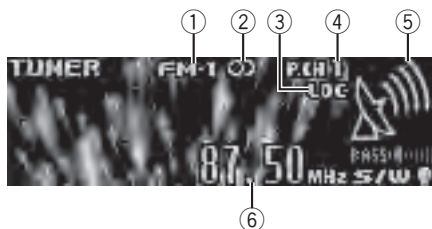

- ① Band indicator
- ② (stereo) indicator
Appears when the selected frequency is being broadcast in stereo.
- ③ **LOC** indicator
Appears when local seek tuning is on.
- ④ Preset number indicator
- ⑤ Signal level indicator
Shows the radio wave strength.
- ⑥ Frequency indicator

● Select a band

Press **BAND**.

- Band can be selected from among **FM1**, **FM2**, **FM3** or **AM**.

● Manual tuning (step by step)

Push **MULTI-CONTROL** left or right.

● Seek tuning

Push and hold **MULTI-CONTROL** left or right for about one second and release.

- You can cancel seek tuning by pushing **MULTI-CONTROL** left or right.
- If you push and hold **MULTI-CONTROL** left or right, you can skip stations. Seek tuning starts as soon as you release **MULTI-CONTROL**.

Storing and recalling broadcast frequencies

You can easily store up to six broadcast frequencies for later recall.

- Six stations for each band can be stored in memory.

1 Press **LIST**.

Preset screen is displayed.

2 Use **MULTI-CONTROL** to store the selected frequency in memory.

Turn to change the preset number. Press and hold to store.

3 Use **MULTI-CONTROL** to select the desired station.

Turn to change the station. Press to select.

- You can also change the station by pushing **MULTI-CONTROL** up or down.
- To return to the ordinary display, press **BAND** or **LIST**.
- If you do not operate the list within about 30 seconds, the display automatically returns to the ordinary display.

Using the remote control

- **When you find a frequency that you want to store in memory, press one of preset tuning buttons 1 to 6 and hold until the preset number stops flashing.**

The number you have pressed will flash in the preset number indicator and then remain lit. The selected radio station frequency has been stored in memory.

The next time you press the same preset tuning button the radio station frequency is recalled from memory.

- You can also recall radio station frequencies assigned to preset tuning numbers by pushing **MULTI-CONTROL** up or down during the frequency display.

Introduction of advanced operations

1 Press **MULTI-CONTROL** to display the main menu.

2 Use **MULTI-CONTROL** to select **FUNCTION**.

Turn to change the menu option. Press to select.

Operating this unit

The function menu is displayed.

3 Turn MULTI-CONTROL to select the function.

BSM (best stations memory)—**Local** (local seek tuning)



Notes

- You can also select the function by pressing **FUNCTION** on the remote control.
- To return to the ordinary display, press **BAND**.

Storing the strongest broadcast frequencies

BSM (best stations memory) lets you automatically store the six strongest broadcast frequencies.

1 Display the function menu.

Refer to *Introduction of advanced operations* on the previous page.

2 Use MULTI-CONTROL to select BSM in the function menu.

3 Press MULTI-CONTROL to turn BSM on.

The six strongest broadcast frequencies are stored in the order of their signal strength.

- To cancel, press **MULTI-CONTROL** again.

Tuning in strong signals

Local seek tuning lets you tune in only those radio stations with sufficiently strong signals for good reception.

1 Display the function menu.

Refer to *Introduction of advanced operations* on the previous page.

2 Use MULTI-CONTROL to select Local in the function menu.

3 Press MULTI-CONTROL to turn local seek tuning on.

- To turn local seek tuning off, press **MULTI-CONTROL** again.

4 Push MULTI-CONTROL left or right to set the sensitivity.

FM: **Level 1—Level 2—Level 3—Level 4**

AM: **Level 1—Level 2**

The **Level 4** setting allows reception of only the strongest stations, while lower settings let you receive progressively weaker stations.

Operating this unit

Built-in CD Player

Basic Operations



- ① **WMA/MP3/AAC/WAV** indicator
Shows the type of audio file currently playing when the compressed audio is playing.
- ② Folder number indicator
Shows the folder number currently playing when the compressed audio is playing.
- ③ Track number indicator
- ④ Play time indicator
- ⑤ Bit rate/sampling frequency indicator
Shows the bit rate or sampling frequency of the current track (file) when the compressed audio is playing.
 - When playing back VBR (variable bit rate)-recorded WMA files, the average bit rate value is displayed.
 - When playing back VBR (variable bit rate)-recorded MP3 files, **VBR** is displayed instead of bit rate value.

● Open the front panel

Press **EJECT**.

Disc loading slot appears.

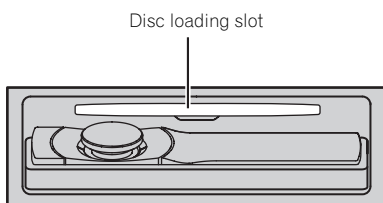

- **When loading a disc, face the label side of a disc up.**

● Eject a disc

Press **EJECT**.

● Select a folder

Push **MULTI-CONTROL** up or down.

- You cannot select a folder that does not have a compressed audio file recorded in it.

● Select a track

Push **MULTI-CONTROL** left or right.

● Fast forward or reverse

Push and hold **MULTI-CONTROL** left or right.

- When playing compressed audio, there is no sound on fast forward or reverse.

● Return to root folder

Press and hold **BAND**.

- If folder 01 (ROOT) contains no files, playback commences with folder 02.

● Switch between compressed audio and CD-DA

Press **BAND**.

- This operation is available only when playing CD-EXTRA or MIXED-MODE CDs.
- If you have switched between compressed audio and CD-DA, playback starts at the first track on the disc.

Notes

- The built-in CD player can play back audio CD and compressed audio recorded on a CD-ROM. (Refer to page 67 for files that can be played back.)
- Read the precautions for discs and player on page 64.
- After a disc has been inserted, press **SRC** to select the built-in CD player.
- There is sometimes a delay between starting up disc playback and the sound being issued. When being read, **FORMAT READ** is displayed.
- If an error message is displayed, refer to *Error messages* on page 63.
- Playback is carried out in order of file number. Folders are skipped if they contain no files. (If folder 01 (ROOT) contains no files, playback commences with folder 02.)
- You can eject the CD by pressing and holding **EJECT** with eject position when the CD loading or ejecting cannot operate properly.

Selecting a track directly

When using the remote control, you can select a track directly by entering the desired track number.

- When audio files are being played back, you can select track in the current folder.

1 Press DIRECT.

Track number input display appears.

2 Press 0 to 9 buttons to enter the desired track number.

- You can cancel the input number by pressing CLEAR.

3 Press DIRECT.

The track for the entered number will play.

- After entering the number input mode, if you do not perform an operation within about eight seconds, the mode is automatically canceled.

Displaying text information on disc

● Press DISP to select the desired text information.

• For title entered CD

Play time—: disc title and play time

• For CD TEXT discs

Play time—: disc artist name and : track title

—: disc artist name and : disc title

—: disc title and : track title

—: track artist name and : track title

—: track title and play time—: track title, : track artist name and : disc title

—: track artist name and : disc title

• For WMA/MP3/AAC

Play time—: folder name and : file name

—: artist name and : track title

—: artist name and : album title—: album title and : track title—: track title and play time—: comment and play time—: track title, : artist name and : album title

—: album title

—: album title

—: album title

—: album title

• For WAV

Play time—: folder name and : file name

name

Notes

- You can scroll to the left of the title by pressing and holding **DISP**.
- Audio CD that contains certain information such as text and/or number is CD TEXT.
- If specific information is not recorded on a disc, title or name is not displayed.
- Depending on the version of iTunes® used to write MP3 files onto a disc, comment information may not be correctly displayed.
- Depending on the version of Windows Media Player used to encode WMA files, album names and other text information may not be correctly displayed.
- When playing back VBR (variable bit rate)-recorded WMA files, the average bit rate value is displayed.
- When playing back VBR (variable bit rate)-recorded MP3 files, **VBR** is displayed instead of bit rate value.
- The sampling frequency shown in the display may be abbreviated.
- When Ever Scroll is set to ON at the initial setting, text information scrolls continuously in the display. Refer to *Switching the ever scroll* on page 32.

Selecting tracks from the track title list

Track title list lets you see the list of track titles on a CD TEXT disc and select one of them to play back.

1 Press LIST to switch to the track title list mode.

2 Use MULTI-CONTROL to select the desired track title.

Turn to change the track title. Press to play.

- You can also change the track title by pushing **MULTI-CONTROL** up or down.

- To return to the ordinary display, press **BAND** or **LIST**.

- If you do not operate the list within about 30 seconds, the display automatically returns to the ordinary display.

Operating this unit

Selecting files from the file name list

File name list lets you see the list of file names (or folder names) and select one of them to playback.

1 Press LIST to switch to the file name list mode.

Names of files and folders appear in the display.

2 Use MULTI-CONTROL to select the desired file name (or folder name).

Turn to change the name of file or folder.

- when a file is selected, press to play.
- when a folder is selected, press to see a list of files (or folders) in the selected folder.
- when a folder is selected, press and hold to play a song in the selected folder.

▪ You can also play the file by pushing

MULTI-CONTROL right.

▪ You can also play a song in the selected folder by pushing and holding **MULTI-CONTROL** right.

▪ To return to the previous list (the folder one level higher), push **MULTI-CONTROL** left.

▪ Number of the folders/files in the currently selected folder will be indicated on the right side of the display.

▪ To return to the ordinary display, press **BAND** or **LIST**.

▪ If you do not operate the list within about 30 seconds, the display automatically returns to the ordinary display.

Introduction of advanced operations

1 Press MULTI-CONTROL to display the main menu.

2 Use MULTI-CONTROL to select FUNCTION.

Turn to change the menu option. Press to select.

The function menu is displayed.

3 Turn MULTI-CONTROL to select the function.

Play mode (repeat play)—**Random mode** (random play)—**Scan mode** (scan play)—

Pause (pause)—**Sound Retriever** (sound retriever)—**TitleInput "A"** (disc title input)



Notes

- You can also select the function by pressing **FUNCTION** on the remote control.
- To return to the ordinary display, press **BAND**.
- If you do not operate functions except for **TitleInput "A"** within about 30 seconds, the display automatically returns to the ordinary display.
- When playing a compressed audio disc or CD TEXT disc, you cannot switch to disc title input display.

Selecting a repeat play range

1 Display the function menu.

Refer to *Introduction of advanced operations* on this page.

2 Use MULTI-CONTROL to select Play mode in the function menu.

3 Press MULTI-CONTROL to select the repeat range.

- **Disc repeat** – Repeat all tracks
- **Track repeat** – Repeat the current track
- **Folder repeat** – Repeat the current folder
- If you select another folder during repeat play, the repeat play range changes to disc repeat.
- Performing track search or fast forward/reverse during **Track repeat** (track repeat) changes the repeat play range to disc/folder.
- When **Folder repeat** (folder repeat) is selected, it is not possible to play back a subfolder of that folder.

Playing tracks in random order

Tracks in a selected repeat range are played in random order.

Operating this unit

- **Press RDM to turn random play on.**

Tracks play in a random order.

- To turn random play off, press **RDM** again.



Note

You can also turn this function on or off in the menu that appears by using **MULTI-CONTROL**.

Scanning folders and tracks

Scan play searches the song within the selected repeat range.

- 1 **Display the function menu.**

Refer to *Introduction of advanced operations* on the previous page.

- 2 **Use MULTI-CONTROL to select Scan mode in the function menu.**

- 3 **Press MULTI-CONTROL to turn scan play on.**

The first 10 seconds of each track is played.

- 4 **When you find the desired track press MULTI-CONTROL to turn scan play off.**

- If the display has automatically returned to the playback display, select **Scan mode** again by using **MULTI-CONTROL**.
- After scanning of a disc (folder) is finished, normal playback of the tracks begins.

Pausing playback

- 1 **Display the function menu.**

Refer to *Introduction of advanced operations* on the previous page.

- 2 **Use MULTI-CONTROL to select Pause in the function menu.**

- 3 **Press MULTI-CONTROL to turn pause on.**

Playback of the current track pauses.

- To turn pause off, press **MULTI-CONTROL** again.

Using Sound Retriever

Sound Retriever function automatically enhances compressed audio and restores rich sound.

- **Press S.Rtrv repeatedly to select the desired setting.**

OFF (off)—1—2

- 2 is more effective than 1.



Note

You can also perform this operation in the menu that appears by using **MULTI-CONTROL**.

Using disc title functions

You can input CD titles and display the title. The next time you insert a CD for which you have entered a title, the title of that CD is displayed.

Entering disc titles

Use the disc title input feature to store up to 48 CD titles in the unit. Each title can be up to 10 characters long.

- 1 **Display the function menu.**

Refer to *Introduction of advanced operations* on the previous page.

- 2 **Play the CD that you want to enter a title for.**

- 3 **Use MULTI-CONTROL to select TitleInput "A" in the function menu.**

- 4 **Press DISP to select the desired character type.**

Press **DISP** repeatedly to switch between the following character types:

Alphabet (upper case), numbers and symbols—Alphabet (lower case)—European letters, such as those with accents (e.g. á, à, â, ç)—Numbers and symbols

- 5 **Push MULTI-CONTROL up or down to select a letter of the alphabet.**

Operating this unit

6 Push **MULTI-CONTROL** left or right to move the cursor to the previous or next character position.

7 Move the cursor to the last position by pushing **MULTI-CONTROL** right after entering the title.

When you push **MULTI-CONTROL** right one more time, the entered title is stored in memory.

8 Press **BAND** to return to the playback display.



Notes

- Titles remain in memory, even after the disc is removed from the unit, and are recalled when the disc is reinserted.
- After data for 48 discs are stored in the memory, data for a new disc overwrites the oldest one.
- If you connect a multi-CD player, you can input disc titles for up to 100 discs.
- When a multi-CD player that does not support disc title functions is connected, you cannot enter disc titles in this unit. 

Playing songs on USB portable audio player/USB memory

For details about the supported device, refer to *Portable audio player compatibility* on page 6.

Basic Operations



- ① **WMA/MP3/AAC/WAV** indicator
Shows the type of file currently playing.
- ② Folder number indicator
- ③ Track number indicator
- ④ Play time indicator
- ⑤ Bit rate/sampling frequency indicator
 - When playing back VBR (variable bit rate)-recorded WMA files, the average bit rate value is displayed.
 - When playing back VBR (variable bit rate)-recorded MP3 files, **VBR** is displayed instead of bit rate value.

● Select a folder

Push **MULTI-CONTROL** up or down.

● Fast forward or reverse

Push and hold **MULTI-CONTROL** left or right.

● Select a track

Push **MULTI-CONTROL** left or right.

● Return to root folder

Press and hold **BAND**.



Notes

- Optimum performance of this unit may not be obtained depending on the connected USB portable audio player/USB memory.
- If folder 01 (ROOT) contains no files, playback commences with folder 02.

Operating this unit

- When the USB portable audio player having battery charging function is connected to this unit and the ignition switch is set to ACC or ON, the battery is charged.
- You can disconnect the USB portable audio player/USB memory anytime you want to finish listening to it.
- If USB portable audio player/USB memory is connected to this unit, the source is changed to USB automatically. If you do not use an USB device, disconnect it from this unit. Depending on the connected USB device, turning on the ignition switch while USB device is connected to this unit may change the source automatically.

Selecting an audio file directly in the current folder

The operation is the same as that of the built-in CD player.

Refer to *Selecting a track directly* on page 16.

Displaying text information of an audio file

The operation is the same as that of the built-in CD player.

Refer to *Displaying text information on disc* on page 16.



Notes

- If the characters recorded on the audio file are not compatible with the head unit, those characters are not displayed.
- The text information of some audio files may not be correctly displayed.

Selecting files from the file name list

The operation is the same as that of the built-in CD player.

Refer to *Selecting files from the file name list* on page 17.

Introduction of advanced operations

1 Press MULTI-CONTROL to display the main menu.

2 Use MULTI-CONTROL to select FUNCTION.

Turn to change the menu option. Press to select.

The function menu is displayed.

3 Turn MULTI-CONTROL to select the function.

Play mode (repeat play)—**Random mode** (random play)—**Scan mode** (scan play)—**Pause** (pause)—**Sound Retriever** (sound retriever)

Function and operation

Play mode, **Random mode**, **Scan mode**, **Pause** and **Sound Retriever** operations are basically the same as that of the built-in CD player.

Function name	Operation
Play mode	Refer to <i>Selecting a repeat play range</i> on page 17. However, the repeat play ranges you can select are different from that of the built-in CD player. The repeat play ranges of the USB portable audio player/USB memory are: <ul style="list-style-type: none"> • Track repeat – Repeat just the current file • Folder repeat – Repeat the current folder • All repeat – Repeat all files
Random mode	Refer to <i>Playing tracks in random order</i> on page 17.
Scan mode	Refer to <i>Scanning folders and tracks</i> on page 18.
Pause	Refer to <i>Pausing playback</i> on page 18.
Sound Retriever	Refer to <i>Using Sound Retriever</i> on page 18.

Operating this unit

Notes

- You can also select the function by pressing **FUNCTION** on the remote control.
- To return to the ordinary display, press **BAND**.
- If you select another folder during repeat play, the repeat play range changes to **All repeat**.
- If you perform track search or fast forward/reverse during **Track repeat**, the repeat play range changes to **Folder repeat**.
- When **Folder repeat** is selected, it is not possible to play back a subfolder of that folder.
- After file or folder scanning is finished, normal playback of the files begins again. 

Playing songs on iPod

For details about the supported iPod, refer to iPod® compatibility on page 6.

Basic Operations

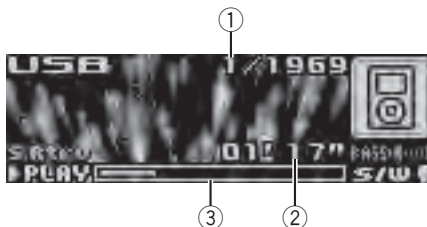

- ① Song number indicator
- ② Play time indicator
- ③ Song time (progress bar)

● Fast forward or reverse

Push and hold **MULTI-CONTROL** left or right.

● Select a track (chapter)

Push **MULTI-CONTROL** left or right.

Notes

- When using an iPod, iPod Dock Connector to USB Cable is required.
- Read the precautions for iPod on page 67.
- While iPod is connected to this unit, **PIONEER** (or ✓ (check mark)) is displayed on the iPod.
- If an error message is displayed, refer to *Error messages* on page 63.
- When the ignition switch is set to ACC or ON, the iPod's battery is charged while the iPod is connected to this unit.
- While the iPod is connected to this unit, the iPod cannot be turned on or off.
- Before connecting the dock connector of this unit to the iPod, disconnect the headphones from the iPod.
- The iPod is turned off about two minutes after the ignition switch is set to OFF.

Browsing for a song

Searching songs by category

Operations to control an iPod with this unit is designed to be as close to the iPod as possible to make operation and song search easy.

- Depending on the number of files in the iPod, there may be delay when displaying a list.
- If the characters recorded on the iPod are not compatible with this unit, those characters are not displayed.

1 Press LIST.

2 Use MULTI-CONTROL to select a category.

Turn to change the category; press to select.

Playlists (playlists)—**Artists** (artists)—**Albums** (albums)—**Songs** (songs)—**Podcasts** (podcasts)—**Genres** (genres)—**Composers** (composers)—**Audiobooks** (audiobooks)
List for the selected category is displayed.

- You can start playback throughout the selected category by pressing and holding **MULTI-CONTROL**. You can also perform this operation by pushing and holding **MULTI-CONTROL** right.
 - You can also change the category by pushing **MULTI-CONTROL** up or down.
 - You can also select the category by pushing **MULTI-CONTROL** right.
 - To return to the previous category, push **MULTI-CONTROL** left.
 - To return to the top tier of categories, push and hold **MULTI-CONTROL** left.
 - To return to the ordinary display, press **BAND**.
 - If you do not operate the list within about 30 seconds, the display automatically returns to the ordinary display.

3 Repeat step 2 to find a song you want to listen to.

Searching songs by alphabet

1 Press LIST.

2 Use MULTI-CONTROL to select a category.

Turn to change the category. Press to select.

3 Press LIST to switch to alphabet search mode.

4 Turn MULTI-CONTROL to select a desired alphabet.

5 Press MULTI-CONTROL to display the alphabetical list.

- If alphabet search is aborted, **Not Found** is displayed.

Displaying text information on iPod

● Press DISP to select the desired text information.

Play time— : artist name and : song title
— : artist name and : album name— : album name and : song title— : song title and play time— : song title, : artist name and : album name

- If the characters recorded on the iPod are not compatible with this unit, those characters are not displayed.



Notes

- You can scroll the text information to the left by pressing and holding **DISP**.
- When Ever Scroll is set to ON at the initial setting, text information scrolls continuously in the display. Refer to *Switching the ever scroll* on page 32.

Introduction of advanced operations

1 Press MULTI-CONTROL to display the main menu.

2 Use MULTI-CONTROL to select FUNCTION.

Turn to change the menu option. Press to select.

Operating this unit

The function menu is displayed.

3 Turn MULTI-CONTROL to select the function.

Play mode (repeat play)—**Shuffle mode**

(shuffle)—**Shuffle all** (shuffle all)—

Link search (link search)—**Control mode**

(control mode)—**Pause** (pause)—

Audiobooks (audiobook speed)—

Sound Retriever (sound retriever)

Function and operation

Play mode, **Pause** and **Sound Retriever** operations are basically the same as that of the built-in CD player.

Function name	Operation
Play mode	Refer to <i>Selecting a repeat play range</i> on page 17. However, the repeat play ranges you can select are different from that of the built-in CD player. The repeat play ranges of the iPod are: <ul style="list-style-type: none"> • Repeat One – Repeat the current song • Repeat All – Repeat all songs in the selected list
Pause	Refer to <i>Pausing playback</i> on page 18.
Sound Retriever	Refer to <i>Using Sound Retriever</i> on page 18.

Notes

- You can also select the function by pressing **FUNCTION** on the remote control.
- To return to the ordinary display, press **BAND**.
- If you do not operate functions within about 30 seconds, the display automatically returns to the ordinary display.
- **Control mode** (control mode) function is available only for iPod nano (second generation).
- When **Control mode** is on, only **Control mode** and **Sound Retriever** can be operated.

Playing songs in a random order (shuffle)

1 Display the function menu.

Refer to *Introduction of advanced operations* on the previous page.

2 Use MULTI-CONTROL to select Shuffle mode in the function menu.

3 Press MULTI-CONTROL to select your favorite setting.

- **Shuffle Songs** – Play back songs in the selected list in random order.
- **Shuffle Albums** – Play back songs from a randomly selected album in order.
- **Shuffle OFF** – Cancel random play.

Playing all songs in a random order (shuffle all)

● Press to turn shuffle all on.

All songs on the iPod play randomly.

- To turn shuffle all off, set **Shuffle mode** in the **FUNCTION** menu to off.

Note

You can also turn this function on in the menu that appears by using **MULTI-CONTROL**.

Selecting songs from album list of currently playing artist

Album list of the currently selected artist is displayed. You can select an album or song from the artist name.

- Depending on the number of files in the iPod, there may be delay when displaying a list.

1 Press and hold LIST to turn link search on.

Searches albums of the artist and displays the list.

Operating this unit

2 Use MULTI-CONTROL to select an album or song from the list.

For more details about the selecting operation, refer to step 2 of *Browsing for a song* on page 22.



Notes

- If link search is aborted, **Not Found** is displayed.
- You can also turn this function on in the menu that appears by using **MULTI-CONTROL**.

Operating this unit's iPod function from your iPod

This function is available only for iPod nano (second generation).

This unit's iPod function can be operated from your iPod. Sound can be heard from car's speaker, and operation can be conducted from your iPod.

- While this function is in use, even if the ignition key is turned off, iPod is not turned off. To turn off power, operate the iPod.

1 Press iPod and hold to switch the control mode.

- Each pressing and holding **iPod** switches the control mode.
- While using this function, play time and titles are not displayed on this unit.
- Even if this function is performed, track up/down can be operated from this unit.
- While using this function, browse function cannot be operated from this unit.

2 Operate the connected iPod to select a song and play.



Note

You can also turn this function on or off in the menu that appears by using **MULTI-CONTROL**.

Changing audiobook speed

While listening to an audiobook on iPod, playback speed can be changed.

1 Display the function menu.

Refer to *Introduction of advanced operations* on page 22.

2 Use MULTI-CONTROL to select Audiobooks in the function menu.

3 Press MULTI-CONTROL to select your favorite setting.

Press **MULTI-CONTROL** repeatedly until the desired setting appears in the display.

- **Faster** – Playback faster than normal speed
- **Normal** – Playback in normal speed
- **Slower** – Playback slower than normal speed

Audio Adjustments

Introduction of audio adjustments

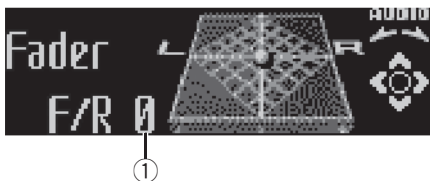

- ① Audio display
Shows the audio adjustment status.

1 Press MULTI-CONTROL to display the main menu.

2 Use MULTI-CONTROL to select AUDIO.

Turn to change the menu option. Press to select.

The audio menu is displayed.

3 Turn MULTI-CONTROL to select the audio function.

Turn **MULTI-CONTROL** to switch between the audio functions in the following order.

Fader (balance adjustment)—**Powerful** (graphic equalizer adjustment)—**50Hz** (7-band graphic equalizer adjustment)—**LOUD** (loudness)—**Sub W.1** (subwoofer on/off setting)—**Sub W.2** (subwoofer setting)—**Bass** (bass boost)—**HPF** (high pass filter)—**SLA** (source level adjustment)

- You can also select the audio function by pressing **AUDIO** on the remote control.
- You can select the **Sub W.2** only when subwoofer output is turned on in **Sub W.1**.
- When selecting FM as the source, you cannot switch to **SLA**.
- To return to the display of each source, press **BAND**.
- If you do not operate functions except for **50Hz** within about 30 seconds, the display is automatically returned to the ordinary display.

Using balance adjustment

You can change the fader/balance setting so that it can provide the ideal listening environment in all occupied seats.

1 Display the audio menu.

Refer to *Introduction of audio adjustments* on this page.

2 Use MULTI-CONTROL to select Fader.

▪ If the balance setting has been previously adjusted, **Balance** will be displayed.

3 Push MULTI-CONTROL up or down to adjust front/rear speaker balance.

Each time **MULTI-CONTROL** is pushed up or down, the front/rear speaker balance moves towards the front or rear.

F 15 to **R 15** is displayed as the front/rear speaker balance moves from front to rear.

- **F/R 0** is the proper setting when only two speakers are used.
- When the rear output setting is **Rear SP:S/W**, you cannot adjust front/rear speaker balance. Refer to *Setting the rear output and subwoofer controller* on page 31.

4 Push MULTI-CONTROL left or right to adjust left/right speaker balance.

Each time **MULTI-CONTROL** is pushed left or right, the left/right speaker balance moves towards the left or right.

L 15 to **R 15** is displayed as the left/right speaker balance moves from left to right.

Using the equalizer

The equalizer lets you adjust the equalization to match the car's interior acoustic characteristics as desired.

Recalling equalizer curves

There are seven stored equalizer curves which you can easily recall at any time. Here is a list of the equalizer curves.

Display	Equalizer curve
Powerful	Powerful
Natural	Natural
Vocal	Vocal
Custom1	Custom 1
Custom2	Custom 2
Flat	Flat
S.Bass	Super bass

- **Custom1** and **Custom2** are adjusted equalizer curves that you create. Adjustments can be made with a 7-band graphic equalizer.
- When **Flat** is selected, no supplement or correction is made to the sound. This is useful to check the effect of the equalizer curves by switching alternatively between **Flat** and a set equalizer curve.

1 Display the audio menu.

Refer to *Introduction of audio adjustments* on the previous page.

2 Use MULTI-CONTROL to select the graphic equalizer adjustment.

Powerful appears in the display.

If the equalizer curve has been previously selected, the curve of that previously selected will be displayed instead of **Powerful**.

3 Push MULTI-CONTROL left or right to select an equalizer curve.

Each time **MULTI-CONTROL** is pushed left or right, equalizer curves are selected in the following order:

Powerful—Natural—Vocal—Custom1—Custom2—Flat—S.Bass

Adjusting equalizer curves

The factory supplied equalizer curves, with the exception of **Flat**, can be adjusted to a fine degree (nuance control).

1 Recall the equalizer curve you want to adjust.

See *Recalling equalizer curves* on the previous page.

2 Push MULTI-CONTROL up or down to adjust the equalizer curve.

Each time **MULTI-CONTROL** is pushed up or down, the equalizer curve increases or decreases respectively.

+6 to **-4** (or **-6**) is displayed as the equalizer curve is increased or decreased.

- The actual range of the adjustments are different depending on which equalizer curve is selected.
- The equalizer curve with all frequencies set to **0** cannot be adjusted.

Adjusting 7-band graphic equalizer

For **Custom1** and **Custom2** equalizer curves, you can adjust the level of each band.

- A separate **Custom1** curve can be created for each source. (The built-in CD player and the multi-CD player are set to the same equalizer adjustment setting automatically.) If you make adjustments when a curve other than **Custom2** is selected, the equalizer curve settings will be memorized in **Custom1**.
- A **Custom2** curve can be created common to all sources. If you make adjustments when the **Custom2** curve is selected, the **Custom2** curve will be updated.

1 Recall the equalizer curve you want to adjust.

See *Recalling equalizer curves* on the previous page.

2 Use MULTI-CONTROL to select 7-band graphic equalizer adjustment.

Frequency and the level (e.g., **50Hz +4**) appears in the display.

Audio Adjustments

3 Push MULTI-CONTROL left or right to select the equalizer band to adjust.

Each time **MULTI-CONTROL** is pushed left or right, equalizer bands are selected in the following order:

50Hz—125Hz—315Hz—800Hz—2kHz—5kHz—12.5kHz

4 Push MULTI-CONTROL up or down to adjust the level of the equalizer band.

Each time **MULTI-CONTROL** is pushed up or down, the level of the equalization band increases or decreases.

+6 to **-6** is displayed as the level is increased or decreased.

- You can then select another band and adjust the level.

5 Press BAND to cancel the 7-band graphic equalizer adjustment.

Adjusting loudness

Loudness compensates for deficiencies in the low- and high-sound ranges at low volume.

1 Display the audio menu.

Refer to *Introduction of audio adjustments* on page 25.

2 Use MULTI-CONTROL to select LOUD.

3 Press MULTI-CONTROL to turn loudness on.

Loudness level (e.g., **Mid**) appears in the display.

- To turn loudness off, press **MULTI-CONTROL** again.

4 Push MULTI-CONTROL left or right to select a desired level.

Each time **MULTI-CONTROL** is pushed left or right, level is selected in the following order:

Low (low)—**Mid** (mid)—**High** (high)

Using subwoofer output

This unit is equipped with a subwoofer output which can be turned on or off.

1 Display the audio menu.

Refer to *Introduction of audio adjustments* on page 25.

- You can also select the subwoofer setting menu by pressing **SW** on the unit.

2 Use MULTI-CONTROL to select Sub W.1.

3 Press MULTI-CONTROL to turn subwoofer output on.

Normal appears in the display. Subwoofer output is now on.

- To turn subwoofer output off, press **MULTI-CONTROL** again.

4 Push MULTI-CONTROL left or right to select the phase of subwoofer output.

Push **MULTI-CONTROL** left to select reverse phase and **Reverse** appears in the display.

Push **MULTI-CONTROL** right to select normal phase and **Normal** appears in the display.

Adjusting subwoofer settings

When the subwoofer output is on, you can adjust the cut-off frequency and the output level of the subwoofer.

Only frequencies lower than those in the selected range are outputted from the subwoofer.

- When the subwoofer output is on, you can select **Sub W.2**.

1 Display the audio menu.

Refer to *Introduction of audio adjustments* on page 25.

- You can also select the subwoofer setting menu by pressing **SW** on the unit.

2 Use MULTI-CONTROL to select Sub W.2.

3 Push MULTI-CONTROL left or right to select cut-off frequency.

Each time **MULTI-CONTROL** is pushed left or right, cut-off frequencies are selected in the following order:

50Hz—63Hz—80Hz—100Hz—125Hz

Audio Adjustments

4 Push MULTI-CONTROL up or down to adjust the output level of the subwoofer.

Each time **MULTI-CONTROL** is pushed up or down, subwoofer level increases or decreases. **+6** to **-24** is displayed as the level is increased or decreased. 

Boosting the bass

Bass boost function boosts the bass level of sound.

1 Display the audio menu.

Refer to *Introduction of audio adjustments* on page 25.

- You can also select the bass boost setting by pressing and holding **SW**.

2 Use MULTI-CONTROL to select Bass.

3 Push MULTI-CONTROL up or down to select a desired level.

0 to **+6** is displayed as the level is increased or decreased. 

Using the high pass filter

When you do not want low sounds from the subwoofer output frequency range to play from the front or rear speakers, turn on the HPF (high pass filter). Only frequencies higher than those in the selected range are output from the front or rear speakers.

1 Display the audio menu.

Refer to *Introduction of audio adjustments* on page 25.

2 Use MULTI-CONTROL to select HPF.

3 Press MULTI-CONTROL to turn high pass filter on.

80Hz appears in the display. High pass filter is now on.

- If the high pass filter has been previously adjusted, the frequency of that previously selected will be displayed instead of **80Hz**.

- To turn high pass filter off, press

MULTI-CONTROL again.

4 Push MULTI-CONTROL left or right to select cut-off frequency.

Each time **MULTI-CONTROL** is pushed left or right, cut-off frequencies are selected in the following order:

50Hz—63Hz—80Hz—100Hz—125Hz 

Adjusting source levels

Source level adjustment (**SLA**) lets you adjust the volume level of each source to prevent radical changes in volume when switching between sources.

- Settings are based on the FM volume level, which remains unchanged.

1 Compare the FM volume level with the level of the source you wish to adjust.

2 Display the audio menu.

Refer to *Introduction of audio adjustments* on page 25.

3 Use MULTI-CONTROL to select SLA.

4 Push MULTI-CONTROL up or down to adjust the source volume.

Each time **MULTI-CONTROL** is pushed up or down, source volume increases or decreases. **SLA +4** to **SLA -4** is displayed as the source volume is increased or decreased.



Notes

- The AM volume level can also be adjusted with source level adjustments.
- The built-in CD player and the multi-CD player are set to the same source level adjustment volume automatically.
- External unit 1 and external unit 2 are set to the same source level adjustment volume automatically.
- XM tuner and SIRIUS tuner are set to the same source level adjustment volume automatically. 

Initial Settings

Adjusting initial settings



①

Using the initial settings, you can customize various system settings to achieve optimal performance from this unit.

- ① Function display
- Shows the function status.

1 Press SRC and hold until the unit turns off.

2 Press MULTI-CONTROL and hold until the initial setting menu appears in the display.

3 Turn MULTI-CONTROL to select one of the initial settings.

Turn **MULTI-CONTROL** to switch between the functions in the following order.

Language select (language selection)—

Calendar (calendar)—**Clock** (clock)—

Warning tone (warning tone)—

Face auto open (face auto open)—**AUX1** (auxiliary input 1)—**AUX2** (auxiliary input 2)—

Dimmer (dimmer)—**Brightness** (brightness)

—**S/W control** (rear output and subwoofer controller)—

Mute (sound muting/attenuation)—

Demonstration (feature demo)—

Reverse mode (reverse mode)—**Ever-scroll**

(ever scroll)—**BT AUDIO** (Bluetooth audio)—

Pin code input (pin code input)—

BT Version info. (Bluetooth version information)

Use the following instructions to operate each particular setting.

- You can also select the function by pressing **FUNCTION** on the remote control.
- **BT AUDIO** and **Pin code input** can be selected only when Bluetooth adapter (e.g., CD-BTB200) is connected to this unit.
- To cancel initial settings, press **BAND**.

Selecting the display language

For your convenience, this unit equips multiple language display. You can select the language best suited to your first language.

- For this function, verify the topic *Adjusting initial settings* before initiating the operation.

1 Display the initial setting menu.

2 Use MULTI-CONTROL to select Language select.

3 Press MULTI-CONTROL to select the language.

Each press of **MULTI-CONTROL** selects languages in the following order:

English—Français—Español

Setting the date

The calendar display adjusted in this mode appears when the telephone source is selected or sources and the feature demo are off.

- For this function, verify the topic *Adjusting initial settings* before initiating the operation.

1 Display the initial setting menu.

2 Use MULTI-CONTROL to select Calendar.

Calendar appears in the display.

3 Push MULTI-CONTROL left or right to select the segment of the calendar display you wish to set.

Pushing **MULTI-CONTROL** left or right will select one segment of the calendar display:

Day—Month—Year

As you select segments of the calendar display the segment selected will blink.

4 Push MULTI-CONTROL up or down to set the date.

Pushing **MULTI-CONTROL** up will increase the selected day, month or year. Pushing **MULTI-CONTROL** down will decrease the selected day, month or year.

Setting the clock

Use these instructions to set the clock.

- For this function, verify the topic *Adjusting initial settings* before initiating the operation.

- 1 **Display the initial setting menu.**
- 2 **Use MULTI-CONTROL to select Clock.**
- 3 **Push MULTI-CONTROL left or right to select the segment of the clock display you wish to set.**

Pushing **MULTI-CONTROL** left or right will select one segment of the clock display:

Hour—Minute

As you select segments of the clock display, the selected segment blinks.

- 4 **Push MULTI-CONTROL up or down to put a clock right.**

Note

You can match the clock to a time signal by pressing **MULTI-CONTROL**.

- If **00** to **29**, the minutes are rounded down. (e.g., **10:18** becomes **10:00**.)
- If **30** to **59**, the minutes are rounded up. (e.g., **10:36** becomes **11:00**.) 

Switching the warning tone

If the front panel is not detached from the head unit within four seconds of turning off the ignition, a warning tone sounds. You can turn off the warning tone.

- For this function, verify the topic *Adjusting initial settings* before initiating the operation.

- 1 **Display the initial setting menu.**
- 2 **Use MULTI-CONTROL to select Warning tone.**
- 3 **Press MULTI-CONTROL to turn warning tone on.**
 - To turn warning tone off, press **MULTI-CONTROL** again. 

Switching the face auto open

To protect against theft, this unit features detachable front panel. To detach the front panel easily, the front panel opens automatically. This function is on as a default.

- For this function, verify the topic *Adjusting initial settings* before initiating the operation.

- 1 **Display the initial setting menu.**
- 2 **Use MULTI-CONTROL to select Face auto open.**
- 3 **Press MULTI-CONTROL to turn the face auto open on.**
 - To turn the face auto open off, press **MULTI-CONTROL** again. 

Switching the auxiliary setting

Auxiliary devices connected to this unit can be activated individually. Set each AUX source to ON when using. For more information about connecting or using auxiliary devices, refer to *Using the AUX source* on page 34.

- For this function, verify the topic *Adjusting initial settings* before initiating the operation.

- 1 **Display the initial setting menu.**
- 2 **Use MULTI-CONTROL to select AUX1/AUX2.**
- 3 **Press MULTI-CONTROL to turn AUX1/AUX2 on.**
 - To turn AUX off, press **MULTI-CONTROL** again. 

Switching the dimmer setting

To prevent the display from being too bright at night, the display is automatically dimmed when the car's headlights are turned on. You can turn the dimmer on or off.

Initial Settings

- For this function, verify the topic *Adjusting initial settings* before initiating the operation.

- 1 **Display the initial setting menu.**
- 2 **Use MULTI-CONTROL to select Dimmer.**
- 3 **Press MULTI-CONTROL to turn dimmer on.**
 - To turn dimmer off, press **MULTI-CONTROL** again. 

Adjusting the brightness

You can adjust the display brightness.

- For this function, verify the topic *Adjusting initial settings* before initiating the operation.

- 1 **Display the initial setting menu.**
- 2 **Use MULTI-CONTROL to select Brightness.**
- 3 **Push MULTI-CONTROL left or right to adjust the brightness level.**
0 to 15 is displayed as the level is increased or decreased.
 - When dimmer is functioning, the brightness level can be adjusted **0 to 10**. 

Setting the rear output and subwoofer controller

This unit's rear output (rear speaker leads output and RCA rear output) can be used for full-range speaker (**Rear SP:F.Range**) or subwoofer (**Rear SP:S/W**) connection. If you switch the rear output setting to **Rear SP:S/W**, you can connect a rear speaker lead directly to a subwoofer without using an auxiliary amp. Initially, the unit is set for rear full-range speaker connection (**Rear SP:F.Range**).

- For this function, verify the topic *Adjusting initial settings* before initiating the operation.

- 1 **Display the initial setting menu.**

- 2 **Use MULTI-CONTROL to select S/W control.**

- 3 **Press MULTI-CONTROL to switch the rear output setting.**

Pressing **MULTI-CONTROL** will switch between **Rear SP:F.Range** (full-range speaker) and **Rear SP:S/W** (subwoofer) and that status will be displayed.

- When no subwoofer is connected to the rear output, select **Rear SP:F.Range**.
- When a subwoofer is connected to the rear output, set for subwoofer **Rear SP:S/W**.



Notes

- Even if you change this setting, there is no output unless you turn the subwoofer output on (refer to *Using subwoofer output* on page 27).
- If you change this setting, subwoofer output in the audio menu return to the factory settings.
- Both rear speaker lead outputs and RCA rear output are switched simultaneously in this setting. 

Switching the sound muting/attenuation

Sound from this system is muted or attenuated automatically when the signal from the equipment with mute function is received.

- The sound is muted or attenuated, **MUTE** or **ATT** are displayed and no audio adjustment is possible.
- Sound from this system returns to normal when the muting or attenuation is canceled.
- For this function, verify the topic *Adjusting initial settings* before initiating the operation.

- 1 **Display the initial setting menu.**
- 2 **Use MULTI-CONTROL to select Mute.**

Initial Settings

3 Press MULTI-CONTROL to switch the telephone muting/attenuation.

Pressing **MULTI-CONTROL** will switch between **TEL ATT** (attenuation) and **TEL mute** (muting) and that status will be displayed. 

Switching the feature demo

The feature demo automatically starts when power to this unit is turned off while the ignition switch is set to ACC or ON.

- For this function, verify the topic *Adjusting initial settings* before initiating the operation.

1 Display the initial setting menu.

2 Use MULTI-CONTROL to select Demonstration.

3 Press MULTI-CONTROL to turn the feature demo on.

- To turn the feature demo off, press **MULTI-CONTROL** again.

Notes

- Remember that if the feature demo continues operating when the car engine is turned off, it may drain battery power.
- You can also turn on or off feature demo by pressing **DISP** while this unit is turned off. For more details, see *About the demo mode* on page 8. 

Switching the reverse mode

If you do not perform an operation for about 30 seconds, screen indications start to reverse, and continue reversing every 10 seconds.

- For this function, verify the topic *Adjusting initial settings* before initiating the operation.

1 Display the initial setting menu.

2 Use MULTI-CONTROL to select Reverse mode.

3 Press MULTI-CONTROL to turn the reverse mode on.

- To turn the reverse mode off, press **MULTI-CONTROL** again.

Note

You can also turn on or off reverse mode by pressing **BAND** while this unit is turned off. For more details, see *Reverse mode* on page 8. 

Switching the ever scroll

When ever scroll is set to on, CD text information scrolls continuously in the display. Set to off if you prefer the information to scroll just once.

- For this function, verify the topic *Adjusting initial settings* before initiating the operation.

1 Display the initial setting menu.

2 Use MULTI-CONTROL to select Ever-scroll.

3 Press MULTI-CONTROL to turn the ever scroll on.

- To turn the Ever Scroll off, press **MULTI-CONTROL** again. 

Activating the BT Audio source

You need to activate the **BT Audio** source in order to use a Bluetooth audio player.

- You can only operate this function when Bluetooth adapter (e.g. CD-BTB200) is connected to this unit.
- For this function, verify the topic *Adjusting initial settings* before initiating the operation.

1 Display the initial setting menu.

2 Use MULTI-CONTROL to select BT AUDIO.

Initial Settings

3 Press **MULTI-CONTROL** to turn the **BT Audio** source on.

- To turn the **BT Audio** source off, press **MULTI-CONTROL** again. 

Entering PIN code for Bluetooth wireless connection

To connect your cellular phone to this unit via Bluetooth wireless technology, you need to enter PIN code on your phone to verify the connection. The default code is **0000**, but you can change this in this function.

- With some Bluetooth audio players, you may be required to enter the Bluetooth audio player PIN code in advance to set this unit for a connection.
- You can only operate this function when Bluetooth adapter (e.g. CD-BTB200) is connected to this unit.
- For this function, verify the topic *Adjusting initial settings* before initiating the operation.

1 Display the initial setting menu.

2 Use **MULTI-CONTROL** to select Pin code input.

3 Push **MULTI-CONTROL** up or down to select a number.

4 Push **MULTI-CONTROL** left or right to move the cursor to the previous or next position.

5 After inputting PIN code (up to 16 digits), press **MULTI-CONTROL**.

PIN code can be stored in memory.

When you press **MULTI-CONTROL** again on the same display, the PIN code you entered is stored in this unit.

- Pushing **MULTI-CONTROL** right in the confirmation display returns you to the PIN code input display, and you can change the PIN code. 

Displaying system version for repair

Should this unit fails to operate properly and you consult your dealer for repair, you may be asked to indicate the system versions of this unit and of Bluetooth module. You can display the versions and confirm them.

- For this function, verify the topic *Adjusting initial settings* before initiating the operation.

1 Display the initial setting menu.

2 Use **MULTI-CONTROL** to select BT Version info.

The system (microprocessor) version of this unit is displayed.

3 Push **MULTI-CONTROL** left to switch to the version of the Bluetooth module of this unit.

- Pushing **MULTI-CONTROL** right returns to the system version of this unit. 

Using the AUX source

Up to two auxiliary devices such as VCR or portable devices (sold separately) can be connected to this unit. When connected, auxiliary devices are automatically read as AUX sources and assigned to **AUX1** or **AUX2**. The relationship between **AUX1** and **AUX2** sources is explained below.

About AUX1 and AUX2

There are two methods to connect auxiliary devices to this unit.

AUX1 source:

When connecting auxiliary equipment using a stereo mini plug cable

- **Insert the stereo mini plug into the input jack on this unit.**

For more details, refer to the installation manual.

This auxiliary device is automatically set to **AUX1**.

AUX2 source:

When connecting auxiliary equipment using an IP-BUS-RCA Interconnector (sold separately)

- **Use an IP-BUS-RCA Interconnector such as the CD-RB20/CD-RB10 (sold separately) to connect this unit to auxiliary equipment featuring RCA output.**

For more details, refer to the IP-BUS-RCA Interconnector owner's manual.

This auxiliary device is automatically set to **AUX2**.

- You can only make this type of connection if the auxiliary device has RCA outputs.

Selecting AUX as the source

- **Press SRC to select AUX as the source.**
 - If the auxiliary setting is not turned on, **AUX** cannot be selected. For more details, see *Switching the auxiliary setting* on page 30.

Setting the AUX title

The title displayed for the **AUX1** or **AUX2** source can be changed.

- 1 After you have selected AUX as the source, use MULTI-CONTROL and select FUNCTION to display TitleInput "A".**

- 2 Enter a title in the same way as the built-in CD player.**

For details concerning operation, refer to *Entering disc titles* on page 18.

Using the external unit

External unit refers to a Pioneer product (such as ones available in the future) that, although incompatible as a source, enables control of basic functions with this unit. Two external units can be controlled with this unit. When two external units are connected, the external unit is automatically allocated to external unit 1 or external unit 2 by this unit.

Basic operations of the external unit are explained below. Allocated functions are different depending on the connected external unit. For details concerning functions, refer to external unit's owner's manual.

Selecting the external unit as the source

- **Press SRC to select EXTERNAL as the source.**

Other Functions

Basic operation

Functions allocated to the following operations are different depending on the connected external unit. For details concerning functions, refer to the connected external unit's owner's manual.

- Press **BAND**.
- Press and hold **BAND**.
- Push **MULTI-CONTROL** left or right.
- Push and hold **MULTI-CONTROL** left or right.
- Push **MULTI-CONTROL** up or down.

Using the functions allocated to 1 to 6 keys

- Press any of 1 to 6 on the remote control.

Advanced operations

1 Press **MULTI-CONTROL** to display the main menu.

2 Use **MULTI-CONTROL** to select **FUNCTION**.

Turn to change the menu option. Press to select.

3 Turn **MULTI-CONTROL** to select the function.

Function1 (function 1)—**Function2** (function 2)—**Function3** (function 3)—**Function4** (function 4)—**Auto/Manual** (auto/manual)

- You can also turn **Function1** on or off by pressing **PGM** on the remote control.

Notes

- You can also select the function by pressing **FUNCTION** on the remote control.
- To return to the ordinary display, press **BAND**. 

Turning the clock display on or off

You can turn the clock display on or off.

- Even when the sources and the feature demo are off, the clock display appears on the display.

- Press **CLOCK** to turn the clock display on or off.

Each press of **CLOCK** turns the clock display on or off.

- The clock display disappears temporarily when you perform other operations, but the clock display appears again after 4 seconds.

Note

In the following conditions, the clock display cannot be turned on or off.

- While displaying three line text information
- While displaying **ENT CLOCK** (entertainment clock) (Refer to *Using different entertainment displays* on the next page) 

Switching the display indication and button illumination

Display indication and button illumination can be switched on or off.

- Press and hold **DISP OFF**.

Pressing and holding **DISP OFF** switches the display indication and button illumination on or off.

- While the display indication is turned off, **CLOCK/DISP OFF** button lights up.
- Even if the display indication is turned off, operation can be conducted. If operation is conducted while the display indication is off, display will light up for a few seconds and then turn off again.
- In the following conditions, the clock display cannot be turned on or off.
 - While displaying three line text information

- While displaying **ENT CLOCK** (entertainment clock) (Refer to *Using different entertainment displays* on this page) 

Using different entertainment displays

You can enjoy entertainment displays while listening to each sound source.

1 Press MULTI-CONTROL to display the main menu.

2 Use MULTI-CONTROL to select ENTERTAINMENT.

Turn to change the menu option. Press to select.

3 Use MULTI-CONTROL to change the display.

Turn to change the menu option. Press to select.

BGV-1 (background visual 1)—**BGV-2** (background visual 2)—**BGP-1** (background picture 1)—**BGP-2** (background picture 2)—**BGP-3** (background picture 3)—**BGP-4** (background picture 4)—**SIMPLE-1** (simple display 1)—**SIMPLE-2** (simple display 2)—**LEVEL METER** (level meter)—**VISUALIZER1** (visualizer 1)—**VISUALIZER2** (visualizer 2)—**VISUALIZER3** (visualizer 3)—**SPECTRUM ANALYZER 1** (spectrum analyzer 1)—**SPECTRUM ANALYZER 2** (spectrum analyzer 2)—**MOVIE** (movie)—**ENT CLOCK** (entertainment clock)

- You can also switch between the display by pressing **ENT** on the remote control.
- To return to the playback display, press **BAND**. 

Using the PGM button

You can operate the preprogrammed functions for each source by using **PGM** on the remote control.

● **Press PGM to turn pause on when selecting the following sources:**

- **COMPACT DISC** – Built-in CD player
- **MULTI CD** – Multi-CD player
- **USB** – USB portable audio player/USB memory
- **IPOD** – iPod
- **BT Audio** – Bluetooth audio player
- **DVD** – DVD player/multi-DVD player

▪ To turn pause off, press **PGM** again.

● **Press PGM and hold to turn BSM on when selecting tuner as the source.**

Press **PGM** and hold until the BSM turns on.

- To cancel the storage process, press **PGM** again.

● **Press PGM and hold to turn BSSM on when selecting television as the source.**

Press **PGM** and hold until the BSSM turns on.

- To cancel the storage process, press **PGM** again.

● **Press PGM to select the desired channel select setting when selecting XM or SIRIUS as the source.**

Press **PGM** repeatedly to switch between the following channel select settings:

Channel number (channel number select setting)—**Category** (channel category select setting) 

Available accessories

Playing songs on iPod

Basic operation

You can use this unit to control an interface adapter for iPod, which is sold separately.

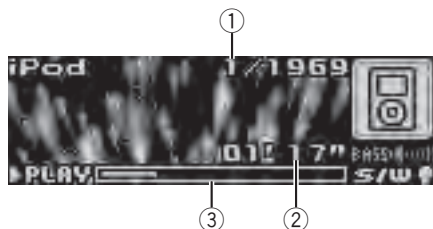

- ① Song number indicator
- ② Play time indicator
- ③ Song time (progress bar)

- **Fast forward or reverse**

Push and hold **MULTI-CONTROL** left or right.

- **Select a track**







Push **MULTI-CONTROL** left or right.

Notes

- Read the precautions for iPod on page 67.
- While iPod is connected to this unit, **PIONEER** (or ✓ (check mark)) is displayed on the iPod.
- If an error message is displayed, refer to *Error messages* on page 63.
- When the ignition switch is set to ACC or ON, the iPod's battery is charged while the iPod is connected to this unit.
- While the iPod is connected to this unit, the iPod cannot be turned on or off.
- Before connecting the dock connector of this unit to the iPod, disconnect the headphones from the iPod.
- The iPod is turned off about two minutes after the ignition switch is set to OFF.

Displaying text information on iPod

- **Press DISP to select the desired text information.**

Play time—: artist name and : song title
: artist name and : album name—: album name and : song title—: song title and play time

- If the characters recorded on the iPod are not compatible with this unit, those characters are not displayed.

Notes

- You can scroll the text information to the left by pressing and holding **DISP**.
- When Ever Scroll is set to ON at the initial setting, text information scrolls continuously in the display. Refer to *Switching the ever scroll* on page 32.

Browsing for a song

The operation is the same as that of the iPod connected to USB interface of this unit. (Refer to *Browsing for a song* on page 22.)

However, the selectable categories are slightly different. Selectable categories are **Playlists** (playlists)—**Artists** (artists)—**Albums** (albums)—**Songs** (songs)—**Genres** (genres)

Introduction of advanced operations

1 Press **MULTI-CONTROL** to display the main menu.

2 Use **MULTI-CONTROL** to select **FUNCTION**.

Turn to change the menu option. Press to select.

The function menu is displayed.

3 Turn MULTI-CONTROL to select the function.

Play mode (repeat play)—**Shuffle mode** (shuffle)—**Pause** (pause)

Function and operation

Play mode and **Pause** operations are basically the same as that of the built-in CD player.

Function name	Operation
Play mode	<p>Refer to <i>Selecting a repeat play range</i> on page 17.</p> <p>However, the repeat play ranges you can select are different from that of the built-in CD player. The repeat play ranges of the iPod are:</p> <ul style="list-style-type: none"> • Repeat One – Repeat the current song • Repeat All – Repeat all songs in the selected list
Pause	<p>Refer to <i>Pausing playback</i> on page 18.</p>



Notes

- You can also select the function by pressing **FUNCTION** on the remote control.
- To return to the ordinary display, press **BAND**.
- If you do not operate functions within about 30 seconds, the display automatically returns to the ordinary display.

Playing songs in a random order (shuffle)

- Press **↺** repeatedly to select the desired setting.
 - **Shuffle Songs** – Play back songs in the selected list in random order.
 - **Shuffle Albums** – Play back songs from a randomly selected album in order.
 - **Shuffle OFF** – Cancel random play.



Note

You can also turn this function on in the menu that appears by using **MULTI-CONTROL**.

Bluetooth Audio

Basic Operations

If you connect a Bluetooth adapter (e.g. CD-BTB200) to this unit, you can control Bluetooth audio players via Bluetooth wireless technology.



- ① Device name
- Shows the device name of the connected Bluetooth audio player (or Bluetooth adapter).



Important

- Depending on the Bluetooth audio player connected to this unit, the operations available with this unit are limited to the following two levels:
 - Lower level: Only playing back songs on your audio player is possible.
 - Higher level: Playing back, pausing, selecting songs, etc., are possible (all the operations illustrated in this manual).
- Since there are a number of Bluetooth audio players available on the market, operations with your Bluetooth audio player using this unit vary in great range. Refer to the instruction manual that came with your Bluetooth audio player as well as this manual while operating your player on this unit.
- Information about songs (e.g. the elapsed playing time, song title, song index, etc.) cannot be displayed on this unit.
- While you are listening to songs on your Bluetooth audio player, refrain from operating on your cellular phone as much as possible. If you try operating your cellular phone, the signal from your cellular phone may cause noise on the song playback.

Available accessories

- When you are talking on a cellular phone connected to this unit via Bluetooth wireless technology, song playback from your Bluetooth audio player connected to this unit is muted.
- Even if while you are listening to a song on your Bluetooth audio player and you switch to another source, playback of song continues.

● **Fast forward or reverse**

Push and hold **MULTI-CONTROL** left or right.

● **Select a track**

Push **MULTI-CONTROL** left or right.

Notes

- For details concerning operation, refer to the Bluetooth adapter's operation manual. This section provides brief information on Bluetooth audio player operations with this unit, which slightly differs or is abbreviated from that described in the Bluetooth adapter's operation manual.
- Even though your audio player does not contain a Bluetooth module, you can still control it from this unit via Bluetooth wireless technology. To control your audio player using this unit, connect a product featuring Bluetooth wireless technology (available on the market) to your audio player and connect the Bluetooth adapter (e.g. CD-BTB200) to this unit.

Function and operation

1 Press MULTI-CONTROL to display the main menu.

2 Use MULTI-CONTROL to select FUNCTION.

Turn to change the menu option. Press to select.

The function menu is displayed.

3 Turn MULTI-CONTROL to select the function.

Connection open (connection open)—

Disconnect audio (disconnect audio)—**Play**

(Play)—**Stop** (Stop)—**Pause** (pause)—

Device info (device information)

- **Pause** is the same as that of the built-in CD player. (Refer to *Pausing playback* on page 18.)

Notes

- You can also select the function by pressing **FUNCTION** on the remote control.
- To return to the ordinary display, press **BAND**.
- If a Bluetooth audio player is not connected to this unit yet, **Connection open** and **Device info** appear in the function menu and other functions are not available.
- If a Bluetooth audio player is connected via higher level, **Connection open** does not appear in the function menu and the other functions are available.
- If a Bluetooth audio player is connected via lower level, only **Disconnect audio** and **Device info** appear in the function menu.
- If you do not operate functions other than **Connection open** and **Disconnect audio** within about 30 seconds, the display is automatically returned to the ordinary display.

Connecting a Bluetooth audio player

1 Display the function menu.

Refer to *Function and operation* on this page.

2 Use MULTI-CONTROL to select Connection open in the function menu.

3 Press MULTI-CONTROL to open the connection.

Always waiting is displayed. This unit is now on standby for connection from Bluetooth audio player.

If your Bluetooth audio player is set ready for Bluetooth wireless connection, connection to this unit is automatically established.

**Note**

Before you can use audio players you may need to enter the PIN code into this unit. If your player requires a PIN code to establish a connection, look for the code on the player or in its accompanying documentation. Refer to *Entering PIN code for Bluetooth wireless connection* on page 33.

Playing songs on Bluetooth audio player

1 Display the function menu.

Refer to *Function and operation* on the previous page.

2 Use MULTI-CONTROL to select Play in the function menu.

3 Press MULTI-CONTROL to start playback.

Stopping playback

1 Display the function menu.

Refer to *Function and operation* on the previous page.

2 Use MULTI-CONTROL to select Stop in the function menu.

3 Press MULTI-CONTROL to stop the playback.

Disconnecting a Bluetooth audio player

1 Display the function menu.

Refer to *Function and operation* on the previous page.

2 Use MULTI-CONTROL to select Disconnect audio in the function menu.

3 Press MULTI-CONTROL to disconnect the Bluetooth audio player.

Disconnected is displayed. The Bluetooth audio player is now disconnected from this unit.

Displaying BD (Bluetooth Device) address

1 Display the function menu.

Refer to *Function and operation* on the previous page.

2 Use MULTI-CONTROL to select Device info in the function menu.

3 Push MULTI-CONTROL left to switch to the BD address.

12-digit hexadecimal string is displayed.

- Pushing **MULTI-CONTROL** right returns to the device name. 

Bluetooth Telephone

Basic Operations

If you use a Bluetooth adapter (e.g. CD-BTB200), you can connect a cellular phone featuring Bluetooth wireless technology to this unit for hands-free, wireless calls, even while driving.

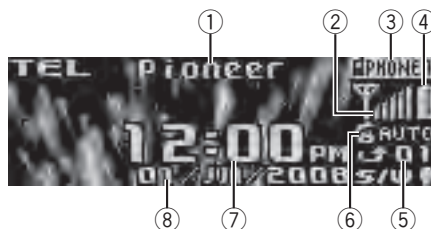

- ① Device name
Shows the device name of the cellular phone.
- ② Signal level indicator
Shows the signal strength of cellular phone.
 - Signal level indicator may differ from the actual signal level.

Available accessories

- ③ User number indicator
Shows the registration number of the cellular phone.
- ④ Battery strength indicator
Shows the battery strength of cellular phone.
 - Battery strength indicator may differ from the actual battery strength.
 - If the battery strength is not available, nothing is displayed in the battery strength indicator area.
- ⑤ Incoming call notice indication
Shows when an incoming call has been received and not checked yet.
 - Incoming call notice is not displayed for calls made when your cellular phone is disconnected from this unit.
- ⑥ Automatic answering/Automatic rejecting indicator
Shows **AUTO** when the automatic answering function is on (for more details, refer to *Setting automatic answering* on page 49).
Shows **REJECT** when the automatic rejecting function is on (for more details, refer to *Setting automatic rejecting* on page 49).
- ⑦ Clock display
Shows the time (if connected with a phone).
- ⑧ Calendar display
Shows the day, month and year (if connected with a phone).



Important

- Since this unit is on standby to connect with your cellular phone via Bluetooth wireless technology, using this unit without running the engine can result in battery drainage.
- Advanced operations that require your attention such as dialing numbers on the monitor, using phone book, etc., are prohibited while you are driving. When you need to use these advanced operations, stop your vehicle in a safe place.



Notes

- Equalizer curve for the phone source is fixed.

- When selecting the phone source, you can only operate **Fader** (balance adjustment) in the audio menu.

Setting up for hands-free phoning

Before you can use the hands-free phoning function you must set up the unit for use with your cellular phone. This entails establishing a Bluetooth wireless connection between this unit and your phone, registering your phone with this unit, and adjusting the volume level.

1 Connection

For detailed instructions on connecting your phone to this unit via Bluetooth wireless technology, refer to *Connecting a cellular phone* on page 43.

- Your phone should now be temporarily connected. However, to make best use of the technology, we recommend you register the phone to this unit.

2 Registration

To register your temporarily connected phone, refer to *Registering a connected cellular phone* on page 44.

3 Volume adjustment

Adjust the earpiece volume on your cellular phone for comfort. When adjusted, the volume level is memorized in this unit as the default setting.

- Caller's voice volume and ring volume may vary depending on the type of cellular phone.
- If the difference between the ring volume and caller's voice volume is big, overall volume level may become unstable.
- Before disconnecting the cellular phone from this unit, make sure to adjust the volume to a proper level. If the volume is muted (zero level) on your cellular phone, the volume level of your cellular phone remains muted even after the cellular phone is disconnected.

Making a phone call

Voice recognition

1 Press **BAND** and hold until **Voice dial** appears in the display.

Voice dial appears in the display. When **Voice dial ON** is displayed, voice recognition function is now ready.

- If your cellular phone does not feature voice recognition function, **No voice dial** appears in the display and operation is not available.

2 Pronounce the name of your contact.

Taking a phone call

Answering or rejecting an incoming call

● Answering an incoming call

When a call comes in, press

MULTI-CONTROL.

- You can also perform this operation by pushing **MULTI-CONTROL** up.

● End a call

Push **MULTI-CONTROL** down.

● Rejecting an incoming call

When a call comes in, push **MULTI-CONTROL** down.



Notes

- If private mode is selected on the cellular phone, hands-free phoning may not be performed.
- The estimated call time appears in the display (this may differ slightly from the actual call time).

Operating a call waiting

● Answering a call waiting

When a call comes in, press

MULTI-CONTROL.

- You can also perform this operation by pushing **MULTI-CONTROL** up.

● End all calls

Push **MULTI-CONTROL** down.

● Switch between callers on hold

Press **MULTI-CONTROL**.

- You can also perform this operation by pushing **MULTI-CONTROL** up.

● Rejecting a call waiting

Push **MULTI-CONTROL** down.



Notes

- Pushing **MULTI-CONTROL** down ends all calls including calls waiting on line.
- To end the call, both you and your caller need to hang up the phone.

Function and operation

1 Press **MULTI-CONTROL** to display the main menu.

2 Use **MULTI-CONTROL** to select **FUNCTION**.

Turn to change the menu option. Press to select.

The function menu is displayed.

3 Turn **MULTI-CONTROL** to select the function.

Search & Connect (search and connect)—

Connection open (connection open)—

Disconnect phone (disconnect phone)—

Connect phone (connect phone)—**Set phone**

(registering phone)—**Delete phone** (delete

phone)—**PH.B.Transfer** (phone book transfer)

—**PH.B.Name view** (phone book name view)

—**Clear memory** (clear memory)—

Number dial (call by entering number)—

Refuse calls (automatic reject setting)—

Auto answer (automatic answer setting)—

Ring tone (ring tone select)—**Auto connect**

(automatic connection setting)—**Echo cancel**

(echo cancel)—**Device info** (device information)

If not connected yet

The following functions cannot be operated.

Available accessories

- **Disconnect phone** (disconnect phone)
- **Set phone** (registering phone)
- **Clear memory** (clear memory)
- **PH.B.Name view** (phone book name view)
- **Number dial** (call by entering number)

If connected but not registered yet

The following functions cannot be operated.

- **Search & Connect** (search and connect)
- **Connection open** (connection open)
- **Connect phone** (connect phone)
- **PH.B.Name view** (phone book name view)
- **Clear memory** (clear memory)

If already connected and registered

The following functions cannot be operated.

- **Search & Connect** (search and connect)
- **Connection open** (connection open)
- **Connect phone** (connect phone)
- **Set phone** (registering phone)



Notes

- You can also select the function by pressing **FUNCTION** on the remote control.
- To return to the playback display, press **BAND**.
- **Device info** is the same as that of the Bluetooth audio. (Refer to *Displaying BD (Bluetooth Device) address* on page 40.)
- **PH.B.Name view** (phone book name view) cannot be selected for cellular phone registered guest phone.
- If cellular phone is connected to this unit via Bluetooth wireless technology with HSP (Head Set Profile), **PH.B.Name view**, **Clear memory**, **Number dial** and **Refuse calls** cannot be selected.
- If you do not operate functions other than **Search & Connect**, **Connection open**, **Connect phone**, **PH.B.Transfer**, **Disconnect phone**, **Number dial**, **Clear memory** and **PH.B.Name view** within about 30 seconds, the display automatically returns to the ordinary display.

Connecting a cellular phone

Searching for available cellular phones

1 Display the function menu.

Refer to *Function and operation* on the previous page.

2 Use MULTI-CONTROL to select Search & Connect in the function menu.

3 Press MULTI-CONTROL to search for available cellular phones.

While searching, **SEARCHING** flashes. When available cellular phones featuring Bluetooth wireless technology are found, device name or **Name not found** (if names cannot be obtained) is displayed.

- If this unit fails to find any available cellular phones, **Not found** is displayed.

4 Push MULTI-CONTROL up or down to select a device name you want to connect.

5 Press MULTI-CONTROL to connect the selected cellular phone.

While connecting, **Connecting** flashes. To complete the connection, check the device name (**Pioneer BT Unit**) and enter the link code on your cellular phone. If the connection is established, **Connected** is displayed.

- The link code is set to **0000** as default. You can change this code in the initial setting. Refer to *Entering PIN code for Bluetooth wireless connection* on page 33.

Using a cellular phone to initiate a connection

1 Display the function menu.

Refer to *Function and operation* on the previous page.

2 Use MULTI-CONTROL to select Connection open in the function menu.

Available accessories

3 Press MULTI-CONTROL to open the connection.

Always waiting flashes and the unit is now on standby for connection from a cellular phone.

4 Use cellular phone to connect to this unit.

- The link code is set to **0000** as default. You can change this code in the initial setting. Refer to *Entering PIN code for Bluetooth wireless connection* on page 33.

Disconnecting a cellular phone

1 Display the function menu.

Refer to *Function and operation* on page 42.

2 Use MULTI-CONTROL to select Disconnect phone in the function menu.

Device name of the connected phone appears in the display.

3 Press MULTI-CONTROL to disconnect a cellular phone from this unit.

After disconnection is completed, **Disconnected** is displayed.

Registering a connected cellular phone

1 Display the function menu.

Refer to *Function and operation* on page 42.

2 Use MULTI-CONTROL to select Set phone in the function menu.

3 Push MULTI-CONTROL up or down to select a registration assignment.

P1 (user phone 1)—**P2** (user phone 2)—**P3** (user phone 3)—**G1** (guest phone 1)—**G2** (guest phone 2)

- As you select each assignment, you can see whether or not a phone is already registered. If the assignment is empty, **No data** is displayed. If the assignment is already taken, the device name appears. To replace an assignment with a new phone, first delete the current assignment. For

more detailed instructions, see *Deleting a registered phone* on this page.

4 Press MULTI-CONTROL to register the currently connected phone.

When registration is completed, **Reg.Completed** is displayed.

- If the registration fails, **Reg.ERROR** is displayed. In this case, return to step 1 and try again.

Deleting a registered phone

1 Display the function menu.

Refer to *Function and operation* on page 42.

2 Use MULTI-CONTROL to select Delete phone in the function menu.

3 Push MULTI-CONTROL up or down to select a registration assignment.

P1 (user phone 1)—**P2** (user phone 2)—**P3** (user phone 3)—**G1** (guest phone 1)—**G2** (guest phone 2)

- If the assignment is empty, **No data** is displayed and operation is not possible.

4 Push MULTI-CONTROL right to select Delete YES.

Delete YES is displayed. Deleting phone is now on standby.

5 Press MULTI-CONTROL to delete the phone.

After the phone is deleted, **Deleted** is displayed.

Available accessories

Connecting to a registered cellular phone

Connecting to a registered phone manually

1 Display the function menu.

Refer to *Function and operation* on page 42.

2 Use MULTI-CONTROL to select Connect phone in the function menu.

3 Push MULTI-CONTROL up or down to select a registration assignment.

P1 (user phone 1)—**P2** (user phone 2)—**P3** (user phone 3)—**G1** (guest phone 1)—**G2** (guest phone 2)

- If the assignment is empty, **No data** is displayed and operation is not possible.

4 Press MULTI-CONTROL to connect the selected cellular phone.

While connecting, **Connecting** is displayed. After the connection is completed, **Connected** is displayed.

Connecting to a registered phone automatically

1 Display the function menu.

Refer to *Function and operation* on page 42.

2 Use MULTI-CONTROL to select Auto connect in the function menu.

3 Press MULTI-CONTROL to turn automatic connection on.

If your cellular phone is ready for Bluetooth wireless connection, connection to this unit is automatically established.

- To turn automatic connection off, press **MULTI-CONTROL** again.

Using the phone book

Transferring entries to the phone book

The Phone Book can hold a total of 500 entries. 300 from User 1, 150 from User 2, and 50 from User 3.

1 Display the function menu.

Refer to *Function and operation* on page 42.

2 Use MULTI-CONTROL to select PH.B.Transfer in the function menu.

3 Press MULTI-CONTROL to enter in the phone book transfer standby mode.

Transfer YES appears in the display.

4 Press MULTI-CONTROL to show the confirmation display.

Transfer YES appears in the display.

5 Use cellular phone to perform phone book transfer.

Perform phone book transfer using the cellular phone. For detailed instructions, refer to the instruction manual that came with your cellular phone.

- The display indicates how many entries have been transferred and the total number to be transferred.

6 Data transferred is displayed and phone book transfer is completed.

Changing the phone book display order

1 Display the function menu.

Refer to *Function and operation* on page 42.

2 Use MULTI-CONTROL to select PH.B.Name view in the function menu.

Invert names YES appears in the display.

3 Press MULTI-CONTROL to change the name view order.

Inverted is displayed and the name view order is changed.

Pressing **MULTI-CONTROL** repeatedly changes the name view order between first name and last name.

Calling a number in the phone book

Important

Be sure to park your vehicle and apply the parking brake when performing this operation.

Available accessories

After finding the number you want to call in the phone book, you can select the entry and make the call.

1 Press LIST to display the phone book.

2 Push MULTI-CONTROL left or right to select the first letter of the name you are looking for.

3 Press MULTI-CONTROL to display entries.

The display shows the first three Phone Book entries starting with that letter (e.g. "Ben", "Brian" and "Burt" when "B" is selected).

4 Push MULTI-CONTROL up or down to select a Phone Book entry you want to call.

5 Push MULTI-CONTROL right to display the detailed list of the selected entry.

The phone number, name and genre (if assigned) of entries are displayed in the detailed list.

- You can scroll the name and phone number by pressing and holding **DISP**.
- If several phone numbers are entered to an entry, select one by turning **MULTI-CONTROL**.
- If you want to go back and select another entry, push **MULTI-CONTROL** left.

6 Press MULTI-CONTROL to make a call.

7 To end the call, push MULTI-CONTROL down.

Editing the name of a Phone Book entry



Important

Be sure to park your vehicle and apply the parking brake when performing this operation.

You can edit the names of Phone Book entries. Each name can be up to 16 characters long.

1 Display the detailed list of your desired Phone Book entry.

See step 1 to 5 on *Calling a number in the phone book* on the previous page for how to do this.

2 Press and hold MULTI-CONTROL to display the name input screen.
Edit name is displayed.

3 Press DISP to select the desired character type.

Each press of **DISP** switches the character types in the following order: Alphabet (upper case), numbers and symbols—alphabet (lower case)—numbers and symbols—European characters, such as those with accents (e.g., **á, à, ä, ç**) or Russian characters

- Pressing and holding **DISP** enables you to switch character set between ISO8859-1 (European characters) and ISO8859-5 (Russian characters) alternately.
- European characters and Russian characters can't be mixed.

4 Push MULTI-CONTROL up or down to select a letter.

- To delete a character and leave a space, select "**_**" (underbar).

5 Push MULTI-CONTROL left or right to move the cursor to the previous or next character position.

6 Press MULTI-CONTROL to store the new name.

Editing phone numbers



Important

Be sure to park your vehicle and apply the parking brake when performing this operation.

You can edit the numbers of Phone Book entries. Each phone number can be up to 24 digits long.

Available accessories

1 Display the detailed list of your desired Phone Book entry.

See step 1 to 5 on *Calling a number in the phone book* on page 45 for how to do this.

2 Press and hold MULTI-CONTROL to display the name input screen.

Edit name is displayed.

3 Turn MULTI-CONTROL to switch to the number input screen.

Edit name (name input screen)—

Edit number (number input screen)—

Clear memory (clear memory screen)

4 Push MULTI-CONTROL left or right to move the cursor to the number you want to change.

5 Push MULTI-CONTROL up or down to change numbers.

Repeat these steps until you have finished changing.

6 Press MULTI-CONTROL to store the new number.

Clearing a phone book entry

Important

Be sure to park your vehicle and apply the parking brake when performing this operation.

1 Display the detailed list of your desired Phone Book entry.

See step 1 to 5 on *Calling a number in the phone book* on page 45 for how to do this.

2 Press and hold MULTI-CONTROL to display the name input screen.

Edit name is displayed.

3 Turn MULTI-CONTROL to switch to the clear memory screen.

Edit name (name input screen)—

Edit number (number input screen)—

Clear memory (clear memory screen)

4 Push MULTI-CONTROL right to show a confirmation display.

Clear memory YES is displayed.

- If you do not want to clear memory that you have selected, push **MULTI-CONTROL** left. The display reverts.

5 Press MULTI-CONTROL to delete the Phone Book entry.

Cleared is displayed.

The Phone Book entry is deleted. The display returns to Phone Book entry list.

Using the call history

Important

Be sure to park your vehicle and apply the parking brake when performing this operation.

The 12 most recent calls made (dialed), received and missed, are stored in the call history. You can browse the call history and call numbers from it.

1 Press LIST to display the list.

Press **LIST** repeatedly to switch between the following lists:

Phone book—Missed call—Dialed call—Received call

- For more details about the Phone Book list, refer to *Using the phone book* on page 45.

- If no phone numbers are stored in the selected list, **No data** is displayed.

2 Turn MULTI-CONTROL to select a phone number.

Turning **MULTI-CONTROL** to change the phone numbers stored in the list.

- If the number is already in the phone book, the name is displayed.

- You can also change the phone number by pushing **MULTI-CONTROL** up or down.

3 Push MULTI-CONTROL right to display the detailed list.

Name and phone number are displayed in the detailed list.

- If the number is already in the Phone Book then the name is also displayed.
- Turning **MULTI-CONTROL** switches to the previous or next phone number displayed in the detailed list.
- If you do not operate anything within about 30 seconds, the list display is canceled automatically.

4 Press **MULTI-CONTROL** to make a call.

- For an international call, press and hold **MULTI-CONTROL** to add + to the phone number.

5 To end the call, push **MULTI-CONTROL** down.

Using preset numbers



Important

Be sure to park your vehicle and apply the parking brake when performing this operation.

Numbers that you dial frequently can be assigned to presets for quick recall.

1 Select a desired phone number from the phone book or the call history. Or directly enter a desired phone number.

To select a desired phone number from the Phone Book or the Call History, see the instructions explained in previous pages. To directly enter a desired phone number, see *Making a call by entering phone number* on this page.

2 Press and hold one of 1 to 6 on the remote control to store the phone number.

The selected phone number has been stored in memory. The next time you press the same preset button, the phone number is recalled from memory.

Making a call by entering phone number



Important

Be sure to park your vehicle and apply the parking brake when performing this operation.

1 Display the function menu.

Refer to *Function and operation* on page 42.

2 Use **MULTI-CONTROL** to select Number dial in the function menu.

- You can also enter in this menu from the standby display by pressing **DIRECT** on the remote control.

3 Push **MULTI-CONTROL** up or down to select a number.

- You can also input numbers by pressing 0 to 9 on the remote control.

4 Push **MULTI-CONTROL** left or right to move the cursor to the previous or next position.

- Up to 24 digits can be entered.

5 When you completed entering the number, press **MULTI-CONTROL**.

Call confirmation appears.

6 Press **MULTI-CONTROL** again to make a call.

7 To end the call, push **MULTI-CONTROL** down.

Clearing memory

1 Display the function menu.

Refer to *Function and operation* on page 42.

2 Use **MULTI-CONTROL** to select Clear memory in the function menu.

3 Push **MULTI-CONTROL** up or down to select an item.

Each time **MULTI-CONTROL** is pushed up or down, the items are switched in the following order:

Available accessories

Phone book (phone book)—**Missed calls** (missed call history)—**Dialed calls** (dialed call history)—**Received calls** (received call history)—**Dial preset** (preset phone numbers)—**All clear** (delete all memory)

- If you want to clear all the Phone Book, dialed/received/missed call history list and pre-set phone number, select **All clear**.
- If guest phone is connected to this unit via Bluetooth wireless technology, **Phone book** cannot be selected.

4 Push MULTI-CONTROL right to determine the item that you want to delete from this unit.

Clear memory YES is displayed. Clearing memory is now on standby.

- If you do not want to clear memory that you have selected, push **MULTI-CONTROL** left. The display reverts.

5 Press MULTI-CONTROL to clear the memory.

Cleared is displayed and data on the selected item is cleared from this unit's memory.

Setting automatic rejecting

1 Display the function menu.

Refer to *Function and operation* on page 42.

2 Use MULTI-CONTROL to select Refuse calls in the function menu.

3 Press MULTI-CONTROL to turn automatic call rejection on.

- To turn automatic call rejection off, press **MULTI-CONTROL** again.

Setting automatic answering

1 Display the function menu.

Refer to *Function and operation* on page 42.

2 Use MULTI-CONTROL to select Auto answer in the function menu.

3 Press MULTI-CONTROL to turn automatic answering on.

- To turn automatic answering function off, press **MULTI-CONTROL** again.

Switching the ring tone

1 Display the function menu.

Refer to *Function and operation* on page 42.

2 Use MULTI-CONTROL to select Ring tone in the function menu.

3 Press MULTI-CONTROL to turn the ring tone on.

- To turn the ring tone off, press **MULTI-CONTROL** again.

Echo canceling and noise reduction

1 Display the function menu.

Refer to *Function and operation* on page 42.

2 Use MULTI-CONTROL to select Echo cancel in the function menu.

3 Press MULTI-CONTROL to turn echo canceling on.

- To turn echo canceling off, press **MULTI-CONTROL** again. 

XM tuner

Listening to XM Satellite Radio

You can use this unit to control an XM satellite digital tuner (GEX-P920XM), which is sold separately.

For details concerning operation, refer to the XM tuner's operation manuals. This section provides information on XM operations with this unit which differs from that described in the XM tuner's operation manual.

- With this unit, you can operate two additional functions: XM channel direct selection and preset channel list.

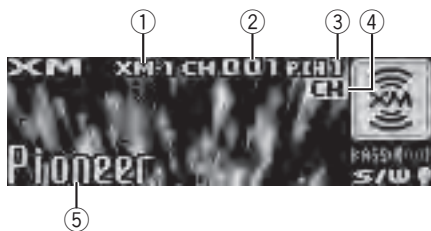

- ① XM band indicator
- ② XM channel number indicator
- ③ XM preset number indicator
- ④ XM channel select setting indicator
Shows what channel select setting has been selected. **CH** is displayed when **Channel number** is selected, and **CAT** is displayed when **Category** is selected.
- ⑤ XM text information
Shows the text information of broadcast channel.

● Select an XM band.

Press **BAND**.

- Band can be selected from **XM-1**, **XM-2** or **XM-3**.

● Select a channel.

Push **MULTI-CONTROL** left or right.

- If you push and hold **MULTI-CONTROL** left or right, you can increase or decrease channel number continuously.
- You can also perform tuning from a desired channel category. (Refer to *Selecting a channel in the channel category* on the next page.)

Selecting an XM channel directly

When using the remote control, you can select the XM channel directly by entering the desired channel number.

1 Press DIRECT.

Channel number input display appears.

2 Press 0 to 9 buttons to enter the desired channel number.

- You can cancel the input number by pressing **CLEAR**.

3 Press DIRECT.

The XM channel of entered number is selected.

- After entering the number input mode, if you do not perform an operation within about eight seconds, the mode is automatically canceled.

Switching the XM display

● Press DISP to switch the XM display.

- You can scroll the text information to the left by pressing and holding **DISP**.

Storing and recalling broadcast stations

You can easily store up to six broadcast stations for later recall.

- Six stations for each band can be stored in memory.

1 Press LIST.

Preset screen is displayed.

2 Use MULTI-CONTROL to store the selected station in memory.

Turn to change the preset number. Press and hold to store.

The XM preset number you have selected will flash and then remain lit. The selected station has been stored in memory.

3 Use MULTI-CONTROL to select the desired station.

Turn to change the station; press to select.

- You can also change the station by pushing **MULTI-CONTROL** up or down.
- If you do not operate the list within about 30 seconds, the display is automatically returned to the ordinary display.

Available accessories

Using the remote control

- When you find a station that you want to store in memory, press one of preset tuning buttons 1 to 6 and hold until the XM preset number stops flashing.

The number you have pressed will flash in the XM preset number indicator and then remain lit. The selected station has been stored in memory.

The next time you press the same preset tuning button the station is recalled from memory.

- You can also recall stations assigned to preset tuning numbers by pushing **MULTI-CONTROL** up or down.

Switching the XM channel select mode

You have two methods for selecting a channel: by number and by category. When selecting by number, channels in any category can be selected. Select by category to narrow your search down to only channels in a particular category.

- Press **SAT MODE** repeatedly to select the desired channel select setting.

Channel number (channel number select setting)—**Category** (channel category select setting)

- If you do not operate the function within about 30 seconds, the display is automatically returned to the channel display.

Note

You can also perform this operation in the menu that appears by using **MULTI-CONTROL**.

Selecting a channel in the channel category

- 1 Select the channel select settings to **Category**.

Refer to *Switching the XM channel select mode* on this page.

- 2 Push **MULTI-CONTROL** up or down to select the desired channel category.

- 3 Push **MULTI-CONTROL** left or right to select the desired channel in the selected channel category.

Displaying the Radio ID

Channel number select setting

- 1 Select the channel select settings to **Channel number**.

Refer to *Switching the XM channel select mode* on this page.

- 2 Push **MULTI-CONTROL** left or right to select **RADIO ID**.

- If you select another channel, display of the ID code is canceled.
- Display of the ID code repeats displaying **RADIO ID** and the ID code one after the other. 

SIRIUS Satellite Radio tuner

Listening to SIRIUS Satellite Radio

You can use this unit to control a SIRIUS Satellite Radio tuner, which is sold separately.

When the SIRIUS tuner is used together with this unit, some operations differ slightly from those described in the SIRIUS operation manual. This manual provides information on these points. For all other information on using the SIRIUS tuner, please refer to the SIRIUS operation manual.

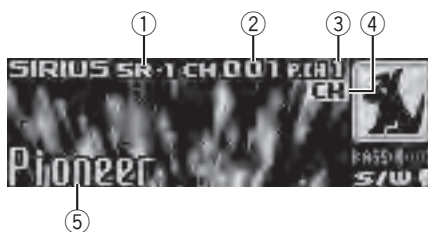

- ① SIRIUS band indicator
- ② SIRIUS channel number indicator

Available accessories

- ③ SIRIUS preset number indicator
- ④ SIRIUS channel select setting indicator
Shows what channel select setting has been selected. **CH** is displayed when **Channel number** is selected, and **CAT** is displayed when **Category** is selected. **I.R** is displayed during the Instant Replay mode.
- ⑤ SIRIUS channel name
Shows the channel name of broadcast channel.

● Select a SIRIUS band.

Press **BAND**.

- Band can be selected from **SR-1**, **SR-2** or **SR-3**.

● Select a channel.

Push **MULTI-CONTROL** left or right.

- If you push and hold **MULTI-CONTROL** left or right, you can increase or decrease channel number continuously.
- You can also perform tuning from a desired channel category. (Refer to *Selecting a channel in the channel category* on the next page.)



Note

It may take a few seconds before you can hear anything while this unit acquires and processes the satellite signal when you change the source to SIRIUS tuner or select a channel.

Selecting a SIRIUS channel directly

When using the remote control, you can select the SIRIUS channel directly by entering the desired channel number.

1 Press **DIRECT**.

Channel number input display appears.

2 Press 0 to 9 buttons to enter the desired channel number.

- You can cancel the input number by pressing **CLEAR**.

3 Press **DIRECT**.

The SIRIUS channel of entered number is selected.

- After entering the number input mode, if you do not perform an operation within about eight seconds, the mode is automatically canceled.

Switching the SIRIUS display

● Press **DISP** to switch the SIRIUS display.

Each press of **DISP** changes the SIRIUS display in the following order:

Play time—Channel number—Channel name—Category name—Artist name—Song title/program title—Composer name

- Play time is displayed during the Instant Replay mode. Refer to *Using Instant Replay function* on page 55.
- Play time display indicates the time inverted from the live broadcast. Play time is displayed in negative number.

Storing and recalling broadcast stations

You can easily store up to six broadcast stations for later recall.

- Six stations for each band can be stored in memory.

● When you find a station that you want to store in memory press one of preset tuning buttons 1 to 6 and hold until the SIRIUS preset number stops flashing.

The number you have pressed will flash in the SIRIUS preset number indicator and then remain lit. The selected station has been stored in memory.

The next time you press the same preset tuning button the station is recalled from memory.

- You can also recall stations assigned to preset tuning numbers by pushing **MULTI-CONTROL** up or down.

Available accessories

Introduction of advanced operations

1 Press MULTI-CONTROL to display the main menu.

2 Use MULTI-CONTROL to select FUNCTION.

The function selection menu is displayed. Turn to change the menu option. Press to select.

3 Turn MULTI-CONTROL to select the function.

Channel mode (channel select mode setting)

—**Game alert** (game alert setting)—

Team setting (team setting)—**Game info**

(game info)—**Pause** (pause)

Notes

- You can also select the function by pressing **FUNCTION** on the remote control.
- To return to the ordinary display, press **BAND**.
- If you do not operate functions within about 30 seconds, the display is automatically returned to the ordinary display.
- During the Instant Replay mode, you can select **Pause** (pause). Refer to *Using Instant Replay function* on page 55.
- **Pause** is the same as that of the built-in CD player. (Refer to *Pausing playback* on page 18.)

Selecting the SIRIUS channel select mode

You have two methods for selecting a channel: by number and by category. When selecting by number, channels in any category can be selected. Select by category to narrow your search down to only channels in a particular category.

- **Press SAT MODE repeatedly to select the desired channel select setting.**
Channel number (channel number select setting)—**Category** (channel category select setting)

Note

You can also perform this operation in the menu that appears by using **MULTI-CONTROL**.

Selecting a channel in the channel category

1 Select the channel select settings to Category.

Refer to *Selecting the SIRIUS channel select mode* on this page.

2 Push MULTI-CONTROL up or down to select the desired channel category.

3 Push MULTI-CONTROL left or right to select the desired channel in the selected channel category.

Using the Game Alert function

Only when SIR-PNR2/SIR-PNR2C is connected to this unit, you can operate this function.

This unit can alert you when games involving your favorite teams are about to start. To use this function you need in advance to set up a game alert for the teams.

Selecting teams for Game Alert

1 Display the function selection menu.

Refer to *Introduction of advanced operations* on this page.

2 Use MULTI-CONTROL to select Team setting in the function menu.

3 Push MULTI-CONTROL left or right to select a desired league.

League names are switched in the display.

4 Push MULTI-CONTROL up or down to select a desired team.

Teams in the selected category are switched in the display.

Available accessories

5 Press **MULTI-CONTROL** to store the selected team in memory.

The game alert function will start on that team.

- To turn the Game Alert off of the selected team, press **MULTI-CONTROL** again.
- When you have already made 12 team selections, **FULL** is displayed and additional team selection is not possible. In this case, first delete the team selection and then try again.

6 Repeat these steps for selecting other teams.

Up to 12 teams can be selected.

Switching the Game Alert on or off

Once you made team selections, you need to turn the Game Alert function on.

- The Game Alert function is on at the default setting.

1 Display the function selection menu.

Refer to *Introduction of advanced operations* on the previous page.

2 Use **MULTI-CONTROL** to select Game alert in the function menu.

3 Press **MULTI-CONTROL** to turn the Game Alert on.

The Game Alert function is now on.

- To turn the Game Alert function off, press **MULTI-CONTROL** again.

When the game of the selected team starts

When a game of the selected team is about to start (or is currently playing) on a different station, **Game alert info** is displayed. Press and hold **MULTI-CONTROL** to switch to that station, and you can listen to that game.

- If you do not operate the function within about 10 seconds, the display is automatically returned.

Displaying game information

If games of your selected teams are currently playing, you can display information of the games and tune to the broadcast channel. You can display information of the games while enjoying the sound from currently tuning station. You can also tune to the broadcast channel when you wish to.

1 Display the function selection menu.

Refer to *Introduction of advanced operations* on the previous page.

2 Use **MULTI-CONTROL** to select Game info in the function menu.

The game information of your selected team is displayed.

3 Push **MULTI-CONTROL** up or down to select a game.

The game is displayed, followed by more detailed game information.

- Game score will be updated automatically.

4 Press **MULTI-CONTROL** to switch to that station to listen to the game.

Notes

- If you have not made any team selections, **NOT SET** is displayed.
- When games involving your favorite teams are not currently playing, **NO GAME** is displayed.

Displaying the Radio ID

If you select **CH 000**, the ID code is displayed.

● Push **MULTI-CONTROL** left or right to select **CH 000**.

Note

To select **CH 000**, set the channel select setting to **Channel number**. About the channel select setting, refer to *Selecting the SIRIUS channel select mode* on the previous page.

Available accessories

Using Instant Replay function

Following functions can be operated during the Instant Replay mode.

- To use this function, Pioneer SIRIUS bus interface (e.g. CD-SB10) is required.
- To use this function, SIRIUS plug-and-play unit with Instant Replay Function is required.
- For details, refer to SIRIUS plug-and-play unit's manuals.

● Performing the Instant Replay mode

When SIRIUS tuner is selected as the source, press and hold **SAT MODE**.

- In the following conditions, tuner exits from the Instant Replay mode.
 - When **BAND** is pressed
 - When another source is selected

● Select a track

Push **MULTI-CONTROL** left or right.

● Fast forward or reverse

Push and hold **MULTI-CONTROL** left or right for about one second and release. 

Multi-CD Player

Basic Operations

You can use this unit to control a multi-CD player, which is sold separately.

- Only functions described in this manual are supported by 50-disc multi-CD players.
- This unit is not designed to operate disc title list functions with a 50-disc multi-CD player. For information about the disc title list functions, refer to *Selecting discs from the disc title list* on page 58.

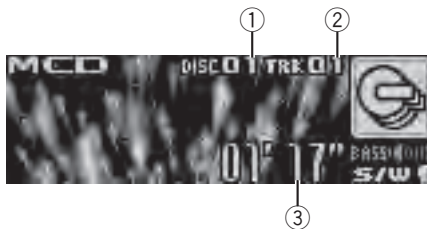

- ① Disc number indicator
- ② Track number indicator
- ③ Play time indicator

● Select a disc

Push **MULTI-CONTROL** up or down.

- You can also select a disc by using **1** to **6** buttons on the remote control.
 - For discs 1 to 6, press the corresponding button number.
 - For discs 7 to 12, press and hold the corresponding numbers, such as **1** for disc 7, until the disc number appears in the display.

● Fast forward or reverse

Push and hold **MULTI-CONTROL** left or right.

● Select a track

Push **MULTI-CONTROL** left or right.

Notes

- When multi-CD player completes preparatory operations, **READY** is displayed.
- If an error message such as **ERROR-11** is displayed, refer to the multi-CD player owner's manual.
- If there are no discs in the multi-CD player magazine, **No disc** is displayed.

Using CD TEXT functions

You can use these functions only with a CD TEXT compatible multi-CD player.

The operation is the same as that of the built-in CD player.

Refer to *Displaying text information on disc* on page 16.

Introduction of advanced operations

You can only use **Compression** (compression and DBE) with a multi-CD player that supports them.

1 Press MULTI-CONTROL to display the main menu.

2 Use MULTI-CONTROL to select FUNCTION.

Turn to change the menu option. Press to select.

The function menu is displayed.

3 Turn MULTI-CONTROL to select the function.

Play mode (repeat play)—**Random mode** (random play)—**Scan mode** (scan play)—**Pause** (pause)—**compression** (compression and DBE)—**ITS play mode** (ITS play)—**ITS memo** (ITS programming)—**TitleInput "A"** (disc title input)

- If you do not operate functions other than **ITS memo** and **TitleInput "A"** within about 30 seconds, the display automatically returns to the ordinary display.
- When playing a CD TEXT disc on a CD TEXT compatible multi-CD player, you cannot switch to **TitleInput "A"**. The disc title is already recorded on the CD TEXT disc.

Function and operation

Play mode, **Random mode**, **Scan mode**, **Pause** and **TitleInput "A"** operations are basically the same as that of the built-in CD player.

Function name	Operation
Play mode	Refer to <i>Selecting a repeat play range</i> on page 17. However, the repeat play ranges you can select are different from that of the built-in CD player. The repeat play ranges of the multi-CD player are: <ul style="list-style-type: none"> • M-CD repeat – Repeat all discs in the multi-CD player • Track repeat – Repeat just the current track • Disc repeat – Repeat the current disc
Random mode	Refer to <i>Playing tracks in random order</i> on page 17.
Scan mode	Refer to <i>Scanning folders and tracks</i> on page 18.
Pause	Refer to <i>Pausing playback</i> on page 18.
TitleInput "A"	Refer to <i>Entering disc titles</i> on page 18.



Notes

- You can also select the function by pressing **FUNCTION** on the remote control.
- To return to the playback display, press **BAND**.
- If you select other discs during repeat play, the repeat play range changes to **M-CD repeat**.
- If you perform track search or fast forward/reverse during **Track repeat**, the repeat play range changes to **Disc repeat**.
- After track or disc scanning is finished, normal playback of the tracks begins again.

Using compression and bass emphasis

You can only use these functions with a multi-CD player that supports them.

COMP (compression) and DBE (dynamic bass emphasis) functions lets you adjust the sound playback quality of the multi-CD player.

Available accessories

1 Display the function menu.

Refer to *Introduction of advanced operations* on the previous page.

2 Use MULTI-CONTROL to select compression in the function menu.

- If the multi-CD player does not support COMP/DBE, **NO COMP** is displayed when you attempt to select it.

3 Press MULTI-CONTROL to select your favorite setting.

**COMP OFF—COMP 1—COMP 2—
COMP OFF—DBE 1—DBE 2**

Using ITS playlists

ITS (instant track selection) lets you make a playlist of favorite tracks from the multi-CD player magazine. After you have added your favorite tracks to the playlist, you can turn on ITS play and play just those selections.

You can use ITS to enter and play back up to 99 tracks per disc from up to 100 discs (with the disc titles). (With multi-CD players sold before the CDX-P1250 and CDX-P650, up to 24 tracks can be stored in the playlist.)

Creating a playlist with ITS programming

1 Play a CD that you want to program.

Push **MULTI-CONTROL** up or down to select the CD.

2 Display the function menu.

Refer to *Introduction of advanced operations* on the previous page.

3 Use MULTI-CONTROL to select ITS memo in the function menu.

4 Select the desired track by pushing MULTI-CONTROL left or right.

5 Push MULTI-CONTROL up to store the currently playing track in the playlist.

Memory complete is displayed and the currently playing selection is added to your playlist.

6 Press BAND to return to the playback display.



Note

After data for 100 discs is stored in memory, data for a new disc will overwrite the oldest one.

Playback from your ITS playlist

ITS play lets you listen to the tracks that you have entered into your ITS playlist. When you turn on ITS play, tracks from your ITS playlist in the multi-CD player begin to play.

1 Select the repeat range.

Refer to *Playing tracks in random order* on page 17.

2 Display the function menu.

Refer to *Introduction of advanced operations* on the previous page.

3 Use MULTI-CONTROL to select ITS play mode in the function menu.

4 Press MULTI-CONTROL to turn ITS play on.

ITS play appears in the display. Playback begins of those tracks from your playlist within the previously selected **M-CD repeat** or **Disc repeat** ranges.

- If no tracks in the current range are programmed for ITS play, then **ITS empty** is displayed.
- To turn ITS play off, press **MULTI-CONTROL** again.

Erasing a track from your ITS playlist

You can delete a track from your ITS playlist if ITS play is on.

If ITS play is already on, skip to step 2. If ITS play is not already on, use **MULTI-CONTROL**.

1 Play the CD with the track you want to delete from your ITS playlist, and turn ITS play on.

Refer to *Playback from your ITS playlist* on this page.

Available accessories

2 Display the function menu.

Refer to *Introduction of advanced operations* on page 56.

3 Use MULTI-CONTROL to select ITS memo in the function menu.

4 Select the desired track by pushing MULTI-CONTROL left or right.

5 Push MULTI-CONTROL down to erase the track from your ITS playlist.

The currently playing selection is erased from your ITS playlist and playback of the next track begins.

- If there are no tracks from your playlist in the current range, **ITS empty** is displayed and normal playback resumes.

6 Press BAND to return to the playback display.

Erasing a CD from your ITS playlist

You can delete all tracks of a CD from your ITS playlist if ITS play is off.

1 Play the CD that you want to delete.

Push **MULTI-CONTROL** up or down to select the CD.

2 Display the function menu.

Refer to *Introduction of advanced operations* on page 56.

3 Use MULTI-CONTROL to select ITS memo in the function menu.

4 Push MULTI-CONTROL down to erase all tracks on the currently playing CD from your ITS playlist.

All tracks on the currently playing CD are deleted from your playlist and **Memory deleted** is displayed.

5 Press BAND to return to the playback display.

Using disc title functions

You can input CD titles and display the titles. Then, you can easily search for and play a desired disc.

Entering disc titles

Use the disc title input feature to store up to 100 CD titles (with ITS playlist) into the multi-CD player. Each title can be up to 10 characters long.

For details concerning operation, refer to *Entering disc titles* on page 18.

- Titles remain in the memory even after the disc is removed from the magazine, and are recalled when the disc is reinserted.
- After data for 100 discs is stored in memory, data for a new disc will overwrite the oldest one.

Displaying disc titles

● Press DISP to select the desired text information.

• For title entered CD

Play time—: disc title and play time

• For CD TEXT discs

Play time—: disc artist name and : track title

—: disc artist name and : disc title

—: track artist name and : track title

—: track title and play time

Selecting discs from the disc title list

Disc title list lets you see the list of disc titles entered in the multi-CD player and select one of them to play back.

1 Press LIST to switch to the disc title list mode during the playback display.

2 Use MULTI-CONTROL to select the desired disc title.

Turn to change the disc title. Press to play.

- You can also change the disc title by pushing **MULTI-CONTROL** up or down.

Available accessories

- When playing CD TEXT disc, push **MULTI-CONTROL** right to see a list of the tracks in the selected disc. Push **MULTI-CONTROL** left to return to the disc list.
- If no title is entered for a disc, **No Title** is displayed.
- **No disc** is displayed next to the disc number when there is no disc in the magazine.
- If you do not operate the list within about 30 seconds, the display automatically returns to the ordinary display. 

DVD Player

Basic Operations

You can use this unit to control a DVD player or multi-DVD player, which is sold separately. For details concerning operation, refer to the DVD player's or multi-DVD player's operation manual. This section provides information on DVD operations with this unit which differs from that described in the DVD player's or multi-DVD player's operation manual.



- ① **DVD-V/VCD/CD/MP3/WMA** indicator
Shows the type of disc currently playing.
- ② Disc number indicator
Shows the number of the disc currently playing when using a multi-DVD player.
- ③ Title/Folder number indicator
Shows the title (when playing DVD video) or folder (when playing compressed audio) of the selection currently playing.
- ④ Chapter/track number indicator
Shows the chapter (when playing DVD video) or track (when playing Video CD, CD or compressed audio) currently playing.
- ⑤ Play time indicator

- **Select a chapter/track**

Push **MULTI-CONTROL** left or right.

- **Fast forward or reverse**

Push and hold **MULTI-CONTROL** left or right.

- When playing compressed audio, there is no sound on fast forward or reverse.

- **To skip back or forward to another chapter/track, push MULTI-CONTROL left or right.**

Selecting a disc

- You can operate this function only when a multi-DVD player is connected to this unit.
- Press any of 1 to 6 on the remote control to select the desired disc.

Selecting a folder

- You can operate this function only when a DVD player compatible with compressed audio playback is connected to this unit.
- Push MULTI-CONTROL up or down to select a folder.

Introduction of advanced operations

1 Press MULTI-CONTROL to display the main menu.

2 Use MULTI-CONTROL to select FUNCTION.

Turn to change the menu option. Press to select.

The function menu is displayed.

3 Turn MULTI-CONTROL to select the function.

During DVD video or Video CD playback

Play mode (repeat play)—**Pause** (pause)

During CD playback

Play mode (repeat play)—**Random mode**

(random play)—**Scan mode** (scan play)—

Pause (pause)—**ITS play mode** (ITS play)—

ITS memo (ITS input)—**TitleInput "A"** (disc title input)

During compressed audio playback

Play mode (repeat play)—**Random mode**

(random play)—**Scan mode** (scan play)—

Pause (pause)

- You can also select the function by pressing FUNCTION on the remote control.

- To return to the playback display, press BAND.

- If you do not operate functions except for ITS memo and TitleInput "A" within about 30

seconds, the display is automatically returned to the ordinary display.

Function and operation

Play mode, **Random mode**, **Scan mode**, **Pause** and **TitleInput "A"** operations are basically the same as that of the built-in CD player. Also, **ITS play mode** and **ITS memo** operations are basically the same as that the multi-CD player.

Function name	Operation
	Refer to <i>Selecting a repeat play range</i> on page 17. But the repeat play range that you can select is vary depending on the type of disc or system. The repeat play ranges of the DVD player/multi-DVD player are as below: During PBC playback of Video CDs, this function cannot be operated.
Play mode	<ul style="list-style-type: none"> ● Disc repeat – Repeat the current disc ● Folder repeat – Repeat the current folder ● Title repeat – Repeat just the current title ● Chapter repeat – Repeat just the current chapter ● Track repeat – Repeat the current track
Random mode	Refer to <i>Playing tracks in random order</i> on page 17.
Scan mode	Refer to <i>Scanning folders and tracks</i> on page 18.
Pause	Refer to <i>Pausing playback</i> on page 18.
ITS play mode	Refer to <i>Using ITS playlists</i> on page 57.
ITS memo	Refer to <i>Using ITS playlists</i> on page 57.
TitleInput "A"	Refer to <i>Entering disc titles</i> on page 18.

Available accessories

Notes

- If you select other discs during repeat play, the repeat play range changes to **Disc repeat**.
- When playing back Video CD or CD, if you perform track search or fast forward/reverse during **Track repeat**, the repeat play range changes to **Disc repeat**.
- When playing back compressed audio, if you select another folder during repeat play, the repeat play range changes to **Disc repeat**.
- When playing back compressed audio, if you perform track search or fast forward/reverse during **Track repeat**, the repeat play range changes to **Folder repeat**.
- Multi-DVD player that has ITS functions and disc title functions can also be connected to this unit. In this case, **ITS play mode**, **ITS memo** and disc title input can be controlled.
- The ITS function of a DVD player differs slightly from ITS playback with a multi-CD player. With multi-DVD player, ITS playback applies only to the CD playing. For details, refer to *Using ITS playlists* on page 57. 

TV tuner

Basic Operations

You can use this unit to control a TV tuner, which is sold separately.

For details concerning operation, refer to the TV tuner's operation manual. This section provides information on TV operations with this unit, which differs from that described in the TV tuner's operation manual.



- ① Band indicator

- ② Preset number indicator
③ Channel indicator

● Select a band

Press **BAND**.

● Select a channel (step by step)

Push **MULTI-CONTROL** left or right.

● Seek tuning

Push and hold **MULTI-CONTROL** left or right for about one second and release.

Notes

- Band can be selected from **TV-1** or **TV-2**.
- You can cancel seek tuning by pushing **MULTI-CONTROL** left or right.
- If you push and hold **MULTI-CONTROL** left or right, you can skip stations. Seek tuning starts as soon as you release **MULTI-CONTROL**.

Storing and recalling broadcast stations

You can easily store up to 12 broadcast stations for later recall.

- 12 stations for each band can be stored in memory.

1 Press LIST.

Preset screen is displayed.

2 Use MULTI-CONTROL to store the selected station in memory.

Turn to change the preset number. Press and hold to store.

- You can also store the station in memory by pushing and holding **MULTI-CONTROL** right.

3 Use MULTI-CONTROL to select the desired station.

Turn to change the station. Press to select.

- You can also change the station by pushing **MULTI-CONTROL** up or down.
- If you do not operate the list within about 30 seconds, the display automatically returns to the ordinary display.

Available accessories

Using the remote control

You can also store and recall stations assigned to preset tuning numbers **P 1** to **P 6** by using the remote control.

- **When you find a station that you want to store in memory, press one of preset tuning buttons 1 to 6 and hold until the preset number stops flashing.**

The number you have pressed will flash in the preset number indicator and then remain lit. The selected station has been stored in memory.

The next time you press the same preset tuning button the station is recalled from memory.

- You can also recall stations assigned to preset tuning numbers by pushing **MULTI-CONTROL** up or down during the channel display.

Storing the strongest broadcast stations sequentially

1 Press MULTI-CONTROL to display the main menu.

2 Use MULTI-CONTROL and select FUNCTION to display BSSM.

- You can also select the function by pressing **FUNCTION** on the remote control.

3 Press MULTI-CONTROL to turn BSSM on.

Searching begins to flash. While **Searching** is flashing, the 12 strongest broadcast stations are stored in order from the lowest channel up. When finished, the preset channel list appears.

- To cancel the storage process, press **MULTI-CONTROL** again.

4 Use MULTI-CONTROL to select the desired station.

Turn to change the station. Press to select.

- You can also change the station by pushing **MULTI-CONTROL** up or down.
- To return to the ordinary display, press **BAND**.

- If you do not operate the list within about 30 seconds, the display automatically returns to the ordinary display. 

Additional Information

Error messages

When you contact your dealer or your nearest Pioneer Service Center, be sure to have the error message recorded.

Built-in CD Player

Message	Cause	Action
ERROR-11, 12, 17, 30	Dirty disc	Clean disc.
ERROR-11, 12, 17, 30	Scratched disc	Replace disc.
ERROR-10, 11, 12, 15, 17, 30, A0	Electrical or mechanical	Turn the ignition switch OFF and back ON, or switch to a different source, then back to the CD player.
ERROR-15	The inserted disc does not contain any data	Replace disc.
ERROR-22, 23	The CD format cannot be played back	Replace disc.
No Audio	The inserted disc does not contain any files that can be played back	Replace disc.
TRK SKIPPED	The inserted disc contains WMA files that are protected by DRM	Replace disc.
PROTECT	All the files on the inserted disc are secured by DRM	Replace disc.

USB audio player/USB memory

Message	Cause	Action
No Audio	No songs	Transfer the audio files to the USB portable audio player/USB memory and connect.
	USB memory with security enabled is connected	Follow the USB memory instructions to disable the security.
	No songs	Transfer the songs to iPod.

TRK SKIPPED	The connected USB portable audio player/USB memory contains WMA files that are protected by Windows Media DRM 9/10	Play an audio file not protected by Windows Media DRM 9/10.
PROTECT	All the files on the connected USB portable audio player/USB memory are protected by Windows Media DRM 9/10	Transfer audio files not protected by Windows Media DRM 9/10 to the USB portable audio player/USB memory and connect.
N/A USB	The USB device connected to is not supported by this unit.	Connect a USB portable audio player or USB memory that is USB Mass Storage Class compliant.
CHECK USB	The USB connector or USB cable is short-circuited.	Confirm that the USB connector or USB cable is not caught in something or damaged.
	The connected USB portable audio player/USB memory consumes more than 500 mA (maximum allowable current).	Disconnect the USB portable audio player/USB memory and do not use it. Turn the ignition switch to OFF, then to ACC or ON and then connect the compliant USB portable audio player/USB memory.

Additional Information

ERROR-19	Communication failure	Perform one of the following operations. -Turn the ignition switch OFF and back ON. -Disconnect the USB portable audio player/USB memory. -Change to a different source. Then, return to the USB portable audio player/USB memory.
-----------------	-----------------------	--

ERROR-23	USB device is not formatted with FAT16 or FAT32	USB device should be formatted with FAT16 or FAT32.
-----------------	---	---

iPod

Message	Cause	Action
ERROR-19	Communication failure	Disconnect the cable from iPod. Once iPod main menu is displayed, connect the cable again. Reset the iPod.
	iPod failure	Disconnect the cable from iPod. Once iPod main menu is displayed, connect the cable again. Reset the iPod.
N/A USB	Old version of iPod	Update the iPod version.
	iPod failure	Reset the iPod.
ERROR-16	Old version of iPod	Update the iPod version.
	iPod failure	Disconnect the cable from iPod. Once iPod main menu is displayed, connect the cable again. Reset the iPod.

ERROR-A1 CHECK USB	iPod is not charged but operates correctly	Check if the connection cable for iPod shorted out (e.g., not caught in metal objects). After checking, turn the ignition switch OFF and back ON or disconnect the iPod and connect again.
No Songs	No songs	Transfer the songs to iPod.
STOP	No songs in the current list	Select a list that contains the songs.



Handling guideline of discs and player

- Use only discs featuring either of following two logos.



- Use only conventional, fully circular discs. Do not use shaped discs.



- Use 12-cm or 8-cm CD. Do not use an adapter when playing 8-cm CDs.
- Do not insert anything other than a CD into the CD loading slot.
- Do not use cracked, chipped, warped, or otherwise damaged discs as they may damage the player.
- Unfinalized CD-R/CD-RW disc playback is not possible.
- Do not touch the recorded surface of the discs.
- Store discs in their cases when not in use.

Additional Information

- Avoid leaving discs in excessively hot environments including under direct sunlight.
- Do not attach labels, write on or apply chemicals to the surface of the discs.
- To clean a CD, wipe the disc with a soft cloth outward from the center.
- Condensation may temporarily impair the player's performance. Leave it to adjust to the warmer temperature for about one hour. Also, wipe any dump discs with a soft cloth.
- Playback of discs may not be possible because of disc characteristics, disc format, recorded application, playback environment, storage conditions, and so on.
- Text information may not be correctly displayed depending on the recorded environment.
- Road shocks may interrupt disc playback.
- Read the precautions for discs before using them. 

Dual Discs

- Dual Discs are two-sided discs that have a recordable CD for audio on one side and a recordable DVD for video on the other.
- Since the CD side of Dual Discs is not physically compatible with the general CD standard, it may not be possible to play the CD side with this unit.
- Frequent loading and ejecting of a Dual Disc may result in scratches on the disc. Serious scratches can lead to playback problems on this unit. In some cases, a Dual Disc may become stuck in the disc loading slot and will not eject. To prevent this, we recommend you refrain from using Dual Disc with this unit.
- Please refer to the information from the disc manufacturer for more detailed information about Dual Discs. 

Compressed audio compatibility

WMA

- Compatible format: WMA encoded by Windows Media Player
- Bit rate: 48 kbps to 320 kbps (CBR), 48 kbps to 384 kbps (VBR)
- Sampling frequency: 32 kHz to 48 kHz
- Windows Media Audio 9 Professional, Lossless, Voice: No

MP3

- Bit rate: 8 kbps to 320 kbps
- Sampling frequency: 16 kHz to 48 kHz (32, 44.1, 48 kHz for emphasis)
- Compatible ID3 tag version: 1.0, 1.1, 2.2, 2.3, 2.4 (ID3 tag Version 2.x is given priority than Version 1.x.)
- M3u playlist: No
- MP3i (MP3 interactive), mp3 PRO: No

AAC

- Compatible format: AAC encoded by iTunes®
- Sampling frequency: 11.025 kHz to 48 kHz
- Transmission rate: 16 kbps to 320 kbps
- Apple Lossless: No

WAV

- Compatible format: Linear PCM (LPCM), MS ADPCM
- Quantization bits: 8 and 16 (LPCM), 4 (MS ADPCM)
- Sampling frequency: 16 kHz to 48 kHz (LPCM), 22.05 kHz to 44.1 kHz (MS ADPCM) 

USB audio player/USB memory

USB audio player/USB memory compatibility

- USB version: 2.0, 1.1 and 1.0
- USB data transfer rate: full speed
- USB Class: MSC (Mass Storage Class) device

Additional Information

- Protocol: bulk
- Minimum amount of memory: 250 MB
- Maximum amount of memory: 250 GB
- File system: FAT32 and FAT16
- Supply current: 500 mA



Notes

- Partitioned USB memory is not compatible with this unit.
- Depending on the kind of USB portable audio player/USB memory you use, this unit may not recognize the USB audio player/USB memory or audio files may not be played back properly.
- This unit can play back files in the USB portable audio player/USB memory that is USB Mass Storage Class. However, copyright protected files that are stored in above-mentioned USB devices cannot be played back. (If the iPod is connected to this unit, file playback condition depends on the iPod specifications.)
- You cannot connect a USB portable audio player/USB memory to this unit via a USB hub.

Handling guideline and supplemental information

- Do not leave the USB portable audio player/USB memory in direct sunlight for extended amounts of time. Extended exposure to direct sunlight can result in USB portable audio player/USB memory malfunction due to the resulting high temperature.
- Do not leave the USB portable audio player/USB memory in high temperature.
- Firmly secure the USB portable audio player/USB memory when driving. Do not let the USB portable audio player/USB memory fall onto the floor, where it may become jammed under the brake or accelerator pedal.
- There may be a slight delay when starting playback of audio files encoded with image data.

- Depending on the USB devices connected to this unit, it may generate noise in the radio.
- Only 32 characters from the beginning can be displayed as a file name (including the extension) or a folder name when USB portable audio player/USB memory is selected as a source.
- The text information of some audio files may not be correctly displayed.
- File extensions must be used properly.
- Up to 15 000 files on a USB portable audio player/USB memory can be played back.
- Up to 500 folders on a USB portable audio player/USB memory can be played back.
- Up to eight tiers directory on a USB portable audio player/USB memory can be played back.
- There may be a slight delay when starting playback of audio files on a USB portable audio player/USB memory with numerous folder hierarchies.
- Do not connect anything other than the USB portable audio player/USB memory.
- Operations may vary depending on the kind of USB audio player and a USB memory.

The sequence of audio files on USB memory

For USB portable audio players, the sequence is different from that of USB memory and depends on the player.

Additional Information

Example of a hierarchy

📁: Folder

🎵: Compressed audio file

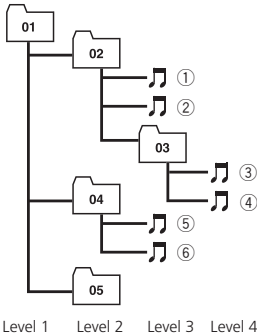

- 01 to 05 represent assigned folder numbers. ① to ⑥ represent the playback sequence. The user cannot assign folder numbers and specify the playback sequence with this unit.
- Playback sequence of the audio file is the same as recorded sequence in the USB device.
- To specify the playback sequence, the following method is recommended.
 - 1 Create the file name including numbers that specify the playback sequence (e.g., 001xxx.mp3 and 099yyy.mp3).
 - 2 Put those files into a folder.
 - 3 Record the folder containing files into the USB device.

However, depending on the system environment, you cannot specify the file playback sequence.

iPod

About handling the iPod

- Do not leave the iPod in direct sunlight for extended amounts of time. Extended exposure to direct sunlight can result in iPod malfunction due to the resulting high temperature.
- Do not leave the iPod in a high temperature.
- Connect directly the dock connector cable to the iPod so that this unit works properly.
- Firmly secure the iPod when driving. Do not let the iPod fall onto the floor, where it may become jammed under the brake or accelerator pedal.
- For details, refer to the iPod's manuals.

About iPod settings

- You cannot operate the iPod Equalizer on Pioneer products. We recommend that you set the iPod Equalizer to off, before connecting to this unit.
- You cannot set Repeat to off on the iPod when using this unit. Even if you set Repeat to off on the iPod, Repeat is automatically changed to All when connecting the iPod to this unit.

Compressed audio files on the disc

- Depending on the version of Windows Media Player used to encode WMA files, album names and other text information may not be correctly displayed.
- There may be a slight delay when starting playback of WMA/AAC files encoded with image data.
- ISO 9660 Level 1 and 2 compliant. Romeo and Joliet file systems are both compatible with this player.
- Multi-session playback is possible.
- Compressed audio files are not compatible with packet write data transfer.
- Only 64 characters from the beginning can be displayed as a file name (including the extension such as .wma, .mp3, .m4a or .wav) or a folder name.
- Folder selection sequence or other operation may be altered depending on the encoding or writing software.

Additional Information

- Regardless of the length of blank section between the songs of original recording, compressed audio discs play with a short pause between songs.
- File extensions such as .wma, .mp3, .m4a or .wav must be used properly.

Example of a hierarchy

📁: Folder

🎵: Compressed audio file

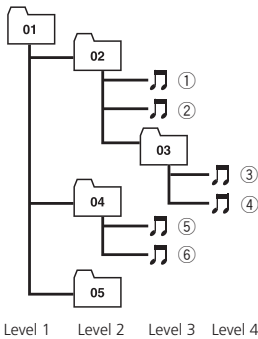

- This unit assigns folder numbers. The user cannot assign folder numbers.
- Folder hierarchy is allowed up to eight tiers. However, a practical hierarchy of folder is less than two tiers.
- Up to 99 folders on a disc can be played back.

Additional Information

Specifications

General

Power source	14.4 V DC (10.8 V to 15.1 V allowable)
Grounding system	Negative type
Max. current consumption	10.0 A
Dimensions (W × H × D): DIN	
Chassis	178 mm × 50 mm × 165 mm (7 in. × 2 in. × 6-1/2 in.)
Nose	188 mm × 58 mm × 18 mm (7-3/8 in. × 2-1/4 in. × 3/4 in.)
D	
Chassis	178 mm × 50 mm × 165 mm (7 in. × 2 in. × 6-1/2 in.)
Nose	170 mm × 45 mm × 18 mm (6-3/4 in. × 1-3/4 in. × 3/4 in.)
Weight	1.5 kg (3.3 lbs)

Audio

Maximum power output	50 W × 4 50 W × 2/4 Ω + 70 W × 1/2 Ω (for subwoofer)
Continuous power output	22 W × 4 (50 Hz to 15 000 Hz, 5% THD, 4 Ω load, both channels driven)
Load impedance	4 Ω to 8 Ω × 4 4 Ω to 8 Ω × 2 + 2 Ω × 1
Preout max output level	4 V
Equalizer (7-Band Graphic Equalizer):	
Frequency	50/125/315/800/2k/5k/12.5k Hz
Gain	±12 dB
HPF:	
Frequency	50/63/80/100/125 Hz
Slope	-12 dB/oct
Subwoofer (mono):	
Frequency	50/63/80/100/125 Hz
Slope	-18 dB/oct
Gain	+6 dB to -24 dB
Phase	Normal/Reverse
Bass boost:	
Gain	+12 dB to 0 dB

CD player

System	Compact disc audio system
Usable discs	Compact disc
Signal-to-noise ratio	94 dB (1 kHz) (IHF-A network)
Number of channels	2 (stereo)

MP3 decoding format	MPEG-1 & 2 Audio Layer 3
WMA decoding format	Ver. 7, 7.1, 8, 9, 10, 11 (2ch audio) (Windows Media Player)
AAC decoding format	MPEG-4 AAC (iTunes® encoded only) (.m4a) (Ver. 7.2 and earlier)
WAV signal format	Linear PCM & MS ADPCM (Non-compressed)

USB

Specification	USB 2.0 full speed
Supply current	500 mA
Maximum amount of memory	250 GB
File system	FAT16, FAT32
MP3 decoding format	MPEG-1 & 2 Audio Layer 3
WMA decoding format	Ver. 7, 7.1, 8, 9, 10, 11 (2ch audio) (Windows Media Player)
AAC decoding format	MPEG-4 AAC (iTunes® encoded only) (.m4a) (Ver. 7.2 and earlier)
WAV signal format	Linear PCM & MS ADPCM (Non-compressed)

FM tuner

Frequency range	87.9 MHz to 107.9 MHz
Usable sensitivity	8 dBf (0.7 μV/75 Ω, mono, S/N: 30 dB)
Signal-to-noise ratio	75 dB (IHF-A network)

AM tuner

Frequency range	530 kHz to 1 710 kHz (10 kHz)
Usable sensitivity	18 μV (S/N: 20 dB)
Signal-to-noise ratio	65 dB (IHF-A network)

CEA2006 Specifications



Power output	14 W RMS × 4 Channels (4 Ω and ≤ 1% THD+N)
S/N ratio	91 dBA (reference: 1 W into 4 Ω)

Note

Specifications and the design are subject to modifications without notice due to improvements. ■

*Register your product at
Enregistrez votre produit au*

<http://www.pioneerelectronics.com>

*See "Visit our website" page
Voir la page "Visitez notre site Web"*

PIONEER CORPORATION

4-1, MEGURO 1-CHOME, MEGURO-KU
TOKYO 153-8654, JAPAN

PIONEER ELECTRONICS (USA) INC.

P.O. Box 1540, Long Beach, California 90801-1540, U.S.A.
TEL: (800) 421-1404

PIONEER EUROPE NV

Haven 1087, Keetberglaan 1, B-9120 Melsele, Belgium
TEL: (0) 3/570.05.11

PIONEER ELECTRONICS ASIACENTRE PTE. LTD.

253 Alexandra Road, #04-01, Singapore 159936
TEL: 65-6472-7555

PIONEER ELECTRONICS AUSTRALIA PTY. LTD.

178-184 Boundary Road, Braeside, Victoria 3195, Australia
TEL: (03) 9586-6300

PIONEER ELECTRONICS OF CANADA, INC.

300 Allstate Parkway, Markham, Ontario L3R 0P2, Canada
TEL: 1-877-283-5901
TEL: 905-479-4411

PIONEER ELECTRONICS DE MEXICO, S.A. de C.V.

Bldv.Manuel Avila Camacho 138 10 piso
Col.Lomas de Chapultepec, Mexico, D.F. 11000
TEL: 55-9178-4270

先鋒股份有限公司

總公司：台北市中山北路二段44號13樓
電話：(02) 2521-3588

先鋒電子（香港）有限公司

香港九龍尖沙咀海港城世界商業中心
9樓901-6室
電話：(0852) 2848-6488

Published by Pioneer Corporation.
Copyright © 2007 by Pioneer Corporation.
All rights reserved.

Free Manuals Download Website

<http://myh66.com>

<http://usermanuals.us>

<http://www.somanuals.com>

<http://www.4manuals.cc>

<http://www.manual-lib.com>

<http://www.404manual.com>

<http://www.luxmanual.com>

<http://aubethermostatmanual.com>

Golf course search by state

<http://golfingnear.com>

Email search by domain

<http://emailbydomain.com>

Auto manuals search

<http://auto.somanuals.com>

TV manuals search

<http://tv.somanuals.com>