

Multi-CD control High power cassette player with RDS tuner

Operation Manual

**KEH-P5010R
KEH-P4013R
KEH-P4010R
KEH-P4010RB**

Pioneer

ENGLISH

Contents

Installation	3	Using the Cassette Player	13
Installation with the rubber bush	3	• Repeat Play	
Removing the Unit	3	• Blank Skip	
Connecting the Units	4	• Radio Intercept	
Key Finder	6	Using Multi-CD Players	14
• Head Unit	6	• Repeat Play	
• Steering Remote Controller (CD-SR80)	6	• Random Play	
Before Using This Product	6	• Scan Play	
About This Product	6	• Pause	
About This Manual	6	Audio Adjustment	15
Precaution	6	Selecting the Equalizer Curve	15
In Case of Trouble	6	Entering the Audio Menu	15
When using the 50-Disc Type		Audio Menu Functions	15
Multi-CD Player	6	• Balance Adjustment (FAD)	
Basic Operation	7	• Equalizer Curve Adjustment	
To Listen to Music	7	• EQ-L/EQ-M/EQ-H	
Basic Operation of Tuner	7	• Loudness Adjustment (LOUD)	
• Manual and Seek Tuning		• Front Image Enhancer Function (FIE)	
• Preset Tuning		• Source Level Adjustment (SLA)	
• Band		Detaching and Replacing the	
Basic Operation of Cassette Player	8	Front Panel	17
• Fast Forward/Rewind and Music Search		Theft Protection	17
• Eject		• Detaching the Front Panel	
• Cassette Loading Slot		• Replacing the Front Panel	
• Direction Change		Initial Setting	17
Basic Operation of Multi-CD Player	8	Entering the Initial Setting Menu	17
• Track Search and Fast Forward/Reverse		Initial Setting Menu Functions	18
• Disc Search		• Changing the FM Tuning Step (STEP)	
• Disc Number Search		• Switching the Auto PI Seek (A-PI)	
(for 6-Disc, 12-Disc types)		• Switching the AUX Mode (AUX)	
Tuner Operation	9	Other Functions	18
• Local Seek Tuning		Using the AUX Source	18
• Best Stations Memory (BSM)		• Selecting the AUX Source	
Using RDS Functions	9	Cellular Telephone Muting	18
What is RDS?	9	Cassette Player and Care	19
Program Service Name Display	9	Precaution	19
AF Function	10	• About the Cassette Player	
• Activating/Deactivating the AF Function		• About Cassette Tapes	
PI Seek Function	10	Cleaning the Head	19
• PI Seek		Specifications	19
• Auto PI Seek (for preset station)			
Regional Function	10		
• Activating/Deactivating the REG Function			
TA Function	11		
• Activating/Deactivating the TA Function			
• Canceling Traffic Announcements			
• Adjusting the TA Volume			
• TP Alarm Function			
PTY Function	12		
• PTY Search Setting Function			
• PTY Search Function			
• PTY Alarm			
• Canceling Emergency Announcements			

Installation

Note:

- Before finally installing the unit, connect the wiring temporarily, making sure it is all connected up properly, and the unit and the system work properly.
- Use only the parts included with the unit to ensure proper installation. The use of unauthorized parts can cause malfunctions.
- Consult with your nearest dealer if installation requires the drilling of holes or other modifications of the vehicle.
- Install the unit where it does not get in the driver's way and cannot injure the passenger if there is a sudden stop, like an emergency stop.
- If installation angle exceeds 30° from horizontal, the unit might not give its optimum performance.

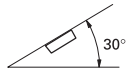

Installation with the rubber bush

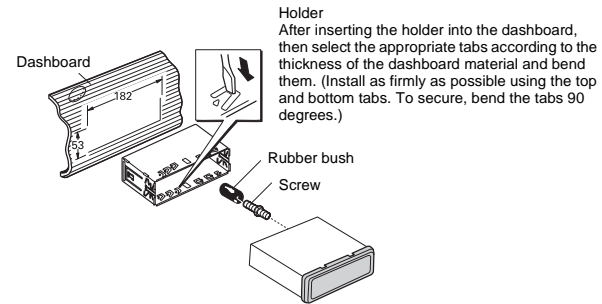

Removing the Unit

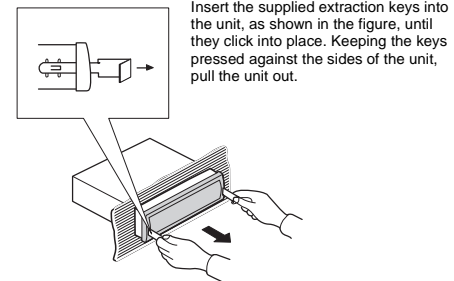

ENGLISH

3

Connecting the Units

Note:

- This unit is for vehicles with a 12-volt battery and negative grounding. Before installing it in a recreational vehicle, truck, or bus, check the battery voltage.
- To avoid shorts in the electrical system, be sure to disconnect the ⊖ battery cable before beginning installation.
- Refer to the owner's manual for details on connecting the power amp and other units, then make connections correctly.
- Secure the wiring with cable clamps or adhesive tape. To protect the wiring, wrap adhesive tape around them where they lie against metal parts.
- Route and secure all wiring so it cannot touch any moving parts, such as the gear shift, handbrake, and seat rails. Do not route wiring in places that get hot, such as near the heater outlet. If the insulation of the wiring melts or gets torn, there is a danger of the wiring short-circuiting to the vehicle body.
- Don't pass the yellow lead through a hole into the engine compartment to connect to the battery. This will damage the lead insulation and cause a very dangerous short.
- Do not shorten any leads. If you do, the protection circuit may fail to work when it should.
- Never feed power to other equipment by cutting the insulation of the power supply lead of the unit and tapping into the lead. The current capacity of the lead will be exceeded, causing overheating.
- When replacing fuse, be sure to use only fuse of the rating prescribed on this unit.
- Since a unique BPTL circuit is employed, never wire so the speaker leads are directly grounded or the left and right ⊖ speaker leads are common.
- Speakers connected to this unit must be high-power types with minimum rating of 45 W (50 W)* and impedance of 4 to 8 ohms. Connecting speakers with output and/or impedance values other than those noted here may result in the speakers catching fire, emitting smoke, or becoming damaged.

*KEH-P5010R

- When this product's source is switched ON, a control signal is output through the blue/white lead. Connect to an external power amp's system remote control or the car's Auto-antenna relay control terminal (max. 300 mA 12 V DC). If the car features a glass antenna, connect to the antenna booster power supply terminal.
- When an external power amp is being used with this system, be sure not to connect the blue/white lead to the amp's power terminal. Likewise, do not connect the blue/white lead to the power terminal of the auto-antenna. Such connection could cause excessive current drain and malfunction.
- To avoid short-circuiting, cover the disconnected lead with insulating tape. Especially, insulate the unused speaker leads without fail. There is a possibility of short-circuiting if the leads are not insulated.
- To prevent incorrect connection, the input side of the IP-BUS connector is blue, and the output side is black. Connect the connectors of the same colors correctly.
- If this unit is installed in a vehicle that does not have an ACC (accessory) position on the ignition switch, the red lead of the unit should be connected to a terminal coupled with ignition switch ON/OFF operations. If this is not done, the vehicle battery may be drained when you are away from the vehicle for several hours.



ACC position



No ACC position

- The black lead is ground. Please ground this lead separately from the ground of high-current products such as power amps. If you ground the products together and the ground becomes detached, there is a risk of damage to the products or fire.

- Cords for this product and those for other products may be different colors even if they have the same function. When connecting this product to another product, refer to the supplied Installation manuals of both products and connect cords that have the same function.

Connecting the Units

This product conforms to new cord colors.

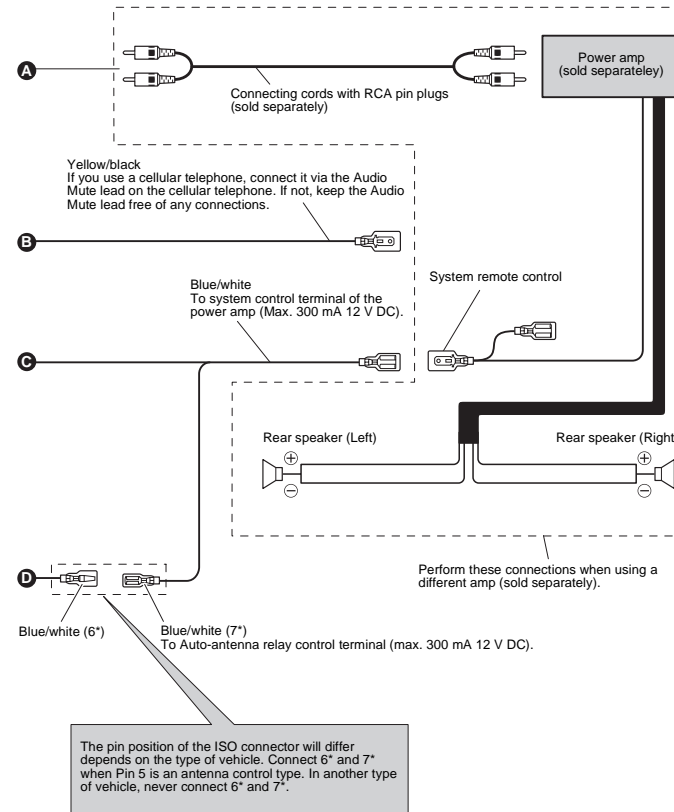
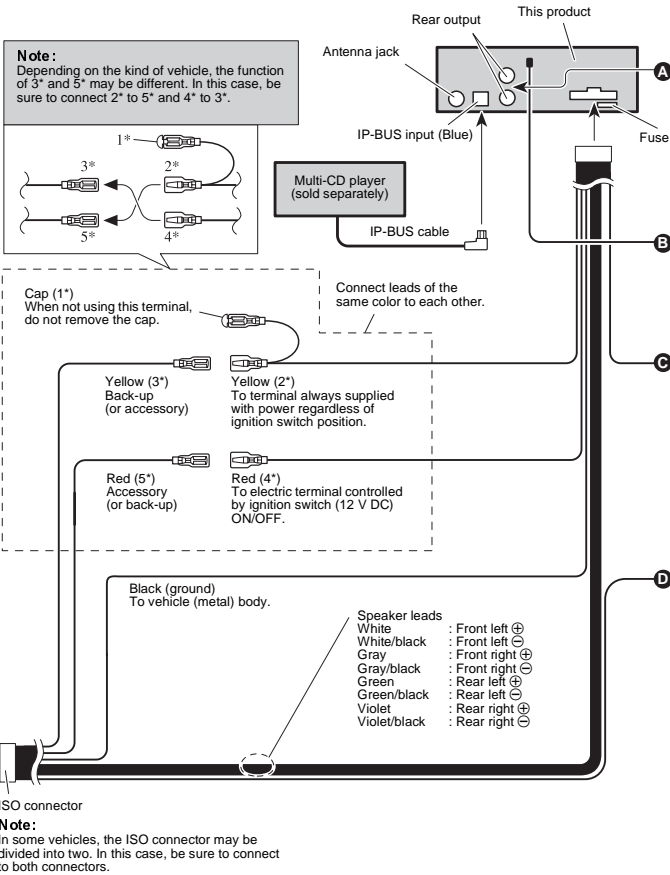

ENGLISH

Key Finder

Head Unit

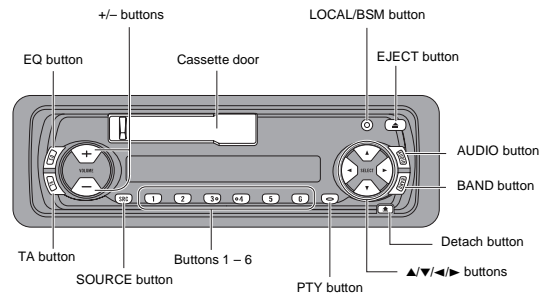

Steering Remote Controller (CD-SR80)

The steering remote controller (CD-SR80) is an option only for KEH-P5010R.

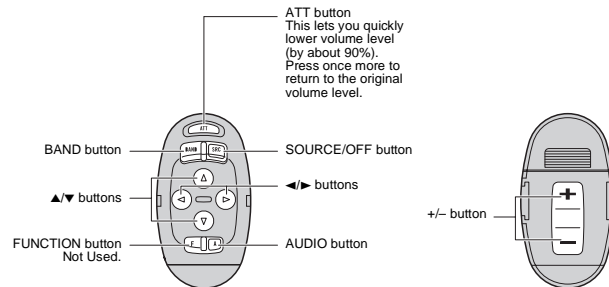

Before Using This Product

About This Product

- This product complies with the EMC Directives (89/336/EEC, 92/31/EEC) and CE Marking Directive (93/68/EEC).

The tuner frequencies on this product are allocated for use in Western Europe, Asia, the Middle East, Africa and Oceania. Use in other areas may result in improper reception. The RDS function operates only in areas with FM stations broadcasting RDS signals.

About This Manual

This product features a number of sophisticated functions ensuring superior reception and operation. All are designed for the easiest possible use, but many are not self-explanatory. This operation manual is intended to help you benefit fully from their potential and to maximize your listening enjoyment.

We recommend that you familiarize yourself with the functions and their operation by reading through the manual before you begin using this product. It is especially important that you read and observe the "Precaution" on this page and in other sections.

This manual explains head unit operation. You can perform the same operations with the steering remote controller when operating KEH-P5010R.

Precaution

- The Pioneer CarStereo-Pass is for use only in Germany.
- Keep this manual handy as a reference for operating procedures and precautions.
- Always keep the volume low enough for outside sounds to be audible.
- Protect this product from moisture.
- If the battery is disconnected, the preset memory will be erased and must be reprogrammed.

In Case of Trouble

Should this product fail to operate properly, contact your dealer or nearest authorized Pioneer Service Station.

When using the 50-Disc Type Multi-CD Player

The available functions of the 50-Disc Type Multi-CD Player are described in this Operation Manual. Note that other 50-Disc Type Multi-CD Player functions cannot be used with this product.

Basic Operation

To Listen to Music

The following explains the initial operations required before you can listen to music.

Note:

- Loading a cassette in this product. (Refer to page 8.)

1. Select the desired source (e.g. Tuner).

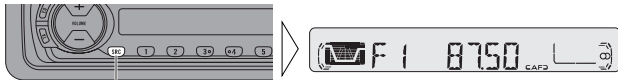

Each press changes the Source ...

Each press of the SOURCE button selects the desired source in the following order:
Tuner → Tape → Multi-CD player → External Unit → AUX

Note:

- External Unit refers to a Pioneer product (such as one available in the future) that, although incompatible as a source, enables control of basic functions by this product. Only one External Unit can be controlled by this product.
- In the following cases, the sound source will not change:
 - * When a product corresponding to each source is not connected to this product.
 - * When no tape is set in this product.
 - * When no magazine is set in the Multi-CD player.
 - * When the AUX (external input) is set to OFF. (Refer to page 18.)
- When this product's blue/white lead is connected to the car's Auto-antenna relay control terminal, the car's Auto-antenna extends when this product's source is switched ON. To retract the antenna, switch the source OFF.

2. Raise or lower the volume.

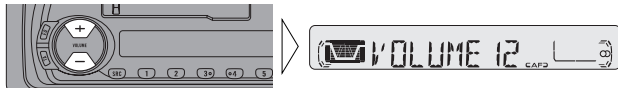

3. Turn the source OFF.

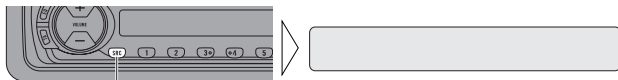

Hold for 1 second

Basic Operation of Tuner

This product's AF function can be switched ON and OFF. AF should be switched OFF for normal tuning operations. (Refer to page 10.)

Manual and Seek Tuning

- You can select the tuning method by changing the length of time you press the ◀/▶ button.

Manual Tuning (step by step)	0.5 seconds or less
Seek Tuning	0.5 seconds or more

Note:

- If you continue pressing the button for longer than 0.5 seconds, you can skip broadcast stations. Seek Tuning starts as soon as you release the button.
- Stereo indicator "S" lights when a stereo station is selected.

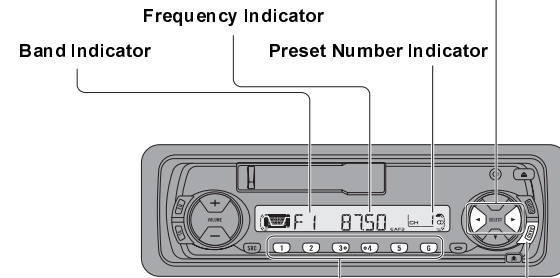

Preset Tuning

- You can memorize broadcast stations in buttons 1 through 6 for easy, one-touch station recall.

Preset station recall	2 seconds or less
Broadcast station preset memory	2 seconds or more

Note:

- Up to 12 FM stations (6 each in F1 (FM1) and F2 (FM2)) and 6 MW/LW stations can be stored in memory.
- You can also use the ▲ or ▼ buttons to recall broadcast stations memorized in buttons 1 through 6.

Band

- F1 (FM1)
- F2 (FM2)
- MW/LW

ENGLISH

Basic Operation

Basic Operation of Cassette Player

Fast Forward/Rewind and Music Search

- Each press of the ► button selects Fast Forward or Forward-Music Search.
FF (Fast Forward) → F-MS (Forward-Music Search) → Normal Playback
- Each press of the ◀ button selects Rewind or Rewind-Music Search.
REW (Rewind) → R-MS (Rewind-Music Search) → Normal Playback

Note:

- Fast Forward/Rewind and Music Search can be canceled by pressing the BAND button.

Eject

Note:

- The Tape function can be turned ON/OFF with the cassette tape remaining in this product. (Refer to page 7.)

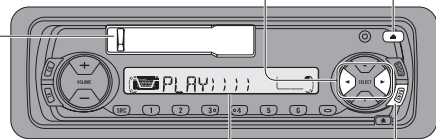

Direction Indicator

Direction Change

Cassette Loading Slot

Note:

- Don't insert any materials except for cassette into Cassette Loading Slot.

Basic Operation of Multi-CD Player

This product can control a Multi-CD player (sold separately).

Track Search and Fast Forward/Reverse

- You can select between Track Search or Fast Forward/Reverse by pressing the ◀/► button for a different length of time.

Track Search	0.5 seconds or less
Fast Forward/Reverse	Continue pressing

Note:

- Multi-CD indicator "Ⓢ" lights when a Multi-CD source is selected.

Track Number Indicator Disc Number Indicator
Play Time Indicator Disc Search

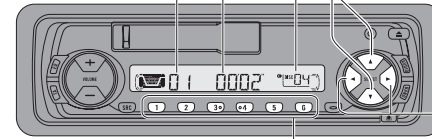

Disc Number Search (for 6-Disc, 12-Disc types)

- You can select discs directly with the 1 to 6 buttons. Just press the number corresponding to the disc you want to listen to.

Note:

- When a 12-Disc Multi-CD Player is connected and you want to select disc 7 to 12, press the 1 to 6 buttons for 2 seconds.

Note:

- The Multi-CD Player may perform a preparatory operation, such as verifying the presence of a disc or reading disc information, when the power is turned ON or a new disc is selected for playback. "READY" is displayed.
- If the Multi-CD Player cannot operate properly, an error message such as "ERROR-14" is displayed. Refer to the Multi-CD Player owner's manual.
- If there are no discs in the Multi-CD Player magazine, "NO DISC" is displayed.

Tuner Operation

Local Seek Tuning

This function selects only stations with especially strong signals.

- Switch the Local ON/OFF with the LOCAL/BSM button.

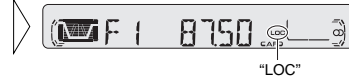

Best Stations Memory (BSM)

The BSM function stores stations in memory automatically.

- Press the LOCAL/BSM button for 2 seconds to switch BSM ON.

The stations with the strongest signals will be stored under buttons 1–6 and in order of their signal strength.



- To cancel the process, press the LOCAL/BSM button before memorization is complete.

Using RDS Functions

What is RDS?

RDS (Radio Data System) is a system for transmitting data along with FM programs. This data, which is inaudible, provides a variety of features such as: program service name, program type display, traffic announcement standby, automatic tuning and program type tuning, intended to aid radio listeners in tuning to a desired station.

Note:

- RDS service may not be provided by all stations.
- RDS functions, like AF (Alternative frequencies search) and TA (Traffic Announcement standby), are only active when your radio is tuned to RDS stations.

Program Service Name Display

With this function, the names of networks/stations providing RDS services replace the frequency on the display a few seconds after they are tuned in.

- When you want to know PTY Information or the frequency of the current station, change the display.

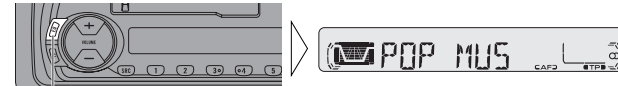

Hold for 2 seconds

Each press of the DISPLAY button for 2 seconds selects the display in the following order:

Program Service Name → PTY Information → Frequency

Note:

- After switching displays, if you do not perform an operation within 8 seconds, the Program Service Name is automatically displayed.

■ PTY Information

PTY (Program Type ID code) information for the currently tuned station appears on the display for 8 seconds. The information is correlated with the list in the section "PTY Function" on page 12.

Note:

- If a PTY code of zero is received from a station, "NONE" will be displayed. This indicates that the station has not defined its program contents.
- If the signal is too weak for this product to pick up the PTY code, "NO PTY" will be displayed.

■ Frequency

The frequency of the current station appears on the display.

Using RDS Functions

AF Function

The AF (Alternative Frequencies search) function is used to search for other frequencies in the same network as the currently tuned station. It automatically retunes the receiver to another frequency in the network which is broadcasting a stronger signal when there are problems with reception of the currently tuned station or better reception is possible on a different frequency.

Note:

- AF tunes the receiver only to RDS stations when you use Seek tuning or BSM Auto Memory with the "AF" indicator ON.
- When you recall a preset station, the tuner may update the preset station with a new frequency from the station's AF list. (This is only available when using presets on the FM1 band.) No preset number appears on the display if the RDS data for the station received differs from that for the originally stored station.
- Sound may be temporarily interrupted by another program during an AF frequency search.
- When the tuner is tuned to a non-RDS station, the "AF" indicator flashes.
- AF can be switched ON or OFF independently for each FM band.

Activating/Deactivating the AF Function

AF is set to ON by default.

- **Turn AF to OFF.**

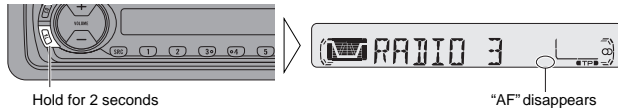

Hold for 2 seconds

"AF" disappears

To turn AF back ON, repeat the preceding operation.

PI Seek Function

The tuner searches for another frequency broadcasting the same programming. "PI SEEK" appears on the display and the radio volume is muted during a PI Seek. The muting is discontinued after completion of the PI Seek, whether or not the PI seek has succeeded. If the PI Seek is unsuccessful, the tuner returns to the previous frequency.

PI Seek

If the tuner fails to locate a suitable alternative frequency or if the broadcasting signal is too weak for proper reception, the PI Seek will automatically start.

Auto PI Seek (for preset station)

When preset stations cannot be recalled, as when traveling long distances, this product can be set to perform PI Seek also during preset recall.

The default setting for Auto PI Seek is OFF.

Note:

- Refer to "Initial Setting" for details on how to switch Auto PI Seek ON/OFF.

Regional Function

When AF is used to retune the tuner automatically, REG (regional) limits the selection to stations broadcasting regional programs.

Note:

- Regional programming and regional networks are organized differently depending on the country (i.e., they may change according to the hour, state or broadcast area).
- The preset number may disappear on the display if the tuner tunes in a regional station which differs from the originally set station.
- REG can be switched ON or OFF independently for each FM band.

Activating/Deactivating the REG Function

The REG function is set to ON by default.

- **Turn REG to OFF.**

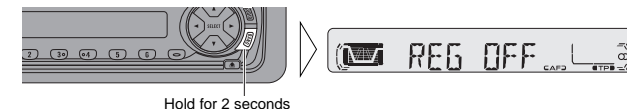

Hold for 2 seconds

To turn REG back ON, repeat the preceding operation.

Using RDS Functions

TA Function

The TA (Traffic Announcement standby) function lets you receive traffic announcements automatically, no matter what source you are listening to. The TA function can be activated for either a TP station (a station that broadcasts traffic information) or an enhanced other network's TP station (a station carrying information which cross-references TP stations).

Activating/Deactivating the TA Function

1. Tune in a TP or EON TP station.

The "TP" indicator lights when the tuner is tuned to a TP station or an enhanced other network's TP station.

2. Activate the TA function.

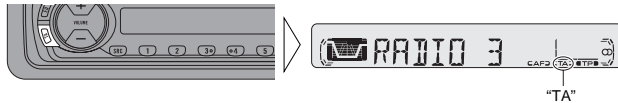

The "TA" indicator lights, indicating that the tuner is waiting for traffic announcements. Repeat the preceding operation when no traffic announcement is being received to deactivate the TA function.

Note:

- The system switches back to the original source following traffic announcement reception.
- The TA function can be activated from sources other than tuner if the tuner was last set to the FM band but not if it was last set to the MW/LW band.
- If the tuner was last set to FM, turning on the TA function lets you operate other tuning functions while listening to sources other than tuner.
- Only TP or EON TP stations are tuned in during the Seek Tuning mode when the "TA" indicator is ON.
- Only TP or EON TP stations are stored by BSM when the "TA" indicator is ON.

Canceling Traffic Announcements

- Press the TA button while a traffic announcement is being received to cancel the announcement and return to the original source.



The announcement is canceled but the tuner remains in the TA mode until the TA button is pressed again.

Adjusting the TA Volume

When a traffic announcement begins, the volume adjusts automatically to a preset level to enable you to hear the announcement clearly.

- Set the volume by adjusting it during reception of a traffic announcement.

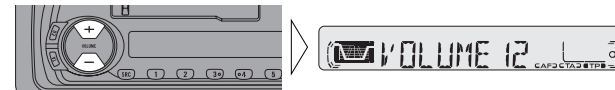

The newly set volume is stored in memory and recalled for subsequent traffic announcements.

TP Alarm Function

About 30 seconds after the "TP" indicator is extinguished due to a weak signal, a 5 second beep sounds to remind you to select another TP or EON TP station.

- If you are listening to the tuner, tune in another TP station or EON TP station.

In sources other than tuner, the tuner automatically seeks out the TP station with the strongest signal in the current area 10 (or 30)* seconds after "TP" disappears from the display.

*** Time taken before Seek begins.**

TA function ON	10 seconds
TA, AF functions ON	30 seconds

Using RDS Functions

PTY Function

The PTY function enables you to select stations by the type of programming they broadcast (PTY Search). It also provides automatic tuning to emergency broadcasts (PTY Alarm).

Note:

- PTY code program types are as follows:
 1. NEWS: News.
 2. AFFAIRS: Current affairs.
 3. INFO: General information and advice.
 4. SPORT: Sports programs.
 5. EDUCATE: Educational programs.
 6. DRAMA: All radio plays and serials.
 7. CULTURE: Programs concerned with any aspect of national or regional culture.
 8. SCIENCE: Programs about nature, science and technology.
 9. VARIED: Light entertainment programs.
 10. POP MUS: Popular music.
 11. ROCK MUS: Contemporary modern music.
 12. EASY MUS: Easy listening music.
 13. L. CLASS: Light classical music.
 14. CLASSIC: Serious classical music.
 15. OTH MUS: Other types of music, which can't be categorized.
 16. WEATHER: Weather reports/Meteorological information.
 17. FINANCE: Stock market reports, commerce, trading etc.
 18. CHILDREN: Children's programs.
 19. SOCIAL: Social affairs programs.
 20. RELIGION: Religion affairs programs or services.
 21. PHONE IN: Phone in based programs.
 22. TOURING: Travel programs, not for announcements about traffic problem.
 23. LEISURE: Programs about hobbies and recreational activities.
 24. JAZZ: Jazz music based programs.
 25. COUNTRY: Country music based programs.
 26. NAT MUS: National music based programs.
 27. OLDIES: Oldies music, 'Golden age' based programs.
 28. FOLK MUS: Folk music based programs.
 29. DOCUMENT: Documentary programs.

PTY Search Setting Function

1. Enter the PTY Search setting mode.



Hold for 2 seconds

The name of a program type appears on the display for 5 seconds.

Note:

- "CURRENT" sets desired PTY to the program type of the current station (only for RDS stations broadcasting PTY information).

2. Select one of the PTYs.



3. When the desired programming type appears on the display, return to the normal display.



Using RDS Functions

PTY Search Function

- Initiate a PTY search.

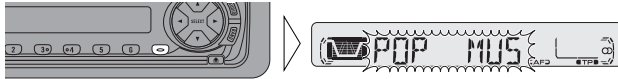

The tuner searches for a station broadcasting the desired PTY.

Note:

- The program of some stations may differ from that indicated by the transmitted PTY.
- If no station broadcasting the selected programming type is found, "NOTFOUND" is displayed for about 2 seconds, and the tuner returns to the original station.

PTY Alarm

PTY Alarm is a special PTY code for announcements regarding emergencies such as natural disasters. When the tuner receives the radio alarm code, "ALARM" appears on the display and the volume adjusts to the TA volume. When the station stops broadcasting the emergency announcement, the system returns to the previous source.



Note:

- The system switches back to the original source following emergency announcement reception.

Canceling Emergency Announcements

- Press the TA button during emergency announcement reception to cancel the announcement and return to the previous source.

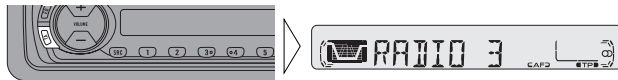

Using the Cassette Player

Repeat Play

The repeat mode lets you hear the same song over again.

- Switch the Repeat Play ON/OFF with the LOCAL/BSM button.



Blank Skip

This function fast-forwards to the next song automatically if there is a long period of silence (12 seconds or longer) between songs.

- Switch the Blank Skip ON/OFF with the button 5.



Radio Intercept

This function allows you to listen to the radio during tape fast-forwarding/rewinding.

Note:

- The radio intercept function does not work during a Music Search operation.

- Switch the Radio Intercept ON/OFF with the button 6.



Using Multi-CD Players

Repeat Play

There are three repeat play ranges: One-track Repeat, Disc Repeat and Multi-CD player Repeat. Default repeat play range is Multi-CD player Repeat.

- Select the desired repeat play range by pressing the LOCAL/BSM button.

Multi-CD player Repeat →
One-track Repeat → Disc Repeat



Indicator	Display	Play range
—	—	Multi-CD player Repeat
■	RPT	One-track Repeat
—	DISC	Disc Repeat

Note:

- If you select other discs during the repeat play, the repeat play range changes to Multi-CD player Repeat.
- If you perform Track Search or Fast Forward/Reverse during One-track Repeat, the repeat play range changes to Disc Repeat.

Random Play

Tracks are played at random within the selected repeat play range as explained in "Repeat Play" above.

- Press the LOCAL/BSM button for 2 seconds to switch the Random Play ON/OFF.

After selecting the desired repeat play range from those referred to in "Repeat Play" above, switch Multi-CD Player Random Play ON.



Display	Play range
DRDM	Disc Repeat
RDM	Multi-CD player Repeat

Note:

- One-track Repeat changes to the Disc Repeat when you switch the Random Play ON.

Scan Play

In the Disc Repeat, the beginning of each track on the selected disc is scanned for about 10 seconds. In the Multi-CD player Repeat, the beginning of the first track on each disc is scanned for about 10 seconds.

1. Press the PTY button for 2 seconds to switch the Scan Play ON.

After selecting the desired repeat play range from those referred to in "Repeat Play" on page 14, switch Multi-CD Player Scan Play ON.

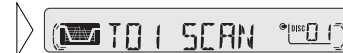

2. When you find the desired track (or disc), cancel the Scan Play by pressing the PTY button for 2 seconds.



Display	Play range
DSCN	Disc Repeat
SCAN	Multi-CD player Repeat

Note:

- Scan Play is canceled automatically after all the tracks or discs have been scanned.
- One-track Repeat changes to the Disc Repeat when you switch the Scan Play ON.

Pause

Pause pauses the currently playing track.

- Switch the Pause play ON/OFF with the LOCAL/BSM button.



Audio Adjustment

Selecting the Equalizer Curve

You can switch between Equalizer curves.

- Press the EQ button to select the desired Equalizer curve.

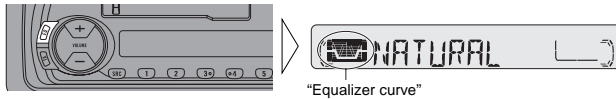

POWERFUL (powerful) → NATURAL (natural) → VOCAL (vocal)
→ CUSTOM (custom) → EQ FLAT (flat) → SPR-BASS (super bass)

Note:

- "CUSTOM" stores an equalizer curve you have made adjustments to. (Refer to "Equalizer Curve Adjustment" on page 15.)

Entering the Audio Menu

With this Menu, you can adjust the sound quality.

Note:

- After entering the Audio Menu, if you do not perform an operation within about 30 seconds, the Audio Menu is automatically canceled.

1. Select the desired mode in the Audio Menu.

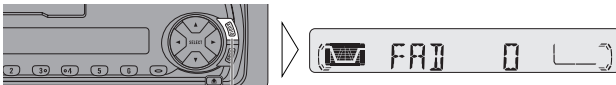

Each press changes the Mode ...

2. Operate a mode.
3. Cancel the Audio Menu.

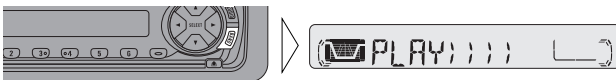

Audio Menu Functions

The Audio Menu features the following functions.

Balance Adjustment (FAD)

This function allows you to select a Fader/Balance setting that provides ideal listening conditions in all occupied seats.

1. Press the AUDIO button and select the Fader/Balance mode (FAD) in the Audio Menu.

2. Adjust front/rear speaker balance with the ▲/▼ buttons.

"FAD F15" – "FAD R15" is displayed as it moves from front to rear.



3. Adjust left/right speaker balance with the ◀/▶ buttons.

"BAL L 9" – "BAL R 9" is displayed as it moves from left to right.



Note:

- "FAD 0" is the proper setting when 2 speakers are in use.

Equalizer Curve Adjustment (EQ-L/EQ-M/EQ-H)

You can adjust the currently selected equalizer curve settings as desired. Adjusted equalizer curve settings are memorized in "CUSTOM".

1. Press the AUDIO button and select the Equalizer mode (EQ-L/EQ-M/EQ-H) in the Audio Menu.

2. Select the band you want to adjust with the ◀/▶ buttons.

EQ-L (low) ↔ EQ-M (mid)
↔ EQ-H (high)



3. Boost or attenuate the selected band with the ▲/▼ buttons.

The display shows "+6" – "-6".



"CUSTOM"

Note:

- If you make adjustments when a curve other than "CUSTOM" is selected, the newly adjusted curve will replace the previous adjusted curve. Then a new curve with "CUSTOM" appears on the display while selecting the equalizer curve. (Refer to page 15.)

Audio Adjustment

Loudness Adjustment (LOUD)

The Loudness function compensates for deficiencies in the low and high sound ranges at low volume. You can select a desired Loudness level.

1. Press the AUDIO button and select the Loudness mode (LOUD) in the Audio Menu.

2. Switch the Loudness function ON/OFF with the ▲/▼ buttons.



3. Select the desired level with the ◀/▶ buttons.

LOW (low) ↔ MID (mid)
↔ HI (high)



Front Image Enhancer Function (FIE)

The F.I.E. (Front Image Enhancer) function is a simple method of enhancing front imaging by cutting mid- and high-range frequency output from the rear speakers, limiting their output to low-range frequencies. You can select the frequency you want to cut.

• Precaution:

When the F.I.E. function is deactivated, the rear speakers output sound of all frequencies, not just bass sounds. Reduce the volume before disengaging F.I.E. to prevent a sudden increase in volume.

1. Press the AUDIO button and select the F.I.E. mode (FIE) in the Audio Menu.

2. Switch the F.I.E. function ON/OFF with the ▲/▼ buttons.



3. Select the desired frequency with the ◀/▶ buttons.

100 ↔ 160 ↔ 250 (Hz)



Note:

- After switching the F.I.E. function ON, select the Fader/Balance mode in the Audio Menu, and adjust front and rear speaker volume levels until they are balanced.
- Switch the F.I.E. function OFF when using a 2-speaker system.

Source Level Adjustment (SLA)

The SLA (Source Level Adjustment) function prevents radical leaps in volume level when switching between sources. Settings are based on the FM volume level, which remains unchanged.

1. Compare the FM volume with the volume of the other source. (e.g. Cassette player)

2. Press the AUDIO button and select the SLA mode (SLA) in the Audio Menu.

3. Increase or decrease the level with the ▲/▼ buttons.

The display shows "+4" – "-4".



Note:

- Since the FM volume is the control, SLA is not possible in the FM modes.
- The MW/LW volume level, which is different from the FM base setting volume level, can be adjusted similar to sources other than tuner.

Detaching and Replacing the Front Panel

Theft Protection

The front panel of the main body is detachable to discourage theft.

Detaching the Front Panel

1. Eject the front panel.



2. To remove the front panel, pull its right-hand side toward you.

Take care not to grip it tightly or drop it.

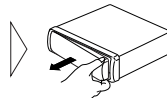

3. Use the protective case provided to store/carry the detached front panel.

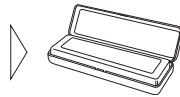

Replacing the Front Panel

- Replace the front panel by clipping it into place.

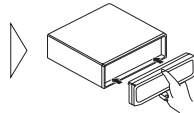

Precaution:

- Never use force or grip the display tightly when removing or replacing the front panel.
- Avoid subjecting the front panel to excessive shocks.
- Keep the front panel out of direct sunlight and high temperatures.

Initial Setting

Entering the Initial Setting Menu

With this menu, you can perform initial settings for this product.

1. Switch the source OFF.
2. Enter the Initial Setting Menu.



Hold for 2 seconds

3. Select a desired mode.



Each press changes the Mode ...

4. Operate a mode.
5. Cancel the Initial Setting Menu.



Note:

- Holding down the AUDIO button for 2 seconds also cancels the Initial Setting Menu.

Initial Setting

Initial Setting Menu Functions

The Initial Setting Menu features the following functions.

Changing the FM Tuning Step (STEP)

Normally set at 50 kHz during Seek tuning in the FM mode, the tuning step changes to 100 kHz when the AF or TA mode is activated.

It may be preferable to set tuning step to 50 kHz in the AF mode.

1. Press the AUDIO button and select the FM Tuning Step mode (STEP) in the Initial Setting Menu.
2. Select the desired tuning step with the ◀/▶ buttons.



Note:

- The tuning step remains set at 50 kHz during Manual tuning.
- The tuning step returns to 100 kHz if the battery is temporarily disconnected.

Switching the Auto PI Seek (A-PI)

During Preset Station PI Seek operation, you can switch the Auto PI Seek function ON/OFF. (Refer to "PI Seek Function" on page 10.)

1. Press the AUDIO button and select the Auto PI Seek mode (A-PI) in the Initial Setting Menu.
2. Switch the Auto PI Seek ON/OFF with the ▲/▼ buttons.



Switching the AUX Mode (AUX)

It is possible to use auxiliary (AUX) equipment with this product.

Activate the AUX mode when using external equipment with this product.

1. Press the AUDIO button and select the AUX Setting mode (AUX) in the Initial Setting Menu.
2. Switch the AUX ON/OFF with the ▲/▼ buttons.



Other Functions

Using the AUX Source

An IP-BUS-RCA Interconnector such as CD-RB20 or CD-RB10 (sold separately) enables you to connect this product to auxiliary equipment featuring an RCA output. For more details, refer to the IP-BUS-RCA Interconnector's Owner's Manual.

Selecting the AUX Source

- Select AUX. (Refer to page 7.)

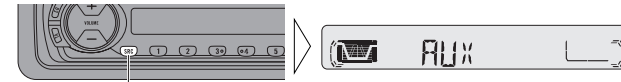

Each press changes the Mode ...

Cellular Telephone Muting

Sound from this system is muted automatically when a call is made or received using a cellular telephone connected to this product.

- The sound is turned off, "MUTE" is displayed and no audio adjustment is possible. Operation returns to normal when the phone connection is ended.



Cassette Player and Care

Precaution

About the Cassette Player

- A loose or warped label on a cassette tape may interfere with the eject mechanism of the unit or cause the cassette to become jammed in the unit. Avoid using such tapes or remove such labels from the cassette before attempting use.
- The music search and repeat functions may not work properly with the following kinds of recorded tapes because the gap between songs cannot be found correctly.
 - * A tape with a gap of 4 seconds or less between songs.
 - * A tape containing dialog, etc., with pauses lasting for 4 seconds or longer.
 - * A tape with an extremely quiet passage in the music lasting for 4 seconds or longer.

About Cassette Tapes

- Do not use tapes longer than C-90 type (90 min.) cassettes. Longer tapes can interfere with tape transport.
- Storing cassettes in areas directly exposed to sunlight or high temperatures can distort them and subsequently interfere with tape transport.



- Store unused tapes in a tape case where there is no danger of them becoming loose or being exposed to dust.

Cleaning the Head

If the head becomes dirty, the sound quality will deteriorate and there will be sound dropouts and other imperfections in performance. In this case, the head must be cleaned.

Specifications

General

Power source 14.4 V DC (10.8 – 15.1 V allowable)
 Grounding system Negative type
 Max. current consumption 8.5 A
 Dimensions
 (mounting size) ... 178 (W) x 50 (H) x 155 (D) mm
 (front face) 188 (W) x 58 (H) x 19 (D) mm
 Weight 1.2 kg

Amplifier

Maximum power output
 (KEH-P5010R) 50 W x 4
 (KEH-P4013R, KEH-P4010R, KEH-P4010RB) 45 W x 4
 Continuous power output
 (KEH-P5010R) 25 W x 4
 (KEH-P4013R, KEH-P4010R, KEH-P4010RB) 25 W x 4
 (DIN45324, +B = 14.4 V)

Load impedance 4 Ω (4 – 8 Ω allowable)
 Preout maximum output
 level/output impedance 2.2 V / 1 kΩ
 Equalizer (3 band equalizer)
 (Low) Level: ±12 dB
 (Mid) Level: ±12 dB
 (High) Level: ±12 dB
 Loudness contour
 (Low) +3.5 dB (100 Hz), +3 dB (10 kHz)
 (Mid) +10 dB (100 Hz), +6.5 dB (10 kHz)
 (High) +11 dB (100 Hz), +11 dB (10 kHz)
 (volume: -30 dB)

Cassette player

Tape Compact cassette tape (C-30 – C-90)
 Tape speed 4.8 cm/sec.
 Fast forward/rewinding time
 Approx. 100 sec. for C-60
 Wow & flutter 0.09% (WRMS)
 Frequency response 30 – 16,000 Hz (±3 dB)
 Stereo separation 45 dB
 Signal-to-noise ratio 61 dB (IEC-A network)

Cassette player

Tape Compact cassette tape (C-30 – C-90)
 Tape speed 4.8 cm/sec.
 Fast forward/rewinding time
 Approx. 100 sec. for C-60
 Wow & flutter 0.09% (WRMS)
 Frequency response 30 – 16,000 Hz (±3 dB)
 Stereo separation 45 dB
 Signal-to-noise ratio 61 dB (IEC-A network)

FM tuner

Frequency range 87.5 – 108 MHz
 Usable sensitivity 9 dBf
 (0.8 μV/75 Ω, mono, S/N: 30 dB)
 50 dB quieting sensitivity 15 dBf
 (1.5 μV/75 Ω, mono)
 Signal-to-noise ratio 70 dB (IEC-A network)
 Distortion 0.3% (at 65 dBf, 1 kHz, stereo)
 Frequency response 30 – 15,000 Hz (±3 dB)
 Stereo separation 40 dB (at 65 dBf, 1 kHz)

MW tuner

Frequency range 531 – 1,602 kHz (9 kHz)
 Usable sensitivity 18 μV (S/N: 20 dB)
 Selectivity 50 dB (±9 kHz)

LW tuner

Frequency range 153 – 281 kHz
 Usable sensitivity 30 μV (S/N: 20 dB)
 Selectivity 50 dB (±9 kHz)

Note:

- Specifications and the design are subject to possible modification without notice due to improvements.

MAN-KEH-P5010R-GB/B
Printed in Belgium

Published by Pioneer Corporation.
Copyright © 2000 by Pioneer Corporation.
All rights reserved.

PIONEER CORPORATION
4-1, MEGURO 1-CHOME, MEGURO-KU, TOKYO 153-8654, JAPAN

PIONEER ELECTRONICS (USA) INC.
P.O. Box 1760, Long Beach, California 90801, U.S.A.
TEL: (800) 421-1404

PIONEER EUROPE N.V.
Haven 1087 Kaaiberglaan 1, 9120 Melsele, Belgium
TEL: (0) 3570.05.11

PIONEER ELECTRONICS AUSTRALIA PTY. LTD.
178-184 Boundary Road, Braeside, Victoria 3195, Australia
TEL: (03) 9586-6300

PIONEER ELECTRONICS OF CANADA, INC.
300 Alstair Parkway, Markham, Ontario L3R 0P2, Canada
TEL: (905) 479-4411

PIONEER ELECTRONICS DE MEXICO, S.A. de C.V.
San Lorenzo Num 1009 3er piso Desp. 302
Col. Del Valle, Mexico D.F. C.P. 03100
TEL: 5-688-52-90



Free Manuals Download Website

<http://myh66.com>

<http://usermanuals.us>

<http://www.somanuals.com>

<http://www.4manuals.cc>

<http://www.manual-lib.com>

<http://www.404manual.com>

<http://www.luxmanual.com>

<http://aubethermostatmanual.com>

Golf course search by state

<http://golfingnear.com>

Email search by domain

<http://emailbydomain.com>

Auto manuals search

<http://auto.somanuals.com>

TV manuals search

<http://tv.somanuals.com>