

Pioneer *sound.vision.soul*

DVD/CD Receiver

XV-DV515

Speaker System

S-DV515

Wireless Speaker System

XW-DV515



Operating Instructions



CONGRATULATIONS ON YOUR PURCHASE OF THIS FINE PIONEER PRODUCT.

Pioneer is on the leading edge of DVD research for consumer products and this unit incorporates the latest technological developments.

We are sure you will be fully satisfied with this system.

Thank you for your support.

Location: underside of the unit

IMPORTANT



The lightning flash with arrowhead symbol, within an equilateral triangle, is intended to alert the user to the presence of uninsulated "dangerous voltage" within the product's enclosure that may be of sufficient magnitude to constitute a risk of electric shock to persons.

CAUTION

**RISK OF ELECTRIC SHOCK
DO NOT OPEN**

CAUTION: TO PREVENT THE RISK OF ELECTRIC SHOCK, DO NOT REMOVE COVER (OR BACK). NO USER-SERVICEABLE PARTS INSIDE. REFER SERVICING TO QUALIFIED SERVICE PERSONNEL.



The exclamation point within an equilateral triangle is intended to alert the user to the presence of important operating and maintenance (servicing) instructions in the literature accompanying the appliance.

H002_En

WARNING: THIS APPARATUS IS NOT WATERPROOF. TO PREVENT FIRE OR SHOCK HAZARD, DO NOT EXPOSE THIS APPARATUS TO RAIN OR MOISTURE AND DO NOT PUT ANY WATER SOURCE NEAR THIS APPARATUS, SUCH AS VASES, FLOWER POTS, COSMETICS CONTAINERS, MEDICINE BOTTLES, ETC.

WARNING: BEFORE PLUGGING IN THE UNIT FOR THE FIRST TIME, READ THE FOLLOWING SECTION CAREFULLY. THE VOLTAGE OF THE AVAILABLE POWER SUPPLY DIFFERS ACCORDING TO COUNTRY OR REGION. BE SURE THAT THE POWER SUPPLY VOLTAGE OF THE AREA WHERE THIS UNIT WILL BE USED MEETS THE REQUIRED VOLTAGE (E.G., 230V OR 120V) WRITTEN ON THE REAR PANEL.

H041A_En

European model only:

This product complies with the Low Voltage Directive (73/23/EEC, amended by 93/68/EEC), EMC Directives (89/336/EEC, amended by 92/31/EEC and 93/68/EEC).

H015AEn

CAUTION

This product contains a laser diode of higher class than 1. To ensure continued safety, do not remove any covers or attempt to gain access to the inside of the product. Refer all servicing to qualified personnel.

The following caution label appears on your unit.

Location: underside of the unit



H018A_En

WARNING: NO NAKED FLAME SOURCES, SUCH AS LIGHTED CANDLE, SHOULD BE PLACED ON THE APPARATUS. IF NAKED FLAME SOURCES ACCIDENTALLY FALL DOWN, FIRE SPREAD OVER THE APPARATUS THEN MAY CAUSE FIRE.

H044_En

Replacement and mounting of an AC plug on the power supply cord of this unit should be performed only by qualified service personnel.

IMPORTANT

FOR USE IN THE UNITED KINGDOM

The wires in this mains lead are coloured in accordance with the following code:

Blue : Neutral
Brown : Live

If the plug provided is unsuitable for your socket outlets, the plug must be cut off and a suitable plug fitted.

The cut-off plug should be disposed of and must not be inserted into any 13 amp socket as this can result in electric shock. The plug or adaptor or the distribution panel should be provided with 5 A fuse. As the colours of the wires in the mains lead of this appliance may not correspond with coloured markings identifying the terminals in your plug, proceed as follows:

The wire which is coloured blue must be connected to the terminal which is marked with the letter N or coloured black.

The wire which is coloured brown must be connected to the terminal which is marked with the letter L or coloured red.

Do not connect either wire to the earth terminal of a three pin plug.

NOTE

After replacing or changing a fuse, the fuse cover in the plug must be replaced with a fuse cover which corresponds to the colour of the insert in the base of the plug, and the word that is embossed on the base of the plug, and the appliance must not be used without a fuse cover. If lost replacement fuse covers can be obtained from: your dealer.

Only 5 A fuses approved by B.S.I. or A.S.T.A to B.S. 1362 should be used.

H005BEn

VENTILATION:

European, UK, Australian, New Zealand, Hong Kong and Taiwanese models:

When installing this unit, make sure to leave space around the unit for ventilation to improve heat radiation (at least 10 cm at top, 10 cm at rear, and 10 cm at each side).

All other models:

When installing this unit, make sure to leave space around the unit for ventilation to improve heat radiation (at least 20 cm at top, 15 cm at rear, and 15 cm at each side).

WARNING: Slots and openings in the cabinet are provided for ventilation and to ensure reliable operation of the product and to protect it from overheating, to prevent fire hazard, the openings should never be blocked and covered with items, such as newspapers, table-cloths, curtains, etc. Also do not put the apparatus on the thick carpet, bed, sofa, or fabric having a thick pile. H040 En

CAUTION: These speaker terminals can be under HAZARDOUS VOLTAGE. When you connect or disconnect the speaker cables, to prevent the risk of electric shock, do not touch uninsulated parts before disconnecting the power cord. H047 En

Australian model:



Energy-saving design

This system is designed to use 0.39 W of electricity when power is switched to standby.

CAUTION: THE STANDBY/ON BUTTON IS SECONDARY CONNECTED AND THEREFORE DOES NOT SEPARATE THE UNIT FROM MAINS POWER IN STANDBY POSITION. therefore install the unit suitable places easy to disconnect the MAINS plug in case of the accident. The MAINS plug of unit should be unplugged from the wall socket when left unused for a long period of time. H017B_En

Operating Environment H045_En

Operating environment temperature and humidity:

+5°C – +35°C (+41°F – +95°F); less than 85%RH (cooling vents not blocked)

Do not install in the following locations

- Location exposed to direct sunlight or strong artificial light
- Location exposed to high humidity, or poorly ventilated location

Thank you for buying this Pioneer product.

Please read through these operating instructions so that you will know how to operate your model properly. After you have finished reading the instructions, put them in a safe place for future reference.

Contents

01 Before you start

Features	7
Introduction to home theater	8
General disc compatibility	8
CD-R/RW compatibility	9
DVD-R/RW compatibility	9
PC-created disc compatibility	9
About WMA	9
Compressed audio compatibility	10
JPEG file compatibility	10

02 Controls and displays

Front panel	11
Display	12
Remote control	14
Wireless speaker system	17

03 Getting started

Switching on and setting up	19
Setting the clock	20
Setting up the remote to control your TV	21
Using the Room Setup	21
Using the on-screen displays	22
Playing discs	23
Basic playback controls	24
Resume and Last Memory	25
DVD-Video disc menus	26
Video CD/Super VCD PBC menus	27
Listening to the radio	28
Improving poor FM reception	29
Memorizing stations	29
Listening to station presets	30
Listening to other sources	30

04 Home theater sound

Auto listening mode	31
Listening in surround sound	31
Dolby Pro Logic II Music settings	32
Listening in stereo	32
Listening with headphones	32
Using the Advanced Surround effects	33
Adjusting the Advanced Surround effect level	33
Enhancing dialogue	34
Listening with a virtual surround back speaker	34
Using Quiet and Midnight listening modes	34
Adjusting the bass and treble	35
Boosting the bass level	35
Muting the sound	36
Using the wireless surround speaker	36

05 Playing discs

Introduction	37
Using the Disc Navigator to browse the contents of a disc	37
Scanning discs	38
Playing in slow motion	38
Frame advance/frame reverse	39
Looping a section of a disc	39
Using repeat play	40
Using the OSD	40
Using the front panel display	41
Using random play	41
Using the OSD	41
Creating a program list	42
Using the OSD	42
Using the front panel display	44
Clearing the program list	45
Searching a disc	45
Switching subtitles	46

Switching the DVD audio language	46
Switching VR format DVD-RW audio channel	46
Switching the Video CD/Super VCD audio channel	46
Zooming the screen	47
Switching camera angles	47
Displaying disc information	47
OSD disc information	47
Front panel display information	48

06 Viewing JPEG discs

Playing a JPEG slideshow	50
Using the JPEG Disc Navigator and Photo Browser	50
Zooming the screen	51

07 More tuner features: RDS

European model only

An introduction to RDS	52
Displaying RDS information	53
Searching for RDS programs	53

08 Using the timer

Setting the wake-up timer	54
Turning the wake-up timer on/off	55
Setting the sleep timer	55

09 Surround sound setup

Setting up surround sound	57
System Setup menu options	57
Setting the channel levels	59

10 Video Adjust menu

Video Adjust	60
Creating your own presets	60

11 Initial Settings menu

Using the Initial Settings menu	62
Video Output settings	62
TV Screen	62
AV Connector Out <i>(European model only)</i>	62
Component Out <i>(Not Applicable to the European model)</i>	63
S-Video Out <i>(Not Applicable to the European model)</i>	64

Language settings	64
Audio Language	64
Subtitle Language	65
DVD Menu Language	65
Subtitle Display	66
Display settings	66
OSD Language	66
On Screen Display	66
Angle Indicator	66
Options	66
Parental Lock	66
PhotoViewer	69

12 Other connections

Connecting the wireless speaker system	70
Connecting external antennas	70
Connecting auxiliary components	71
Reducing the TV and line signal levels	72
Recording mode	72
Connecting using the S-video output <i>(Not Applicable to the European model)</i>	72
Connecting using the component video output <i>(Not Applicable to the European model)</i>	73
Using the SCART AV output <i>(European model only)</i>	73
Switching the TV audio input from SCART to RCA	74

13 Additional information

Switching off the demo	75
Child Lock	75
Changing the clock format	75
Setting the TV format	75
Watching NTSC on a PAL TV <i>(MOD. PAL)</i>	76
Changing the frequency step <i>(Not Applicable to the European model)</i>	76
Resetting the system	76
Using and taking care of discs	76
Titles, chapters and tracks	76
DVD Video regions	77
Handling discs	77
Storing discs	77
Discs to avoid	78

Proper installation and maintenance of this system	78	Screen sizes and disc formats	84
Hints on installation	78	Widescreen TV users	84
Cleaning the pickup lens	78	Standard TV users	84
Problems with condensation	79	Selecting languages using the language code list	84
Moving the system unit	79	Language code list	85
Power cord caution	79	Country code list	85
Wireless speaker system AC adaptor and power cord caution	79	Preset code list	86
Troubleshooting	80	Glossary	88
General	80	Specifications	91
DVD/CD/Video CD player	81	Amplifier section	91
WMA/MP3/JPEG discs	82	Disc section	91
Tuner	83	FM tuner section	91
Error Messages	83	AM tuner section	91
		Miscellaneous	91
		Accessories (DVD/CD receiver)	91
		Speaker System	91
		Digital wireless speaker system	92

Chapter 1

Before you start

Features

24-bit/96kHz compatible DAC

This system is fully compatible with high sampling-rate discs, capable of delivering better-than-CD sound quality in terms of dynamic range, low-level resolution and high-frequency detail.

Excellent audio performance with Dolby Digital, Dolby Pro Logic, Dolby Pro Logic II*¹ and DTS*² software



Built-in Dolby Digital and DTS decoders let you enjoy true discrete multi-channel home theater sound with Dolby Digital and DTS encoded DVD discs.

Dolby Pro Logic and Dolby Pro Logic II decoding adds excitement to two-channel source material with surround sound playback.

Picture zoom

While a DVD or Video CD/Super VCD is playing, you can zoom in on any part of the picture at up to 4x magnification for a closer look. See *Zooming the screen* on page 47.

PureCinema progressive scan

Not applicable to the European model

When connected to a progressive scan-compatible TV or monitor using the component video outputs, you can enjoy extremely stable, flicker free images, with the same frame refresh rate as the original movie.

MP3 and WMA compatibility

This system is compatible with CD-R, CD-RW and CD-ROM discs that contain MP3 or WMA audio tracks. See also *Compressed audio compatibility* on page 10.

Graphical on-screen displays

Setting up and using your DVD home theater system is made very easy using the graphical on-screen displays.

Wireless speaker system

The XW-DV515 wireless speaker system can be used for multi-channel sound with your main setup, or as a second stereo speaker system.

Energy saving design

This unit is designed to use 0.39 W of power when in standby mode.

*1 *Manufactured under license from Dolby Laboratories. "Dolby", "Pro Logic" and the double-D symbol are trademarks of Dolby Laboratories.*

*2 *"DTS" and "DTS Digital Surround" are registered trademarks of Digital Theater Systems, Inc.*

Introduction to home theater

You are probably used to using stereo equipment to listen to music, but may not be used to home theater systems that give you many more options (such as surround sound) when listening to soundtracks.

Home theater refers to the use of multiple audio tracks to create a surround sound effect, making you feel like you're in the middle of the action or concert. The surround sound you get from a home theater system depends not only on the speakers you have set up in your room, but also on the source and the sound settings of the system.

DVD-Video has become the basic source material for home theater due to its size, quality, and ease of use. Depending on the DVD, you can have up to seven different audio tracks coming from one disc, all of them being sent to different speakers in your system. This is what creates a surround sound effect and gives you the feeling of 'being there'.

This system will automatically decode Dolby Digital, DTS, or Dolby Surround DVD-Video discs, according to your speaker setup. In most cases, you won't have to make changes for realistic surround sound, but other possibilities (like listening to a CD with multi-channel surround sound) are explained in *Home theater sound* on page 31.

General disc compatibility

This system was designed and engineered to be compatible with software bearing one or more of the following logos:



- KODAK Picture CD
-  is a trademark of Fuji Photo Film Co. Ltd.

This player supports the IEC's Super VCD standard. Compared to the Video CD standard, Super VCD offers superior picture quality, and allows two stereo soundtracks to be recorded. Super VCD also supports the widescreen size.



Other formats, including but not limited to the following, are not playable in this system:

**DVD-Audio / SACD / DVD-RAM
DVD-ROM / CD-ROM***

- * *Except those that contain MP3, WMA or JPEG. See also Compressed audio compatibility and JPEG file compatibility below.*

Before you start

DVD-R/RW and CD-R/RW discs (Audio CDs and Video CD/Super VCDs) recorded using a DVD recorder, CD recorder or personal computer may not be playable on this system. This may be caused by a number of possibilities, including but not limited to: the type of disc used; the type of recording; damage, dirt or condensation on either the disc or the player's pick-up lens. See below for notes about particular software and formats.

CD-R/RW compatibility

- This system will play CD-R and CD-RW discs recorded in CD Audio or Video CD/Super VCD format, or as a CD-ROM containing MP3, WMA or JPEG files. However, any other content may cause the disc not to play, or create noise/distortion in the output.
- This system cannot record CD-R or CD-RW discs.
- Unfinalized CD-R/RW discs recorded as CD Audio can be played, but the full Table of Contents (playing time, etc.) will not be displayed.

DVD-R/RW compatibility

- This unit will play DVD-R/RW discs recorded using the DVD-Video format that have been finalized using a DVD-recorder.
- This unit will play DVD-RW discs recorded using the Video Recording (VR) format.
- **DVD-RW** shows in the display when a VR format DVD-RW disc is loading.
- When playing a VR format DVD-RW discs that was edited on a DVD recorder, the screen may go momentarily black at edited points and/or you may see scenes from immediately before the edited point.
- This unit cannot record DVD-R/RW discs.
- Unfinalized DVD-R/RW discs cannot be played in this player.

PC-created disc compatibility

- If you record a disc using a personal computer, even if it is recorded in a "compatible format" as listed above, there will be cases in which the disc may not be playable in this machine due to the setting of the application software used to create the disc. In these particular instances, check with the software publisher for more detailed information.
- Check the DVD-R/RW or CD-R/RW software disc boxes for additional compatibility information.

About WMA



The Windows Media™ logo printed on the box indicates that this player can playback WMA data.

WMA is short for Windows Media Audio and refers to an audio compression technology developed by Microsoft Corporation. WMA data can be encoded by using Windows Media Player version 8 (or less) or Windows Media Player for Windows XP.

Windows Media, and the Windows logo are trademarks, or registered trademarks of Microsoft Corporation in the United States and/or other countries.

Compressed audio compatibility

- This unit will play CD-ROM, CD-R, and CD-RW discs containing files saved in the MPEG-1 Audio Layer 3 (MP3) or Windows Media Audio (WMA) format with a sampling rate of 32, 44.1 or 48kHz (except 32 kHz WMA files encoded at 20 kbps). Incompatible files will not play and the message **Can't play this format** will be displayed (**No Play** in the front panel display).
- Fixed bit-rate files are recommended. Variable bit-rate (VBR) MP3 files are playable, but playing time may not be shown correctly.
- This player is compatible with WMA data encoded using Windows Media Player version 8 (or less) or Windows Media Player for Windows XP.
- This player is not compatible with lossless-encoding or variable bit-rate (VBR) WMA files.
- WMA files encoded with DRM (Digital Rights Management) copy protection will not play and the message **Can't play this format** will be displayed (**No Play** in the front panel display).
- The CD-ROM used to compile your MP3, WMA must be ISO 9660 Level 1 or 2 compliant. CD physical format: Mode1, Mode2 XA Form1. Romeo and Joliet file systems are both compatible with this player.
- Use CD-R or CD-RW media for recording your files. The disc must be finalized (i.e. the session must be closed) in order to play in this unit. This player is not compatible with multi-session discs. Only the first session of a multi-session disc will be recognized.
- This player only plays tracks that are named with the file extension .mp3, .MP3, .wma, or .WMA.

- When naming MP3 and WMA files, add the corresponding file name extension (.mp3 or .wma). Files are played according to the file extension. To prevent noise and malfunctions, do not use these extensions for other kinds of files.
- This player can recognize up to 999 files (WMA/MP3/JPEG) and up to 499 folders. If a disc exceeds these limits, only files and folders up to these limits will be playable. Files and folders are read/displayed in alphabetical order. Note that if the file structure is very complex, you may not be able to read/play all files on the disc.
- Folder and track names (excluding the file extension) are displayed.
- There are many different recording bit-rates available to encode MP3 files. This unit was designed to be compatible with all of them. Audio encoded at 128Kbps should sound close to regular CD Audio quality. This player will play lower bit-rate files, but please note that the sound quality becomes noticeably worse at lower bit-rates.

JPEG file compatibility

- Baseline JPEG and EXIF 2.1* still image files up to 8 mega-pixels are supported (maximum vertical and horizontal resolution is 5120 pixels). (**File format used by digital still cameras*)
- The CD-ROM used to compile your JPEG files must be ISO 9660 Level 1 or 2 compliant. CD physical format: Mode1, Mode2 XA Form1. Romeo and Joliet file systems are both compatible with this player.
- This player only displays files that are named with the file extension .jpg or .JPG.

Chapter 2 Controls and displays

Front panel

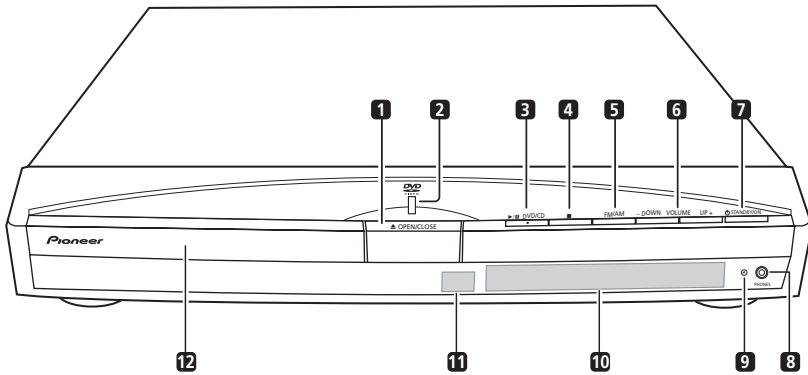

1 ▲ OPEN/CLOSE

Press to open/close the disc tray.

2 Operation indicator

3 ►/|| DVD/CD

Press to switch to the **DVD/CD** function. Also press to start/pause/resume playback.

4 ■

Press to stop playback.

5 FM/AM

Press to switch to the tuner function, then to toggle between the FM and AM bands.

6 VOLUME buttons

Use to adjust the volume.

7 ⏻ STANDBY/ON

Press to switch the system on or into standby.

8 PHONES jack

Headphone jack.

9 Timer indicator

Lights when the wake-up timer is set (page 54).

10 Display

See *Display* on page 12 for detailed information.

11 Remote sensor

12 Disc tray

Display

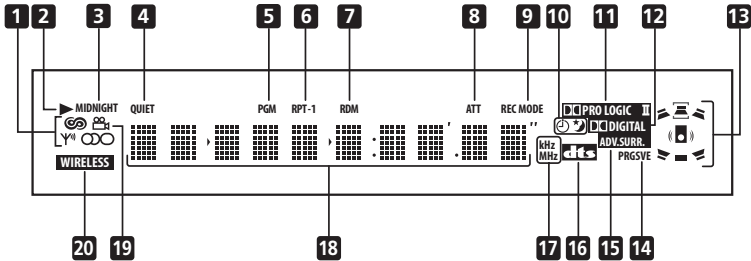

1 Tuner indicators



European model only

Lights when in one of the RDS display or search modes.



Lights when a broadcast is being received.



Lights when a stereo FM broadcast is being received in auto stereo mode.



Lights when FM mono reception is selected.

2 ▶

Lights when a disc is playing.

3 MIDNIGHT

Lights when the Midnight mode is selected (page 34).

4 QUIET

Lights when the Quiet mode is selected (page 34).

5 PGM

Lights when a program list has been programmed (page 42).

6 RPT and RPT-1

RPT lights during repeat play. RPT-1 lights during repeat one-track play (page 40).

7 RDM

Lights during random play (page 41).

8 ATT

Lights when the input attenuator is active for the currently selected analog input (page 72).

9 REC MODE

Lights when Rec Mode is active (page 72).

10 Timer indicators



Lights when the wake-up timer is set (page 54).



Lights when the sleep timer is active (page 55).

11 PRO LOGIC II

Lights during Dolby Pro Logic decoding (page 31).

12 DIGITAL

Lights during playback of a Dolby Digital source (page 31).

13 Speaker indicators

These show which speakers are being used to output the current source. The illustrations below show some example displays.



5.1 channel surround sound



Stereo (2.1 channel) sound



3.1 channel sound with Dialogue enhancement on the center channel



5.1 channel surround sound with Virtual Surround Back mode active

14 PRGSVE

Not applicable to the European model

Lights when progressive scan video output is selected (page 63).

15 ADV.SURR.

Lights when one of the Advanced Surround listening modes is selected (page 33).

16 DTS

Lights during playback of a DTS source (page 31).

17 kHz / MHz

Indicates the unit of the frequency shown in the character display (**kHz** for AM, **MHz** for FM).

18 Character display

19

Lights during multi-angle scenes on a DVD disc (page 47).

20 WIRELESS

Lights when either the **W.Surr.** or **W. Stereo** mode is selected (see *Using the wireless surround speaker* on page 36).

Remote control

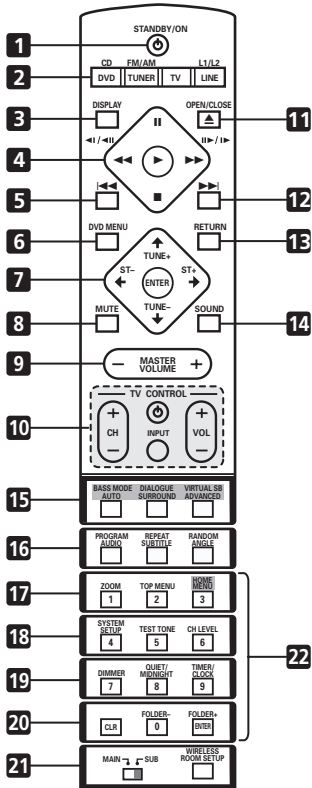

Important

- Functions printed in green on the remote control are accessed by switching the **MAIN/SUB** switch to **SUB**.

1 STANDBY/ON

Press to switch the system on or into standby.

2 **Function select buttons**

Press to select the source you want to listen to (**DVD (CD), TUNER, TV, LINE**)

3 **DISPLAY**

Press to display/change disc information shown on-screen (page 47).

4 **Disc playback controls**

▶
Press to start or resume playback.

◀◀ and ◀/▶▶

Use for reverse slow motion playback, frame reverse and reverse scanning.

▶▶ and ▶/▶▶

Use for forward slow motion playback, frame advance and forward scanning.

⏸

Press to pause playback; press again to restart.

■

Press to stop playback.

5 ◀◀

Press to jump to the beginning of the current chapter/track, then to previous chapters/tracks.

6 **DVD MENU**

Press to display a DVD disc menu, or the Disc Navigator if a VR format DVD-RW, CD, Video CD/Super VCD, MP3, WMA or JPEG disc is loaded.

7 **Cursor buttons, ENTER and tuning buttons**

Cursor buttons

Use the cursor buttons (↑/↓/←/→) to navigate on-screen displays and menus.

ENTER

Press to select an option or execute a command.

TUNE +/-

Use to tune the radio.

ST +/-

Use to select station presets when listening to the radio.

8 MUTE

Press to mute all sound from the speakers and headphones (press again to cancel) (page 36).

9 MASTER VOLUME

Use to adjust the volume.

10 TV CONTROL (page 21)

Press to switch the TV on or into standby.

INPUT

Press to switch the TV input.

CH +/-

Use to select channels on the TV.

VOL +/-

Use to adjust the volume on the TV.

11 ▲ OPEN/CLOSE

Press to open/close the disc tray.

12 ►►

Press to jump to the next chapter/track.

13 RETURN

Press to return to a previous menu screen.

14 SOUND

Press to access the sound menu, from which you can adjust the DSP effect level, bass and treble, etc.

15 Surround sound mode/sound enhancement buttons**AUTO**

Press to select the default decoding for the current source (page 31).

SURROUND

Use to select a Surround mode (page 31).

ADVANCED

Use to select an Advanced Surround (page 33).

BASS MODE

Use to select a Bass Mode (page 35).

DIALOGUE

Use to select a Dialogue mode (page 34).

VIRTUAL SB

Press to switch the Virtual Surround Back speaker effect on/off (page 34).

16 DVD/CD buttons**AUDIO**

Press to select an audio channel or language (page 46).

SUBTITLE

Press to display/change the DVD subtitle display (page 46).

ANGLE

Press to change camera angle during DVD multi-angle scene playback (page 47).

PROGRAM

Use to program/play a program list (page 42).

REPEAT

Use to select a repeat play mode (page 40).

RANDOM

Use to select a random play mode (page 41).

17 ZOOM

Press to change the screen zoom level (page 47).

TOP MENU

Use to display the top menu of a DVD disc in the play position (this may be the same as pressing **DVD MENU**).

HOME MENU

Press to display (or exit) the on-screen menu for Initial Settings, Play Mode functions, etc.

18 SYSTEM SETUP

Use to make various system and surround sound settings (page 57).

TEST TONE

Use to output the test tone (for speaker setup) (page 59).

CH LEVEL

Use to adjust the speaker level (page 59).

19 DIMMER

Press to switch between normal and dimmed front panel display.

QUIET/MIDNIGHT

Use to select the Quiet and Midnight modes (page 34).

TIMER/CLOCK

Press to display the clock and to access the timer menu (page 20 and page 54).

20 CLR

Press to clear an entry.

FOLDER –

Press to jump to previous folders.

FOLDER +

Press to jump to the next folder.

ENTER

Selects menu options, etc. (works exactly the same as the **ENTER** button in **7** above).

21 MAIN/SUB

Change from **MAIN** to **SUB** to access the functions/commands printed in green on the remote.

WIRELESS

Press to switch between modes with the wireless speaker system (see *Using the wireless surround speaker* on page 36).

ROOM SETUP

Press to start Room Setup (page 21).

22 Number buttons

Use the number buttons for selecting chapters/tracks from a disc directly.

Wireless speaker system

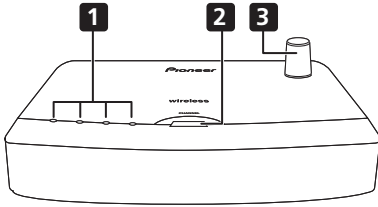

Transmitter

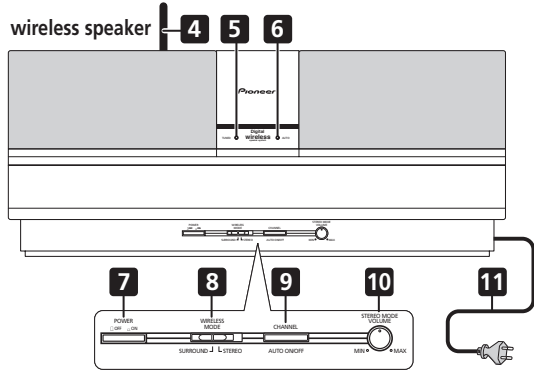

1 CHANNEL indicator

Lights to indicate the selected channel.

2 CHANNEL button

Press to select a frequency channel. The frequency channel changes sequentially each time the button is pressed:



3 Antenna

Transmits signals to the XW-DV515 wireless speaker.

4 Wireless speaker antenna

Receives signals from the transmitter.

5 TUNED indicator

Lights when the signal from the transmitter is properly received.

6 AUTO indicator

Lights when **AUTO** is selected.

7 POWER button

Press to switch the speaker on or off.

8 WIRELESS MODE switch

Selects between **SURROUND** or **STEREO**.

See *Using the wireless surround speaker* on page 36 for more on this.



Caution

- Make sure to stop/turn off the source and switch off the wireless speaker when switching speaker systems. The wireless speaker will output the source at very loud volumes if the wireless speaker is set to **SURROUND** and the main unit is set to **W.Stereo**. In this case, the volume control has no effect, so please follow these precautions.

9 CHANNEL (AUTO ON/OFF) button

The default setting is **AUTO**, where the channel is automatically set to the same one selected on the transmitter. If you find that the reception is weak, try switching to **AUTO OFF**. This 'locks' the signal and can result in better reception.

Press and hold for about 5 seconds to switch between **AUTO** and **AUTO OFF**.

10 STEREO MODE VOLUME knob

Turn to adjust the speaker volume when **WIRELESS MODE** is set to **STEREO (W.Stereo)**.

11 Power cord

Connect to an AC outlet.

**Note**

- The **STEREO MODE VOLUME** knob has no effect when **WIRELESS MODE** is set to **SURROUND**.
- Even when not in use, the fan in the wireless speaker will continue to operate. Switching off the wireless speaker when not in use will increase product life.

Placing the wireless speaker

For best surround sound, make sure to place the wireless speaker directly behind the center of the listening position and no higher than ear level. Also, make sure you don't move the wireless speaker too far behind the listening position or you will lose much of the surround sound effect.

For a greater surround sound effect from the wireless speaker, see *Setting the channel levels* on page 59 to increase the surround channel levels.

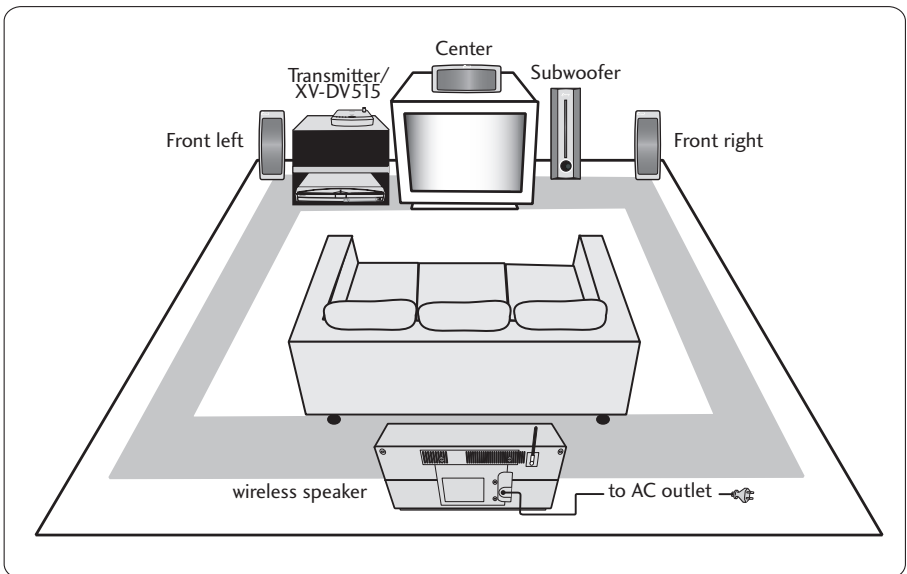
Overhead view of a multi-channel (SURROUND) setup with the XW-DV515

Chapter 3

Getting started

Switching on and setting up

After making sure everything is connected up properly, you're ready to switch on. The first thing to do is to tell the system what kind of TV you're using, standard or widescreen.

After that you can set up the surround sound for your room, and set the clock so that you can use the timer features.

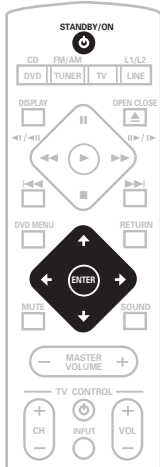

1 Press STANDBY/ON (on the remote or on the front panel) to switch the system on.

Also make sure that your TV is switched on and that the video input is set to this system.

2 European model only: Use the / (cursor up/down) buttons to choose a language, then press ENTER.

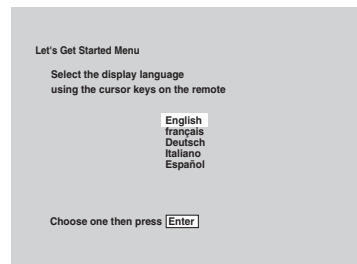

Not Applicable to the European model: After you're finished reading the welcome screen, press ENTER to move on.

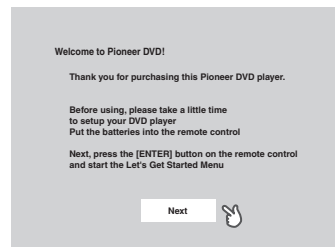

3 Use the **←/→** (cursor left/right) buttons to select either 'Wide screen (16:9)' or 'Standard size screen (4:3)' according to the kind of TV you have, then press **ENTER**.

See also *Screen sizes and disc formats* on page 84 if you're not sure which one to choose.

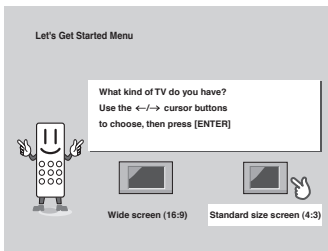

4 Press **ENTER** again to finish setting up.

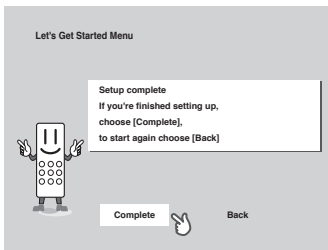

- Use the **→** (cursor right) button to select **BACK** then press **ENTER** if you want to go back and change the setting you just made.



Tip

- You can also use the function buttons (**DVD/CD**, **TUNER**, etc.) or the **▲ OPEN/CLOSE** button to switch the system on from standby.

Setting the clock

Setting the clock allows you to use the timer features.

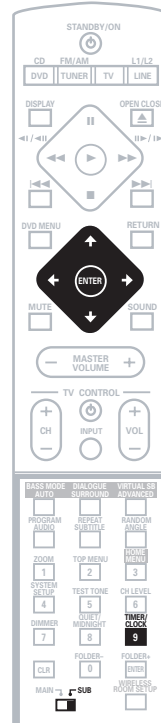

1 Press **TIMER/CLOCK**.

- If you are adjusting the clock, rather than setting it for the first time, press **TIMER/CLOCK** again.

2 If 'Clock ADJ?' isn't already showing in the display, press **←** or **→** (cursor left or right) until you see it.

3 Press **ENTER**.

4 Use the **↑/↓** (cursor up/down) buttons to set the hour.

5 Press **ENTER**.

6 Use the ↑/↓ (cursor up/down) buttons to set the minute.

7 Press ENTER to confirm.

The display flashes to indicate the clock is set.



Tip

- Press **TIMER/CLOCK** anytime to display the clock.



Note

- If you unplug the system from the wall outlet, or there is a power outage, you will need to set the clock again.

Setting up the remote to control your TV

You can set up the supplied remote to control your TV using the **TV CONTROL** buttons.

1 Switch on your TV.

2 Find the name of the manufacturer of your TV in the Preset code list on page 86

Next to each manufacturer is one or more three digit codes. These tell the remote what kind of TV you have.

If the name of the manufacturer of your TV does not appear in the table, you won't be able to set up this remote to control your TV.

3 Point the remote at your TV, hold down the CLR button, then enter the three digit code for your TV.

The remote transmits an on/off signal to the TV. If you've entered the correct code, your TV should switch off.

If your TV doesn't turn off, repeat the procedure using the next code in the list until your TV switches off successfully. Once set, you can then use the individual TV controls shown below.

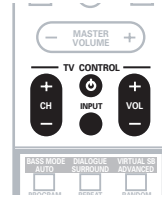

Button	What it does
	Switches your TV on or into standby.
CH +/-	Changes the TV channel.
VOL +/-	Adjusts the volume.
INPUT	Switches the TV's input between the built in TV tuner and an external video source.



Note

- The default setting is for a Pioneer TV.

Using the Room Setup

Before using your system to enjoy surround sound playback, we recommend you spend a few minutes using the Room Setup. This is a quick and easy way to get good surround sound for your room.



Depending on the distance of the surround speakers from your main listening position, choose between **S** (small), **M** (medium), or **L** (large) room, then depending on your seating position relative to the front and surround speakers, choose **Fwd** (forward), **Mid**, or **Back**.

1 If the system isn't already on, press  STANDBY/ON to switch it on.

2 Press ROOM SETUP.



- If you have previously set up the room type and seating position, the display will show the current room settings.

3 Press ENTER.

4 Use the / (cursor up/down) buttons to select a room type then press ENTER.

Choose one of the following depending on your room size:

- **S** – Smaller than average room
- **M** – Average room
- **L** – Larger than average room

5 Use the / (cursor up/down) buttons to select a seating position setting, then press ENTER.

Choose one of the following depending on where your main listening position is:

- **Fwd** – If you are nearer to the front speakers than the surround speakers
- **Mid** – If you are equal distance from the front and surround speakers
- **Back** – If you are nearer to the surround speakers than the front speakers







Note

- The Room Setup automatically sets up both channel level and channel delay. If you have already set the channel levels manually (see *Setting the channel levels* on page 59), you will see **Room Set?** in the display when you first press the **ROOM SETUP** button.
- Using the Room Setup will overwrite any previous settings you had for channel level and channel delay.

- For a more detailed surround sound setup, see *Setting up surround sound* on page 57.

Using the on-screen displays

For ease of use, this system makes extensive use of graphical on-screen displays (OSDs). You should get used to the way these work as you'll need to use them when setting up the system, using some of the playback features, such as program play, and when making more advanced settings for audio and video.

All the screens are navigated in basically the same way, using the cursor buttons (, , , ) to change the highlighted item and pressing **ENTER** to select it.



Important

- Throughout this manual, 'Select' means use the cursor buttons to highlight an item on-screen, then press **ENTER**.

**Tip**

- The button guide at the bottom of every OSD screen shows you which buttons you'll need to use for that screen.

Playing discs

The basic playback controls for playing DVD, CD, Video CD/Super VCD and WMA/MP3 discs are covered here. Further functions are detailed in the chapter 5.

- 1 If the player isn't already on, press  STANDBY/ON to switch it on.**

If you're playing a DVD or Video CD, also turn on your TV and make sure that it is set to the correct video input.

- 2 Press  OPEN/CLOSE to open the disc tray.**

- 3 Load a disc.**

Load a disc with the label side facing up, using the disc tray guide to align the disc (if you're loading a double-sided DVD disc, load it with the side you want to play face down).

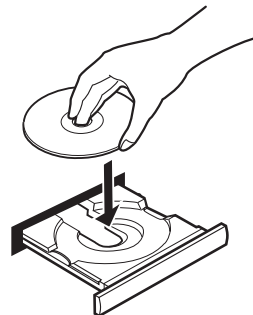

- 4 Press  (play) to start playback.**

If you're playing a DVD or Video CD/Super VCD, a menu may appear. See *DVD-Video disc menus* on page 26 and *Video CD/Super VCD PBC menus* on page 27 for how to navigate these.

Button	What it does
HOME MENU	Displays/exits the on-screen display
← ↑ ↓ →	Changes the highlighted menu item
ENTER	Selects the highlighted menu item (both ENTER buttons work in exactly the same way)
RETURN	Returns to the main menu without saving changes

If you're playing an WMA/MP3 disc, it may take a few seconds before playback starts, depending on the complexity of the file structure on the disc.

If you loaded a CD/CD-R/RW containing JPEGs, a slideshow will start. See *Viewing JPEG discs* on page 50 for more on playing these discs.

- See also *PhotoViewer* on page 69 if the disc contains both WMA/MP3 audio files and JPEG picture files.

5 Use the MASTER VOLUME – / + button (or the front panel VOLUME buttons) to adjust the volume.

Basic playback controls

The table below shows the basic controls on the remote for playing discs. You can find other playback features in the chapter 5.

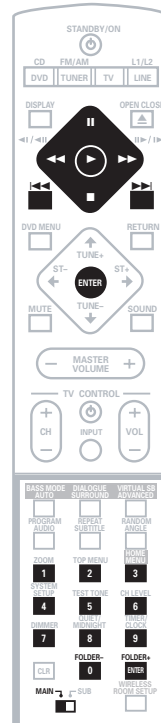

Button	What it does
▶	Starts playback. <i>DVD and Video CD/Super VCD:</i> If the display shows Resume or Last Mem playback starts from the resume or last memory point (see also <i>Resume and Last Memory</i> below.)

Button	What it does
II	Pauses a disc that's playing, or restarts a paused disc.
■	Stops playback. <i>DVD and Video CD/Super VCD:</i> The display shows Resume . Press ■ again if you want to cancel the resume function. (See also <i>Resume and Last Memory</i> below.)
◀◀	Press to start fast reverse scanning. Press ▶ (play) to resume normal playback.
▶▶	Press to start fast forward scanning. Press ▶ (play) to resume normal playback.
◀◀◀	Skips to the start of the current track or chapter, then to previous tracks/chapters.
▶▶▶	Skips to the next track or chapter.
FOLDER +/-	Skips to the next/previous folder when playing an WMA/MP3 disc.
Numbers	<ul style="list-style-type: none"> • If the disc is stopped, playback starts from the selected title (for DVD) or track number (for CD/Video CD/Super VCD/WMA/MP3) after a few seconds (or after pressing ENTER). • If the disc is playing, playback jumps to the start of the selected chapter or track after a few seconds (or after pressing ENTER).

**Note**

- You may find with some DVD discs that some playback controls don't work in certain parts of the disc. This is not a malfunction.
- Track skip and number buttons for track selection do not work with unfinalized CD-R/RW discs.

Using the front panel controls

The ▲ **OPEN/CLOSE**, ▶/II **DVD/CD, FM/AM** and ■ (stop) buttons on the front panel work the same way as the remote control equivalents.

Resume and Last Memory

When you stop playback of a DVD or Video CD disc, **Resume** is shown in the display indicating that you can resume playback again from that point.

If the disc tray is not opened, the next time you start playback the display shows **Resume** and playback resumes from the resume point. For DVD discs only: If you take the disc out of the player, the play position is stored in memory. When you load the disc next time, the display shows **Last Mem** and you can resume playback (this works for up to five discs).

If you want to clear the resume/last memory point, press ■ (stop) while **Resume** or **Last Mem** is displayed.

**Note**

- When a Video CD is loaded, the Resume point is lost if the system is switched off, or switched to a function other than **DVD (CD)**.
- For the Last Memory function to work, you must press ■ (stop) to stop playback before opening the disc tray.

- The Last Memory function doesn't work with VR format DVD-RW discs.



FAQ

- *After I load a DVD disc, it ejects automatically after a few seconds!*
Most likely, the disc is the wrong region for your system. The region number should be printed on the disc; check it against the region number of the system (which you can find on the rear panel). See also *DVD Video regions* on page 77. If the region number is OK, it may be that the disc is damaged or dirty. Clean the disc and look for signs of damage. See also *Using and taking care of discs* on page 76.

- *Why won't the disc I loaded play?*
First check that you loaded the disc the right way up (label side up), and that it's clean and not damaged. See *Using and taking care of discs* on page 76 for information on cleaning discs.

If a disc loaded correctly won't play, it's probably an incompatible format or disc type, such as DVD-Audio or DVD-ROM. See *General disc compatibility* on page 8 for more on disc compatibility.

- *I have a widescreen TV so why are there black bars at the top and bottom of the screen when I play some discs?*
Some movie formats are such that even when played on a widescreen TV, black bars are necessary at the top and bottom of the screen. This is not a malfunction.
- *I have a standard (4:3) TV and set the system to show widescreen DVDs in pan & scan format, so why do I still get black bars top and bottom with some discs?*
Some discs override the display preferences of the system, so even if you have **4:3 (Pan & Scan)** selected, those discs will still be shown in letterbox format. This is not a malfunction.

DVD-Video disc menus

Many DVD-Video discs contain menus from which you can select what you want to watch. They may give access to additional features, such as subtitle and audio language selection, or special features such as slideshows. See the disc packaging for details.

Sometimes DVD-Video menus are displayed automatically when you start playback; others only appear when you press **DVD MENU** or **TOP MENU**.

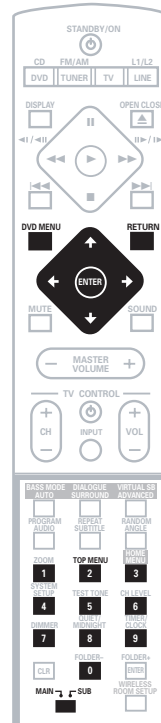

Button	What it does
TOP MENU	Displays the 'top menu' of a DVD disc—this varies with the disc.
DVD MENU	Displays a DVD disc menu—this varies with the disc and may be the same as the 'top menu'.
←↑↓→	Moves the cursor around the screen.
ENTER	Selects the current menu option.
RETURN	Returns to the previously displayed menu screen.
Numbers	Highlights a numbered menu option (some discs only). Press ENTER to select.

Video CD/Super VCD PBC menus

Some Video CD/Super VCDs have menus from which you can choose what you want to watch. These are called PBC (Playback control) menus.

You can play a PBC Video CD/Super VCD without having to navigate the PBC menu by starting playback using a number button to select a track, rather than ► (play) (or ►/|| on the front panel).

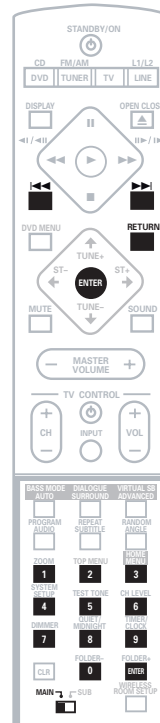

Button	What it does
RETURN	Displays the PBC menu.

Button	What it does
Numbers	Selects a numbered menu option.
◀◀	Displays the previous menu page (if there is one).
▶▶	Displays the next menu page (if there is one).
ENTER	Press to select highlighted menu option.

Listening to the radio

The tuner can receive both FM and AM broadcasts, and lets you memorize your favorite stations so you don't have to manually tune in every time you want to listen. For more on using the radio, see *More tuner features: RDS* on page 52.

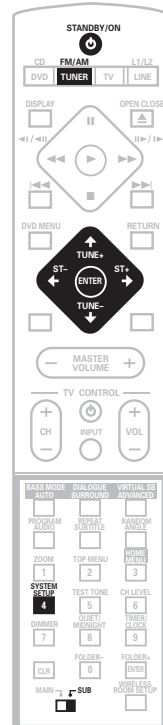

- 1 If the system isn't already on, press **STANDBY/ON** to switch on.
- 2 Press **TUNER** to switch to the tuner, then press repeatedly to select the **AM** or **FM** band.

The display indicates the tuner band and the frequency.

- If you're using the front panel controls, the **TUNER** button switches between FM, AM and station presets (see *Memorizing stations* below).

3 Tune to a frequency.

There are three tuning modes—manual, auto, and high-speed:

- **Manual tuning:** Press **TUNE +/-** repeatedly to change the displayed frequency.
- **Auto tuning:** Press and hold **TUNE +/-** until the frequency display starts to move, then release. The tuner will stop on the next station it finds. Repeat to search for other stations.
- **High-speed tuning:** Press and hold **TUNE +/-** until the frequency display starts to move rapidly. Keep the button held down until you reach the frequency you want. If necessary, fine tune the frequency using the manual tuning method.

Improving poor FM reception

If you're listening to an FM station in stereo but the reception is weak, you can improve the sound quality by switching to mono.

- 1 **Tune to an FM radio station.**
- 2 **Press SYSTEM SETUP.**
- 3 **Use the ←/→ (cursor left/right) buttons to choose 'FM Mode?' then press ENTER.**
- 4 **Use the ↑/↓ (cursor up/down) buttons to select 'FM Mono' then press ENTER.**

The mono indicator (○) lights when the tuner is in mono reception mode.

Select **Auto** above to switch back to auto-stereo mode (the stereo indicator (⊕) lights when receiving a stereo broadcast).

Memorizing stations

You can save up to 30 station presets so that you always have easy access to your favorite stations without having to tune in manually each time.

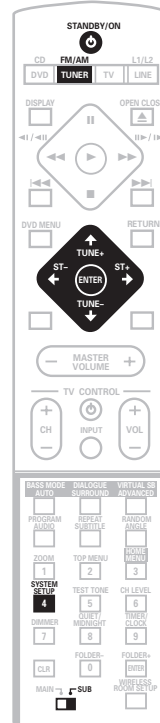

- 1 **Tune to an AM or FM radio station.**

For the FM band, select mono or auto-stereo reception as necessary. This setting is saved along with the preset.

2 Press **SYSTEM SETUP**.

3 Use the **←/→** (cursor left/right) buttons to choose 'St. Memory?' then press **ENTER**.

4 Use the **↑/↓** (cursor up/down) buttons to select the station preset you want.

There are 30 preset locations; each can store one station preset.

5 Press **ENTER** to save the station preset.



Note

- If the system is unplugged from the power supply completely, saved stations will remain for several days, after which you'll have to save them again.

Listening to station presets

1 Make sure the **TUNER** function is selected.

2 Use the **ST +/-** buttons to select a station preset.

Listening to other sources

You can connect up to three external sources (TV, satellite receiver, etc.) to this system, including one digital source. See also *Connecting auxiliary components* on page 71.

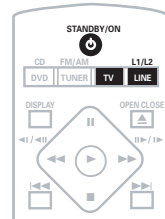

1 If the system isn't already on, press **STANDBY/ON** to switch on.

Also make sure that the external source (TV, satellite receiver, etc.) is switched on.

2 Select the source you want to listen to.

- If you're using the remote control, press **TV** to select the **TV IN** input, or use the **LINE (L1/L2)** button to select the **LINE 1** or **LINE 2** input.

3 If necessary, start playback of the external source.

Chapter 4

Home theater sound

Using this system you can enjoy listening to sources, analog or digital, in either stereo or surround sound.

Auto listening mode

The Auto listening mode is the simplest way to listen to any source as it was mastered: the output from the speakers mirrors the channels in the source material.

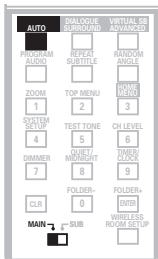

- Press **AUTO** to select the 'Auto' listening mode.

If the source is Dolby Digital or DTS, the **DOLBY DIGITAL** or **DTS** indicator on the front panel lights. The **STEREO** indicator lights when playing a stereo source.



Note

- Any previously active Dolby Pro Logic or Advanced Surround mode is cancelled when Auto listening mode is selected.

Listening in surround sound

You can listen to any source—stereo or multichannel, analog or digital—in surround sound. Surround sound is generated from stereo sources using one of the Dolby Pro Logic decoding modes.

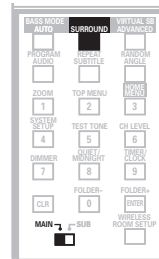

- Press **SURROUND** repeatedly to select a listening mode (or press **SURROUND** then use the **↑/↓** (cursor up/down) buttons).

The listening mode choices that appear in the display will vary according to the type of source that's playing.

- **Auto** – Auto listening mode (see above)
- **Dolby Digital / DTS** – Dolby Digital or DTS decoding (depending on the source). For a multichannel source, this will be the same as **Auto**.
- **Pro Logic** – 4.1 channel surround sound for use with any two-channel source
- **PL II Movie** – Pro Logic II 5.1 channel surround sound, especially suited to movie sources, for use with any two-channel source
- **PL II Music** – Pro Logic II 5.1 channel surround sound, especially suited to music sources, for use with any two-channel source (see also *Dolby Pro Logic II Music settings* below)

- **Stereo** – See *Listening in stereo* below

**Tip**

- See also *Using the Advanced Surround effects* below, for further stereo and surround playback options.

**Note**

- You can't use the Surround modes with high sampling rate 88.2 / 96 kHz sources.
- When listening in **Dolby Digital / DTS** mode, two-channel material will automatically be played in surround sound using Dolby Pro Logic decoding.
- Dolby Digital / DTS sources that use only the center channel cannot be played back in surround sound.

Dolby Pro Logic II Music settings

When listening in Dolby Pro Logic II Music mode, there are three further parameters you can adjust: Center Width, Dimension, and Panorama.

1 With Dolby Pro Logic II Music mode active, press SOUND.

2 Use the ←/→ (cursor left/right) buttons to select 'C Width', 'Dimen.' or 'Pnrm.'

- **C Width** (Center Width): Makes the center channel wider (higher settings) or narrower (lower settings)
- **Dimen.** (Dimension): Makes the sound more distant (minus settings), or more forward (positive settings)
- **Pnrm.** (Panorama): Creates more spacious surround sound

3 Use the ↑/↓ (cursor up/down) buttons to adjust the setting.

Center Width is adjustable between **0** and **7**; Dimension between **-3** and **+3**. Panorama is **On** or **Off**.

4 Press ENTER to confirm.

Listening in stereo

You can listen to any source—stereo or multichannel, analog or digital—in stereo. When playing a multichannel source, stereo sound is created by downmixing all channels to the front left/right speakers and the subwoofer.

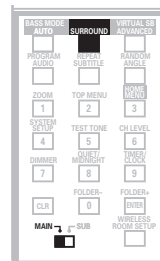

- **Press SURROUND repeatedly until 'Stereo' shows in the display.** Any active Advanced Surround mode is cancelled.

**Tip**

- See also *Using the Advanced Surround effects* below, for further stereo and surround playback options.

Listening with headphones

When headphones are connected, only the **Stereo** (default) and **Phones Surround** (virtual surround sound for headphones) modes are available.

When you connect a pair of headphones, the listening mode automatically changes to **Stereo**. When you disconnect them it reverts to the previous mode.

- **With headphones connected, press **ADVANCED** to select 'Phones Surround' or **SURROUND** to select 'Stereo'.**

Using the Advanced Surround effects

Advanced Surround effects can be used with multichannel or stereo sources for a variety of additional surround sound effects.

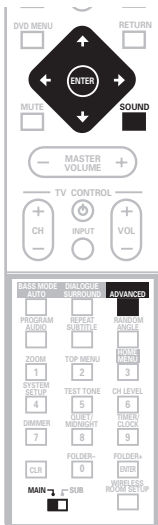

- **Press **ADVANCED** to select an Advanced Surround mode (or press **ADVANCED** then use the **↑/↓** (cursor up/down) buttons).**

Press repeatedly to select from:

- **Adv. Music** – Gives a concert hall-type sound
- **Adv. Movie** – Gives a movie theater-type sound

- **Expanded** – Creates an extra wide stereo field
- **TV Surr.** – Designed for mono or stereo TV broadcasts and other sources
- **Sports** – Designed for sports and other programs based on commentary
- **Game** – Creates surround sound from video game sources
- **ExpPwrSurr.** (Extra Power Surround) – Gives additional energy and width to stereo sources
- **Virtual** – Creates the impression of surround sound from just the front speakers
- **5ch Stereo** – Designed to give powerful surround sound to stereo music sources



Note

- You can't use the Advanced Surround modes with high sampling rate 88.2 / 96 kHz sources.
- You can use any of the above Advanced Surround modes with any type of source. The descriptions are given only as a guide.

Adjusting the Advanced Surround effect level

- Default setting: **70**

You can emphasize or reduce the effect of the Advanced Surround modes as you like. For each Advanced Surround mode you can set the effect level independently.

1 With one of the Advanced Surround modes active, press **SOUND.**

2 Use the **←/→ (cursor left/right) buttons to select 'Effect'.**

3 Use the **↑/↓ (cursor up/down) buttons to adjust the effect level.**

The effect level can be adjusted from **10** (min) to **90** (max).

4 Press ENTER to confirm.

Enhancing dialogue

- Default setting: **Dialog. Off** (European model) / **Dialog. Mid** (All other models)

The Dialogue Enhancement feature is designed to make the dialog stand out from other background sounds in a TV or movie soundtrack.



- Press **DIALOGUE** to select the amount dialog enhancement.

Press repeatedly to select from:

- **Dialog Off** – No dialog enhancement
- **Dialog Mid** – Moderate dialog enhancement
- **Dialog Max** – Strong dialog enhancement



Note

- You can't use Dialog Enhancement with high sampling rate 88.2 / 96 kHz sources.

Listening with a virtual surround back speaker

- Default setting: **Vir. SB Off**

The Virtual Surround Back feature can be used when listening in surround sound to simulate an added surround back channel. In a real theater the surround back speaker would be directly behind you, creating more cohesive and realistic surround sound.

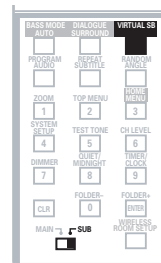

- Press **VIRTUAL SB** repeatedly to switch between 'Vir. SB On' and 'Vir. SB Off'.



Note

- You can't use Virtual Surround Back when listening in **Stereo** or **Virtual** listening modes.
- If there is no surround channel, Virtual Surround Back has no effect.
- You can't use the Virtual Surround Back effect with high sampling rate 88.2 / 96 kHz sources, or with headphones.

Using Quiet and Midnight listening modes

- Default setting: **Off**

The Quiet listening feature reduces excessive bass or treble in a sound source. You can use this feature if the music is a little bit harsh and you would like a smoother sound.

The Midnight listening feature allows you to hear effective surround sound of movies at low volume levels. The effect automatically adjusts according to the volume at which you're listening.

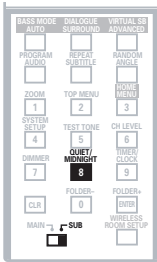

- Press **QUIET/MIDNIGHT** repeatedly to switch between 'Quiet', 'Midnight' and 'Off'.

Adjusting the bass and treble

- Default setting: Treble: **+1**, Bass: **0** (European model)/Treble: **+2**, Bass: **0** (All other models)

Use the bass and treble controls to adjust the overall tone. Bass and treble adjustment is not possible when the Quiet or Midnight modes are active.

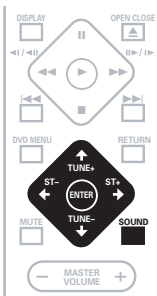

- 1 Press **SOUND**.
- 2 Use the **←/→** (cursor left/right) buttons to select 'Bass' or 'Treble'.
- 3 Use the **↑/↓** (cursor up/down) buttons to adjust the sound. The bass and treble can be adjusted from **-3** to **+3**.
- 4 Press **ENTER** to confirm.

Boosting the bass level

There are three bass modes you can use to enhance the bass in a source.

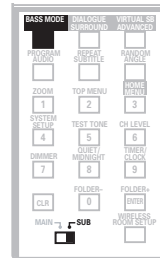

- Press **BASS MODE** repeatedly to choose an option that fits the source you're listening to.

- **Music** – Can be used with music to give a deeper bass sound
- **Cinema** – Good for action movies or movies with lots of sound effects
- **P. Bass** – Can be used with music sources to bring the beat of the music (or soundtrack) to the forefront
- **Off**

 **Note**

- You can't use the bass mode when the headphones are connected.

Muting the sound

Use the **MUTE** button if you need to momentarily turn off all sound from the speakers.

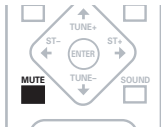

- Press **MUTE** to mute the volume. To cancel, adjust the volume or press **MUTE** again.

Using the wireless surround speaker

The wireless speaker supplied with your system can be used for multi-channel sound with your main setup, or as a second stereo speaker system.

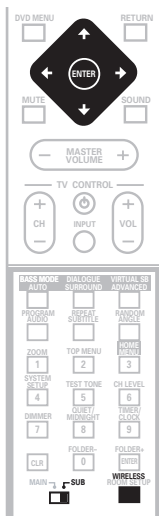

1 Press **WIRELESS**.

The current setting is shown in the display.

2 Use **↑/↓ (cursor up/down)** to select **'W.Surr.?', 'W.Stereo?', or 'W.Off?'**.

- **W.Surr.** – Sounds going to the surround left and right channels are heard through the wireless speakers.
- **W.Stereo** – Any source playing through the main system is heard in stereo through the wireless speakers (multi-channel sources will be downmixed to stereo).
- **W.Off** – The wireless speakers are muted.

Caution

- Make sure to stop/turn off the source and switch off the wireless speaker when switching speaker systems. The wireless speaker will output the source at very loud volumes if the wireless speaker is set to **SURROUND** and the main unit is set to **W.Stereo**. In this case, the volume control has no effect, so please follow these precautions.

3 Press **ENTER**.

4 Set the **WIRELESS MODE** switch on the wireless speaker to the same mode you selected above.

Note

- If you selected **W.Off** in step 2, the **WIRELESS MODE** switch has no effect.
- When you select **W.Surr. (SURROUND)** on the wireless speaker, you won't be able to hear anything through the speakers connected to the surround left and right speaker terminals. The signals are sent to the wireless speakers instead.

Chapter 5 Playing discs

Introduction

Most of the features described in this chapter make use of on-screen displays. For an explanation of how to navigate these, see *Using the on-screen displays* on page 22.

Many of the functions covered in this chapter apply to DVD discs, Video CD/Super VCDs, CDs and WMA/MP3/JPEG discs, although the exact operation of some varies slightly with the kind of disc loaded.

Some DVD discs restrict the use of some functions (random or repeat, for example). This is not a malfunction.

When playing Video CD/Super VCDs, some of the functions are not available during PBC playback. If you want to use them, start the disc playing using a number button to select a track.



Remember

- To access functions printed in green on the remote, move the slider switch from **MAIN** to **SUB**.

Using the Disc Navigator to browse the contents of a disc

Use the Disc Navigator to browse through the contents of a disc to find the part you want to play. You can use the Disc Navigator when a disc is playing or stopped.

1 Press HOME MENU and select 'Disc Navigator' from the on-screen display.

Alternatively, if a VR format DVD-RW, CD, Video CD/Super VCD or WMA/MP3/JPEG disc is loaded, you can press **DVD MENU**, which takes you straight to the Disc Navigator screen.

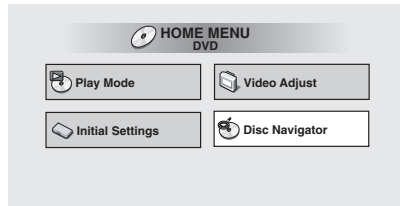

2 Select what you want to play.

Depending on the type of disc you have loaded, the Disc Navigator looks slightly different.

The screen for DVD discs shows the titles on the left and the chapters on the right. Select a title, or a chapter within a title.

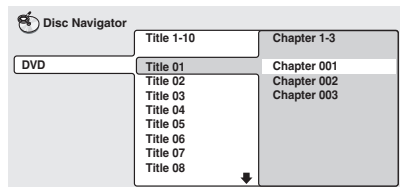

For a VR (Video Recording) mode DVD-RW disc select between the **Playlist** and **Original** areas of the disc, or a title. Press **➡** (cursor right) to preview the title.

- It's not possible to switch between **Original** and **Playlist** during playback.

- Not all VR format DVD-RW discs have a Playlist.

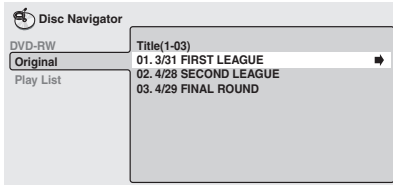

The screen for CDs and Video CD/Super VCDs shows a list of tracks.

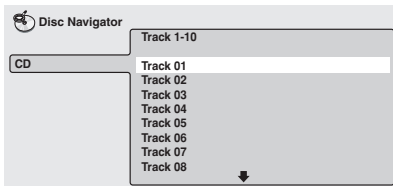

The screen for an WMA/MP3 disc shows the folder names on the left and the track names on the right (note that if there are more than 16 folders or names that contain accented or non-roman characters, tracks and folders may show up with generic names – **F_033**, **T_035**, etc.).

Select a folder, or a track within a folder.

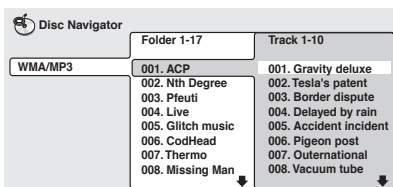

Playback starts after you press **ENTER**.



Tip

- The Disc Navigator is not available unless there is a disc loaded.

- It's not possible to use the Disc Navigator when playing a Video CD/Super VCD in PBC mode, or an unfinalized CD-R/RW disc.

- Another way to find a particular place on a disc is to use one of the search modes. See *Searching a disc* on page 45.

Scanning discs

You can fast-scan discs forward or backward at various different speeds.

- 1 During playback, press ◀◀ or ▶▶ to start scanning.**
- 2 Press repeatedly to increase the scanning speed.**
 - WMA/MP3 tracks can only be scanned at one speed.
 - The scanning speed is shown on-screen.
- 3 To resume normal playback, press ▶ (play).**



Note

- Sound can be heard while scanning audio CDs and WMA/MP3 discs.
- When scanning a Video CD/Super VCD or WMA/MP3 track, playback automatically resumes at the end or beginning of the track.
- There is no sound while scanning DVDs and Video CD/Super VCDs, and no subtitles while scanning DVDs.
- Depending on the disc, normal playback may automatically resume when a new chapter is reached on a DVD disc.

Playing in slow motion

You can play DVDs and Video CD/Super VCDs at four different forward slow motion speeds. DVD discs can also be played at two reverse speeds.

- 1 **During playback, press II (pause).**
- 2 **Press and hold ◀|/◀|| or |||/▶ to until slow motion playback starts.**
 - The slow motion speed is shown on-screen.
 - There is no sound during slow motion playback.
- 3 **Press repeatedly to change the slow motion speed.**
 - The slow motion speed is displayed on-screen.
- 4 **To resume normal playback, press ▶ (play).**



Note

- Video CD/Super VCD and VR format DVD-RWs only supports forward slow motion playback.
- The picture quality during slow motion playback is not as good as during normal playback.
- Depending on the disc, normal playback may automatically resume when a new chapter is reached.

Frame advance/frame reverse

You can advance or back up a DVD disc frame-by-frame. With Video CD/Super VCDs and VR format DVD-RWs, you can only use frame advance.

- 1 **During playback, press II (pause).**
- 2 **Press ◀|/◀|| or |||/▶ to reverse or advance a frame at a time.**
- 3 **To resume normal playback, press ▶ (play).**



Note

- The picture quality when using frame reverse is not as good as frame advance.
- Depending on the disc, normal playback may automatically resume when a new chapter is reached.
- When changing direction with a DVD disc, the picture may 'move' in an unexpected way. This is not a malfunction.

Looping a section of a disc

The A-B Repeat function allows you to specify two points (A and B) within a track (CD and Video CD/Super VCD) or title (DVD) that form a loop which is played over and over.



Important

- You can't use A-B Repeat with WMA/MP3 discs, Video CD/Super VCDs in PBC mode, or unfinalized CD-R/RW discs.

- 1 **During playback, press HOME MENU and select 'Play Mode'.**
- 2 **Select 'A-B Repeat' from the list of functions on the left.**

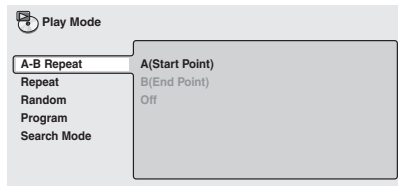

- 3 Press **ENTER** on 'A(Start Point)' to set the loop start point.

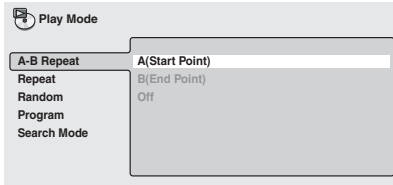

- 4 Press **ENTER** on 'B(End Point)' to set the loop end point.

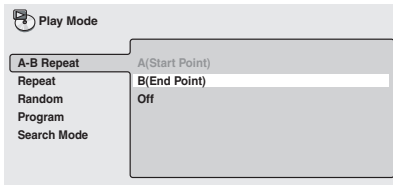

After pressing **ENTER**, playback jumps back to the start point and plays the loop.

- The minimum loop time is 2 seconds.

- 5 To resume normal playback, select 'Off' from the menu.

Using repeat play

There are various repeat play options, depending on the kind of disc loaded. It's also possible to use repeat play together with program play to repeat the tracks/chapters in the program list (see *Creating a program list* on page 42).



Important

- You can't use Repeat play with Video CD/ Super VCDs in PBC mode, or unfinalized CD-R/RW discs.

Using the OSD

- 1 During playback, press **HOME MENU** and select 'Play Mode'.
- 2 Select 'Repeat' from the list of functions on the left.

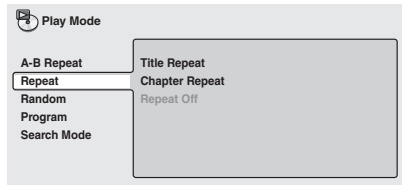

- 3 Select a repeat play option.

If program play is active, select **Program Repeat** to repeat the program list, or **Repeat Off** to cancel.

For DVD discs, select **Title Repeat** or **Chapter Repeat** (or **Repeat Off**).

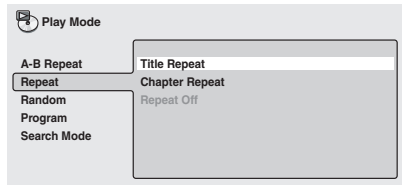

For CDs and Video CD/Super VCDs, select **Disc Repeat** or **Track Repeat** (or **Repeat Off**).

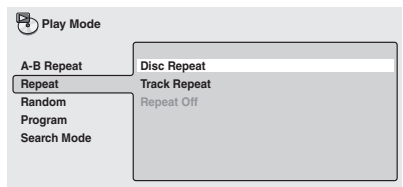

Playing discs

For WMA/MP3 discs, select **Disc Repeat**, **Folder Repeat** or **Track Repeat** (or **Repeat Off**).

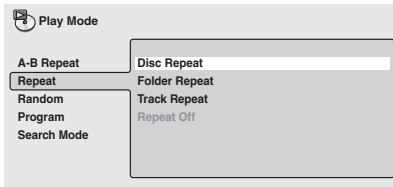

Using the front panel display

- During playback, press **REPEAT** to select a repeat play option.

Press repeatedly until the repeat play option you want is shown in the display.

The repeat options are the same as those available from the OSD (see above).



Tip

- If you've created a program list, **Program Repeat** is also available.
- During playback, you can cancel repeat play by pressing **CLR**.



Note

- You can't use repeat and random play at the same time.
- If you switch camera angle during repeat play, repeat play is canceled.

Using random play

Use the random play function to play titles or chapters (DVD-Video) or tracks (CD, Video CD/Super VCD and WMA/MP3 discs) in a random order.

You can set the random play option when a disc is playing or stopped.



Important

- You can't use random play with VR format DVD-RW discs, Video CD/Super VCDs playing in PBC mode, or while a DVD disc menu is being displayed.

Using the OSD

- 1 During playback, press **HOME MENU** and select 'Play Mode'.
- 2 Select 'Random' from the list of functions on the left.

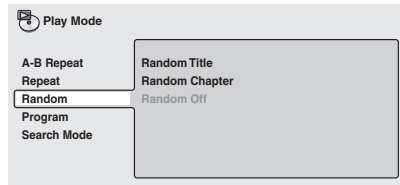

- 3 Select a random play option.

For DVD discs, select **Random Title** or **Random Chapter**, (or **Random Off**).

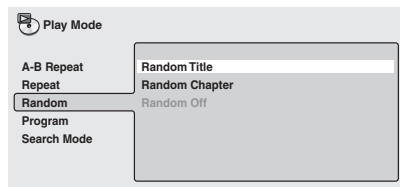

For CDs and Video CD/Super VCDs, select **On** or **Off** to switch random play on or off.

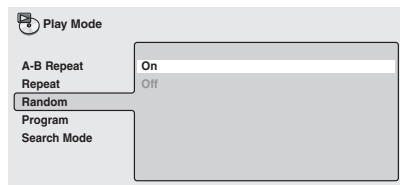

For WMA/MP3 discs, select **Random All** (all folders) or **Random Track** (current folder only), (or **Random Off**).

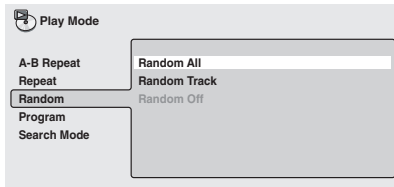

Tip

- You can also use the **RANDOM** button on the remote to select a random play mode. The random mode is indicated in the front panel display and on-screen. The random modes available are the same as when choosing from the **Play Mode** menu. Press **ENTER** to start random play.
- To stop the disc and cancel random playback, press **■** (stop).
- To cancel random playback without stopping playback, press **CLR**. The disc will play to the end, then stop.
- During random play, the **⏮** and **⏭** buttons function a little differently to normal: **⏮** returns to the beginning of the current track/chapter. You can't go back further than this. **⏭** selects another track/chapter at random from those remaining.
- You can't use random play together with program or repeat play.

Creating a program list

This feature lets you program the play order of titles/chapters/folders/tracks on a disc.



Important

- You can't use Program play with VR format DVD-RW discs, Video CD/Super VCDs playing in PBC mode, or while a DVD disc menu is being displayed.

Using the OSD

- 1 During playback, press **HOME MENU** and select 'Play Mode'.
- 2 Select 'Program' from the list of functions on the left.

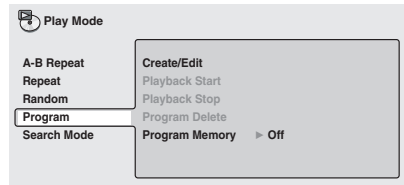

- 3 Select 'Create/Edit' from the list of program options.

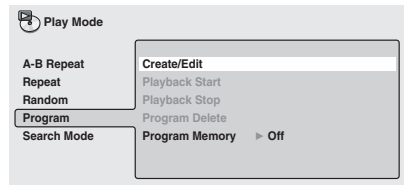

The Program edit screen that appears depends on the kind of disc loaded.

On the left side is the program list, then to the right is a list of titles (if a DVD disc is loaded), tracks (for CDs and Video CD/Super VCDs), or folder names (for WMA/MP3 discs). On the far right is a list of chapters (for DVD) or track names (for WMA/MP3).

4 Select a title, chapter, folder or track for the current step in the program list.

For a DVD disc, you can add a whole title, or a chapter within a title to the program list.

- To add a title, select the title.

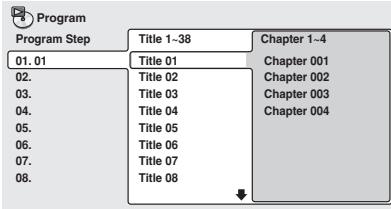

- To add a chapter, first highlight the title, then press **➡** (cursor right) and select a chapter from the list.

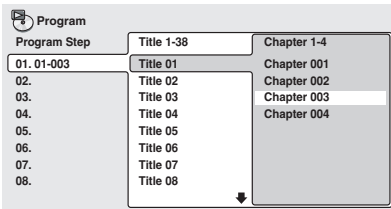

For a CD or Video CD/Super VCD, select a track to add to the program list.

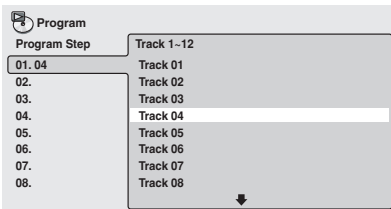

For an WMA/MP3 disc, you can add a whole folder, or a track within a folder to the program list.

- To add a folder, select the folder.

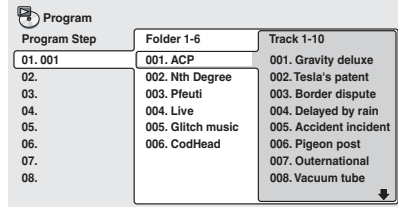

- To add a track, first find the folder, then press **➡** (cursor right) and select a track name from the list.

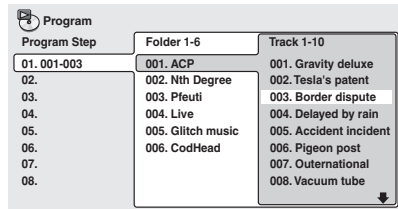

After pressing **ENTER** to select the title/chapter/folder/track, the step number automatically moves down one.

5 Repeat step 4 to build up a program list.

A program list can contain up to 24 titles/chapters/folders/tracks.

6 To play the program list, press **▶** (play).

Program play remains active until you turn off program play (see below), erase the program list (see below), eject the disc or switch off the player.



Tip

- To save your program list and exit the program edit screen without starting playback, press **HOME MENU**. (Don't press **RETURN** – your program list won't be saved.)

- During program play, press ►► to skip to the next program step.
- Press **CLR** during playback to switch off program play. Press while stopped to erase the program list.

Editing a program list using the OSD

After creating a program list, you can add, delete and change steps.

1 During playback, press HOME MENU and select 'Play Mode'.

2 Select 'Program' from the list of functions on the left.

3 Select 'Create/Edit' from the list of program options.

4 To clear a step, highlight the step number and press CLR.

5 To insert a step in the middle of the program list, highlight the step where you want the new step to appear, then select a title/chapter/folder/track to add.

After pressing **ENTER**, the new step is inserted into the list.

6 To add a step to the end of the program list, highlight the next free step then select a title/chapter/folder/track to add.



Tip

- To save your program list and exit the program edit screen without starting playback, press **HOME MENU**.
- If you want to exit the program edit screen without saving the changes you made, press **RETURN**.

Other functions available from the OSD program menu

As well as creating and editing a program list, you can start program play, cancel program play, erase the program list, and memorize a program list from the Play Mode menu.

1 During playback, press HOME MENU and select 'Play Mode'.

2 Select 'Program' from the list of functions on the left.

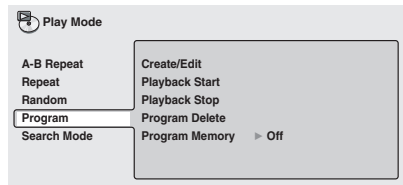

3 Select a program play function.

- **Create/Edit** – See above
- **Playback Start** – Starts playback of a saved program list
- **Playback Stop** – Turns off program play, but does not erase the program list
- **Program Delete** – Erases the program list and turns off program play
- **Program Memory** (DVD only) – Select On to save the program list for the disc loaded. (Select **Off** to cancel the program memory for the disc loaded)

Using the front panel display

Even though the OSD is available for CDs and WMA/MP3 discs, the front panel display provides enough information to make a program list easily. If a disc is playing, stop it first.

Playing discs

1 Press PROGRAM.

You're prompted to enter a track or folder for the first step in the program list.

P - 00 · 0' 00"

2 Use ↑/↓ (cursor up/down) to select a track or a folder, then press ENTER.

- For WMA/MP3 discs only: To select an individual track within a folder, use the ↑/↓ (cursor up/down) buttons to select the folder, then press →, then use ↑/↓ (cursor up/down) to select a track. Press ENTER.

P - 01 · 5' 37"

Wait for the display to prompt you after completing each selection. If you make a mistake, press CLR to delete the last (most recently) programmed track.

3 Repeat step 2 to build up a program list.

A program list can contain up to 24 steps.

4 To play the program list, press ► (play).

Program play remains active until you press ■ (stop), clear the playlist (see below), eject the disc or switch off the player.

Clearing the program list

You must clear the program list to program a new one.

1 If a disc is playing, press ■ (stop).

2 Press CLR.



Note

- Program lists are saved for the DVD disc loaded. When you load a disc with a saved program list, program play is automatically turned on.

- You can save program lists for up to 24 discs. After that, the oldest one is replaced with the new one saved.

Searching a disc

You can search DVD discs by title or chapter number, or by time. CD/Super VCDs can be searched by track number, and Video CDs by track number or time. WMA/MP3 discs can be searched by folder or track number.

1 During playback, press HOME MENU and select 'Play Mode'.

2 Select 'Search Mode' from the list of functions on the left.

The search options that appear depend on the kind of disc loaded. The screen below shows the DVD search options.

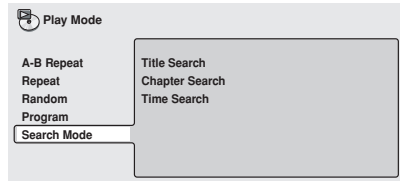

3 Select a search mode.

4 Use the number buttons to enter a title, chapter, folder or track number, or a time.

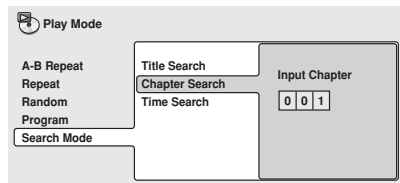

- For a time search, enter the number of minutes and seconds into the currently playing title (DVD) or track (Video CD) you want playback to resume from. For

example, press **4, 5, 0, 0** to have playback start from 45 minutes into the disc. For 1 hour, 20 minutes and 30 seconds, press **8, 0, 3, 0**.

5 Press ENTER to start playback.



Note

- The disc must be playing in order to use time search.
- Search functions are not available with Video CD/Super VCDs in PBC mode, or unfinalized CD-R/RW discs.

Switching subtitles

Some DVD discs have subtitles in one or more languages; the disc box will usually tell you which subtitle languages are available. You can switch subtitle language during playback.

- Press **SUBTITLE** repeatedly to select a subtitle option.

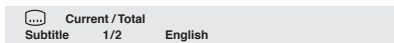

Note

- Some discs only allow you to change subtitle language from the disc menu. Press **TOP MENU** to access.
- To set subtitle preferences, see *Subtitle Language* on page 65.

Switching the DVD audio language

When playing a DVD disc recorded with dialog in two or more languages, you can switch audio language during playback.

- Press **AUDIO** repeatedly to select an audio language option.

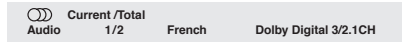

Note

- Some discs only allow you to change audio language from the disc menu. Press **TOP MENU** to access.
- To set audio language preferences, see *Audio Language* on page 64.

Switching VR format DVD-RW audio channel

When playing a VR format DVD-RW disc recorded with dual-mono audio, you can switch between the main, sub, and mixed channels during playback.

- 1 Press **AUDIO** repeatedly to select an audio channel option.

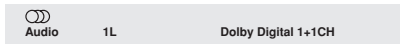

Switching the Video CD/Super VCD audio channel

When playing a Video CD/Super VCD, you can switch between stereo, just the left channel or just the right channel.

Super VCD supports four channels of audio. You can switch the playback channel between Stereo 1, Left 1, Right 1, Stereo 2, Left 2 and Right 2 (note that not all Super VCDs have a second soundtrack).

- Press **AUDIO** repeatedly to select an audio channel option.



Zooming the screen

Using the zoom feature you can magnify a part of the screen by a factor of 2 or 4, while watching a DVD or Video CD/Super VCD.

1 During playback, use the ZOOM button to select the zoom factor.

- Normal
- 2x
- 4x

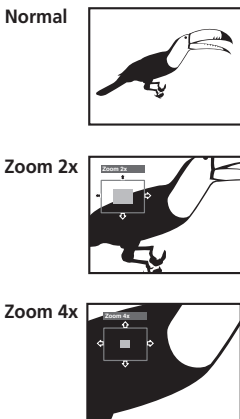

- Since DVD and Video CD/Super VCD have a fixed resolution, picture quality will deteriorate, especially at 4x zoom. This is not a malfunction.

2 Use the cursor buttons to change the zoomed area.

You can change the zoom factor and the zoomed area freely during playback.

- If the navigation square at the top of the screen disappears, press **ZOOM** again to display it.



Note

- We do not recommend using DVD disc menus when the screen is zoomed as menu options will not be highlighted.
- If you are displaying subtitles, these will disappear when the screen is zoomed. They will reappear when you return the screen to normal.

Switching camera angles

Some DVD discs feature scenes shot from two or more angles—check the disc box for details.

When a multi-angle scene is playing, a  icon appears on screen to let you know that other angles are available (this can be switched off if you prefer—see *Angle Indicator* on page 66).

- During playback (or when paused), press **ANGLE** to switch angle.

Displaying disc information

Various track, chapter and title information, as well as the video transmission rate for DVD discs, can be displayed on-screen while a disc is playing.

OSD disc information

- To show/switch the information displayed, press **DISPLAY**.

When a disc is playing, the information appears at the top of the screen. Keep pressing **DISPLAY** to change the displayed information.

- JPEG disc displays

TIGER_01 File name

ZOO_TRIP Folder name

Chapter 6

Viewing JPEG discs

Playing a JPEG slideshow

After loading a CD/CD-R/RW containing JPEG pictures, press ► to start a slideshow from the first folder/picture on the disc. The player displays the pictures in each folder in alphabetical order.

Pictures are automatically adjusted so that they fill as much of the screen as possible (if the aspect ratio of the picture is different to your TV screen you may notice black bars at the sides, or at the top and bottom of the screen).

While the slideshow is running:

Button	What it does
II	Pauses the slideshow; press again to restart.
◀◀	Displays the previous picture.
▶▶	Displays the next picture.
ANGLE	Pauses the slideshow and rotates the currently displayed picture 90° clockwise. Press ► (play) to restart slideshow.
ZOOM	Pauses the slideshow and zooms the screen (see below). Press ► (play) to restart slideshow.
DVD MENU	Displays the Disc Navigator screen (see below).
FOLDER +/ FOLDER -	Skips to the next/previous folder when playing a JPEG disc.



Note

- The **II**, **ANGLE** and **ZOOM** buttons do not work while the display shows **LOADING**.
- The time it takes for the player to load a file increases with large file sizes.
- Up to 999 files are viewable on a disc. If there are more files than this on a disc, only the first 999 files are viewable.

Using the JPEG Disc Navigator and Photo Browser

Use the JPEG Disc Navigator to find a particular folder or picture by filename on the disc in the play position; use the Photo Browser to find a picture within a folder by thumbnail image.

1 Press DVD MENU to display the Disc Navigator screen.

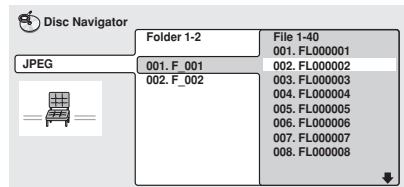

The left column shows the folders on the disc, the right column shows the files in a folder.

2 Use the cursor buttons (↑/↓/←/→) to navigate.

When a file is highlighted, a thumbnail image is displayed.

- When a folder is highlighted you can press **ENTER** to open the Photo Browser screen for that folder. See below for more on using the Photo Browser.

3 To resume the slideshow from the highlighted file, press **ENTER**.

Using the Photo Browser

The Photo Browser displays nine thumbnail images at a time from the current folder.

1 From the Disc Navigator screen, highlight a folder to display then press **ENTER**.

The Photo Browser screen opens with the first nine pictures displayed as thumbnails.

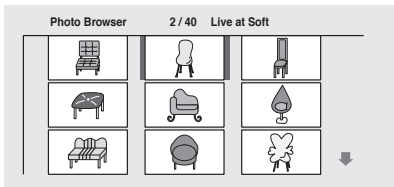

2 Use the cursor buttons (↑/↓/←/→) to highlight a thumbnail picture.

- Use the track skip buttons (⏮ and ⏭) to see the previous / next page of thumbnails. Keep the button pressed if you want to skip several pages; release when you reach the page you want.
- To return to the Disc Navigator screen, press **RETURN**.

3 Press **ENTER** to display the selected thumbnail full size on screen.

The slideshow resumes from the selected picture.

Zooming the screen

Using the zoom feature you can magnify a part of the screen by a factor of 2 or 4, while viewing pictures from a JPEG disc.

1 During slideshow playback, use the **ZOOM** button to select the zoom factor.

- Normal
- 2x
- 4x

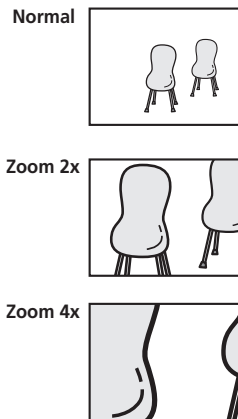

- The slideshow is paused when the screen is zoomed.
- Since JPEG pictures have a fixed resolution, picture quality may deteriorate, especially at 4x zoom. This is not a malfunction.

2 Use the cursor buttons (↑/↓/←/→) to change the zoomed area.

You can change the zoom factor and the zoomed area freely.

3 To resume the slideshow, press ► (play).

Chapter 7:

More tuner features: RDS

European model only

An introduction to RDS

Radio Data System, or RDS as it's usually known, is a system used by FM radio stations to provide listeners with various kinds of information—the name of the station and the kind of show they're broadcasting, for example. This information shows up as text on the display, and you can switch between the kind of information shown. Although you don't get RDS information from all FM radio stations, you do with most.

Probably the best feature of RDS is that you can search automatically by type of program. So, if you felt like listening to jazz, you could search for a station that's broadcasting a show with the program type, **Jazz**. There are around 30 such program types, including various genres of music, news, sport, talk shows, financial information, and so on.

The receiver lets you display three different kinds of RDS information: Radio Text, Program Service Name, and Program Type.

Radio Text (**RT**) is messages sent by the radio station. These can be anything the broadcaster chooses—a talk radio station might give out its telephone number as RT, for example.

Program Service Name (**PS**) is the name of the radio station.

Program Type (**PTY**) indicates the kind of program currently being broadcast.

The receiver can search for and display the following program types:

News – News

Affairs – Current affairs

Info – General information

Sport – Sport

Educate – Educational material

Drama – Radio plays or serials

Culture – National or regional culture, theatre, etc.

Science – Science and technology

Varied – Usually talk-based material, such as quiz shows or interviews.

Pop M – Pop music

Rock M – Rock music

Easy M – Easy listening music

Light M – 'Light' classical music

Classics – 'Serious' classical music

Other M – Other music not fitting any of the above categories

Weather – Weather reports

Finance – Stock market reports, commerce, trading, etc.

Children – Programs for children

Social – Social affairs

Religion – Programs concerning religion

Phone In – Public expressing their views by phone

Travel – Holiday-type travel rather than traffic announcements

Leisure – Leisure interests and hobbies

Jazz – Jazz

Country – Country music

Nation M – Popular music in a language other than English

Oldies – Popular music from the '50s and '60s

Folk M – Folk music

Document – Documentaries

In addition, there are three other program types, **TEST**, **Alarm!**, and **None**. **Alarm!** and **TEST** are used for emergency announcements. You can't search for these, but the tuner will switch automatically to this RDS broadcast signal. **None** appears when a program type cannot be found.

Displaying RDS information

Use the **DISPLAY** button to display the different types of RDS information available (**RT**, **PS** and **PTY**).

- **Press DISPLAY to select the RDS information display.**

Each press changes the display as follows:

- **RT** – Radio Text display
- **PS** – Program Service display
- **PTY** – Program Type display
- **PTY SEARCH** – see *Searching for RDS programs* below
- Current tuner frequency



Note

- If any noise is picked up while displaying the RT scroll, some characters may be displayed incorrectly.
- If you see **No Data** in the RT display, it means no RT data is transmitted from the broadcast station. If you have entered a name for the station, it is broadcast instead of RT data. If you haven't, the display will automatically switch to the PS data display. If no PS data is transmitted from the station, the frequency will be displayed.

- In the PTY display, there are cases where **No Data** or **None** is shown. If this happens, the PS display is shown after a few seconds.

Searching for RDS programs

One of the most useful features of RDS is the ability to search for a particular kind of radio program. You can search for any of the program types listed on the previous page.

- 1 Press the TUNER button to select the FM band.**

RDS is only possible in the FM band.

- 2 Press DISPLAY repeatedly until PTY SEARCH appears in the display.**

- 3 Use ←/→ (cursor left/right) to select the program type you want to hear.**

- 4 Press ENTER to search for the program type.**

The system starts searching through the station presets for a match. When it finds one, the search stops and the station plays for five seconds.

- 5 If you want to keep listening to the station, press ENTER within the 5 seconds.**

If you don't press **ENTER**, searching resumes.

Chapter 8

Using the timer

Setting the wake-up timer

Use the wake-up timer to set the system to switch on at any time and start playing whatever source you want.

**Important**

- The clock must be set to the correct time for the wake-up timer to work properly (see *Setting the clock* on page 20).

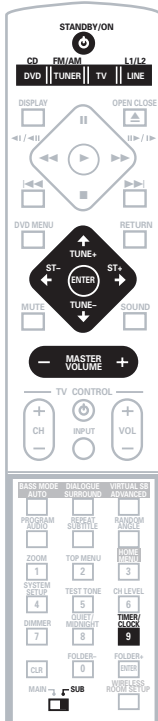
**1 Select the source you want played.**

For example, press **TUNER (FM/AM)** on the front panel to select the radio as your source.

2 Prepare the source.

For example, tune in the radio station you want to wake up to.

If you've selected a CD, make sure that it's stopped.

3 Set the volume.**4 Press TIMER/CLOCK twice to reach the timer menu.****5 Use the ←/→ (cursor left/right) buttons to select 'Wake-Up?' then press ENTER.****6 Use the ←/→ (cursor left/right) buttons to select 'TimerEdit' then press ENTER.****7 Set the switch-on time.**

Use the ↑/↓ (cursor up/down) buttons to set the hour, then press **ENTER**. Set the minute in the same way, pressing **ENTER** when you're done.

8 Set the switch-off time.

Use the ↑/↓ (cursor up/down) buttons to set the hour, then press **ENTER**. Set the minute in the same way, pressing **ENTER** when you're done.

After pressing **ENTER** this last time, the wake-up indicator lights, and the switch-on, switch-off times, the function (**DVD/CD**, etc.) and volume are confirmed in the display.

9 Switch the system into standby mode.

The wake-up timer will not work if the system is left on!



Tip

- You can check the timer settings in standby by pressing **TIMER/CLOCK** twice. (Press **TIMER/CLOCK** once to display the current time.)

Turning the wake-up timer on/off

If the wake-up timer is on, it will switch on the system everyday at the time you have set.

1 Press TIMER/CLOCK twice to reach the timer menu.

2 Use the ←/→ (cursor left/right) buttons to select 'Wake-Up?' then press ENTER.

3 Use the ←/→ (cursor left/right) buttons to select 'Timer On?' or 'Timer Off?'.

- You must have the timer set (see above) to select **ON**. The wake-up timer switches on and off according to your previous settings.

4 Press ENTER.



Note

- The wake-up timer will automatically be canceled if the clock is reset.

Setting the sleep timer

The sleep timer switches off the system after a specified time so you can fall asleep without worrying about it.



Important

- If you set the sleep timer while either the wake-up timer is active, the earlier switch off time takes priority.

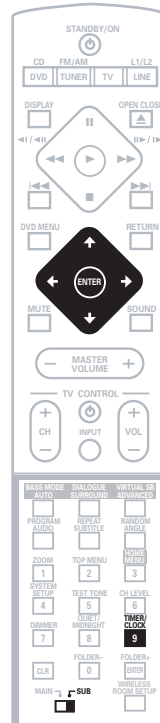

1 Press TIMER/CLOCK twice to reach the timer menu.

2 Use the ←/→ (cursor left/right) buttons to select 'Sleep?' then press ENTER.

3 Use the ↑/↓ (cursor up/down) buttons to select a switch-off time then press ENTER.

Choose between the following options:

- **Sleep Auto** – System switches off automatically after the currently playing CD, VCD or WMA/MP3 disc has finished.
- **Sleep 90** – System switches off after 90 minutes
- **Sleep 60** – System switches off after an hour
- **Sleep 30** – System switches off after 30 minutes
- **Sleep Off** – cancels the sleep timer

4 To check how much time is left, repeat steps 1 and 2.

The remaining time is displayed momentarily.



Note

- **Sleep Auto** will not work with VCDs during PBC playback or CDs in repeat play.

Chapter 9

Surround sound setup

Setting up surround sound

The Room Setup feature (page 21) is designed to give you a basic surround sound setup, however you can make the more detailed settings that may improve the surround sound in your listening room.

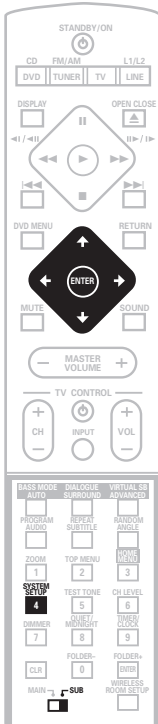

1 Press **SYSTEM SETUP**.

2 Use the **←/→ (cursor left/right)** buttons to choose the setting you want to adjust.

The current setting is shown for each option as you cycle through the display. See below for a full list and description of each.

3 Use the **↑/↓ (cursor up/down)** buttons to adjust the setting.

4 Repeat steps 2 and 3 to make other settings.

5 When you're done, press **ENTER** to leave the System Setup menu.



Note

- The System Setup menu is exited automatically after 5 minutes of inactivity.

System Setup menu options

Below are all the available settings in the setup menu. The first setting in each section is the default. See also the notes in each section for additional information about the settings.

Front speakers distance setting

Specifies the distance from your listening position to the front speakers:

- Front 0.3 m ~ Front 9 m** – Distance can be set in increments of 0.3 m. The default is 3 m.

Center speaker distance setting

Specifies the distance from your listening position to the center speaker:

- **Center 0.3 m ~ Center 9 m** – Distance can be set in increments of 0.3 m. The default is 3 m.

Surround speakers distance setting

Specifies the distance from your listening position to the front speakers:

- **Surr. 0.3 m ~ Surr. 9 m** – Distance can be set in increments of 0.3 m. The default is 3 m.

Dynamic Range Control

Specifies the amount of dynamic range adjustment to Dolby Digital or DTS soundtracks:

- **DRC Off** – No dynamic range adjustment (use when listening at higher volume)
- **DRC Mid** – Mid setting
- **DRC High** – Dynamic range is reduced (loud sounds are reduced in volume while quieter sounds are increased)



Note

- This setting works only with Dolby Digital and some DTS soundtracks. For other sources you can create a similar effect using the Midnight mode (see *Using Quiet and Midnight listening modes* on page 34).

Dual mono setting

Specifies how dual mono encoded Dolby Digital or DTS soundtracks should be played. You can also use this setting to switch the audio channel on DVD-RW discs recorded with two separate soundtracks.

- **L-Ch1 R-Ch2** – Both channels are played through the front speakers
- **Ch1 Mono** – Only channel 1 is played
- **Ch2 Mono** – Only channel 2 is played



Note

- On the **Ch1 Mono** and **Ch2 Mono** settings the sound comes only from the center speaker (or from the front speakers if listening in **STEREO** mode).
- This setting works only with dual mono encoded Dolby Digital or DTS soundtracks. See the disc packaging for channel information.

LFE attenuator setting

Dolby Digital and DTS audio sources include ultra-low bass tones. Set the LFE attenuator as needed to prevent the ultra-low bass from distorting the sound.

- **LFE ATT 0** – The LFE channel is played with no attenuation
- **LFE ATT 10** – LFE channel is attenuated by 10dB
- **LFE OFF** – LFE channel is not played

Setting the channel levels

You can set the relative channel levels from your main listening position for each listening mode, including all the Surround and Advanced Surround modes.

If you used the Room Setup feature (page 21), the channel levels for each listening mode will already be set. However, you can still fine-tune the levels here if you need to.

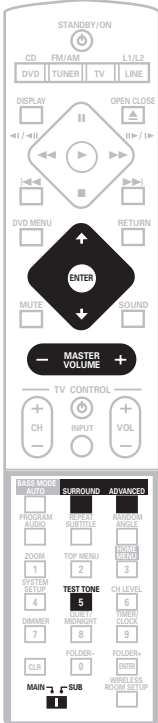

1 Press SURROUND or ADVANCED repeatedly to select a listening mode.

2 Switch the remote control to SUB, then press TEST TONE to hear the test tone.

The test tone is output in the following order (from the speakers active in the current listening mode):

- **L** – Front left speaker
- **C** – Center speaker
- **R** – Front right speaker
- **RS** – Right surround speaker
- **LS** – Left surround speaker
- **SW** – Subwoofer

3 Use the MASTER VOLUME +/- button to adjust the volume to an appropriate level.

4 Use the ↑/↓ (cursor up/down) buttons to adjust the speaker levels in turn.

You should hear the test tone at the same volume from each speaker when seated in the main listening position. The channel level range is ± 10 dB.

5 When you're done, press ENTER to exit test tone setup.



Tip

- The speaker volume can be adjusted while listening to any sound source you want by pressing **CH LEVEL** and then using the **↑/↓** (cursor up/down) buttons to adjust the channel levels. After you're finished with one channel, use the **←/→** (cursor left/right) buttons to move to the next.



Note

- Since the subwoofer produces ultra-low frequencies its sound may seem quieter than it actually is.

Chapter 10

Video Adjust menu

Video Adjust

- Default setting: **Standard**

From the Video Adjust screen you can select the standard video presentation or define presets of your own.

- 1 Press **HOME MENU** and select 'Video Adjust' from the on-screen display.

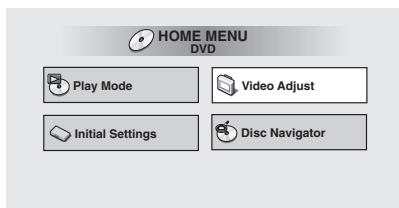

- 2 Use the **←/→** (cursor left/right) buttons to select a preset.

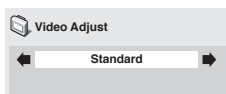

- **Standard** – Normal
- **Memory1–2** – Use for saving your own presets (see below)

- 3 Press **ENTER** to make the setting and exit the Video Adjust screen.

**Note**

- Depending on the disc and the TV/monitor, you may not see the effect clearly.

Creating your own presets

You can create up to three presets of your own.

- 1 Select one of the **Memory** presets (see above).
- 2 Press **↓** (cursor down) to select 'Detailed Settings' then press **ENTER**.

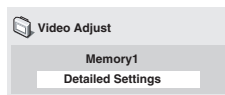

- 3 Adjust the picture quality settings.

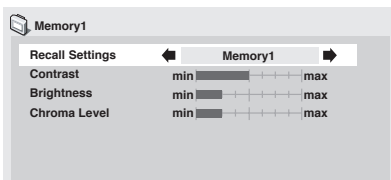

- Use the **↑/↓** (cursor up/down) buttons to select a setting.
- Use the **←/→** (cursor left/right) buttons to adjust the current setting.
- Press **DISPLAY** to switch between full and single view.
- You can change the preset number from the **Recall Settings** menu item.

You can adjust any or all of the following picture quality settings:

- **Contrast** – Adjusts the contrast between light and dark.
- **Brightness** – Adjusts the overall brightness.
- **Chroma Level** – Adjusts how saturated colors appear.

4 Press ENTER to save the preset and exit the Video Adjust screen.

Chapter 11

Initial Settings menu

Using the Initial Settings menu

The Initial Settings menu gives you complete control in setting up your DVD system, including video output settings and parental lock settings, among others.

If an option is grayed out it means that it cannot be changed at the current time. This is usually because a disc is playing. Stop the disc, then change the setting.

1 Press HOME MENU and select 'Initial Settings' from the on-screen display.

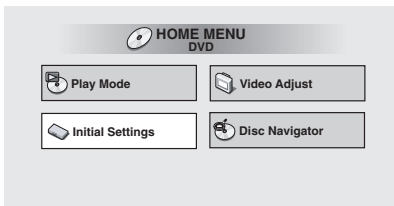

2 Select the setup category from the list on the left, then select an item from the menu list to the right.

3 Make the setting you want.



Note

- The language options shown in the on-screen display illustrations on the following pages may not correspond to those available in your country or region.

Video Output settings

TV Screen

- Default setting: **4:3 (Letter Box)**

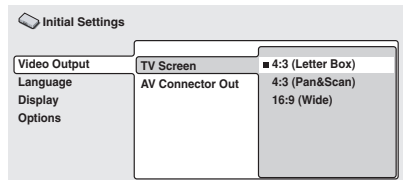

Illustration shows the European model

If you have a widescreen TV, select the **16:9 (Wide)** setting—widescreen DVD software is then shown using the full screen area. When playing software recorded in conventional (4:3) format, the settings on your TV will determine how the material is presented—see the manual that came with your TV for details on what options are available.

If you have a conventional TV, select either **4:3 (Letter Box)** or **4:3 (Pan & Scan)**. In Letter Box mode, widescreen software is shown with black bars at the top and bottom of the screen. Pan & Scan chops the sides off widescreen material to make it fit the 4:3 screen (so even though the image looks larger on the screen, you're actually seeing less of the picture). See also *Screen sizes and disc formats* on page 84.

AV Connector Out

European model only

You only need to make this setting if you connected this player to your TV using the AV SCART-type connector.

- Default setting: **Video**



Important

- If you make a setting here that is incompatible with your TV, the TV may not display any picture at all. If this happens switch everything off and reconnect to the TV using the supplied audio/video cable.
- SCART cables come in various configurations. Make sure you use the correct one for your TV/monitor. See page 74 for the SCART pin assignment diagram.

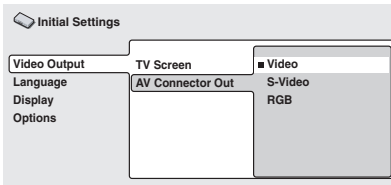

- **Video** – Standard video, compatible with all TVs.
- **S-Video** – Higher quality, but check your TV for compatibility.
- **RGB** – Best quality, but check your TV for compatibility.

Component Out

Not Applicable to the European model

You only need to make this setting if you connected this system to your TV using the component video outputs.

- Default setting: **Interlace**

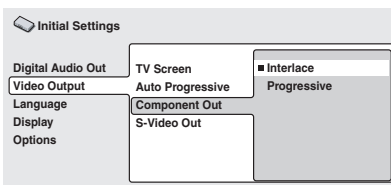

If you have a progressive-scan compatible TV, set this to **Progressive** for flicker-free video output. If your TV is not compatible with progressive-scan video, set to **Interlace**. Check the operating instructions that came with your TV if you're unsure about its compatibility.

When setting to **Progressive**, you have to press **ENTER** once more to confirm (or **RETURN** to cancel). See also below for important information on progressive scan video.

About progressive scan video

Compared to interlace video, progressive scan video effectively doubles the scanning rate of the picture, resulting in a very stable, flicker-free image. Progressive scan video is available only from the component video output.



Important

- *When TV format is set to **AUTO** or **NTSC** only:* When *Component Out* (above) is set to **Progressive**, there is no video output from the **VIDEO** and **S-VIDEO** jacks. If you want to display video on more than one monitor simultaneously, make sure that it is set to **Interlace**. See also *Setting the TV format* on page 75.
- If you connect a TV that is not compatible with a progressive scan signal and switch the system to progressive, you will not be able to see any picture at all. In this case, press **⏻ STANDBY/ON** to put the system in standby, then press and hold the front panel **■** (stop) button for about 8 seconds until the display shows **Mem.Clr.?**. Press the front panel **VOLUME – (DOWN)** or **+** (**UP**) button so that the display shows **Interlace?**. Press the front panel **▶/||** button to set to interlace and switch the system back on.

- When *TV format* is set to **AUTO** or **NTSC** only: When set to **Progressive**, PAL and NTSC discs are both output as progressive NTSC video. See page 75.
- When *TV format* is set to **PAL** only: **Progressive** cannot be selected. See page 75.

Compatibility of this system with progressive-scan TVs.

This system is compatible with progressive video Macro Vision System Copy Guard.

CONSUMERS SHOULD NOTE THAT NOT ALL HIGH DEFINITION TELEVISION SETS ARE FULLY COMPATIBLE WITH THIS PRODUCT AND MAY CAUSE ARTIFACTS TO BE DISPLAYED IN THE PICTURE. IN CASE OF 525 PROGRESSIVE SCAN PICTURE PROBLEMS, IT IS RECOMMENDED THAT THE USER SWITCH THE CONNECTION TO THE "STANDARD DEFINITION" OUTPUT. IF THERE ARE QUESTIONS REGARDING OUR TV SET COMPATIBILITY WITH THIS MODEL 525p DVD PLAYER, PLEASE CONTACT OUR CUSTOMER SERVICE CENTER.

This system is compatible with the following Pioneer displays and monitors: PDP-503HDG, PDP-433HDG progressive scan-compatible TVs.

S-Video Out

Not Applicable to the European model

You only need to make this setting if you connected this system to your TV using an S-video cable.

- Default setting: **S2**

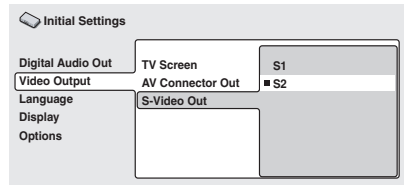

- If you find that the picture is stretched or distorted on the default **S2** setting, try changing it to **S1**.

Language settings

Audio Language

- Default setting: **English**

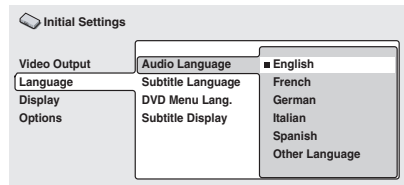

This setting is your preferred audio language for DVD discs. If the language you specify here is recorded on a disc, the system automatically plays the disc in that language.

The DVD format recognizes 136 different languages. Select **Other Language** if you want to specify a language other than those listed. See also *Selecting languages using the language code list* on page 84.



Tip

- You can switch between the languages recorded on a DVD disc during playback using the **AUDIO** button. (This does not affect this setting.) See *Switching the DVD audio language* on page 46.
- Some DVD discs set the audio language automatically when loaded, overriding the **Audio Language** setting.
- Discs with two or more audio languages usually allow you to select the audio language from the disc menu. Press **DVD MENU** to access the disc menu.

Subtitle Language

- Default setting: **English**

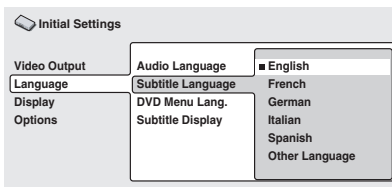

This setting is your preferred subtitle language for DVD discs. If the language you specify here is recorded on a disc, the system automatically plays the disc with those subtitles.

The DVD format recognizes 136 different languages. Select **Other Language** if you want to specify a language other than those listed. See also *Selecting languages using the language code list* on page 84.



Tip

- You can usually change or switch off the subtitles on a DVD disc during playback using the **SUBTITLE** button. (This does not affect this setting.) See *Switching subtitles* on page 46.
- Some DVD discs set the subtitle language automatically when loaded, overriding the **Subtitle Language** setting.
- Discs with two or more subtitle languages usually allow you to select the subtitle language from the disc menu. Press **DVD MENU** to access the disc menu.

DVD Menu Language

- Default setting: **w/Subtitle Lang.**

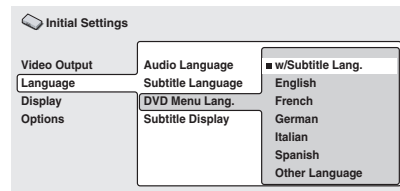

Some multilingual discs have disc menus in several languages. This setting specifies in which language the disc menus should appear. Leave on the default setting for menus to appear in the same language as your **Subtitle Language**—see above.

The DVD format recognizes 136 different languages. Select **Other Language** if you want to specify a language other than those listed. See also *Selecting languages using the language code list* on page 84.

Subtitle Display

- Default setting: **On**

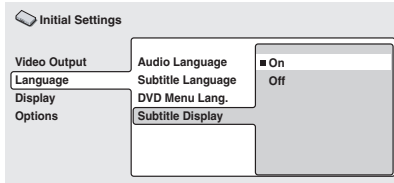

When set to **On**, the player displays subtitles according to the **Subtitle Language** setting. Set to **Off** to switch subtitles off altogether.

Display settings

OSD Language

- Default setting: **English**

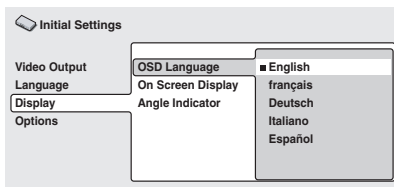

This sets the language of this system's on-screen displays.

On Screen Display

- Default setting: **On**

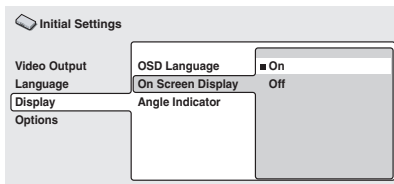

This sets whether operation displays are shown on-screen (**Play, Resume, Scan** and so on).

Angle Indicator

- Default setting: **On**

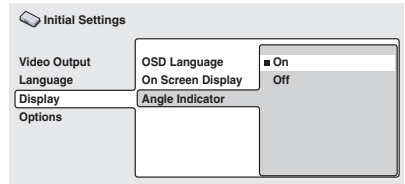

If you prefer not to see the camera icon on-screen during multi-angle scenes on DVD discs, change this setting to **Off**.

Options

Parental Lock

- Default level: **Off**
- Default password: *none*
- Default Country code: **us (2119)**

Some DVD-Video discs feature a Parental Lock level. If the player is set to a lower level than the disc, the disc won't play. This gives you some control about what your children watch on your DVD system.

Some discs also support the Country code feature. The player does not play certain scenes on these discs, depending on the Country code you set.

Before you can set the Parental Lock level or the Country code you must register a password. As the password owner, you can change the Parental Lock level or Country code whenever you like. You can also change the password.



Note

- Not all discs that you may consider inappropriate for your children use the Parental Lock feature. These discs will always play without requiring the password first.
- If you forget your password, you'll need to reset the system to its factory settings (see *Resetting the system* on page 76), then register a new password.

Registering a new password

You must register a password before you can change the Parental Lock level or enter a Country code.

1 Select 'Password'.

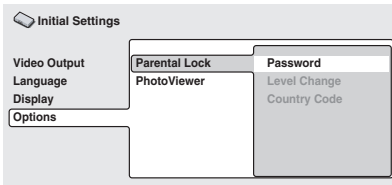

2 Use the number buttons to enter a 4-digit password.

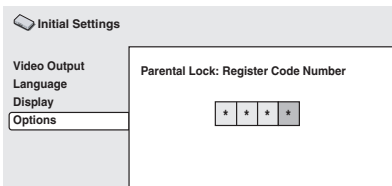

The numbers you enter show up as asterisks (*) on-screen.

3 Press ENTER to register the password and return to the Options menu screen.

If you forget your password, you can reset the system then register a new one. See *Resetting the system* on page 76 for how to reset the system.

Changing your password

To change your password, confirm your existing password then enter a new one.

1 Select 'Password Change'.

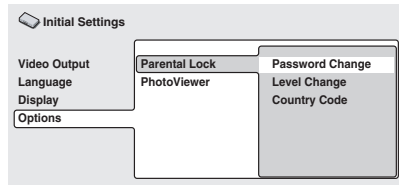

2 Use the number buttons to enter your existing password, then press ENTER.

The numbers appear as asterisks as you enter them.

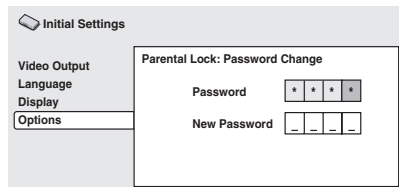

3 Enter a new password.

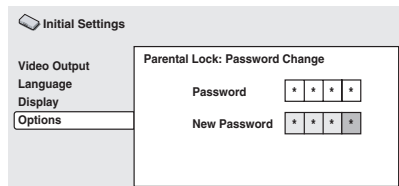

- Press ENTER to register the new password and return to the Options menu screen.

Setting/changing the Parental Lock level

- Select 'Level Change'.

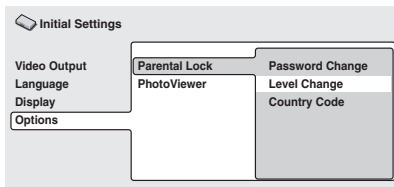

- Use number buttons to enter your password, then press ENTER.

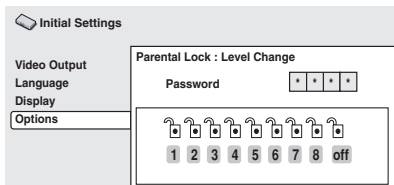

- Select a new level.

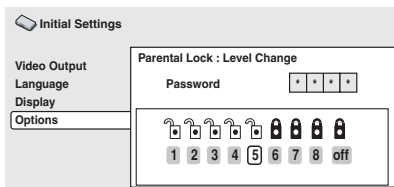

Press ← (cursor left) repeatedly to lock more levels (more discs will require the password); press → (cursor right) to unlock levels. You can't lock level 1.

- Press ENTER to set the new level and return to the Options menu screen.

Setting/changing the Country code

You may also want to refer to the *Country code list* on page 85.

- Select 'Country Code'.

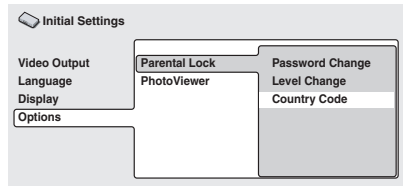

- Use number buttons to enter your password, then press ENTER.

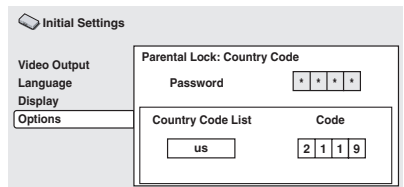

- Select a Country code.

There are two ways you can do this.

- Select by code letter: Use ↑/↓ (cursor up/down) to change the Country code.

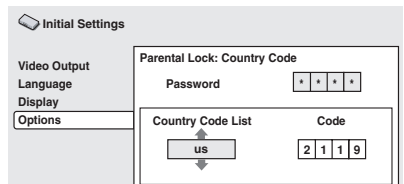

- Select by code number: Press **→** (cursor right) then use the number buttons to enter the 4-digit Country code (you can find the *Country code list* on page 85.)

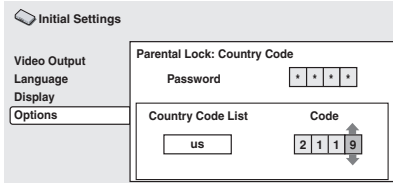

4 Press ENTER to set the new Country code and return to the Options menu screen.



Note

- Changing the Country code does not take effect until the next disc is loaded (or the current disc is reloaded).

PhotoViewer

- Default setting: **On**

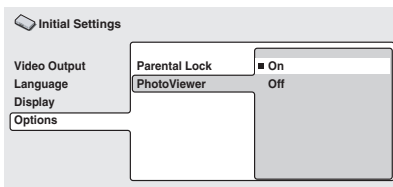

This setting is important if you load a disc that contains both WMA/MP3 audio files and JPEG picture files.

The default **On** setting allows you to view only the JPEG files on this kind of disc. Set to **Off** to be able to play the WMA/MP3 audio files.



Note

- Changing the PhotoViewer setting does not take effect until the next disc is loaded (or the current disc is reloaded).

Chapter 12

Other connections

Connecting the wireless speaker system

Connect the **WIRELESS (IN)** jack on the transmitter to the **WIRELESS (OUT)** jack on the rear panel of the receiver using a 2-pin RCA cable, then connect to a power outlet using the supplied AC adaptor.

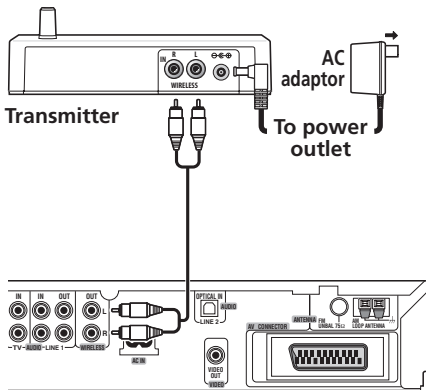

XV-DV515 DVD/CD Receiver

Illustration shows the European model

**Note**

- When connecting, make sure both units are switched off and unplugged.
- See *Wireless speaker system* on page 17 for more on using the XW-DV515 speaker unit.

Connecting external antennas

External AM antenna

Use 5–6 meters of vinyl-insulated wire and set up either indoors or outdoors. Leave the AM loop antenna connected.

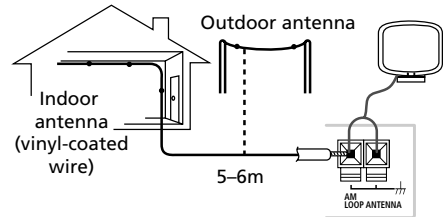
**External FM antenna**

Use a PAL connector (European model) or a 75Ω coaxial cable (all other models) to hook up an external FM antenna.

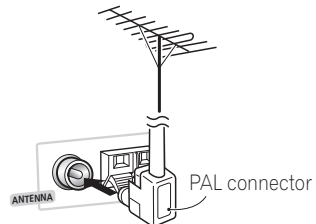
European model

All other models

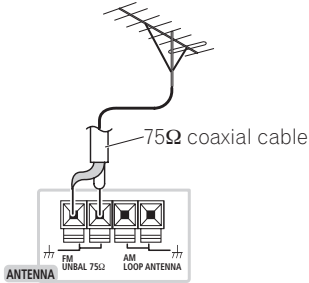

Connecting auxiliary components

This system has both stereo analog inputs and outputs, as well as an optical digital input. Use these to connect external components, such as your VCR, MD or CD-R recorder.

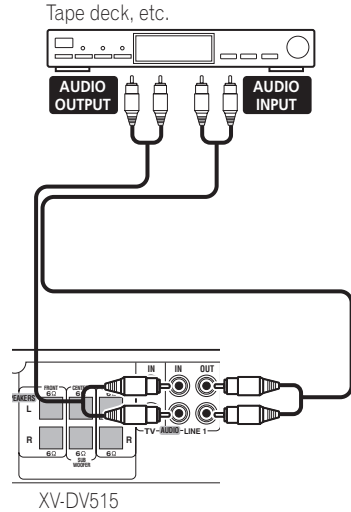
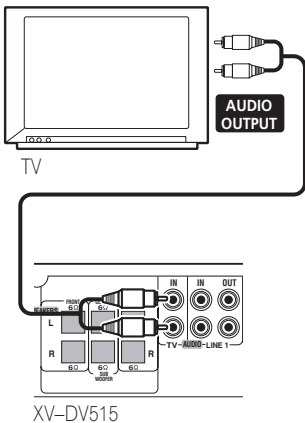

- **Connect the LINE 1 (IN) jacks to the analog outputs of an external playback component.**

These include components such as a VCR or cassette deck. Connect using RCA pin-plug stereo cables. See also *Reducing the TV and line signal levels* below.

- **Connect the LINE 1 (OUT) jacks to the analog inputs of an external recording component.**

These include components such as a cassette deck, VCR, MD or another recorder with analog inputs. Connect using RCA pin-plug stereo cables.

- **Connect the TV (IN) jacks to the audio outs of your TV (or VCR).**

This will enable you to hear the TV (or VCR) through this system. Connect using RCA pin-plug stereo cables. See also *Reducing the TV and line signal levels* below.

- Connect the **LINE 2 (OPTICAL IN)** jack on the rear panel to the optical digital output of an external playback component.

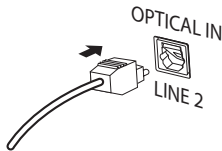

These include digital components such as an MD player, digital satellite, or a game system. Connect using a optical digital cable (not supplied).

Reducing the TV and line signal levels

- Default setting: **ATT 6dB**

Some sources may produce a high signal level which may produce unpleasant distortion from the speakers. In such cases, you may need to reduce the signal level of the auxiliary source (connected to the **TV** or **LINE 1** analog inputs) by switching on the attenuator.

- 1 **Switch the system into standby.**
- 2 **Press SYSTEM SETUP.**
- 3 **Use the ←/→ (cursor left/right) buttons to select 'TV ATT?' or 'LINE1 ATT?', then press ENTER.**
- 4 **Use the ↑/↓ (cursor up/down) buttons to select 'ATT Off', 'ATT 6dB' or 'ATT 10dB'.**

If the **ATT 6dB** setting still results in distorted sound, try the **ATT 10dB** setting.

- 5 **Press ENTER to confirm.**

Recording mode

The Recording mode allows you to make analog recordings from the **LINE 1 (OUT)** jacks.

When Recording mode is on, most sound-related functions (including **SURROUND, ADVANCED, AUTO, SYSTEM SETUP**) become inactive. The display will briefly blink **RecMode On** if you try and use a prohibited function while Recording mode is on.

When Recording mode is off, the audio from the analog output may be interrupted, depending on the operation.

- 1 **Press SOUND.**
- 2 **Use the ←/→ (cursor left/right) buttons to select 'Rec Mode?'.**
- 3 **Press ENTER.**
- 4 **Use the ↑/↓ (cursor up/down) buttons to select 'R.Mode On' or 'R.Mode Off'.**

Connecting using the S-video output

Not applicable to the European model

If your TV has an S-video input, you can use this instead of the standard video output for a better quality picture.

- Use an S-video cable (not supplied) to connect the S-VIDEO OUT to an S-video input on your TV.

Line up the small triangle above the jack with the same mark on the plug before plugging in.

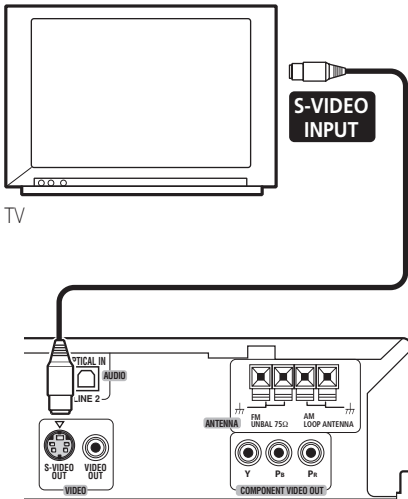

XV-DV515



Note

- The S-video output is switchable between S1 and S2 formats for compatibility with all TVs. See *S-Video Out* on page 64 for more on this.

Connecting using the component video output

Not applicable to the European model

If your TV has component video inputs, you can use these instead of the standard video output to connect this system to your TV. This should give you the best quality picture from the three types of video output available.

- Use a component video cable (not supplied) to connect the COMPONENT VIDEO OUT to a set of component inputs on your TV.

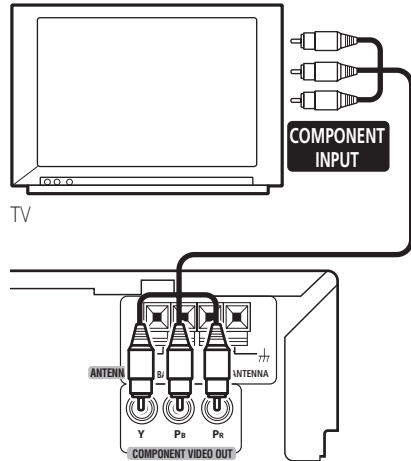

XV-DV515



Note

- The component video output is switchable between interlaced and progressive formats. See *Component Out* on page 63 for more on this.

Using the SCART AV output

European model only

There are two different kinds of video outputs you can use to connect this system to your TV. The SCART output should give you better picture quality than the standard composite video output. The SCART AV connector functions as both a video and audio output.

- Use a commercially available SCART cable to connect the AV CONNECTOR to your TV.

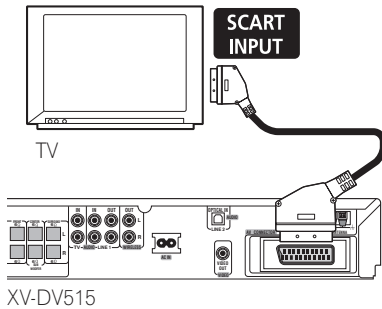

Note

- SCART cables are available in several configurations. Make sure that the one you get will work with this system and your TV/monitor. You can find the pin assignments below.

Switching the TV audio input from SCART to RCA

You can set the TV audio input to RCA or SCART.

- 1 Press **TV**.
- 2 Press **SYSTEM SETUP**.
- 3 Use the **←/→** (cursor left/right) buttons to select 'TV Audio?'
- 4 Press **ENTER**.
- 5 Use the **↑/↓** (cursor up/down) buttons to select **SCART** or **RCA**.
- 6 Press **ENTER**

SCART pin assignment

The diagram below shows the SCART 21-pin connector assignment. This connector provides the video and audio signals for connection to a compatible colour TV or monitor.

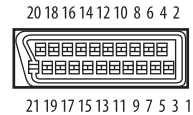

Pin No.	Assignment	Pin No.	Assignment
1	Audio R OUT	12	No connection
2	Audio R IN	13	GND (video)
3	Audio L OUT	14	GND (video)
4	GND (audio)	15	R or C OUT
5	GND (video)	16	BLANK OUT
6	Audio L IN	17	GND (video)
7	B OUT	18	GND (video)
8	Status	19	Video or Y OUT
9	GND (video)	20	No connection
10	No connection	21	GND (video)
11	G OUT		

Chapter 13

Additional information

Switching off the demo

- Default setting: **Demo On**

This system has an automatic demo feature that starts when the system is plugged in for the first time.

- 1 **Switch the system into standby.**
- 2 **Press SYSTEM SETUP.**
- 3 **Use the ←/→ (cursor left/right) buttons to select 'Demo Mode?', then press ENTER.**
- 4 **Use the ↑/↓ (cursor up/down) buttons to select 'Demo Off?' then press ENTER to confirm.**



Note

- After setting the clock, the demo mode switches off automatically. However, if you unplug the system from the wall outlet, the demo mode will revert to **Demo On** (and the clock will be reset).

Child Lock

- Default setting: **Lock Off**

This system has a child lock feature that makes the front panel buttons and controls inoperative. This is useful when you've set the wake-up timer and don't want the system switched on before it activates.

- 1 **Switch the system into standby.**
- 2 **Press SYSTEM SETUP.**
- 3 **Use the ←/→ (cursor left/right) buttons to select 'Child Lock?', then press ENTER.**

- 4 **Use the ↑/↓ (cursor up/down) buttons to select 'Lock On?' or 'Lock Off?'.**
- 5 **Press ENTER to confirm.**

Changing the clock format

- Default setting: **12-Hour**

You can choose to display the clock in either 12 or 24 hour formats.

- 1 **Switch the system into standby.**
- 2 **Press SYSTEM SETUP.**
- 3 **Use the ←/→ (cursor left/right) buttons to select '12/24 Hour?', then press ENTER.**
- 4 **Use the ↑/↓ (cursor up/down) buttons to select either '12-Hour?' or '24-Hour?'.**
- 5 **Press ENTER to confirm.**

Setting the TV format

- Default setting: **AUTO**

The default setting of this system is **AUTO**, and unless you notice that the picture is distorted when playing some discs, you should leave it set to **AUTO**. If you experience picture distortion with some discs, set the TV system to match your country or region's system. Doing this, however, may restrict the kinds of disc you can watch. The table below shows what kinds of disc are compatible with each setting (**AUTO**, **PAL** and **NTSC**).

- 1 Switch the system into standby.
- 2 Press **SYSTEM SETUP**.
- 3 Use the **←/→** (cursor left/right) buttons to select 'TV System?', then press **ENTER**.
- 4 Use the **↑/↓** (cursor up/down) buttons to select Auto, PAL or NTSC, then press **ENTER** to confirm.

Disc Type	Format	Player setting		
		NTSC	PAL	AUTO
DVD	NTSC	NTSC	MOD.PAL	NTSC
/Super VCD	PAL	NTSC	PAL	PAL
Video CD	NTSC	NTSC	MOD.PAL	NTSC
	PAL	NTSC	PAL	PAL
CD/no disc	—	NTSC	PAL	NTSC or PAL

Watching NTSC on a PAL TV (MOD. PAL)

Most models of the newly developed count-down PAL TV system detect 50 Hz (PAL)/60 Hz (NTSC) and automatically switch vertical amplitude, resulting in a display without vertical shrinkage. However, in some cases, the image may appear without color.

If your PAL TV does not have a V-Hold control, you may not be able to watch NTSC discs because of picture roll. If the TV has a V-Hold control, adjust it until the picture stops rolling.

On some TVs, the picture may shrink vertically, leaving black bands at the top and bottom of the screen. This is not a malfunction; it is caused by the NTSC to PAL conversion.

Changing the frequency step

Not applicable to the European model

- Default setting: **AM 9/FM 50**

If you find that you can't tune into stations successfully, the frequency step may not be suitable for your country/region.

- 1 Switch the system into standby.
- 2 Press **SYSTEM SETUP**.
- 3 Use the **←/→** (cursor left/right) buttons to select 'FM AM Step?', then press **ENTER**.
- 4 Use the **↑/↓** (cursor up/down) buttons to select 'FM 50 AM 9?' or 'FM100 AM10?' then press **ENTER** to confirm.

Resetting the system

Use this procedure to reset all system settings to the factory default.

- 1 Switch the system into standby.
- 2 Press and hold the front panel **■** (stop) button for about 8 seconds until the display shows 'Mem.Clr.?'.
- 3 Press the front panel **▶/||** button. All the system's settings are now reset, and you should see the 'Let's Get Started' screen.

Using and taking care of discs

Titles, chapters and tracks

DVD discs are generally divided into one or more titles. Titles may be further subdivided into chapters.

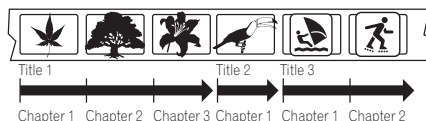

CDs and Video CDs are divided into tracks.

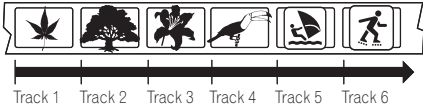

CD-ROMs contain folders and files. MP3 and WMA files are referred to as tracks. Folders may contain further folders.

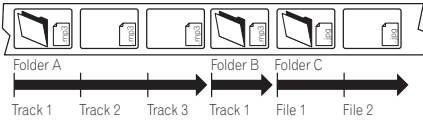

DVD Video regions

All DVD Video discs carry a region mark on the case somewhere that indicates which region(s) of the world the disc is compatible with. Your DVD system also has a region mark, which you can find on the rear panel. Discs from incompatible regions will not play in this player. Discs marked **ALL** will play in any player.

The diagram below shows the various DVD regions of the world.

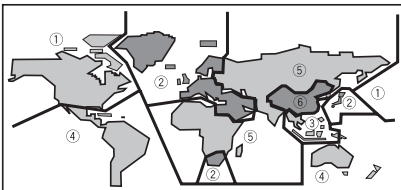

Handling discs

When holding discs of any type, take care not to leave fingerprints, dirt or scratches on the disc surface. Hold the disc by its edge or by the center hole and edge.

Damaged or dirty discs can affect playback performance. Take care also not to scratch the label side of the disc. Although not as fragile as the recorded side, scratches can still result in a disc becoming unusable.

Should a disc become marked with fingerprints, dust, etc., clean using a soft, dry cloth, wiping the disc lightly from the center to the outside edge as shown in the diagram below.

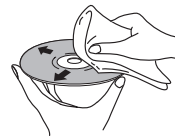

Wipe lightly from the center of the disc using straight strokes.



Don't wipe the disc surface using circular strokes.

If necessary, use a cloth soaked in alcohol, or a commercially available CD/DVD cleaning kit to clean a disc more thoroughly. Never use benzine, thinner or other cleaning agents, including products designed for cleaning vinyl records.

Storing discs

Although CDs and DVD discs are more durable than vinyl records, you should still take care to handle and store discs correctly. When you're not using a disc, return it to its case and store upright. Avoid leaving discs in excessively cold, humid, or hot environments (including under direct sunlight).

Don't glue paper or put stickers onto the disc, or use a pencil, ball-point pen or other sharp-tipped writing instrument. These could all damage the disc.



For more detailed care information see the instructions that come with discs.

Do not load more than one disc into the player at a time.

Discs to avoid

Discs spin at high speed inside the player. If you can see that a disc is cracked, chipped, warped, or otherwise damaged, don't risk using it in your player—you could end up damaging the unit.

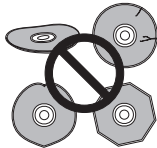

This unit is designed for use with conventional, fully circular discs only. Use of shaped discs is not recommended for this product. Pioneer disclaims all liability arising in connection with the use of shaped discs.

Proper installation and maintenance of this system

Hints on installation

We want you to enjoy using this system for years to come, so please bear in mind the following points when choosing a suitable location for it:

Do...

- ✓ Use in a well-ventilated room.

- ✓ Place on a solid, flat, level surface, such as a table, shelf or stereo rack.

Don't...

- ✗ Use in a place exposed to high temperatures or humidity, including near radiators and other heat-generating appliances.
- ✗ Place on a window sill or other place where the system will be exposed to direct sunlight.
- ✗ Use in an excessively dusty or damp environment.
- ✗ Place directly on top of an amplifier, or other component in your stereo system that becomes hot in use.
- ✗ Use near a television or monitor as you may experience interference—especially if the television uses an indoor antenna.
- ✗ Use in a kitchen or other room where the system may be exposed to smoke or steam.
- ✗ Use on a thick rug or carpet, or cover with cloth—this may prevent proper cooling of the system.
- ✗ Place on an unstable surface, or one that is not large enough to support all four of the unit's feet.

Cleaning the pickup lens

The DVD player's lens should not become dirty in normal use, but if for some reason it should malfunction due to dust or dirt, consult your nearest Pioneer authorized service center. Although lens cleaners are commercially available, we do not recommend using them since some may damage the lens.

Problems with condensation

Condensation may form inside the player if it is brought into a warm room from outside, or if the temperature of the room rises quickly. Although the condensation won't damage the player, it may temporarily impair its performance. For this reason you should leave it to adjust to the warmer temperature for about an hour before switching on and using.

Moving the system unit

If you need to move the main unit, first remove a disc if there's one in the player, then press **⏻ STANDBY/ON** on the front panel to turn the system off. Wait for **Good Bye** to disappear from the display, then unplug the power cable. Never lift or move the unit during playback—discs rotate at a high speed and may be damaged.



Note

- Unplugging the unit before **Good Bye** disappears from the display may cause the system to return to the factory settings.

Power cord caution

Handle the power cord by the plug. Do not pull out the plug by tugging the cord and never touch the power cord when your hands are wet as this could cause a short circuit or an electric shock. Do not place this unit, a piece of furniture, etc., on the power cord, or pinch the cord. Never make a knot in the cord or tie it with other cords. The power cords should be routed such that they are not likely to be stepped on. A damaged power cord can cause a fire or give you an electrical shock.

Check the power cord once in a while. When you find it damaged, ask your nearest Pioneer authorized service center or your dealer for a replacement.

Wireless speaker system AC adaptor and power cord caution

- Do not leave the power cord near heating equipment. The coating of the cord may melt, which could lead to fire and/or electrocution.
- Make sure to grasp the body of the AC adaptor when removing it from the power outlet. If you pull the power cord, it may become damaged which could lead to fire and/or electrocution.
- Do not attempt to plug in or remove the AC adaptor with wet hands. This may result in electrocution.
- Insert the prongs of the AC adaptor all the way into the power outlet. If the connection is incomplete, heat may be generated which could lead to fire. Furthermore, contact with the connected prongs of the adaptor may result in electrocution.
- Do not insert the AC adaptor into a power outlet where the connection remains loose despite inserting the prongs all the way into the outlet. Heat may be generated which could lead to fire. Consult with the retailer or an electrician regarding replacement of the power outlet.
- Even when not in use, the fan in the wireless speaker will continue to operate. Switching off the wireless speaker when not in use will increase product life.

Troubleshooting

Incorrect operations are often mistaken for trouble and malfunctions. If you think that there is something wrong with this component, check the points below. Sometimes the trouble may lie in another component. Investigate the other components and electrical appliances being used. If the trouble cannot be rectified even after exercising the checks listed below, ask your nearest Pioneer authorized service center or your dealer to carry out repair work.



Important

- If the system does not operate normally due to external effects such as static electricity disconnect the power plug from the outlet and insert again to return to normal operating conditions.

General

Problem	Remedy
The power does not turn on.	<ul style="list-style-type: none"> • Connect the power plug to the wall outlet. • Disconnect the power plug from the outlet, and insert again. • Make sure there are no loose strands of speaker wire touching the rear panel. This could cause the system to shut off automatically.
No sound is output when a function is selected.	<ul style="list-style-type: none"> • If you're using the line input, make sure the component is connected correctly (see <i>Connecting auxiliary components</i> on page 71). • Press MUTE on the remote control to turn muting off. • Adjust the VOLUME. • <i>European model only:</i> If you're using the TV input, make sure you've selected the RCA audio input (see <i>Switching the TV audio input from SCART to RCA</i> on page 74).
No image is output when playing discs.	<ul style="list-style-type: none"> • Make sure the TV is connected correctly (refer to the Setup Guide). • <i>Not applicable to the European model:</i> Reset the video output to interlace (see <i>Component Out</i> on page 63).
No sound from surround or center speakers.	<ul style="list-style-type: none"> • Refer to <i>Setting the channel levels</i> on page 59 to check the speaker levels. • Check that you haven't selected the STEREO sound mode (see <i>Listening in surround sound</i> on page 31). • Check that the Virtual mode is not on (<i>Using the Advanced Surround effects</i> on page 33). • Connect the speakers properly (refer to the Setup Guide).
Can't operate the remote control.	<ul style="list-style-type: none"> • Replace the batteries (refer to the Setup Guide). • Operate within 7 m, 30° of the remote sensor on the front panel (refer to the Setup Guide). • Remove any obstacles or operate from another position. • Avoid exposing the remote sensor on the front panel to direct light.

Problem	Remedy
Timer indicator is blinking and the system will not switch on.	<ul style="list-style-type: none"> • Unplug the unit, then plug back in. Wait for one minute then switch on. • Make sure the fan at the rear of the unit is not being blocked. • Check that the speakers are connected correctly. • Make sure the voltage of the mains power source is correct for the model. • If the problem persists, take it to your nearest Pioneer authorized service center or your dealer for servicing.

DVD/CD/Video CD player

Problem	Remedy
The disc is ejected automatically after loading.	<ul style="list-style-type: none"> • Clean the disc. • Align the disc properly in the disc guide. • If the region number on a DVD-video disc does not match the number on the player, the disc cannot be used (see <i>DVD Video regions</i> on page 77). • Allow time for any condensation inside the player to evaporate. Avoid using the player near an air-conditioning unit.
Playback is not possible.	<ul style="list-style-type: none"> • If the disc is loaded upside down, reload the disc with the label side face up.
Picture playback stops and the operation buttons cannot be used.	<ul style="list-style-type: none"> • Press ■ (stop), then ▶ (play) to start playback again. • Switch the power off once, then on again using the front panel ⏻ STANDBY/ON button.
Settings are canceled.	<ul style="list-style-type: none"> • When the power is cut due to power failure or by unplugging the power cable, settings will be canceled.
No picture/No color.	<ul style="list-style-type: none"> • Check that connections are correct and that plugs are inserted fully. • Check the instruction manual of the TV/monitor to make sure the TV/monitor settings are incorrect.
Screen is stretched or aspect does not change.	<ul style="list-style-type: none"> • The TV Screen setting is incorrect. Set the TV Screen option to match the TV/monitor you're using (see <i>TV Screen</i> on page 62).
When recorded on a VCR or passed through an AV selector, there is disturbance in the playback picture.	<ul style="list-style-type: none"> • This system uses copy-protection technology which may prevent recording or cause picture problems when connected through a VCR or AV selector. This is not a malfunction.
CD won't play	<ul style="list-style-type: none"> • Set the PhotoViewer menu option in the Initial Settings menu to Off to be able to play some copy-protected CDs. See also <i>PhotoViewer</i> on page 69.

Problem	Remedy
Picture disturbance during playback or dark.	<ul style="list-style-type: none"> • This player is compatible with Macro-Vision System copy guard. Some discs include a copy prevention signal, and when this type of disc is played back, stripes etc., may appear on some sections of the picture depending on the TV. This is not a malfunction. • Discs respond differently to particular player functions. This may result in the screen becoming black for a brief instant or shaking slightly when the function is executed. These problems are largely due to differences between discs and disc content and are not malfunctions of this player.
Noticeable difference in DVD and CD volume.	<ul style="list-style-type: none"> • DVDs and CDs use different recording methods. This is not a malfunction.

WMA/MP3/JPEG discs

Problem	Remedy
CD-ROM disc is not recognized by the system.	<ul style="list-style-type: none"> • Make sure that the CD-ROM was recorded using the ISO 9660 disc format. See <i>General disc compatibility</i> on page 8 for other disc compatibility information.
Files don't show up in the Disc Navigator/Photo Browser.	<ul style="list-style-type: none"> • The files on the disc must be named with the correct file extension: .mp3 for MP3 files; .wma for WMA files; .jpg for JPEG files (upper or lower-case is OK). See <i>General disc compatibility</i> on page 8 for other disc compatibility information.
Can play JPEG files, but not WMA/MP3 files on the same disc (or vice versa).	<ul style="list-style-type: none"> • Set the PhotoViewer menu option in the Initial Settings menu to Off to be able to access the WMA/MP3 files. Set to On to be able to play the JPEG files. See <i>PhotoViewer</i> on page 69.

Tuner

Problem	Remedy
Considerable noise in radio broadcasts.	<ul style="list-style-type: none"> • Tune into the correct frequency. • Connect the antenna (refer to the Setup Guide). • Fully extend the FM wire antenna, position for best reception, and secure to a wall. • Connect an outdoor FM antenna (see <i>Connecting external antennas</i> on page 70). • Adjust the direction and position for best reception. • Connect an additional internal or external AM antenna (refer to the Setup Guide and <i>Connecting external antennas</i> on page 70). • Turn off any other equipment that may be causing the noise or move it away from the main unit. • The tuning interval is incorrect for your country or region. Try switching the tuning interval (see <i>Changing the frequency step</i> on page 76).
Auto tuning does not pick up some stations.	<ul style="list-style-type: none"> • The radio signal is weak. Auto tuning will only detect radio stations with a good signal. For more sensitive tuning, connect an outdoor antenna.
Sound is mono only.	<ul style="list-style-type: none"> • Check that the tuner is not set to FM mono (see <i>Improving poor FM reception</i> on page 29).

Error Messages

Message	Description
Child Lock	<ul style="list-style-type: none"> • This message appears when the front panel buttons are pressed when the child lock feature is active. See <i>Child Lock</i> on page 75 for more on switching on/off the child lock.
Rec Mode On	<ul style="list-style-type: none"> • Blinks rapidly for 2 seconds when an operation is prohibited because the Recording Mode is on (see <i>Recording mode</i> on page 72).
Phones In	<ul style="list-style-type: none"> • Blinks rapidly for 2 seconds when an operation is prohibited because headphones are connected.
96K Stereo	<ul style="list-style-type: none"> • Blinks rapidly for 2 seconds when an operation is prohibited because the source is digital 88.2 or 96kHz PCM.
No Surr. SP	<ul style="list-style-type: none"> • Blinks rapidly for 2 seconds when an operation is prohibited because there is no surround speaker output.
Muting	<ul style="list-style-type: none"> • Blinks rapidly for 2 seconds when an operation is prohibited because the sound is muted (see <i>Muting the sound</i> on page 36).
Exit	<ul style="list-style-type: none"> • Appears briefly when a menu is automatically exited after a set period of inactivity.

Screen sizes and disc formats

DVD-Video discs come in several different screen aspects, ranging from TV programs, which are generally 4:3, to CinemaScope widescreen movies, with an aspect ratio of up to about 7:3.

Televisions also come in different aspect ratios; 'standard' 4:3 and widescreen 16:9.

Widescreen TV users

If you have a widescreen TV, the **TV Screen** setting (page 62) of this system should be set to **16:9 (Wide)**.

When you watch discs recorded in 4:3 format, you can use the TV controls to select how the picture is presented. Your TV may offer various zoom and stretch options; see the instructions that came with your TV for details.

Please note that some movie aspect ratios are wider than 16:9, so even though you have a widescreen TV, these discs will still play in a 'letterbox' style with black bars at the top and bottom of the screen.

Standard TV users

If you have a standard TV, the **TV Screen** setting (page 62) of this system should be set to **4:3 (Letter Box)** or **4:3 (Pan&Scan)**, depending on which you prefer.

Set to **4:3 (Letter Box)**, widescreen discs are shown with black bars top and bottom.



Set to **4:3 (Pan&Scan)**, widescreen discs are shown with the left and right sides cropped. Although the picture looks larger, you don't actually see the whole picture.



Please note that many widescreen discs override the system's settings so that the disc is shown in letterbox format regardless of the setting.



Tip

- Using the **16:9 (Wide)** setting with a standard 4:3 TV, or either of the **4:3** settings with a widescreen TV, will result in a distorted picture.

Selecting languages using the language code list

Some of the language options (see *Language settings* on page 64) allow you to set your preferred language from any of the 136 languages listed in the *Language code list* on page 85.

- 1 Select '**Other Language**'.
- 2 Use the **←/→ (cursor left/right)** buttons to select either a code letter or a code number.
- 3 Use the **↑/↓ (cursor up/down)** buttons to select a code letter or a code number.

See *Language code list* on page 85 for a complete list of languages and codes.

Language code list

Language (Language code letter), **Language code**

Japanese (ja), 1001	Basque (eu), 0521	Lithuanian (lt), 1220	Samoan (sm), 1913
English (en), 0514	Persian (fa), 0601	Latvian (lv), 1222	Shona (sn), 1914
French (fr), 0618	Finnish (fi), 0609	Malagasy (mg), 1307	Somali (so), 1915
German (de), 0405	Fiji (fj), 0610	Maori (mi), 1309	Albanian (sq), 1917
Italian (it), 0920	Faroese (fo), 0615	Macedonian (mk), 1311	Serbian (sr), 1918
Spanish (es), 0519	Frisian (fy), 0625	Malayalam (ml), 1312	Siswati (ss), 1919
Dutch (nl), 1412	Irish (ga), 0701	Mongolian (mn), 1314	Sesotho (st), 1920
Russian (ru), 1821	Scots-Gaelic (gd), 0704	Moldavian (mo), 1315	Sundanese (su), 1921
Chinese (zh), 2608	Galician (gl), 0712	Marathi (mr), 1318	Swedish (sv), 1922
Korean (ko), 1115	Guarani (gn), 0714	Malay (ms), 1319	Swahili (sw), 1923
Greek (el), 0512	Gujarati (gu), 0721	Maltese (mt), 1320	Tamil (ta), 2001
Afar (aa), 0101	Hausa (ha), 0801	Burmese (my), 1325	Telugu (te), 2005
Abkhazian (ab), 0102	Hindi (hi), 0809	Nauru (na), 1401	Tajik (tg), 2007
Afrikaans (af), 0106	Croatian (hr), 0818	Nepali (ne), 1405	Thai (th), 2008
Amharic (am), 0113	Hungarian (hu), 0821	Norwegian (no), 1415	Tigrinya (ti), 2009
Arabic (ar), 0118	Armenian (hy), 0825	Occitan (oc), 1503	Turkmen (tk), 2011
Assamese (as), 0119	Interlingua (ia), 0901	Oromo (om), 1513	Tagalog (tl), 2012
Aymara (ay), 0125	Interlingue (ie), 0905	Oriya (or), 1518	Setswana (tn), 2014
Azerbaijani (az), 0126	Inupiak (ik), 0911	Panjabi (pa), 1601	Tonga (to), 2015
Bashkir (ba), 0201	Indonesian (in), 0914	Polish (pl), 1612	Turkish (tr), 2018
Byelorussian (be), 0205	Icelandic (is), 0919	Pashto, Pushto (ps), 1619	Tsonga (ts), 2019
Bulgarian (bg), 0207	Hebrew (iw), 0923	Portuguese (pt), 1620	Tatar (tt), 2020
Bihari (bh), 0208	Yiddish (ji), 1009	Quechua (qu), 1721	Twi (tw), 2023
Bislama (bi), 0209	Javanese (jw), 1023	Rhaeto-Romance (rm), 1813	Ukrainian (uk), 2111
Bengali (bn), 0214	Georgian (ka), 1101	Kirundi (rn), 1814	Urdu (ur), 2118
Tibetan (bo), 0215	Kazakh (kk), 1111	Romanian (ro), 1815	Tonga (to), 2015
Breton (br), 0218	Greenlandic (kl), 1112	Kinyarwanda (rw), 1823	Wolof (wo), 2315
Catalan (ca), 0301	Cambodian (km), 1113	Sanskrit (sa), 1901	Vietnamese (vi), 2209
Corsican (co), 0315	Kannada (kn), 1114	Sindhi (sd), 1904	Volapük (vo), 2215
Czech (cs), 0319	Kashmiri (ks), 1119	Sangho (sg), 1907	Xhosa (xh), 2408
Welsh (cy), 0325	Kurdish (ku), 1121	Serbo-Croatian (sh), 1908	Yoruba (yo), 2515
Danish (da), 0401	Kirghiz (ky), 1125	Sinhalese (si), 1909	Zulu (zu), 2621
Bhutanese (dz), 0426	Latin (la), 1201	Slovak (sk), 1911	
Esperanto (eo), 0515	Lingala (ln), 1214	Slovenian (sl), 1912	
Estonian (et), 0520	Laothian (lo), 1215		

Country code list

Country, **Country code**, **Country code letter**

Argentina, 0118 , ar	France, 0618 , fr	Mexico, 1324 , mx	Spain, 0519 , es
Australia, 0121 , au	Germany, 0405 , de	Netherlands, 1412 , nl	Switzerland, 0308 , ch
Austria, 0120 , at	Hong Kong, 0811 , hk	New Zealand, 1426 , nz	Sweden, 1905 , se
Belgium, 0205 , be	India, 0914 , in	Norway, 1415 , no	Taiwan, 2023 , tw
Brazil, 0218 , br	Indonesia, 0904 , id	Pakistan, 1611 , pk	Thailand, 2008 , th
Canada, 0301 , ca	Italy, 0920 , it	Philippines, 1608 , ph	United Kingdom, 0702 , gb
Chile, 0312 , cl	Japan, 1016 , jp	Portugal, 1620 , pt	United States of America, 2119 , us
China, 0314 , cn	Korea, Republic of, 1118 , kr	Russian Federation, 1821 , ru	
Denmark, 0411 , dk	Malaysia, 1325 , my	Singapore, 1907 , sg	
Finland, 0609 , fi			

Preset code list

Please note that there are cases where only certain functions may be controllable after assigning the proper preset code, or the codes for the manufacturer in the list will not work for the model that you are using.

MANUFACTURER Code(s)

ACURA 644	ERRES 607	ITC 642	OSUME 648
ADMIRAL 631	FERGUSON 607, 636, 651	ITT 631, 632, 642	OTTO VERSAND 631, 632, 607, 642
AIWA 660	FINLANDIA 635, 643, 655	JEC 605	PALLADIUM 638
AKAI 632, 635, 642	FINLUX 632, 607, 645, 648, 653, 654, 655	JVC 613, 623	PANAMA 646
AKURA 641	FIRSTLINE 640, 644	KAISUI 618, 641, 644	PANASONIC 631, 607, 608, 642, 622
ALBA 607, 639, 641, 644	FISHER 632, 635, 638, 645	KAPSCH 631	PATHO CINEMA 642
AMSTRAD 642, 644, 647	FORMENTI 632, 607, 642	KENDO 642	PAUSA 644
ANITECH 644	FRONTECH 631, 642, 646	KENNEDY 632, 642	PHILCO 632, 642
ASA 645	FRONTECH/PROTECH 632	KORPEL 607	PHILIPS 631, 607, 634, 656
ASUKA 641	FUJITSU 648, 629	KOYODA 644	PHOENIX 632
AUDIOGONIC 607, 636	FUNAI 640, 646, 658	LEYCO 607, 640, 646, 648	PHONOLA 607
BASIC LINE 641, 644	GBC 632, 642	LIESENK&TTER 607	PROFEX 642, 644
BAUR 631, 607, 642	GE 601, 608, 607, 610, 617, 602, 628, 618	LOEWE 607	PROTECH 607, 642, 644, 646, 649
BEKO 638	GEC 607, 634, 648	LUXOR 632, 642, 643	QUELLE 631, 632, 607, 642, 645, 653
BEON 607	GELOS 632, 644	M-ELECTRONIC 631, 644, 645, 654, 655, 656, 607, 636, 651	R-LINE 607
BLAUPUNKT 631	GENEXXA 631, 641	MAGNADYNE 632, 649	RADIOLA 607
BLUE SKY 641	GOLDSTAR 610, 623, 621, 602, 607, 650	MAGNAFON 649	RADIOSHACK 610, 623, 621, 602
BLUE STAR 618	GOODMANS 607, 639, 647, 648, 656	MAGNAVOX 607, 610, 603, 612, 629	RBM 653
BPL 618	GORENJE 638	MANESTH 639, 646	RCA 601, 610, 615, 616, 617, 618, 661, 662, 609
BRANDT 636	GPM 641	MARANTZ 607	REDIFFUSION 632, 642
BTC 641	GRAETZ 631, 642	MARK 607	REX 631, 646
BUSH 607, 641, 642, 644, 647, 656	GRANADA 607, 635, 642, 643, 648	MATSUI 607, 639, 640, 642, 644, 647, 648	ROADSTAR 641, 644, 646
CASCADE 644	GRADIENTE 630, 657	MCMICHAEL 634	SABA 631, 636, 642, 651
CATHAY 607	GRANDIN 618	MEDIATOR 607	SAISHO 639, 644, 646
CENTURION 607	GRUNDIG 631, 653	MEMOREX 644	SALORA 631, 632, 642, 643
CGB 642	HANSEATIC 607, 642	METZ 631	SAMBERS 649
CIMLINE 644	HCM 618, 644	MINERVA 631, 653	SAMSUNG 607, 638, 644, 646
CLARIVOX 607	HINARI 607, 641, 644	MITSUBISHI 609, 610, 602, 621, 631	SANYO 635, 645, 648, 621, 614
CLATRONIC 638	HISAWA 618	MULTITECH 644, 649	SBR 607, 634
CONDOR 638	HITACHI 631, 633, 634, 636, 642, 643, 654, 606, 610, 624, 625, 618	NEC 659	SCHAUB LORENZ 642
CONTEC 644	HUANYU 656	NECKERMANN 631, 607	SCHNEIDER 607, 641, 647
CROSLEY 632	HYPSON 607, 618, 646	NEI 607, 642	SEG 642, 646
CROWN 638, 644	ICE 646, 647	NIKKAI 605, 607, 641, 646, 648	SEI 632, 640, 649
CRYSTAL 642	IMPERIAL 638, 642	NOBLIKO 649	SELECO 631, 642
CYBERTRON 641	INDIANA 607	NOKIA 632, 642, 652	SHARP 602, 619, 627
DAEWOO 607, 644, 656	INGELEN 631	NORDMENDE 632, 636, 651, 652	SIAREM 632, 649
DAINICHI 641	INTERFUNK 631, 632, 607, 642	OCEANIC 631, 632, 642	SIEMENS 631
DANSAI 607	INTERVISION 646, 649	ORION 632, 607, 639, 640	SINUDYNE 632, 639, 640, 649
DAYTON 644	ISUKAI 641	OSAKI 641, 646, 648	
DECCA 607, 648		OSO 641	
DIXI 607, 644			
DUMONT 653			
ELIN 607			
ELITE 641			
ELTA 644			
EMERSON 642			

SKANTIC 643
SOLAVOX 631
SONOKO 607, 644
SONOLOR 631, 635
SONTEC 607
SONY 604
SOUNDWAVE 607
STANDARD 641, 644
STERN 631
SUSUMU 641
SYSLINE 607

TANDY 631, 641, 648
TASHIKO 634
TATUNG 607, 648
TEC 642
TELEAVIA 636
TELEFUNKEN 636, 637, 652
TELETECH 644
TENSAI 640, 641
THOMSON 636, 651, 652, 663

THORN 631, 607, 642, 645, 648
TOMASHI 618
TOSHIBA 605, 602, 626, 621, 653
TOWADA 642
ULTRAVOX 632, 642, 649
UNIVERSUM 631, 607, 638, 642, 645, 646, 654, 655
VESTEL 607
VICTOR 613

VOXSON 631
WALTHAM 643
WATSON 607
WATT RADIO 632, 642, 649
WHITE
WESTINGHOUSE 607
YOKO 607, 642, 646
ZENITH 603, 620
PIONEER 600, 631, 632, 607, 636, 642, 651

Glossary

Analog audio

An electrical signal that directly represents sound. Compare this to digital audio which can be an electrical signal, but is an indirect representation of sound. See also *Digital audio*.

Aspect ratio

The width of a TV screen relative to its height. Conventional TVs are 4:3 (in other words, the screen is almost square); widescreen models are 16:9 (the screen is almost twice as wide as it is high).

Digital audio

An indirect representation of sound by numbers. During recording, the sound is measured at discrete intervals (44,100 times a second for CD audio) by an analog-to-digital converter, generating a stream of numbers. On playback, a digital-to-analog converter generates an analog signal based on these numbers. See also *Sampling frequency* and *Analog audio*.

Dolby Digital



Using a maximum of 5.1 channels of audio, this high quality surround system is used in many of the finer movie theaters around the world.

The on-screen display shows which channels are active, for example showing 3/2.1. The 3 being the two front channels and the center channel; the 2 being the surround channels, and the .1 being the LFE channel.

Dolby Pro Logic / Pro Logic II



A matrix decoding system that extracts 4.1 (Dolby Pro Logic) or 5.1 (Dolby Pro Logic II) channel surround sound from a two channel source.

DRM

DRM (digital rights management) is a type of server software developed to enable secure distribution of paid content over the web, recently incorporated by WMA (Windows Media Audio).

DTS



DTS stands for Digital Theater Systems. DTS is a surround system different from Dolby Digital that has become a popular surround sound format for movies.

Dynamic range

The difference between the quietest and loudest sounds possible in an audio signal (without distorting or getting lost in noise). Dolby Digital and DTS soundtracks are capable of a very wide dynamic range, delivering dramatic cinema-like effects.

EXIF (Exchangeable Image File)

A file format developed by Fuji Photo Film for digital still cameras. Digital cameras from various manufacturers use this compressed file format which carries date, time and thumbnail information, as well as the picture data.

File extension

A tag added to the end of a filename to indicate the type of file. For example, “.mp3” indicates an MP3 file.

Interlaced video

A method of displaying a picture in which odd-numbered lines are updated in one pass, then even-numbered lines are updated in the next. See also *Progressive scan video*.

ISO 9660 format

International standard for the volume and file structure of CD-ROM discs.

JPEG

A file format used for still images, such as photographs and illustrations. JPEG files are identified by the file extension “.jpg” or “.JPG”. Most digital cameras use this format.

MP3

MP3 (MPEG1 audio layer 3) is a compressed audio file format. Files are recognized by their file extension “.mp3” or “.MP3”.

MPEG audio

An audio format used on Video CDs and some DVD discs. This system can convert MPEG audio to PCM format for wider compatibility with digital recorders and AV amplifiers. See also *PCM (Pulse Code Modulation)*.

MPEG video

The video format used for Video CDs and DVDs. Video CD uses the older MPEG-1 standard, while DVD uses the newer and much better quality MPEG-2 standard.

PBC (PlayBack Control) (Video CD/Super VCD only)

A system of navigating a Video CD/Super VCD through on-screen menus recorded onto the disc. Especially good for discs that you would normally not watch from beginning to end all at once—karaoke discs, for example.

PCM (Pulse Code Modulation)

The most common system of encoding digital audio, found on CDs and DAT. Excellent quality, but requires a lot of data compared to formats such as Dolby Digital and MPEG audio. See also *Digital audio*.

Progressive scan video

Also called non-interlaced video, this method of displaying a picture updates all the lines in one pass, resulting in a more stable, flicker-free image than interlaced video (for a given scanning rate). See also *Interlaced video*.

Regions (DVD-Video only)

These associate discs and players with particular areas of the world. This system will only play discs that have compatible region codes. You can find the region code of your system by looking on the rear panel. Some discs are compatible with more than one region (or all regions).

Sampling frequency

The rate at which sound is measured to be turned into digital audio data. The higher the rate, the better the sound quality, but the more digital information is generated. Standard CD audio has a sampling frequency of 44.1kHz, which means 44,100 samples (measurements) per second. See also *Digital audio*.

WMA

WMA is short for Windows Media Audio and refers to an audio compression technology developed by Microsoft Corporation. WMA data can be encoded by using Windows Media Player version 8 or Windows Media Player for Windows XP. Files are recognized by their file extension ".wma" or ".WMA".

Microsoft, Windows Media, and the Windows logo are trademarks, or registered trademarks of Microsoft Corporation in the United States and/or other countries.

Specifications

Amplifier section

Continuous Power Output (RMS):
 Front, Center, Surround 75 W per channel
 (1 kHz, 10 % T.H.D., 6 Ω)
 Subwoofer75 W (100 Hz, 10 % T.H.D., 6 Ω)
 Continuous Power Output :
 Front, Center, Surround 62 W per channel
 (1 kHz, 1 % T.H.D., 6 Ω)
 Subwoofer62 W (100 Hz, 1 % T.H.D., 6 Ω)

Disc section

Digital audio characteristics DVD fs: 96 kHz, 24-bit
 Type DVD system, video CD system and compact disc digital audio system
 Frequency response 4 Hz to 44 kHz
 Wow and Flutter Limit of measurement (±0.001 % W.PEAK) or less (JEITA)

FM tuner section

Frequency range 87.5 – 108 MHz
 Antenna 75 Ω, unbalanced

AM tuner section

Frequency range
 With 9kHz step 531 kHz to 1,602 kHz
 With 10kHz step (*Not applicable to the European model*) . . 530 kHz to 1,700 kHz
 Antenna Loop antenna

Miscellaneous

Power requirements
 European/Singapore models AC 220-230 V, 50/60 Hz
 U.K. model AC 230 V, 50/60 Hz
 Australian/New Zealand/Malaysian models AC 240 V, 50/60 Hz
 Taiwan model AC 110-120 V, 60 Hz
 Power consumption
 European/U.K. model 160 W

Australian/New Zealand/Singapore/
 Malaysian models 160 W
 Taiwan model 157 W
 Power consumption in standby 0.39 W
 Dimensions . . . 420 (W) x 70 (H) x 403.5 (D) mm
 Weight 7.4 kg

Accessories (DVD/CD receiver)

Remote control 1
 AA/R6 dry cell batteries 2
 Video cable (yellow plugs) 1
 AM loop antenna 1
 FM antenna 1
 Power cord 1
 Setup Guide 1
 These operating instructions 1
 Warranty Card (European/U.K./
 Australian/New Zealand models only) 1

Speaker System

Front speakers

Enclosure Closed-box bookshelf type
 (magnetically shielded)
 System 18x6 cm 1-way system
 Speakers 18x6 cm cone type
 Nominal impedance 6 Ω
 Frequency range 90 Hz to 20 kHz
 Maximum Input Power 75 W
 Dimensions 78 (W) x 210 (H) x 82 (D) mm
 Weight 0.7 kg

Center speaker

Enclosure Closed-box bookshelf type
 (magnetically shielded)
 System 18x6 cm 1-way system
 Speakers 18x6 cm cone type
 Nominal impedance 6 Ω
 Frequency range 78 Hz to 20 kHz
 Maximum Input Power 75 W
 Dimensions 240 (W) x 85 (H) x 96 (D) mm
 Weight 0.75 kg

Subwoofer

Enclosure	Bass-reflex floor type (magnetically shielded)
System	16 cm 1-way system
Speaker	16 cm cone type
Nominal impedance	6 Ω
Frequency range	35 Hz to 2.8 kHz
Maximum Input Power	75 W
Dimensions	130 (W) x 360 (H) x 360 (D) mm
Weight	4.5 kg

Accessories (Speaker system)

Speaker cables	6
Non-slip pads (Small)	20
Non-slip pads (Large)	4

Digital wireless speaker system**Wireless speaker**

System	Digital wireless speaker system (Transmitter / Wireless speaker)
Power requirements	
European model	AC 220-230 V, 50/60 Hz
U.K. model	AC 230 V, 50/60 Hz
Australian/New Zealand models	AC 240 V, 50/60 Hz
Singapore/Malaysian models	AC 220-240 V, 50/60 Hz
Taiwan model	AC 110 V, 60 Hz
Power consumption	
European model	52 W
Australian/New Zealand/Singapore /Malaysian models	55 W
Taiwan model	51 W
Speaker unit	7 cm cone type x 2
Weight	4.2 kg
Dimensions	420 (W) x 178 (H) x 138 (D) mm

Transmitter

AC adaptor	
Power requirements	
European/Singapore/Malaysian models	AC 220-240 V, 50/60 Hz
U.K. model	AC 230 V, 50/60 Hz
Australian/New Zealand models	AC 240 V, 50/60 Hz
Taiwan model	AC 110 V, 60 Hz
Power consumption	9 W
Rated output	12 V/300 mA
Power consumption (without AC adaptor)	2 W
Input	RCA jack
Weight	0.3 kg
Dimensions	166 (W) x 56 (H) x 112 (D) mm

Accessories (Wireless speaker system)

AC adaptor	1
RCA stereo cord	1
Operating instructions	1
Warranty card (European/U.K./ Australian/New Zealand models only)	1

**Note**

- Specifications and design subject to possible modification without notice, due to improvements.

This product includes FontAvenue® fonts licenced by NEC corporation. FontAvenue is a registered trademark of NEC Corporation.

This product incorporates copyright protection technology that is protected by method claims of certain U.S. patents and other intellectual property rights owned by Macrovision Corporation and other rights owners. Use of this copyright protection technology must be authorized by Macrovision Corporation, and is intended for home and other limited uses only unless otherwise authorized by Macrovision Corporation. Reverse engineering or disassembly is prohibited.

This product is intended for household purposes. Any failure due to use for other than household purposes (such as long-term use for business purposes in a restaurant or use in a car or ship) and which requires repair will be charged for even in the warranty period.

KO41_En

AFTER-SALES SERVICE FOR PIONEER PRODUCTS

Please contact the dealer or distributor from where you purchased the product for its after-sales service (including warranty conditions) or any other information. In case the necessary information is not available, please contact the Pioneer's subsidiaries (regional service headquarters) listed below:

PLEASE DO NOT SHIP YOUR PRODUCT TO THE COMPANIES at the addresses listed below for repair without advance contact, for these companies are not repair locations.

AMERICA

PIONEER ELECTRONICS (USA) INC.
CUSTOMER SUPPORT DIVISION
P.O. BOX 1760, LONG BEACH, CA 90801-1760, U.S.A.
CUSTOMER SERVICE HOTLINE : (800) 421-1404

EUROPE

PIONEER EUROPE NV
EUROPEAN SERVICE DIVISION
HAVEN 1087, KEETBERGLAAN 1, B-9120 MELSELE, BELGIUM

ASEAN

PIONEER ELECTRONICS ASIACENTRE PTE. LTD.
SERVICE DEPARTMENT
253, ALEXANDRA ROAD #04-01 SINGAPORE 159936

JAPAN AND OTHERS

PIONEER CORPORATION (HEAD OFFICE)
CUSTOMER SUPPORT CENTER
4-1, MEGURO 1-CHOME, MEGURO-KU, TOKYO 153-8654 JAPAN

5016D_en

Published by Pioneer Corporation
Copyright ©2003 Pioneer Corporation
All rights reserved

PIONEER CORPORATION

4-1, Meguro 1-Chome, Meguro-ku, Tokyo 153-8654, Japan

PIONEER ELECTRONICS (USA) INC.

P.O. BOX 1540, Long Beach, California 90810-1540, U.S.A. TEL: (800) 421-1404

PIONEER ELECTRONICS OF CANADA, INC.

300 Allstate Parkway, Markham, Ontario L3R 0P2, Canada TEL: (905) 479-4411

PIONEER EUROPE NV

Haven 1087, Keetberglaan 1, B-9120 Melsele, Belgium TEL: 03/570.05.11

PIONEER ELECTRONICS ASIACENTRE PTE. LTD.

253 Alexandra Road, #04-01, Singapore 159936 TEL: 656-472-1111

PIONEER ELECTRONICS AUSTRALIA PTY. LTD.

178-184 Boundary Road, Braeside, Victoria 3195, Australia, TEL: (03) 9586-6300

PIONEER ELECTRONICS DE MEXICO S.A. DE C.V.

Blvd.Manuel Avila Camacho 138 10 piso Col.Lomas de Chapultepec, Mexico,D.F. 11000 TEL: 55-9178-4270

Free Manuals Download Website

<http://myh66.com>

<http://usermanuals.us>

<http://www.somanuals.com>

<http://www.4manuals.cc>

<http://www.manual-lib.com>

<http://www.404manual.com>

<http://www.luxmanual.com>

<http://aubethermostatmanual.com>

Golf course search by state

<http://golfingnear.com>

Email search by domain

<http://emailbydomain.com>

Auto manuals search

<http://auto.somanuals.com>

TV manuals search

<http://tv.somanuals.com>