

Operating Instructions

STEREO CD CASSETTE DECK RECEIVER

XR-P160

SPEAKER SYSTEM

S-P160

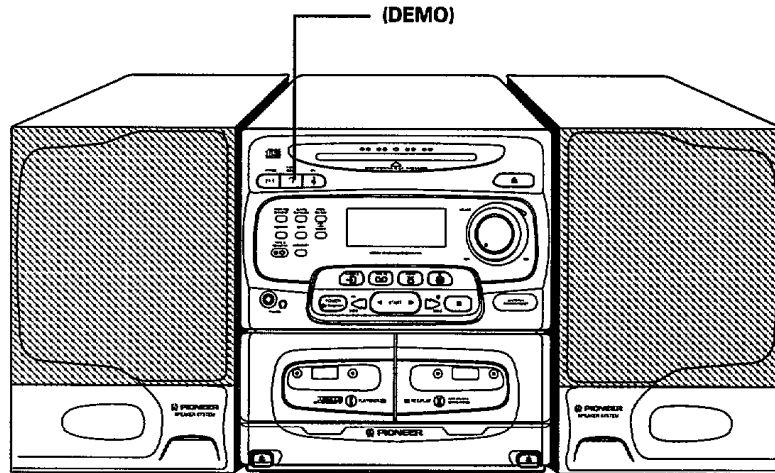

COMPACT
disc
DIGITAL AUDIO

Thank you for buying this Pioneer product. Please read through these operating instructions so you will know how to operate your model properly. After you have finished reading the instructions, put them away in a safe place for future reference. In some countries or regions, the shape of the power plug and power outlet may sometimes differ from that shown in the explanatory drawings. However, the method of connecting and operating the unit is the same.

WARNING: TO PREVENT FIRE OR SHOCK HAZARD, DO NOT EXPOSE THIS APPLIANCE TO RAIN OR MOISTURE.

This product complies with the Low Voltage Directive (73/23/EEC), EMC Directives (89/336/EEC, 92/31/EEC) and CE Marking Directive (93/68/EEC).

Demo Function

The Demo mode starts automatically when the power cord is plugged into the power outlet.

Also, when the P.BASS (DEMO) button is pressed in the STANDBY mode, the Demo mode is activated.

In the demo mode, various functions of this system appear on the display.

- The Demo mode can be cancelled by turning on the power with the POWER button.

THE POWER SWITCH IS SECONDARY CONNECTED AND THEREFORE DOES NOT SEPARATE THE UNIT FROM MAINS POWER IN STANDBY POSITION.

IMPORTANT 1



The lightning flash with arrowhead, within an equilateral triangle, is intended to alert the user to the presence of uninsulated "dangerous voltage" within the product's enclosure that may be of sufficient magnitude to constitute a risk of electric shock to persons.

CAUTION

RISK OF ELECTRIC SHOCK
DO NOT OPEN

CAUTION:
TO PREVENT THE RISK OF ELECTRIC SHOCK, DO NOT REMOVE COVER (OR BACK). NO USER-SERVICEABLE PARTS INSIDE. REFER SERVICING TO QUALIFIED SERVICE PERSONNEL.



The exclamation point within an equilateral triangle is intended to alert the user to the presence of important operating and maintenance (servicing) instructions in the literature accompanying the appliance.

 **PIONEER**
The Art of Entertainment

IMPORTANT 2

FOR USE IN THE UNITED KINGDOM

The wires in this mains lead are coloured in accordance with the following code:

Blue : neutral
Brown : live

If the plug provided is unsuitable for your socket outlets, the plug must be cut off and a suitable plug fitted.

The cut-off plug should be disposed of and must not be inserted into any 13 amp socket as this can result in electric shock. The plug or adaptor or the distribution panel should be provided with 5 amp fuse. As the colours of the wires in the mains lead of this appliance may not correspond with coloured markings identifying the terminals in your plug, proceed as follows:
The wire which is coloured blue must be connected to the terminal which is marked with the letter N or coloured black.
The wire which is coloured brown must be connected to the terminal which is marked with the letter L or coloured red.

Do not connect either wire to the earth terminal of a three pin plug.

NOTE

After replacing or changing a fuse, the fuse cover in the plug must be replaced with a fuse cover which corresponds to the colour of the insert in the base of the plug or the word that is embossed on the base of the plug, and the appliance must not be used without a fuse cover. If lost, replacement fuse covers can be obtained from your dealer.

Only 5 A fuses approved to B.S.I. or A.S.T.A. to B.S. 1362 should be used.

SAFETY INSTRUCTIONS

READ INSTRUCTIONS – All the safety and operating instructions should be read before the appliance is operated.

RETAIN INSTRUCTIONS – The safety and operating instructions should be retained for future reference.

HEED WARNING – All warnings on the appliance and in the operating instructions should be adhered to.

FOLLOW INSTRUCTIONS – All operating and use instructions should be followed.

WATER AND MOISTURE – The appliance should not be used near water – for example, near a bathtub, washbowl, kitchen sink, laundry tub, in a wet basement, or near a swimming pool, etc.

LOCATION – The appliance should be installed in a stable location.

WALL OR CEILING MOUNTING – The appliance should not be mounted to a wall or ceiling.

VENTILATION – The appliance should be situated so that its location or position does not interfere with its proper ventilation. For example, the appliance should not be situated on a bed, sofa, rug, or similar surface that may block the ventilation openings; or, placed in a built-in installation, such as a bookcase or cabinet that may impede the flow of air through the ventilation openings.

HEAT – The appliance should be situated away from heat sources such as radiators, heat registers, stoves, or other appliances (including amplifiers) that produce heat.

POWER SOURCES – The appliance should be connected to a power supply only of the type described in the operating instructions or as marked on the appliance.

POWER-CORD PROTECTION – Power-supply cords should be routed so that they are not likely to be walked on or pinched by items placed upon or against them. Pay particular attention to cords at plugs, convenience receptacles, and the point where they exit from the appliance.

POLARIZATION – If your purchased product is provided with a polarized power plug, please read the following instructions. This product is equipped with a polarized alternating current line plug (a plug having one blade wider than the other). This plug will fit into the power outlet only one way. This is a safety feature. If you are unable to insert the plug fully into the outlet, try reversing the plug. If the plug should still fail to fit, contact your electrician to replace your obsolete outlet. Do not defeat the safety purpose of the polarized plug.

CLEANING – The appliance should be cleaned only with a polishing cloth or a soft dry cloth. Never clean with furniture wax, benzene, insecticides or other volatile liquids since they may corrode the cabinet.

POWER LINES – An outdoor antenna should be located away from power lines.

NONUSE PERIODS – The power cord of the appliance should be unplugged from the outlet when left unused for a long period of time.

OBJECT AND LIQUID ENTRY – Care should be taken so that objects do not fall and liquids are not spilled into the enclosure through openings.

DAMAGE REQUIRING SERVICE – The appliance should be serviced by a Pioneer authorized service center or qualified service personnel when

- The power-supply cord or the plug has been damaged.
- Objects have fallen, or liquid has been spilled into the appliance.
- The appliance has been exposed to rain.
- The appliance does not appear to operate normally or exhibits a marked change in performance.
- The appliance has been dropped or the enclosure damaged.

SERVICING – The user should not attempt to service the appliance beyond that described in the operating instructions. All other servicing should be referred to qualified service personnel.

OUTDOOR ANTENNA GROUNDING – If an outside antenna is connected to the antenna terminal, be sure the antenna system is grounded so as to provide some protection against voltage surges and built-up static charges.

In the U.S.A. section 810 of the National Electrical Code, ANSI/NFPA 70, provides information with respect to proper grounding of the mast and supporting structure, grounding of the lead-in wire to an antenna discharge unit, size of grounding conductors, location of antenna discharge unit, connection to grounding electrodes, and requirements for the grounding electrode. See Fig. A.

CART – An appliance and cart combination should be moved with care. Quick stops, excessive force, and uneven surfaces may cause the appliance and cart combination to overturn.



NEC – NATIONAL ELECTRIC CODE

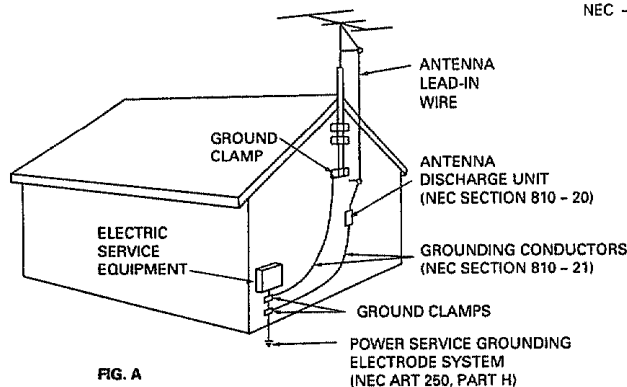

FIG. A

[FOR EUROPEAN AND U.K. MODELS] CAUTION

This product contains a laser diode of higher class than 1. To ensure continued safety, do not remove any covers or attempt to gain access to the inside of the product. Refer all servicing to qualified personnel.

The following caution label appears on your unit.

Location: rear of the unit



CONTENTS

CAUTIONS REGARDING HANDLING	3
CONFIRM SUPPLIED ACCESSORIES	4
LOADING BATTERIES INTO THE REMOTE CONTROL UNIT	4
REMOTE CONTROL OPERATIONS	4
CONNECTIONS	5
NAMES AND FUNCTIONS OF PARTS	7
SETTING THE CLOCK	10
TURNING ON THE POWER	10
Direct power on	10
TUNING INTO STATIONS	11
Beat cut function	11
MEMORIZING STATIONS	11
Manual presetting	11
Station call	12
CAUTIONS REGARDING COMPACT DISC HANDLING	13
OPERATIONS OF THE DISPLAY	13
When the function is CD	13
LISTENING TO COMPACT DISCS	14
To stop playback	14
To play a compact disc	14
To remove a disc	14
To search for a particular track	14
VARIOUS OPERATIONS OF THE CD PLAYER	15
CD indicator	15
To play back desired track (Direct search)	15
Random playback - To play all tracks in random order	15
To repeat playback (Repeat playback)	15
TO PLAY ONLY DESIRED TRACKS	16
Program playback - To program tracks in desired order	16
To clear all of the programmed contents	16
Programming during playback (Reservation programming)	16
PLAYING TAPES	17
Basic operation	17
For playing back from the beginning of a song (MUSIC SEARCH function)	18
RECORDING	19
Recording on a tape	19
Copying a tape	20
A.S.E.S. (Auto Synchro Editing System)	21
HOW TO HANDLE CASSETTE TAPES	21
MAINTENANCE	22
SOUND FIELD CONTROL OPERATION	23
Selecting a preset sound setting	23
ADJUSTING THE SOUND	23
Creating an expansive sound field (STEREO WIDE mode)	23
Boosting the bass sound	23
TIMER PLAYBACK/TIMER RECORDING	24
Setting the WAKE-UP timer	24
Timer recording setting	25
To change timer settings	25
If you make a mistake while setting the timer	25
To select the timer to be activated in case both the wake-up timer and recording timer have been set	26
To deactivate WAKE-UP timer and timer recording	26
SLEEP TIMER	26
Sleep timer - Automatically turns off the power	26
TROUBLESHOOTING	27
SPECIFICATIONS	Back Cover

CAUTIONS REGARDING HANDLING

Location

Install the unit in a well-ventilated location where it will not be exposed to high temperatures or humidity.

Do not install the unit in a location which is exposed to direct rays of the sun, or near stoves or radiators. Excessive heat can adversely affect the cabinet and internal components. Installation of the unit in a damp or dusty environment may also result in a malfunction or an accident. (Avoid installation near cookers, etc., where the unit may be exposed to oily smoke, steam or heat.)



Precautions regarding installation

- Placing and using the unit for long periods on heat-generating sources will affect performance. Avoid placing the unit on heat-generating sources.
- Install the unit as far away as possible from your TV. Installation in close proximity to such equipment may cause noise or degradation of the picture.
- Such noise may be particularly noticeable when an indoor antenna is used. In such cases, make use of an outdoor antenna, or turn off the power to the unit.
- Please place this unit on a level surface.

Condensation

When this unit is brought into a warm room from previously cold surroundings or when the room temperature rises sharply, condensation may form inside, and the unit may not be able to attain its full performance. To prevent this, allow the unit to stand for about an hour before switching it on, or raise the room temperature gradually.

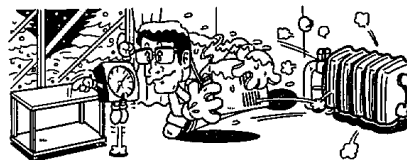

CONFIRM SUPPLIED ACCESSORIES

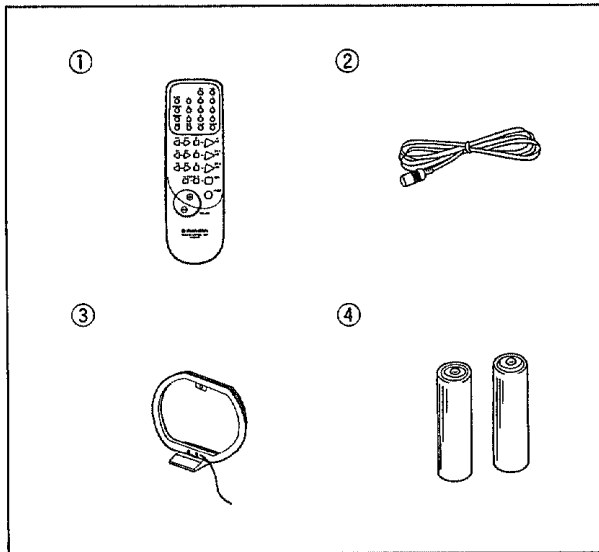

- ① Remote control unit x 1
- ② FM T-type antenna x 1
- ③ AM loop antenna x 1
- ④ AAA/R03 dry cell batteries x 2

LOADING BATTERIES INTO THE REMOTE CONTROL UNIT

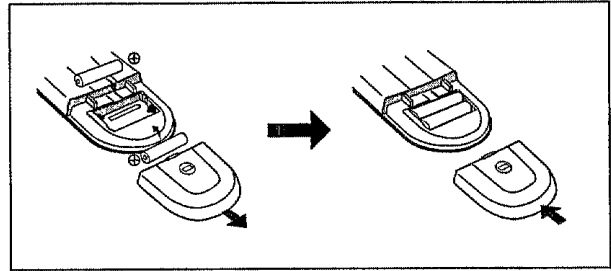

Open the battery compartment cover on the back of the remote control unit.
Insert size "AAA/R03" dry cell batteries into the battery compartment in accordance with the indications (+, -) inside the compartment.
Close the cover of the battery case.

Incorrect use of batteries may cause leakage or rupture. Always be sure to follow these guidelines:

- A. Always insert batteries into the battery compartment correctly matching the positive (+) and negative (-) polarities, as shown by the display inside the compartment.
- B. Never mix new and used batteries.
- C. Batteries of the same size may have different voltages, depending on brand. Do not mix different brands of batteries.

REMOTE CONTROL OPERATIONS

The remote control unit can be used within a range of approx. 7 meters from the remote sensor, and within angles of up to approx. 30 degrees.

- If the remote control sensor window is in a position where it receives strong light such as sunlight or fluorescent light, control may not be possible.

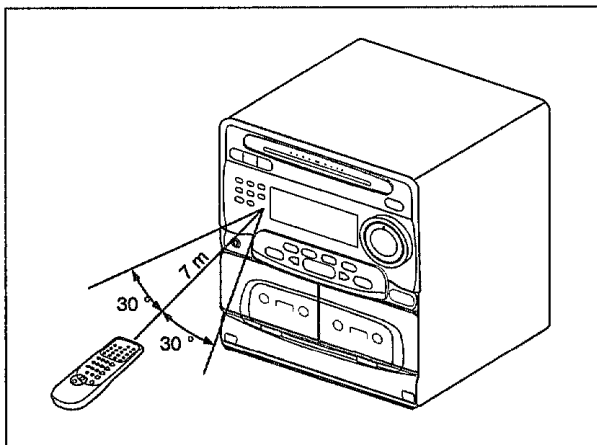

POWER-CORD CAUTION

Handle the power cord by the plug. Do not pull out the plug by tugging the cord and never touch the power cord when your hands are wet as this could cause a short circuit or electric shock. Do not place the unit, a piece of furniture, etc., on the power cord, or pinch the cord. Never make a knot in the cord or tie it with other cords. The power cords should be routed such that they are not likely to be stepped on. A damaged power cord can cause a fire or give you an electrical shock. Check the power cord once in a while. When you find it damaged, ask your nearest PIONEER authorized service center or your dealer for a replacement.

CONNECTIONS

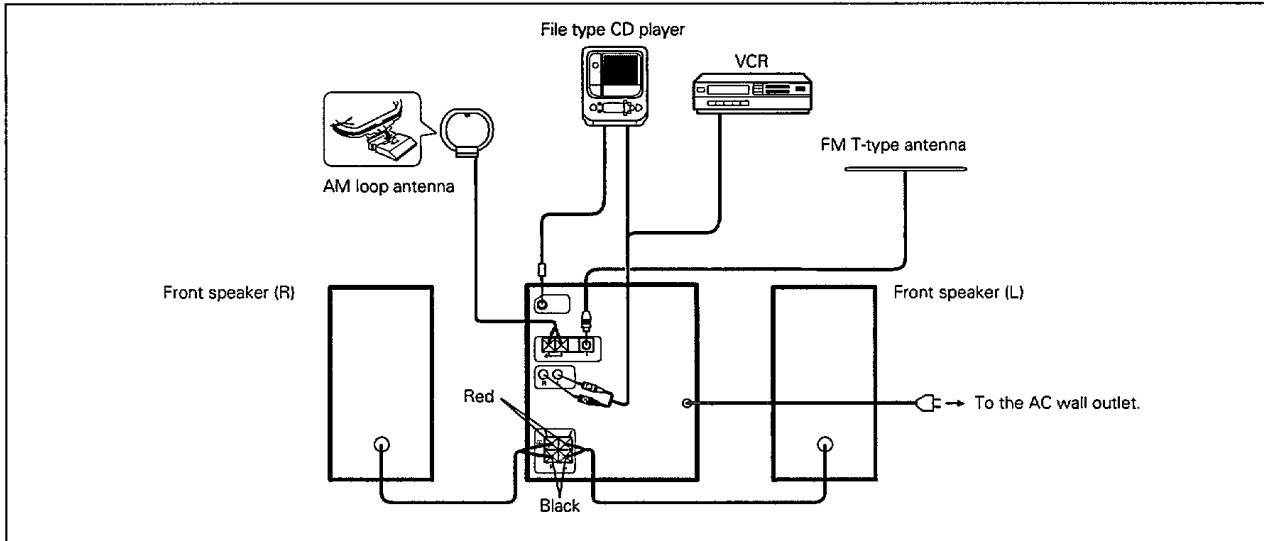

- Before making or changing the connections, switch off the power switch and disconnect the power cord from the AC outlet.
 - Be sure to connect an antenna. If you do not, broadcast signal reception will not be possible.
- 1 Connect AM loop antenna and FM T-type antenna to the unit's antenna terminals.

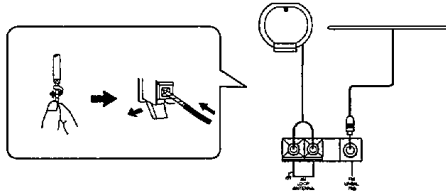

- 2 Connect the speaker cords to the SPEAKER terminals. Connect the red cords to the "+" (red) terminals and the black cords to the "-" (black) terminals.

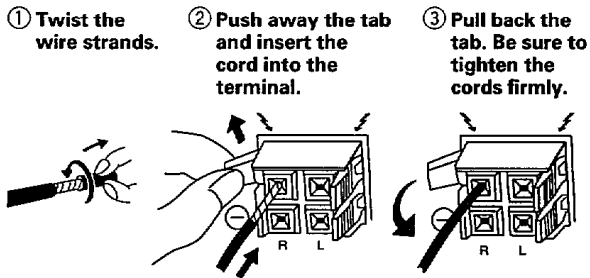

NOTES:

- Do not allow the conductors of the cords to project out of the terminals or to come into contact with other conductors. A breakdown or failure may occur when conductors touch.
- The speaker system of this product has not been designed to be resistant against magnetism. If the system is installed near a TV set, color irregularities may be observed on the TV screen. Be sure to install the speaker system at a distance from a TV set.

Speaker impedance

Connect speaker systems with a normal impedance ranging from 6 to 16Ω.

Precaution for the S-P160

Do not connect to any amplifier other than the one supplied with this system. Connection to any other amplifier may in rare cases result in smoke or fire.

- 3 When using a video cassette recorder, connect the output cord to the AUX/CD II input jacks.

4 Connection of the control terminals.

The control terminals are used for installing additional CD players.

- File type CD players & other Pioneer CD players provided with control terminals can be connected.

- The CDII CONTROL OUT terminal of this unit is connected with the CONTROL IN terminal of the file type CD player or other CD player to be connected, by means of a control cable provided with the player.

The remote controller provided with this product can be used to operate this product only. When remote controlling a file type CD player, use the remote controller provided with the file type CD player.

- When using CDII CONTROL OUT terminal, make sure to connect the AUX/CDII input of this unit with the output of the file type CD player or other CD players to be connected with this unit by means of a connecting cord provided with pin plugs, that is sold separately.

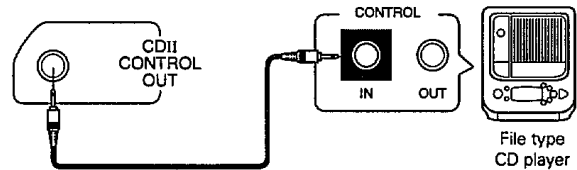

- 5 Finally, plug the power cord into the AC wall outlet.

NOTE:

Insert the plugs securely into the jacks. Improper connection can lead to sound distortion or a malfunction.

CONNECTIONS

ANTENNA CONNECTIONS

Radio reception is not possible unless the antenna is properly connected.

The strength of broadcast signals varies from one area to another. Signal propagation is especially poor in metropolitan areas, where there are many tall buildings, and in mountainous areas. Proper antenna installation is vital to good reception.

FM ANTENNA

FM T-type antenna

Stretch out the antenna and affix it to a wall, etc.

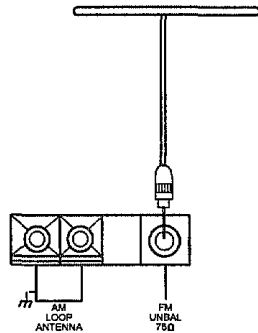

External FM antenna installation

Use an external antenna when the signals from stations are weak and cannot be picked up by the accessory FM T-type antenna, or when the sound heard is accompanied by large amounts of noise. Connect a 75Ω coaxial cable.

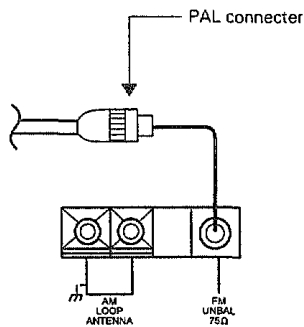

AM ANTENNA

The antenna should be placed at a distance from this unit, and should not be allowed to touch metallic objects. Avoid placing it near CD players, personal computers, television sets, and other devices generating radio frequencies.

Set Up the AM Loop Antenna

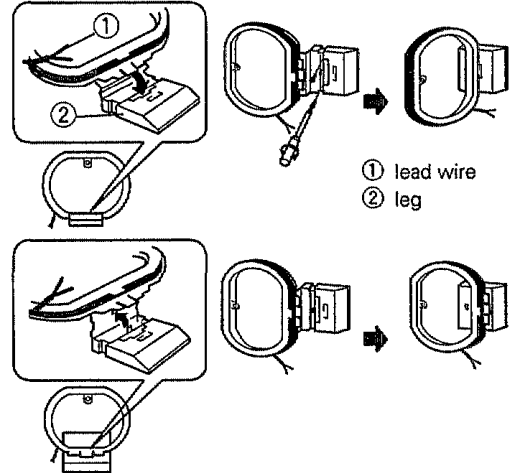

- Insert the clip on the bottom of the antenna into the groove on the leg.
- To permanently fix the antenna, screw the leg to a wall or something similar before assembling (fixing the antenna in the direction that gives the best reception).
- Place the antenna on a level surface and rotate it to find the orientation that yields the best reception.

External AM antenna

Indoor AM antenna

Prepare a vinyl-coated wire (5 to 6 meters long). Secure one end to the AM terminal and the other end to a wall or other high location.

Outdoor AM antenna

If reception is still poor even when a lead antenna has been fully extended indoors, stretch out a vinyl-coated wire and secure it outdoors.

NOTES:

- Do not detach the AM loop antenna when using an external AM antenna.
-  (signal earth) is designed to reduce noise that occurs when an antenna is connected. It is not a safety earth.

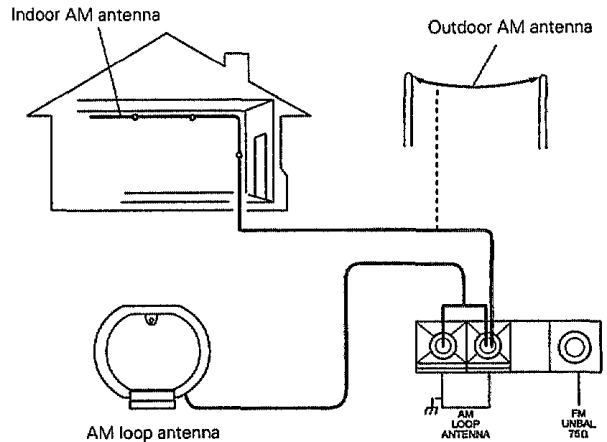

NAMES AND FUNCTIONS OF PARTS

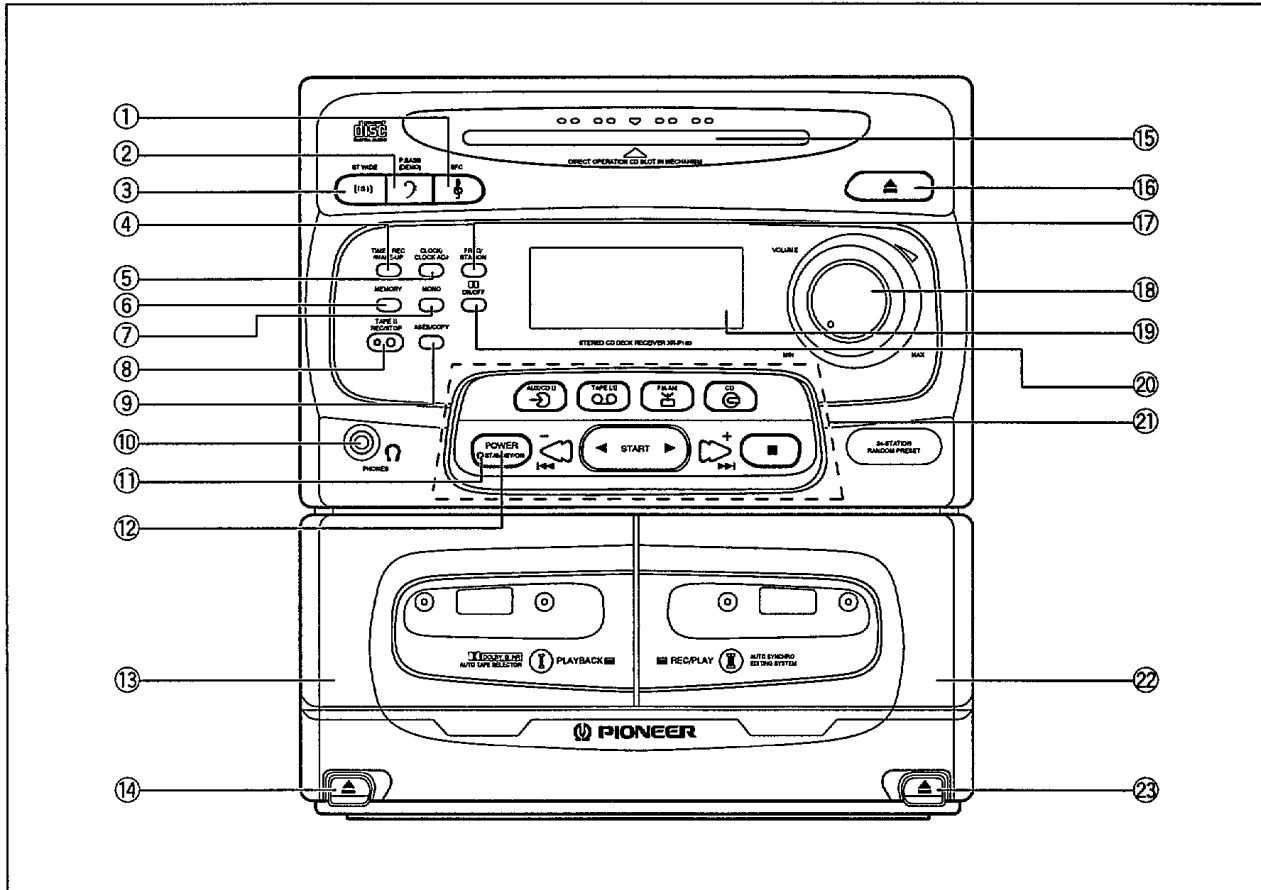

① SFC button P.23

Each time this button is pressed, the mode changes in the following sequence:

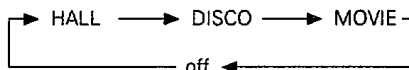

② P.BASS (DEMO) button P.23

Each time this button is pressed, the mode changes in the following sequence:

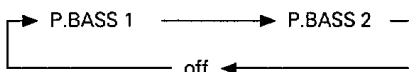

③ ST. WIDE button P.23

Each time this button is pressed, the mode changes in the following sequence:

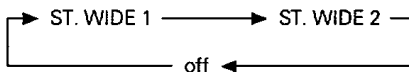

④ TIMER REC/WAKE-UP button

⑤ CLOCK/CLOCK ADJ button P.10

⑥ MEMORY button P.11

⑦ MONO button P.11

⑧ Rec/Rec stop button P.19

⑨ ASES/COPY button P.20 P.21

⑩ Headphones jack

⑪ STANDBY indicator P.10

This is the switch for electric power.

ON: When set to the ON position, power is supplied and the unit becomes operational.

STANDBY: When set to the STANDBY position, the main power flow is cut and the unit is no longer fully operational. A minute flow of power feeds the unit to maintain operation readiness. (The STANDBY indicator lights.)

⑫ POWER STANDBY/ON switch P.10

⑬ TAPE I cassette door

⑭ TAPE I Eject button ▲

NAMES AND FUNCTIONS OF PARTS

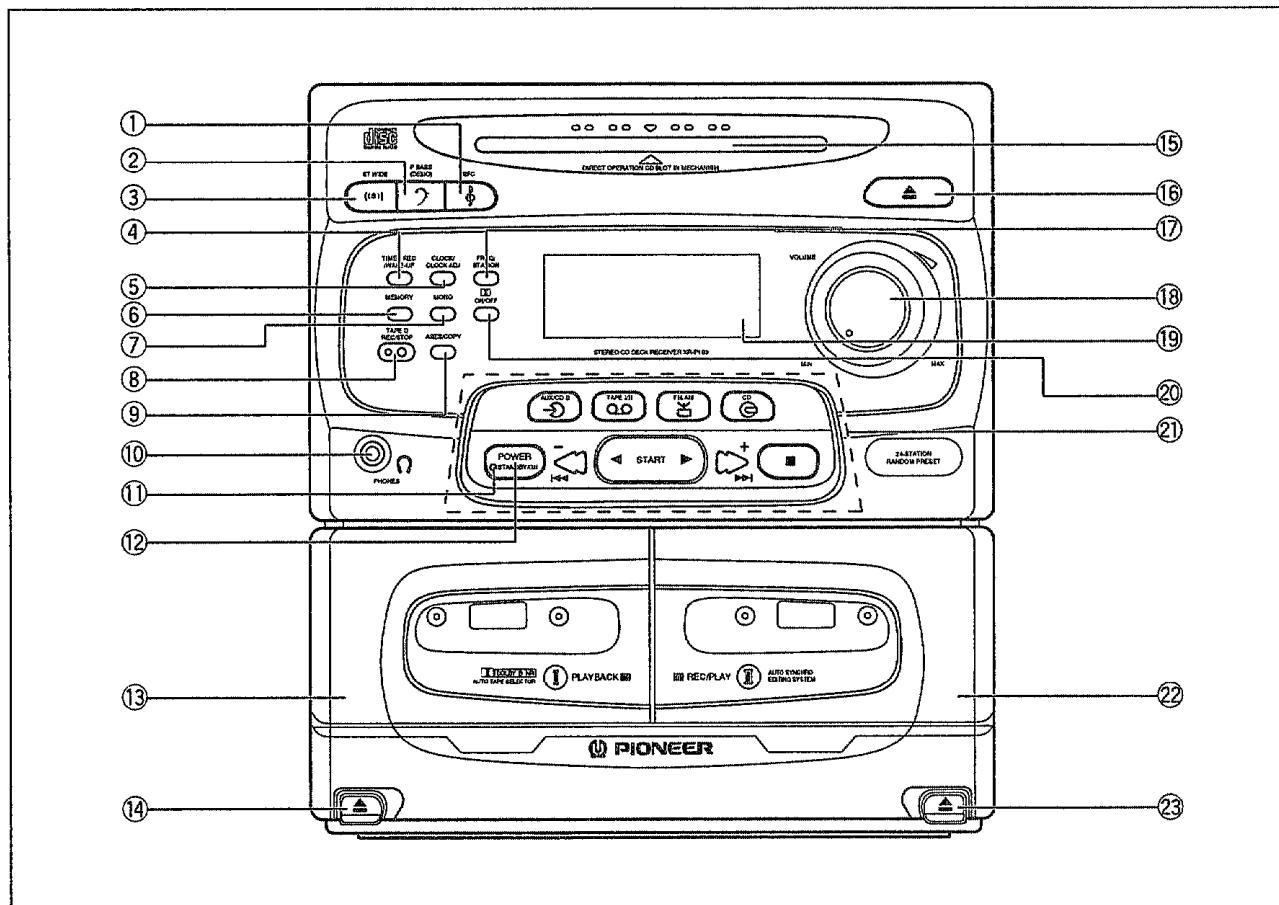

15 Disc slot

16 CD Eject button (▲)

17 **FREQ/STATION** button P. 12

Each time this button is pressed, the mode changes between FREQUENCY and STATION.

18 **Volume control (VOLUME)**

19 **Display**

20 **(DOLBY*) NR ON/OFF** button P. 17

Each time this button is pressed, DOLBY NR system turns ON and OFF.

21 **Function buttons (Refer to P. 9)**

22 **TAPE II cassette door**

23 **TAPE II Eject button (▲)**

- *Dolby noise reduction manufactured under license from Dolby Laboratories Licensing Corporation.*
- *"DOLBY" and the double-D symbol are trademarks of Dolby Laboratories Licensing Corporation.*

Function button section

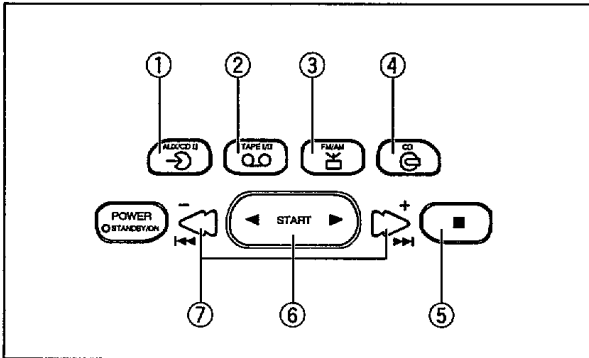

- ① AUX/CD II function button and indicator
- ② TAPE (I/II) function button and indicator
- ③ Tuner (FM/AM) function button and indicator
- ④ CD function button and indicator
- ⑤ STOP button (■)
- ⑥ START button (◀▶)
- ⑦ $\leftarrow \leftarrow \leftarrow$, $\rightarrow \rightarrow \rightarrow$ buttons

● Roles of the common operation buttons (The roles of the buttons vary depending on the input functions as shown below.)

During CD input

START: Play/pause button

STOP: Stop button

$\leftarrow \leftarrow \leftarrow$: Fast forward/track search button

$\rightarrow \rightarrow \rightarrow$: Fast reverse/track search button

During cassette deck input

START: Play button/Tape transport direction

STOP: Stop button

$\leftarrow \leftarrow \leftarrow$: Fast forward button

$\rightarrow \rightarrow \rightarrow$: Rewind button

During tuner operation

$\leftarrow \leftarrow \leftarrow$: Frequency & Station + (up) button

$\rightarrow \rightarrow \rightarrow$: Frequency & Station - (down) button

REMOTE CONTROL UNIT

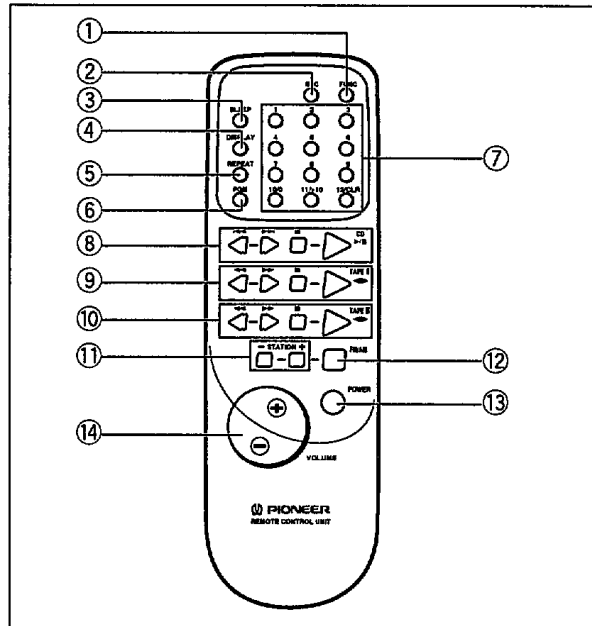

① Function button (FUNC)

Each time this button is pressed, the function changes in the following sequence:

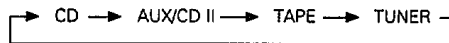

② SFC mode button (P.23)

Each time this button is pressed, the function changes in the following sequence:

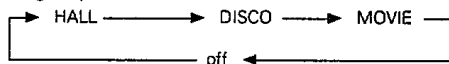

③ SLEEP timer button (P.26)

④ DISPLAY button (P.13)

⑤ REPEAT button (P.15)

⑥ PGM button (P.16)

⑦ Number buttons (P.12, P.15)

These buttons are used for selecting track numbers of a CD and for scanning preset stations.

⑧ CD operation buttons

(Track search $\leftarrow \leftarrow \leftarrow \rightarrow \rightarrow \rightarrow$, Stop ■, Play/Pause \blacktriangleright /II)

⑨ TAPE I operation buttons

(Fast $\leftarrow \leftarrow \leftarrow \rightarrow \rightarrow \rightarrow$, Stop ■, Play \blacktriangleright)

⑩ TAPE II operation buttons

(Fast $\leftarrow \leftarrow \leftarrow \rightarrow \rightarrow \rightarrow$, Stop ■, Play \blacktriangleright)

⑪ STATION - (down), + (up) buttons

Before operation, memorize broadcast stations with the STATION -, + buttons.

+ ... Stations change in order in the upward direction.

- ... Stations change in order in the downward direction.

⑫ FM/AM band button

⑬ POWER button (P.10)

⑭ VOLUME + (up), - (down) button

Increase/decrease the sound volume of the unit.

SETTING THE CLOCK

- Set the clock when it has been incorrectly set, or when power has been cut to the unit.
- This clock provides a 24 hour display.
- The clock cannot be set by the remote control unit.

Example: Setting the clock to 18:40

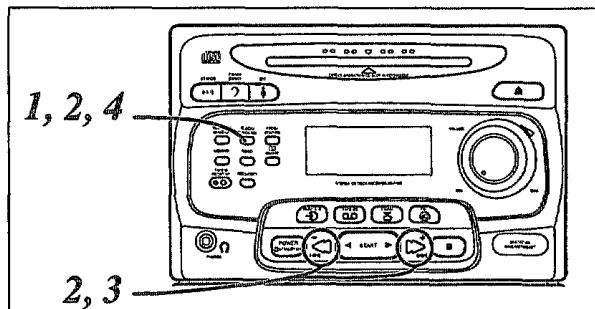





1, 2, 4



2, 3

1. While power is turned off, keep the CLOCK/CLOCK ADJ button pressed for more than 5 seconds.

CLOCK/CLOCK ADJ

2. Set the hour by pressing the  or  button, then press the CLOCK/CLOCK ADJ button.

  → CLOCK/CLOCK ADJ

3. Set the minutes by pressing the  or  button.

4. Press the CLOCK/CLOCK ADJ button, when "00" seconds of that minute are reached for precise adjustment.

CLOCK/CLOCK ADJ

18:40

- After connecting to an AC outlet, be sure to set the present time. Timer playback and timer recording are not possible unless the time has been set.
- The time display will appear as "--:--" when the power is restored following a power failure, or if the power cord has been disconnected. In this case, be sure to set the present time again.
- To see the clock during playback, press CLOCK/CLOCK ADJ to switch to the clock display.

TURNING ON THE POWER

Operations indicated by the  mark are performed with the remote control unit.

- Read "CONNECTIONS" again and ensure that the speakers, antenna, etc., are connected properly.
- When the power plug is inserted into the power outlet, the clock display (---:---) lights up (STANDBY mode). If the power plug has been disconnected while the power of the system was ON, the system is turned ON at the moment the power plug is inserted.

Press the POWER switch.



To switch the power OFF:

Press the POWER switch again. The clock display reappears and the STANDBY indicator lights.

Direct power on

Performing any of the following operations while the system power is off (STANDBY) turns the power ON.

Pressing the tuner (FM/AM) function button:

Power is turned ON and the tuner (radio) input is selected.

Pressing the CD function button:

Power is turned ON, the CD input is selected and, if a CD has been loaded, it starts to play.

Pressing the AUX/CD II function button:

Power is turned ON and, if the component connected to the AUX/CD II input jacks are operating, its audio is played.

Pressing the TAPE (I/II) function button:

Power is turned ON, the TAPE input is selected and, if a cassette tape has been loaded, it starts to play.

Pressing the START button:

Power is turned ON, the function which has been selected before the last time the power was switched off is selected and the corresponding operation starts.

If there is a CD loaded:

Power is turned ON and play starts.

■ Auto function

This model is equipped with an "Auto Function" operation, so when the function button for CD, TAPE, AUX/CD II, or FM and AM (AM/FM with remote control unit) is pressed, the function switches automatically. Use the FUNC button on the remote control unit to select the component connected to the AUX/CD II IN jacks, since Auto Function is not effective for this.

NOTE:

The function cannot be switched during recording and tape copying.

TUNING INTO STATIONS

- Be sure to connect the antennas.
- Do not place the AM antenna on a metallic case including the receiver cabinet or near a CD player, LD player, DAT recorder, personal computer or TV set. Any of these installations will cause noise in reception.

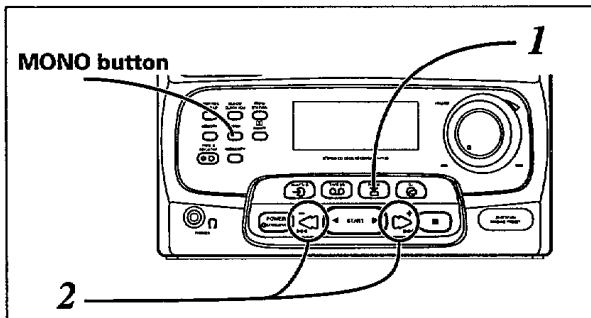

1. Select FM or AM with the Tuner (FM/AM) function button.

Select the AM or FM broadcasting band.

2. Tune in the desired station by pressing the

◀ or ▶ button.

• Manual tuning

Tap the ◀ or ▶ button in quick repetitions.

• Auto tuning

Press the ◀ or ▶ button for a second or two and remove your finger from it when the frequency starts to change.

→ The frequency changes automatically. When a station is received, the frequency stops changing and "TUNED" appears on the display.

• High-speed manual tuning

Press and hold the ◀ or ▶ button.

→ The frequency changes continuously and stops when your finger is removed from the button.

MONO button

During FM reception: Switches between stereo and monaural modes when listening to a stereo broadcast. If there is a lot of noise in the stereo position, switch to MONO, and the noise will be suppressed.

Beat cut function

If noise occurs during AM broadcast recording, perform the following procedures to reduce the noise.

1. Press the POWER switch so that the STANDBY indicator lights up.
2. Turn on the power while pressing the MONO button. (The BEAT CUT indicator lights on the right side of the STEREO indicator in the display.)

- To cancel the BEAT CUT function, repeat 1 and 2.

MEMORIZING STATIONS

Manual presetting

- Up to 24 FM/AM stations can be memorized at random.
- For FM reception, the MONO setting can be memorized.

Example: To memorize FM 106 MHz as preset station 3

1. Select FM with the tuner (FM/AM) function button.
2. Tune in the desired station by pressing the ◀ or ▶ button.
3. Press MEMORY.
4. Select the station number to be memorized by pressing the ◀ or ▶ button.

Operate while the display is flashing.
5. Press MEMORY.

BEAT CUT indicator

Operate while the display is flashing (it flashes for approx. 2 seconds). The displayed frequency is stored in the selected station No. Repeat steps 1 through 4 to memorize up to 24 stations.

MEMORIZING STATIONS

Station call

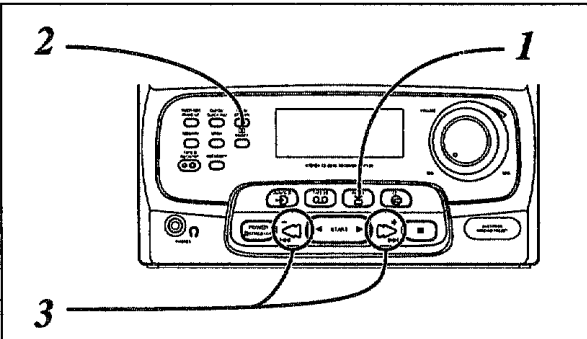

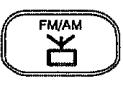

1. Press the Tuner (FM/AM) function button to select the tuner input.
The band and frequency being received are displayed.



2. Press the FREQ/STATION button to change the display to the station mode.



This operation is not necessary when the remote control unit is used.

3. Press the  or  button to select the desired station.

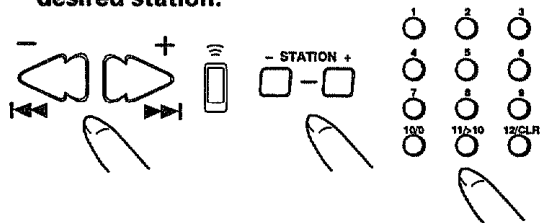

- When the function is set to TUNER, it is possible to select the station with the number buttons on the remote control unit.

When the remote control unit is used, select the station with the numeric buttons. (Refer to the following table for selection.)

Recalling preset stations with the remote control unit

Number button	Times pressed	
	once	twice
1	1	13
2	2	14
3	3	15
4	4	16
5	5	17
6	6	18
7	7	19
8	8	20
9	9	21
10/0	10	22
11/>10	11	23
12/CLR	12	24

NOTES:

- The memorized stations will not be erased even if the power is turned off. However, if the AC power cord is unplugged or a power failure occurs, the memorized stations will be erased. (If the AC power cord is unplugged, the memorized stations will be preserved for several days.)
- If the memorized stations have been erased, memorize them again.

CAUTIONS REGARDING COMPACT DISC HANDLING

CARE OF DISCS

- When holding discs, do not touch their signal surfaces.

STORING DISCS

- Always store discs in their cases vertically, avoiding locations with high heat or humidity, or extremely low temperatures.
- Always read and abide by the precautionary notes listed on disc labels.

CLEANING DISCS

- Fingerprints or smudges on the surface of a disc will not directly affect the recorded signals. Always keep your discs clean by wiping them gently with a soft cloth from the inner edge toward the outer periphery.
- If a disc becomes very dirty, dip a soft cloth in water, and after wringing it out well, wipe the dirt away gently. Remove any water drops with another soft, dry cloth.
- Do not use record cleaning sprays or anti-static agents on discs. Never clean discs with benzene, thinner, or other volatile solvents, since damage to the disc surface may result.



- Do not affix gummed labels or tape to the label surfaces. Also, do not scratch or damage the label.
- Discs rotate at high speed inside the player. Do not use damaged (cracked or warped) discs.

CD LENS CLEANER

The player's pickup lens should not become dirty in normal use, but if for some reason it should malfunction due to soiling, contact your nearest PIONEER authorized service center. Lens cleaners for CD players are commercially available, but special care should be exercised in their use since some may cause damage to the lens.

OPERATIONS OF THE DISPLAY

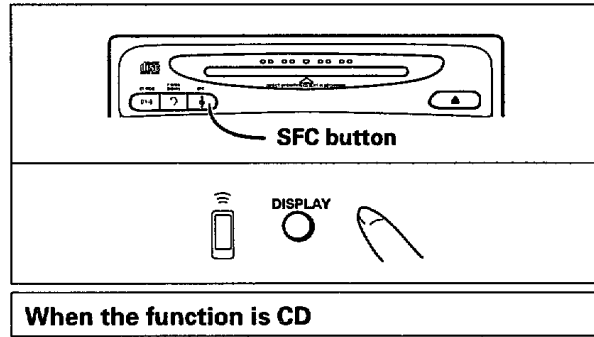

When the function is CD

Operate using the DISPLAY button of the remote control unit.

1. During regular operation

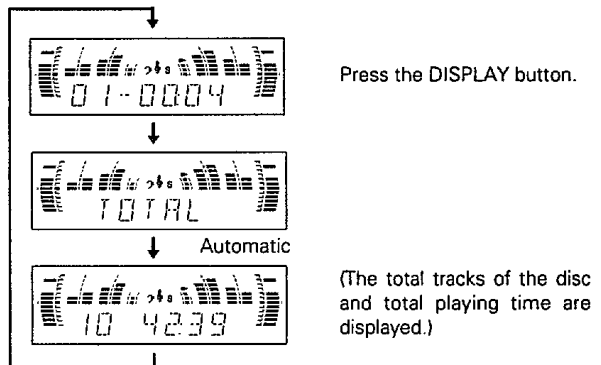

2. During A.S.E.S operation or random play

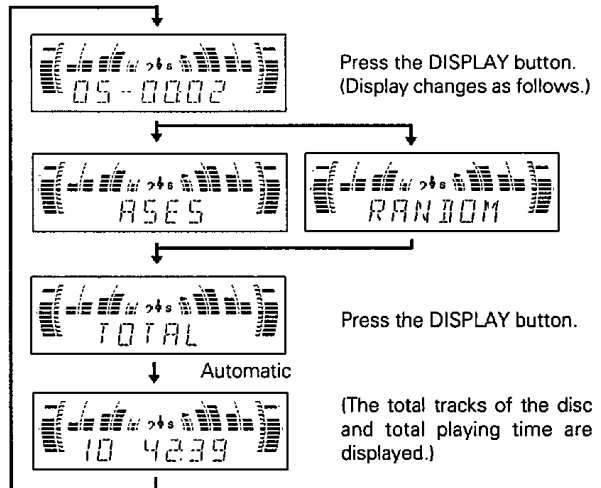

NOTES:

- When the program has been specified, the total playing time of the programmed tracks is displayed.
- You can change dynamic displays such as those for the level meters and spectrum analyzer in the following way:
Power OFF (STANDBY)

Press the SFC button. (Each time you press it, the mode changes from A to B.)



LISTENING TO COMPACT DISCS

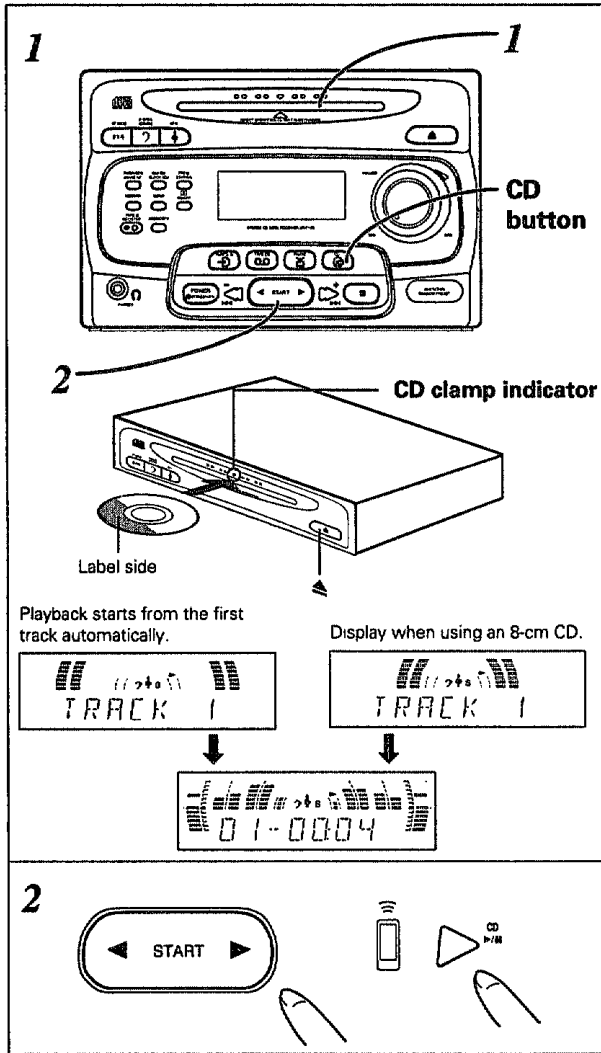

To play a compact disc

1. Load a CD in the disc slot.

- Gently load the CD keeping it horizontal, making sure the disc label is on top (the side with the name of the disc displayed). After pushing in a short way, the disc is loaded automatically.
- After inserting a CD, the display will indicate whether it is correctly loaded, as shown in the left figure, and play will begin from track 1.
- When power is switched off (STANDBY), pressing the CD function button switches power ON, and CD play starts if a disc is loaded.

2. When a CD is loaded,

- Press the **START** button (◀▶).
- To eject a disc, press the **Eject** button (⬆). Even if power is switched off (STANDBY), pressing the Eject button (⬆) lets you eject a disc, then the unit enters the standby mode again.

To remove a disc

Press the **Eject** button (⬆), then remove the disc.







CAUTION:

Do not unplug the power cord during playback, as this could result in damage to the disc.

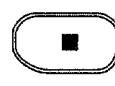

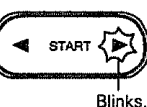

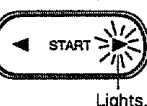
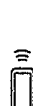

NOTES:

- If the function is switched during CD playback, the CD player enters stop mode automatically.
- When setting an 8-cm CD single, do not use the 8-cm CD single adaptor.
- Never attempt to load both 8-cm and 12-cm discs together, since disc damage or other malfunctions may result. Always load only one disc at a time.
- Only one disc at a time can be played. Be sure to press the Eject button (⬆) before loading a disc.
- Take out the CD after the ejection operation has completed.

To stop playback

Function	Buttons
To stop playback	  
To stop playback temporarily (The play indicator blinks in pause mode.)	  
To play back again	   

To search for a particular track

Function	Buttons
To search for the beginning of a track	    Press and release.
To rapidly advance forward or backward (Main unit only)	  Press and hold.

VARIOUS OPERATIONS OF THE CD PLAYER

CD indicator

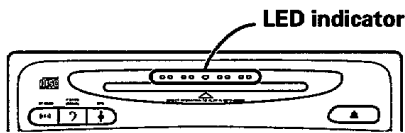

- This lights to show different indicators as follows.

● = Lit ○ = Not lit

- When a CD is not loaded (no exist):



- When a CD is loaded (exist):



To play back desired track (Direct search)

- Set the function mode to CD and then operate with the remote control unit.

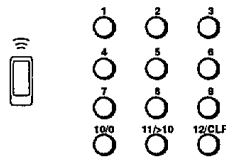

Enter the track number with the number buttons.

<Example>

To select track number 3



To select track number 12
(Track number cannot be selected by pressing 12/CLR.)



To select track number 20



Playback of the specified track will start.

If you make a mistake during entry, reenter the correct number.

NOTES:

- During programmed playback, direct search is not possible.
- Even if you press 11/5-10 or 12/CLR, tracks 11 and 12 cannot be selected.
- A track number between 1 and 99 can be selected.
- If you put the CD player in pause mode before selecting the track number, the player will pause at the beginning of the selected track number. Press the START button or CD function button to start playback.

Random playback - To play all tracks in random order



In either play or stop mode, press and hold the CD function button for a few seconds.

- To stop random playback, press the Stop button (■) or □ on the remote control unit.

NOTES:

- Random playback cannot be applied to the programmed tracks.
- Random playback is possible up to 99 tracks.
- If the REPEAT button is pressed during random playback, all of the tracks on the disc will be played repeatedly in a random order. (Random repeat playback)
- If you use the number buttons to select a track (direct search) during random playback, the unit enters normal playback mode and random playback is cancelled.
- If CD function button is pressed for a few seconds during program playback, the programmed contents will be erased.

To repeat playback (Repeat playback)

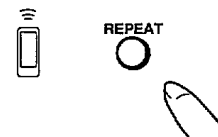

- The REPEAT indicator lights up.
- All tracks will be repeated.

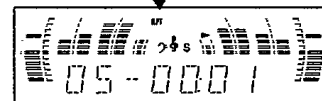

In the repeat mode, programmed play and random play will be repeated.

- To exit repeat mode, press REPEAT or Stop (■) so that the REPEAT indicator goes off.
- To repeat one track, program one track and press REPEAT (see P.16).

TO PLAY ONLY DESIRED TRACKS

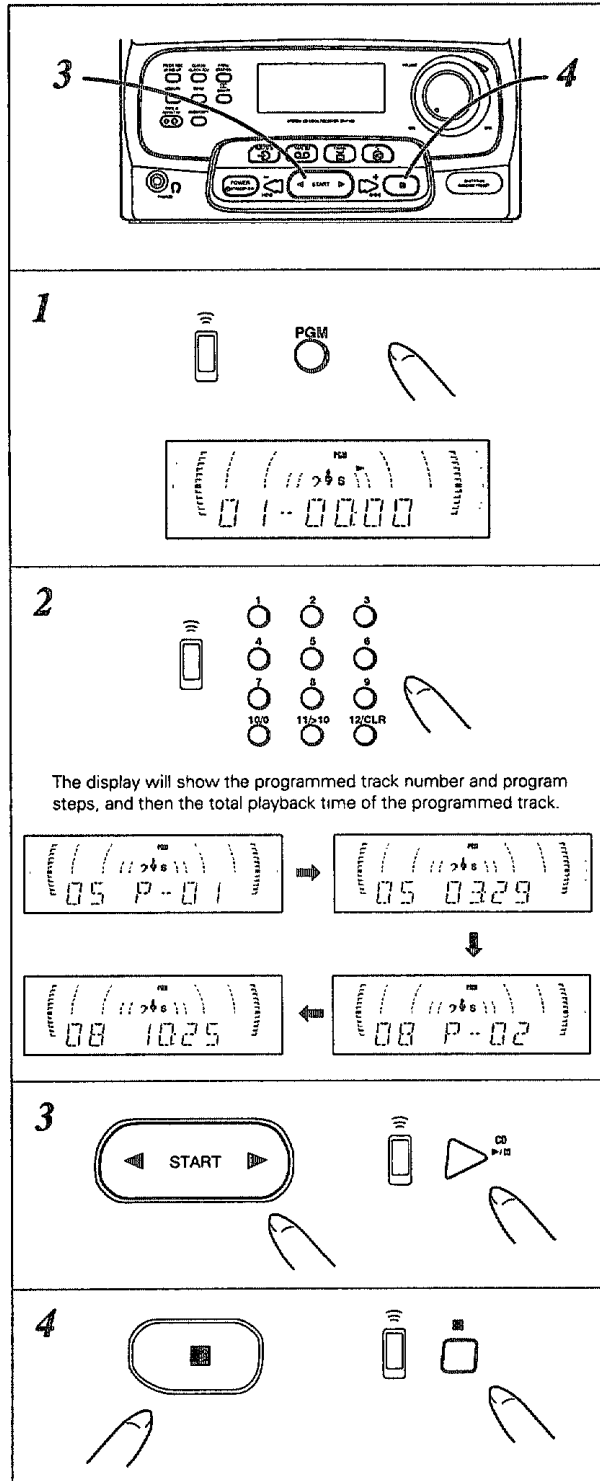

Program playback - To program tracks in desired order

- Up to 24 steps can be programmed.

1. In the stop mode, press the PGM button on the remote control unit.

The PGM indicator lights.

2. Press the track number for the desired track.

Repeat the procedure until all desired tracks have been programmed in the desired order.

(When programming on the main unit, search for desired tracks using and (the button for finding the start of tracks), and then press the PGM button to register the track. Repeat this procedure until all desired tracks have been programmed.)

(For details, refer to [p 15](#).)

The display will show the programmed track number and then the total playback time of the programmed track.

3. Press the START button () (or on the remote control unit).

Start playback, and programmed tracks are played one after another in the programmed order.

4. To stop programmed playback, press the Stop button () (or on the remote control unit).

To clear all of the programmed contents

- Press the Eject button ().
- In the stop mode, press the Stop button () (or on the remote control unit).
- In the playback mode, press the Stop button () (or on the remote control unit) twice.
- Each time the CLR button on the remote control is pressed, the last programmed step will be cleared.

Programming during playback (Reservation programming)

- Program with the remote control unit.

1. In the playback mode, press the PGM button on the remote control unit.

2. Press the number button for the desired track. (Refer to above for details concerning the programming of 11 or more tracks.)

3. Repeat procedure 2.

When the track currently playing finishes, programmed playback automatically starts. Pressing the START button () or CD function button also starts programmed playback.

PLAYING TAPES

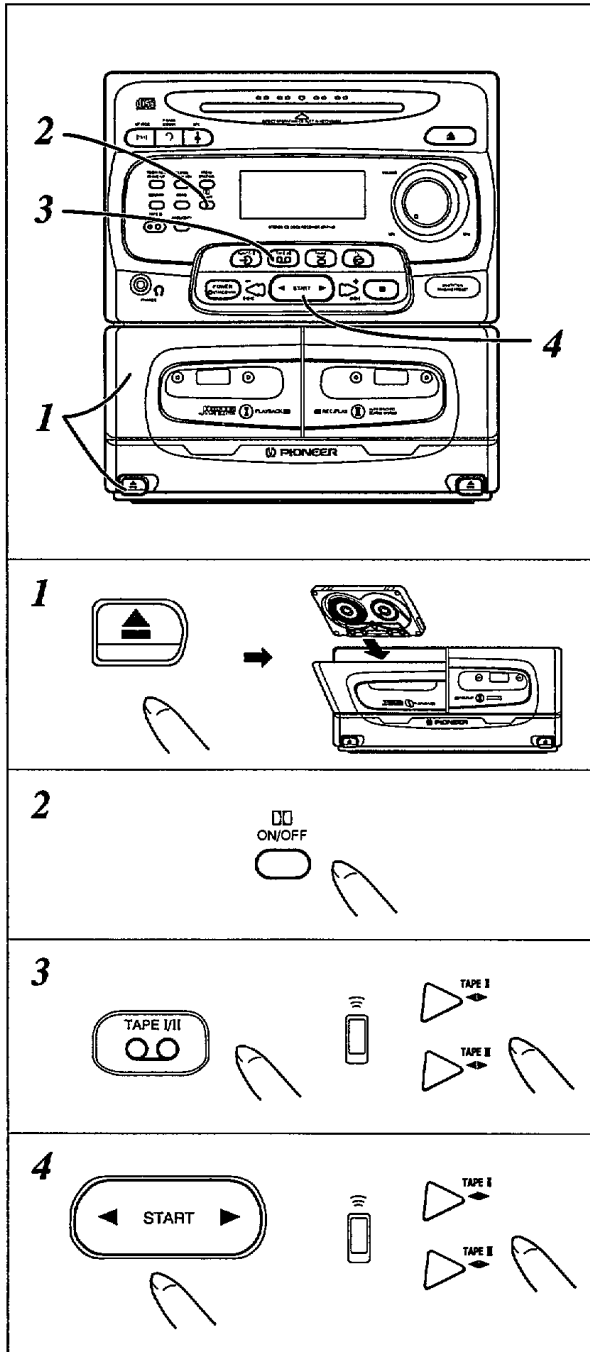

Basic operation

- Tapes may be played back in TAPE I or TAPE II but not in both decks at the same time.

1. Press Eject button (▲) and load a recorded tape, then push in the cassette door until it locks.

For relay playback, load tapes into TAPE I and TAPE II. Relay playback is repeated as follows (32 sides maximum):

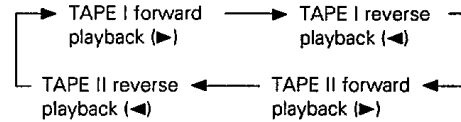

If there is a tape in only one deck, that deck continuously plays both sides of the tape (16 sides maximum).

2. Set DOLBY NR to the same position used for recording.

Tapes recorded using Dolby noise reduction should always be played back with the noise reduction system on.

Each press of the button alternates ON and OFF as shown below.

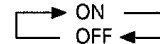

3. Select TAPE I or TAPE II, whichever is desired to playback, with the TAPE (I/II) function button.

When a tape is loaded, the loaded deck will automatically be selected.

Each press of the button alternates TAPE I and TAPE II as shown below.



4. Press START ◀ or ▶ to select direction.

Each press of START alternates the tape direction as shown below.

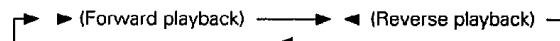

When you use the remote control unit, press the START button (◀▶) for the deck you choose to play (TAPE I or II).

To stop playback:

Press the Stop button (■) (or ◻ on the remote control unit).

To fast forward or rewind:

In the stop mode, press ◀ or ▶.

- This cassette deck automatically plays both side of a tape.

NOTES:

- Do not press the Eject button (▲) while the tape is running.
- Confirm that the cassette deck has stopped before pressing the Eject button (▲).

Auto Stop Mechanism

This mechanism automatically stops the tape when the end of the tape is reached during fast forward or reverse (◀ or ▶).

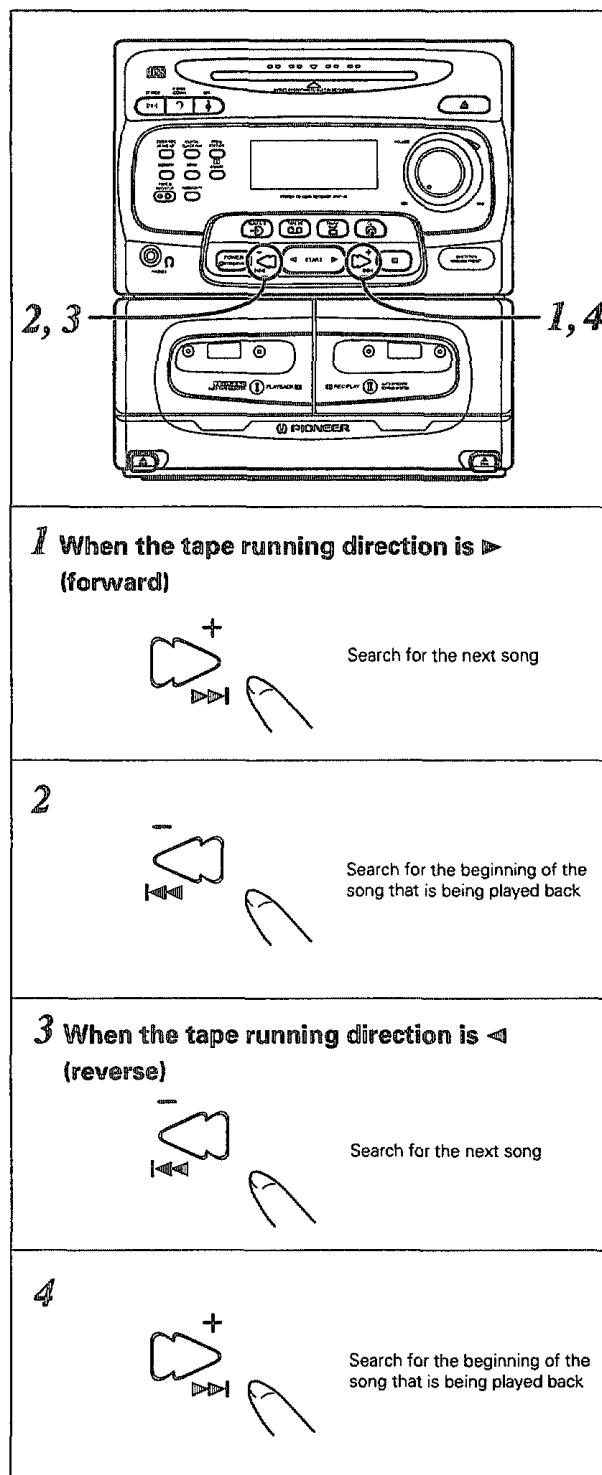

For playing back from the beginning of a song (MUSIC SEARCH function)

- When there is an unrecorded portion of 4 seconds or more between two successive songs, it is possible to return to the beginning of the song that is being played back or to search for the next song.

<When the tape running direction is ► (forward)>

1. Push the fast forward button (⏮⁺) to search for the next song during playback.

2. Push the rewind button (⏪) to return to the beginning of the song that is being played back.

<When the indication of the tape running direction is ◀ (reverse)>

3. Push the rewind button (⏪) to search for the next song during playback.

4. Push the fast forward button (⏮⁺) to return to the beginning of the song that is being played back.

NOTES:

The music search function may not work correctly when the following tapes are being played back.

- Tapes that do not have unrecorded portions of 4 seconds or more between songs.
- Tapes containing music with long intervals of low sound such as classical music.
- Tapes with interruption of sound, such as meetings and language study tapes.
- Tapes containing noise in the unrecorded portions.

RECORDING

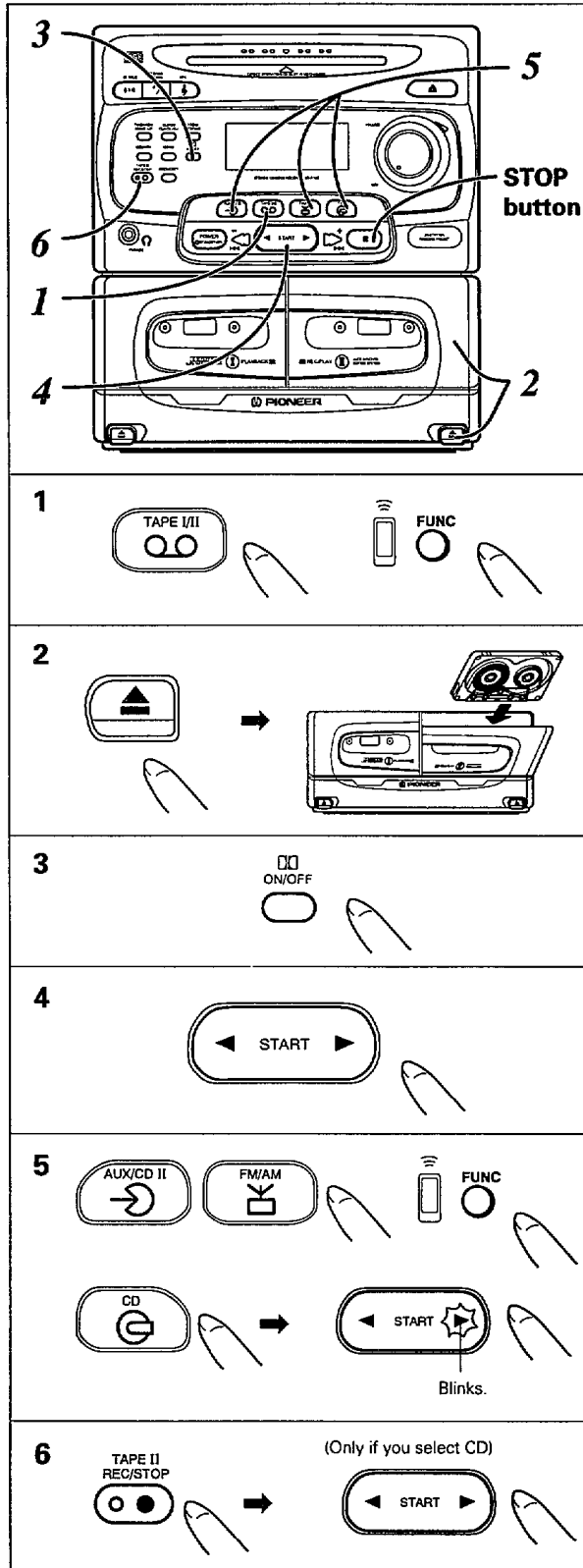

Recording on a tape

- This deck is equipped with an auto-reverse function, when recording finishes in the ► direction, recording automatically starts in the ◀ direction. If you only want to record on one side of the tape, record in the ◀ direction, or break off the accidental erasure prevention tab on the side you don't want to record on.
- Use **TYPE I (Normal) and TYPE II (HIGH/CrO₂) tapes.** TYPE IV (METAL) tapes cannot be used.

1. Press the TAPE function button.

2. Load the tape for recording into TAPE II.

Wind the tape forward past the leader to the start of the magnetic coated portion.

3. Press the DOLBY NR switching button to select the ON/OFF state of the Dolby NR function.

The ON and OFF states alternate each time this button is pressed.

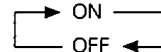

4. Press the START button (◀ or ►) of the direction you want to record.

The indicator in the display shows the direction in which recording will start.

Press STOP (■) after choosing the recording direction.

5. Press one of the AUX/CDII, tuner (FM/AM) or CD input function buttons of main unit to select the component to be recorded.

On the remote control unit, press the FUNC button to select the component to be recorded.

(If you selected CD, insert a disc and press START to pause the CD player.)

6. Press the Rec/Rec stop button (●) to start recording.

(If you selected CD, press START to start playback.)

7. Play the program source to be recorded.

The recording level is automatically adjusted.

Play the program source to be recorded.

To stop recording:

Press the Rec/Rec stop button (●) (or  on the remote control unit).

- In the recording mode, the input source cannot be changed.
- In the recording mode, the sound field control and ST.WIDE do not function.
During recording with P.BASS, the playback sound is heard with P.BASS, but not recorded.
- This unit automatically sets the recording level by ALC (Auto Level Control) function.

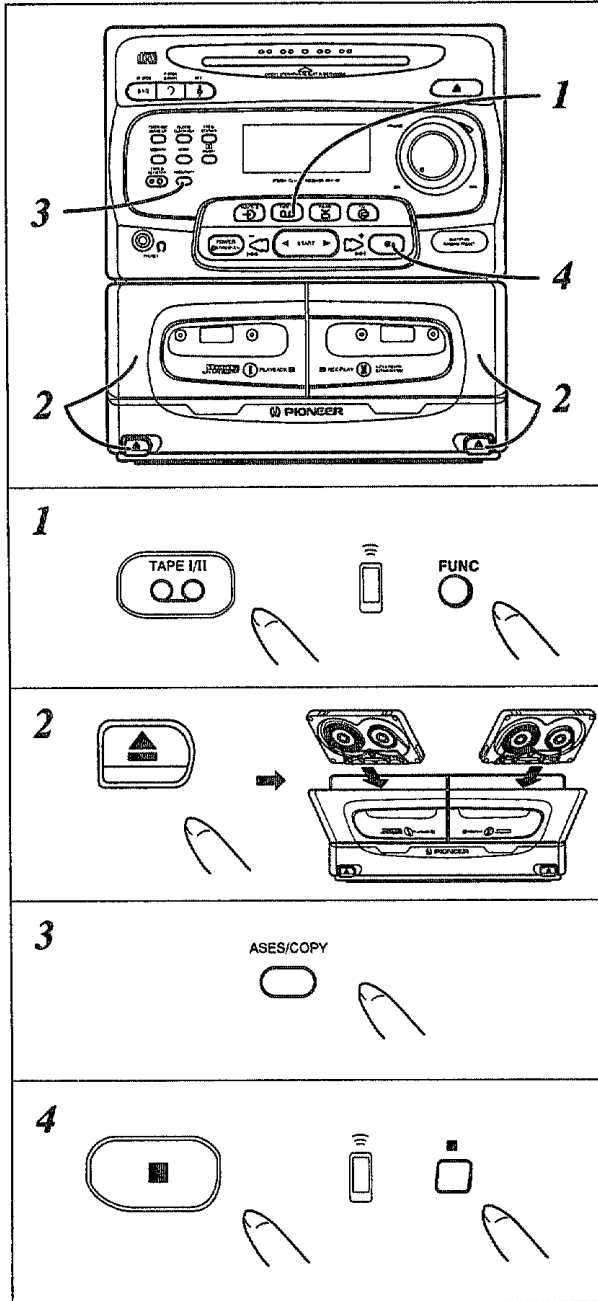

Copying a tape

- Use TAPE II to record.
- The copy begins from the forward side (▶).

1. Press the TAPE (I/II) function button of the main unit to select the cassette tape input function.

On the remote control unit, select the cassette deck input with the FUNC button.

2. Insert the recorded tape in TAPE I and insert the tape to be recorded in TAPE II.

- Check the running directions of the recorded tape and the tape to be recorded.
- Run the tape to be recorded out of the leader portion for the magnetic portion to be exposed.

3. Press the ASSES/COPY button.

The copy starts.

4. To stop the copying ...

Press the Stop button (■) (on the remote control unit, press the TAPE I or TAPE II Stop button (■)). Both decks will stop simultaneously.

NOTES:

- The copied tape is recorded with the same setting as the tape in the playback side, irrespective of the setting of the Dolby NR switching button.
- When you want to copy only one side, break the accidental erasure prevention tab of the side you do not want to record, and insert the tape with the side to be recorded facing outside.

HOW TO HANDLE CASSETTE TAPES

A.S.E.S. (Auto Synchro Editing System)

For automatic recording of a CD to a cassette tape.

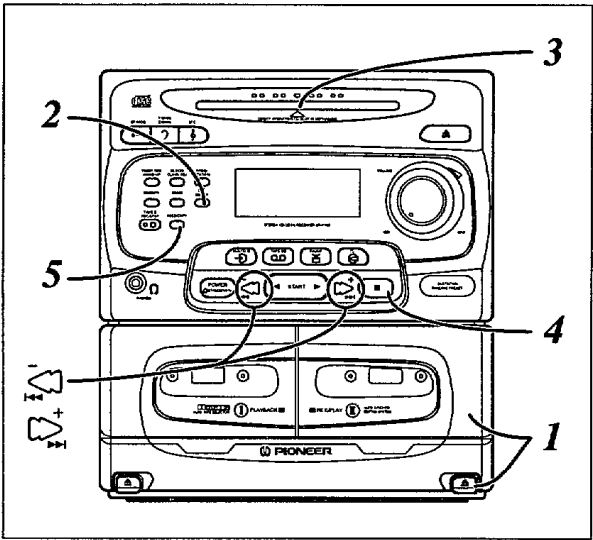

- Recording starts in the forward (▶) direction.
- When recording on both sides, and the tape ends in the middle of a track in the forward (▶) direction, recording starts from the beginning of the track when it continues in the reverse (◀) direction.

- 1. Load the tape for recording into TAPE II.**
Recording should begin in the forward direction (▶).
- 2. Set DOLBY NR to the desired position.**
- 3. Insert the CD in the disc slot.**
If a CD is already loaded, press the CD function button.
- 4. Press the Stop button (■).**
When programming is performed, tracks will be played in the programmed order.

If a track number of the CD is selected using the or button, the recording will start from that track and continues on subsequent tracks. If no track is selected here, the recording will start from track No. 1 of the CD.

- 5. Press the ASES/COPY button.**
The A.S.E.S. operation starts.

To stop A.S.E.S. during recording:
Press the Stop button (■) (or on the remote control unit).

- When A.S.E.S. is activated, this unit sometimes operates incorrectly, for example, the present track is skipped and the next track is played back.
When the CD finishes playback, the A.S.E.S. function stops. In this case, record the skipped track without using the A.S.E.S. function.
- If the CD player is set for all-track repeat playback, it is possible to record a tape without leaving any space on it.
- If the CD player has been programmed, A.S.E.S. records the tracks in the programmed order.

Is the tape loose, or is some of the tape sticking out of the cassette?

This will damage the tape itself. To remove the slack, insert a pencil into the spool and gently wind it.

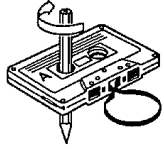

Safekeeping
Put the cassette tape back into its case and store it in a location away from exposure to magnetic fields, humidity, dust, or oil.



- ### TIPS ON USING CASSETTE TAPES
- Leader tape (which does not allow sound to be recorded over it) is provided at the beginning of a cassette tape. Start recording after allowing the tape to run for approx. 5 seconds so that the leader tape clears the recording head.
 - Forwarding or reversing the cassette tapes before recording prevents shock to the unit caused by slack.

Do not use tapes longer than 90 minutes.
Since tapes longer than 90 minutes are extremely thin, they easily jam in the pinch roller and capstan, and they are susceptible to other trouble such as irregular winding. Try not to use them with this unit.

How can you prevent accidental erasure?
When the tab on the cassette shell is broken out with the tip of a screwdriver, it will not be possible to activate the recording function even by pressing the Rec/Rec stop button (●), so valuable recordings will not be erased in error.

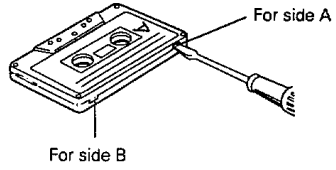

When you want to record again on a cassette with broken erasure prevention tabs, cover the hole with a double layer of adhesive tape. With TYPE II (HIGH/CrO2) tapes, be sure not cover the tape-type detection holes.

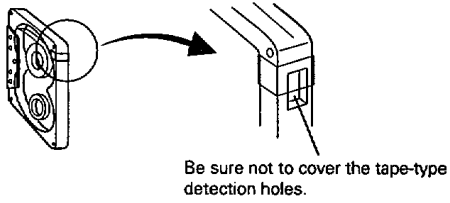

Cleaning the head section

The heads, capstans and pinch rollers are parts which are liable to become dirty quite easily. In particular, if the heads are dirty, the high frequency components of the sound will not be reproduced and the stereo balance will be impaired, resulting in a deterioration of sound quality. It is therefore recommended that the head section be cleaned regularly.

1. Turn the power off.
2. Press Eject button (▲) to open the cassette door
3. Dip a cleaning swab into head cleaning fluid and use it to wipe the head, capstans, and pinch rollers. Wait 2-3 minutes until the cleaning fluid dries.

NOTE:

This unit uses a head-slant standby system, with the result that the heads are mounted at an angled position.

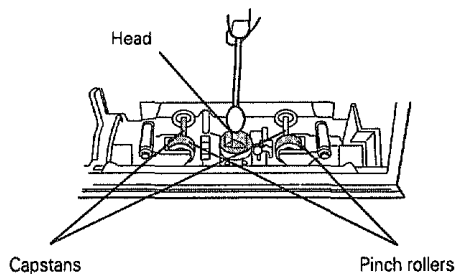

The illustration shows TAPE II.

Demagnetizing the cassette deck heads

The deck heads may become magnetized after the deck has been used for a long period of time, or if a magnet or other magnetized object (screwdriver, etc.) is brought near the heads. Magnetization of the heads results in increased noise and reduced ability to reproduce high-frequency sounds.

In this case, please use a commercially available head demagnetizer at regular intervals to eliminate the magnetic field on the heads. When using a head demagnetizer, turn this unit's power switch ON. In order to prevent adverse effects on the receiver and speakers, however, **be sure to turn down the receiver's volume control to its lowest position**, and disconnect any headphones from their headphones jack. For details, consult the instructions accompanying your head demagnetizer.

Maintenance of external surfaces

- Use a polishing cloth or dry cloth to wipe off dust and dirt.
- When the surfaces are very dirty, wipe with a soft cloth dipped in some neutral cleanser diluted five or six times with water and wrung out well, then wipe again with a dry cloth. Do not use furniture wax or cleaners.
- Never use thinners, benzene, insecticide sprays or other chemicals on or near this unit, since these will corrode the surfaces.

SOUND FIELD CONTROL OPERATION

Selecting a preset sound setting

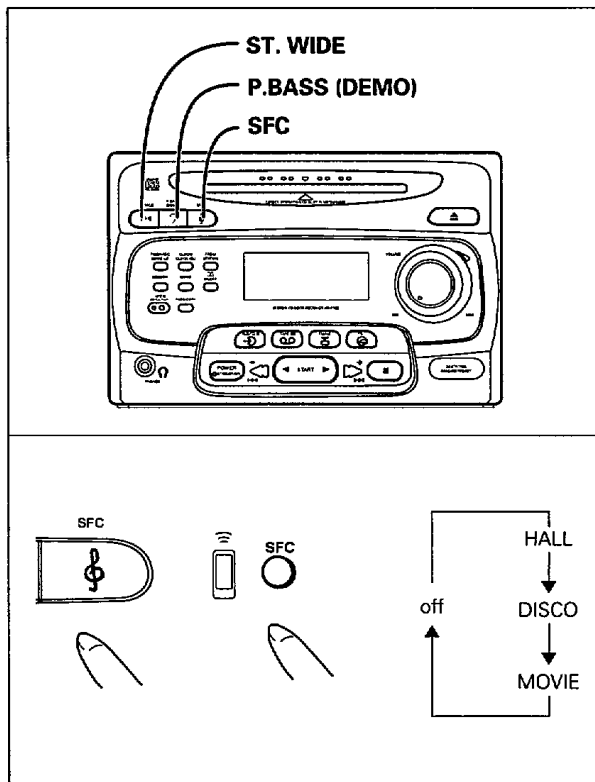

Select one of the three settings with the SFC button or the SFC button on the remote control unit.

- HALL:** Provides a reverberation effect like that produced in a concert hall.
- DISCO:** This boosts bass and treble to deliver a powerful, more dynamic sound
- MOVIE:** Naturally reproduces the conversations and effect sound, and provides wide and dynamic acoustics. This is effective with movie softwares.

To clear SOUND FIELD CONTROL settings:

Press the SFC button until OFF is selected or press the SFC button on the remote control unit until OFF is selected.

NOTES:

- Press the SFC button once, and the current mode is displayed. Press again, and the mode changes.
- If a Sound Field Control is selected, ST.WIDE and P.BASS are canceled.

ADJUSTING THE SOUND

Creating an expansive sound field (STEREO WIDE mode)

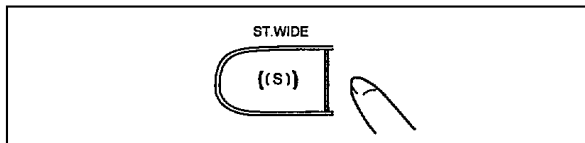

Each time the ST.WIDE button is pressed, the setting of the STEREO WIDE mode changes in the following sequence:

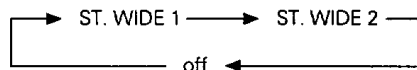

ST. WIDE 1:

Creates a more expansive sound field compared with the normal sound field.

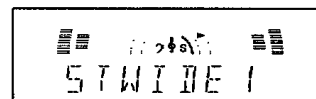

ST. WIDE 2:

Creates a more expansive sound field compared with ST. WIDE 1.

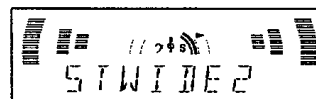

NOTE:

If ST. WIDE is selected, SFC (Sound Field Control) and KARAOKE are canceled.

Boosting the bass sound

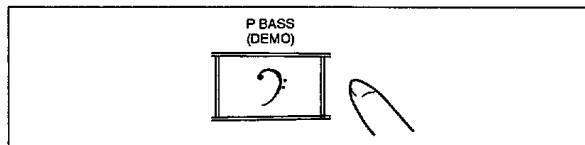

Each time the P.BASS (DEMO) button is pressed, the setting of the P.BASS mode changes in the following sequence:

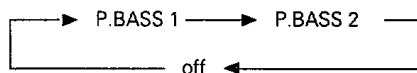

P. BASS 1

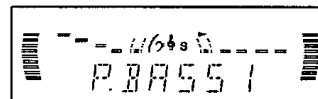

P. BASS 2

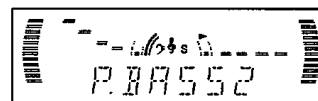

NOTE:

If P. BASS is selected, SFC (Sound Field Control) is canceled.

TIMER PLAYBACK/TIMER RECORDING

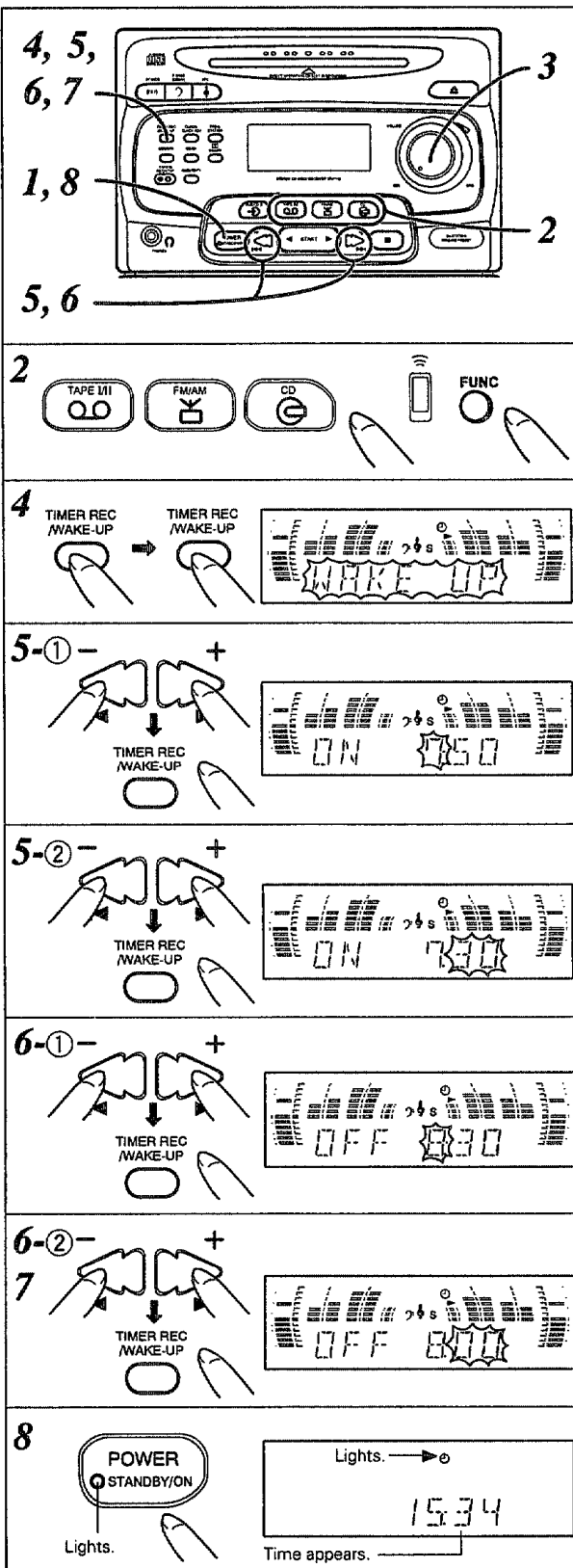

Setting the WAKE-UP timer

Example: Using TIMER from 7:30 to 8:00

1. **Switch power ON.**
2. **Select the input function to be played to wake you up.**
 CD: Load the CD.
 Tuner: Select the station.
 TAPE: Load the cassette tape. (Playback starts from TAPE I forward playback (▶).)
 If the TAPE or CD input function is selected on the main unit, it is played immediately so you also have to press the Stop button (■) to stop it.
3. **Set volume to the desired level.**
4. **Press the TIMER REC/WAKE-UP button twice.**
5. **Set the timer start time.**
 - ① Set the hour.
 Set the hour using the or button, and then press the TIMER REC/WAKE-UP button.
 - ② Set the number of minutes.
 Set the number of minutes using the or button, and then press the TIMER REC/WAKE-UP button.
6. **Set the timer finish time.**
 - ① Set the hour.
 Set the hour using the or button, and then press the TIMER REC/WAKE-UP button.
 - ② Set the number of minutes.
 Set the number of minutes using the or button.
7. **Press the TIMER REC/WAKE-UP button, and the set time is automatically confirmed.**
 After a few seconds confirmation is completed, and the display returns to the original indications.
 (The timer operates at the set time.)
8. **Turn power off.**
 The system enters the STANDBY mode.
 The timer indicator (⊙) lights on the display.
Set up is complete.

To reset:

Press the TIMER REC/WAKE-UP button when the timer indicator (⊙) is lit.

NOTES:

- The wake-up timer works every day at the same hour, unless it is reset.
- When sleep is set during the timer operation, the earlier OFF time has priority.
- The timer is reset when the TIMER button is pressed during its operation.
- The wake-up timer and timer recording functions can not be used at the same time.

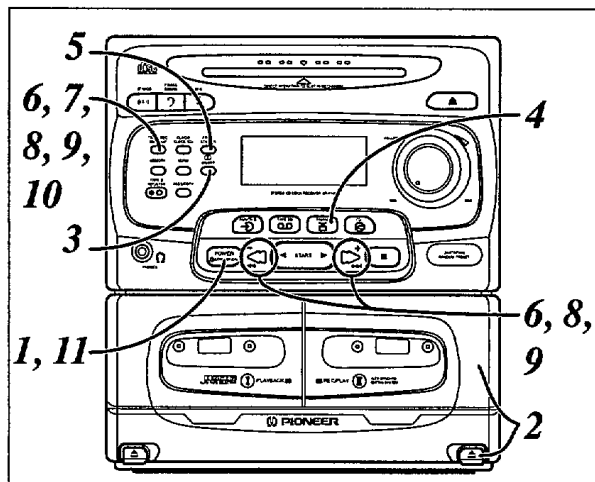

1 Goes out.

2 →

3

4

5 →

6 → →

7 →

(continued)

Timer recording setting

Timer recording is only possible with the tuner.

Example: Using TIMER from 7:30 to 8:00

- 1. Switch power ON.**
- 2. Load the tape for recording into TAPE II.**
Recording starts in the forward direction (▶).
- 3. Select the DOLBY NR ON or OFF.**
- 4. Press the AM or FM button.**
- 5. Press the FREQ/STATION button then tune in the station to be recorded.**
- 6. Press the TIMER REC/WAKE-UP button.**
When "WAKE UP" appears blinking on the display, press either the ◀ or ▶ button so that blinking "REC" is displayed.
- 7. Press the TIMER REC/WAKE-UP button.**
(The system enters the time setting mode.)
- 8. Set the timer start time.**
 - ① Set the hour.
Set the hour using the ◀ or ▶ button, and then press the TIMER REC/WAKE-UP button.
 - ② Set the number of minutes.
Set the number of minutes using the ◀ or ▶ button, and then press the TIMER REC/WAKE-UP button.
- 9. Set the timer finish time.**
 - ① Set the hour.
Set the hour using the ◀ or ▶ button, and then press the TIMER REC/WAKE-UP button.
 - ② Set the number of minutes.
Set the number of minutes using the ◀ or ▶ button.
- 10. Press the TIMER REC/WAKE-UP button, and the set time is automatically confirmed.**
After a few seconds confirmation is completed, and the display returns to the original indications
(The timer operates at the set time.)
- 11. Turn power off.**
The system enters the STANDBY mode.
The timer indicator ("⌚", "REC" and the current time) lights on the display.
Set up is complete.

To change timer settings

To change all of the timer settings, start over again, inputting the settings that you want.

If you make a mistake while setting the timer

Go ahead to next item and continue setting various items until you finish. Then use the "To change timer settings" procedure to change the setting that was incorrect

TIMER PLAYBACK/TIMER RECORDING

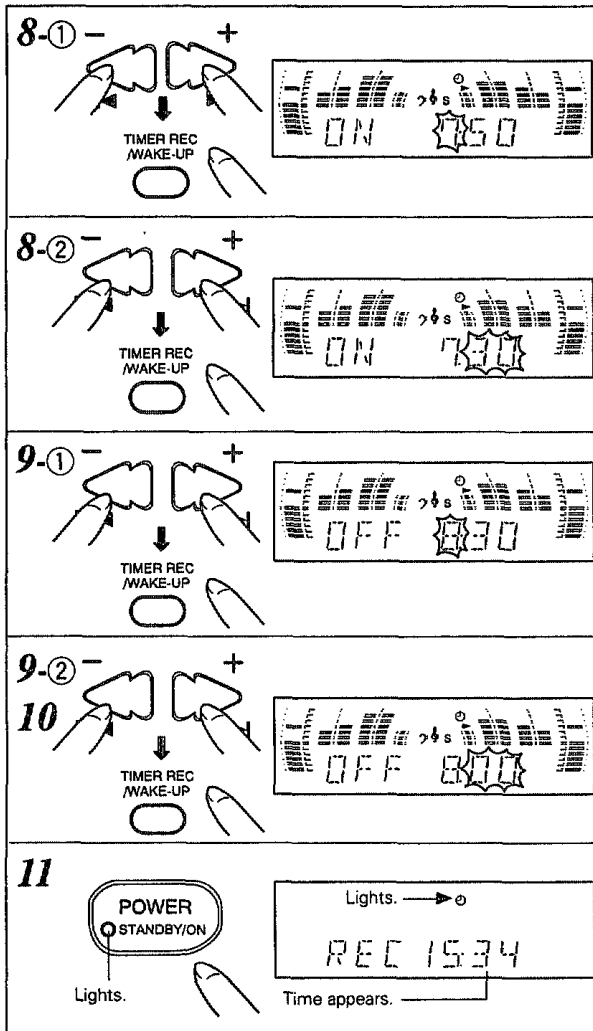

To select the timer to be activated in case both the wake-up timer and recording timer have been set

Each press of the TIMER REC/WAKE-UP button changes the activated timer as shown below.

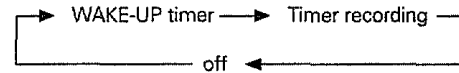

To deactivate WAKE-UP timer and timer recording

- When timer setting operation has been completed, the timer indicator lights to indicate that the timer has been set. To deactivate the timer setting, press the TIMER REC/WAKE-UP button. (The timer indicator goes off.)
- Pressing the TIMER REC/WAKE-UP button during timer operation stops it.

NOTES:

- Once the timer is set, you can display the timer settings by pressing the TIMER REC/WAKE-UP button while in standby mode.
- Timer recording is reset when it is carried out once, or when the power is turned ON and OFF (STANDBY).

SLEEP TIMER

(Example) Automatically switches the power off after 30 min.

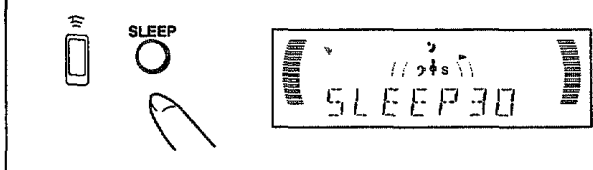

- If you switch to the sleep mode when the cassette deck is playing or recording, or when a CD is playing, "AUTO SLEEP" is set.
- AUTO SLEEP lets you set the unit so that power automatically switches OFF when play ends on the cassette player or CD player.

Sleep timer - Automatically turns off the power

Power turns off automatically after the specified time has elapsed. Each time the SLEEP button is pressed, the setting changes in the following sequence:

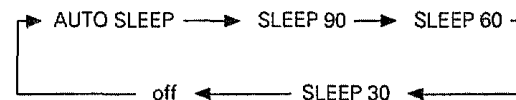

NOTE:

If you press the SLEEP button during Sleep operation, the time remaining till the power turns off is displayed. Do not press the SLEEP button when the remaining time is displayed. Otherwise, the setting changes and the sleep timer cannot function properly.

TROUBLESHOOTING

Incorrect operations are often mistaken for trouble and malfunctions. If you think that there is something wrong with this component, check the points below. Sometimes the trouble may lie in another component. Investigate the other components and electrical appliances being used. If the trouble cannot be rectified even after exercising the checks listed below, ask your nearest PIONEER authorized service center or your dealer to carry out repair work.

	Symptom	Cause	Remedy
General	No sound from speakers.	<ul style="list-style-type: none"> AC cord is unplugged. All cords are not connected properly. 	<ul style="list-style-type: none"> Plug power cord into wall socket correctly. Connect cords correctly referring to CONNECTIONS on page 5.
		<ul style="list-style-type: none"> Function is not set to the desired listening source on the receiver. 	<ul style="list-style-type: none"> Select correct function.
Cassette tape deck	Cassette door does not open.	<ul style="list-style-type: none"> Power cord was unplugged while the tape was running. 	<ul style="list-style-type: none"> Plug in the power cord.
	Cannot record.	<ul style="list-style-type: none"> Erase prevention tabs are broken off. 	<ul style="list-style-type: none"> Use a cassette that can be recorded on, or apply adhesive tape over the tab holes.
	Sound is muffled. Previously recorded sounds remain.	<ul style="list-style-type: none"> Dirty heads. 	<ul style="list-style-type: none"> Clean heads. (Refer to page 22.)
	Sound is muffled. Treble tones too strong.	<ul style="list-style-type: none"> Tape recorded with DOLBY NR but played without. 	<ul style="list-style-type: none"> Turn on DOLBY NR system for tapes recorded with DOLBY NR.
	The Music Search (MS) does not work.	<ul style="list-style-type: none"> The unrecorded interval between two songs is shorter than 4 seconds. The fast forward or rewind operation is started from stop mode. 	<ul style="list-style-type: none"> Change with a tape having at least a 4-seconds unrecorded interval between two songs. (Refer to page 18.) First put the tape deck in play mode then press the fast forward or rewind button.
CD player	Playback does not start.	<ul style="list-style-type: none"> Disc is loaded upside down. Dirt, blur, etc. on the disc. Disc has a bad scratch or warp. 	<ul style="list-style-type: none"> Load a disc correctly with the label side (printed side) UP. Clean the disc. Replace the disc. (Refer to page 13.)
Tuner	Sound is distorted.	<ul style="list-style-type: none"> Antenna is not connected. Antenna is in poor position. Interference from nearby fluorescent light, hair dryer, or other electrical appliance. 	<ul style="list-style-type: none"> Connect the antenna correctly. Change the antenna position. Stop using device causing interference. (Refer to page 6.)
	There is no stereo sound.	<ul style="list-style-type: none"> The MONO indicator in the display window on the receiver lights up. 	<ul style="list-style-type: none"> Press MONO so that the MONO indicator goes out. (Refer to page 11.)
Others	Timer does not work.	<ul style="list-style-type: none"> Current time is not set. 	<ul style="list-style-type: none"> Set current time.
	Remote control does not work.	<ul style="list-style-type: none"> Batteries are run down. A fluorescent light is shining on the remote sensor window. 	<ul style="list-style-type: none"> Replace with new batteries. Move the unit away from the fluorescent light. (Refer to page 4.)

Abnormal functioning of this unit may be caused by static electricity or other external interference. To restore normal operation, turn the power off and then on again, or unplug the AC power cord and then plug it in again.

SPECIFICATIONS

STEREO CD CASSETTE DECK RECEIVER

Amplifier section

<XR-P160>

Continuous Power Output (RMS)	35 W + 35 W (1 kHz, T.H.D. 10 % 6 Ω)
Continuous Power Output (DIN)	27 W + 27 W (1 kHz, T.H.D. 1 % 6 Ω)

- Above specifications are for when power supply is 230 V.

FM/AM Tuner section

FM tuner section

Frequency Range	87.5 MHz to 108 MHz
Antenna input	75 Ω unbalanced

AM tuner section

Frequency Range	With 9 kHz step
Antenna	531 kHz to 1,602 kHz Loop antenna

CD section

Type	Compact disc digital audio system
Wow and Flutter	Limit of measurement (±0.001 % W.PEAK) or less (EIAJ)

Cassette deck section

Systems	4 track, 2-channel stereo
Heads	Recording/playback head x 1 Playback head x 1 Erasing head x 1
Motor	DC servo motor x 1
Tape type	TYPE I (Normal)/TYPE II (HIGH/CrO ₂) tape

Miscellaneous

Power Requirements	AC 230 V, 50/60 Hz (U.K. model) AC 220 - 230 V, 50/60 Hz (European model)
Power Consumption	187 W
Dimensions	240 (W) x 270 (H) x 297 (D) mm
Weight (without package)	5.5 kg

SPEAKER SYSTEM: S-P160

Enclosure	Bass-reflex bookshelf type
System	2-way system
Loudspeakers:	
Woofer	12-cm cone type
Tweeter	5.2-cm cone type
Nominal Impedance	6 Ω
Frequency Response	40 Hz - 20 kHz
MUSIC POWER (DIN)	35 W
Dimensions	170 (W) x 270 (H) x 232 (D) mm
Weight	2.3 kg

Accessories

Operating instructions	1
Remote control unit	1
AAA/R03 dry cell batteries	2
FM T-type antenna	1
AM loop antenna	1

NOTE:

Specifications and design subject to possible modification without notice, due to improvement.

Published by Pioneer Electronic Corporation.
Copyright © 1996 Pioneer Electronic Corporation.
All rights reserved.

PIONEER ELECTRONIC CORPORATION

4-1, Meguro 1-Chome, Meguro-ku, Tokyo 153, Japan

PIONEER ELECTRONICS [USA] INC. P.O. BOX 1540, Long Beach, California 90801-1540

PIONEER ELECTRONICS OF CANADA, INC. 300 Allstate Parkway, Markham, Ontario L3R 0P2, Canada

PIONEER ELECTRONIC [EUROPE] N.V. Haven 1087, Keetberglaan 1, 9120 Melsele, Belgium TEL: 03/570.05.11

PIONEER ELECTRONICS AUSTRALIA PTY. LTD. 178-184 Boundary Road, Braeside, Victoria 3195, Australia, TEL: [03] 580-9911

PIONEER ELECTRONICS DE MEXICO S.A. DE C.V. Augusto Rodin No.128 PB Col. San Juan Mixcoac Mexico D.F. CP.03730 TEL: 52-5-598-3950

<96B00WF0A00>

Printed in the U K <ARB7062-A>

Free Manuals Download Website

<http://myh66.com>

<http://usermanuals.us>

<http://www.somanuals.com>

<http://www.4manuals.cc>

<http://www.manual-lib.com>

<http://www.404manual.com>

<http://www.luxmanual.com>

<http://aubethermostatmanual.com>

Golf course search by state

<http://golfingnear.com>

Email search by domain

<http://emailbydomain.com>

Auto manuals search

<http://auto.somanuals.com>

TV manuals search

<http://tv.somanuals.com>