

Pioneer *sound.vision.soul*

6-Disc Multi-DVD Player

ENGLISH

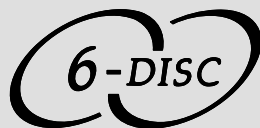

Owner's Manual

XDV-P90

This product conforms to CEMA cord colors.



Dear Customer:

Selecting fine audio equipment such as the unit you've just purchased is only the start of your musical enjoyment. Now it's time to consider how you can maximize the fun and excitement your equipment offers. This manufacturer and the Electronic Industries Association's Consumer Electronics Group want you to get the most out of your equipment by playing it at a safe level. One that lets the sound come through loud and clear without annoying blaring or distortion—and, most importantly, without affecting your sensitive hearing.

Sound can be deceiving. Over time your hearing "comfort level" adapts to higher volumes of sound. So what sounds "normal" can actually be loud and harmful to your hearing. Guard against this by setting your equipment at a safe level BEFORE your hearing adapts.

To establish a safe level:

- Start your volume control at a low setting.
- Slowly increase the sound until you can hear it comfortably and clearly, and without distortion.

Once you have established a comfortable sound level:

- Set the dial and leave it there.

Taking a minute to do this now will help to prevent hearing damage or loss in the future. After all, we want you listening for a lifetime.

We Want You Listening For A Lifetime

Used wisely, your new sound equipment will provide a lifetime of fun and enjoyment. Since hearing damage from loud noise is often undetectable until it is too late, this manufacturer and the Electronic Industries Association's Consumer Electronics Group recommend you avoid prolonged exposure to excessive noise. This list of sound levels is included for your protection.

Decibel

Level	Example
30	Quiet library, soft whispers
40	Living room, refrigerator, bedroom away from traffic
50	Light traffic, normal conversation, quiet office
60	Air conditioner at 20 feet, sewing machine
70	Vacuum cleaner, hair dryer, noisy restaurant
80	Average city traffic, garbage disposals, alarm clock at two feet.

THE FOLLOWING NOISES CAN BE DANGEROUS UNDER CONSTANT EXPOSURE

90	Subway, motorcycle, truck traffic, lawn mower
100	Garbage truck, chain saw, pneumatic drill
120	Rock band concert in front of speakers, thunderclap
140	Gunshot blast, jet plane
180	Rocket launching pad

Information courtesy of the Deafness Research Foundation.



Important

The serial number of this device is located on the bottom of this product. For your own security and convenience, be sure to record this number on the enclosed warranty card.

Precaution

CAUTION: USE OF CONTROL OR ADJUSTMENT OR PERFORMANCE OF PROCEDURES OTHER THAN THOSE SPECIFIED HEREIN MAY RESULT IN HAZARDOUS RADIATION EXPOSURE.

CAUTION: THE USE OF OPTICAL INSTRUMENTS WITH THIS PRODUCT WILL INCREASE EYE HAZARD.

Information to User

Alteration or modifications carried out without appropriate authorization may invalidate the user's right to operate the equipment.

After-sales Service for Pioneer Products

Please contact the dealer or distributor from where you purchased the product for its after-sales service (including warranty conditions) or any other information. In case the necessary information is not available, please contact the companies listed below:

Please do not ship your product to the companies at the addresses listed below for repair without advance contact.

■ U.S.A.

Pioneer Electronics (USA) Inc.
CUSTOMER SUPPORT
DIVISION
P.O. Box 1760
Long Beach, CA 90801-1760
800-421-1404

■ CANADA

Pioneer Electronics of Canada, Inc.
CUSTOMER SATISFACTION
DEPARTMENT
300 Allstate Parkway
Markham, Ontario L3R 0P2
(905) 479-4411
1-877-283-5901

For warranty information please see the Limited Warranty sheet included with your product.

Contents

Be sure to read this.

Discs Compatible with this Product	9
Disc Operation	10

Before Using 3

Before Using This Product	3
● About This Product	
● About This Manual	
● How to Use This Manual	
● To Ensure Safe Driving	
● Precaution	
● Preventing the Battery from Becoming Exhausted	
● Changing the Mode Switch Setting	
● Condition Memory	
● Resetting the Microprocessor	
Key Finder	7
Using the Remote Controller	8
● Battery	
Discs Compatible with this Product	9
● Features of This Player	
● What the Marks on DVDs Indicate	
● Disc Organization	
Main Features of This Product	12
Care of Discs and Magazines	13
● Precaution	
Loading Discs	14
● Loading Discs	
● Loading the Magazine	
● Removing the Magazine	

Basic Operations 17

Switching Power ON/OFF	17
● Switching Power ON	
● Switching Power OFF	

Disc (DVD/Video CD/CD) Playback	19
● Working with the Menu Screen	
Chapter and Track Advance/Return	20
● Skipping to the Next Chapter/Track	
● Returning to the Previous Chapter/Track	
Specifying Title/Chapter/Track (Direct Search)	21
● Specifying Title	
● Specifying Chapter	
● Specifying Track	
Disc Fast Forward/Reverse	22
● Fast Forward	
● Fast Reverse	
Changing Discs	23
Stopping Playback	23

Playback Variations 24

Still, Frame-by-Frame and Slow Motion Playback	24
● Still Playback	
● Frame-by-Frame Playback	
● Slow Motion Playback	
Changing Audio Language during Playback (Multi-Audio)	26
Changing Audio Output during Playback	26
Changing the Subtitle Language during Playback (Multi-Subtitle)	27
Changing the Viewing Angle during Playback (Multi-Angle)	28

Operating with Information Displays 29

Calling up Information Displays	29
Operating with the Information Display 1 of a DVD	30
● Searching for a Desired Scene, Starting Playback from a Specified Time	
● Selecting Audio, Subtitle and Angle	
Operating with the Information Display 2 of a DVD	32
● Switching Discs	
● Selecting Repeat Range	
● Selecting the Picture Mode	

Operating with the Information	
Display 1 of a Video CD	33
● Searching for a Desired Scene,	
Starting Playback from a	
Specified Time	
● Selecting Repeat Range	
● Selecting Audio Output	
Operating with the Information	
Display 2 of a Video CD	36
● Switching Discs	
● Selecting the Picture Mode	
Operating with the Information	
Display 1 of a CD	37
● Searching for a Desired Track	
● Selecting Repeat Range	
● Setting Random Play	
● Setting Scan Play	
Operating with the Information	
Display 2 of a CD	39
● Switching Discs	
Changing Initial Settings	40
Calling up the SET UP MENU	40
Setting the Subtitle	
(SUBTITLE LANG.)	41
● Setting Subtitles and Assist	
Subtitles ON/OFF	
● Setting the Subtitle Language	
Setting the Audio Language	
(AUDIO LANG.)	43
Setting the Menu Language	
(MENU LANG.)	44
Setting the Parental Lock (PARENTAL)	44
● Setting the Code Number and Level	
● Changing the Level	
Setting Aspect Ratio (TV ASPECT)	47
Setting for Digital Output	
(DIGITAL OUTPUT)	48
Setting Digital and Analog Audio Output	
(OUT SELECTION)	49
Setting Angle Selection Mark Display	
(ANGLE)	50

Others	51
Switching the Remote Control Operation	
Mode Switch	51
Switching the Remote Control Code	
Selection Switch	52
Operating with the Head Unit	53
● Switching Power ON	
ITS Playback	54
Troubleshooting	55
If You Forget Your Code Number	59
Error Message	59
Language Code Chart	60
Terms	61

Installation	63
Connecting the Units	63
● Connecting the Power Cord	
● Connection Diagram	
Transportation of Multi-DVD Player	71
Installation	72
● MODE Switch Setting	
● Installing the DVD Player Unit	
Installing the Remote Sensor	75

Appendix	77
Index	77
Specifications	78

Before Using

Before Using This Product

About This Product



CAUTION

This product does not automatically change discs. To change a disc, follow the instructions on page 23.

Video System of a Connected Component

This product is NTSC system compatible. When connecting other components to this product, be sure components are compatible with the same video systems. If it is not, images will not be correctly reproduced.

About This Manual

We recommend that you familiarize yourself with the functions and their operation by reading through the manual before you use this product. It is especially important that you read and observe the "Precaution".

How to Use This Manual

This manual is divided into the sections shown below.

Before Using:	Explanations of operations you should perform before using this product.
Basic Operations:	Explanations of basic audio, video and other operations.
Playback Variations:	Explanations of how to enjoy various playback modes.
Operating with Information Displays:	Explanations of how to operate this product using Information Displays.
Changing Initial Settings:	Explanations of how to use this product's SET UP MENU.

There is an index at the edge of each page in this manual.

Each section's heading is printed vertically at the top of the left hand page. Each section's heading is also printed vertically at the edge of the right hand page, together with indications of the discs the explanations apply to.

Please use these handy headings and indications when searching for information.

To Ensure Safe Driving

WARNING

- To avoid the risk of accident and the potential violation of applicable laws, this product is not for use with a video screen that is visible to the driver.
- In some countries or states the viewing of images on a display inside a vehicle even by persons other than the driver may be illegal. Where such regulations apply, they must be obeyed.

This product detects whether your car's parking brake is engaged or not, and prevents you from watching a DVD or Video CD on the display connected to Front Video Output while driving.

Example: When you attempt to watch a DVD (the screen is black.)

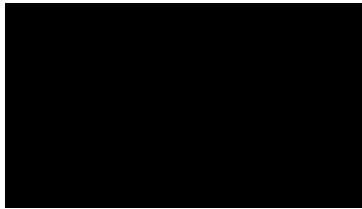

When you park your car in a safe place and apply the parking brake, the picture appears on the screen.

When Using a Display connected to Rear Video Output

This product's Rear video output is for connection of a display to enable passengers in the Rear seats to watch the DVD or Video CD.

WARNING

- NEVER install the display in a location that enables the Driver to watch the DVD or Video CD while Driving.

Precaution

- Keep this manual handy as a reference for operating procedures and precautions.
- Always keep the volume low enough for outside sounds to be audible.
- Protect the product from moisture.
- If the battery is disconnected, the preset memory will be erased and must be reprogrammed.

Preventing the Battery from Becoming Exhausted

When using this product, be sure your car engine is running. If you use this product when your engine is not running, the battery will become exhausted.

Changing the Mode Switch Setting

Use a pen tip or other pointed instrument to select the correct setting of the Mode switch on the rear of this unit for the component you are using it with. After changing the setting, be sure to press the RESET button. (See page 6.)

- (1) **When using this product with a Pioneer component featuring an IP-BUS input**
 - Select the IP-BUS mode.
- (2) **When using this product with a Pioneer component that does not feature an IP-BUS input, or another company's product**
 - Select the STAND ALONE mode.

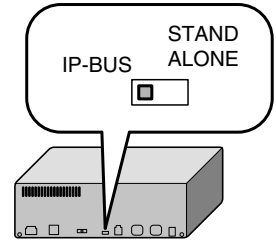

Condition Memory

This function memorizes audio language, subtitle language and picture mode settings made during disc playback for up to 30 discs. Without any special operations, the final setting details during playback of a disc are memorized. The next time a disc is played, the previous settings are automatically applied.

Note:

- With some discs, audio language and subtitle language are automatically specified, in which case condition memory does not function.
- When the number of discs exceeds 30, settings for the latest disc replace those for the least recent disc.

Resetting the Microprocessor

Pressing the RESET button lets you reset the microprocessor to its initial settings without changing SET UP MENU settings, Condition Memory and other memory settings.

Press the RESET button in the following cases.

- After changing the setting of the Mode switch on the rear of the unit.
- When this unit fails to operate correctly.
- When strange (incorrect) messages appear on the display.

Resetting

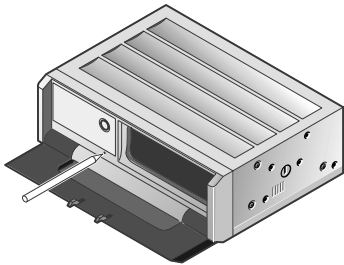

1 Turn the ignition switch OFF.

2 Press the RESET button.

Use a pen tip or other pointed instrument.

Note:

- After completing connections or when you want to erase all memorized settings or return the unit to its initial (factory) settings, switch your engine ON or set the ignition switch to ACC ON before pressing the RESET button.

Key Finder

The remote control (CD-R7) is sold separately.

- You can also operate this product with the remote controller supplied with an AV receiver (e.g. AVH-P6400CD), but you cannot change discs.

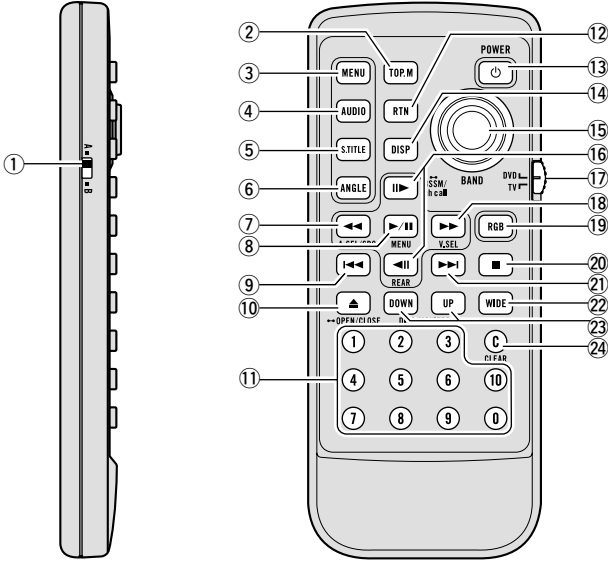

- | | | |
|--|--|------------------------|
| ① Remote control code selection switch (For details, see page 52.) | ⑩ OPEN/CLOSE (▲) button | ⑲ RGB button |
| ② TOP MENU button | ⑪ Number buttons | ⑳ STOP (■) button |
| ③ MENU button | ⑫ RETURN button | ㉑ NEXT (▶▶) button |
| ④ AUDIO button | ⑬ POWER button | ㉒ WIDE button |
| ⑤ SUBTITLE button | ⑭ DISPLAY button | ㉓ DISC UP/DOWN buttons |
| ⑥ ANGLE button | ⑮ Joystick | ㉔ CLEAR button |
| ⑦ REVERSE (◀◀) button | ⑯ STEP (◀ / ▶) buttons | |
| ⑧ PLAY/PAUSE (▶) button | ⑰ Remote control operation mode switch (For details, see page 51.) | |
| ⑨ PREVIOUS (◀◀◀) button | ⑱ FORWARD (▶▶▶) button | |

Using the Remote Controller

This product is equipped with a remote controller for convenient operation.

- Point the controller in the direction of the unit or remote sensor to operate.

Precaution:

- Do not store the remote controller in high temperatures or direct sunlight.
- The controller may not function properly in direct sunlight.
- Do not let the remote controller fall onto the floor, where it may become jammed under the brake or accelerator pedal.

Battery

- Slide the tray out on the back of the remote controller and insert the battery with the (+) and (-) poles pointing in the proper direction.

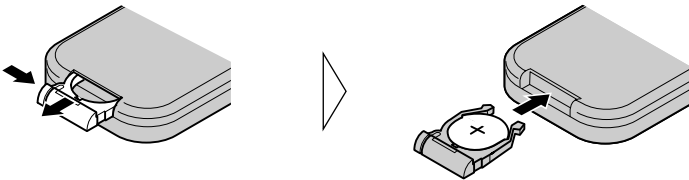

Note:

- When using for the first time, pull out the film protruding from the tray.

Replacing the Lithium Battery:

- Use only lithium battery “CR2025”, 3 V.

Precaution:

- Remove the battery if the remote controller is not used for a month or longer.
- If the event of battery leakage, wipe the remote controller completely clean and install a new battery.

⚠ WARNING:

- Keep the lithium battery out of reach of children. Should the battery be swallowed, immediately consult a doctor.

⚠ CAUTION:

- Do not recharge, disassemble, heat or dispose of battery in a fire.
- Use a CR2025 (3 V) lithium battery only. Never use other types of battery with this unit.
- Do not handle the battery with metallic tools.
- Do not store the lithium battery with metallic materials.
- When disposing of used batteries, please comply with governmental regulations or environmental public institution’s rules that apply in your country/area.
- Always check carefully that you are loading the battery with its (+) and (-) poles facing in the proper directions.

Discs Compatible with this Product

Features of This Player

Compatible with DVD, Video CD and CD Formats

DVD, Video CD and CD discs that display the logos shown below can be played back on this player.



The disc format logos shown above are found on disc labels or on disc jackets.

Note:

- With some DVD-Video discs, you may not be able to use certain functions.
- Playback of some DVD-Video discs may not be possible.
- With DVD-R/DVD-RW discs, only recordings made in the Video format (Video mode) can be played back. DVD-RW discs recorded in the Video Recording format (VR mode) cannot be played back.
- Even with DVD-R/DVD-RW discs featuring recordings made in the Video format (Video mode), playback may not be possible with this product due to disc characteristics or scratches or dirt on the disc. Dirt or condensation on the lens inside this product may also prevent playback.
- Playback of CD-R/RW and DVD-R/RW discs that have not been finalized is not possible.
- Playback of discs recorded with a PC using the correct format is possible, but depending on the application software settings, environment and other factors, playback may not be possible. (For details, inquire at the store or dealer's where you purchased the application software.)
- Playback of CD-TEXT discs is possible, but display of titles and other information is not possible.
- CD-Extra discs can be played back as music CDs.

Precaution:

- Playback of DVD-Audio, DVD-R and CD-ROM discs is not possible. This player can only playback discs bearing the marks shown on page 9.
- Use the optional 8 cm (3 in.) disc tray to play 8 cm (3 in.) discs. Never use a commercially available 8 cm (3 in.) adapter as this will damage the player.
- **DVDs that have incompatible region numbers (see page 62) cannot be played on this player. The region number of the player can be found on the rear panel. The illustration below shows the regions and corresponding region numbers.**

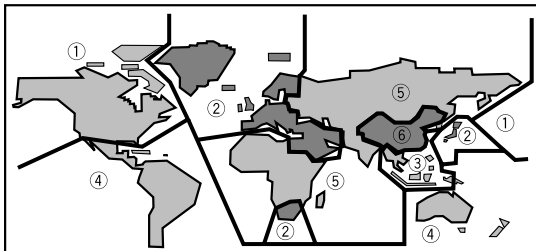

- Normal playback of CD-R discs other than those recorded with a music CD recorder may not be possible.
- Playback of music CD-R discs, even those recorded with a music CD recorder, may not be possible with this product due to disc characteristics or scratches or dirt on the disc. Dirt or condensation on the lens inside this product may also prevent playback.
- Titles and other text information recorded on a CD-R disc may not be displayed by this product.
- Read the precautions with the CD-R discs before using.

What the Marks on DVDs Indicate

The marks below can be found on DVD disc labels and packages. They indicate the type of images and audio recorded on the disc, and the functions you can use.

Mark	Meaning
	Indicates the number of audio systems.
	Indicates the number of subtitle languages.
	Indicates the number of viewing angles.
	Indicates the picture size (aspect ratio: screen width-to-height ratio) type.
	Indicates the number of the region where playback is possible.

■ Disc Operation

With some DVDs, depending on the intentions of the disc's producer, certain operations may be prohibited. Also, with discs enabling menu operation and two-way operation during playback, the way titles and chapters are organized may prevent certain operations such as Repeat play.

If this happens with this player, the prohibited mark “⊘” is displayed.

The prohibited mark “⊘” may not appear on some discs.

Disc Organization

DVD

On DVD-Video discs, the contents are divided into titles which are in turn divided into chapters.

With video material, a single work (movie etc.) usually corresponds to a single title, with different scenes corresponding to separate chapters. With karaoke discs, one song corresponds to one title.

However, some discs are not organized like this, so bear this in mind when using the Search function.

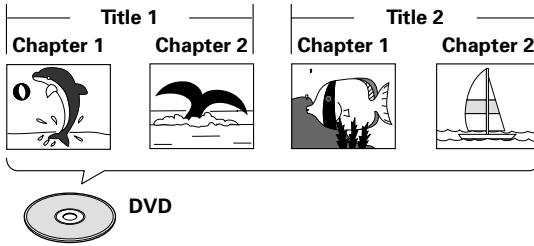

Video CD and CD

On CDs and Video CDs, the contents are divided into tracks. One track usually corresponds to one song. On some discs, tracks may also feature an index.

With Video CDs featuring PBC (Playback Control), you can use a menu to perform playback operations. It may not be possible to use functions such as Repeat and Search.

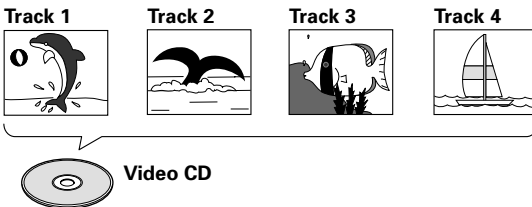
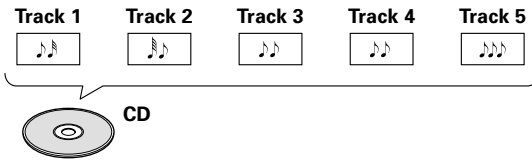

Main Features of This Product

You can play back DVDs, Video CDs (PBC compatibility) and CDs.

Repeat Play	You can enjoy different kinds of repeat play.
Still Image & Frame-By-Frame Playback	You can view still images or playback of one frame at a time.
Slow Motion Playback	Slow motion playback is possible.
Multi-Aspect	Switching between Wide screen, Letter box and Panscan display is possible.
Cinema/Animation/Standard Mode Switching	You can switch among these three modes for the best picture quality when watching a movie or an animation movie.
Multi-Audio	You can switch between multiple audio systems recorded on a DVD as desired.
Multi-Subtitle	You can switch between multiple subtitle languages recorded on a DVD as desired.
Multi-Angle	You can switch between multiple viewing angles of a scene recorded on a DVD as desired.
Video CDs featuring PBC Compatibility	You can play back Video CDs featuring PBC (Playback Control).
Parental Lock	You can use this to prevent your children viewing violent or adult oriented scenes.
Dolby* Digital/DTS** Compatibility (When combining the product with a Pioneer Multi-Channel AV Master Unit such as the AVM-P9000R)	When using this product with a Pioneer Multi-Channel AV Master Unit, you can enjoy the atmosphere and excitement provided by DVD movie and music software featuring 5.1 channel recordings.



* Manufactured under license from Dolby Laboratories. "Dolby" and the double-D symbol are trademarks of Dolby Laboratories.

**"DTS" is a registered trademark of Digital Theater Systems, Inc.

This product incorporates copyright protection technology that is protected by method claims of certain U.S. patents and other intellectual property rights owned by Macrovision Corporation and other rights owners.

Use of this copyright protection technology must be authorized by Macrovision Corporation, and is intended for home and other limited viewing uses only unless otherwise authorized by Macrovision Corporation. Reverse engineering or disassembly is prohibited.

Care of Discs and Magazines

Precaution

- This product is designed for use with conventional, fully circular discs only. Use of shaped discs are not recommended for this product.

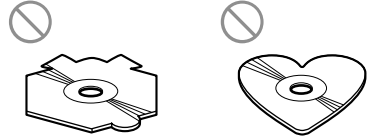

- Check all discs before playing and discard cracked, scratched or warped discs.
- Wipe dirty or damp discs outward from the center with a soft cloth.

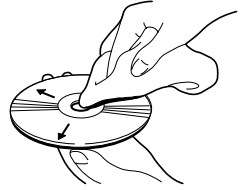

- Avoid touching the recorded (iridescent) surface when handling discs.
- Store discs in their cases when not in use.
- Keep discs out of direct sunlight and high temperatures.
- Do not affix labels or apply chemicals to discs.
- Condensation may collect inside the player when using the heater in cold weather, interfering with playback. Turn it off for an hour or so and wipe damp discs with a soft cloth.
- Road shocks may interrupt disc playback.
- Be sure to use DVD compatible magazines and trays with this product.
- If you need more magazines, please ask your nearest dealer for magazine JD-612V.
- Do not put the magazine in a place where it will be exposed to high temperatures or direct sunlight.
- Do not disassemble the magazine.
- Take care not to drop the magazine or knock it against anything.
- Do not use cracked or warped trays.
- Never insert anything other than discs. Do not attach a label or tape to a disc.
- The use of benzene, thinner, insecticide, or other volatile chemicals may damage the magazine surface.
- Attach the supplied label in the specified position. Attaching the label in an incorrect place or attaching more than one label will cause malfunction.

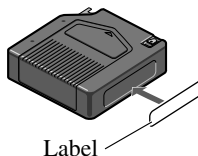

Loading Discs

Loading discs in the magazine and loading the magazine in the unit.

Loading Discs

You can load up to six discs in the magazine. Refer to page 9 to confirm the type of disc you can use with this unit.

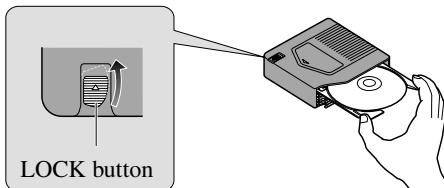

- 1** While pressing the LOCK button, pull out the tray.
- 2** Load a disc.
Load with the recorded side (the iridescent side) facing down.
With double-sided discs, load with the side you want to watch facing down.

- 3** Replace the tray.

When Using 8 cm (3 in.) Discs

Do not use an 8 cm (3 in.) disc adapter. If it is used, the player may fail. To load an 8 cm (3 in.) disc, you need a special 8 cm (3 in.) disc tray (Part No. CXB5931). Ask your Pioneer Service Center about it.

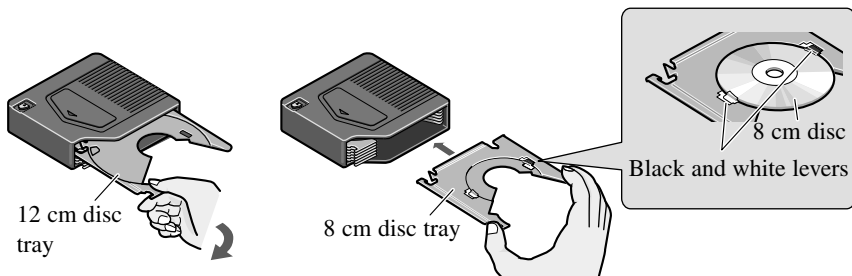

- 1** While pressing the LOCK button, pull out the tray.
- 2** Gently pull out the tray to the left to remove it.
- 3** Align the tray with the grooves on the left and right, and push in until you hear a click.
- 4** Secure the disc with the black and white levers.
- 5** Replace the tray.

- Be sure to remove the disc before changing a disc tray.
- If the tray is not aligned with the right and left grooves, it cannot be pushed to the end. Do not bend or force the tray.
- Always load 6 trays in a magazine to prevent loss or warping of trays.

Loading the Magazine

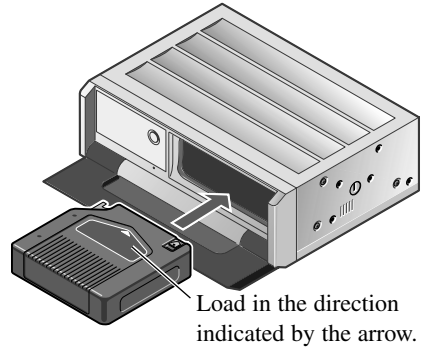
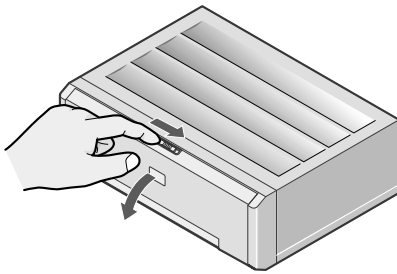

1 Slide the OPEN lever to the right.
The front door opens.

2 Load the magazine in the direction indicated by the arrow.

3 Close the front door.

Removing the Magazine

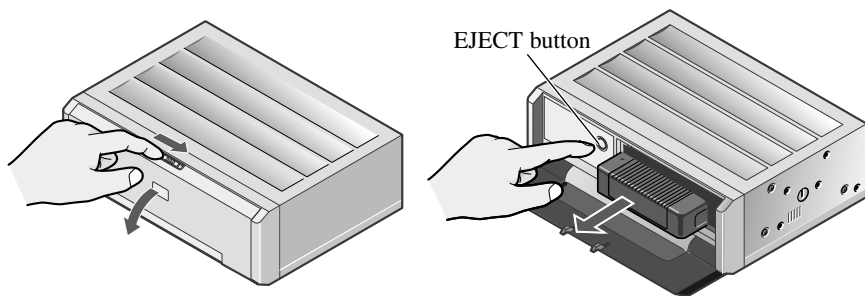

1 Slide the OPEN lever to the right.

The front door opens.

2 Press the EJECT button.

3 Remove the magazine.

4 Close the front door.

- Do not put your fingers in the magazine tray as this may lead to incorrect operation and damage to the player.
- If the label on the magazine is coming off or wrinkled up, it may damage the eject mechanism, and in some cases, the magazine may not be ejected. Therefore, remove a damaged label completely before use.
- Be sure the front door is closed except when loading or removing a magazine. Playback is not possible if the front door is left open. Dust or dirt entering the magazine may result in damage to the unit.

Basic Operations

Switching Power ON/OFF

Switching Power ON

When Using the IP-BUS Mode

1 Switch the display image source to this product.

For details, refer to the connected unit's manual.

2 Press the SOURCE button on the Head Unit.

Press repeatedly until DVD is selected, and the disc starts playing.

When Using the STAND ALONE Mode

Operate after confirming the Operation mode switch is set to DVD. (See page 7.)

1 Switch the display image source to this product.

For details, refer to the connected unit's manual.

2 Press the POWER button.

Power to this product switches ON and a disc starts playing. The remote sensor indicator lights.

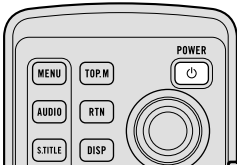

Note:

- When you have reloaded the magazine, playback starts from the first disc.
- If you were previously playing a DVD, playback of that disc resumes from where you left off.
- If power to this product is switched ON/OFF with the POWER button, playback does not resume from where you left off.
- Playback cannot resume from where you left off until information on all of the discs has been read.
- With some discs, a menu may be displayed. (See page 19.)

Switching Power OFF

When Using the IP-BUS Mode

Press the **SOURCE** button for 1 second on the Head Unit.

When Using the STAND ALONE Mode



Press the **POWER** button.

Power to this product switches OFF. The remote sensor indicator goes out.

When using a rear display in the IP-BUS Mode

- Even if the source selected with the head unit is not DVD, if you switch power to this product ON with the POWER button, you can watch the DVD picture from this product on the rear display.
- Regardless of whether the head unit is switched ON/OFF, you can switch power to this product ON/OFF.

Precautions concerning the IP-BUS Mode

- When you have switched power to this product ON by pressing the POWER button, be sure not to forget to switch power to this product OFF. If you switch power to this product OFF after switching to DVD video display, the display shows that power to this product has been switched OFF.
- When you eject a source disc (CD or MD) selected with the head unit, power to the head unit switches OFF. Depending on the connection method, the picture on the rear display may disappear.

D
VD

V
ideo
CD

C
D

Disc (DVD/Video CD/CD) Playback

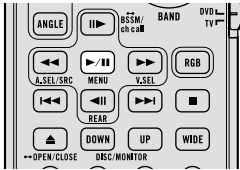

Press the **PLAY/PAUSE (▶/||)** button.

The playback mark (▶) is displayed for 4 seconds and the disc starts playing.

Note:

- Pressing the PLAY/PAUSE (▶/||) button when a disc is playing, pauses playback.
- If the last disc played was a DVD, playback starts from the point on that disc where you stopped play previously. With some discs, a menu may be displayed and playback may not be possible from where you left off previously.

Working with the Menu Screen



When DVDs offering menu or Video CDs featuring the PBC (Playback Control) function start playing, a menu is displayed.

With DVDs

1

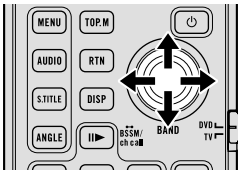

Use the joystick to select the desired **MENU** option.

2

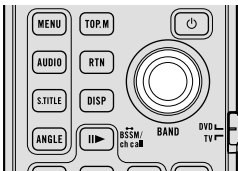

Click the joystick.

Playback starts from the selected menu option.

■ To Display the Menu

You can display the menu by pressing the MENU button or TOP MENU button while a disc is playing. Pressing either of these buttons again lets you start playback from the location selected from the menu. For details, refer to the instructions provided with the disc.

Note:

- The way to display the menu differs depending on the disc.

With Video CDs

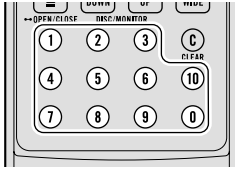

Press the number buttons to select a desired menu option.

Playback starts from the selected menu option.
Operation with the joystick is not possible.

■ To Display the Menu

You can display the menu by pressing the RETURN button while PBC playback. For details, refer to the instructions provided with the disc.

Note:

- When menu are two or more pages long, press the PREVIOUS (◀◀) / NEXT (▶▶) button to switch between displays.
- To play a disc without using a menu (without PBC playback), when the disc is stopped press the appropriate number button to select the desired track. To return to PBC playback, stop playback and press the PLAY/PAUSE (▶/⏸) button.

Chapter and Track Advance/Return

Skipping to the Next Chapter/Track



During play, press the NEXT (▶▶) button.

Chapter/track numbers are displayed for 4 seconds and you advance to the next chapter/track.

Returning to the Previous Chapter/Track

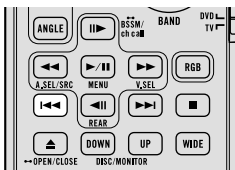

During play, press the PREVIOUS (◀◀) button.

Chapter/track numbers are displayed for 4 seconds and you return to the beginning of the current chapter/track.

Press the PREVIOUS (◀◀) button twice in succession takes you to the beginning of the chapter/track before the current chapter/track.

Specifying Title/Chapter/Track (Direct Search)

Specifying Title

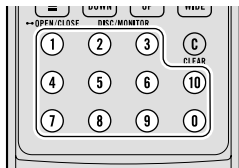

Press the number button corresponding to a desired title number when the disc is stopped.

Title number is displayed for 4 seconds and playback starts from the selected title.

To select 3, press button 3.

To select 10, press buttons 10 and 0 in order.

To select 23, press buttons 10, 10 and 3 in order.

Specifying Chapter

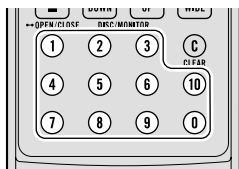

Press the number button corresponding to a desired chapter number during playback.

Chapter number is displayed for 4 seconds and playback starts from the selected chapter.

To select 3, press button 3.

To select 10, press buttons 10 and 0 in order.

To select 23, press buttons 10, 10 and 3 in order.

Specifying Track

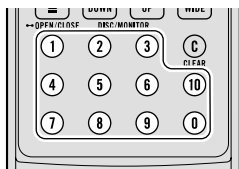

Press the number button corresponding to a desired track number.

Track number is displayed for 4 seconds and playback starts from the selected track.

To select 3, press button 3.

To select 10, press buttons 10 and 0 in order.

To select 23, press buttons 10, 10 and 3 in order.

Note:

- With some discs, the prohibited mark “Ⓢ” may be displayed and operation may not be possible.
- With Video CD, Direct Search is not possible during PBC playback.

Disc Fast Forward/Reverse

Fast Forward

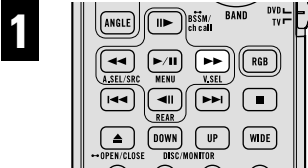

1 During play, continue pressing the **FORWARD** (▶▶) button.

The fast forward mark (▶▶) is displayed while pressing the button and disc fast forward is performed.

2 Release the **FORWARD** (▶▶) button at the point you want to watch/listen.

Playback resumes from that point.

Note:

- If you continue pressing the FORWARD (▶▶) button for 5 seconds, the color of the fast forward mark (▶▶) changes from blue to yellow. When this happens, fast forward continues even if you release the FORWARD (▶▶) button. To resume playback at a desired point, press the PLAY/PAUSE (▶/||) button.
- If you fast forward to the end of a CD, fast forward continues from the beginning of the disc.
- Fast forward may not be possible at certain locations on some discs. If this happens, normal playback automatically resumes.

Fast Reverse

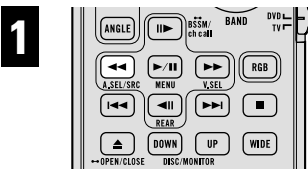

1 During play, continue pressing the **REVERSE** (◀◀) button.

The fast reverse mark (◀◀) is displayed while pressing the button and disc fast reverse is performed.

2 Release the **REVERSE** (◀◀) button at the point you want to watch/listen.

Playback resumes from that point.

Note:

- If you continue pressing the REVERSE (◀◀) button for 5 seconds, the color of the fast reverse mark (◀◀) changes from blue to yellow. When this happens, fast reverse continues even if you release the REVERSE (◀◀) button. To resume playback at a desired point, press the PLAY/PAUSE (▶/||) button.
- If you fast reverse to the beginning of a CD, normal playback resumes.
- Fast reverse may not be possible at certain locations on some discs. If this happens, normal playback automatically resumes.

Changing Discs

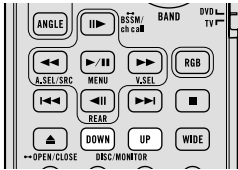

Press the DISC UP/DOWN buttons.

Disc numbers are displayed for 4 seconds and the previous or next disc in the magazine is selected. Repeat the operation to select the desired disc.

Note:

- Empty disc trays are skipped during disc selection.
- After a desired disc is selected, it automatically starts playing.

Stopping Playback



Press the STOP (■) button.

Note:

- When you stop DVD or Video CD playback (during PBC playback only) by pressing the STOP (■) button, that location on the disc is memorized enabling playback from that point when you play the disc again.
- The playback stop point on a disc is erased from memory if you change the disc, remove the magazine or switch power to this product ON/OFF with the POWER button.

Playback Variations

Still, Frame-by-Frame and Slow Motion Playback



D_{VD}

V_{ideo}
CD

C_D

Still Playback

This lets you pause playback and view a still picture.

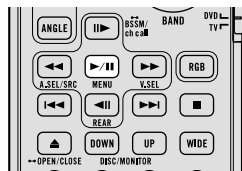

Press the PLAY/PAUSE (▶/⏸) button during playback.

The still mark (◻) is displayed for 4 seconds and playback is paused letting you view a still image.

- To return to normal playback, press the PLAY/PAUSE (▶/⏸) button once more.

Frame-by-Frame Playback

This lets you move ahead or back one frame at a time during playback. Reverse Frame-by-Frame playback is not possible with Video CDs.

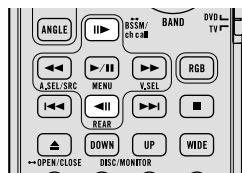

Press the STEP (⏮▶) or STEP (◀⏭) button.

Each time you press the STEP (⏮▶) button, you move ahead one frame.

Each time you press the STEP (◀⏭) button, you move back a number of frames.

- To return to normal playback, press the PLAY/PAUSE (▶/⏸) button.

Slow Motion Playback

This lets you slow down playback speed. Reverse Slow Motion playback is not possible with Video CDs.

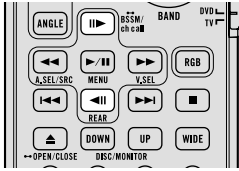

Press the STEP (◀||) or STEP (||▶) button for 1 second during playback.

The slow playback mark (▶) or (◀) is displayed, forward or reverse Slow Motion playback begins.

- To return to normal playback, press the PLAY/PAUSE (▶||) button.
- During forward Slow Motion playback, you can adjust playback speed by pressing the STEP (||▶) or STEP (◀||) button. Each time you press it the speed changes in 4 steps in the following order:
1/16 ↔ 1/8 ↔ 1/4 ↔ 1/2

Note:

- There is no sound during Still, Frame-by-Frame or Slow Motion playback.
- Depending on the disc and the playback location on the disc, the prohibited mark “⊘” may be displayed indicating that Still, Frame-by-Frame and Slow Motion playback are not possible.
- With some discs, images may be unclear during Frame-by-Frame and Slow Motion playback.

Changing Audio Language during Playback (Multi-Audio)



DVDs can provide audio playback with different languages and different systems (Dolby Digital, DTS etc.). With DVDs featuring multi-audio recordings, you can switch between languages/audio systems during playback.

1

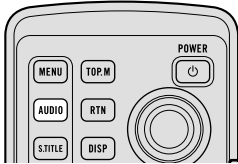

Press the AUDIO button during playback.

The audio selection mark () is displayed.

2

Press the AUDIO button while the audio selection mark is displayed.

The audio changes each time you press the AUDIO button.

Note:

- This function only operates with DVDs featuring multi-audio recordings.
- The number in the “Ⓣ” mark on a DVD’s package indicates the number of recorded languages/audio systems.
- With some DVDs, switching between languages/audio systems may only be possible using a menu display.
- You can also switch between languages/audio systems using the SET UP MENU. For details, refer to “Setting the Audio Language” on page 43.
- Only digital output of DTS audio is possible. If this product’s optical digital outputs are not connected, DTS audio will not be output, so select an audio setting other than DTS.
- While the audio selection mark is displayed, you can also switch to a desired audio language number using the number buttons.
- Display indications such as “Dolby D” and “5.1ch” indicate the audio system recorded on the DVD. Depending on the setting, playback may not be with the same audio system as that indicated.

Changing Audio Output during Playback



You can switch between stereo and monaural output.

1



Press the AUDIO button during playback.

The audio output selection mark () is displayed.

2

Press the AUDIO button while the audio output selection mark is displayed.

The audio output setting changes each time you press the AUDIO button in the following order:

L+R (Stereo) → L (Left) → R (Right) → L+R (Stereo)

Changing the Subtitle Language during Playback (Multi-Subtitle)

With DVDs featuring multi-subtitle recordings, you can switch between subtitle languages during playback.

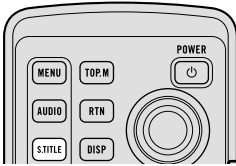
1

Press the SUBTITLE button during playback.

The subtitle selection mark () is displayed.

2

Press the SUBTITLE button while the subtitle selection mark is displayed.

The subtitle language changes each time you press the SUBTITLE button.

Note:

- This function only operates with DVDs featuring multi-subtitle recordings.
- The number in the “” mark on a DVD’s package indicates the number of recorded subtitle languages.
- With some DVDs, switching between subtitle languages may only be possible using a menu display.
- You can also switch between subtitle languages using the SET UP MENU. For details, refer to “Setting the Subtitle” on page 41.
- While the subtitle selection mark is displayed, you can also switch to a desired subtitle language number using the number buttons. At this time, you can also switch subtitle display OFF by pressing the CLEAR button.

Changing the Viewing Angle during Playback (Multi-Angle)



DVD

With DVDs featuring multi-angle (scenes shot from multiple angles) recordings, you can switch among viewing angles during playback.

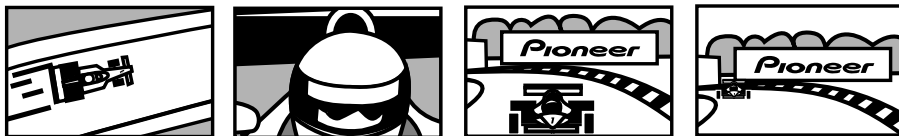

■ About Scenes that Let You Change the Viewing Angle

During playback of a scene shot from multiple angles on this product, the angle selection mark () is displayed in the bottom right of the screen.

Switch angle selection mark display ON/OFF using the SET UP MENU. For details, refer to “Setting Angle Selection Mark Display” on page 50.

1

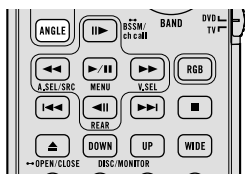

Press the ANGLE button during playback of a scene shot from multiple angles.



The angle selection mark () and angle number () are displayed.

2

Press the ANGLE button while the angle selection mark and angle number are displayed.

The angle changes each time you press the ANGLE button.

Note:

- This function only operates with DVDs featuring multi-angle recordings.
- The “” mark on a DVD’s package indicates it features multi-angle scenes. The number in the “” mark indicates the number of angles from which scenes were shot.
- You cannot switch angles during Slow Motion playback.
- If you press the ANGLE button during fast forward/fast reverse or pause, fast forward/fast reverse or pause is canceled and normal playback resumes but the viewing angle does not change.
- While the angle selection mark and angle number are displayed, you can also switch to a desired angle number using the number buttons.

Operating with Information Displays

Calling up Information Displays

Information displays let you easily perform a wide range of disc operations. These include starting playback from a specified title, chapter or time, selecting the picture mode, setting the range of Repeat play, changing discs, and switching between different audio and subtitle settings.

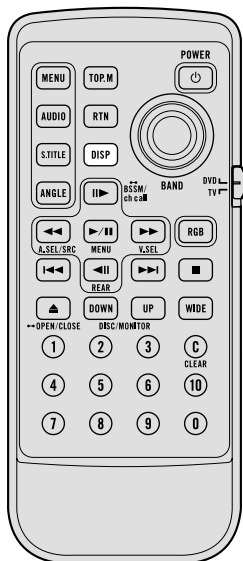

1 Press the DISPLAY button.

Each time you press the button the display changes as follows:

Information display 1 → Information display 2 → Display OFF → Information display 1

Information display 1 (e.g. DVD)



Information display 2 (e.g. DVD)



Note:

- For CDs there is no Display OFF setting.
- You can perform disc switching as well as title, chapter and time settings with either the information display 1 or 2.

This manual explains how to use the information display 2 to display all the discs loaded in the magazine for disc switching, and how to use the information display 1 to perform title, chapter and time settings.

- Pressing the DISPLAY button during fast forward/reverse returns you to normal playback.

■ Concerning Information Display 2

When information cannot be read directly after loading a magazine or at some other time, indications of the type of disc that cannot be read are not displayed.

Operating with the Information Display 1 of a DVD



This display lets you switch discs for playback, use the Search function to specify a title or chapter to search for a desired scene, use the Time Search function to specify a time to search for a desired scene, select the desired audio and subtitle language, and select the angle.

- Displaying all the discs loaded in the magazine for disc selection is explained using the information display 2.

Searching for a Desired Scene, Starting Playback from a Specified Time

You can use the Search function to search for a desired scene by specifying a title or chapter, and the Time Search function to specify the time on a disc at which play starts.

1 Move the joystick left/right to select a desired option.

The selected option is indicated in blue.

2 Press the number buttons to input the desired number.

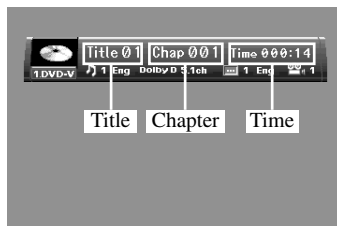

For Titles and Chapters

To select 3, press button 3.

To select 10, press buttons 1 and 0 in order.

To select 23, press buttons 2 and 3 in order.

- To jump 10 titles or chapters ahead of the selected one, press the 10 button.

For Time (Time Search)

To select 21 minutes 43 seconds, press buttons 2, 1, 4 and 3 in order.

To select 1 hour 11 minutes, convert the time into 71 minutes 00 seconds and press buttons 7, 1, 0 and 0 in order.

- To jump 10 seconds ahead of the selected time, press the 10 button.

Note:

- Pressing the CLEAR button cancels the input number.
- You can also select titles and chapters by moving the joystick up/down.

3 While the input number is displayed, click the joystick.

This starts playback from the selected scene.

Note:

- With discs featuring a menu, you can also press the MENU button or TOP MENU button and then make selections from the displayed menu.
- With some discs, the prohibited mark “⊘” may be displayed, indicating that titles, chapters and time cannot be specified.
- Chapter Search and Time Search are not possible when disc playback has been stopped.

■ Direct Search

Even without using an information display you can start playback from a specified title or chapter. For details, see page 21.

D_{VD}

V_{ideo}
CD

C_D

Selecting Audio, Subtitle and Angle

You can perform Audio (language, stereo, audio type as Dolby Digital etc.), Subtitle language and Angle selection.

1 Move the joystick left/right to select a desired option.

The selected option is indicated in blue.

2 Move the joystick up/down to switch to the desired setting.

This switches you to the selected setting.

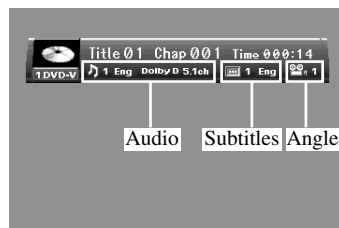

For Audio

Selection options switch as follows:

Audio 1 ↔ Audio 2 ↔ Audio 3 ↔ Audio 1

For Subtitles

Selection options switch as follows:

Subtitles 1 ↔ Subtitles 2 ↔ Subtitles OFF ↔ Subtitles 1

For Angle

Selection options switch as follows:

Angle 1 ↔ Angle 2 ↔ Angle 3 ↔ Angle 1

Note:

- The number of switching options depends on how many options are recorded on the DVD.
- You can switch Audio, Subtitle and Angle during playback using the respective buttons. For details, refer to “Playback Variations” on page 24.
- You can also switch settings by inputting numbers with the number buttons.
- Display indications such as “Dolby D” and “5.1ch” indicate the audio system recorded on the DVD. Depending on the setting, playback may not be with the same audio system as that indicated.

Operating with the Information Display 2 of a DVD



In addition to the Search and Time Search functions of the information display 1, this display lets you switch the disc for playback, select the range for Repeat play, and select the Picture mode.

Switching Discs

You can switch discs while confirming disc type. The selected disc is indicated by an arrow.

1 Move the joystick left/right to select the Disc option.

The Disc option is indicated in blue.

2 Move the joystick up/down to select the desired disc.

3 Click the joystick.

The selected disc starts playing.



The currently selected disc

Note:

- You can also switch discs by pressing a number button.

Selecting Repeat Range

You can choose between Repeat play of a disc, title or chapter.

1 Move the joystick left/right to select the Repeat range option.

The Repeat range option is indicated in blue.

2 Move the joystick up/down to switch to the desired setting.

This switches you to the selected setting.

Disc ↔ Title ↔ Chapter ↔ Disc

- When you select Disc, playback of the entire disc is repeated. When you select Title or Chapter, playback of that title or chapter only is repeated.

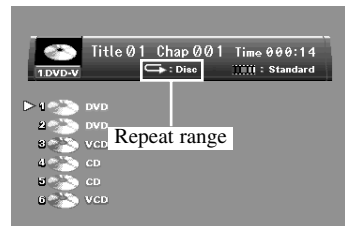

Note:

- When the Repeat play of a DVD disc is selected, play stops and depending on the disc a menu is displayed upon completion of play of an entire disc once through.

Selecting the Picture Mode

You can select between Standard, Animation and Cinema modes.

Compared to Standard mode, Animation provides a picture with beautifully clear colors and the Cinema mode assures images with well defined black/white contrast.

1 Move the joystick left/right to select the Picture mode option.

The Picture mode option is indicated in blue.

2 Move the joystick up/down to switch to the desired setting.

This switches you to the selected setting.

Standard ↔ Animation ↔ Cinema ↔ Standard

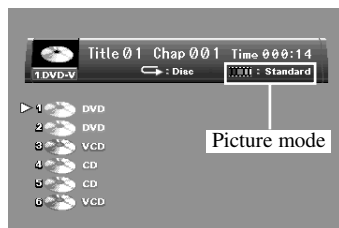

Note:

- Images may not be clear with some software and some displays.

Operating with the Information Display 1 of a Video CD



This display lets you switch discs for playback, use the Search function to specify a track to search for desired scenes, use the Time Search function to specify a time to search for a desired scene, switch audio output, and select the range for Repeat play. During playback of Video CDs featuring PBC (Playback Control), "Play Back Control:ON" is displayed. During such playback, Search and Time Search functions cannot be used nor can you select the range for Repeat play. (See page 20.)

- Displaying all the discs loaded in the magazine for disc selection is explained using the information display 2.

Searching for a Desired Scene, Starting Playback from a Specified Time

You can use the Search function to search for a desired scene by specifying a track, and the Time Search function to specify the time on a disc at which play starts.

1 Move the joystick left/right to select a desired option.

The selected option is indicated in blue.

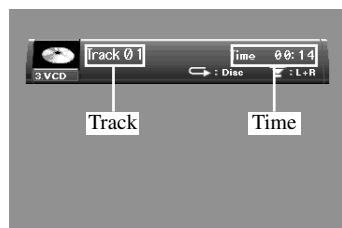

2 Press the number buttons to input the desired number.

For Tracks

- To select 3, press button 3.
- To select 10, press buttons 1 and 0 in order.
- To select 23, press buttons 2 and 3 in order.
- To jump 10 tracks ahead of the selected one, press the 10 button.

For Time (Time Search)

- To select 21 minutes 43 seconds, press buttons 2, 1, 4 and 3 in order.
- To select 1 hour 11 minutes, convert the time into 71 minutes 00 seconds and press buttons 7, 1, 0 and 0 in order.
- To jump 10 seconds ahead of the selected time, press the 10 button.

Note:

- Pressing the CLEAR button cancels the input number.
- You can also select tracks by moving the joystick up/down.

3 While the input number is displayed, click the joystick.

This starts playback from the selected scene.

Note:

- Time Search is not possible while the disc is stopped.

■ Direct Search

Even without using an information display you can start playback of a desired track. For details, see page 21.

Selecting Repeat Range

You can choose between Repeat play of a disc or a track.

1 Move the joystick left/right to select the Repeat range option.

The Repeat range option is indicated in blue.

2 Move the joystick up/down to switch to the desired setting.

This switches you to the selected setting.

Disc ↔ Track

- When you select Disc, playback of the entire disc is repeated. When you select Track, playback of that track only is repeated.

Note:

- When the Repeat play of a Video CD disc is selected, play stops and depending on the disc a menu is displayed upon completion of play of an entire disc once through.

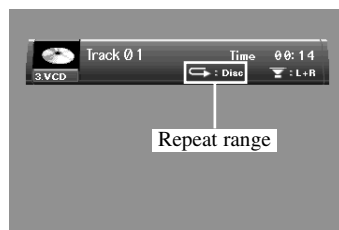

Selecting Audio Output

You can select between stereo and monaural audio output.

1 Move the joystick left/right to select the Audio option.

The Audio option is indicated in blue.

2 Move the joystick up/down to switch to the desired setting.

This switches you to the selected setting.

L+R (Stereo) ↔ L (Left) ↔ R (Right) ↔

L+R (Stereo)

- When you select Stereo, audio is output through both left and right channels. When you select Left or Right, audio is output from that channel only.

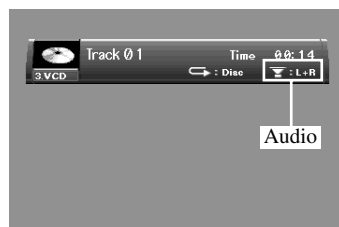

Operating with the Information Display 2 of a Video CD



In addition to the Search and Time Search functions of the information display 1, this display lets you switch the disc for playback and select the Picture mode. During playback of Video CDs featuring PBC (Playback Control), "Play Back Control:ON" is displayed. During such playback, both Search and Time Search functions cannot be used.

Switching Discs

You can switch discs while confirming disc type. The selected disc is indicated by an arrow.

1 Move the joystick left/right to select the Disc option.

The Disc option is indicated in blue.

2 Move the joystick up/down to switch to a desired disc.

3 Click the joystick.

The selected disc starts playing.

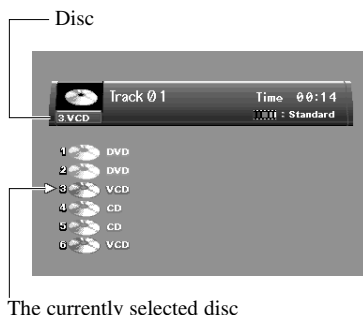

Note:

- You can also switch discs by pressing a number button.

Selecting the Picture Mode

You can select between Standard, Animation and Cinema modes.

Compared to Standard mode, Animation provides a picture with beautifully clear colors and the Cinema mode assures images with well defined black/white contrast.

1 Move the joystick left/right to select the Picture mode option.

The Picture mode option is indicated in blue.

2 Move the joystick up/down to switch to the desired setting.

This switches you to the selected setting.

Standard ↔ Animation ↔ Cinema ↔ Standard

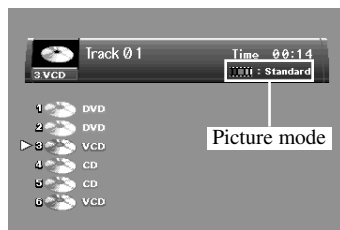

Note:

- Images may not be clear with some software and some displays.

Operating with the Information Display 1 of a CD



This display lets you switch discs for playback, use the Search function to specify a track to search for desired track, select the range for Repeat play, and switch Random play and Scan play ON/OFF.

- Displaying all the discs loaded in the magazine for disc selection is explained using the information display 2.

Searching for a Desired Track

You can use the Search function to specify a track to search for a desired track.

1 Move the joystick left/right to select the Track option.

The Track option is indicated in blue.

2 Press the number buttons to input the desired track number.

To select 3, press button 3.

To select 10, press buttons 1 and 0 in order.

To select 23, press buttons 2 and 3 in order.

- To jump 10 tracks ahead of the selected one, press the 10 button.

Note:

- Pressing the CLEAR button cancels the input number.
- You can also select tracks by moving the joystick up/down.

3 While the input number is displayed, click the joystick.

Play of the selected track starts.

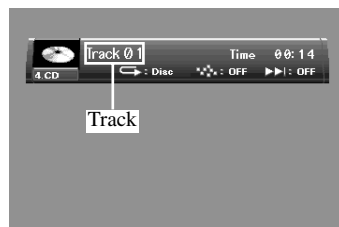

Selecting Repeat Range

You can choose between Repeat play of a disc or a track.

1 Move the joystick left/right to select the Repeat range option.

The Repeat range option is indicated in blue.

2 Move the joystick up/down to switch to the desired setting.

This switches you to the selected setting.

Disc ↔ Track

- When you select Disc, playback of the entire disc is repeated. When you select Track, playback of that track only is repeated.

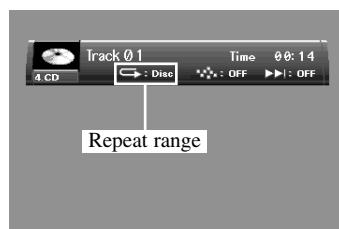

Setting Random Play

Tracks of the CD you are currently listening to are played in a random order.

1 Move the joystick left/right to select the Random option.

The Random option is indicated in blue.

2 Move the joystick up/down to switch to the desired setting.

This switches you to the selected setting.
ON ↔ OFF

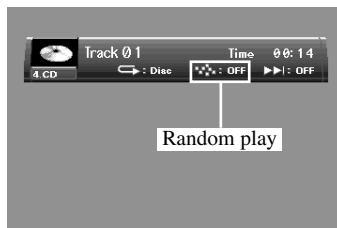

Setting Scan Play

The beginning of each track on the CD you are currently listening to is played for about 10 seconds.

1 Move the joystick left/right to select the Scan option.

The Scan option is indicated in blue.

2 Move the joystick up/down to switch the Scan play ON.

This switches you to the selected setting.
ON ↔ OFF

3 When you find the desired track, move the joystick up/down to cancel the Scan play.

Note:

- Scan play is canceled automatically after all tracks have been scanned.

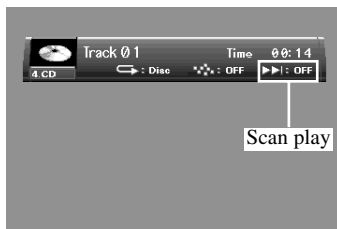

Operating with the Information Display 2 of a CD



The following explains how to switch discs with this display. With CDs, you can switch discs using either information display 1 or information display 2.

Switching Discs

You can switch discs while confirming disc type. The selected disc is indicated by an arrow.

1 Move the joystick left/right to select Disc option.

The Disc option is indicated in blue.

2 Move the joystick up/down to switch to a desired disc.

3 Click the joystick.

The selected disc starts playing.

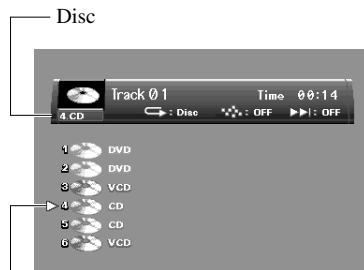

The currently selected disc

Note:

- You can also switch discs by pressing a number button.

Changing Initial Settings

Calling up the SET UP MENU

DVD

D_{VD}

You can use this menu to change Audio, Subtitle, Parental Lock and other DVD settings.

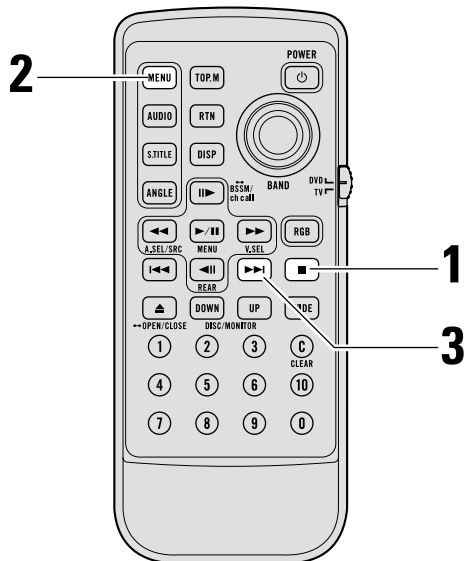

1 Press the STOP (■) button.

2 Press the MENU button when the disc is stopped.

The SET UP MENU is displayed.



3 Press the NEXT (▶▶) button.

The second SET UP MENU is displayed.

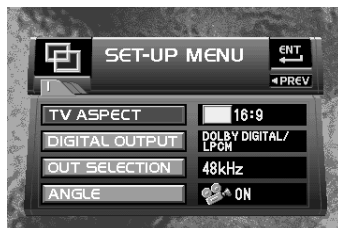

Note:

- You can also switch between SET UP MENUS by moving the joystick up/down.
- If you press the MENU button during display of a SET UP MENU, the SET UP MENU is canceled and the unit returns to the previous display.

■ Returning to the previous display

The SET UP MENU lets you switch between displays of different setting options. To continue performing different settings, or if you make a mistake during setting, pressing the RETURN button takes you back to the previous display each time you press it.

Setting the Subtitle (SUBTITLE LANG.)



You can set a desired subtitle language. If the selected subtitle language is recorded on the DVD, subtitles are displayed in that language. You can also switch subtitle and assist subtitle display ON/OFF.

Setting Subtitles and Assist Subtitles ON/OFF

You can switch Subtitle and Assist Subtitle ON/OFF as desired.

- 1 Move the joystick up/down to select the “SUBTITLE LANG.”.

“SUBTITLE LANG.” is indicated in blue.

- 2 Click the joystick.

A subtitle language menu is displayed.



- 3 Move the joystick to select Subtitle ON/OFF (LANG.) or Assist Subtitle ON/OFF (ASSIST).

The currently set language is indicated in yellow.
The option selected with the joystick is indicated in blue.



- 4 Click the joystick.

Each time you click the joystick the selected setting switches ON/OFF.

■ Assist Subtitles

Assist subtitles offer explanations for the aurally impaired. However, they are only displayed if they are recorded on the DVD.

Setting the Subtitle Language

You can set the preferred subtitle language.

1 Move the joystick up/down to select the “SUBTITLE LANG.”.

“SUBTITLE LANG.” is indicated in blue.

2 Click the joystick.

A subtitle language menu is displayed.



3 Move the joystick to select the desired language.

The currently set language is indicated in yellow. The language selected with the joystick is indicated in blue.



4 Click the joystick.

A subtitle language is set.

Note:

- If the selected language is not recorded on the disc, languages specified on the disc are displayed.
- You can also switch the subtitle language during playback with the SUBTITLE button. (See page 27.)
- Even if you use the SUBTITLE button to switch the subtitle language, this does not affect the settings here.
- Pressing the RETURN button takes you back to the previous display.

■ When You Select “OTHERS”

When you select “OTHERS”, a language code input display is shown. Refer to “Language Code Chart” (see page 60), using the number buttons to input the four digit code of the desired language, then click the joystick.

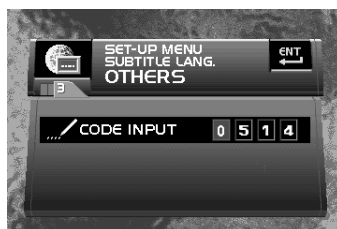

Note:

- Pressing the CLEAR button cancels the input numbers.

Setting the Audio Language (AUDIO LANG.)



You can set the preferred audio language.

1 Move the joystick up/down to select the “AUDIO LANG.”.

“AUDIO LANG.” is indicated in blue.

2 Click the joystick.

An audio language menu is displayed.



3 Move the joystick to select the desired audio language.

The currently set language is indicated in yellow.

The language selected with the joystick is indicated in blue.



4 Click the joystick.

The audio language is set.

Note:

- If the selected language is not recorded on the disc, the language specified on the disc is output.
- You can also switch the audio language during playback with the AUDIO button. (See page 26.)
- Even if you use the AUDIO button to switch the audio language, this does not affect the settings here.
- Pressing the RETURN button takes you back to the previous display.
- If you have selected “OTHERS”, refer to “When You Select “OTHERS”” on page 42.

Setting the Menu Language (MENU LANG.)



You can set the preferred language for displays of menus recorded on a disc.

1 Move the joystick up/down to select the "MENU LANG."

"MENU LANG." is indicated in blue.

2 Click the joystick.

A menu language menu is displayed.



3 Move the joystick to select the desired menu language.

The currently set language is indicated in yellow. The language selected with the joystick is indicated in blue.



4 Click the joystick.

The menu language is set.

Note:

- If the selected language is not recorded on the disc, the language specified on the disc is displayed.
- Pressing the RETURN button takes you back to the previous display.
- If you have selected "OTHERS", refer to "When You Select "OTHERS"" on page 42.

Setting the Parental Lock (PARENTAL)



Some DVDs let you use Parental Lock to restrict the viewing of violent and adult oriented scenes by children. You can set the Parental Lock level in steps as desired.

Setting the Code Number and Level

When you first use this function, register your code number. If you do not register a code number, Parental Lock will not operate.

1 Move the joystick up/down to select the "PARENTAL"

"PARENTAL" is indicated in blue.

2 Click the joystick.

Parental Lock setting menu is displayed.



Continued overleaf

3 Press the number buttons to input a four digit code number.

4 Click the joystick.

The code number is set, and you can now set the level.

5 Move the joystick left/right to select the desired level.



Level	Parental Lock details
LEVEL 8	Playback of the entire disc is possible. (Initial setting)
LEVEL 7 – LEVEL 2	This prevents playback of discs featuring adult oriented material. (Playback of discs for children and non-adult oriented discs is possible.)
LEVEL 1	Playback of discs for children only is possible.

6 Click the joystick.

The parental lock level is set.

Note:

- We recommend to keep a record of your code number in case you forget it.
- The Parental Lock level is recorded on the disc. You can confirm it by looking at the disc package, included literature or on the disc itself. With discs that do not feature a recorded Parental Lock level, you cannot use Parental Lock.
- With some discs, Parental Lock operates to skip certain scenes only, after which normal playback resumes. For details, refer to the disc's instructions.
- Pressing the RETURN button takes you back to the previous display.

Changing the Level

You can change the set Parental Lock level.

1 Move the joystick up/down to select the “PARENTAL”.

“PARENTAL” is indicated in blue.



2 Click the joystick.

Parental Lock setting menu is displayed.

3 Press the number buttons to input the registered code number.

4 Click the joystick.

This enters the code number, and you can now change the level.

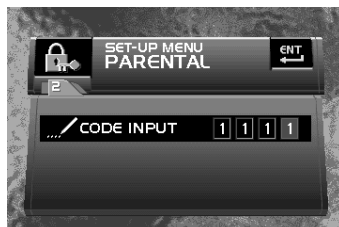

Note:

- If you input an incorrect code number, the prohibited mark “⊘” is displayed. Press the CLEAR button and input the correct code number.
- If you forget your code number, refer to “If You Forget Your Code Number” on page 59.

5 Move the joystick left/right to select the desired level.

6 Click the joystick.

The new Parental Lock level is set.



Note:

- Pressing the RETURN button takes you back to the previous display.

■ When Playing DVDs Enabling Parental Lock

When you play a disc featuring Parental Lock, code number input indications may be displayed. If this happens and you do not input the correct code number, playback will not begin.

Setting Aspect Ratio (TV ASPECT)



There are two kinds of display. A wide screen display has a width-to-height ratio (TV aspect) of 16:9, while a regular display has a TV aspect of 4:3. Be sure to select the correct TV aspect for the display you use.

1 Move the joystick up/down to select the “TV ASPECT”.

“TV ASPECT” is indicated in blue. (For details, see page 40.)

2 Click the joystick.

TV aspect settings are indicated on the right of the screen.

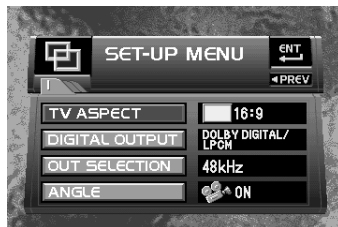

3 Move the joystick up/down to select the desired TV aspect.

The currently set TV aspect is indicated in yellow. The TV aspect selected with the joystick is indicated in blue.

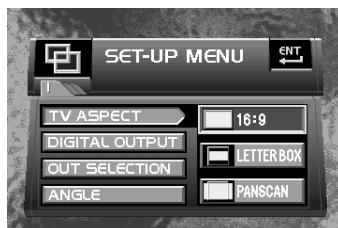

TV aspect	Setting detail
16:9	Select when using a wide screen display. (Initial setting)
LETTER BOX	Select when using a regular display. When playing discs featuring images recorded with a 16:9 TV aspect, the picture is the shape of a letter box with black bands at the top and bottom of the screen.
PANSCAN	Select when using a regular display. When playing discs featuring images recorded with a 16:9 TV aspect, the picture is cut short at the right and left of the screen.

4 Click the joystick.

The selected TV aspect is set.

Precaution:

- When using a regular display, select either “LETTER BOX” or “PANSCAN”. Selecting 16:9 may result in an unnatural picture.
- When playing discs that do not specify “PANSCAN”, playback is with “LETTER BOX” even if you select the “PANSCAN” setting. Confirm whether the disc package bears the “16:9 LB” mark. (See page 10.)
- Some discs do not enable changing of the TV aspect. For details, refer to the disc’s instructions.
- When selecting CDs and Video CDs, you cannot change the TV aspect settings.
- Pressing the RETURN button takes you back to the previous display.

Setting for Digital Output (DIGITAL OUTPUT)



Set digital output correctly to match the components you are using with this unit. There is no need to change settings if this unit is not connected for digital output.

Precaution:

- Incorrect setting may result in noise and damage to speakers so be sure to read the manuals of the connected components.

1 Move the joystick up/down to select the “DIGITAL OUTPUT”.

“DIGITAL OUTPUT” is indicated in blue. (For details, see page 40.)

2 Click the joystick.

Digital output settings are indicated on the right of the screen.

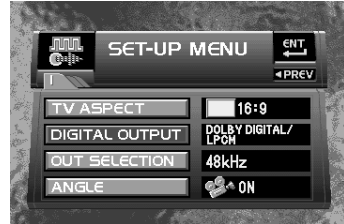

3 Move the joystick up/down to select the desired digital output setting.

The currently set digital output setting is indicated in yellow. The digital output setting selected with the joystick is indicated in blue.

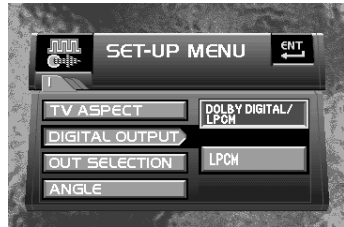

Digital output	Setting detail
DOLBY DIGITAL/LPCM	Select when using a Dolby Digital compatible amp and decoder. The Dolby Digital signal is output as it is. (Initial setting)
LPCM	Select when using an amp and decoder that are not Dolby Digital compatible. The Dolby Digital signal is converted to and output as a linear PCM signal.

4 Click the joystick.

The selected digital output setting is set.

Note:

- Linear PCM output of DTS audio is not possible. If you select the LPCM setting, DTS audio is not output.
- When using this product with a Pioneer Multi-Channel AV Master Unit with digital input (e.g. AVM-P9000R), select the “DOLBY DIGITAL/LPCM” setting.
- When using this product with the “DEX-P9”, select the “LPCM” setting.
- Pressing the RETURN button takes you back to the previous display.

Setting Digital and Analog Audio Output (OUT SELECTION)



You can set linear PCM audio output for both digital and analog output. Set audio output correctly to match the components you are using with this unit.

Precaution:

- If the setting is incorrect there will be no sound so be sure to read the manuals of the connected components.

1 Move the joystick up/down to select the “OUT SELECTION”.

“OUT SELECTION” is indicated in blue. (For details, see page 40.)

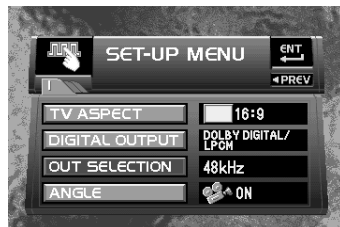

2 Click the joystick.

Audio output settings are indicated on the right of the screen.

3 Move the joystick up/down to select the desired audio output setting.

The currently set audio output setting is indicated in yellow. The audio output setting selected with the joystick is indicated in blue.

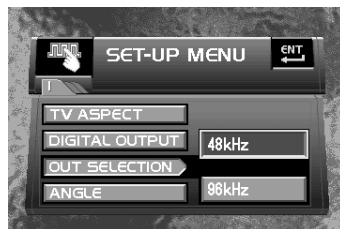

Output setting	Setting detail
48kHz	Select this setting when using digital connections. A 48 kHz signal is output regardless of the audio sampling frequency. A 96 kHz signal is converted to a 48 kHz signal. (Initial setting)
96kHz	Select this setting when using analog connections. The signal is output with the same frequency as the audio sampling frequency. With a 96 kHz signal, you can enjoy exceptionally high sound quality.

4 Click the joystick.

The selected audio output setting is set.

Note:

- With discs featuring 96 kHz recording, if you select the “96kHz” setting, audio is not output from digital output.
- With discs do not feature a CSS (Content Scrambling System) copy guard signal, a 96 kHz digital signal is output.
- When using this unit with a Multi-Channel AV Master Unit (e.g. AVM-P9000R), select the “48kHz” setting. If you select the “96kHz” setting, no sound will be output when playing discs featuring 96 kHz recordings.
- Pressing the RETURN button takes you back to the previous display.

Setting Angle Selection Mark Display (ANGLE)



With discs featuring multi-angle recordings, the angle selection mark is displayed at the bottom right of the screen during playback of scenes enabling multi-angle viewing. You can set angle selection mark display ON/OFF.

1 Move the joystick up/down to select the “ANGLE”.

“ANGLE” is indicated in blue. (For details, see page 40.)

2 Click the joystick.

Angle settings are indicated on the right of the screen.

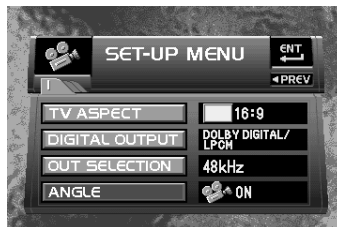

3 Move the joystick up/down to select angle selection mark display ON/OFF.

The currently set option is indicated in yellow. The option selected with the joystick is indicated in blue.

4 Click the joystick.

Angle selection mark display is set ON/OFF.



Note:

- Pressing the RETURN button takes you back to the previous display.

Switching the Remote Control Operation Mode Switch

When using this product with a separately sold TV or display, you can use the supplied remote controller to perform some TV or display operations. To operate the TV or display, set the remote control operation mode switch to “TV”. To operate this product, set the switch to “DVD”. (See page 7.)

Function Compatibility Charts

Functions that can be operated differ depending on the TV or display. Refer to the following chart before operating.

Button Number	Button Name	Model						
		(A)	(B)	(C)	(D)	(E)	(F)	(G)
⑦	A.SEL button	—	—	—	—	—	○	—
⑧	MENU button	○	—	—	—	—	○	○
⑩	OPEN/CLOSE button	—	○	○	○	○	—	—
⑮	BAND button	—	—	—	—	—	○	—
⑯ (upper)	BSSM (CH CALL) button	—	—	—	—	—	○	○
⑯ (lower)	REAR button	—	—	—	—	—	○	—
⑱	V.SEL button	○	—	—	—	—	○	—
⑲	RGB button	—	—	○	—	○	—	—
㉒	WIDE button	○	○	○	○	○	—	—
㉓	ANGLE button	—	○	○	○	○	—	—

■ Model

(A):AVD-W8000*

(B):AVX-7000

(C):AVX-7300

(D):AVX-P7000CD

(E):AVX-P7300DVD

(F):GEX-P7000TV

(G):GEX-P6400TV

* Only when the front mode is selected.

Switching the Remote Control Code Selection Switch

The remote controller has two remote codes for DVD operation, "A" and "B". To operate this product, be sure to set the remote control code selection switch to "A". When using this product with other Pioneer DVD players, set the remote control code selection switch to "B" to use the remote controller only for operation of those players.

Operating with the Head Unit

When in the IP-BUS mode, some operations can be performed with the head unit.

When connected to a Pioneer Multi-Channel AV Master Unit (e.g. AVM-P9000R), refer to the AV Master Unit Owner's Manual.

When connected to the "DEX-P9", refer to the Head Unit's Manual.

When operating with another head unit, refer to the following Function Compatibility Chart and Function Mode Switching, and operate with the appropriate buttons.

■ Function Compatibility Chart

Function	Reference page	Button
Source switching	17	SOURCE, SOURCE/OFF
Disc switching (selection by disc number)	—	1 – 6
Disc switching (moving ahead one disc number at a time)	23	BAND, ◀▶
Disc switching (moving ahead or back one disc number at a time)	23	▲/▼
Chapter/track advance/return	20	◀▶*1
Fast forward/reverse	22	◀▶*2

*1 Operation is possible when the AUTO (A/M) mode is set to AUTO.

*2 Operation is possible when the AUTO (A/M) mode is set to MANU.

■ Function Mode Switching

When using convenient functions other than those usually used, switch the mode and operate.

1 Press the FUNCTION button.

Press the button repeatedly until the desired mode is selected.

FUNC1 → FUNC2 → FUNC3 → FUNC4 → AUTO (A/M)

2 Press the ▲ button (press the ▼ button to switch OFF).

Perform AUTO (A/M) operation with the ◀▶ button.

Mode	Press the ▲ button	Press the ▲ button for 2 seconds
FUNC1	Head unit display switching	—
FUNC2	Pause (see page 24)	Random play (see page 38)
FUNC3	Scan play (see page 38)	—
FUNC4	Repeat range switching (See pages 32, 35 and 37)	—

Mode	Press the ◀▶ button	Press the ◀▶ button for 2 seconds
AUTO (A/M)	AUTO/MANUAL switching	—

Switching Power ON

When connected in the IP-BUS mode to a head unit other than a Pioneer Multi-Channel AV Master Unit (e.g. AVM-P9000R), performing the following steps switches power ON.

1 Switch the display picture source to this unit.

For details, refer to the connected component's Owner's Manual.

2 Switch the head unit's source to this unit.

For details, refer to the head unit's Owner's Manual.

Precaution

- You cannot switch the head unit's source with remote control for DVD player.
- When you have switched power to this unit ON by pressing the POWER button, power to this unit remains ON even if you switch power to the head unit OFF. Do not forget to switch power to this unit OFF.
- When you eject a source disc (CD or MD) selected with the head unit, power to the head unit switches OFF. Depending on the connection method, the picture on the rear display may disappear.

ITS Playback



When connected to a Pioneer Multi-Channel AV Master Unit (e.g. AVM-P9000R), you can operate the head unit to play just a desired track (ITS playback). This function differs slightly from ITS playback with a Pioneer Multi-CD player. With this unit, ITS playback applies only to the CD playing. For details, refer to the Multi-Channel AV Master Unit's Owner's Manual.

Troubleshooting

If you think there is something wrong with the unit.

Before requesting repairs, check the following chart.



If the problem remains even after checking.

Reset the unit. (See page 6.)



If the problem still remains.

Request repairs.

■ Common problems

Symptom	Cause	Remedy
Power doesn't switch ON. The unit doesn't operate.	Leads and connectors are incorrectly connected.	Confirm once more that all connections are correct.
	A fuse has blown.	Fix the problem causing the blown fuse, and replace the old fuse with a new one of the same capacity.
	Noise and other factors are causing the built-in microprocessor to operate incorrectly.	Press the RESET button. (See page 6.)
Operation with the remote control isn't possible. The unit does not operate correctly even when the appropriate remote control buttons are pressed.	The remote control operation mode is incorrect.	Switch to the correct remote control mode. (See pages 7, 51 and 52.)
	Battery power is low.	Load new battery. (See page 8.)
	Some operations are prohibited with certain discs.	Check using another disc.
Playback is not possible.	The disc is dirty.	Clean the disc. (See page 13.)
	The loaded disc is a type this unit cannot play.	Check what type the disc is.
	Non compatible video system disc is loaded.	Change to a disc compatible to your video system.
There's no sound.	Connections are incorrect.	Check connections.
	With some discs, 96 kHz output is prohibited.	Switch the output setting to 48 kHz. (See page 49.)
	The unit is performing Still, Slow Motion or Frame-By-Frame playback.	There is no sound during Still, Slow Motion or Frame-By-Frame playback.

■ Common problems (continued)

Symptom	Cause	Remedy
There's no picture.	The parking brake cord is not connected.	Connect a parking brake cord, and apply the parking brake.
	The parking brake is not applied.	
The prohibited mark “⊘” is displayed, and operation is not possible.	The operation is prohibited for the disc.	This operation is not possible.
	The operation is not compatible with the disc's organization.	
The picture stops (pauses) and the unit cannot be operated.	Reading of data has become impossible during playback.	After pressing the STOP (■) button once, start playback once more.
There's no sound. Volume level is low.	The volume level on the head unit or connected component is low.	Raise the volume level on the head unit or connected component.
	The attenuator is ON.	Switch the attenuator on the head unit OFF.
There's audio and video skipping.	This unit is not firmly secured.	Secure this unit firmly.
The picture is stretched, the aspect is incorrect.	The aspect setting is incorrect for the display.	Select the appropriate setting for your display. (See page 47.)
Rear display picture disappears.	The source disc (CD or MD) being listened to with the head unit has been ejected.	Before ejecting the disc, switch the source. This problem may occur when certain connection methods are used.

■ Problems during DVD playback

Symptom	Cause	Remedy
Playback is not possible.	The loaded disc has a different region number from this unit.	Replace the disc with one featuring the same region number as this unit. (See page 10.)
A Parental Lock message is displayed and playback is not possible.	Parental Lock is ON.	Switch Parental Lock OFF or change the level. (See page 44.)
Parental Lock cannot be canceled.	The code number is incorrect.	Input the correct code number. (See page 46.)
	You have forgotten your code number.	Press the CLEAR button 10 times to cancel the code number. (See page 59.)
Dialog language (and subtitle language) cannot be switched.	The DVD playing does not feature multiple language recordings.	You cannot switch among multiple languages if they aren't recorded on the disc.
	You can only switch between options indicated in the disc menu.	Switch using the disc menu.
No subtitles are displayed.	The DVD playing does not feature subtitles.	Subtitles are not displayed if they are not recorded on the disc.
	You can only switch between options indicated in the disc menu.	Switch using the disc menu.
Playback is not with the audio language and subtitle language settings selected in the SET UP MENU.	The DVD playing does not feature dialog or subtitles in the language selected in the SET UP MENU.	Switching to a selected language is not possible if the language selected in the SET UP MENU is not recorded on the disc.
Switching the viewing angle is not possible.	The DVD playing does not feature scenes shot from multiple angles.	You cannot switch between multiple angles if the DVD does not feature scenes recorded from multiple angles.
	You are trying to switch to multiple angle viewing of a scene that is not recorded from multiple angles.	Switch between multiple angles when watching scenes recorded from multiple angles.
The picture is extremely unclear/distorted and dark during playback.	The disc features a signal to prohibit copying. (Some discs may have this.)	Since this product is compatible with the copy guard analog copy protect system, when playing a disc that has a signal prohibiting copying, the picture may suffer from horizontal stripes or other imperfections when viewed on some displays. This does not mean this product is malfunctioning.

■ Problems during Video CD playback

Symptom	Cause	Remedy
The PBC (Playback Control) menu display cannot be called up.	The Video CD playing does not feature PBC.	This operation is not possible with Video CDs not featuring PBC.
	PBC is switched OFF.	Switch PBC ON. (See page 20.)
Repeat play and Track/Time Search are not possible.	PBC is switched ON.	Switch PBC OFF. (See page 20.)

■ Problems during Multi-Channel AV Master Unit connection

Symptom	Cause	Remedy
There's no sound.	Optical digital cables are not correctly connected.	Connect optical digital cables correctly.
	The Multi-Channel AV Master Unit is not compatible with a 96 kHz signal.	Switch the output setting to 48 kHz. (See page 49.)
Information display operation is not possible.	Indications are not the Multi-Channel AV Master Unit's information display.	Operate using this unit's information display. (See page 29.)

If You Forget Your Code Number



Refer to "Changing the Level", step 3 on page 46, and press the CLEAR button 10 times. The registered code number is canceled, letting you register a new one.

Error Message

When problems occur with disc playback, an error message appears on the display. Refer to the table below to identify the problem, then take the suggested corrective action. If the error persists, contact your dealer or your nearest PIONEER Service Center.

Message (error number)	When this message is displayed	Remedy
Error-2	The disc is dirty.	Wipe the disc clean. (See page 13.)
	The disc is scratched.	If the disc is scratched, replace it with another. (See page 13.)
	The disc is loaded upside down.	Check that the disc is loaded correctly. (See page 14.)
	This type of disc (CD-ROM etc.) cannot be played by this unit.	Replace the disc with one this unit can play. (See page 9.)
Error-5 Error-6	This unit's power supply or internal mechanisms may be malfunctioning.	Switch this unit OFF and then switch it back ON. (See page 17.)
No Disc	There are no discs loaded in the magazine.	Load a disc or discs in the magazine. (See page 14.)
Thermal Protection	The temperature of this unit is outside of the normal operating range.	Wait until the unit's temperature returns to within normal operating limits.
DVD Player Door Open	The DVD player's door is open.	Close the DVD player's door.
CANNOT BE PLAYED	The disc does not have the same region number as this unit.	Replace the DVD with one bearing the correct region number.
	This type of disc (CD-ROM etc.) cannot be played by this unit.	Replace the disc with one this unit can play. (See page 9.)

Language (code)	Input code
Japanese (ja)	1001
English (en)	0514
French (fr)	0618
Spanish (es)	0519
German (de)	0405
Italian (it)	0920
Chinese (zh)	2608
Dutch (nl)	1412
Portuguese (pt)	1620
Swedish (sv)	1922
Russian (ru)	1821
Korean (ko)	1115
Greek (el)	0512
Afar (aa)	0101
Abkhazian (ab)	0102
Afrikaans (af)	0106
Amharic (am)	0113
Arabic (ar)	0118
Assamese (as)	0119
Aymara (ay)	0125
Azerbaijani (az)	0126
Bashkir (ba)	0201
Byelorussian (be)	0205
Bulgarian (bg)	0207
Bihari (bh)	0208
Bislama (bi)	0209
Bengali (bn)	0214
Tibetan (bo)	0215
Breton (br)	0218
Catalan (ca)	0301
Corsican (co)	0315
Czech (cs)	0319
Welsh (cy)	0325
Danish (da)	0401
Bhutani (dz)	0426
Esperanto (eo)	0515
Estonian (et)	0520
Basque (eu)	0521
Persian (fa)	0601
Finnish (fi)	0609
Fiji (fj)	0610
Faroese (fo)	0615
Frisian (fy)	0625
Irish (ga)	0701
Scots-Gaelic (gd)	0704
Galician (gl)	0712
Guarani (gn)	0714
Gujarati (gu)	0721

Language (code)	Input code
Hausa (ha)	0801
Hindi (hi)	0809
Croatian (hr)	0818
Hungarian (hu)	0821
Armenian (hy)	0825
Interlingua (ia)	0901
Interlingue (ie)	0905
Inupiak (ik)	0911
Indonesian (in)	0914
Icelandic (is)	0919
Hebrew (iw)	0923
Yiddish (ji)	1009
Javanese (jw)	1023
Georgian (ka)	1101
Kazakh (kk)	1111
Greenlandic (kl)	1112
Cambodian (km)	1113
Kannada (kn)	1114
Kashmiri (ks)	1119
Kurdish (ku)	1121
Kirghiz (ky)	1125
Latin (la)	1201
Lingala (ln)	1214
Laothian (lo)	1215
Lithuanian (lt)	1220
Latvian (lv)	1222
Malagasy (mg)	1307
Maori (mi)	1309
Macedonian (mk)	1311
Malayalam (ml)	1312
Mongolian (mn)	1314
Moldavian (mo)	1315
Marathi (mr)	1318
Malay (ms)	1319
Maltese (mt)	1320
Burmese (my)	1325
Nauru (na)	1401
Nepali (ne)	1405
Norwegian (no)	1415
Occitan (oc)	1503
Oromo (om)	1513
Oriya (or)	1518
Panjabi (pa)	1601
Polish (pl)	1612
Pashto, Pushto (ps)	1619
Quechua (qu)	1721
Rhaeto-Romance (rm)	1813
Kirundi (rn)	1814

Language (code)	Input code
Romanian (ro)	1815
Kinyarwanda (rw)	1823
Sanskrit (sa)	1901
Sindhi (sd)	1904
Sangho (sg)	1907
Serbo-Croatian (sh)	1908
Sinhalese (si)	1909
Slovak (sk)	1911
Slovenian (sl)	1912
Samoan (sm)	1913
Shona (sn)	1914
Somali (so)	1915
Albanian (sq)	1917
Serbian (sr)	1918
Siswati (ss)	1919
Sesotho (st)	1920
Sundanese (su)	1921
Swahili (sw)	1923
Tamil (ta)	2001
Telugu (te)	2005
Tajik (tg)	2007
Thai (th)	2008
Tigrinya (ti)	2009
Turkmen (tk)	2011
Tagalog (tl)	2012
Setswana (tn)	2014
Tonga (to)	2015
Turkish (tr)	2018
Tsonga (ts)	2019
Tatar (tt)	2020
Twi (tw)	2023
Ukrainian (uk)	2111
Urdu (ur)	2118
Uzbek (uz)	2126
Vietnamese (vi)	2209
Volapük (vo)	2215
Wolof (wo)	2315
Xhosa (xh)	2408
Yoruba (yo)	2515
Zulu (zu)	2621

Terms

Aspect Ratio

This is the width-to-height ratio of a TV screen. A regular display has an aspect ratio of 4:3. Wide-screen displays have an aspect ratio of 16:9, providing a bigger picture for exceptional presence and atmosphere.

Chapter

DVD titles are in turn divided into chapters which are numbered in the same way as the chapters of a book. With DVDs featuring chapters, you can quickly find a desired scene with Chapter Search.

Dolby Digital



Dolby Digital provides multi-channel audio from up to 5.1 independent channels. This system is the same as the Dolby Digital surround sound system used in theaters. To enjoy Dolby Digital entertainment, you must connect this unit's optical digital output jacks to the optical digital input jacks of a Dolby Digital compatible amp.

DTS



This stands for Digital Theater Systems. DTS is a surround system delivering multi-channel audio from up to 6 independent sources. To enjoy discs featuring DTS audio recording, you must connect this unit's optical digital output jacks to the optical digital input jacks of a DTS compatible amp or decoder.

Linear PCM (LPCM)

This stands for Linear Pulse Code Modulation, which is the signal recording system used for music CDs. Compared to music CDs, which feature 44.1 kHz/16-bit recordings, DVDs feature 48 kHz/16-bit – 96 kHz/24-bit recordings. The result is sound quality even higher than that provided by music CDs.

MPEG

This stands for Moving Pictures Experts Group, and is an international video image compression standard. Some DVDs feature digital audio compressed and recorded using this system.

Multi-Angle

With regular TV programs, although multiple cameras are used to simultaneously shoot scenes, only images from one camera at a time are transmitted to your TV. Some DVDs feature scenes shot from multiple angles, letting you choose your viewing angle as desired.

Multi-Audio (Multilingual Dialog)

Some DVDs feature dialog recorded in multiple languages. Dialog in up to 8 languages can be recorded on a single disc, letting you choose as desired.

Multi-Subtitle

Subtitles in up to 32 languages can be recorded on a single DVD, letting you choose as desired.

Optical Digital Output

By transmitting the audio signal as a digital signal, it's possible to minimize any loss of sound quality. Optical digital output refers to the transmission (output) of a digital audio signal via optical cable. (The amp or other component on the reception side must have optical digital inputs.)

Parental Lock

Some DVDs with violent or adult-oriented scenes feature parental lock which prevents children from viewing such scenes. With this kind of disc, if you set this unit's parental lock level, playback of scenes inappropriate for children will not be possible, or these scenes will be skipped.

Playback Control (PBC)

This is a playback control signal recorded on Video CDs (Version 2.0). Using menu displays provided by Video CDs with PBC lets you enjoy playback of simple interactive software and software with search functions. You can also enjoy viewing high- and standard-resolution still images.

Region Number

DVD players and DVD discs feature region numbers indicating the area in which they were purchased. Playback of a DVD is not possible unless it features the same region number as the DVD player. This unit's region number is displayed on the rear of the unit.

Title

DVDs have a high data capacity, enabling recording of multiple movies on a single disc. If, for example, one disc contains three separate movies, they are divided into Title 1, Title 2 and Title 3. This lets you enjoy the convenience of Title Search and other functions.

Installation

Connecting the Units

Note:

- This unit is for vehicles with a 12-volt battery and negative grounding. Before installing it in a recreational vehicle, truck, or bus, check the battery voltage.
- To avoid shorts in the electrical system, be sure to disconnect the \ominus battery cable before beginning installation.
- Refer to each product's manual for details on connecting the power amp and other units, then make connections correctly.
- Secure the wiring with cable clamps or adhesive tape. To protect the wiring, wrap adhesive tape around them where they lie against metal parts.
- Route and secure all wiring so it cannot touch any moving parts, such as the gear shift, hand-brake and seat rails. Do not route wiring in places that get hot, such as near the heater outlet. If the insulation of the wiring melts or gets torn, there is a danger of the wiring short-circuiting to the vehicle body.
- Don't pass the yellow lead through a hole into the engine compartment to connect to the battery. This will damage the lead insulation and cause a very dangerous short.
- Do not shorten any leads. If you do, the protection circuit may fail to work when it should.
- Never feed power to other equipment by cutting the insulation of the power supply lead of the unit and tapping into the lead. The current capacity of the lead will be exceeded, causing overheating.
- When replacing fuse, be sure to use only fuse of the rating prescribed on the fuse holder.
- If the RCA pin jack on the unit will not be used, do not remove the caps attached to the end of the connector.

- To prevent incorrect connection, the input side of the IP-BUS or optical cable connector is blue, and the output side is black. Connect the connectors of the same colors correctly.
- If this unit is installed in a vehicle that does not have an ACC (accessory) position on the ignition switch, the red lead of the unit should be connected to a terminal coupled with ignition switch ON/OFF operations. If this is not done, the vehicle battery may be drained when you are away from the vehicle for several hours.



ACC position

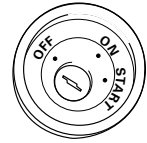

No ACC position

- Cords for this product and those for other products may be different colors even if they have the same function. When connecting this product to another product, refer to the supplied Installation manuals of both products and connect cords that have the same function.

Connecting the Power Cord

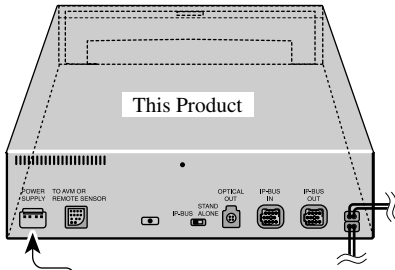

Connection method

1. Clamp the parking brake switch power supply side lead.

↓

2. Clamp firmly with needle-nosed pliers.

Note:

- The position of the parking brake switch depends on the vehicle model. For details, consult the vehicle Owner's Manual or dealer.

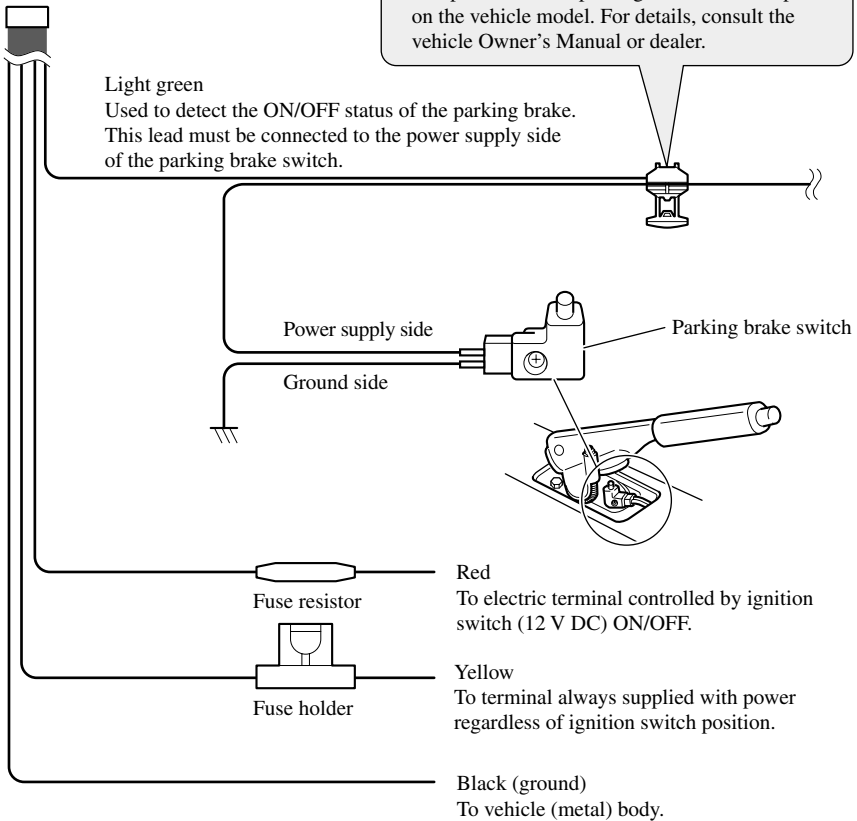

Connection Diagram

■ When connecting the Multi-Channel AV Master Unit

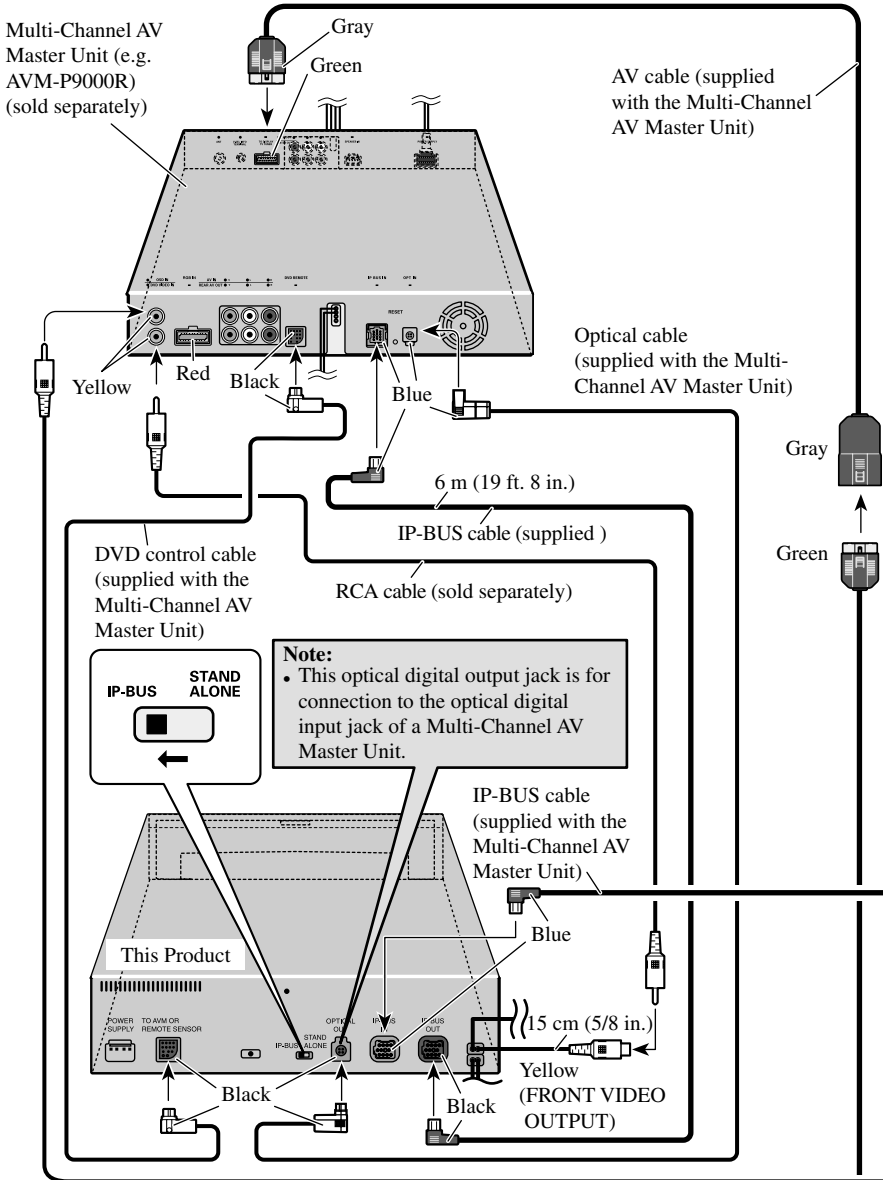

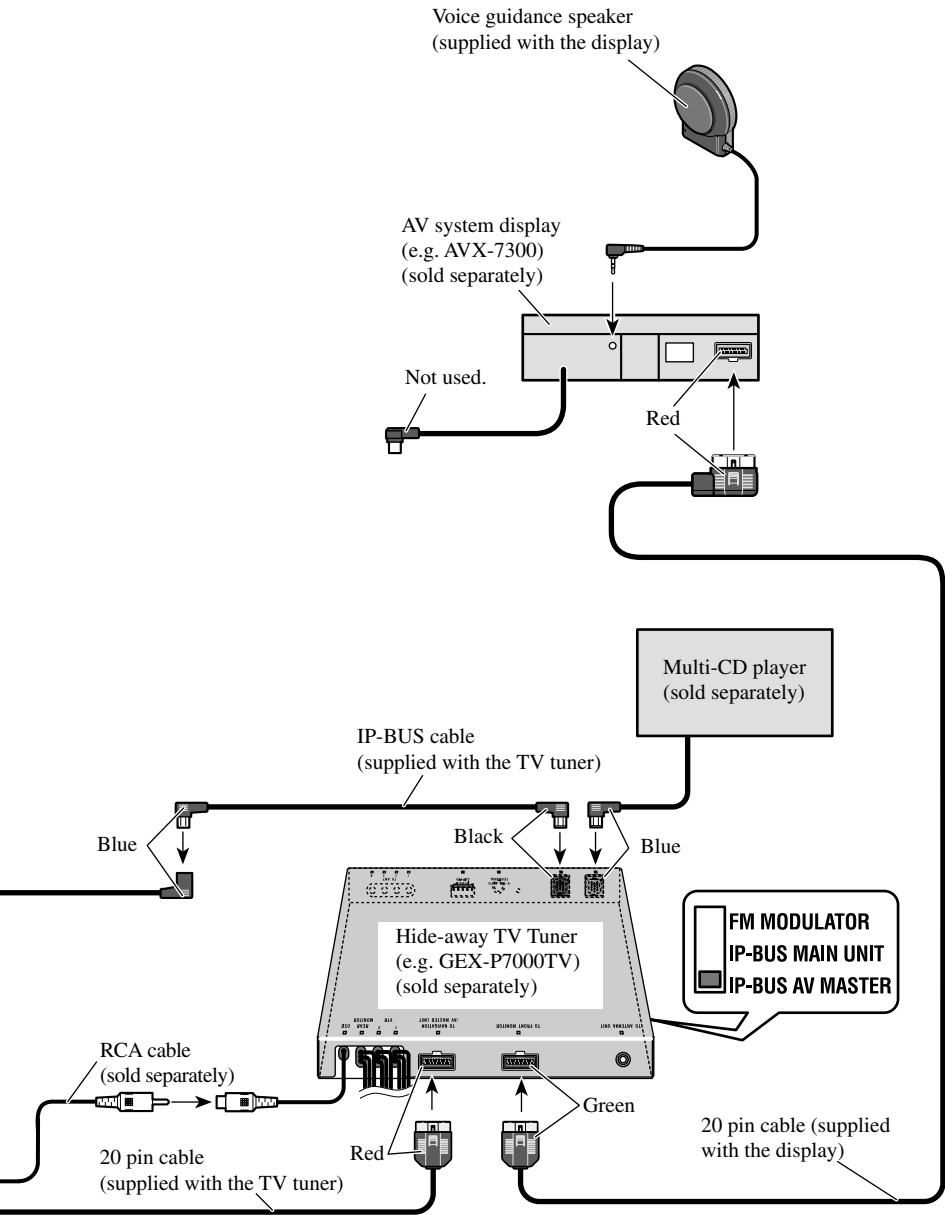

■ When connecting the Head Unit

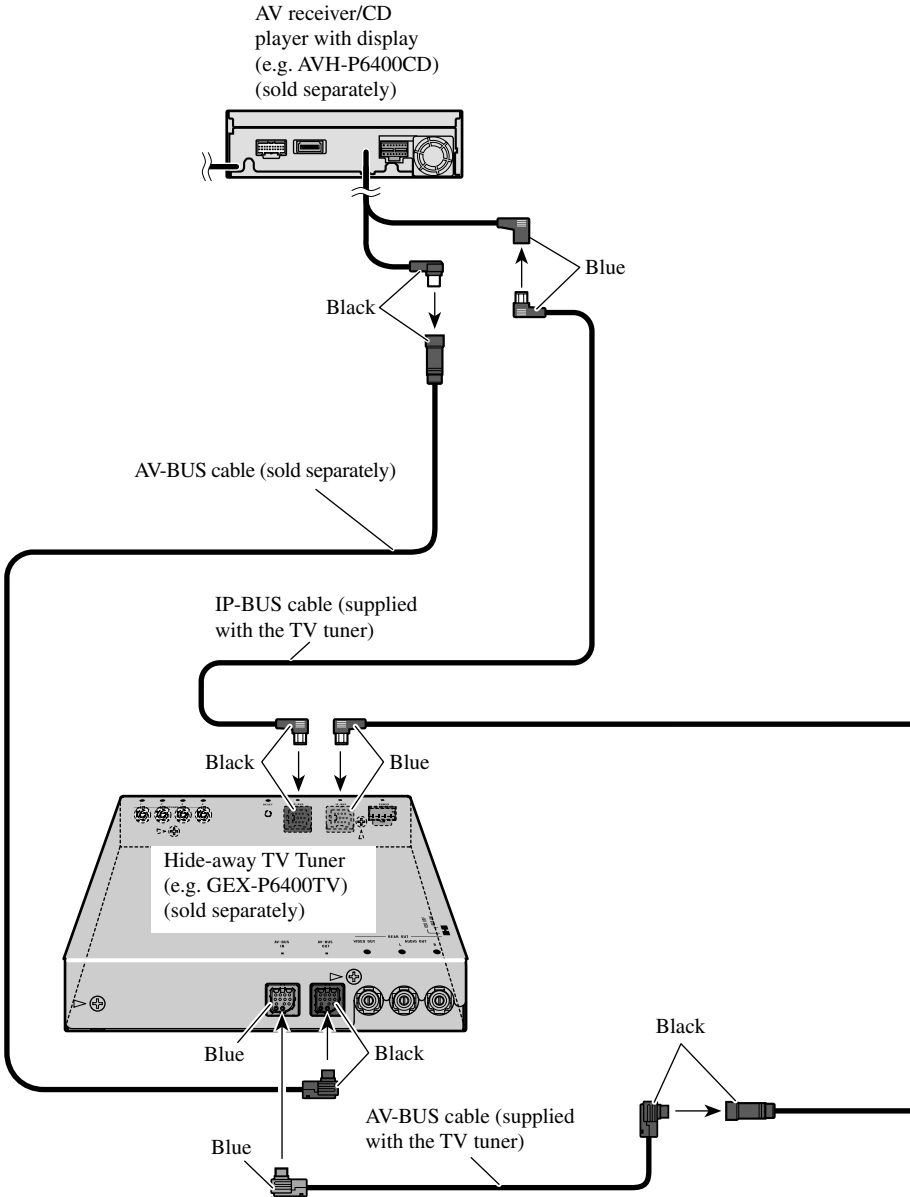

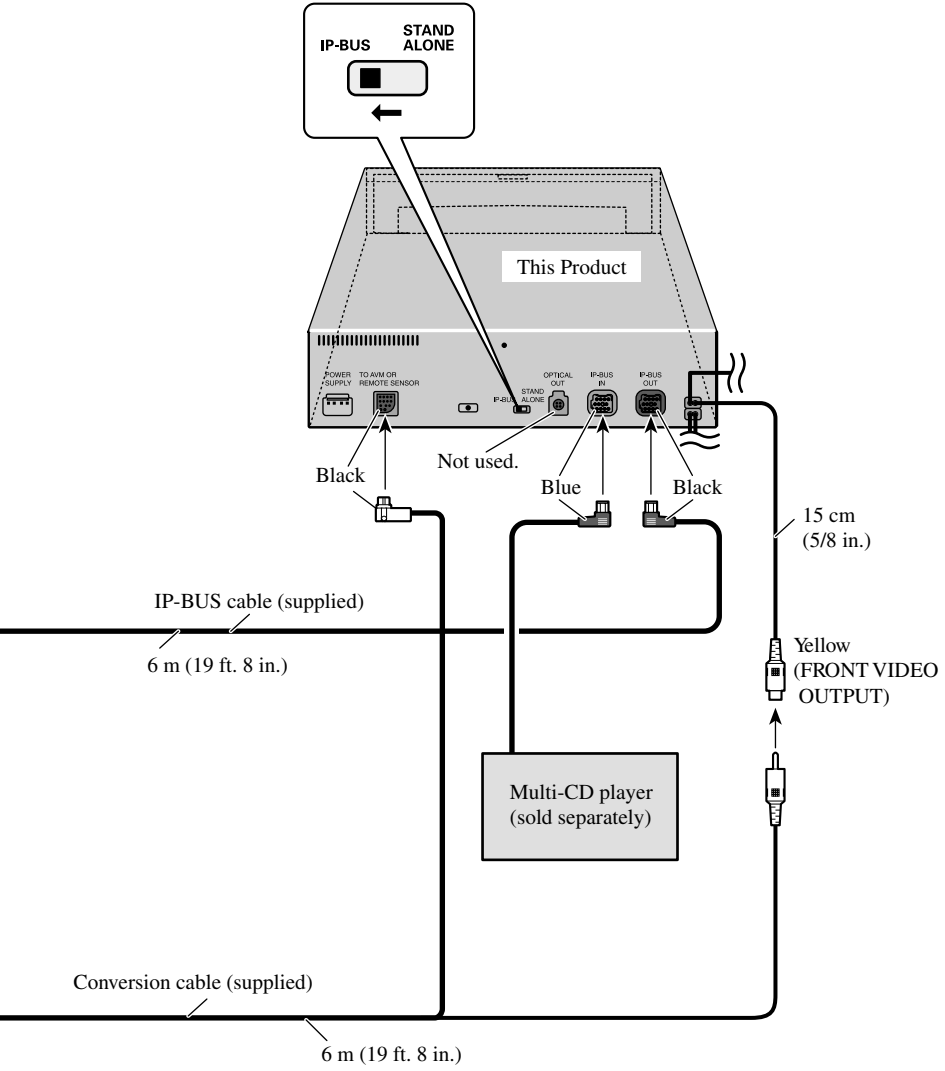

■ When connecting the display with RCA input jacks

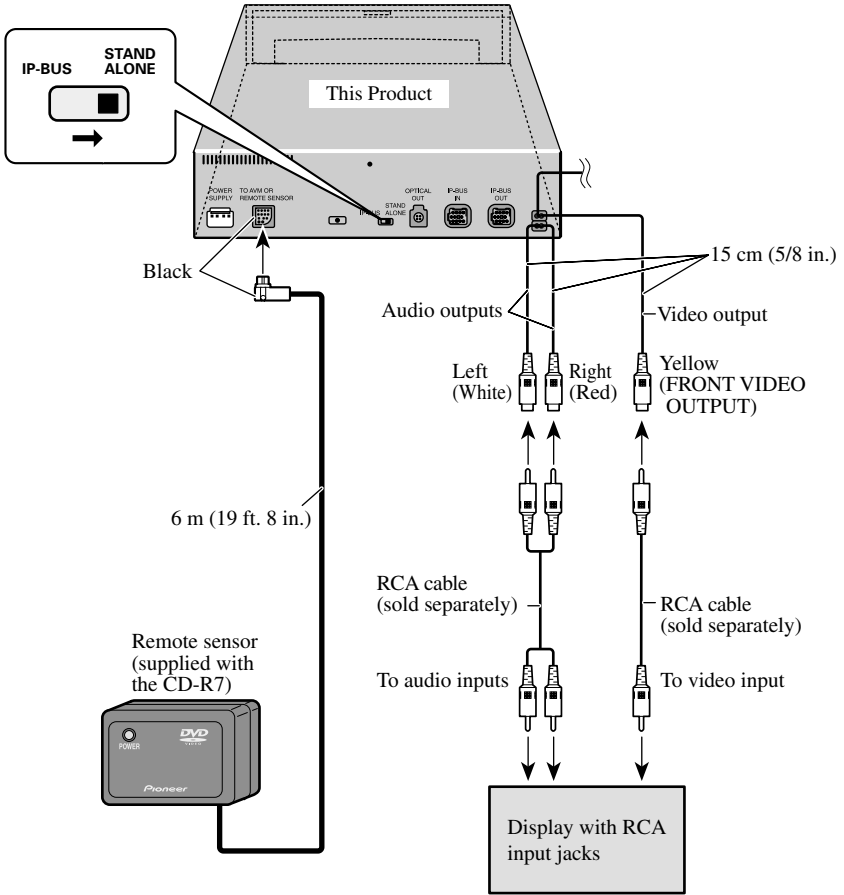

Connecting a rear display

Instead of video output for viewing on a front display, you can connect for video output enabling viewing on a rear display (for passengers in the rear of the car). If you decide to use a rear display, be sure to follow the warnings on the next page.

■ When Using a Display connected Rear Video Output

This product's Rear video output is for connection of a display to enable passengers in the Rear seats to watch the DVD or Video CD.

WARNING

- NEVER install the display in a location that enables the Driver to watch the DVD or Video CD while Driving.

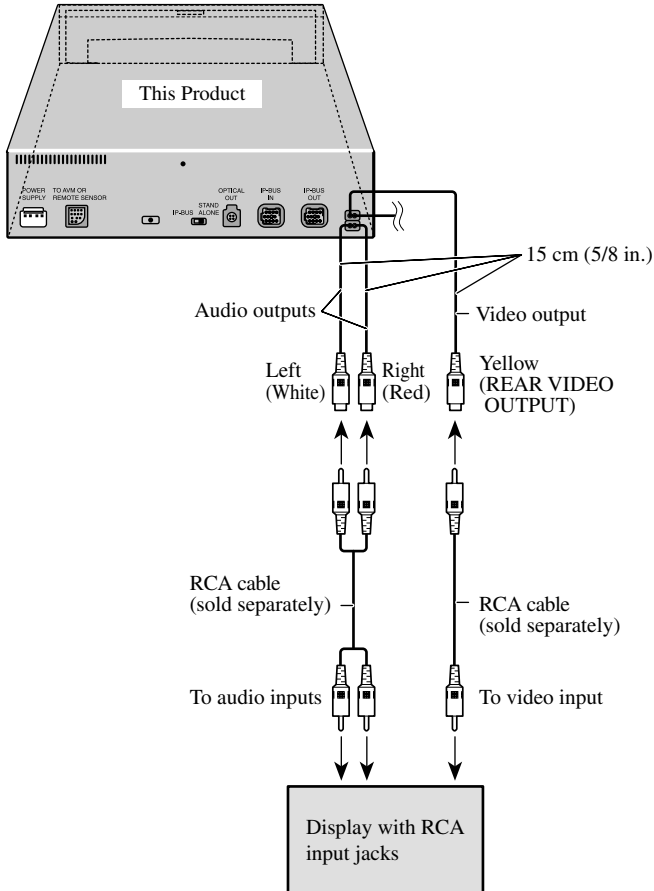

Transportation of Multi-DVD Player

A transport screw has been attached to the set in order to protect it during transportation. After removing the transport screw, cover the hole with the supplied seal. Be sure to remove the transport screw before mounting the set. The removed transport screw should be retained in the accessory bag for use the next time the set is transported.

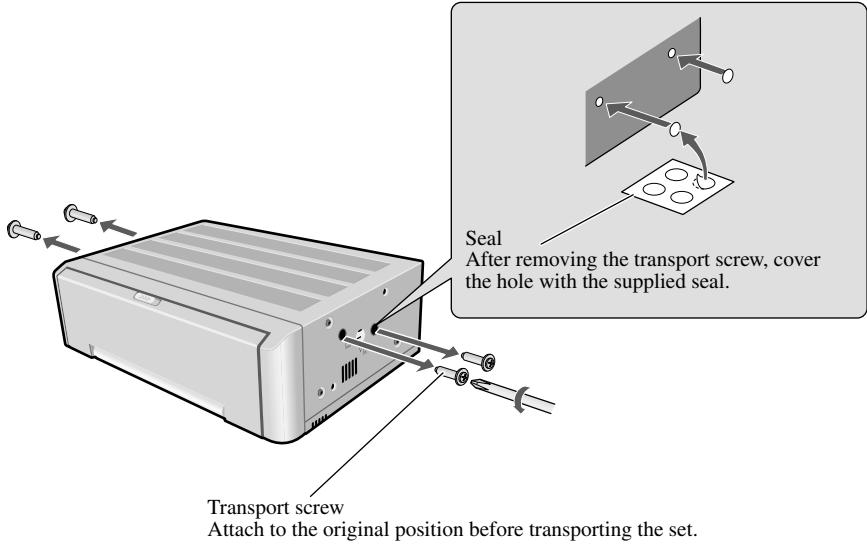

Installation

Note:

- Before finally installing the unit, connect the wiring temporarily, making sure it is all connected up properly, and the unit and the system work properly.
- Use only the parts included with the unit to ensure proper installation. The use of unauthorized parts can cause malfunctions.
- Consult with your nearest dealer if installation requires the drilling of holes or other modifications of the vehicle.
- Install the unit where it does not get in the driver's way and cannot injure the passenger if there is a sudden stop, like an emergency stop.
- When mounting this unit, make sure none of the leads are trapped between this unit and the surrounding metalwork or fittings.
- Do not mount this unit near the heater outlet, where it would be affected by heat, or near the doors, where rainwater might splash onto it.
- Before drilling any mounting holes always check behind where you want to drill the holes. Do not drill into the gas line, brake line, electrical wiring or other important parts.
- If this unit is installed in the passenger compartment, anchor it securely so it does not break free while the car is moving, and cause injury or an accident.
- If this unit is installed under a front seat, make sure it does not obstruct seat movement. Route all leads and cords carefully around the sliding mechanism so they do not get caught or pinched in the mechanism and cause a short circuit.
- Do not mount this unit on the spare tire board or any other unstable place.
- Do not mount this unit anywhere that gets the sun and so becomes hot, like on the dashboard or the rear shelf.
- Mount this unit on a flat surface.
- Installations in other than the horizontal or vertical positions indicated will prevent this product from performing correctly or could cause malfunction.

MODE Switch Setting

Before installing, use a pen tip or other thin, pointed instrument to set the MODE Switch to the appropriate position for the component you are using it with.

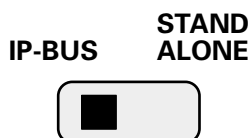

Installing the DVD Player Unit

■ Mounting Horizontally

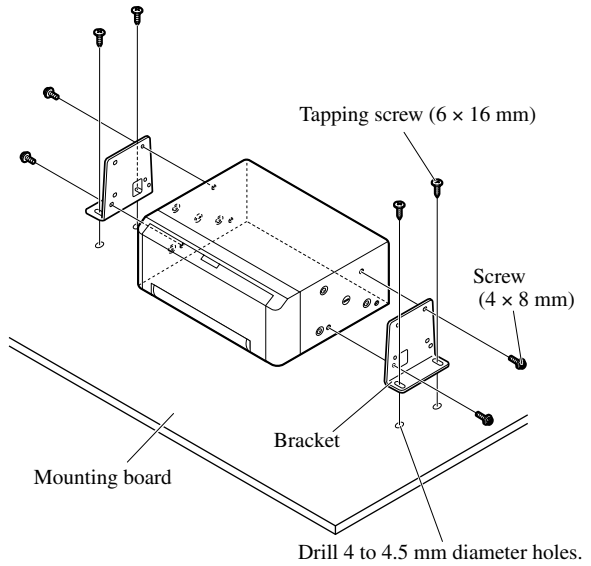
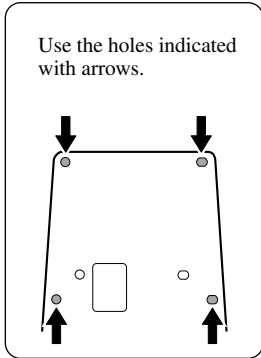

■ Mounting Vertically

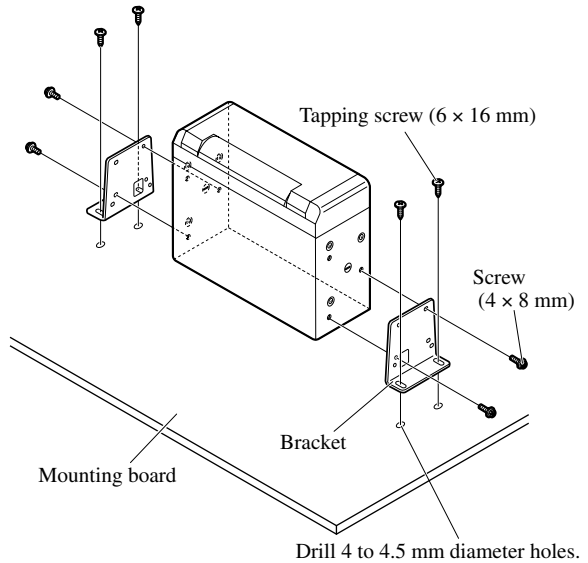
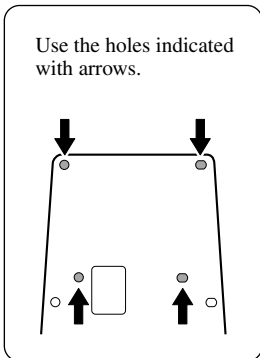

■ Mounting Angle

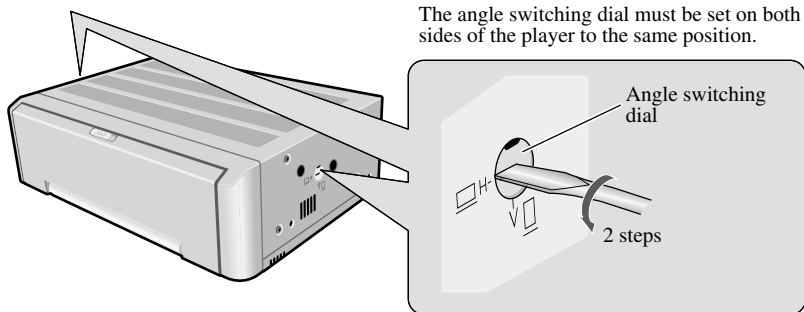
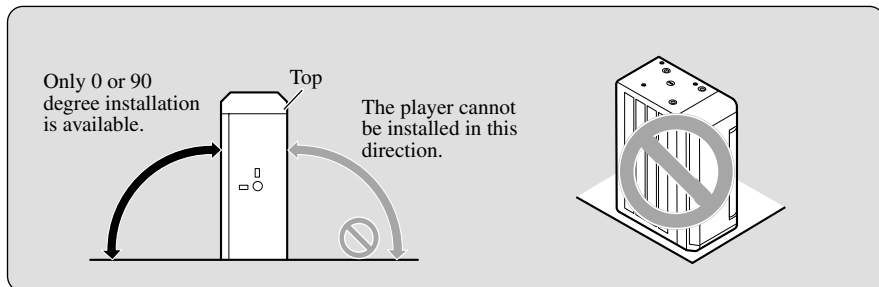

■ Angle Switching Dial Adjustment

When the mounting angle is horizontal to the ground surface, set the dial to “H” position.
When the mounting angle is vertical to the ground surface, set the dial to “V” position.

Installing the Remote Sensor

Precaution:

- Do not install on the dashboard where it may be subjected to direct sunlight. High temperatures may result in damage to the unit.
- Install within the transmission range of the remote control signal.

Stick the double-sided tape to the back of the remote sensor, and attach it to the center console.

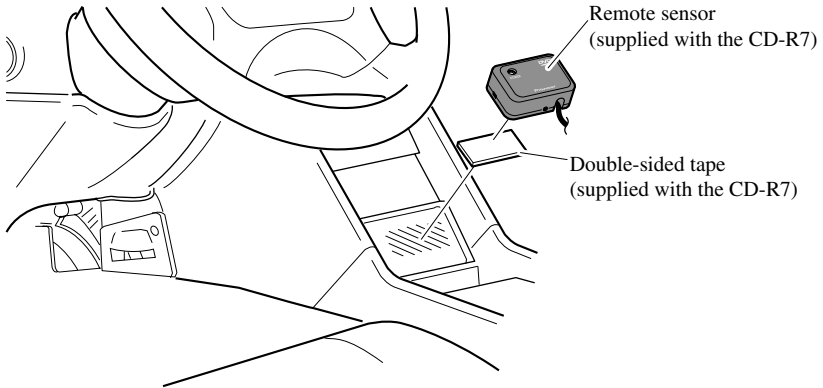

Appendix

Index

A

Angle	28, 31
Angle selection mark	28, 50
Aspect ratio	47, 61
Assist subtitle	41
Audio language	26, 43

C

Chapter	11, 61
Code number	44
Condition memory	6

D

Digital output	48
Direct search	21
DOLBY DIGITAL	12, 48, 61
DTS	12, 48, 61

F

Fast forward	22
Fast reverse	22
Frame-by-frame	24

I

Information display	29
---------------------	-----------

L

Language code chart	60
Letter box	47
Linear PCM (LPCM)	48, 49, 61

M

Menu language	44
MPEG	9, 61
Multi-angle	28, 61
Multi-audio	26, 62
Multi-subtitle	27, 62

O

Optical digital output	62
------------------------	-----------

P

Panscan	47
Parental lock	44, 62
PBC (Playback control)	11, 23, 62
Picture mode	33, 36
Prohibited mark	21, 56

R

Random play	38
Region number	10, 62
Repeat range	32, 35, 37
Reset	6

S

Scan play	38
Set-up menu	40
Slow motion playback	25
Still picture	24
Subtitle language	27, 41

T

Title	11, 62
Track	11
TV aspect	47

V

Video CD	9
----------	----------

Specifications

General

System	DVD-Video, Video CD, Compact disc audio system
Usable discs	DVD-Video, Video CD, Compact disc
Signal format	Sampling frequency: 44.1/48/96 kHz Number of quantization bits: 16/20/24; linear
Power source	14.4 V DC (10.8 – 15.1 V allowable)
Grounding system	Negative type
Max. current consumption	1.3 A
Region Number	1

Audio

(with DVD, at Sampling frequency 96 kHz)

Frequency response	5 – 44,000 Hz
Signal-to-noise ratio	96 dB (1 kHz) (IHF-A network) (CD: 99 dB (1 kHz) (IHF-A network))
Dynamic range	97 dB (1 kHz) (CD: 96 dB (1 kHz))
Distortion	0.003 % (1 kHz)
Output Level	1000 mV (1 kHz, 0 dB)
Number of channels	2 (stereo)

Player

Dimensions	275 (W) × 88 (H) × 202 (D) mm [10-7/8 (W) × 3-1/2 (H) × 8 (D) in.]
Weight	2.9 kg (6.4 lbs)

Video

Output level	1000 mV _{p-p} /75 Ω (±0.2 V)
--------------------	---------------------------------------

Note:

- Specifications and the design are subject to possible modification without notice due to improvements.



PIONEER CORPORATION

4-1, MEGURO 1-CHOME, MEGURO-KU, TOKYO 153-8654, JAPAN

PIONEER ELECTRONICS (USA) INC.

P.O. Box 1540, Long Beach, California 90801-1540, U.S.A.
TEL: (800) 421-1404

PIONEER EUROPE NV

Haven 1087, Keetberglaan 1, B-9120 Melsele, Belgium
TEL: (0) 3/570.05.11

PIONEER ELECTRONICS ASIACENTRE PTE. LTD.

253 Alexandra Road, #04-01, Singapore 159936
TEL: 65-6472-1111

PIONEER ELECTRONICS AUSTRALIA PTY. LTD.

178-184 Boundary Road, Braeside, Victoria 3195, Australia
TEL: (03) 9586-6300

PIONEER ELECTRONICS OF CANADA, INC.

300 Allstate Parkway, Markham, Ontario L3R OP2, Canada
TEL: (905) 479-4411

PIONEER ELECTRONICS DE MEXICO, S.A. de C.V.

San Lorenzo 1009 3er. Piso Desp. 302
Col. Del Valle Mexico, D.F. C.P. 03100
TEL: 55-5688-52-90

Published by Pioneer Corporation.
Copyright © 2002 by Pioneer Corporation.
All rights reserved.

Publication de Pioneer Corporation.
Copyright © 2002 Pioneer Corporation.
Tous droits de reproduction et de traduction
réservés.

Free Manuals Download Website

<http://myh66.com>

<http://usermanuals.us>

<http://www.somanuals.com>

<http://www.4manuals.cc>

<http://www.manual-lib.com>

<http://www.404manual.com>

<http://www.luxmanual.com>

<http://aubethermostatmanual.com>

Golf course search by state

<http://golfingnear.com>

Email search by domain

<http://emailbydomain.com>

Auto manuals search

<http://auto.somanuals.com>

TV manuals search

<http://tv.somanuals.com>