

**Pioneer**

**DVD RECEIVER**

**XV-HTD1**

**SPEAKER SYSTEM**

**S-HTD1**

**Operating Instructions**



**WARNING:** THE APPARATUS IS NOT WATERPROOF, TO PREVENT FIRE OR SHOCK HAZARD, DO NOT EXPOSE THIS APPLIANCE TO RAIN OR MOISTURE AND DO NOT PUT ANY WATER SOURCE NEAR THIS APPARATUS, SUCH AS VASE, FLOWER POT, COSMETICS CONTAINER AND MEDICINE BOTTLE ETC.

H001AEn

**WARNING:** NO NAKED FLAME SOURCES, SUCH AS LIGHTED CANDLE, SHOULD BE PLACED ON THE APPARATUS. IF NAKED FLAME SOURCES ACCIDENTALLY FALL DOWN, FIRE SPREAD OVER THE APPARATUS THEN MAY CAUSE FIRE.

H044 En

## IMPORTANT



The lightning flash with arrowhead symbol, within an equilateral triangle, is intended to alert the user to the presence of uninsulated "dangerous voltage" within the product's enclosure that may be of sufficient magnitude to constitute a risk of electric shock to persons.

### CAUTION

**RISK OF ELECTRIC SHOCK  
DO NOT OPEN**

#### CAUTION:

TO PREVENT THE RISK OF ELECTRIC SHOCK, DO NOT REMOVE COVER (OR BACK). NO USER-SERVICEABLE PARTS INSIDE. REFER SERVICING TO QUALIFIED SERVICE PERSONNEL.



The exclamation point within an equilateral triangle is intended to alert the user to the presence of important operating and maintenance (servicing) instructions in the literature accompanying the appliance. H002\_En

### European and UK models only

*This product complies with the Low Voltage Directive (73/23/EEC, amended by 93/68/EEC), EMC Directives (89/336/EEC, amended by 92/31/EEC and 93/68/EEC).*

H015AEn

#### CAUTION:

THE STANDBY/ON BUTTON IS SECONDARY CONNECTED AND THEREFORE DOES NOT SEPARATE THE UNIT FROM MAINS POWER IN STANDBY POSITION. THEREFORE INSTALL THE UNIT SUITABLE PLACES EASY TO DISCONNECT THE MAINS PLUG IN CASE OF THE ACCIDENT. THE MAINS PLUG OF UNIT SHOULD BE UNPLUGGED FROM THE WALL SOCKET WHEN LEFT UNUSED FOR A LONG PERIOD OF TIME. H017BEn

**WARNING:** BEFORE PLUGGING IN THE UNIT FOR THE FIRST TIME, READ THE FOLLOWING SECTION CAREFULLY. THE VOLTAGE OF THE AVAILABLE POWER SUPPLY DIFFERS ACCORDING TO COUNTRY OR REGION, BE SURE THAT THE POWER SUPPLY VOLTAGE OF THE AREA WHERE THIS UNIT WILL BE USED MEETS THE REQUIRED VOLTAGE (E.G., 230V OR 120V) WRITTEN ON THE REAR PANEL. H041 En

**CAUTION:** The STANDBY/ON switch does not completely separates the unit from the MAINS in off position, therefore install the unit suitable places easy to disconnect the MAINS plug in case of the accident. The MAINS plug of unit should be unplugged from the wall socket when left unused for a long period of time. H046 En

**CAUTION:** These speaker terminals can be under HAZARDOUS VOLTAGE. When you connect or disconnect the speaker cables, to prevent the risk of electric shock, do not touch uninsulated parts before disconnecting the power cord. H047 En

**VENTILATION:** When installing this unit, make sure to leave space around the unit for ventilation to improve heat radiation (at least 10 cm at top, 10 cm at rear, and 5 cm at each side).

**WARNING:** Slots and openings in the cabinet are provided for ventilation and to ensure reliable operation of the product and to protect it from overheating, to prevent fire hazard, the openings should never be blocked and covered with items, such as newspapers, table-cloths, curtains, etc. Also do not put the apparatus on the thick carpet, bed, sofa, or fabric having a thick pile. H040 En

### CAUTION

This product contains a laser diode of higher class than 1. To ensure continued safety, do not remove any covers or attempt to gain access to the inside of the product.

Refer all servicing to qualified personnel.

**The following caution label appear on your player.**

Location: On the rear panel of the player

CLASS 1  
LASER PRODUCT

On the bonnet of the player

**CAUTION** : VISIBLE AND INVISIBLE LASER RADIATION WHEN OPEN.  
AVOID EXPOSURE TO BEAM.

**VORSICHT** : SICHTBARE UND UNSICHTBARE LASERSTRAHLUNG, WENN ABDECKUNG GEÖFFNET NICHT DEM STRAHL AUSSETZEN!

**ADVARSEL** : SYNLIG OG USYNLIG LASERSTRÅLING VED ÅBNING  
: UNDGÅ UDSÆTTELSE FOR STRÅLING.

**VARNING** : SYNLIG OCH USYNLIG LASERSTRÅLNING NÄR DENNA  
: DEL ÄR ÖPPNAD BETRÄKTA EJ STRÅLEN.

**VARO!** : AVATTAESSA ALTISTUT NÄKYVÄ JA NÄKYMÄTTÖMÄLLÄ  
LASERSATEIL YLLÄ. ÄLÄ KATSO SÄTEESÄN. VRW1699

### Operating Environment H045 En

Operating environment temperature and humidity:  
+5°C – +35°C (+41°F – +95°F); less than 85%RH (cooling vents not blocked)

Do not install in the following locations

- Location exposed to direct sunlight or strong artificial light
- Location exposed to high humidity, or poorly ventilated location

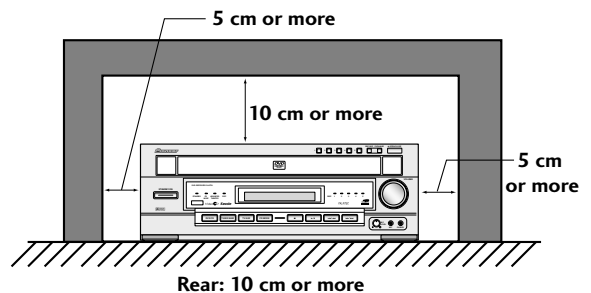

**NOTE:** This equipment has been tested and found to comply with the limits for a Class B digital device, pursuant to Part 15 of the FCC Rules. These limits are designed to provide reasonable protection against harmful interference in a residential installation. This equipment generates, uses, and can radiate radio frequency energy and, if not installed and used in accordance with the instructions, may cause harmful interference to radio communications. However, there is no guarantee that interference will not occur in a particular installation. If this equipment does cause harmful interference to radio or television reception, which can be determined by turning the equipment off and on, the user is encouraged to try to correct the interference by one or more of the following measures:

- Reorient or relocate the receiving antenna.
- Increase the separation between the equipment and receiver.
- Connect the equipment into an outlet on a circuit different from that to which the receiver is connected.
- Consult the dealer or an experienced radio/TV technician for help.

H010 En

### Information to User

Alteration or modifications carried out without appropriate authorization may invalidate the user's right to operate the equipment.

H011 En

**CAUTION :** USE OF CONTROLS OR ADJUSTMENTS OR PERFORMANCE OF PROCEDURES OTHER THAN THOSE SPECIFIED HEREIN MAY RESULT IN HAZARDOUS RADIATION EXPOSURE.

**CAUTION :** THE USE OF OPTICAL INSTRUMENTS WITH THIS PRODUCT WILL INCREASE EYE HAZARD.

H013 En

## CONGRATULATIONS ON YOUR PURCHASE OF THIS FINE PIONEER PRODUCT.

Pioneer is on the leading edge of DVD research for consumer products and this unit incorporates the latest technological developments. We are sure you will be fully satisfied with the DVD player. Thank you for your support.

### LINE VOLTAGE SELECTOR SWITCH

**Only multi-voltage model is provided with this switch.**

**Mains voltages in Saudi Arabia are 127 V and 220 V only. Never use this model with the 110 V setting in Saudi Arabia.** H019 En

The line voltage selector switch is located on the rear panel. Check that it is set properly before plugging the power cord into the outlet. If the voltage is not properly set or if you move to an area where the voltage requirements differ, adjust the selector switch as follows:

- Be sure to disconnect the power cord from its outlet before making this adjustment.
- Use a medium-sized (flat blade) screwdriver. Insert the tip of the screwdriver into the groove of the selector switch and turn it so that the power voltage marking of your area points to the arrow.

#### VOLTAGE SELECTOR



#### CAUTION 220 – 230 V

Power source voltage is factory adjusted 220 - 230 volts. If your area is different, change voltage selectors settings.

H038 En

Thank you for buying this Pioneer product.

Please read through these operating instructions so you will know how to operate your model properly. After you have finished reading the instructions, put them away in a safe place for future reference.

In some countries or regions, the shape of the power plug and power outlet may sometimes differ from that shown in the explanatory drawings. However, the method of connecting and operating the unit is the same.

Please read through these operating instructions so you will know how to operate your model properly. After you have finished reading the instructions, put them away in a safe place for future reference.

- This player is not suitable for commercial use.

This product incorporates copyright protection technology that is protected by method claims of certain U.S. patents and other intellectual property rights owned by Macrovision Corporation and other rights owners. Use of this copyright protection technology must be authorized by Macrovision Corporation, and is intended for home and other limited viewing uses only unless otherwise authorized by Macrovision Corporation. Reverse engineering or disassembly is prohibited.

## IMPORTANT

### FOR USE IN THE UNITED KINGDOM

The wires in this mains lead are coloured in accordance with the following code :

Blue : Neutral  
Brown : Live

If the plug provided is unsuitable for your socket outlets, the plug must be cut off and a suitable plug fitted.

The cut-off plug should be disposed of and must not be inserted into any 13 amp socket as this can result in electric shock. The plug or adaptor or the distribution panel should be provided with 5 A fuse. As the colours of the wires in the mains lead of this appliance may not correspond with coloured markings identifying the terminals in your plug, proceed as follows ;

The wire which is coloured blue must be connected to the terminal which is marked with the letter N or coloured black.

The wire which is coloured brown must be connected to the terminal which is marked with the letter L or coloured red.

Do not connect either wire to the earth terminal of a three pin plug.

#### NOTE

After replacing or changing a fuse, the fuse cover in the plug must be replaced with a fuse cover which corresponds to the colour of the insert in the base of the plug or the word that is embossed on the base of the plug, and the appliance must not be used without a fuse cover. If lost replacement fuse covers can be obtained from: your dealer.

Only 5 A fuses approved by B.S.I. or A.S.T.A to B.S. 1362 should be used.

H0058En

## Features

- **Superlative audio performance with Dolby Digital\* and DTS\*\* software**

The XV-HTD1 delivers breathtaking sound quality with Dolby Digital and DTS discs.

- **Graphical Setup Navigator**

Setting up your home theater is easy using the graphical Setup Navigator. Answer the questions that appear on-screen and the Setup Navigator makes the necessary video and language settings for you.

- This product incorporates copyright protection technology that is protected by method claims of certain U. S. patents and other intellectual property rights owned by Macrovision Corporation and other rights owners. Use of this copyright protection technology must be authorized by Macrovision Corporation, and is intended for home and other limited viewing uses only unless otherwise authorized by Macrovision Corporation. Reverse engineering or disassembly is prohibited.

\* Manufactured under license from Dolby Laboratories. "Dolby" and the double-D symbol are trademarks of Dolby Laboratories. Confidential unpublished works. © 1992-1997 Dolby Laboratories. All rights reserved.

\*\* "DTS" and "DTS Digital Surround" are registered trademarks of Digital Theater Systems, Inc.

## What's in the box

Confirm that the following accessories are in the box when you open it.

- Remote control
- AA/R6P dry cell batteries x2
- AM loop antenna
- FM antenna
- Video cord (yellow)
- Power cord x1 (x2 (Central and South America models only))
- These operating instructions
- Warranty card (European and Australian models only)
- Speaker cords 5m x2 (for front L-R speakers)
- Speaker cord 2m x1 (for center speaker)
- Speaker cords 6m x2 (for rear L-R speakers)
- Speaker cord 3m x1 (for subwoofer)
- Power plug adapter (Central and South America models only)

## Using this manual

This manual is for the XV-HTD1 DVD Receiver. It is divided into several sections: system basics and connecting up (chapters 1 and 2); an explanation of the controls and displays (chapter 3); setting up for surround sound and other preferences (chapter 4); getting started (chapter 5); advanced features (chapters 6–10); system settings and preferences (chapter 11).

## Contents

<b>1 Before You Start</b>		<b>6 Using Surround Sound</b>		<b>11 DVD Setup Menu</b>	
Features	4	Adjusting the bass and treble	23	Using the DVD Setup menu	38
What's in the box	4	Using P.Bass	23	Video settings	38
Using this manual	4	Using sound modes	23	TV Screen	38
Putting the batteries in		Listening to surround-sound		Picture Quality	38
the remote control	6	sources	23	S-Video Out	39
Using the remote control	6	Listening to other sources with		Still Picture	39
Hints on installation	6	room effects	24	On Screen Display	39
Avoiding problems with		Adjusting the effect level	24	Angle Indicator	39
condensation	7	Listening at low volume	25	Language settings	39
Moving the system	7	Direct recording	25	OSD language	39
Discs compatible with this system	7	<b>7 Playing Discs</b>		Audio Language	40
DVD Video regions	7	Introduction	26	Subtitle Language	40
<b>2 Connecting Up</b>		Finding what you want on a disc	26	Auto Language	40
Connecting the speakers	8	Switching camera angles	26	DVD Language	41
Placing the speakers	9	Switching subtitles	26	Subtitle Display	41
Wall mounting the rear speaker		Switching audio language	26	Subtitle Off	41
system	9	Switching audio channel	26	General settings	41
Connecting to your TV	10	Making a program list	27	Setup Menu Mode	41
Setting the TV System	10	More programming options	28	Parental Lock	42
Connecting the supplied antennas	11	Using random play	28	Changing the parental lock level	42
AM loop antenna	11	Using repeat play	28	Changing your password	42
FM wire antenna	11	Looping a section of a disc	29	Screen Saver	43
Connecting external antennas	12	Playing CDs only (CD Mode)	29	Background Color	43
External AM antenna	12	Bookmarking a place in a disc	29	<b>12 Additional Information</b>	
External FM antenna	12	Memorizing disc settings	30	Switching the AM frequency	
Connecting other components	13	Displaying disc information	30	interval	44
Connecting the power	13	Singing karaoke (Except European	31	Setting the display brightness	44
<b>3 Controls &amp; Displays</b>		model)		Switching the time format	44
Remote control	14	<b>8 Using RDS (European</b>		Resetting the system	44
Front panel	15	<b>model only)</b>		Taking care of your system	45
Display	15	Using RDS	32	Disc lens cleaner	45
<b>4 Setting Up</b>		RDS Program types	32	Taking care of your discs	45
Switching on and setting the clock	16	Displaying RDS information	33	Storing discs	45
Setting up for surround sound	16	Searching for a program type	33	Discs to avoid	45
Setting the speaker distances	16	<b>9 Using the Timer</b>		Glossary	46
Balancing the surround sound	17	Using the wake up timer	34	Language code list	47
Using the Setup Navigator	18	Activating/deactivating the		Troubleshooting	48
<b>5 Getting Started</b>		wake up timer	34	Screen sizes and disc formats	50
Playing DVDs, CDs and Video CDs	19	Checking the timer settings	35	Specifications	51
Basic playback controls	19	Using the sleep timer	35	Switching the demo mode on/off	52
Navigating DVD disc menus	20	<b>10 Advanced Sound Setup</b>			
Navigating Video CD PBC menus	20	Advanced sound settings	36		
Exchanging discs	21	LFE attenuator	36		
Listening to the radio	21	Dynamic Range Control	36		
Improving FM stereo sound	22	Dual-mono setting	37		
Saving station presets	22	Adjusting channel volume levels	37		
Listening to station presets	22				
Listening to other components	22				

Chapter 12 provides additional information, including a glossary of terms used in this manual, and a troubleshooting section.

## Putting the batteries in the remote control

- 1 **Open the battery compartment cover on the back of the remote control.**

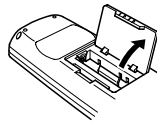

- 2 **Insert two AA/R6P batteries into the battery compartment following the indications (+, -) inside the compartment.**

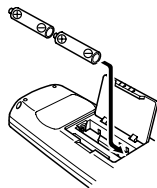

- 3 **Close the cover.**

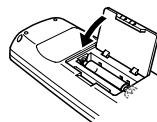

### Caution

- Remove the batteries if the remote is not going to be used for a month or more.
- Remove dead batteries promptly—they can leak and damage the unit.
- When disposing of used batteries, please comply with governmental regulations or environmental public institution's rules that apply in your country or area.

## Using the remote control

Keep in mind the following when using the remote control:

- Make sure that there are no obstacles between the remote control and the remote sensor on the unit.
- Use within 7 meters of the remote sensor and at an angle of less than 30°.
- Remote operation may become unreliable if strong sunlight or fluorescent light is shining on the unit's remote sensor.
- Remote controllers for different devices can interfere with each other. Avoid using remotes for other equipment located nearby this unit.
- Replace the batteries when you notice the operating range of the remote starts to decrease.

## Hints on installation

We want you to enjoy using this unit for years to come, so please bear in mind the following points when choosing a suitable location for it:

### Do...

- ✓ Use in a well-ventilated room.
- ✓ Place on a solid, flat, level surface, such as a table, shelf or stereo rack.

### Don't...

- ✗ Use in a place exposed to high temperatures or humidity, including near radiators and other heat-generating appliances.
- ✗ Place on a window sill or other place where the system will be exposed to direct sunlight.
- ✗ Use in an excessively dusty or damp environment.
- ✗ Place directly on top of an amplifier, or other component in your stereo system that becomes hot in use.

- ✗ Use near a television or monitor as you may experience interference—especially if the television uses an indoor antenna.
- ✗ Use in a kitchen or other room where the system may be exposed to smoke or steam.
- ✗ Use on a thick rug or carpet, or cover with cloth—this may prevent proper cooling of the unit.
- ✗ Place on an unstable surface, or one that is not large enough to support all four of the unit's feet.

### Avoiding problems with condensation

Condensation may form inside the system if it is brought into a warm room from outside, or if the temperature of the room rises quickly. Although the condensation won't damage the system, it may temporarily impair its performance. For this reason you should leave it to adjust to the warmer temperature for about an hour before switching on and using.

### Moving the system

If you need to move the system, first switch it off and unplug from the wall outlet. Never lift or move the unit during playback—discs rotate at a high speed and may be damaged.

### Discs compatible with this system

Any disc that displays one of the following logos should play in this system. Other formats, including DVD-RAM, DVD-ROM, DVD-Audio, CD-ROM, SACD and Photo CD will not play.



#### DVD Video compatibility:

- Single-sided or double-sided discs
- Single layer or dual layer discs
- Dolby Digital, DTS, MPEG or Linear PCM digital audio
- MPEG-2 digital video

DVD discs are generally divided into one or more titles. Titles may be further subdivided into chapters.



#### Audio CD compatibility:

- 12cm or 8cm (5" or 3") discs
- Linear PCM digital audio
- CD-Audio, CD-R\* and CD-RW\* formats

CDs are divided into tracks.

\* This system can play CD-R and CD-RW discs recorded with audio. However, depending on the condition of the player and the disc, you may find that not all discs will play successfully. (For example, if the disc is scratched or dirty, or if the player's pickup lens is dirty.) Note that this unit cannot record onto recordable discs.



#### Video CD compatibility:

- 12cm or 8cm (5" or 3") discs
- MPEG-1 digital audio
- MPEG-1 digital video

Video CDs are divided into tracks.

#### DVD Video regions



All DVD Video discs carry a region mark on the case somewhere that indicates which region(s) of the world the disc is compatible with. Your DVD system also has a region mark, which you can find on the rear panel. Discs from incompatible regions will not play in this system. Discs marked **ALL** will play in any player.



## Important

Before making or changing any rear panel connections, make sure that all the components are switched off and unplugged from the power supply.

## Connecting the speakers

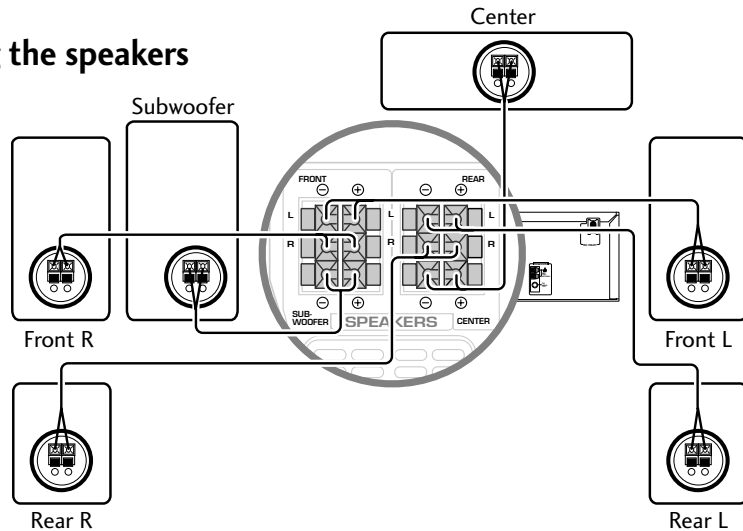

The speaker terminal tabs and supplied speaker cables are color-coded for simpler connection.

- 1 Use the speaker cables with the red sleeves to connect the front speakers to the FRONT L and FRONT R terminals.
- 2 Use the speaker cables with the blue sleeves to connect the rear speakers to the REAR L and REAR R terminals.
- 3 Use the speaker cable with the grey sleeves to connect the subwoofer to the SUBWOOFER terminals.
- 4 Use the speaker cable with the green sleeves to connect the center speaker to the CENTER terminals.

For proper sound, it's important to connect the positive (colored) and negative (black) terminals for each speaker correctly.

- 1 Twist off the protective covers on the ends of the speaker cable.



- 2 Press the speaker terminal tabs to open and insert the wire with the colored sleeve into the colored terminal and the other wire into the black terminal.

- 3 Release the speaker terminal tabs to secure the speaker cable.

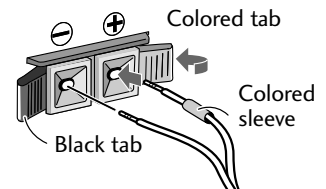

- 4 Connect the other end of the cable to the speaker in the same way.

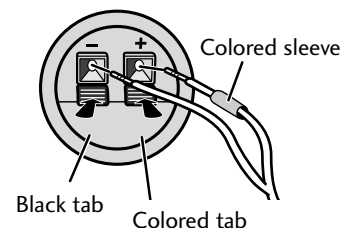





**Caution**

Do not connect any of the supplied speakers to any other amplifier. This may result in malfunction or fire. This DVD receiver has been designed for best performance when connected to the supplied speakers. We do not, therefore, recommend that you connect and use other speakers with this system.

**Placing the speakers**

Where you put your speakers in the room has a big effect on the quality of the sound. The following guidelines should help you to get the best sound from your system.

- The subwoofer can be placed on the floor. Ideally, the other speakers should be at about ear-level when you're listening to them. Putting the speakers on the floor (except the subwoofer), or mounting them very high on a wall is not recommended.
- For the best stereo effect, place the front speakers 2–3m apart.
- The rear speakers should not be further away from your listening position than the front speakers.
- The center speaker should be as close as possible to the TV screen so that movie dialog is localized properly.

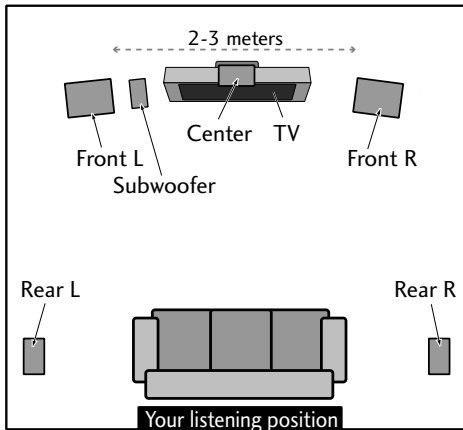

**Note**

If you install the center speaker on top of your TV, be sure to secure it with tape or by some other suitable means. An unsecured speaker may fall from the TV due to external shocks such as earthquakes, endangering those nearby or damaging the speaker.



**Important**

The front and center speakers supplied with this system are magnetically shielded. However, placing them extremely close to a television may result in color distortion on the screen. If this happens, move the speakers a little further away and switch off the television for 15–30 minutes.

The rear speakers and subwoofer are not magnetically shielded, so they should not be placed near a TV or monitor.

**Wall mounting the rear speaker system**

**Before mounting**

- Remember that this speaker system is heavy and that its weight may cause the wood screw to work loose or the wall to fail to support it, in which case the speaker system may fall on the floor. This is extremely dangerous. Make absolutely sure that the wall is sturdy enough to support the weight of the speaker system. Do not mount it on plywood boards or soft-surface walls. **The mounting screws are not included with this unit. Please find the correct screws for your application.**

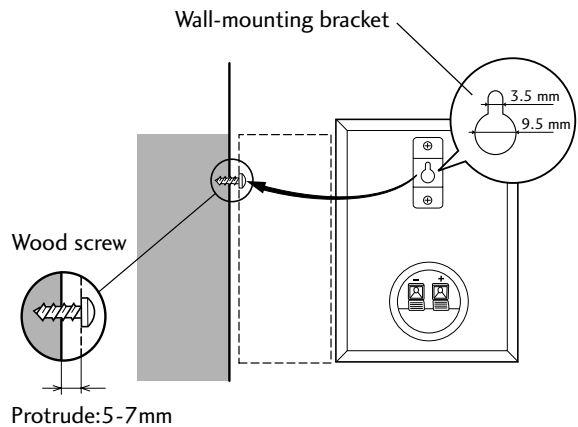

**Note**

- If you are unsure of the qualities and strength of the walls, consult a professional for advice.
- PIONEER is not responsible for any accidents or damage that result from improper installation.

## Connecting to your TV

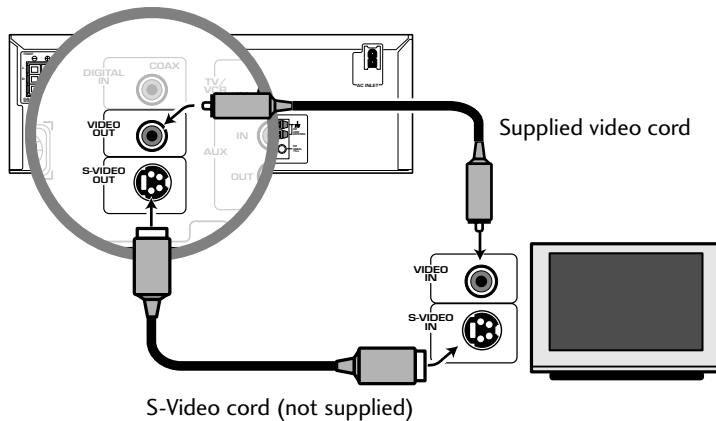

- 1 Use the supplied yellow video cord to connect the VIDEO OUT jack to a video input on your TV.**

Alternatively, you can use an S-Video cable (not supplied) to connect the **S-VIDEO OUT** jack to an S-Video input on your TV. S-Video should give you better picture quality than using the standard **VIDEO OUT**.

- See *S-Video Out* on page 39 for how to change the S-Video setting between S1 and S2 format.

- 2 Optionally: Use a stereo audio cord to connect the audio outs of your TV (or VCR) to the TV/VCR IN jacks.**

This will enable you to hear the TV (or VCR) sound through this system.

- If you want to connect both your TV and VCR, use the **TV/VCR IN** jacks for one and the **AUX IN** jacks for the other.



### Note

Placing the main unit too close to your TV may cause interference, especially if you're using an indoor antenna. If you notice interference, move the unit away from the TV.

## Setting the TV System

The default setting of this player is **AUTO**, and unless you notice that the picture is distorted when playing some discs, you should leave it set to **AUTO**.

If you experience picture distortion with some discs, set the TV system to match your country or region.

- 1 Make sure that the system is in standby.**
- 2 Press SYSTEM SETUP.**  
The current TV system is shown in the display.
- 3 Use ▲ or ▼ to change the TV system.**  
Switch between **auto**, **ntsc** and **pal**.
- 4 Press ENTER.**  
The system returns to standby power.

## Connecting the supplied antennas

### European model

FM wire antenna

AM loop antenna

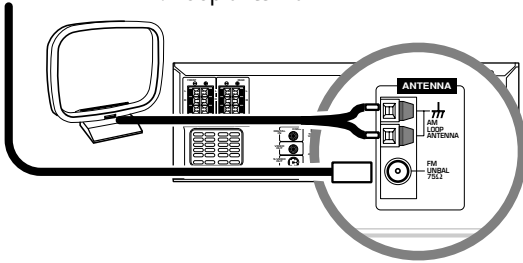

### Except European model

FM wire antenna

AM loop antenna

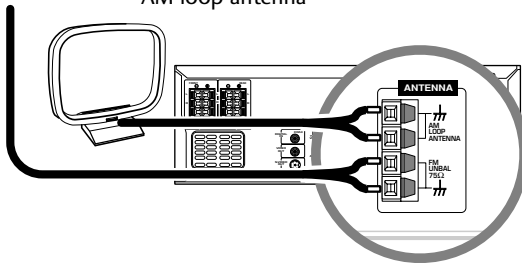

The supplied antennas provide a simple way to listen to AM and FM radio. If you find that reception quality is poor, an outdoor antenna should give you better sound quality—see *Connecting external antennas* on page 12 for more on how to do this.

fig. A

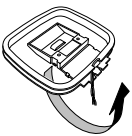

fig. B

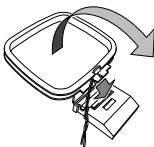
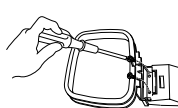

fig. C



## AM loop antenna

- 1 Pull off the protective shields of both AM antenna wires.
- 2 Press the antenna terminal tabs to open and insert one wire into each terminal.
- 3 Release the tabs to secure the AM antenna wires.
- 4 Bend the stand in the direction indicated by the arrow (see fig. A below left).
- 5 Clip the loop onto the stand (fig. B below left).
- 6 Place the AM antenna on a flat surface and point in the direction giving the best reception.

Avoid placing near computers, television sets or other electrical appliances and do not let it come into contact with metal objects.

It's also possible to fix the AM antenna to a wall. When installing on a wall or other surface, perform steps 4 and 5 after first securing the stand with screws (see fig. C below left). Before fixing, make sure that the reception is satisfactory.

## FM wire antenna

- Connect the FM wire antenna to the FM UNBAL 75Ω terminals in the same way as the AM loop antenna.

For best results, extend the FM antenna fully and fix to a wall or door frame. Don't drape loosely or leave coiled up.

### Note

The signal earth (⌚) is designed to reduce noise that occurs when an antenna is connected. It is not an electrical safety earth.

## Connecting external antennas

### External AM antenna

Use 5–6 meters of vinyl-insulated wire and set up either indoors or outdoors. Leave the supplied AM loop antenna connected.

### External FM antenna

Except European model : Use 75Ω coaxial cable to hook up an external FM antenna. Do not leave the supplied FM wire antenna attached.

European model : Use 75Ω coaxial cable with a PAL connector to hook up an external FM antenna.

#### European model

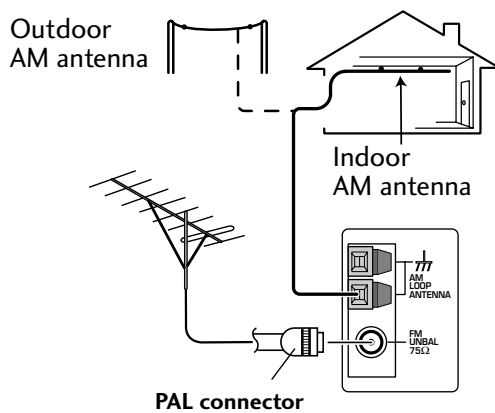

#### Except European model

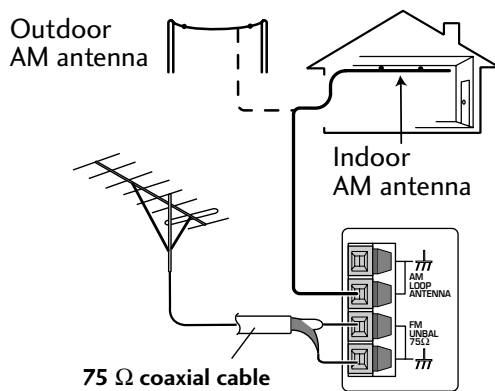

## Connecting other components

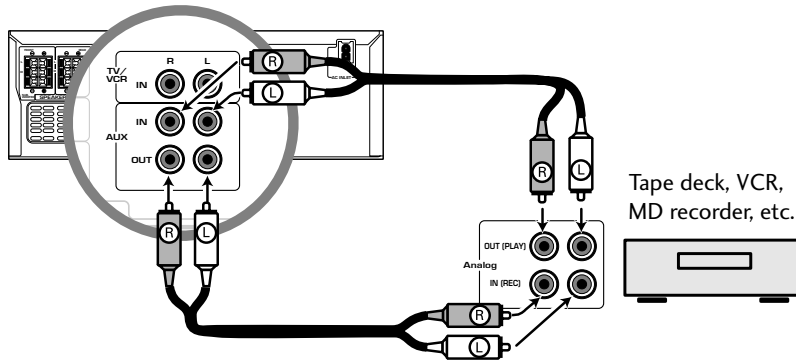

- 1 **Use a stereo audio cable to connect the AUX IN jacks to the analog outputs of an external component.**  
This will allow you to play the component through this system.
- 2 **Use a stereo audio cable to connect the AUX OUT jacks to the analog inputs of an external component.**  
This will allow you to record from this system to an external tape/MD/CD recorder.
- 3 **Use a digital coaxial cable to connect the DIGITAL IN COAX jack to the digital output of an external component.**  
This will allow you to play a digital audio component (MD player, etc.) through this system.



### Important

The **DIGITAL IN COAX** jack should only be connected to a PCM audio output (32, 44.1 or 48kHz). These include CD, MD and DAT players and satellite receivers. Check the instructions that came with your other component for more details.

## Connecting the power

Before connecting the power and switching on for the first time make sure that everything is connected properly (See page 3).

- 1 **Plug one end of the supplied power cord into the AC INLET.**
- 2 **Plug the other end into a household power outlet.**

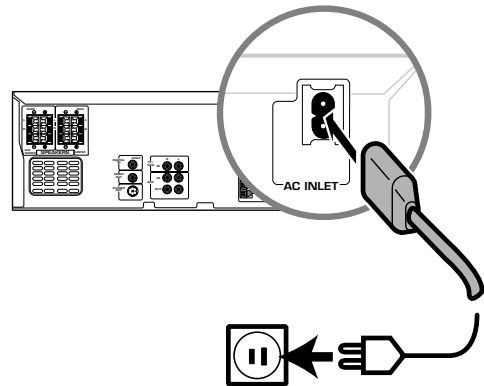

## Remote control

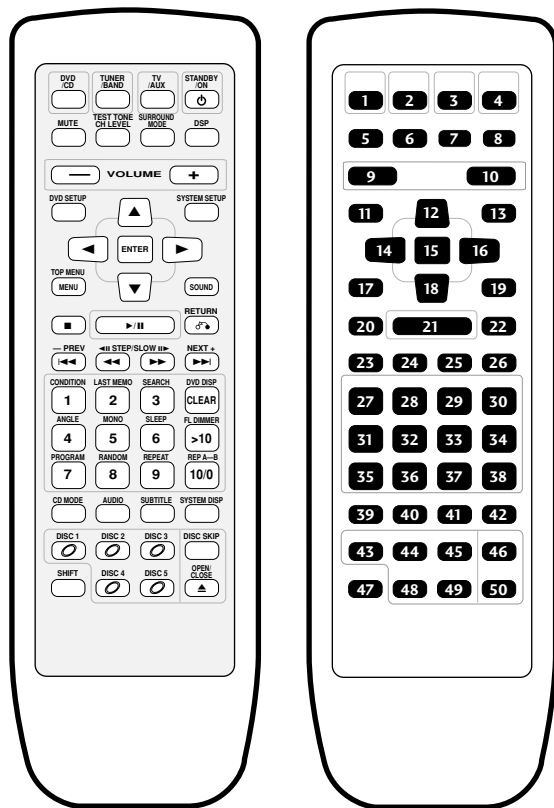

- 1 **DVD/CD** Pages 19, 34
- 2 **TUNER/BAND** Pages 21-22, 34
- 3 **TV/AUX** Pages 22, 34
- 4 **STANDBY/ON** Page 19
- 5 **MUTE** Silences/restores all sound.
- 6 **TEST TONE/CH LEVEL** Page 17
- 7 **SURROUND MODE** Pages 17, 24
- 8 **DSP** Page 24
- 9 **VOLUME -** Lowers the volume.
- 10 **VOLUME +** Raises the volume.
- 11 **DVD SETUP** Pages 18, 38
- 12 **Cursor up** Use for navigating menus and on-screen displays.
- 13 **SYSTEM SETUP** Pages 16, 22, 34-37, 44
- 14 **Cursor left** Use for navigating menus and on-screen displays.

- 15 **ENTER**
- 16 **Cursor right** Use for navigating menus and on-screen displays.
- 17 **MENU** Page 20
- TOP MENU** Page 20
- 18 **Cursor down** Use for navigating menus and on-screen displays.
- 19 **SOUND** Page 24, 25
- 20 **■** Page 19
- 21 **▶/||** Page 19
- 22 **RETURN** Page 20
- 23 **◀◀ / -PREV** Pages 19-20
- 24 **◀◀ / STEP/SLOW ◀||** Pages 19-20
- 25 **▶▶ / STEP/SLOW ||▶** Pages 19-20
- 26 **▶▶ / NEXT+** Pages 19-20
- 27 **1 / CONDITION (SHIFT & 1)** Page 30
- 28 **2 / LAST MEMO (SHIFT & 2)** Page 29
- 29 **3 / SEARCH (SHIFT & 3)** Page 26
- 30 **CLEAR** Clears/cancels various functions  
**DVD DISP (SHIFT & CLEAR)** Page 30
- 31 **4 / ANGLE (SHIFT & 4)** Page 26
- 32 **5 / MONO (SHIFT & 5)** Page 22
- 33 **6 / SLEEP (SHIFT & 6)** Page 35
- 34 **>10** Selects numbers over 10 Page 20  
**FL DIMMER (SHIFT & >10)** Page 44
- 35 **7 / PROGRAM (SHIFT & 7)** Page 28
- 36 **8 / RANDOM (SHIFT & 8)** Page 28
- 37 **9 / REPEAT (SHIFT & 9)** Page 28
- 38 **REP A-B (SHIFT & 10/0)** Page 29  
**10/0** Number button (10 and 0)
- 39 **CD MODE** Page 29
- 40 **AUDIO** Page 26
- 41 **SUBTITLE** Page 26
- 42 **SYSTEM DISP** Page 16
- 43 **DISC 1** Page 20
- 44 **DISC 2** Page 20
- 45 **DISC 3** Page 20
- 46 **DISC SKIP** Pages 19, 21
- 47 **SHIFT** Hold down to access secondary button functions
- 48 **DISC 4** Page 20
- 49 **DISC 5** Page 20
- 50 **OPEN/CLOSE** Pages 19, 21

## Front panel

This illustration is not European model.

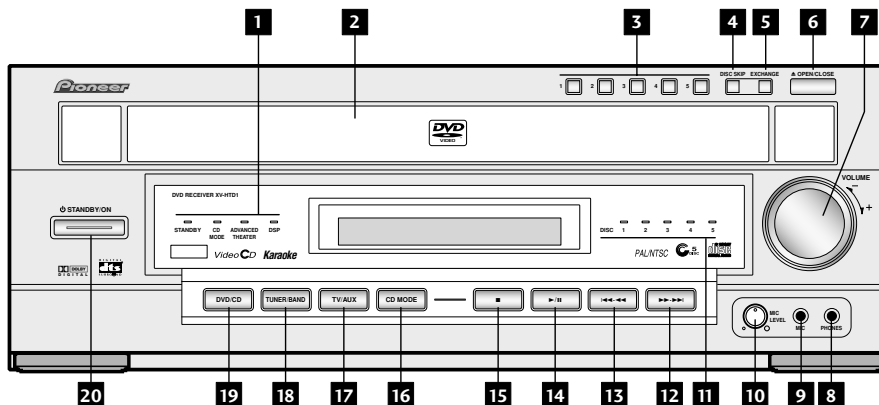

- |   |   |
|---|---|
| <p><b>1</b> STANDBY indicator<br/>CD MODE indicator<br/>ADVANCED THEATER indicator<br/>DSP indicator</p> <p><b>2</b> Disc tray</p> <p><b>3</b> Disc buttons Page 20</p> <p><b>4</b> DISC SKIP Pages 19, 21</p> <p><b>5</b> EXCHANGE Page 21</p> <p><b>6</b> ▲ OPEN/CLOSE Pages 19, 21</p> <p><b>7</b> VOLUME Turn to adjust the volume.</p> <p><b>8</b> PHONES Plug in a pair of headphones here.</p> | <p><b>9</b> Mic input (Except European model)</p> <p><b>10</b> Mic volume (Except European model)</p> <p><b>11</b> DISC indicators</p> <p><b>12</b> ►► • ►►  Pages 19-20</p> <p><b>13</b>  ◀◀ • ◀◀  Pages 19-20</p> <p><b>14</b> ►/   Page 19</p> <p><b>15</b> ■ Page 19</p> <p><b>16</b> CD MODE Page 29</p> <p><b>17</b> TV/AUX (/DIGITAL IN) Pages 22, 34</p> <p><b>18</b> TUNER/BAND Pages 21-22</p> <p><b>19</b> DVD/CD Pages 19, 34</p> <p><b>20</b> STANDBY/ON Page 19</p> |
|---|---|

## Display

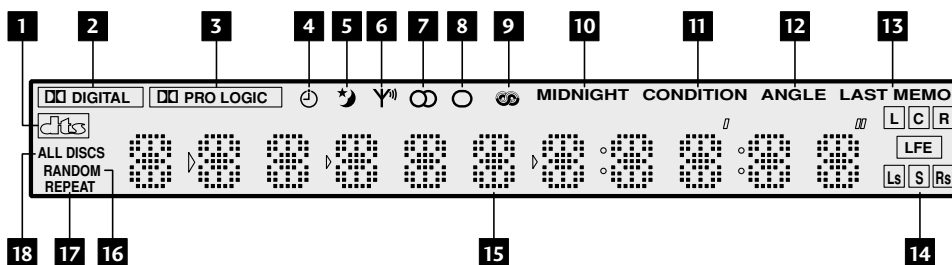

- |  |  |
|--|--|
| <p><b>1</b> DTS pages 23, 46</p> <p><b>2</b> DIGITAL pages 23, 46</p> <p><b>3</b> PRO LOGIC page 23</p> <p><b>4</b> ⏰ Timer indicator page 34</p> <p><b>5</b> 🌙 Sleep indicator page 35</p> <p><b>6</b> 📶 Tuned indicator page 21-22</p> <p><b>7</b> FM stereo indicator page 22</p> <p><b>8</b> FM mono indicator page 22</p> <p><b>9</b> RDS (European model only) Lights when in one of the RDS display or search modes</p> <p><b>10</b> MIDNIGHT page 25</p> | <p><b>11</b> CONDITION page 30</p> <p><b>12</b> ANGLE page 26</p> <p><b>13</b> LAST MEMO page 29</p> <p><b>14</b> Channel indicators Show which channels are available on the current disc.</p> <p><b>15</b> Character display When playing discs : Left to right displays disc number, title, chapter/track, minutes, seconds.</p> <p><b>16</b> RANDOM page 28</p> <p><b>17</b> REPEAT page 28</p> <p><b>18</b> DISC   ALL DISCS Indicates the random or repeat mode ; page 28-29</p> |
|--|--|

## Switching on and setting the clock

This system has a built-in clock, which needs to be set to be able to use the timer features.

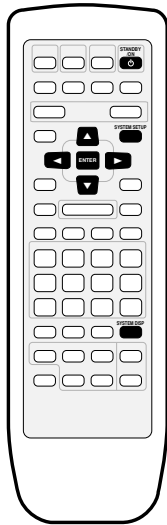

- 1 Press **⏻** to switch on.
- 2 Press **SYSTEM SETUP**.
- 3 Press the **◀** or **▶** button until you see **TIMER** in the display.
- 4 Press **ENTER**.
- 5 Press **◀** or **▶** until you see **CLOCK ADJ** in the display.
- 6 Press **ENTER**.  
The display shows a clock, with the hour blinking.
- 7 Use the **▲** and **▼** buttons to set the hour, then press **ENTER**.
- 8 Use the **▲** and **▼** buttons to set the minute, then press **ENTER**.  
The display blinks to indicate that the time has been set.



### Tip

- Press **SYSTEM DISP** anytime to see the clock when the system is on or in standby.

## Setting up for surround sound

You can use this system right out of the box for surround sound with just the default settings. However, for really great surround sound, we recommend that you spend a few minutes making some settings that match this system to your listening room. Unless you change the layout of your speakers or main listening position, you only need to make most of these settings once.

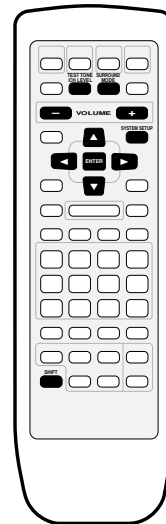

## Setting the speaker distances

- 1 Press **SYSTEM SETUP**.
- 2 Press the **◀** or **▶** button until you see **FRT. SP** in the display.
- 3 Use the **▲** and **▼** buttons to set the distance from your main listening position to the front speakers.  
Ideally, your listening position should be equidistant from the two front speakers.  
The default setting is 3m. You can adjust the range from 0.3m to 9.0m in steps of 0.3m.



**4 Press ► to move on to the CENTER speaker setting.**

**5 Use the ▲ and ▼ buttons to set the distance from your main listening position to the center speaker.**

The default setting is 3m. You can adjust the range from 0.3m to 9.0m in steps of 0.3m.

**6 Press ► to move on to the SURROUND speakers setting.**

**7 Use the ▲ and ▼ buttons to set the distance from your main listening position to the surround speakers.**

Ideally, your listening position should be equidistant from the surround speakers.

The default setting is 3m. You can adjust the range from 0.3m to 9.0m in steps of 0.3m.

**8 Press ENTER to exit.**

- The setting mode is automatically exited if no operation is performed within 20 seconds.
- There are several other settings that you can make from the System Setup menu to further tailor your surround sound. See chapter 9 for more on this.
- The speaker distance settings have no effect when the surround mode is set to **VIR.SURR.1** or **VIR.SURR.2**. See page 23 for more on surround modes.



#### Note

You can't make these settings with the Record mode on. See page 25 for how to switch the Record mode on/off.

### Balancing the surround sound

You can further improve surround sound performance by balancing the levels from the subwoofer, center and surround speakers relative to the front left/right speakers. To help you judge the sound level of each speaker a test tone is played through each speaker in turn (make sure that there are no headphones connected). Adjust the levels until they all sound equal. The levels you set here will apply to all surround modes. However, you can set levels independently for each DSP mode.



#### Note

It may not be possible to accurately adjust the subwoofer level using this method. You may prefer to leave it on its default setting and adjust it to your liking later when playing surround-sound sources.

- You cannot change the DSP mode when Record mode is active (see *Direct recording* on page 25).

**1 Press SURROUND MODE.**

The surround mode can be set to anything except **SURROUND OFF** or **AUTO** (No test tone is output in these modes.)

**2 Set the volume to a moderate level.**

**3 Press TEST TONE (SHIFT & CH LEVEL) to start the test tone then adjust the volume to a suitable level.**

The test tone plays through each speaker in turn:

- Front left
- Center
- Front right
- Surround right
- Surround left
- Subwoofer

**4 Use the ▲ and ▼ buttons to adjust the level of a speaker as the test tone plays.**

For best results, sit in your main listening position when doing this. You can adjust each speaker in the range of +/-10dB.

**5 When you're done, press TEST TONE (SHIFT & CH LEVEL) to turn off the test tone.**

## Using the Setup Navigator

Before playing any discs, we strongly recommend using the Setup Navigator. This makes all the basic DVD system settings for you.

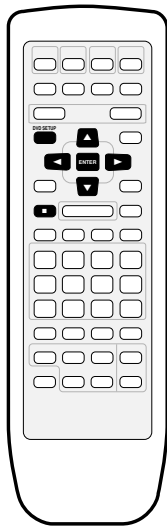

### 1 Make sure that the system is switched on.

Also turn on your TV and make sure that it is set to the correct video input.

- If a disc that's already loaded starts to play, press **■** to stop it.

### 2 Press DVD SETUP.

The Setup Navigator on-screen display (OSD) appears:

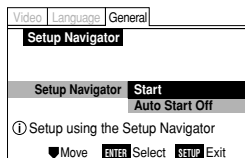

Navigate all of the following OSDs using these controls:

**▲**, **▼** – cursor up/down

**ENTER** – select the highlighted menu option

**◀** – go back to the previous question

The control possibilities for the current OSD are shown at the bottom of each screen.

### 3 Select START.

- If you decide not to use the Setup Navigator, select **Auto Start Off** here instead.

### 4 Choose an OSD menu language.

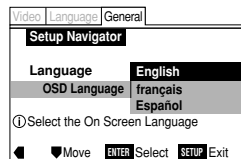

#### Note

- The language options shown in the on-screen display illustrations on the following pages may not correspond to those available in your country or region.

### 5 Select the type of TV you have.

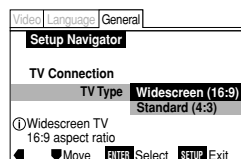

- See *Aspect ratio* in the glossary on page 46 if you're unsure of the difference between widescreen and standard TVs.

### 6 Select Save Changes to make the settings.

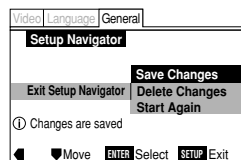

### 7 Press DVD SETUP to exit.

Congratulations, set up is complete!

If you want to use the Setup Navigator again at any time, it is available from the **General** menu. Also, each individual setting can be changed using the appropriate menu option—chapter 11 explains all menu options in detail.

## Playing DVDs, CDs and Video CDs

The basic controls for playing discs are covered here. Further functions are detailed in the chapter 7.

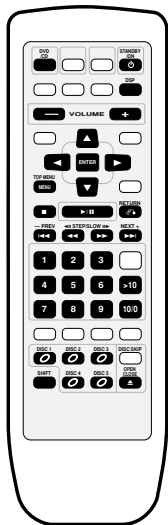

- 1 Press **STANDBY/ON** to turn on the player.
- 2 Press **DVD/CD**.
- 3 Press **OPEN/CLOSE** to open the disc tray.
- 4 Load a disc.

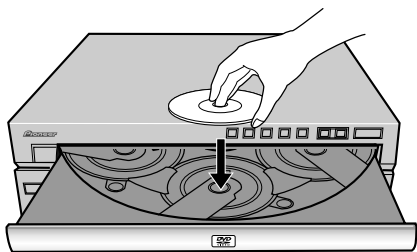

Load a disc with the label side facing up, using the disc tray guide to align the disc (if you're loading a double-sided DVD disc, load it with the side you want to play face down).

If you want to load more discs, press **DISC SKIP** to rotate the disc tray. You can load up to five discs at once.

- Do not place discs in the two partially accessible disc spaces, as it's easy to misalign them. Use only the front-most space.
- When using the **DISC SKIP** button, wait until the disc tray has come to a complete stop before loading a disc; the player may malfunction if a disc is caught in the disc tray mechanism.
- Do not rotate the disc tray by hand. Always use the **DISC SKIP** button.

### 5 Press to start playback of the disc just loaded.

- If you're playing a DVD or Video CD, a menu may appear. See page 20 for how to navigate these.

## Basic playback controls

Button	What it does
	Starts playback or pauses a disc that's playing (press again to restart playback). DVD and Video CD only: Resumes playback of a stopped disc.
	Stops playback. DVD and Video CD only: Display shows resume (press  to start playback again from the last place stopped).
	Press & hold for fast reverse scanning. (After 5 seconds, scanning continues even after releasing the button: press  to resume normal playback.) On the front panel use:
	Press & hold for fast forward scanning. (After 5 seconds, scanning continues even after releasing the button: press  to resume normal playback.) On the front panel use:
	Skips to the start of the current track or chapter, then to previous tracks/chapters. On the front panel use:
	Skips to the next track or chapter. On the front panel use:

**Numbers** If the disc is stopped, playback starts from the selected track or title number. If the disc is playing, playback jumps to the start of the selected track or chapter number.

**>10** Selects tracks/titles/chapters 11 and over. (For example, for 24, press >10 , 2, 4.)

**DISC 1-5** Starts playing the selected disc. (On the front panel use: 1-5)

### DVD and Video CD only:



**II▶ (SHIFT ▶▶)** During playback, press and hold to start slow-motion forward scanning. Change the speed using the ◀II and II▶ buttons. During playback, press once to pause; advance a single frame with each subsequent press.

### DVD only:

**◀II (SHIFT ◀◀)** During playback, press and hold to start slow-motion reverse scanning. During playback, press once to pause; reverse a single frame with each subsequent press.



### Important

While using the DVD playback controls, you may see the  or  mark displayed on-screen.

 means that the operation is not allowed by the system.

 means that the operation is not allowed by the disc.

## Navigating DVD disc menus

Some DVD discs contain menus. Sometimes these are displayed automatically when you start playback; others only appear when you press menu or top menu.

Button	What it does
<b>TOP MENU (SHIFT MENU)</b>	Displays the 'top menu' of a DVD disc—this varies with the disc.
<b>MENU</b>	Displays a DVD disc menu—this varies with the disc and may be the same as the 'top menu'.
<b>RETURN</b>	Returns to the previously displayed menu screen.
<b>◀▶ ▲ ▼</b>	Moves the cursor around the screen
<b>ENTER</b>	Selects the current menu option
<b>Numbers</b>	Selects a numbered menu option (some discs only)

## Navigating Video CD PBC menus

Some Video CDs have menus from which you can choose what you want to watch. These are called PBC (Playback control) menus, and are displayed automatically when you start playback.

You can switch PBC off by starting playback using a number button to select a track, rather than the ▶/II button.

Button	What it does
<b>RETURN</b>	Displays the PBC menu.
<b>Numbers</b>	Selects a numbered menu option.
<b>◀◀</b>	Displays the previous menu page (if there is one).
<b>▶▶</b>	Displays the next menu page (if there is one).
<b>▶/II</b>	Press to select an item from a PBC menu.

## Exchanging discs

You can change any of the discs not in the play position using the **EXCHANGE** button. Because the disc in the play position is unaffected, you can use this button to change discs even during playback.

- 1 Press **EXCHANGE** to open the disc tray without interrupting playback.
- 2 Load a disc.

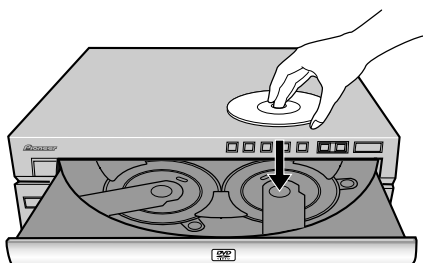

You can load two discs at a time in the two fully accessible disc spaces. Do not try and load discs into any of the other spaces; they may not load correctly and cause the unit to malfunction.

- 3 If you want to load more discs, press **DISC SKIP** to rotate the disc tray.
- 4 Press **▲ OPEN/CLOSE** or **EXCHANGE** to close the disc tray.
  - Do not push the disc tray shut by hand after exchanging discs.

## Listening to the radio

The following steps show you how to tune in to FM and AM radio broadcasts using the automatic (search) and manual (step) tuning functions. Once you are tuned to a station you can memorize the frequency for recall later—see *Saving station presets* on page 22 for more on how to do this.

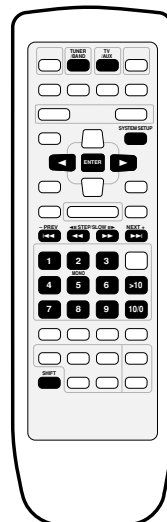

- 1 Press **TUNER/BAND** to select the tuner. On the remote, press repeatedly to switch between FM and AM bands. On the front panel, the **TUNER/BAND** button switches between FM, AM and preset station mode. For now, choose either FM or AM.
- 2 **Tune to a station.** There are three ways to do this:
  - **Automatic tuning** To search for stations in the currently selected band, press and hold either the **◀◀** or **▶▶** button for about a second. The system will start searching for the next station, stopping when it has found one. Repeat this step to search for other stations. Every time searching stops on a station, the **Y**<sup>0</sup> (tuned) indicator lights in the display.

- **Manual tuning**

To change the frequency one step at a time, press the ◀◀ / ▶▶ buttons. When you locate a station signal, the **Y**<sup>(tuned)</sup> indicator lights in the display.

- **High-speed tuning**

Press and hold the ◀◀ or ▶▶ button for high speed tuning, releasing the button once you reach the frequency you want. When you stop on a station signal, the **Y**<sup>(tuned)</sup> indicator lights in the display.

### Improving FM stereo sound

If you're listening to a stereo FM broadcast, but find that there is a lot of noise because of a weak signal, try switching to mono.

- **Press MONO (SHIFT & 5) to switch between mono and stereo.**

When listening in mono, the **O** indicator lights in the display.

### Saving station presets

If you often listen to a particular radio station, it's convenient to have the receiver store the frequency for easy recall whenever you want to listen to that station. This saves the effort of manually tuning in each time. This system can save up to 30 station presets. When saving FM frequencies, the receiver also saves the mono setting (see *Improving FM stereo sound* above).

- 1 Tune to a station you want to memorize.**  
See *Listening to the radio* on page 21 for more on how to do this.
- 2 Press SYSTEM SETUP.**
- 3 Press ◀ or ▶ until you see ST. MEMORY appear in the display.**
- 4 Press ENTER.**

- 5 Press ◀ or ▶ to select a station preset number.**

Alternatively, use the number buttons (use the >10 button for numbers over 10).

If you use the number buttons, you can skip step 6.

- 6 Press ENTER again to save the station preset.**

Repeat these steps to save up to 30 station presets.

### Listening to station presets

Having saved up to 30 station presets, you can be listening to a station with a couple of button presses.

- 1 Press TUNER/BAND to switch to the tuner.**

If you're using the front panel controls, press **TUNER/BAND** repeatedly to select the preset station mode.

- 2 Use ◀◀ or ▶▶ to select the station preset you want to listen to.**

Alternatively, use the number buttons (use the >10 button for numbers over 10).

- If the system is left disconnected from the AC power outlet for a lengthy period, the station presets will be lost and will have to be reprogrammed.

### Listening to other components

You may have connected your TV, VCR, or other components to play through this system. Use the **TV/AUX** button to select your external equipment as the source.

- 1 Press TV/AUX.**

Press repeatedly to switch between:

- **TV** inputs
- **DIGITAL** input
- **AUX** analog inputs

- 2 Start playing the source component.**

## Adjusting the bass and treble

The simplest way to shape the sound is by adjusting the amount of bass and treble.



### Note

- The bass and treble controls have no effect when using the DSP modes, or when the surround mode is set to anything other than **STANDARD**, **AUTO** or **SURR. OFF** (surround off).
- You cannot adjust the bass or treble when Record mode is active (see *Direct recording* on page 25).

- 1 Press **SOUND**.
- 2 Use the ◀ or ▶ buttons to select **BASS** or **TREBLE**.
- 3 Use the ▲ and ▼ buttons to adjust the sound.  
You can see the current level in the display.
- 4 Press **ENTER**.

## Using P.Bass

In addition to the standard controls for adjusting bass and treble, this system has a P.Bass feature. Switch this on to further extend the bass.



### Note

- P.Bass has no effect when listening through headphones.
- You cannot adjust P.Bass when Record mode is active (see *Direct recording* on page 25).

- 1 Press **SOUND**.
- 2 Use the ◀ or ▶ buttons to select **P.BASS**.
- 3 Use the ▲ and ▼ buttons to switch on or off.
- 4 Press **ENTER**.

## Using sound modes

The sound modes allow you to add various surround and room-type sound effects to your DVDs, CDs and other sources. These effects process the sound in various ways to simulate different spaces such as a theater, or concert hall.

For Dolby Surround, Dolby Digital or DTS surround sources, such as DVDs, use the Advanced Theater effects to add room ambience to the sound; for stereo-only sources, such as audio CDs, use the DSP modes.

For each effect you can also adjust how strong the effect sounds. Often, a more subtle effect level enhances the sound better than turning it right up. Experiment to see what works best for you.

## Listening to surround-sound sources

When you play DVD discs with Dolby Digital or DTS sound, choose from the following sound settings.

- **Auto** – For digital sources, decoding is automatically selected according to the source: Dolby Digital, DTS, Dolby Pro Logic, 2-channel stereo, etc. No extra effects are added to the source. Analog sources are played in the same way as the Surround Off setting.
- **Standard** – As Auto, except that 2-channel (analog or digital) sources are processed using Dolby Pro Logic for surround-sound effects.

The following six settings are Advanced Theater effects.

- **Musical** – Concert hall sound.
- **Drama** – Classic, mid-size movie theater sound.
- **Action** – Large, modern movie theater sound.
- **Virtual Surround 1 (VIR.SURR.1)** – Virtual surround sound from just the main front stereo speakers and a subwoofer. Use this mode if you can't use the surround speakers.
- **Virtual Surround 2 (VIR.SURR.2)** – Virtual surround sound if you have connected the surround speakers, but are using them in front of the listening position.
- **Rear Wide** – Widens the rear channel soundstage.

- **Surround Off (SUR.OFF)** – All sources are played through only the front left and right speakers, and the subwoofer. No effects are added.



### Note

- The surround modes cannot be used in combination with DSP effects or with 96kHz digital sources.
- You cannot change the surround mode when Record mode is active (see *Direct recording* on the following page).

## 1 Press SURROUND MODE.

Each press changes the surround mode as follows:

- **AUTO**
- **STANDARD** (surround on, with no Advanced Theater effect)
- **MUSICAL**
- **DRAMA**
- **ACTION**
- **VIR.SURR.1**
- **VIR.SURR.2**
- **REAR WIDE**
- **SUR.OFF** (surround off)

## Listening to other sources with room effects

You can add room effects to audio CDs and other stereo sources using the DSP modes. Different effects work better with different kinds of music, so don't be afraid to experiment a little.

There are seven DSP effects to choose from:

- **Hall 1** – Large, wood-paneled concert hall sound.
- **Hall 2** – Large, stone-walled concert hall sound.
- **Jazz** – Live jazz club sound.
- **Dance** – Nightclub sound.
- **Theater 1** – Classic, mid-size movie theater sound.
- **Theater 2** – Large, modern movie theater sound.
- **Simulated Stereo** – Virtual stereo for mono sources.



### Note

- The DSP effects cannot be used in combination with the surround modes or with 96kHz digital sources.
- When playing stereo sources with DSP effects switched off, there is no sound from the surround and center speakers.
- You cannot change the DSP mode when Record mode is active (see *Direct recording* on the following page).

## 1 Press DSP to select a sound mode.

Each press changes the mode as follows:

- **HALL 1**
- **HALL 2**
- **JAZZ**
- **DANCE**
- **THEATER 1**
- **THEATER 2**
- **SIMULATED STEREO**
- **DSP OFF** (no effects added)

## Adjusting the effect level

You can adjust the effect level when using one of the DSP effects or Advanced Theater effects. It is not possible to change the effect level of the **AUTO** or **STANDARD** surround mode (or when DSP or Surround modes are off).



### Note

- You cannot change the effect level when Record mode is active (see *Direct recording* on the following page).

## 1 Press SOUND.

## 2 Use the ◀ or ▶ buttons to select EFFECT.

## 3 Use the ▲ and ▼ buttons to adjust the effect level.

You can adjust the effect level in the range of 10 to 90.

## 4 Press ENTER.



### Listening at low volume

When the volume is low, surround effects tend to become less than satisfactory. Turn the Midnight listening mode on to enjoy quality surround sound even at low volumes.

- 1 Press **SOUND**.
- 2 Use the ◀ or ▶ buttons to select **M.NIGHT**.
- 3 Use the ▲ and ▼ buttons to turn **ON** or **OFF**.
- 4 Press **ENTER**.



#### Note

- You cannot change the Midnight mode when Record mode is active (see *Direct recording* right).

### Direct recording

This feature let's you record directly to an external recorder, without worrying about the various sound settings. The bass, treble, surround, DSP and Midnight settings are all bypassed so that the recording is direct-from-source.





#### Note

- When the Record Mode is on you cannot change or adjust the bass, treble, surround and DSP mode settings or the Midnight setting.
- Once the power is switched off or the function is changed, the Record mode automatically reverts to off.
- The LFE channel is not recorded.

- 1 Press **SOUND**.
- 2 Use the ◀ or ▶ buttons to select **RECORD MODE**.
- 3 Press **ENTER**.  
The display shows **RECMODE ON**.
- 4 Press **ENTER** again.  
The Record Mode is now active.
  - To switch off the Record Mode, repeat the same procedure. In step 3 above the display shows **RECMODE OFF**.

## Introduction

- Most of the functions covered in this chapter apply to DVD discs, Video CDs and CDs, although the exact operation of some varies slightly with the kind of disc loaded.
- When playing DVD discs, if the  or  icon appears on-screen when you try and use a particular function, either the player or the disc doesn't allow the use of that function.
- When playing Video CDs, some of the functions are not available in PBC mode. You can switch PBC off by starting playback using a number button to select a track, rather than the **▶/||** button.

## Finding what you want on a disc

**DVD** **Video CD** **CD**

You can directly access any point on a disc using one of the search modes. Use these search modes while a disc is playing, or when it's stopped—playback immediately starts from the point specified.

### 1 Press **SEARCH (SHIFT & 3)** (remote only) to choose between:

- Title search (DVD only)
- Chapter/Track search
- Time search (DVD and Video CD only)
- Off

### 2 Enter the title/chapter/track number or time (minutes & seconds).



For example, for title 4, press **4**.

For chapter/track 12, press **1** , **2**.

For 45 minutes into the disc, press **4** , **5** , **0** , **0**.

### 3 Press **▶/||** to start/restart playback.

## Switching camera angles **DVD**

Some DVD discs feature scenes shot from two or more angles—check the disc box for details: it should be marked with a  icon if it contains multi-angle scenes. When these scenes are playing, a camera icon () appears on-screen.

### • To switch the camera angle, press **ANGLE (SHIFT & 4)**.

- To hide the TV angle indicator, choose **Angle Indicator > Off** from the **Video** menu (see page 39).

## Switching subtitles **DVD**

Many DVD discs have subtitles in one or more languages—the disc box will usually tell you which subtitle languages are available. You can switch subtitle language anytime during playback.

- To display/switch the subtitle language, press **SUBTITLE** repeatedly.
- To switch off subtitles, press **SUBTITLE** then **CLEAR**.
  - To set subtitle preferences, see pages 40, 41.

## Switching audio language **DVD**

When playing a DVD disc recorded with dialog in two or more languages, you can switch audio language anytime during playback.

- To display the current audio language, press **AUDIO**.
- To switch the audio language, press **AUDIO** repeatedly.
  - To set audio language preferences, see page 40.

## Switching audio channel

**Video CD** **CD**

When playing a CD or Video CD, you can switch between the stereo soundtrack, just the left channel, or just the right.

- To switch the audio channel, press **AUDIO** repeatedly.

## Making a program list

DVD Video CD CD

Making a program list means telling the player which tracks, and in what order, you want played. You can program a sequence of up to 24 tracks/chapters to play from any of the discs loaded in the disc changer. The discs can be any combination of DVD, Video CD and audio CD. Chapters/tracks can appear more than once in the playlist, or can be left out entirely.

### 1 Press PROGRAM (SHIFT & 7).

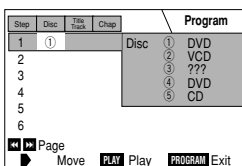

The program screen appears showing the first six steps in the playlist. Navigate around this screen using the cursor buttons. Jump to the next six steps using the ►►► button; to the previous six steps using the ◀◀◀ button.

### 2 Enter a disc number (1 to 5).

You can use either the **DISC1-5** buttons, or the number buttons.

- If this is the first step you're programming, the number of the disc that is currently in the play position will appear automatically.
- If the unit has already read the contents of the disc you want to program, the disc details appear in the box on the right of the screen (type of disc, number of titles/chapters/tracks, etc.). If the unit hasn't yet read the disc then '???' appears in the box for disc type.
- If you want to put the whole disc into the program list, jump to step 5 below.

### 3 Move the cursor to the TITLE/TRACK field and enter a title or track number.

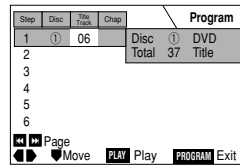

For DVDs, this number will be a disc title; for Video CDs and audio CDs, a track number.

For example, to enter title/track 6, press **6**. To enter title/track 14, press **1, 4**.

- To clear an entry, press **CLEAR**.
- DVD only: If you want to put the whole title into the program list, jump to step 5 below.

### 4 If the current disc is a DVD, move the cursor to the CHAPTER field and enter a chapter number.

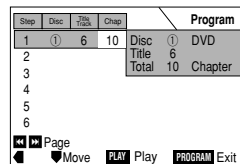

### 5 Press ENTER.

The cursor moves down to the disc number field in the next step.

### 6 Repeat steps 2-5 to add more items to the program list.

### 7 Press ►/|| to start the program list playing.



#### Tip

- To edit any item in the program list, position the cursor on the item you want to change, then enter a new value using the number buttons.
- To delete a whole step, position the cursor anywhere on the step you want to delete and press **CLEAR**.

**Note**

- The playlist remains active even if you open the disc tray and change discs. If a step in the program list cannot be played (because the track number is too high, for example), that step is automatically skipped.
- To delete the playlist, stop playback, then press **CLEAR**.
- You may see an asterisk (\*) appear on-screen when program play of some DVD discs starts. The asterisk means that the part of the disc being played is not in the playlist, but has to be played whenever the disc is first loaded in to the play position. The asterisk will disappear once the programmed chapters start playing.

**More programming options**

There are several other options available when making/using program lists.

- **To view the playlist, press PROGRAM (SHIFT & 7).**
- **To delete an entry from the playlist, position the cursor on the title/chapter/track number and press CLEAR.**
- **To add an entry to the end of the playlist, press PROGRAM (SHIFT & 7), enter the title/chapter/track number, then press program again.**
- **To delete the playlist, exit the program list screen, stop playback, then press CLEAR.**

**Using random play**

Use the random play function to play titles/chapters/tracks in a random order.

How random play works depends on the disc currently in the play position. If the 'current' disc is a DVD, you can play either the titles or chapters on that disc at random. If the 'current' disc is an audio or Video CD, you can play either the tracks on that disc, or all the tracks on all the CDs and Video CDs loaded at random (DVD discs loaded will be ignored).

**1 Press RANDOM (SHIFT & 8) repeatedly to select a random play mode.**

The mode is displayed on-screen and in the front panel display:

**DVD**

- **Random Chapter** (from within the current title)
- **Random Title**

**Video CD** **CD**

- **Random 1 Disc**
- **Random All Discs**

**2 Press ENTER or ►/II to start random play.**

- To stop the disc and cancel random playback, press ■.
- To cancel random playback without stopping playback, press **CLEAR**. The rest of the disc plays out.

**Tip**

During random play, the ◀◀ and ▶▶ buttons function a little differently to normal: ◀◀ returns to the beginning of the current track/chapter. You can't go back further than this. ▶▶ selects another track/chapter at random from those remaining.

**Using repeat play**

You can set the player to repeat individual tracks on CDs or Video-CDs, chapters or titles on DVD discs, a whole disc, or all the discs loaded in the player. It's also possible to loop a section of a disc.

You can use the repeat together with the programming mode to repeat the tracks/chapters in the playlist (see page 27 for how to program a playlist).

**1 Press REPEAT (SHIFT & 9) during playback to select a repeat mode.**

Each press switches the repeat mode:

**DVD**

- **Chapter Repeat**
- **Title Repeat**
- **Repeat Off**

Video CD CD

- **Track Repeat**
- **1 Disc Repeat**
- **All Discs Repeat**
- **Repeat off**

• The **Repeat All** function repeats all tracks on all audio and Video CDs loaded. If, during repeat play, the unit encounters a DVD disc, it will start playing, but the repeat mode will be canceled.

## 2 To resume normal playback, press CLEAR.



**Tip**

You can use repeat play with program play and random play. During program/random play, press **REPEAT (SHIFT & 9)**.

### Looping a section of a disc

- **Press REP A-B (SHIFT & 10/0) once at the start of the section you want to repeat, then again at the end.**

Playback immediately jumps back to the start point and plays the loop repeatedly.

- On a DVD disc, the start and end points of the loop must be in the same title.
- To resume normal playback, press **CLEAR**.

- **To repeat a section of a disc just once, press REP A-B (SHIFT & 10/0) at the start of the section, then ►/II at the end.** Playback jumps back to the start point.

### Playing CDs only (CD Mode) CD

Using this feature you can play only the CDs loaded in the disc tray—automatically skipping over any DVDs or Video CDs loaded. This may be useful if you have a mixture of discs loaded but only want to play music: you don't have to keep track of what kind of disc is where in the disc tray.

## 1 Press CD MODE.

The CD Mode indicator lights.

- To switch off, press **CD MODE** again.

## 2 Press ►/II.

The player automatically starts playing the first CD loaded. Once all the CDs loaded have played, the player automatically stops.



**Tip**

- In CD Mode, use the **DISC SKIP** button to rotate the disc tray to the next CD loaded (if there is one).
- You can use repeat and random play in CD Mode (see page 28 and this page).



**Note**

- You can't switch on CD mode while playing a DVD or Video CD. Stop playback first.
- Program play is not possible in CD Mode. However, it is possible to program a playlist. When you start program play, CD Mode is canceled (see page 27).

### Bookmarking a place in a disc

DVD Video CD

If you watch only part of a DVD disc with the intention of picking up later where you left off, you can bookmark the place then resume playback at a later date without having to manually search for the right place.

You can use this feature for up to five discs (after that the oldest bookmark is deleted to make space for a new one).

- **At the point from which you want to resume playback next time, press LAST MEMO (SHIFT & 2).**

Press ■ if you want to stop playback here.

- **To resume playback, load the disc and press LAST MEMO (SHIFT & 2).**

If the disc starts auto playback, stop it first.

- To clear the bookmark for the disc loaded, press **LAST MEMO (SHIFT & 2)** then **CLEAR** while Last Memory is displayed on-screen.



**Note**

- Bookmarking also works with Video CD, but for one disc only, and you must leave the disc in the player—opening the disc tray erases the memory. Last Memory may not work reliably with some PBC Video CDs.

## Memorizing disc settings

DVD

If you have a particular set of preferences for a disc, you can memorize them using the Condition Memory function. Once memorized, your settings will be recalled automatically whenever you load that disc. The player can store settings for 15 discs; after this, memorizing another replaces the oldest one stored.

The settings memorized are:

- **OSD Position** (page 39)
- **Subtitle Language** (page 40)
- **Audio Language** (page 40)
- **Angle Indicator** (page 39)
- **Parental Lock level** (page 42)
- **To memorize settings for the current disc, press CONDITION (SHIFT & 1) during playback.**

- **To recall memorized settings, just load the disc.**

The display shows **CONDITION** and **Condition Memory** appears on-screen.

- To clear memorized settings, load the disc and press **CLEAR** while **Condition Memory** is displayed on-screen.

## Displaying disc information

DVD

Video CD

CD

Various track, chapter and title information, as well as the video transmission rate for DVD discs, can be displayed on-screen while a disc is playing, or while it's stopped.

- **To show/switch the information displayed, press DVD DISP (SHIFT & CLEAR).**
  - When a disc is playing, the information appears at the top of the screen. Keep pressing **DVD DISP (SHIFT & CLEAR)** to change the displayed information.

Play ① :37—1 0.38  
Tr. Rate :■■■■■■■■■■ 7.2

DVD data transmission rate display

- When a disc is stopped, all title/chapter, or track information for the disc loaded appears on-screen. Press **DVD DISP (SHIFT & CLEAR)** again to exit the screen.

Information: DVD

Title	Chapter	Title	Chapter
01	1~ 30	06	1~ 10
02	1~ 21	07	1~ 13
03	1~ 46	08	1~ 5
04	1~ 12	09	1~ 4
05	1~ 8		

1/1 DISPLAY Exit

DVD-Video

Information: Compact Disc

Track	Time	Total Time
01	3.32	6.30
02	2.58	

1/1 DISPLAY Exit

CD/Video CD

- To display the time remaining on a DVD disc, press and hold **DVD DISP (SHIFT & CLEAR)**.

The display shows the disc time remaining for as long as you hold the button. Release the button to revert to the previous display.

## Singing karaoke (Except European model)

Using the karaoke features you can plug in a microphone and mix the sound of your own voice with a backing track. The backing track can be anything you like, from a song on the radio, to a dedicated DVD karaoke disc that displays the lyrics on screen as the music plays. Tailor the mix by adjusting the microphone level relative to the backing track.

### 1 Set MIC LEVEL to minimum.

### 2 Plug in the microphone.

The mic jack is located on the front panel.

- If the microphone has an on/off switch, make sure it's on.

### 3 Load a karaoke backing disc.

You can also use the radio or a component connected to the auxiliary inputs as source material for a backing track.

### 4 To change the mix (CD or VCD only), press AUDIO.

Pressing repeatedly switches between these modes:

- **STEREO** – Use for backing tracks with no vocals.
- **L CH** – Left channel only. Use for tracks that have a vocal recorded in the right channel.
- **R CH** – Right channel only. Use for tracks that have a vocal recorded in the left channel.

### 5 Play the backing track.

### 6 Adjust the MIC LEVEL to get the sound you want.

If when you turn the **MIC LEVEL** up, you get a loud whistling from the speakers, move the microphone so that it points away from the speakers.

### 7 Sing!

**Note:** Depending on the microphone level, the sound of the disc may distort. If this happens, turn down the volume.

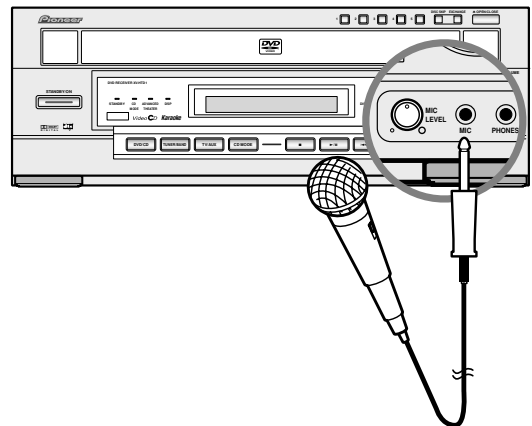

## Using RDS

Radio Data System, or RDS as it's usually known, is a system used by FM radio stations to provide listeners with various information—the name of the station and what kind of show they're broadcasting, for example. RDS allows you to search through stations automatically using this information. It shows up as text on the display, and you can switch between the type of information shown. Although you don't get RDS information from all FM radio stations, you do with most.

This unit lets you display three different kinds of RDS information: Radio Text, Program Service Name, and Program Type.

Radio Text (RT) is a message sent by the radio station. It can be anything the broadcaster chooses—a talk radio station might give out its telephone number as RT, for example.

Program Service Name (PS) is the name of the radio station.

Program Type (PTY) indicates the kind of program currently being broadcast.

## RDS Program types

<b>News</b>	News
<b>Affairs</b>	Current affairs
<b>Info</b>	General information
<b>Sport</b>	Sports
<b>Educate</b>	Educational material
<b>Drama</b>	Radio drama
<b>Culture</b>	Arts and culture
<b>Science</b>	Science and technology
<b>Varied</b>	Usually talk-based material, such as quiz shows or interviews.
<b>Pop M</b>	Pop music
<b>Rock M</b>	Rock music
<b>M.O.R. M</b>	"Middle of the road" music
<b>Light M</b>	'Light' classical music
<b>Classics</b>	'Serious' classical music
<b>Other M</b>	Other music not fitting any of the above categories
<b>Weather</b>	Weather reports
<b>Finance</b>	Finance and business
<b>Children</b>	Children's' entertainment
<b>Social</b>	Social affairs
<b>Religion</b>	Religious programming
<b>Phone in</b>	Phone in talk show
<b>Travel</b>	Holiday-type travel rather than traffic announcements, etc.
<b>Leisure</b>	Leisure interests and hobbies
<b>Jazz</b>	Jazz music
<b>Country</b>	Country music
<b>Nation M</b>	Popular music in a language other than English
<b>Oldies</b>	Popular music from the '50s
<b>Folk M</b>	Folk music
<b>Document</b>	Documentaries

In addition, there are program types, **ALARM** and **TEST**, used for exceptional emergency announcements. The tuner will switch automatically to that station if it picks up either of these RDS signals.



## Displaying RDS information

You can choose to display Program Service name (PS), Program Type (PTY), or Radio Text (RT) for the FM station you're listening to.

### 1 Press **SYSTEM DISP** repeatedly to select the RDS information you want to display.

Switch between:

- **PS** (Program Service name)
- **PTY** (Program Type)
- **RT** (Radio Text)
- **SEARCH** (see below for more on this)
- **OFF** (don't display any RDS data)

The RDS information will appear after a few seconds.



#### Note

- The RDS indicator will light in the RDS mode.
- If no RDS signal can be received, the no data message will be displayed.
- If there is noise during the RT scroll display when in the RT mode, some characters may be temporarily displayed incorrectly.
- In the RT mode, when no RT data is transmitted, no radio text data is displayed.
- During RDS broadcast reception in the PTY mode, no type data may be displayed. In this case, it will automatically switch to PS mode after a few seconds.

## Searching for a program type

You can search for a station that is broadcasting any program type from the list on page 32.

### 1 Select FM with the **TUNER/BAND** button.

### 2 Press **SYSTEM DISP** repeatedly until **SEARCH** appears in the display.

### 3 Use **◀◀** and **▶▶** to choose the program type, then press **SYSTEM DISP**.

You can search for any of the program types listed on page 32.

After pressing **DISP/RDS**, the system starts searching through the station presets for a match. When it finds one, the search stops and the station plays for 6 seconds.

### 4 If you want to keep listening to the station, press **SYSTEM DISP** within the 6 seconds.

If you don't press **SYSTEM DISP**, searching resumes.

## Using the wake up timer

You can use the timer as an alarm clock to wake up to the sound of a disc loaded or the radio. If you have an external component operated by a separate timer, you can also set it as the source function.

Once the timer is active, it will switch the system on everyday at the set time.

Unlike an ordinary alarm clock, you need to set a system switch off time, as well as a switch on time.

### 1 Select the source that you'd like to wake up to.

For a disc, press **DVD/CD**; for the radio press **TUNER/BAND**; for an external component, press **TV/AUX**.

### 2 Load a disc or tune to a radio station, then set the volume.

If you selected an external component, make the appropriate timer settings for it.

### 3 Press **SYSTEM SETUP**.

### 4 Press **◀** or **▶** until you see **TIMER** in the display.

### 5 Press **ENTER**.

### 6 Press **◀** or **▶** until you see **WAKE UP SET** in the display.

### 7 Press **ENTER**.

The display shows a switch on time with the hour blinking.

### 8 Set the switch on time.

Use **▲** and **▼** to set the hour then press **ENTER**. Set the minute in the same way, pressing **ENTER** to finish.

- If you make a mistake, press **SYSTEM SETUP** and start again from step 3.

### 9 Set the switch off time.

Set in the same way as the switch on time, pressing **ENTER** to finish.

- If you make a mistake, press **SYSTEM SETUP** and start again from step 3.

### 10 Check the settings you just made.

The display should indicate that you have set the wake up timer, then show the on time, the off time, the function (DVD, etc.), and the volume. The display shows **CHECK END** after all the settings.

- There is no direct way to edit the timer settings. If you see that some timer setting is not what you'd intended, you'll need to start the process again from the top.

### 11 Switch the system into standby.

The timer will not work if the system is left on!

The timer indicator (⌚) lights when the timer is on.

## Activating/deactivating the wake up timer

To activate the wake up timer, set the timer to **ON**. To deactivate it, set the timer to **OFF**.

### 1 Press **SYSTEM SETUP**.

### 2 Press **◀** or **▶** until you see **TIMER** in the display.

### 3 Press **ENTER**.

### 4 Press the **◀** or **▶** button until you see **TIMER ON** or **TIMER OFF** in the display.

### 5 Press **ENTER**.

The timer indicator (⌚) lights when the timer is on.

### Checking the timer settings

If you've set the wake-up timer, you can check the settings anytime.

- 1 Press **SYSTEM SETUP**.
- 2 Press **◀** or **▶** until you see **TIMER** in the display.
- 3 Press **ENTER**.
- 4 Press the **◀** or **▶** button until you see **TIMER CHECK** in the display.
- 5 Press **ENTER**.

The display shows the timer settings:

- On time
- Off time
- Function (DVD, etc.)
- Volume
- **CHECK END**

### Using the sleep timer

The sleep timer switches the system into standby after a specified amount of time so that you can fall asleep without worrying about the stereo being left on all night. If you've also set the wake up timer this is important since the wake up timer will only work if the system is in standby.

- 1 Press **SLEEP (SHIFT & 6)** to set the time until the system goes into standby.

Press repeatedly to switch between:

- **SLEEP AUTO** – this setting is only available when the system is playing a CD\*
- **SLEEP 90** (minutes)
- **SLEEP 60** (minutes)
- **SLEEP 30** (minutes)
- **SLEEP OFF** (cancels the sleep timer)

The sleep timer indicator (☾) lights and the display dims when the sleep timer is active.

\* This is not available when a Video CD is in PBC mode, or if you're playing a CD or Video CD in repeat mode. If you set a disc playing in repeat mode after setting the sleep timer to **SLEEP AUTO**, it automatically switches to the 90 minute setting.

- Once the sleep timer is set, you can check the time left by pressing **SLEEP (SHIFT & 6)**.
- To cancel the sleep timer, switch the system into standby, or select **SLEEP OFF** (as described above).
- If you switch to a different source when sleep auto is set, the system will automatically go into standby a minute later.

## Advanced sound settings

This chapter covers advanced settings to further optimize the sound of your system.

### LFE attenuator

The LFE (low frequency effects) channel carries ultra low bass sound to add weight to effects in Dolby Digital and DTS soundtracks. This channel can overload the subwoofer resulting in distortion. Use the LFE attenuator setting to reduce the signal fed to the subwoofer.



#### Note

The LFE attenuator only works with sources that contain an LFE channel. It is not a general level control for the sub-woofer.

- You can't change this setting if the Record mode is on (see page 25).

- 1 Press SYSTEM SETUP.**
- 2 Press the ◀ or ▶ button until you see LFE in the display.**
- 3 Use the ▲ and ▼ buttons to set the amount of signal reduction.**

There are three settings:

- **LFE ATT 0** – default setting (no signal reduction)
- **LFE ATT 10** – the LFE channel signal level is reduced to avoid distortion
- **LFE OFF** – the LFE channel is switched off completely. This may be useful late at night, for example.

- 4 Press ENTER.**

## Dynamic Range Control

The dynamic range of a source is the difference between the quietest and the loudest sounds. The dynamic range of Dolby Digital soundtracks can be very great. This makes them exciting, but it also means that when you turn the volume down you can easily lose quiet dialog. Switch on Dynamic Range Control to even out the soundtrack volume.

- You can't change this setting if the Record mode is on (see page 25).

- 1 Press SYSTEM SETUP.**
- 2 Press the ◀ or ▶ button until you see D.R.C. in the display.**
- 3 Use the ▲ and ▼ buttons to select a dynamic range setting.**
  - **D.R.C. OFF** – default setting (no change to the dynamics)
  - **D.R.C. LOW** – the dynamic range is reduced by a small amount.
  - **D.R.C. MID** – mid setting
  - **D.R.C. HIGH** – the dynamic range is reduced by a large amount (good for listening at very low volume).
- 4 Press ENTER.**

### Dual-mono setting

The dual-mono setting applies only to Dolby Digital discs that feature dual-mono material—see the disc box for details.

Dual-mono discs are recorded with two independent channels that may be played together or separately depending on the situation. For example, a guitar tuition disc might have the guitar recorded on one channel and all the other instruments on the other. Use the dual-mono setting to play just the guitar part on its own; just the backing, or everything together (through separate speakers, or mixed).

- You can't change this setting if the Record mode is on (see page 25).

- 1 Press **SYSTEM SETUP**.
- 2 Press the **◀** or **▶** button until you see **CH** or **MIX** in the display.
- 3 Use the **▲** and **▼** buttons to select a dual-mono setting.
  - **L-CH1 R-CH2** – default setting (Ch1 is played through the left speaker; Ch2 through the right)
  - **CH1** – Ch1 is played through the center speaker (or through the left and right speakers if **Surround Off** is selected); Ch2 is muted.
  - **CH2** – Ch2 is played through the center speaker (or through the left and right speakers if **Surround Off** is selected); Ch1 is muted.
  - **MIX** – Ch1 and Ch2 are mixed together and played through the center speaker (or through both left and right speakers if **Surround Off** is selected).
- 4 Press **ENTER**.

### Adjusting channel volume levels

Depending on your room and where you're sitting, you may want to adjust the relative volumes of one or more speakers for a more balanced sound. You can do this in any mode, including the surround, DSP, and stereo modes. Settings that you make in any sound mode are completely independent and don't affect any other mode.



#### Note

- Each DSP effect has its own set of channel level settings.
- The channel levels you set for the Surround mode apply to Standard and all Advanced Theater effects.
- The headphone level is not affected by the channel level settings.

- 1 Press **CH LEVEL**.  
Adjustments to the channel volume levels will affect only the current sound mode.
- 2 Use the **◀** and **▶** buttons to select a channel to adjust.  
The display shows the channel and its current setting.
  - Remember that not all channels are available in all sound modes.
- 3 Use the **▲** and **▼** buttons to adjust the volume of the current channel.  
For best results, sit in your main listening position when doing this. You can adjust each speaker in the range of +/-10dB.
- 4 When you're done, press **ENTER**.

## Using the DVD Setup menu

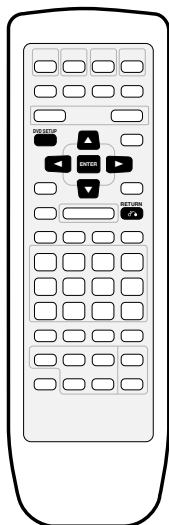

The DVD Setup menu gives you access to all the system's DVD settings. Press **DVD SETUP** to display/leave the menu and the cursor (**◀▶▲▼**) and **ENTER** buttons on the remote to navigate and select options. In some screens you can press **RETURN** to leave the screen without making any changes. The controls for each menu are shown at the bottom of the screen.

If an option is greyed out it means that it cannot be changed at the current time. This is usually because a disc is playing. Stop the disc, then change the setting.

The current setting for any option is marked with a colored box. The color of the box indicates what kind of disc the setting is applicable to: blue for DVD only; yellow for DVD and Video CD; green for any type of disc.



### Note

- The language options shown in the on-screen display illustrations on the following pages may not correspond to those available in your country or region.

## Video settings

### TV Screen

- Set in Setup Navigator (Default: **16:9 (Wide)**)

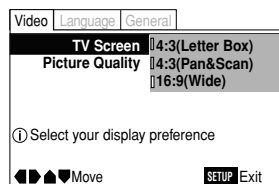

If you have a widescreen TV, select the **16:9 (Wide)** setting—widescreen DVD software is then shown using the full screen area. When playing software recorded in conventional (4:3) format, the settings on your TV will determine how the material is presented—see the manual that came with your TV for details on what options are available.

If you have a conventional TV, choose either **4:3 (Letter Box)** or **4:3 (Pan & Scan)**. In Letter Box mode, widescreen software is shown with black bars at the top and bottom of the screen. Pan & Scan chops the sides off widescreen material to make it fit the 4:3 screen (so even though the picture looks larger on the screen, you're actually seeing less of the movie). See page 50 for more information.

### Picture Quality

- Default setting: **Standard**

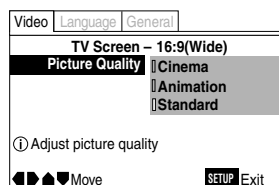

There are three preset picture quality settings that suit various program types.

**Cinema** – Sharp, high contrast picture.

**Animation** – Bright, vibrant colors.

**Standard** – Neutral picture.

**S-Video Out** (Expert)

- Default setting: **S2**

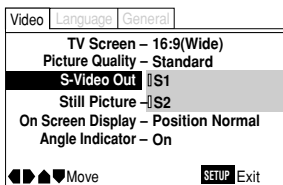

You can switch the type of S-Video signal output. If you connected your TV with an S-Video cord in some rare cases the TV picture may appear stretched. If you find this switch the S-Video output from S2 to S1.

**Still Picture** (Expert)

- Default setting: **Auto**

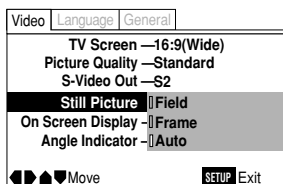

The player uses one of two processes when displaying a still frame from a DVD disc. The default Auto setting lets the system decide which to use.

**Field** – produces a stable, generally shake-free image.

**Frame** – produces a sharper image, but more prone to shake than field stills.

**On Screen Display** (Expert)

- Default setting: **Position – Normal**

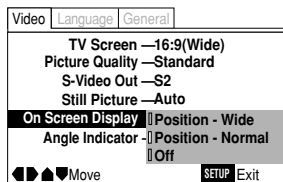

When watching DVD discs recorded in 4:3 format ('regular' TV size) on a widescreen TV, it can be difficult to see the operation displays (**Play, Stop, Resume**, etc.) at the top of the screen. If you find them hard to read, select **Position – Wide**.

If you prefer not to have the operation displays shown on-screen, change the setting to **Off**.

**Angle Indicator** (Expert)

- Default setting: **On**

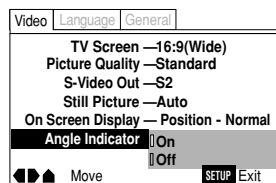

If you prefer not to see the camera icon on-screen during multi-angle scenes on DVD discs, change the Angle Indicator setting to **Off**.

**Language settings****OSD Language**

- Set in Setup Navigator (default: **English**)

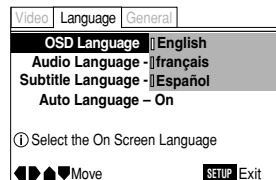

Choose the language you want the OSDs in.

### Audio Language

- Default Setting: **English**

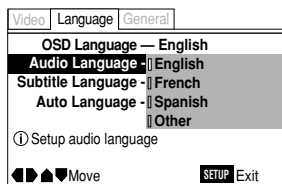

This setting is your preferred audio language for DVD discs. If the language you specify here is recorded on a disc, the system automatically plays the disc in that language (although this depends on the *Auto Language* setting—see *Auto Language* on page 40).

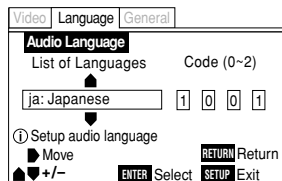

The DVD format recognizes 136 different languages. Choose **Other** if you want to specify a language other than those listed, then follow the on-screen display to select a language. You may also want to refer to the *Language code list* on page 47.

#### Remember

You can switch between the languages recorded on a DVD disc any time during playback using the **AUDIO** button. (This does not affect this setting.)

### Subtitle Language

- Default Setting: **English**



This setting is your preferred subtitle language for DVD discs. If the language you specify here is recorded on a

disc, the system automatically plays the disc with those subtitles (although this depends on the *Auto Language* setting—see *Auto Language* on page 40).

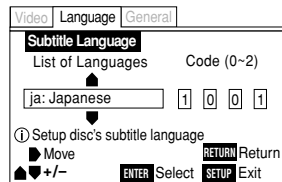

The DVD format recognizes 136 different languages. Choose **Other** if you want to specify a language other than those listed, then follow the on-screen display to select a language. You may also want to refer to the *Language code list* on page 47.

#### Remember

You can change or switch off the subtitles on a DVD disc any time during playback using the **SUBTITLE** button. (This does not affect this setting.)

### Auto Language

- Default Setting: **On**

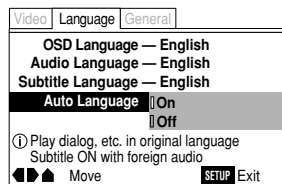

When set to **On**, the system always selects the default audio language on a DVD disc (French dialog for a French movie, for example), and displays subtitles in your preferred subtitle language only if that is set to something different. In other words, movies in your native language won't have any subtitles, while foreign language movies will be shown with subtitles. Set to **Off** to have the system play discs strictly according to your *Audio Language* and *Subtitle Language* settings.

For Auto Language to work, the *Audio Language* and *Subtitle Language* settings must be the same—see this page.



**Tip**

You can still switch audio and subtitle languages on playback using the **AUDIO** and **SUBTITLE** buttons.

**DVD Language** Expert

- Default Setting: **w/Subtitle Language**

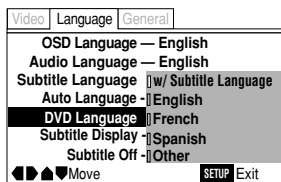

Some multi-lingual discs have disc menus in several languages. This setting specifies in which language the disc menus should appear. Leave on the default setting for menus to appear in the same language as your *Subtitle Language*—see page 40.

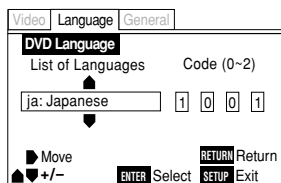

The DVD format recognizes 136 different languages. Choose **Other** if you want to specify a language other than those listed, then follow the on-screen display to select a language. You may also want to refer to the *Language code list* on page 47.

**Subtitle Display** Expert

- Default Setting: **On**

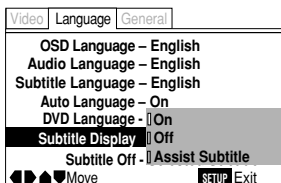

Set to **On**, the player displays subtitles according to the *Subtitle Language* and *Auto Language* settings above. Set to **Off** to switch subtitles off altogether (although see *Subtitle Off* on this page for special cases). Set to **Assist Subtitle** to have the player display the extra assistive subtitles recorded on to some DVD discs.

**Subtitle Off** Expert

- Default Setting: **Selected Subtitle**



Some discs display subtitles even if the *Subtitle Display* setting (this page) is set to off. In this case, you can either have the subtitles displayed in the same language as your preferred audio language (**With Audio**), or in your preferred subtitle language (**Selected Subtitle**). If the *Audio Language* and *Subtitle Language* settings are the same then both of these choices will give the same result.

**General settings****Setup Menu Mode**

- Default setting: **Basic**

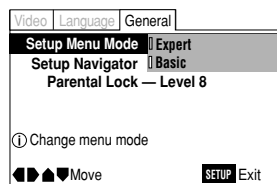

The **Basic** setup menu gives you access to the more commonly used settings. It also features an information bar which tells you more about what the currently highlighted option means.

Set to **Expert** for access to all settings.

## Parental Lock

- Default level: **8**
- Default password: *none*

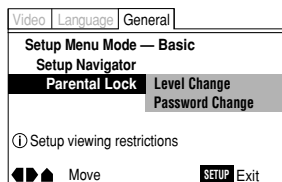

You can restrict access to certain discs using this feature. Once set, the player will ask for a four-digit password if a restricted disc is loaded, giving you a degree of control over what your children watch.

The player can be set to one of eight levels. Setting the level at 1 means that any disc with any level of restriction will need the password in order to watch it, while setting it at level 8 gives unlimited access.

DVD discs are also rated from 1 to 8. Discs rated 1 (or with no rating) generally contain little or no offensive material; discs rated 2, may contain material that some parents may feel is unsuitable for children. Discs rated 8 will almost certainly be unsuitable for children.

Since a disc's rating is up to the manufacturer, it is not possible to give a definitive guide to each level—check the disc box for parental lock details.

### Note

Not all discs that you may consider inappropriate for your children are rated. Unrated discs will always play without requiring the password first.

## Changing the parental lock level

- 1 **Select Level Change.**
- 2 **Use number buttons to register a new password or confirm your existing password, then press ENTER.**

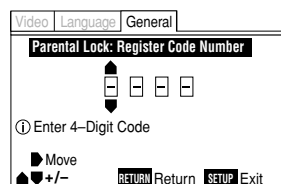

The first time you set the parental lock level, you have to register a password. Anything you input becomes your password.

- 3 **Select a new level.**

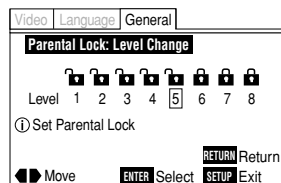

Move leftward to lock more levels (more discs will require the password); rightward to unlock levels. You can't lock level 1.

- 4 **Press ENTER to set the new level.**

## Changing your password

- 1 **Select Password Change.**
- 2 **Input your existing password, then press ENTER.**

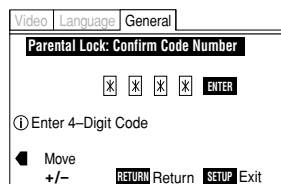

### 3 Input a new password, then press ENTER.

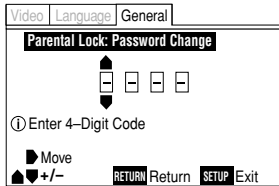

If you forget your password, resetting the player will clear the password. See page 44 for more on this.

### Screen Saver Expert

- Default setting: **On**

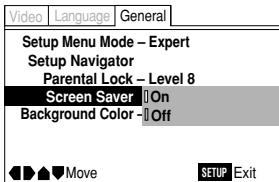

If a constant image is displayed on a conventional CRT-type TV, it can “burn in” leaving a ghost image on the screen. When **On**, the screen saver makes sure that a constant image is not displayed for a dangerously long time.

### Background Color Expert

- Default setting: **Blue**

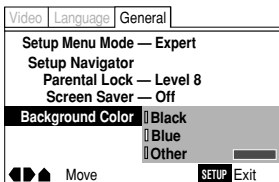

This specifies the color of the screen when the player is stopped (or playing an audio disc).

Select **Other** if you want to make your own background color. Follow the on-screen display to create a color from the red, green and blue bars.

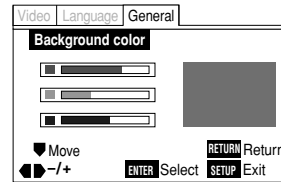

### Switching the AM frequency interval

As its default setting, the tuner jumps in steps of 10kHz when tuning in AM stations. If you find that this is unsuitable in your area (if you can't tune into stations successfully), you can change the tuning interval to 9kHz for AM. Here's how to switch the setting.

- 1 **Switch the system into standby.**
- 2 **Press SYSTEM SETUP.**
- 3 **Press the ◀ or ▶ button until you see AM STEP in the display.**
- 4 **Use the ▲ and ▼ buttons to select 9kHz or 10kHz.**
  - When set to 9kHz, the FM tuning interval becomes 50kHz. This should not affect tuning into FM stations.
- 5 **Press ENTER.**

### Setting the display brightness

You can adjust the brightness of the display to suit the lighting conditions of the room.

- **Press FL DIMMER (SHIFT & >10).**  
Press repeatedly to set the display brightness. There are five levels.

### Switching the time format

You can display the clock in either 12 or 24-hour format.

- 1 **Switch the system into standby.**
- 2 **Press SYSTEM SETUP.**
- 3 **Press the ◀ or ▶ button until you see CLOCK 12 HR or CLOCK 24 HR in the display.**
- 4 **Use the ▲ and ▼ buttons to select 12 or 24.**
- 5 **Press ENTER.**

### Resetting the system

Resetting the system returns all menu, picture and password settings to their factory defaults.

- 1 **Switch the system into standby using the front panel standby/on switch.**
- 2 **Hold down the front panel ■ button and switch back on.**

## Taking care of your system

To clean this unit, wipe with a soft, dry cloth. For stubborn dirt, wet a soft cloth with a mild detergent solution made by diluting one part detergent to 5 or 6 parts water, wring well, then wipe off the dirt. Use a dry cloth to wipe the surface dry. Do not use volatile liquids such as benzene and thinner which may damage the surfaces.

## Disc lens cleaner

The disc pickup lens should not become dirty in normal use, but if for some reason it should malfunction due to dirt or dust, consult your nearest Pioneer authorized service center. Although lens cleaners for CD players are commercially available, we do not recommend using them since some may damage the lens.

## Taking care of your discs

When holding discs, take care not to leave fingerprints, dirt or scratches on the disc surface. Hold the disc by its edge or by the center hole and edge. Damaged or dirty discs can affect playback performance. Take care also not to scratch the label side of the disc. Although not as fragile as the recorded side, scratches can still result in a disc becoming unusable.

Should a disc become marked with fingerprints, dust, etc., clean using a soft, dry cloth, wiping the disc lightly from the center to the outside edge as shown on the next page. If necessary, use a cloth soaked in alcohol, or a commercially available CD or DVD cleaning kit to clean a disc more thoroughly. Never use benzine, thinner or other cleaning agents, including products designed for cleaning vinyl records.

- Wipe lightly from the center of the disc using straight strokes.



- Don't wipe the disc surface using circular strokes.

## Storing discs

Although CDs and DVDs are more durable than vinyl records, you should still take care to handle and store discs correctly. When you're not using a disc, return it to its case and store upright. Avoid leaving discs in excessively cold, humid, or hot environments (including under direct sunlight).

Don't glue paper or put stickers on discs, or write on them using a pencil, ball-point pen or other sharp-tipped writing instrument.

## Discs to avoid

Discs spin at high speed during playback. If you can see that a disc is cracked, chipped, warped, or otherwise damaged, don't risk using it—you could end up damaging the system.

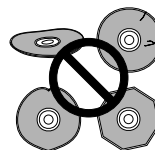

This system is designed for use with conventional, fully circular discs only. Use of shaped discs is not recommended. Pioneer disclaims all liability arising in connection with the use of shaped CDs and DVDs.

## Glossary

### Aspect ratio

The width of a TV screen relative to its height. Conventional TVs are 4:3 (in other words, the screen is almost square); widescreen models are 16:9 (the screen is almost twice as wide as it is high).

### Chapter

Just as a book is split up into several chapters, a title on a DVD disc is usually divided into chapters. See also Title.

### Dolby Digital

A surround sound system developed by Dolby Laboratories containing up to six channels of digital audio (front left and right, surround left and right, center and low-frequency channels). See also DTS.

### DTS

A surround sound system developed by Digital Theater Systems as an alternative to Dolby Digital. DTS discs contain up to eight channels of digital audio. See also Dolby Digital.

### MPEG video

The video format used for Video CDs and DVDs. Video CD uses the older MPEG-1 standard, while DVD uses the newer and much better quality MPEG-2 standard.

### PBC (PlayBack Control) (Video CD only)

A system of navigating a Video CD through on-screen menus recorded onto the disc. Especially good for discs that you would normally not watch from beginning to end all at once—karaoke discs, for example.

### Regions (DVD only)

These associate discs and players with particular areas of the world. This unit will only play discs that have compatible region codes. You can find the region code of your unit by looking on the rear panel. Some discs are compatible with more than one region (or all regions).

### Title (DVD only)



A collection of chapters on a DVD disc. See also Chapter.

## Language code list

Language/Langue	Code	Language/Langue	Code	Language/Langue	Code
Japanese/japonais ( ja )	1001	Hausa ( ha )	0801	Quechua ( qu )	1721
English/anglais ( en )	0514	Hindi ( hi )	0809	Rhaeto-Romance ( rm )	1813
French ( fr )	0618	Croatian ( hr )	0818	Kirundi ( rn )	1814
German ( de )	0405	Hungarian ( hu )	0821	Romanian ( ro )	1815
Italian ( it )	0920	Armenian ( hy )	0825	Kinyarwanda ( rw )	1823
Spanish ( es )	0519	Interlingua ( ia )	0901	Sanskrit ( sa )	1901
Dutch ( nl )	1412	Interlingue ( ie )	0905	Sindhi ( sd )	1904
Russian ( ru )	1821	Inupiak ( ik )	0911	Sangho ( sg )	1907
Chinese ( zh )	2608	Indonesian ( in )	0914	Serbo-Croatian ( sh )	1908
Korean ( ko )	1115	Icelandic ( is )	0919	Singhalese ( si )	1909
Greek ( el )	0512	Hebrew ( iw )	0923	Slovak ( sk )	1911
Afar ( aa )	0101	Yiddish ( ji )	1009	Slovenian ( sl )	1912
Abkhazian ( ab )	0102	Javanese ( jw )	1023	Samoaan ( sm )	1913
Afrikaans ( af )	0106	Georgian ( ka )	1101	Shona ( sn )	1914
Amharic ( am )	0113	Kazakh ( kk )	1111	Somali ( so )	1915
Arabic ( ar )	0118	Greenlandic ( kl )	1112	Albanian ( sq )	1917
Assamese ( as )	0119	Cambodian ( km )	1113	Serbian ( sr )	1918
Aymara ( ay )	0125	Kannada ( kn )	1114	Siswati ( ss )	1919
Azerbaijani ( az )	0126	Kashmiri ( ks )	1119	Sesotho ( st )	1920
Bashkir ( ba )	0201	Kurdish ( ku )	1121	Sundanese ( su )	1921
Byelorussian ( be )	0205	Kirghiz ( ky )	1125	Swedish ( sv )	1922
Bulgarian ( bg )	0207	Latin ( la )	1201	Swahili ( sw )	1923
Bihari ( bh )	0208	Lingala ( ln )	1214	Tamil ( ta )	2001
Bislama ( bi )	0209	Laothian ( lo )	1215	Telugu ( te )	2005
Bengali ( bn )	0214	Lithuanian ( lt )	1220	Tajik ( tg )	2007
Tibetan ( bo )	0215	Latvian ( lv )	1222	Thai ( th )	2008
Breton ( br )	0218	Malagasy ( mg )	1307	Tigrinya ( ti )	2009
Catalan ( ca )	0301	Maori ( mi )	1309	Turkmen ( tk )	2011
Corsican ( co )	0315	Macedonian ( mk )	1311	Tagalog ( tl )	2012
Czech ( cs )	0319	Malayalam ( ml )	1312	Setswana ( tn )	2014
Welsh ( cy )	0325	Mongolian ( mn )	1314	Tonga ( to )	2015
Danish ( da )	0401	Moldavian ( mo )	1315	Turkish ( tr )	2018
Bhutani ( dz )	0426	Marathi ( mr )	1318	Tsonga ( ts )	2019
Esperanto ( eo )	0515	Malay ( ms )	1319	Tatar ( tt )	2020
Estonian ( et )	0520	Maltese ( mt )	1320	Twí ( tw )	2023
Basque ( eu )	0521	Burmese ( my )	1325	Ukrainian ( uk )	2111
Persian ( fa )	0601	Nauru ( na )	1401	Urdu ( ur )	2118
Finnish ( fi )	0609	Nepali ( ne )	1405	Uzbek ( uz )	2126
Fiji ( fj )	0610	Norwegian ( no )	1415	Vietnamese ( vi )	2209
Faroese ( fo )	0615	Occitan ( oc )	1503	Volapük ( vo )	2215
Frisian ( fy )	0625	Oromo ( om )	1513	Wolof ( wo )	2315
Irish ( ga )	0701	Oriya ( or )	1518	Xhosa ( xh )	2408
Scots-Gaelic ( gd )	0704	Panjabi ( pa )	1601	Yoruba ( yo )	2515
Galician ( gl )	0712	Polish ( pl )	1612	Zulu ( zu )	2621
Guarani ( gn )	0714	Pashto, Pushto ( ps )	1619		
Gujarati ( gu )	0721	Portuguese ( pt )	1620		

## Troubleshooting

Incorrect operation is often mistaken for trouble or malfunction. If you think that there is something wrong with this component, check the points below. Sometimes the trouble may lie in another component. Inspect the other components and electrical appliances being used. If the trouble cannot be rectified after checking the items below, ask your nearest Pioneer authorized service center or your dealer to carry out repair work.

Problem	Remedy
<b>CDs, DVDs and Video CDs</b>	
<b>The disc is ejected automatically after loading.</b>	<ul style="list-style-type: none"> <li>• Check that the disc is clean and undamaged (page 45).</li> <li>• Make sure that the disc is seated properly in the disc guide.</li> <li>• Check that the disc has a compatible region number (page 7).</li> <li>• There may be condensation inside the unit. Allow time for condensation to evaporate. Avoid using the player near an air-conditioning unit.</li> </ul>
<b>Playback is not possible.</b>	<ul style="list-style-type: none"> <li>• Check that the disc is loaded correctly (label side face up).</li> </ul>
 <b>mark appears on screen.</b>	<ul style="list-style-type: none"> <li>• The operation is prohibited by the system.</li> </ul>
 <b>mark appears on screen.</b>	<ul style="list-style-type: none"> <li>• The selected function does not operate for that disc.</li> </ul>
<b>When making changes in the Setup OSD menus,  is displayed.</b>	<ul style="list-style-type: none"> <li>• There is a CD or Video CD loaded and the setting that was changed applies only to DVD discs. The settings will take effect next time a DVD is loaded.</li> </ul>
<b>Picture playback stops and the operation buttons cannot be used.</b>	<ul style="list-style-type: none"> <li>• Switch the power off once, then on again using the front panel standby/on switch.</li> </ul>
<b>New settings made in the Setup screen menus while a disc is playing are ineffective.</b>	<ul style="list-style-type: none"> <li>• Some settings can be changed while a disc is playing, but are not effective until the disc is stopped then restarted. This is not a malfunction. Note that making settings in the Setup screen menus may cancel the resume function.</li> </ul>
<b>Settings are canceled.</b>	<ul style="list-style-type: none"> <li>• If the power was cut due to power failure or by unplugging the power cord, settings will be canceled.</li> </ul>
<b>No picture/No color.</b>	<ul style="list-style-type: none"> <li>• Check that the video connections are correct and that plugs are inserted fully.</li> <li>• Check that the TV/monitor settings are correct.</li> </ul>
<b>Screen is stretched or aspect does not change.</b>	<ul style="list-style-type: none"> <li>• Make sure that the TV Screen option in the Setup menu matches the TV/monitor you're using.</li> </ul>
<b>Picture disturbance during playback or screen is dark.</b>	<ul style="list-style-type: none"> <li>• This player is compatible with Macro-Vision System copy guard. Some discs include a copy prevention signal, and when this type of disc is played back, stripes etc., may appear on some sections of the picture depending on the TV. This is not a malfunction.</li> <li>• Problems with some discs may result in the screen becoming black for a brief instant or shaking slightly when certain functions are executed.</li> <li>• Due to copy protection, connection of this system through a VCR or an AV selector may prevent recording or cause picture problems. This is not a malfunction.</li> </ul>



Problem	Remedy
<b>Noticeable difference in DVD and CD volume.</b>	<ul style="list-style-type: none"> <li>DVDs and CDs use different recording methods. This is not a malfunction.</li> </ul>
<b>Tuner</b>	
<b>Noisy radio reception</b>	<ul style="list-style-type: none"> <li>Check that the frequency is correct.</li> <li>Check that the antennas are connected properly. For FM, make sure that the antenna is fully extended and positioned to give the best reception. For AM, make sure that the loop antenna is pointing in the best direction.</li> <li>If the radio signal is weak, an outdoor antenna will usually give better results than the supplied indoor types.</li> <li>Other electrical equipment, such as TVs, fluorescent lamps and motors can cause interference. Try switching off or moving the equipment, or moving the antenna(s).</li> <li>The tuning interval may be incorrect for your country or region. Try switching the tuning interval (page 44).</li> </ul>
<b>Auto tuning does not pick up some stations.</b>	<ul style="list-style-type: none"> <li>Auto tuning will only detect radio stations with a good signal. For more sensitive tuning, connect an outdoor antenna.</li> </ul>
<b>General</b>	
<b>The remote control doesn't seem to work.</b>	<ul style="list-style-type: none"> <li>Make sure that you're using the remote within its operating range and that there are no obstacles between the remote and the sensor on the main unit.</li> <li>Check that the batteries are not exhausted.</li> </ul>
<b>No audio, or audio is distorted.</b>	<ul style="list-style-type: none"> <li>Check that the correct function is selected (DVD/CD, etc.), the volume turned up.</li> <li>Check that the MUTE function is not on and that the disc is not paused.</li> <li>Check that the disc is clean and undamaged (page 45).</li> <li>Check that all rear panel connections are correct.</li> <li>If you find dirty or oxidized plugs/terminals, clean them.</li> </ul>
<b>Can't adjust sound mode settings (bass, treble, etc.)</b>	<ul style="list-style-type: none"> <li>The Record Mode is switched on. Switch off then adjust as desired (see page 25).</li> </ul>



**Note**



Static electricity or other external influences may cause malfunctioning of this unit. In this case, unplug the power cord and then plug back in. This will usually reset the unit for proper operation. If this does not correct the problem, please consult your nearest PIONEER service center.

## Screen sizes and disc formats

The table below shows the effect of various TV Screen settings on the different kinds of disc available.

### When viewing a widescreen TV or monitor

Setting and appearance	Screen format of disc
 <p>16:9 (Wide)</p>	<p><b>Widescreen (movies, etc.)</b> Note that some extra-wide formats (such as CinemaScope) will appear with black bars at the top and bottom of the screen.</p>

	<p><b>Standard (TV programs, etc.)</b> Your TV will determine how the picture is presented—check the manual that came with the TV for details. Typical options are black bars either side, some form of stretched or zoomed presentation.</p>
 <p>16:9 (Wide)</p>	

### When viewing a standard size TV or monitor

Setting and appearance	Screen format of disc
 <p>Any setting</p>	<p><b>Standard (TV programs, etc.)</b> The program is presented correctly, regardless of the setting.</p>

 <p>4:3 (Letter Box)</p>	<p><b>Widescreen (movies, etc.)</b> The program is shown in widescreen with black bars at the top and bottom of the screen.</p>
---	---

 <p>4:3 (Pan &amp; Scan)</p>	<p><b>Widescreen (movies, etc.)</b> The sides of the program are cropped so that the picture fills the whole screen.</p>
--	--

 <p>16:9 (Wide)</p>	<p><b>Widescreen (movies, etc.)</b> The program appears squashed: set to either 4:3 (Letter Box) or 4:3 (Pan &amp; Scan).</p>
--	---

## Specifications

### Amplifier Section

Continuous power output (RMS)	
Front .....	80 W, per channel (1 kHz, 10 % T.H.D., 8 Ω)
Rear .....	30 W, per channel (1 kHz, 10 % T.H.D., 8 Ω)
Center .....	30 W, per channel (1 kHz, 10 % T.H.D., 8 Ω)
Subwoofer .....	80W (100Hz, 10% T.H.D., 8Ω)

### DVD Player (Audio)Section

S/N ratio .....	115 dB (EIA)
Dynamic range .....	100 dB (EIA)
Distortion .....	0.004%
Frequency response	
48 kHz sampling .....	4 Hz to 22 kHz
96 kHz sampling .....	4 Hz to 44 kHz
Wow & flutter .....	Below measurable levels (±0.001 % W.PEAK)

### DVD Player (Video) Section

Output level .....	1 Vp-p (75 Ω)
Video Y output level .....	1 Vp-p (75 Ω)
Video C output level .....	286 mVp-p (75 Ω)

### DVD (Other jacks) Section

Digital coaxial input (PCM/Dolby/DTS) .....	Coaxial connector
---	-------------------

### Tuner Section

FM tuner	
Frequency range .....	87.5 MHz to 108.0 MHz
Antenna .....	75 Ω unbalanced
AM tuner	
Frequency range	
.....	531 kHz to 1,602 kHz (9 kHz step)
.....	530 kHz to 1,700 kHz (10 kHz step)
Antenna .....	loop antenna (supplied)

### Power Supply Section

Power Requirements	
Multi voltage model	
.....	AC 110-127/220-230/240 V (Switchable) , 50/60 Hz
European model .....	AC 220-230 V, 50/60 Hz
UK model .....	AC 230 V, 50/60 Hz
Australian and New Zealand models	
.....	AC 240 V, 50/60 Hz

Power consumption	
Flat blade 2-pin AC plug model .....	540 W
Australian and New Zealand models .....	139 W
Except Flat blade 2-pin AC plug model and	
Australian and New Zealand models .....	136 W
Power consumption in standby mode .....	1 W

### Miscellaneous

Dimensions	
European model and UK mode	
.....	420 (W) x 411.6 (D) x 150 (H) mm
Except European model and UK mode	
.....	420 (W) x 410.4 (D) x 150 (H) mm
Weight .....	9.8 kg

### Speaker system (S-HTD1)

(Front Speaker x 2, Rear Speaker x 2, Center Speaker x 1, Subwoofer x 1)

#### Front speaker

Enclosure .....	Closed-box bookshelf type (magnetically shielded †)
System .....	10 cm 2-way system
Speaker	
Woofers .....	10 cm cone type
Tweeter .....	5.2 cm cone type
Nominal impedance .....	8 Ω
Frequency range .....	50 to 20,000 Hz
Max. input .....	100 W
Dimensions .....	150 (W) x 270 (H) x 178 (D) mm
Weight .....	2.0 kg

#### Rear speaker

Enclosure .....	Closed-box bookshelf type
System .....	8.7 cm 1-way system
Speaker .....	8.7 cm (cone type)
Nominal impedance .....	8 Ω
Frequency range .....	120 to 20,000 Hz
Max. input .....	33 W
Dimensions .....	115 (W) x 150 (H) x 96 (D) mm
Weight .....	0.8 kg

#### Center speaker

Enclosure .....	Closed-box bookshelf type (magnetically shielded †)
System .....	8.7 cm 1-way system
Speaker .....	8.7 cm (cone type)
Nominal impedance .....	8 Ω
Frequency range .....	80 to 20,000 Hz
Max. input .....	34 W
Dimensions .....	370 (W) x 120 (H) x 130 (D) mm
Weight .....	1.8 kg

#### Subwoofer

Enclosure .....	Bass reflex floor type
System .....	16 cm 1-way system
Speaker .....	16 cm (cone type)
Nominal impedance .....	8 Ω
Frequency range .....	30 Hz to 2000 Hz
Max. input .....	100 W
Dimensions .....	190 (W) x 360 (H) x 327 (D) mm
Weight .....	4.8 kg

† Antimagnetic design (EIAJ) speaker system conforms to the basic EIAJ standards.

### Supplied Items

Remote control .....	1
AA/R6P dry cell batteries .....	2
AM loop antenna .....	1
FM antenna .....	1
Video cord (yellow) .....	1
Power cord .....	1
.....	2 (Central and South America models only)
Speaker cords	
5m (for front L-R speakers) .....	2
2m (for center speaker) .....	1
6m (for rear L-R speakers) .....	2
3m (for subwoofer) .....	1
Operating instructions .....	1
Warranty card (European and Australian models only) .....	1
Power plug adapter (Central and South America models only) .....	1

*Note: Specifications and design subject to possible modification without notice, due improvements.*

# Switching the demo mode on/off

When you first plug in this system the display shows a demo sequence. The demo will also start if the system is on in the DVD function but idle for more than 5 minutes. The demo will stop if you press any button except **CD MODE** on the main unit .

- **To switch the demo mode off completely, press and hold CD MODE on the main unit for about 3 seconds while the demo is in progress.**
- **To switch the demo mode on, press and hold CD MODE on the main unit for about 3 seconds while the system is in standby.**

Published by Pioneer Corporation.  
Copyright © 2001 Pioneer Corporation.  
All rights reserved.

---

**PIONEER CORPORATION** 4-1, Meguro 1-Chome, Meguro-ku, Tokyo 153-8654, Japan  
**PIONEER ELECTRONICS [USA] INC.** P.O. BOX 1540, Long Beach, California 90810-1540, U.S.A.  
**PIONEER ELECTRONICS OF CANADA, INC.** 300 Allstate Parkway, Markham, Ontario L3R OP2, Canada  
**PIONEER EUROPE NV** Haven 1087, Keetberglaan 1, B-9120 Melsele, Belgium TEL: 03/570.05.11  
**PIONEER ELECTRONICS AUSTRALIA PTY. LTD.** 178-184 Boundary Road, Braeside, Victoria 3195, Australia, TEL: [03] 9586-6300  
**PIONEER ELECTRONICS DE MEXICO S.A. DE C.V.** San Lorenzo 1009 3er Piso Desp. 302 Col. Del Valle Mexico D.F. C.P. 03100  
TEL: 5-688-52-90

## Free Manuals Download Website

<http://myh66.com>

<http://usermanuals.us>

<http://www.somanuals.com>

<http://www.4manuals.cc>

<http://www.manual-lib.com>

<http://www.404manual.com>

<http://www.luxmanual.com>

<http://aubethermostatmanual.com>

Golf course search by state

<http://golfingnear.com>

Email search by domain

<http://emailbydomain.com>

Auto manuals search

<http://auto.somanuals.com>

TV manuals search

<http://tv.somanuals.com>