

LaserMemory

DE-SH9101

書き換え／追記両用型光ディスクドライブ・サブシステム
MULTIFUNCTION OPTICAL DISK DRIVE SUBSYSTEM
SYSTEME AUXILIAIRE D'UNITE DE DISQUE OPTIQUE MULTIFONCTIONNELLE
MULTIFUNKTIONALES OPTISCHES DISKETTENLAUFWERK UNTERSYSTEM

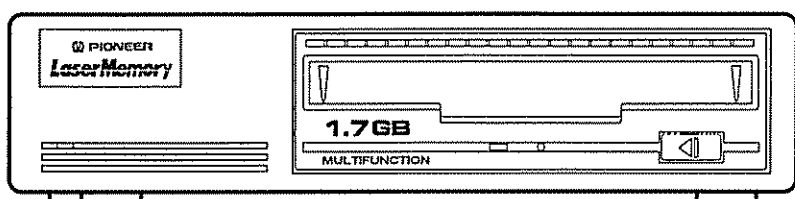

日本語

English

Français

Deutsch

検査サンプル

判	1999年10月21日		
	合格・不合格		
定	責任者	担当	
	今野	内	三

お買いあげいただき、まことにありがとうございます。お使いになる前に、この取扱説明書を必ずお読みください。お読みになった後は、後日お役に立つこともありますので、保証書などと共に大切に保管してください。

- 本製品は外国為替及び外国貿易管理法に定める戦略物資(又は、役務)に該当します。輸出する場合は同法に基づく輸出許可が必要となります。

所沢マニュアルセンター

この装置は、第二種情報装置（住宅地域又はその隣接した地域において使用されるべき情報装置）で住宅地域での電波障害防止を目的とした情報処理装置等電波障害自主規制協議会（VCCI）基準に適合しております。しかし、本装置をラジオ、テレビジョン受信機に近接してご使用になると、受信障害の原因となることがあります。取扱説明書に従って正しい取り扱いをしてください。

目次

ご使用の前に	2	使用上の注意	7
特長	3	仕様	7
準備	3	故障？ ちょっと調べてください	8
各部の名称と使い方	6		

Thank you for buying this Pioneer product.
Please read through these operating instructions so you will know how to operate your model properly. After you have finished reading the instructions, put them away in a safe place for future reference

In some countries or regions, the shape of the power plug and power outlet may sometimes differ from that shown in the explanatory drawings. However, the method of connecting and operating the unit is the same

CONTENTS

IMPORTANT SAFETY INSTRUCTIONS	9	USAGE PRECAUTIONS	15
FEATURES	11	TROUBLESHOOTING	15
PREPARATION	11	SPECIFICATIONS	16
NAMES OF PARTS AND THEIR FUNCTIONS	14		

IMPORTANT! SAFETY INSTRUCTIONS

- | | | |
|----------------------------------------------------------------------------------------------------------------------------------------------------------------------------------------------------------------------------------------------------------------------------------------------------------------------------------------------------------------------------------------------------------------------------------------------------------------------------------------------------------------------------------------------------------------------------------------------------------------------------------------------------------------------------------------------------------------------------------------------------------------------------------------------------------------------------------------------------------------------------------------------------------------------------------------------------------------------------------------------------------------------------------------------------------------------------------------------------------------------------------------------------------------------------------------------------------------------------------------------------------------------------------------------------------------------------------------------------------------------------------------------------------------------------------------------------------------------------------------------------------------------------------------------------------------------------|--------------------------------------------------------------------------------------------------------------------------------------------------------------------------------------------------------------------------------------------------------------------------------------------------------------------------------------------------------------------------------------------------------------------------------------------------------------------------------------------------------------------------------------------------------------------------------------------------------------------------------------------------------------------------------------------------------------------------------------------------------------------------------------------------------------------------------------------------------------------------------------------------------------------------------------------------------------------------------------------------------------------------------------------------------------------------------------------------------------------------------------------------------------------------------------------------------------------------------------------------------------------------------------------------------------------------------------------------------------------------------------------------------------------------------------------------------------------------------------------------------------------------------------------------------------------|-----------------------------------------------------------------------------------------------------------------------------------------------------------------------------------------------------------------------------------------------------------------------------------------------------------------------------------------------------------------------------------------------------------------------------------------------------------------------------------------------------------------------------------------------------------------------------------------------------------------------------------------------------------------------------------------------------------------------------------------------------------------------------------------------------------------------------------------------------------------------------------------------------------------------------------------------------------------------------------------------------------------------------------------------------------------------------------------------------------------------------------------------------------------------------------------|
| <p>1. READ INSTRUCTIONS - All the safety and operating instructions should be read before the appliance is operated.</p> <p>2. RETAIN INSTRUCTIONS - The safety and operating instructions should be retained for future reference.</p> <p>3. HEED WARNINGS - All warnings on the appliance and in the instructions should be adhered to.</p> <p>4. FOLLOW INSTRUCTIONS - All operating and use instructions should be followed.</p> <p>5. CLEANING - Unplug this product from the wall outlet before cleaning.
Do not use liquid cleaners or aerosol cleaners.
Use a damp cloth for cleaning.</p> <p>6. WATER AND MOISTURE - Do not use this product near water.</p> <p>7. ACCESSORIES - Do not place this product on an unstable cart, stand, or table.
The product may fall and be seriously damaged.</p> <p>8. VENTILATION - Slots and openings in the cabinet and back or bottom are provided for ventilation and to ensure reliable operation of the product and to protect it from overheating. These openings must not be blocked or covered. They should never be blocked by placing the product on a bed, sofa, rug, or other similar surface. This product should never be placed in a built-in installation unless proper ventilation is provided.</p> <p>9. POWER SOURCES - This product should be operated only from the type of power source indicated on the marking label. If you are not sure of the type of power available, consult your dealer or local power company.</p> | <p>10. PLUG - This product is equipped with a wired grounding type plug (a plug having a third (grounding) pin). This plug will only fit into a grounding type power outlet. This is a safety feature. If you are unable to insert the plug into the outlet, contact your electrician to replace your obsolete outlet. Do not defeat the safety purpose of the grounding type plug.</p> <p>11. POWER-CORD PROTECTION - When unplugging the apparatus, pull on the plug - not on the cord. Do not handle the cord or plug with wet hands. Doing so could cause an electric short or shock. Do not allow anything to rest on the power cord. Do not locate this product where persons will walk on the cord.</p> <p>12. OVERLOADING - Do not overload wall outlets and extension cords as this can result in fire or electric shock.</p> <p>13. OBJECT AND LIQUID ENTRY - Never push objects of any kind into this product through openings as they may touch dangerous voltage points or short out parts that could result in a fire or electric shock. Never spill liquid of any kind on the product.</p> <p>14. CONDENSATION - Moisture will form in the operating section of the product and the product's performance will be impaired if the product is brought from cool surroundings into a warm room or if the room temperature rises suddenly. To prevent this, let the product stand in its new surroundings for about an hour or two before switching it on, or ensure that the room temperature rises gradually.</p> | <p>15. SERVICING - Do not attempt to service this product yourself as opening or removing covers may expose you to dangerous voltage or other hazards. Refer all servicing to qualified service personnel.</p> <p>16. DAMAGE REQUIRING SERVICE - Unplug this product from the wall outlet and refer servicing to qualified service personnel under the following conditions:</p> <ul style="list-style-type: none"> a. When the power cord or plug is damaged b. If liquid has been spilled, or objects have fallen into the product c. If the product has been exposed to rain or water d. If the product does not operate normally when the operating instructions are followed. Adjust only those controls that are covered by the operating instructions. Improper adjustment of other controls may result in damage and will often require extensive work by a qualified technician to restore the product to its normal operation. e. If the product has been dropped or the cabinet has been damaged f. When the product exhibits a distinct change in performance - this indicates a need for service |
|----------------------------------------------------------------------------------------------------------------------------------------------------------------------------------------------------------------------------------------------------------------------------------------------------------------------------------------------------------------------------------------------------------------------------------------------------------------------------------------------------------------------------------------------------------------------------------------------------------------------------------------------------------------------------------------------------------------------------------------------------------------------------------------------------------------------------------------------------------------------------------------------------------------------------------------------------------------------------------------------------------------------------------------------------------------------------------------------------------------------------------------------------------------------------------------------------------------------------------------------------------------------------------------------------------------------------------------------------------------------------------------------------------------------------------------------------------------------------------------------------------------------------------------------------------------------------|--------------------------------------------------------------------------------------------------------------------------------------------------------------------------------------------------------------------------------------------------------------------------------------------------------------------------------------------------------------------------------------------------------------------------------------------------------------------------------------------------------------------------------------------------------------------------------------------------------------------------------------------------------------------------------------------------------------------------------------------------------------------------------------------------------------------------------------------------------------------------------------------------------------------------------------------------------------------------------------------------------------------------------------------------------------------------------------------------------------------------------------------------------------------------------------------------------------------------------------------------------------------------------------------------------------------------------------------------------------------------------------------------------------------------------------------------------------------------------------------------------------------------------------------------------------------|-----------------------------------------------------------------------------------------------------------------------------------------------------------------------------------------------------------------------------------------------------------------------------------------------------------------------------------------------------------------------------------------------------------------------------------------------------------------------------------------------------------------------------------------------------------------------------------------------------------------------------------------------------------------------------------------------------------------------------------------------------------------------------------------------------------------------------------------------------------------------------------------------------------------------------------------------------------------------------------------------------------------------------------------------------------------------------------------------------------------------------------------------------------------------------------------|

Information to User

Alteration or modifications carried out without appropriate authorization may invalidate the user's right to operate the equipment.

CAUTION: Be sure to use the shielded SCSI cables when connecting this equipment to other devices.

The Generation of Acoustical Noise is Less Than 70dB
(ISO7779/DIN45635)

[For Canadian model]

This Class B digital apparatus meets all requirements of the Canadian Interference-Causing Equipment Regulations.

[Pour le modèle Canadian]

Cet appareil numérique de la Classe B respecte toutes les exigences du Règlement sur le matériel brouilleur du Canada.

FEDERAL COMMUNICATIONS COMMISSION DECLARATION OF CONFORMITY

This device complies with part 15 of the FCC Rules. Operation is subject to the following two conditions: (1) This device may not cause harmful interference, and (2) this device must accept any interference received, including interference that may cause un-desired operation.

Product Name: MULTIFUNCTION OPTICAL DISK DRIVE SUBSYSTEM
Model Number: DE-SH9101
Responsible Party Name: PIONEER ELECTRONICS SERVICE, INC
Address: 1925 E. DOMINGUEZ ST. LONG BEACH, CA 90810 U.S.A.
Phone: (310) 952-2359

FOR ENGLAND

"This product complies with the Radio Interference requirements of the EC (European Community) Directive 87/308/EEC."

FOR GERMANY

"Dieses Produkt entspricht den Funkentstörvorschriften der EG (87/308/EEC)."

FOR FRANCE

"Cet article est conforme aux prescriptions de la directive communautaire de la CE nr. 87/308/EEC-(arrêté du 16/8/89) "

FOR ITALY

"Questo apparato è conforme al D M 13 Apr. 89 (Dir. 87/308/CEE) "

FOR SPAIN

"Este aparato cumple las normas para Interferencias de Radio establecidas por la Directriz de la CE (87/308/EEC)."

FOR PORTUGAL

"Este produto satisfaz às exigências das normas sobre interferências de rádio da Comunidade Económica Européia (87/308/EEC) "

FOR BELGIUM AND NETHERLANDS

"Dit produkt voldoet aan de radio-ontstoringsvoorschriften van de Richtlijn van de EG Raad (87/308/EEC)."

FOR DENMARK

"Dette produkt overholder det gældende EF-direktive no. 87/308/EEC vedr. radiostøj."

[For the product bearing the CE mark]

This product complies with the Low Voltage Directive (73/23/EEC), EMC Directives (89/336/EEC, 92/31/EEC) and CE Marking Directive (93/68/EEC).

[Pour le produit portant la marque CE]

Ce produit est conforme à la directive relative aux appareils basse tension (73/23/CEE), aux directives relatives à la compatibilité électromagnétique (89/336/CEE, 92/31/CEE) et à la directive CE relative aux marquages (93/68/CEE).

[Für das Produkt, das die CE-Markierung trägt]

Dieses Produkt entspricht den Niederspannungsrichtlinien (73/23/EEC), EMV-Richtlinien (89/336/EEC, 92/31/EEC) und den CE-Markierungsrichtlinien (93/68/EEC)

[Per il prodotto recante il marchio CE]

Questo prodotto è conforme alla direttiva sul basso voltaggio (73/23/CEE), alle direttive EMC (89/336/CEE, 92/31/CEE) e alla direttiva sul marchio CE (93/68/CEE).

[Voor een produkt voorzien van de CE markering]

Dit produkt voldoet aan de laagspanningsrichtlijn (73/23/EEC), de EMC-richtlijnen (89/336/EEC en 92/31/EEC) en de CE-markeringsrichtlijn (93/68/EEC).

[För produkt med CE-märkning]

Denna produkt uppfyller föreskrifterna i Lågspänningsdirektiv (73/23/EEC), EMC-direktiv (89/336/EEC, 92/31/EEC) och CE-märkningsdirektiv (93/68/EEC).

[Para el producto que lleva la marca de la CE]

Este producto cumple con la Directiva de Bajo Voltaje (73/23/CEE), Directivas EMC (89/336/CEE, 92/31/CEE) y Directiva de Marcación CE (93/68/CEE).

[Para produtos com a marca CE]

Este produto cumpre com a Directiva de Voltagem Baixa (73/23/CEE), Directivas EMC (89/336/CEE, 92/31/CEE) e com a Directiva da Marcação CE (93/68/CEE).

[For produktet som er CE mærket]

Dette produkt er i overensstemmelse med direktivet vedrørende lavspænding (73/23/EEC), direktiverne vedrørende elektromagnetisk kompatibilitet (89/336/EEC, 92/31/EEC) og CE-direktivet vedrørende mærkning (93/68/EEC)

This equipment has been tested and found to comply with the limits for a Class B digital device, pursuant to Part 15 of the FCC Rules. These limits are designed to provide reasonable protection against harmful interference in a residential installation. This equipment generates, uses, and can radiate radio frequency energy and, if not installed and used in accordance with the instructions, may cause harmful interference to radio communications. However, there is no guarantee that interference will not occur in a particular installation. If this equipment does cause harmful interference to radio or television reception, which can be determined by turning the equipment off and on, the user is encouraged to try to correct the interference by one or more of the following measures:

- Reorient or relocate the receiving antenna.
- Increase the separation between the equipment and receiver
- Connect the equipment into an outlet on a circuit different from that to which the receiver is connected
- Consult the dealer or an experienced radio/TV technician for help

CAUTION: USE OF CONTROLS OR ADJUSTMENTS OR PERFORMANCE OF PROCEDURES OTHER THAN THOSE SPECIFIED HEREIN MAY RESULT IN HAZARDOUS RADIATION EXPOSURE.

CAUTION: THE USE OF OPTICAL INSTRUMENTS WITH THIS PRODUCT WILL INCREASE EYE HAZARDS.

[FOR EUROPEAN AND U.K. MODELS]

The following caution label appears on your drive.

Location: bottom of the drive

CAUTION

This product contains a laser diode of a higher class than 1. To ensure continued safety, do not remove any covers or attempt to gain access to the inside of this product. Refer all servicing to qualified personnel.



FEATURES

- ① Can use both rewritable and WORM media of large capacity 1.7GB (using DEC-17GMO/DC-17GWO) and delivers high-speed data transfer.
- ② Interchangeable with former PIONEER models (DEC-702/DC-502A)
- ③ 1 Mbyte data buffer is implemented
- ④ Powerful error correction capability for bit error rate of less than 10^{-12} (when a PIONEER optical disk is used)
- ⑤ Long-life loading mechanism and dustproof construction for high reliability
- ⑥ Changer interface and Spindle control interface are implemented
- ⑦ Low power consumption
- ⑧ SCSI-2 command set is supported

PREPARATION

SETTING UP

Set the product on a level surface as shown in the figure. This product can be positioned vertically or horizontally, but in either case, be sure that it is oriented in the proper direction (see right figure). Please note that if the product is subjected to vibration, it might not yield adequate performance.

CONFIRMATION OF ACCESSORIES

The following accessories are supplied with this product.

- ① Power cord 1
- ② Plug converter 1
- ③ SCSI connector cover 2
- ④ Operating instructions 1
- ⑤ Manual eject screwdriver 1

NOTES:

The SCSI connector covers are attached to each of the SCSI connectors on the rear panel at the shipment

When both or one of the SCSI connector is vacant, it should be covered with SCSI connector cover to protect from electro-static discharge

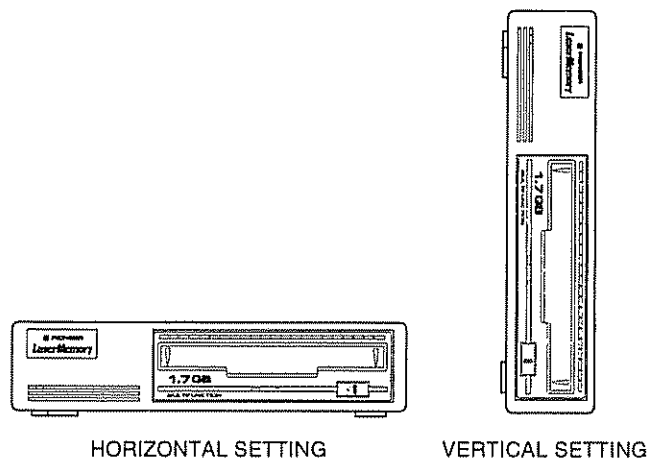

PREPARATION

Procedure for change when connecting a daisy chain configuration, and changing SCSI target ID.

This product can be linked to a maximum of eight units, including a plural number of host computers, by Daisy Chain connection.

Connection Examples

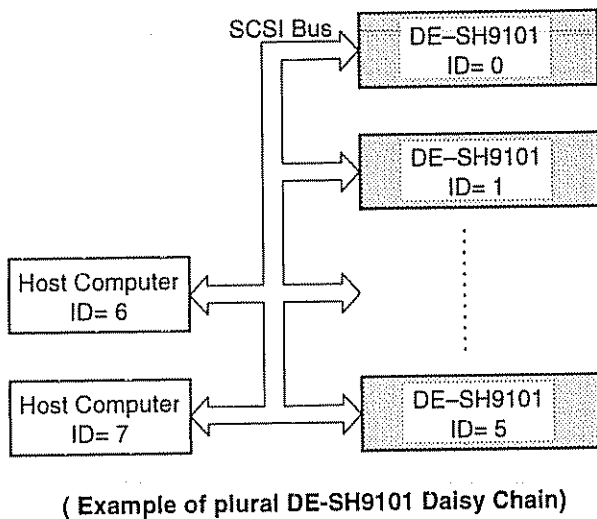
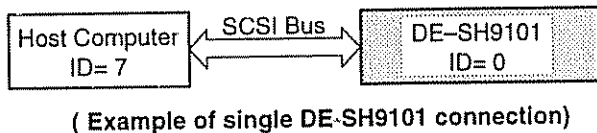

Before making or changing the connections, switch off the power switch and disconnect the power cord from the AC outlet.

1. How to change SCSI ID (See figure 1)

Set the rear panel SCSI ID switch ① to your desired ID. (See SCSI ID switch explanation below.)

NOTES:

- Sum total SCSI cable length should not exceed 6 meters (SCSI cable is sold separately.)
- Be sure not to assign the same target ID number to more than one unit.

2. SCSI ID switch ① explanation (See figure 2)

- Set the SCSI ID on this unit.
- Press the button to increment the SCSI ID (0, 1, ... 7) Press the button to decrement the SCSI ID (7, 6, ... 0). (Be sure to set to a SCSI ID between 0 and 7.)

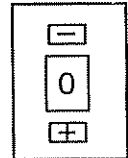

[Figure 2]

NOTE:

SCSI ID is set to "0" at the factory.

3. SCSI Bus Termination.

When this drive is linked at the end of SCSI daisy chain (ex. in left figure, ID = 0 drive is set in such a position), be sure to activate the drive's internal Terminator Resistor setting the bit 6 of DIP switch ② to OFF except the following case. In other cases, internal terminator shall be disable (bit 6 of DIP switch ② to OFF).

NOTE:

The internal Terminator Resistor is "Active Terminator" which is SCSI-2 recommendation.

When another end of SCSI daisy chain is terminated by "Passive Terminator" which conforms to SCSI-1 standard, It is recommended to use commonly sold "Passive Terminator Module" plugging into the vacant SCSI connector of the drive.

In such a case, the internal terminator shall be disabled (bit 6 of DIP switch shall be set to ON).

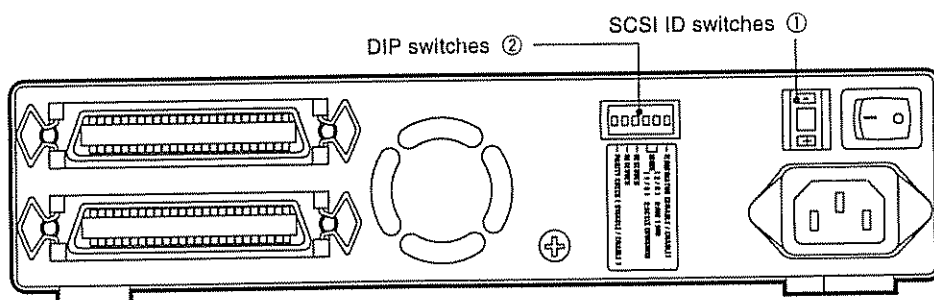

[Figure 1]

4. DIP switch ② explanation (See figure 3)

A. Parity check (bit 1)





This determines whether or not a parity check is performed on this unit's SCSI data bus. When it is set to OFF, a parity check is performed.

B. Reserved (RESERVED, bit 2): shall be set to OFF.

C. Reserved (RESERVED, bit 3): shall be set to OFF.

D. Mode switching (MODE, bits 4 and 5)

The unit refers to this bit setting to determine the operation mode to which the unit will be set after Power ON SCSI RESET.

MODE	Operation mode	Switch Setting
0	Rewritable mode	
1	WORM mode	
2	SCSI II mode Rewritable and WORM	
3	Reserved	

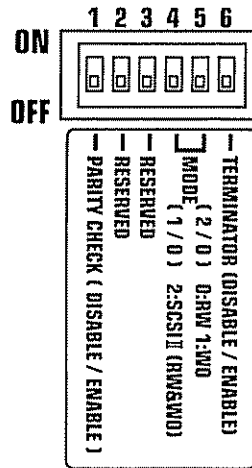

[Figure 3]

E. SCSI terminator (bit 6)

This determines whether or not the drive's internal terminator resistor is to be used.

When set to OFF, the internal terminal resistor can used.

NOTES:

- Mode can be switched by a SCSI command
- If there are no special instructions for bits 1 to 3 in the software instruction manual, use the factory settings (refer to figure 3).
- The internal terminator resistor is "Active Terminator" which is SCSI-2 recommendation. When another end of SCSI daisy chain is terminated by "Passive Terminator" which conforms to SCSI-1 standard, it is recommended to use commonly sold "Passive Terminator Module" plugging into the vacant SCSI connector of the drive. In such a case, the internal terminator shall be disabled (bit 6 of DIP switch shall be set to ON).

NAMES OF PARTS AND THEIR FUNCTIONS

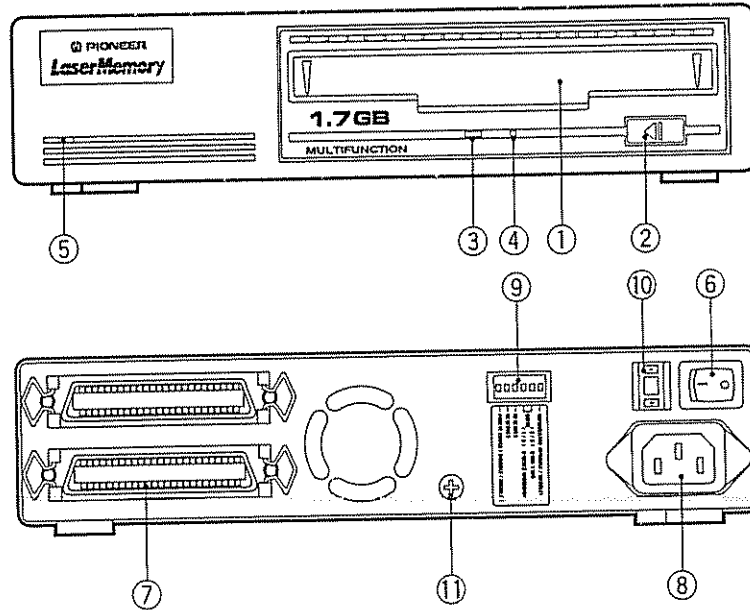

① Disk cartridge insertion door

Insert the disk cartridge into the door and gently push in until it loads.

② Eject switch

Press to eject the cartridge.

③ LED Indications

LED indications for each condition are as follows.

Mode	0	1	2
Drive Condition			
When there is no disk or inappropriate disk inserted	Green (blinking)	Yellow (blinking)	Green (blinking)
When a Rewritable disk is loaded	Goes out	Yellow (blinking)	Goes out
When a WORM disk is loaded	Green (blinking)	Goes out	Goes out
BUSY	Green (lights)	Yellow (lights)	Green (lights)
Overheated	Orange (fast blinking)	Orange (fast blinking)	Orange (fast blinking)

NOTE:

Rewritable disk : DEC-17GMO, DEC-702
 WORM disk : DC-17GWO, DC-502 A

④ Screwdriver hole for manual eject

When you want to manually eject the cartridge from the drive, insert the supplied screwdriver into the manual eject screwdriver hole, and while pressing, turn the screw counterclockwise about 30 times, and remove the cartridge.

NOTE:

When performing manual eject, be sure to switch power OFF

⑤ Power indicator

This lights when power is switched ON

⑥ Power switch

This switches power to the main unit ON and OFF

⑦ SCSI connector

Two SCSI amphenol 50 P connectors are implemented for daisy chain configuration connections. (Either one of the two connectors can be used)

NOTE:

When both or one of the SCSI connector is vacant, it should be covered with SCSI connector cover to protect from electro-static discharge

⑧ Power connector

Use the supplied AC power cord. If necessary, use supplied plug converter to mate with the wall socket.

CAUTION: AC power cable must be shielded for Radio Frequency Interference Suppression.

⑨ DIP switches

These determine various drive setting such as operation mode. (see page 13)

⑩ SCSI ID switch

Sets SCSI ID.

⑪ GND terminal

When earthing this unit, use this terminal

USAGE PRECAUTIONS

1. Do not expose the subsystem to shock or vibration during operation.
2. Do not connect or disconnect SCSI cable while the power is ON
3. Do not turn the power switch OFF or unplug the unit during drive execution
4. Use only specified optical disks.
5. Do not install this product into another maker's product, or install another maker's unit into this product
This product is not guaranteed if used under the above mentioned circumstances. Both products might be damaged irreparably.
6. Be sure to unload the cartridge when moving or transferring this product. The cartridge may be damaged beyond repair by strong jolts, etc.
7. Please use shielded SCSI cable, which is specified by PIONEER as standard products.

WHEN NOT IN USE, BE SURE TO EJECT THE DISK CARTRIDGE, IF YOU LEAVE IT IN THE MAIN UNIT, DIRT AND DUST MAY ACCUMULATE, LEADING TO FAULTY OPERATION.

TROUBLESHOOTING

If you think the product has malfunctioned, check the following points. Gross mistakes in operation of the product can cause malfunctions. Causes could also lie outside the product itself. Be sure to also check all other equipment being used with the product.

Symptom	Checkpoints
Cartridge cannot be loaded. (Go over the checkpoints carefully since pushing the cartridge forcefully can also cause breakdown.)	<ul style="list-style-type: none"> ● Has another cartridge already been loaded ? ● Has the cartridge been inserted in the proper direction ? ● Is the power switch at "ON" ? ● Has the power cord been connected to the outlet securely ? ● Disconnect the SCSI cable. Can the cartridge be loaded when power is supplied with a single DE-SH9101 ? If so, check the host system and/or the SCSI cable.
Cannot perform write or read	<ul style="list-style-type: none"> ● Has the write protect switch of the cartridge been set for "Read Only" status ? ● Has the cartridge been loaded properly ? ● Are you using a specified disk ? ● Has the SCSI cable been connected securely ? ● Are standard products being used with the SCSI cable ? ● Has the drive been placed on a level surface ? ● Is there error or overlap of SCSI target ID ? ● The trouble could be caused by condensation forming on the optical parts and/or the disk. Allow the product to stand idle for about 1 to 2 hours, then try using it again.

If the trouble cannot be rectified even after exercising the checks listed above, ask your nearest PIONEER authorized service center to check your product.

SPECIFICATIONS

- Loading system: Front loading
- Interface: SCSI-2*
- Rotational speed:
 - 2700 rpm, ZCAV (When using DEC-17GMO/DC-17GWO)
 - 2400 rpm, CAV (When using DEC-702/DC-502A)
- Bit error rate: Less than 10^{-12} (When using PIONEER optical disks)
- Power requirements: AC 100-240 V, 50/60 Hz
- Power consumption: 46 W max, 0.7 A max
- Dimensions: Refer to the figure of dimensions
- Weight: 3.5 kg
- Available positioning: Horizontal
- Environmental conditions
 - Operating temperature: +5 ~ +40°C (+40°F ~ +104°F)
 - Operating humidity: 10% ~ 80% RH (no condensation)
 - Storage temperature: -20°C ~ +50°C (+4°F ~ +122°F)
 - Storage humidity: 10% ~ 90% RH (no condensation)

● Specifications and design are subject to possible modifications without notice, due to improvements.

* SCSI Small Computer System Interface

The drawing shows the external features of the DE-SH9101

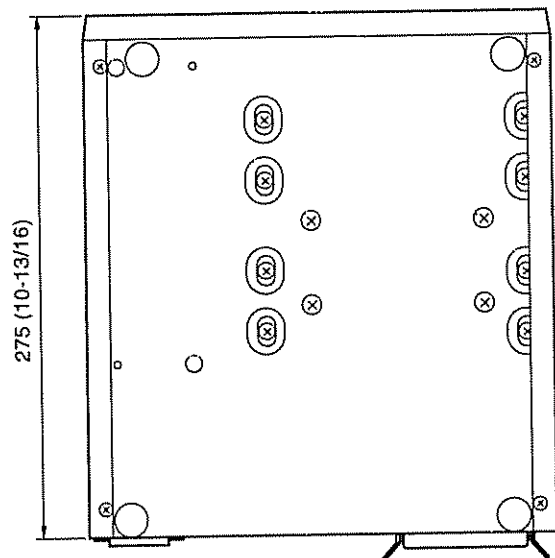
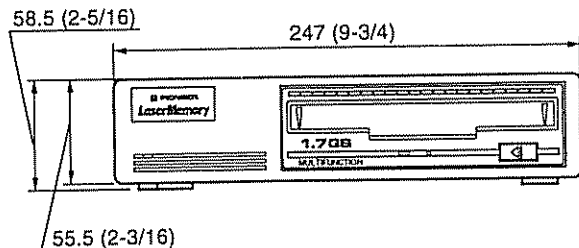

unit: mm (in.)

MAINTENANCE OF EXTERNAL SURFACES

- Use a polishing cloth or a dry cloth to wipe off dust and dirt
- When the surfaces are very dirty, wipe with a soft cloth dipped in some neutral cleanser diluted five or six times with water, and wrung out well, and then wipe again with a dry cloth. Do not use furniture wax or cleaners.
- Never use thinner, benzine, insecticide sprays and other chemicals on or near this unit, since these will corrode the surfaces.

Published by Pioneer Electronic Corporation
 Copyright © 1995 Pioneer Electronic Corporation
 All rights reserved

France : tapez 36 15 PIONEER



この取扱説明書はエコマーク認定の再生紙を使用しています。

Published by Pioneer Electric Corporation
Copyright © 1995 Pioneer Electronic Corporation
All rights reserved

© 1995 パイオニア株式会社 禁無断転載



パイオニア株式会社

〒153 東京都目黒区目黒1丁目4番1号

PIONEER ELECTRONIC CORPORATION

Industrial and Business Products Merchandising Division: 4-1, Meguro 1-Chome, Meguro-ku, Tokyo 153, Japan

PIONEER NEW MEDIA TECHNOLOGIES, INC.

Laser Optical Systems Division: 2265 East 220th Street, Long Beach, CA 90810, U S A. TEL:800-444-OPTI (6784)

PIONEER ELECTRONIC [EUROPE] N.V. Haven 1087, Keetberglaan 1, 9120 Melsele, Belgium TEL: +32-3-570-0511

PIONEER ELECTRONICS OF CANADA, INC.

Industrial Products Department: 300 Allstate Parkway, Markham, Ontario L3R 0P2, Canada TEL: 905-479-4411

PIONEER ELECTRONICS AUSTRALIA PTY. LTD. 178-184 Boundary Road, Braeside, Victoria 3195, Australia TEL:+61-3-586-6300

PIONEER ELECTRONICS ASIACENTRE PTE. LTD. 501 Orchard Road, #10-00, Lane Crawford Place, Singapore 0923

TEL: +65-735-9011 FAX: +65-735-9022

<99J00DF2C07>

Printed in Japan/Imprimé au Japon <ORM1057-C>

Free Manuals Download Website

<http://myh66.com>

<http://usermanuals.us>

<http://www.somanuals.com>

<http://www.4manuals.cc>

<http://www.manual-lib.com>

<http://www.404manual.com>

<http://www.luxmanual.com>

<http://aubethermostatmanual.com>

Golf course search by state

<http://golfingnear.com>

Email search by domain

<http://emailbydomain.com>

Auto manuals search

<http://auto.somanuals.com>

TV manuals search

<http://tv.somanuals.com>