

Pioneer

DVD PLAYER

DV-344

DV-233

Operating Instructions



IMPORTANT



The lightning flash with arrowhead symbol, within an equilateral triangle, is intended to alert the user to the presence of uninsulated "dangerous voltage" within the product's enclosure that may be of sufficient magnitude to constitute a risk of electric shock to persons.

CAUTION

**RISK OF ELECTRIC SHOCK
DO NOT OPEN**

CAUTION:

TO PREVENT THE RISK OF ELECTRIC SHOCK, DO NOT REMOVE COVER (OR BACK). NO USER-SERVICEABLE PARTS INSIDE. REFER SERVICING TO QUALIFIED SERVICE PERSONNEL.



The exclamation point within an equilateral triangle is intended to alert the user to the presence of important operating and maintenance (servicing) instructions in the literature accompanying the appliance. **H002_En**

WARNING: THE APPARATUS IS NOT WATERPROOFS, TO PREVENT FIRE OR SHOCK HAZARD, DO NOT EXPOSE THIS APPLIANCE TO RAIN OR MOISTURE AND DO NOT PUT ANY WATER SOURCE NEAR THIS APPARATUS, SUCH AS VASE, FLOWER POT, COSMETICS CONTAINER AND MEDICINE BOTTLE ETC.

H001AEn

WARNING: BEFORE PLUGGING IN THE UNIT FOR THE FIRST TIME, READ THE FOLLOWING SECTION CAREFULLY. THE VOLTAGE OF THE AVAILABLE POWER SUPPLY DIFFERS ACCORDING TO COUNTRY OR REGION, BE SURE THAT THE POWER SUPPLY VOLTAGE OF THE AREA WHERE THIS UNIT WILL BE USED MEETS THE REQUIRED VOLTAGE (E.G., 230V OR 120V) WRITTEN ON THE REAR PANEL.

H041 En

CAUTION:

THE STANDBY/ON BUTTON IS SECONDARY CONNECTED AND THEREFORE DOES NOT SEPARATE THE UNIT FROM MAINS POWER IN STANDBY POSITION. THEREFORE INSTALL THE UNIT SUITABLE PLACES EASY TO DISCONNECT THE MAINS PLUG IN CASE OF THE ACCIDENT. THE MAINS PLUG OF UNIT SHOULD BE UNPLUGGED FROM THE WALL SOCKET WHEN LEFT UNUSED FOR A LONG PERIOD OF TIME.

H017BEn

CAUTION

This product contains a laser diode of higher class than 1. To ensure continued safety, do not remove any covers or attempt to gain access to the inside of the product.

Refer all servicing to qualified personnel.

The following caution label appears on your unit.

Location: rear of the unit



H018

On the bonnet of the unit.

CAUTION : VISIBLE AND INVISIBLE LASER RADIATION WHEN OPEN. AVOID EXPOSURE TO BEAM.
VORSICHT : SICHTBARE UND UNSICHTBARE LASERSTRAHLUNG. WENNABDECKUNG GEÖFFNET NICHT DEM STRAHL AUSSETZEN!
ADVARSEL : SYNLIG OG USYNLIG LASERSTRÅLING VED ÅBNING UNDGÅ UDSÆTTELSE FOR STRÅLING.
VARNING : SYNLIG OCH OSYNLIG LASERSTRÅLNING NÄR DENNA DEL ÄR ÖPPNAD. BETRÄKTA EJ STRÅLEN.
VARO! : AVATTAESSA ALTISTUT NÄKYVÄ JA NÄKYMÄTTÖMÄLLE LASERSATEIL YLLE. ÄLÄ KATSO SÄTEESEN.
CUIDADO : RADIACIÓN LASER VISIBLE E INVISIBLE AL ESTAR ABIERTO. EVITAR EXPOSICIÓN AL RAYO.

VRW1872

CONGRATULATIONS ON YOUR PURCHASE OF THIS FINE PIONEER PRODUCT.

Pioneer is on the leading edge of DVD research for consumer products and this unit incorporates the latest technological developments.

We are sure you will be fully satisfied with the DVD player.

Thank you for your support.

Please read through these operating instructions so you will know how to operate your model properly. After you have finished reading the instructions, put them away in a safe place for future reference.



- This player is not suitable for commercial use.

This product incorporates copyright protection technology that is protected by method claims of certain U.S. patents and other intellectual property rights owned by Macrovision Corporation and other rights owners. Use of this copyright protection technology must be authorized by Macrovision Corporation, and is intended for home and other limited viewing uses only unless otherwise authorized by Macrovision Corporation. Reverse engineering or disassembly is prohibited.

Features of This Player

Compatible with DVD, Video CD and CD formats

DVD, Video CD and CD discs that display the logos shown below can be played back on PIONEER DVD players. For more information on discs compatible with this player, refer to the table below.

Types of playable discs and their marks	Diameter/ Playable sides	Playback time	
 	DVD VIDEO	Digital audio Digital video (MPEG 2)	
	12 cm/ single-sided	1 layer 2 layer	133 min. 242 min.
	12 cm/ double-sided	1 layer 2 layer	266 min. 484 min.
	DVD VIDEO		
	8 cm/ single-sided	1 layer 2 layer	41 min. 75 min.
	8 cm/ double-sided	1 layer 2 layer	82 min. 150 min.
	VIDEO CD	Digital audio Digital video (MPEG 1)	
	12 cm/ single-sided		Max. 74 minutes
	VIDEO CD single	Digital audio Digital video (MPEG 1)	
	8 cm/ single-sided		Max. 20 minutes
  	CD		Digital audio
	12 cm/ single-sided		Max. 74 minutes
	CD single		Digital audio
	8 cm/ single-sided		Max. 20 minutes

The disc format logos shown above are found on disc labels or on disc jackets.

- To prevent malfunction, do not use an 8 cm (3 in.) adaptor (for CDs).
- Discs other than the ones indicated above cannot be played on this unit.
- DVDs that have incompatible region numbers, DVD-Audio, DVD-ROM, and CD-ROM cannot be played on this unit. The region number of the player can be found on the rear panel.

*1 Playing recordable CDs

- Note that this unit cannot record onto recordable discs.
- This unit can play music-use CD-R and CD-RW discs. However, depending on the condition of the player and the disc, you may find that not all discs will play successfully. (For example, if the disc is scratched or dirty, or if the player's pickup lens is dirty.)

Compatible with a wide range of DVD digital audio output formats



DVDs are recorded in one of four types of digital audio formats (as of October 1998). The digital audio output jacks of this player output Dolby Digital^{*2}, DTS^{*3}, MPEG, and linear PCM digital bitstreams.

This player has a function that converts Dolby Digital and MPEG audio formats into the linear PCM format. This allows playback of DVDs recorded in Dolby Digital and MPEG without the need for a decoder.

Easy setup and adjustment using on-screen menus

Press **SETUP** on the remote control to open the Setup screen and you'll find setting up and adjusting the system easy to do with on-screen menus conveniently organized and arranged. Additionally, on-screen information (i) appears to clarify the functions and explain the options available. Below are just a few examples.

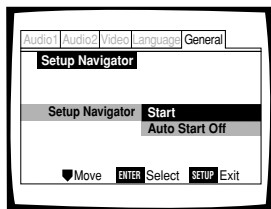

Answer a few questions and have all the necessary audio, video, and on-screen language adjustments set automatically by the player using the Setup Navigator (pages 17, 18).

Select the type of TV screen you are using and the preferred screen format you'd like to use when watching DVDs in the **Video** menu (page 28).

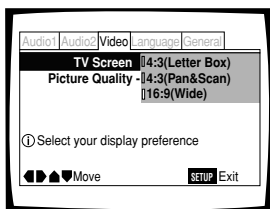

* The on-screen information (i) only appears if you choose **[English]** as the **[OSD Language]** (pages 18, 31).

While using the Setup Navigator, no on-screen information (i) is displayed.

*2 Manufactured under license from Dolby Laboratories. "Dolby" and the double-D symbol are trademarks of Dolby Laboratories. Confidential unpublished works. © 1992-1997 Dolby Laboratories. All rights reserved.

*3 "DTS" is a trademark of Digital Theater Systems, Inc.

Wide range of DVD viewing options

Multi-Angle (page 30)☆

You can view scenes from different camera angles when watching movies or other media with multiple angle playback available.

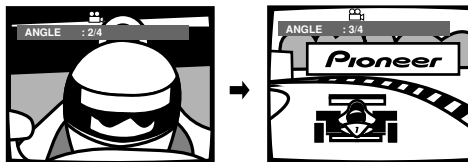

Multiple Languages (page 31)☆

You can select the language on when watching movies or other media that have multiple language and/or audio soundtracks recorded on them.

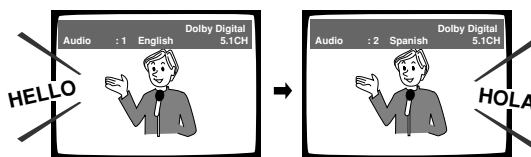

Multi-Language Subtitles (page 33)☆

You can select a subtitle language or turn subtitles off when watching movies or other media with subtitles available.

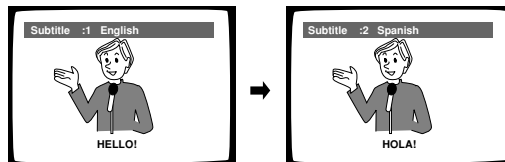

☆This mark indicates this may not be possible with certain discs.

Energy-saving design

This unit is designed to use less than 1 W of energy when this player is in standby mode.

Differences in Disc Composition

DVD

DVDs are divided into units referred to as titles, and titles are divided into chapters. A DVD which contains a movie may have only one title with many or no chapter divisions. Karaoke DVDs may have many titles, assigning a title to each song on the disc. Menu screens do not belong to any title.

DVD player functions generally apply to titles on a disc or chapters within a selected title. The player functions available may also vary from title to title, depending on the disc. When discs have a unique title division, it should be noted that search and program functions may be affected.

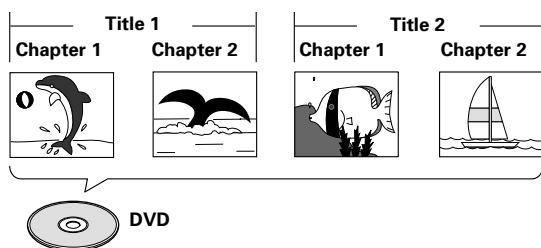

Video CD/CD

Video CDs and CDs are divided into units referred to as tracks (Video CD tracks may also be referred to as scenes). One song generally corresponds to one track. Some tracks are further divided into units referred to as indexes. Video CDs with PBC (Playback Control) also contain menus recorded on the disc which enable easy access to the contents of the disc.

When played back on a DVD player, both Video CDs and CDs are considered to be a single title, regardless of the number of tracks.

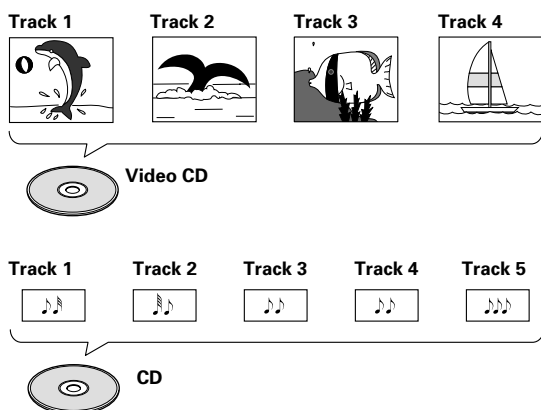

How to Proceed in This Manual

DVD is an incredible format that presents the highest quality digital audio and video available today. The amount of information that can be recorded onto a DVD disc is remarkable, allowing it to offer numerous functions and features available with no other format.

Because using the DVD player and DVDs may be confusing at first, following the order below should help you get through the important stages of getting set up so you can start using your player as soon as possible.

Get familiar with the player.

Refer to the section *"Before Using"* on **page 8** to confirm that all the accessories were included with the player. If you are new to DVD, it might be beneficial for you to go through the *"Names and Functions"* section starting on **page 9** to get familiar with the parts and buttons on the main unit and remote control as they will be referred to throughout this manual.

There is also a list of terms that can be found on **page 54** if you are having trouble understanding some of the terminology associated with DVD.

Make the necessary connections.

No entertainment system seems to be set up exactly the same way. The *"Making Connections"* section starting on **page 14** shows how video and audio connections may be made to suit your home entertainment system.

Set up the necessary player menus.

Before you can begin to enjoy the benefits of the DVD format, it is first necessary to set up the player to output the video and audio information that corresponds to your system. The section *"Setting Up the Player"* starting on **page 17** explains how to use the Setup Navigator, a function that automatically sets up the player corresponding to the answers given in a multiple-choice on-screen procedure. The Setup screen menus, described in the section starting on **page 24**, are also used in a number of other functions. Learning the procedure for operating these menus will make using this player much easier and more enjoyable.

Play a disc.

When all the connections and setups have been made, you are ready to play a DVD, Video CD, or CD with the player. The section *"Getting Started Using Your DVD Player"* starting on **page 20** outlines the basic player operations.

Enjoy the many features available.

Once you are comfortable using the basic player functions, you are ready to take advantage of the various options DVD and this player have to offer. The section *"Advanced Functions"* starting on **page 36** describes how to use the features available on many DVDs.

Table of contents

Before Using 8

- Checking Accessories 8
- Preparing the Remote Control 8

Names and Functions 9

- Front Panel 9
- Display Window 10
- Rear Panel 11
- Remote Control 12

Making Connections 14

- Connecting Your DVD Player 14
- Audio Connections 15
- Video Connections 16
- System Control Connections 16

Setting Up the Player 17

- Setting the TV System 17
- Using the Setup Navigator 17

Getting Started Using Your DVD Player 20

- Playing DVDs, Video CDs and CDs 20
- Chapter (Track) Skip Forward/Skip Back 22
- Forward and Reverse Scanning 22
- Resuming Playback from Where You Stopped 23
- Stopping Playback and Switching Power Off 23

Adjusting Audio and Video Settings 24

- Using the Setup Screen Menus 24
- Changing to the Setup Screen
“Expert” Menu Mode 25
- Setting the Digital Audio Output to Be
Compatible with Your AV Component 26
- Adjusting the Dynamic Range of the Audio
Soundtrack 27
- Setting the TV Screen Size 28
- Selecting Picture Quality Appropriate for
Program Content 29
- Switching the S-Video Output 29
- Selecting the Type of Paused Image to Display
..... 29
- Setting the Position of the On-screen Display
..... 29
- Viewing from a Desired Camera Angle
(Multi-Angle) 30

Setting the Language Options 31

- Setting the On-screen Display (OSD) Language
..... 31
- Changing the Audio Language
(Multi-Language Function) 31
- Selecting a Subtitle Language
(Multi-Language Subtitles) 33

Advanced Functions 36

- Setting the Parental Lock Level 36
- Changing the Background Color of the Screen
..... 37
- Still Frame/Slow Play/Frame Advance Playback
..... 38
- Searching for a Title, Chapter, Track, or Location
on a Disc 39
- Repeat Play 40
- Random Play 41
- Playback in a Desired Order (Program Play)
..... 42
- Continuing Playback from a Specified Location
(Last Memory) 45
- Memorizing Settings for Often Viewed DVDs
(Condition Memory) 46
- Viewing Disc Information 47
- Resetting the Player to System Settings 48

Additional Information 49

- Disc Care 49
- For Proper and Long Use of This Unit 50
- Language Code List 51
- Troubleshooting 52
- Terms 54
- Specifications 55

Before Using

Checking Accessories

Please confirm that the following were received with the player.

Audio cord

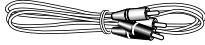

Video cord



Power cord

Central and South American model: 2
Other models : 1



Remote control unit

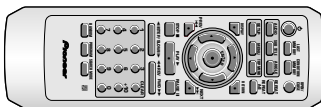

AA(R6P) dry cell batteries

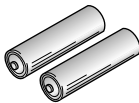

When disposing of used batteries, please comply with governmental regulations or environmental public instruction's rules that apply in your country or area. H048 En

Operating instructions (this manual)

Preparing the Remote Control

Inserting batteries into the remote control

- 1 While pushing the tab on the battery compartment cover toward the center of the remote, pull out in the direction indicated by the arrow.

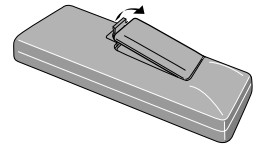

- 2 Insert batteries.

Make sure to match the plus (+) and minus (-) polarity guides on the batteries with the marks inside the battery compartment.

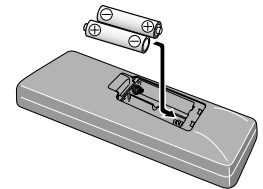

- 3 Close the cover.

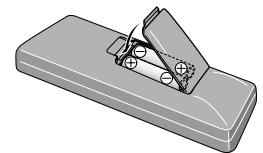

Notes

- Do not mix old and new batteries.
- When replacing batteries, use all new batteries.
- When not using the remote control for a long period of time (over 1 month), remove the batteries to avoid possible damage from battery corrosion. If battery leakage occurs, wipe the battery liquid from the battery component, then insert new batteries.

Remote control operation

When operating the remote control, point it at the remote sensor (SR) located on the player's front panel. The remote control can be used up to 7 m from the player and within a 30° angle on each side of the sensor.

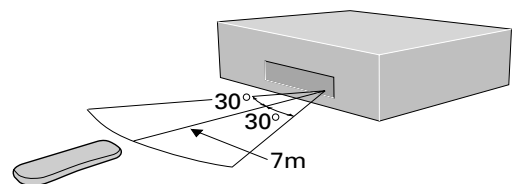

Notes

- Exposing the remote sensor to direct sunlight or strong light may cause faulty operation.
- If the **CONTROL IN** jack on the player's rear panel is connected to the **CONTROL OUT** jack of another component, point the remote control at the other component to operate the player. Operation will not be possible when pointed at this player (page 16).

Names and Functions

Front Panel

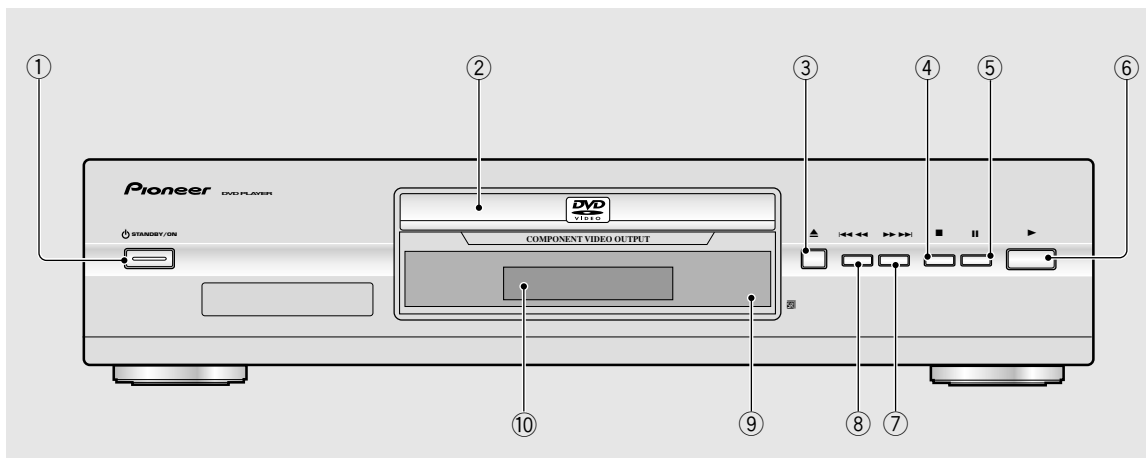

① **⏻ STANDBY/ON button**

Press to switch the player on or to put in standby (pages 20, 23).

② **Disc tray**

When loading a disc, place discs in the disc tray with the label side facing up (pages 20, 23).

③ **▲ (open/close) button**

Press to open and close the disc tray (pages 20, 23).

④ **■ (stop) button**

Press to stop playback. Pressing once enables playback to resume from a point shortly before the location where it stopped. Pressing twice causes the disc to return to the beginning of the disc if playback starts again (page 23).

⑤ **⏸ (pause) button**

Press during playback to pause. Press again to resume playback (page 38).

⑥ **▶ (play) button**

Press to start or resume playback (pages 20, 23).

⑦ **▶▶▶▶ (forward) button**

Press to advance to chapters/tracks. Press and hold to perform fast-forward scanning (page 22).

⑧ **◀◀◀◀ (reverse) button**

Press to go back to previous chapters/tracks. Press and hold to perform reverse playback scanning (page 22).

⑨ **Remote sensor**

Point the remote control toward the remote sensor to operate the player (page 8).

⑩ **Display window**

Displays system information (page 10).

Display Window

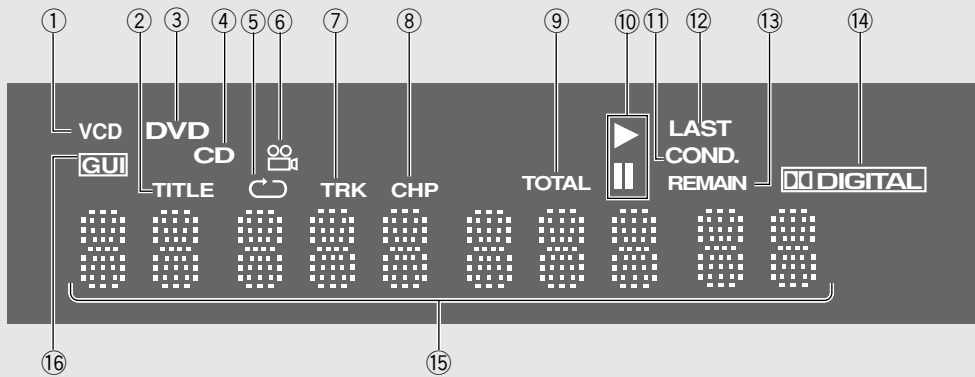

- ① **VCD indicator**
Lights when a Video CD is loaded.
- ② **TITLE indicator**
Indicates a title number is being displayed.
- ③ **DVD indicator**
Lights when a DVD is loaded.
- ④ **CD indicator**
Lights when an audio CD is loaded.
- ⑤ **↻ indicator**
Indicates that the Repeat function is on and that the current title, chapter, or track is being repeated (**page 40**).
- ⑥ **🎬 indicator**
Indicates Multi-Angle playback is in progress (**page 30**).
- ⑦ **TRK indicator**
Indicates a track number is being displayed.
- ⑧ **CHP indicator**
Indicates a chapter number is being displayed.
- ⑨ **TOTAL indicator**
Indicates that the disc in the player is stopped and **DISPLAY** has been pressed (**page 48**).
- ⑩ **▶/|| indicator**
▶ lights when any disc is playing. When a disc is paused, || lights.
- ⑪ **COND. indicator**
Indicates that Condition Memory settings are memorized for the currently loaded DVD (**page 46**).
- ⑫ **LAST indicator**
Indicates the Last Memory location is recorded in memory for the currently loaded DVD or Video CD (**page 45**).
- ⑬ **REMAIN indicator**
Indicates that the remaining playback time of a title or chapter/track is being displayed.
- ⑭ **🔊 DIGITAL indicator**
Indicates Dolby Digital audio playback.
- ⑮ **Counter display**
Displays the playback mode, type of disc, title and chapter/track numbers, playback time, etc.
- ⑯ **GUI indicator**
Indicates an on-screen menu operation is being performed (**pages 18, 24**).

Rear Panel

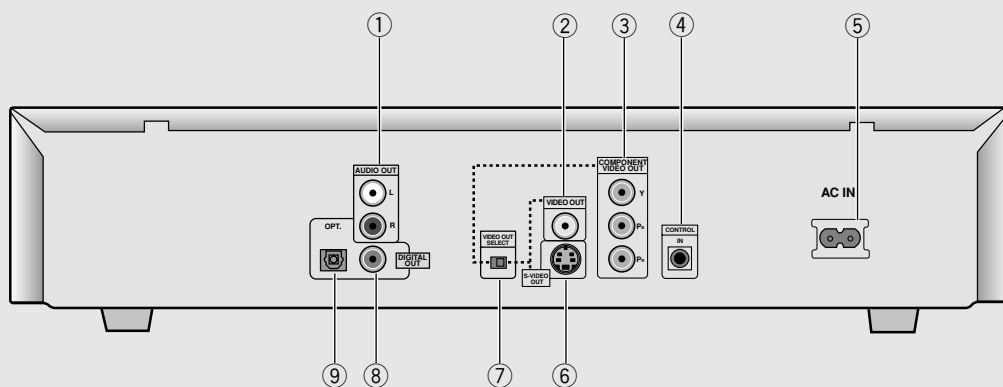

① AUDIO OUT jacks

Use to output two-channel audio (analog) to the audio stereo inputs on a TV or stereo amplifier. If you are connecting to a receiver that has both digital and analog input jacks for DVD player connection, it may be beneficial to make both connections (**pages 14, 15**).

② VIDEO OUT jack

Connect to the video input on a TV or monitor or AV amplifier or receiver with video input capability. When using this output, be sure to set **VIDEO OUT SELECT** to the right position (**pages 14, 16**).

③ COMPONENT VIDEO OUT jacks

If your TV or monitor has component video inputs, you can produce a higher quality picture on your TV or monitor by connecting to the component video outputs on this unit. When using these jacks, be sure to set **VIDEO OUT SELECT** to the left position (**page 16**).

④ CONTROL IN jack

Use to connect this player to another component bearing the Pioneer **SR** mark. This lets you control this unit as though it were a component in a system. Player operations are then performed by pointing the remote control at the component that the player is connect to (**page 16**).

⑤ AC IN power cord connection terminal

Use to connect the power cord to the wall outlet (**page 14**).

⑥ S-VIDEO OUT jack

If your TV or monitor has an S-video input, clear picture reproduction is possible by connecting the player to your TV or monitor via the S-Video jack. When using this output, be sure to set **VIDEO OUT SELECT** to the right position (**page 16**). You can switch between **[S1]** and **[S2]** S-video output from the Setup menu (**page 29**).

⑦ VIDEO OUT SELECT switch

Use to set which output is used to output the video signals. Select either video/S-video or component video signal output depending on the connections you make (**page 16**).

⑧ DIGITAL OUT jack (coaxial)

Use to output the digital audio signal recorded on discs. You can output the digital signal via either coaxial output jack to an AV amplifier or receiver (**page 15**).

⑨ DIGITAL OUT jack (optical (OPT.))

Use to output the digital audio signal recorded on discs. You can output the digital signal via either optical output jack to an AV amplifier or receiver (**page 15**).

Remote Control

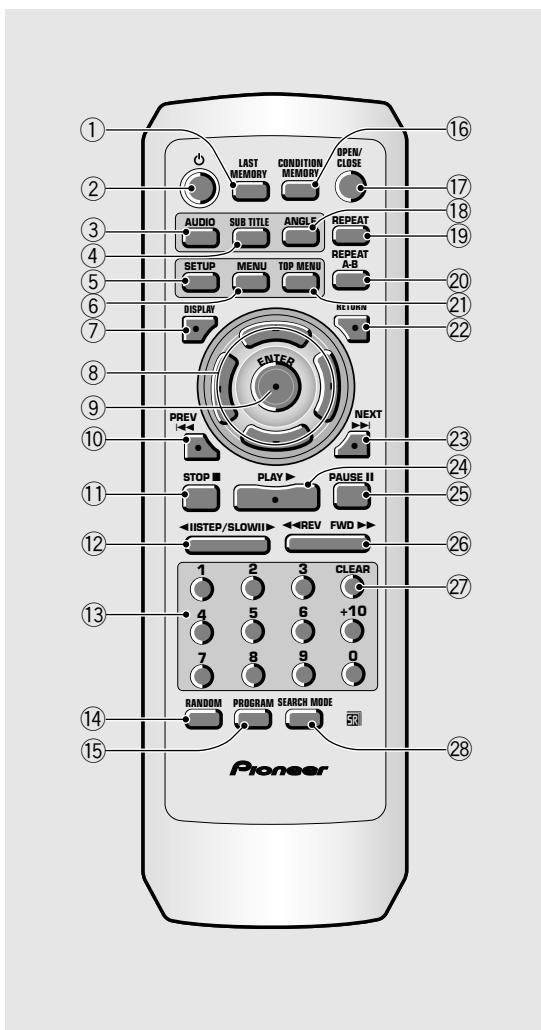

(Buttons indicated with * are used for menu operation.)

① **LAST MEMORY button**

You can resume DVD or Video CD playback from the point you last watched even if the disc is removed from the player. Press **LAST MEMORY** during playback to set a Last Memory point. When you want to resume playback of that disc, press **LAST MEMORY** in the stop mode and playback starts from the memorized point. Last Memory locations can be stored for up to 5 DVDs and 1 Video CD (**page 45**).

② **⏻ (standby/on) button**

Press to switch the player on or to put in standby (**pages 20, 23**).

③ **AUDIO button**

Press repeatedly to select one of the audio languages and/or audio formats programmed on a DVD (**pages 31, 32**).

For Video CD and CD, each press changes the audio output as follows.

→ Stereo → 1/L (Left) → 2/R (Right) →

④ **SUBTITLE button**

Press repeatedly to select one of the subtitle languages programmed on a DVD or to turn the subtitles off (**page 33**).

⑤ **SETUP button***

Press when the player is in either play or stop mode to open and close the Setup screen (**pages 18, 24**).

⑥ **MENU button***

Use to display or close the DVD menu screen (**page 21**).

⑦ **DISPLAY button**

Press during playback to display statistical disc information. Press repeatedly to display different information (**page 47**).

⑧ **Cursor buttons (◀/▶/▲/▼)***

Use to move through the options on menu screens and to change settings.

⑨ **ENTER button***

Use to implement settings selected with the cursor buttons or to set items highlighted in a menu.

⑩ **PREV ◀◀ button (previous)**

During playback, press **PREV ◀◀** to go back to a previous chapter/track (**page 22**).

⑪ **STOP ■ button**

Press to stop playback. Pressing once enables playback to resume from a point shortly before the location where it was stopped. Pressing twice causes the disc to return to the beginning of the disc when playback starts again (**page 23**).

- ⑫ **STEP/SLOW ◀II/II▶ buttons**
 Press **STEP/SLOW II▶** during playback to view slow playback. In pause mode, press **STEP/SLOW II▶** to advance DVDs and Video CDs frame by frame and **STEP/SLOW ◀II** to back up a few frames at a time (page 38).
- ⑬ **Number buttons (1-9, 0, +10)***
 Use to perform direct title and chapter/track searches, and to input numerical values.
- ⑭ **RANDOM button**
 Press to play chapters/tracks in random order (page 41).
- ⑮ **PROGRAM button**
 You can program titles, chapters, or tracks to play back in a desired order. Programs can be a maximum of 24 steps. Additionally, DVD programs for up to 24 discs can be stored in the player's memory for future use (pages 42-44).
- ⑯ **CONDITION MEMORY button**
 You can store in memory the settings for up to 15 DVDs. Press **CONDITION MEMORY** during DVD playback to memorize the settings (page 46).
- ⑰ **OPEN/CLOSE button**
 Press to open or close the disc tray (pages 20, 23).
- ⑱ **ANGLE button**
 Some DVDs are recorded with various camera angle playback options. Press **ANGLE** repeatedly to display different camera angles (page 30).
- ⑲ **REPEAT button**
 Press once to repeat playback of current chapter/track. Press twice to repeat playback of current title (page 40).
- ⑳ **REPEAT A-B button**
 Press at the beginning and end of the section you want to repeat or to mark a location you want to return to (page 40).
- ㉑ **TOP MENU button***
 Press to call up the top menu programmed on the DVD. Depending on the DVD, the top menu may be identical to the DVD menu (page 21).
- ㉒ **RETURN button***
 Use to go one menu back (current settings are maintained). Use **RETURN** when you do not want to change the option setting in a menu.
- ㉓ **NEXT ▶▶I button**
 During playback, press **NEXT ▶▶I** to advance to the next chapter/track (page 22).
- ㉔ **PLAY ▶ button**
 Press to start disc playback (pages 20, 23).
- ㉕ **PAUSE II button**
 Press to pause playback of a disc. Press again to resume playback (page 38).
- ㉖ **REV◀◀/FWD▶▶ (fast reverse/forward) buttons**
 During playback of DVD and Video CD, press **FWD▶▶** to perform fast forward scanning. Press **REV◀◀** to perform fast reverse scanning of DVD and Video CD. When a CD is loaded, audio scanning is performed (page 22).
- ㉗ **CLEAR button**
 Works in conjunction with a number of player functions. Use to cancel repeat and random playback, and to edit programs.
- ㉘ **SEARCH MODE button**
 Press to perform a title, chapter/track or elapsed time search (page 39).

Making Connections

Connecting Your DVD Player

Unlike any other audiovisual media format, DVD offers a wide array of audio and video output options which allows playback to be enjoyed in any number of system configurations from a standard TV with stereo audio input to a home theater system with a TV or monitor and full surround sound capabilities.

Connection Guide

The illustration on this page shows the basic setup using the audio and video cords included with this player. Use this illustration as a guide to setting up your home system.

An explanation of each type of audio and video connection available can be found on **pages 15 to 16**. To determine the best audio and video connection setup for your system, refer to the manuals supplied with the components you are making connections to.

In addition to making physical connections to your TV or monitor, it is also necessary to assign the TV screen size. You can use the **[Setup Navigator]** in the Setup screen **General** menu to set whether you are using a wide screen or standard size TV or monitor (**page 18**).

Additionally, you can use the **[TV Screen]** setting in the Setup screen **Video** menu (**page 28**).

Notes

- When making connections to this unit or when changing connections, check that the unit is off by pressing **STANDBY/ON** and unplug the power cord from the power outlet.
- The analog video output on this player uses copy protect circuitry to prevent the video playback on DVDs from being copied. If you connect the player to a TV via a VCR, or record and play back the contents of a disc with a VCR, the playback picture may not be normal.

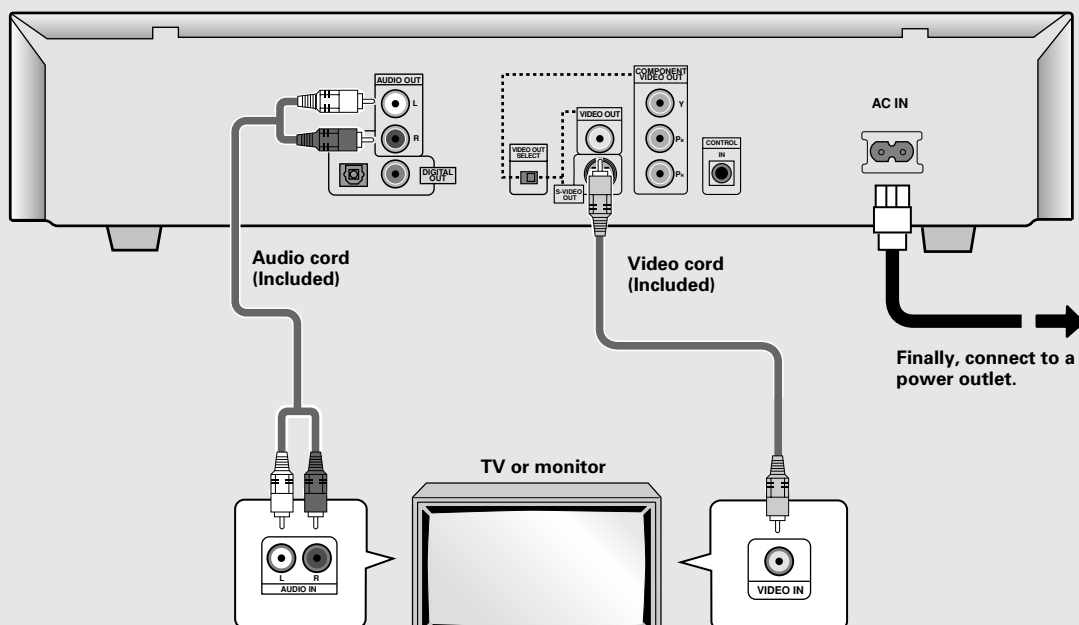

Make audio connections from the **AUDIO OUT** jacks on the player to the **AUDIO IN** jacks on the TV or monitor using the stereo audio cord included with the player. Be sure to match the color of the plugs with the color of the jacks (red and white).

Make video connections from the **VIDEO OUT** jacks on the player to the **VIDEO IN** jack on the TV or monitor using the video cord included with the player. Set the **VIDEO OUT SELECT** to the right position.

Audio Connections

This player features two digital (optical and coaxial) and also analog audio output formats.

Digital Audio Connections

You can enjoy the digital audio recorded on DVD discs from both optical digital and coaxial digital output jacks.

When making digital audio connections, do not make connections from both the coaxial and optical digital outputs to the same component.

When a DVD recorded in Dolby Digital, DTS, or MPEG is loaded, noise will be output if you have made connections via the digital audio jacks to a receiver or amplifier that cannot decode a Dolby Digital, DTS, or MPEG digital bitstream. In this case, be sure to set up the Setup Navigator audio settings to best reflect the type of system you are using (page 19). Additionally, the digital audio settings can be adjusted manually in the Setup screen **Audio 1** menu (pages 26-27).

DIGITAL OUT (Optical)

The digital signal is transmitted as light pulses through a fiber-optic cable.

- Use to connect to an AV amplifier or receiver with built-in Dolby Digital, DTS, or MPEG decoder.
- Use a fiber-optic cable (not supplied) to connect the **DIGITAL OUT OPT** (digital optical output) on the player to the digital optical input on an AV amplifier or receiver.

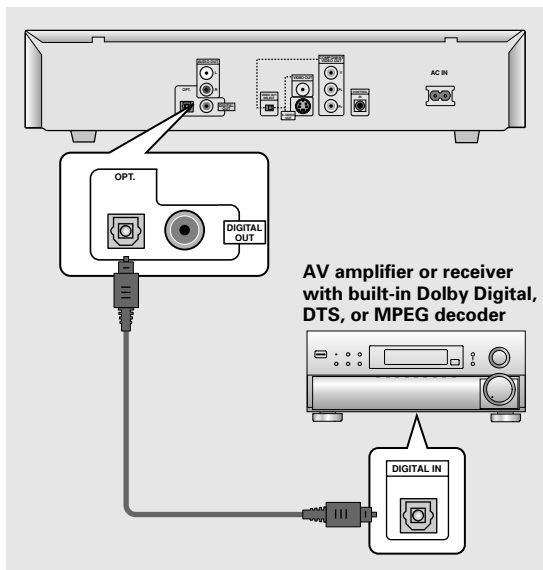

DIGITAL OUT (Coaxial)

The digital signal is transmitted electronically through a coaxial cable.

- Use to connect to an AV amplifier or receiver with built-in Dolby Digital, DTS, or MPEG decoder.
- Use a coaxial cable (not supplied) to connect the **DIGITAL OUT** (coaxial digital output) on the player to the coaxial digital input on an AV amplifier or receiver.

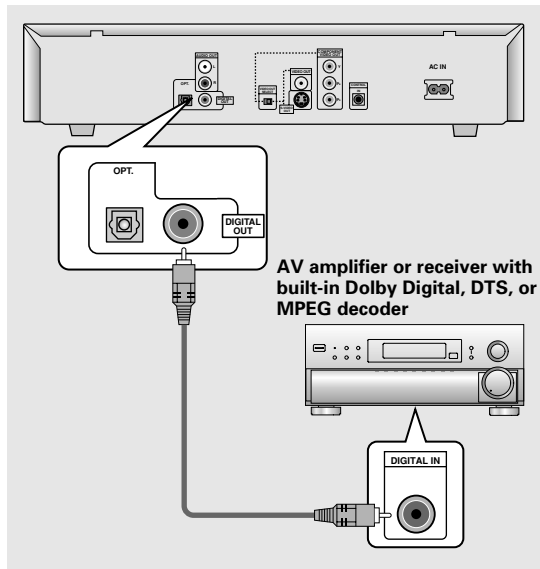

Analog Audio Connection

AUDIO OUT

- Make analog audio connections to a stereo amplifier or receiver.
- Analog audio connections can also be made to a TV or monitor with stereo input jacks.
- Use the supplied audio cord to connect the **AUDIO OUT** on the player to the audio input on the stereo amplifier or receiver.
- When making analog audio connections, be sure to match the color of the plugs with the color of the jacks (red and white).

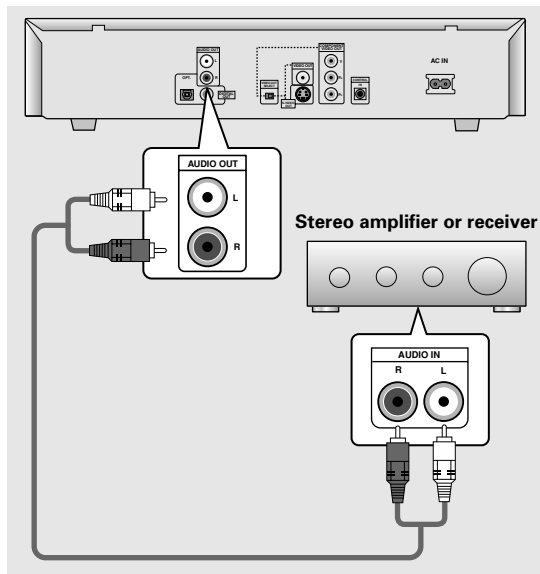

Video Connections

This player features S-video, composite, and component video output possibilities.

Check the manual supplied with your TV or monitor to determine the best possible connection for your system. In addition to making physical connections to your TV or monitor, it is also necessary to assign the TV screen size. You can use the **[Setup Navigator]** in the Setup screen **General** to set whether you are using a wide screen or standard size TV or monitor (**page 18**). Additionally, you can use the **[TV Screen]** setting in the Setup screen **Video** menu (**page 28**).

S-VIDEO OUT

- Make S-video connections to a TV or monitor with S-video input to produce a high quality video image.
- Use an S-video cable (not supplied) to connect the **S-VIDEO OUT** jack on the player to S-video input on the TV or monitor.
- When making S-video connections, make sure to set the **VIDEO OUT SELECT** switch on the rear panel of the player to the right to assign S-video output.

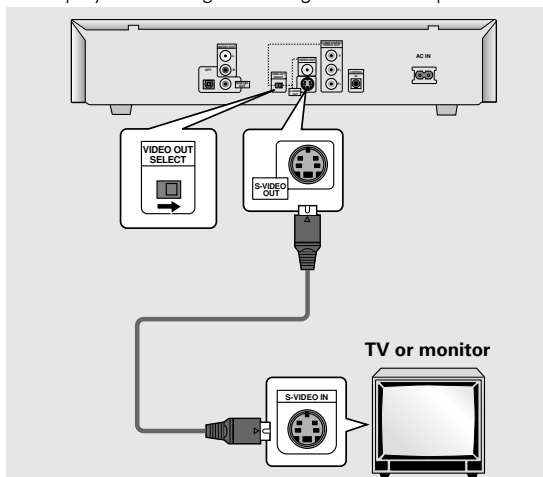

VIDEO OUT

- Make composite video connections to a standard TV or monitor with a video input jack.
- Use the supplied video cable to connect the **VIDEO OUT** jack on the player to the video input on the TV or monitor.
- Be sure to match the color of the plug with the color of the jack (yellow).
- When making video connections, make sure to set the **VIDEO OUT SELECT** switch on the rear panel of the player to the right to assign composite video output.

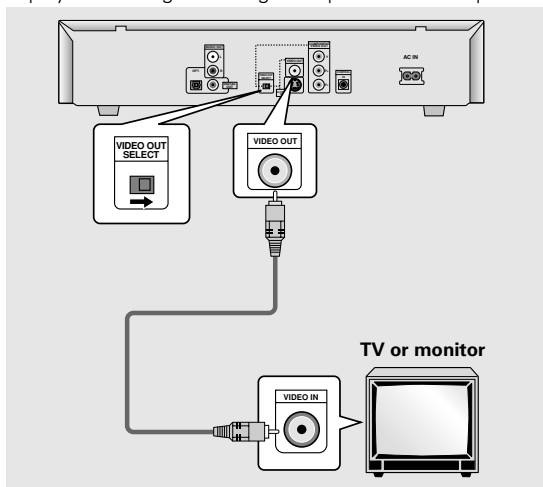

COMPONENT VIDEO OUT

- Make component video connections to a TV or monitor with component inputs to produce a higher quality video image.
- Use a component video cable or 3 video cords (not supplied) to connect the **COMPONENT VIDEO OUT** jacks on the player to the component jacks on the monitor.
- When making component video connections, make sure to set the **VIDEO OUT SELECT** switch on the rear panel of the player to the left to assign component video output.

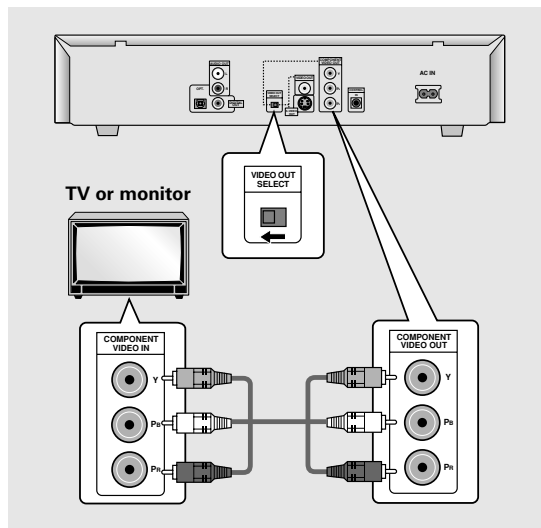

System Control Connections

Using a commercially available cord with a mini plug (3.5 mm dia. with no resistance) to connect this player's **CONTROL IN** jack to the **CONTROL OUT** jack of another PIONEER component bearing the **SR** mark, you can control the player as though it were a component in a system (system control).

- If you connect for system control, you cannot operate the player directly. Point the remote control unit at the component (AV amplifier, etc.) connected to the **CONTROL OUT** jack to operate.
- When controlling as a system, be sure to make a connection to the amplifier **using an audio or video cord**, even when using only digital components.
- For details, refer to the operation manuals of the connected components.

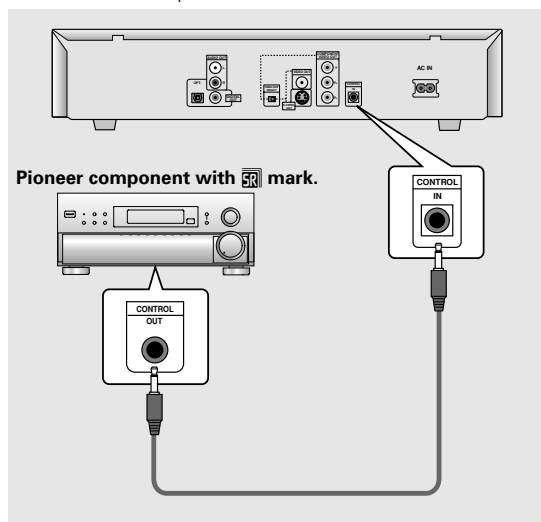

Setting Up the Player

Setting the TV System

The default setting of this player is **AUTO**, and unless you notice that the picture is distorted when playing some discs, you should leave it set to **AUTO**.

If you experience picture distortion with some discs, set the TV system to match your country or region's system. Doing this, however, may restrict the kinds of disc you can watch. The table below shows what kinds of disc are compatible with each setting (**AUTO**, **PAL** and **NTSC**).

Disc		Output format		
Type	Format	Position of TV SYSTEM mode		
		NTSC	PAL	AUTO
DVD	NTSC	NTSC	MOD. PAL	NTSC
	PAL	—	PAL	PAL
Video CD	NTSC	NTSC	MOD. PAL	NTSC
	PAL	NTSC	PAL	PAL
CD, No disc		NTSC	PAL	NTSC or PAL

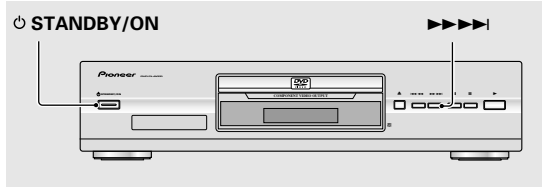

1 Switch the player into standby.

2 Hold down **▶▶▶▶▶▶** then press **⏻** **STANDBY/ON** to switch the TV system.

The TV system changes as follows:

AUTO → **NTSC**

NTSC → **PAL**

PAL → **AUTO**

The display indicates the new setting.

Note that you have to switch the player into standby before each change.

About MOD. (Modulation) PAL

- **SHRINK**

Most models of the newly developed countdown PAL TV system detect 50 Hz (PAL)/60 Hz (NTSC) and automatically switch vertical amplitude, resulting in a display without vertical shrinkage.

- If your PAL TV does not have a V-Hold control, you may not be able to view NTSC disc because the picture may roll. If the TV has a V-Hold control, adjust it until the picture stops rolling. On some TVs, the picture may shrink vertically, leaving black bands at the top and bottom of the screen. This is not a malfunction; it is caused by the NTSC → PAL conversion.

Using the Setup Navigator

The Setup Navigator has been designed to simplify the process of getting the DVD player ready to perform. Designed as a series of on-screen multiple-choice questions, the Setup Navigator automatically sets the audio, video, and language settings according to how the questions are answered. Once this procedure is complete, it will be possible to begin using the DVD player to enjoy DVDs.

The procedure on this page describes the operations necessary to function within the Setup Navigator screens. A detailed description of the contents of each question that appears on the screen can be found on the following pages.

When setting up for the first time

Some DVDs start playing automatically when loaded in the player. Because the Setup Navigator cannot be used if a disc is playing, it is recommended to set up the player using the Setup Navigator before loading a DVD for the first time. If a DVD has been loaded, be sure to press **STOP** **■** before proceeding.

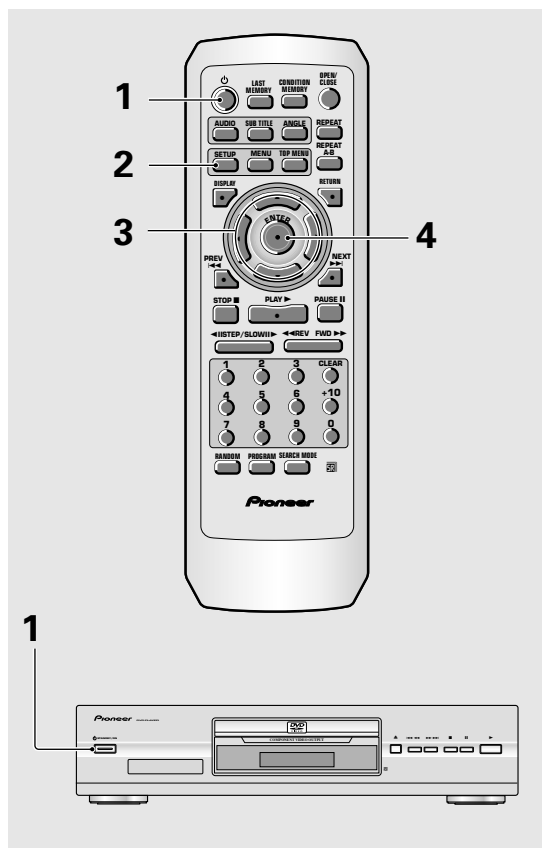

1 Press **⏻** (⏻ **STANDBY/ON** on the front panel).

2 Press **SETUP**.

When **SETUP** is pressed for the first time, the following screen appears. Though the Setup Navigator may be used more than once, this screen only appears the first time **SETUP** is pressed.

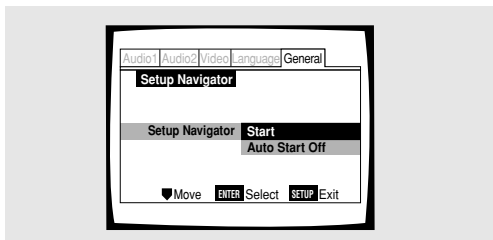

3 Use the cursor buttons (**▲/▼**) to make a selection.

- If you are going to use the Setup Navigator, it is not necessary to change the setting on the first screen. Please proceed to the next step.
- **If you do not want to set up the player using the Setup Navigator, use the cursor button (▼) to select [Auto Start Off] at this time.**
The Setup Navigator function may still be used at a later time in manual Setup screen menu operation (page 24).

4 Press **ENTER**.

The selection is entered and the next Setup Navigator screen appears.

Use steps **3** and **4** as a basis for entering selections on all of the Setup Navigator screens described on the following pages.

To change the answer to a prior question

Use the **cursor button** (◀) to return to previous screens. Please note, however, that you cannot go forward using the **cursor button** (▶), so it will be necessary to answer all the questions that occur after the screen that was returned to.

To exit the Setup Navigator

Press **SETUP** while on any of the screens to exit the Setup Navigator. Please note that if the Setup Navigator is exited before all the questions are answered, no settings are changed.

To return to the Setup screen

Press **RETURN**. The Setup Navigator is exited and the Setup screen **General** menu screen appears. Please note that no settings are changed if **RETURN** is pressed before the Setup Navigator is finished.

Setting the OSD Language (On-Screen Display Language)

The **[OSD Language]** screen establishes the OSD language, or on-screen display language, which refers to the language that is used by the player in menus and on-screen messages. Additionally, the language that is established at this setting will also be used for the default audio and subtitle language.



Settings: **English***
français
Español

* Factory setting

Note

In addition to setting the **[OSD Language]**, the audio and subtitle language are also set at this time. If you wish to change the audio or subtitle language to a different language, make changes in the Setup screen **Language** menu **[Audio Language]** and **[Subtitle Language]** as needed (pages 32, 33).

Setting the TV screen size

The **[TV Type]** screen establishes the size, or more appropriately the width to height ration of your television or monitor. The width-to-height ratio of conventional TVs is 4:3, while the width-to-height ratio of wide screen and high-definition TVs is 16:9. This width-to-height ratio is called the aspect ratio.

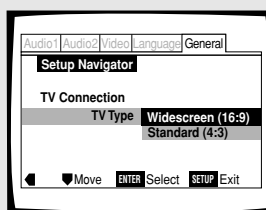

Settings: **Widescreen (16:9)***
Standard (4:3)

* Factory setting

Note

There are two screen formats that can be used to display wide-screen format DVDs: letter box and pan & scan. When **[Standard (4:3)]** is selected in the Setup Navigator, the letter box screen format is automatically selected. To switch the preference to the pan & scan format, make changes in the Setup screen **Video** menu **[TV Screen]** setting (page 28).

Setting digital audio connections to an AV amplifier or decoder

The **[Digital Jack]** screen establishes whether digital connections have been made to an AV amplifier, receiver, or external decoder. As there are numerous options available, please refer to the instructions supplied with the component the player is connected to determine what digital audio formats can be decoded. If you have made no digital connections, select **[Not Connected]**.

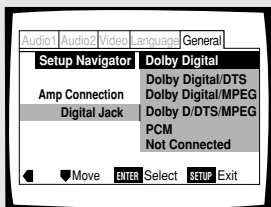

Settings: **Dolby Digital***
Dolby Digital/DTS
Dolby Digital/MPEG
Dolby D/DTS/MPEG
PCM
Not Connected

* Factory setting

Setting compatibility with 96 kHz output

The **[96 kHz PCM Audio]** screen establishes whether or not the AV component the player is connected to is capable of processing an audio signal with a sampling rate of 96 kHz. This screen only appears if connections have been made to an external AV component as determined in previous screens.

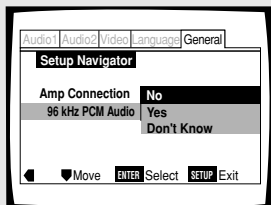

Settings: **No***

Select if the connected AV component cannot process an audio signal with a sampling rate of 96 kHz.

Yes

Select if the connected AV component can process an audio signal with a sampling rate of 96 kHz.

Don't Know

Select if you are uncertain whether the connected AV component can process an audio signal with a sampling rate of 96 kHz.

* Factory setting

Confirming the settings

The **[Exit Setup Navigator]** is the final screen in the Setup Navigator.

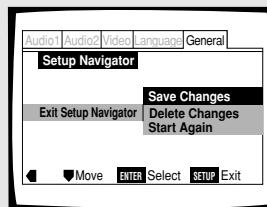

Settings: **Save Changes***

Select to have the player make all of the necessary audio, video and language settings automatically.

Delete Changes

Select to exit the Setup Navigator without changing any of the system settings.

Start Again

Select to return to the **[OSD Language]** screen of the Setup Navigator and do the settings again.

* Factory setting

To exit the Setup screen

When you have completed setting up the player using the Setup Navigator or if you exit the Setup Navigator, the Setup screen **General** menu appears. Press **SETUP** to close the Setup screen.

To change other player settings in the Setup screen menus

The procedure for changing the settings in the Setup screen menus is described on **page 24**.

Getting Started Using Your DVD Player

Playing DVDs, Video CDs and CDs – DVD/Video CD/CD

Before you can start to enjoy the digital audio and video on DVDs, be sure that you have either performed the Setup Navigator procedure described in the previous section or made the necessary settings in the Setup screen menus as outlined in the next section to set up the player to correspond to your home system. Having made these settings, you are now ready to start using the player to enjoy DVDs, Video CDs, and CDs.

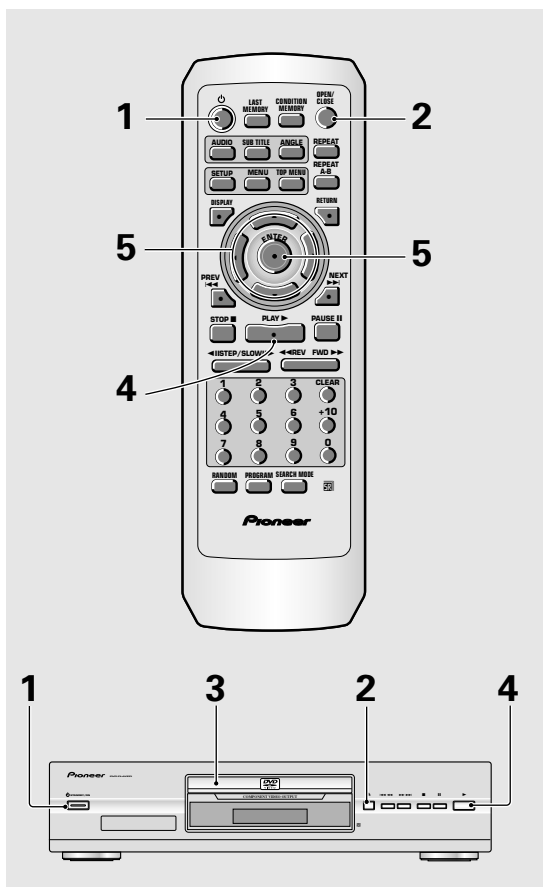

- 1 Press** (⏻ **STANDBY/ON** on the front panel).
- 2 Press** **OPEN/CLOSE** (on the front panel). The disc tray comes out.
- 3 Load a disc.**
 - Load a disc with the label side facing up, using the disc tray guide to align the disc.

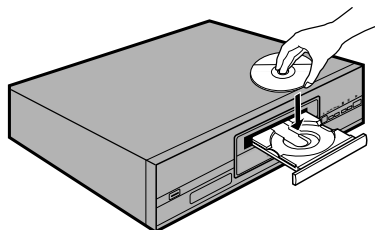

- 4 Press** **PLAY** (on the front panel).
 - The disc tray closes, and playback begins.
 - **Depending on the disc, a menu may be displayed. If a menu is displayed, proceed to step 5.**
- 5 Select the item you want to view.**
 - **When a DVD is loaded:** Select the item with the **cursor buttons** (/▶/▲/▼) or the **number buttons** then press **ENTER**.
 - **When a Video CD is loaded:** Use the **number buttons** to select the item.

Notes

- Noise is output if you make digital audio connections to a receiver or amplifier that does not have a built-in decoder. Check that the digital audio output format selected in the **Audio 1** menu corresponds to the audio components you have made connections to (**pages 26-27**).
- The TV screen size is factory set to present the wide screen format (16:9 aspect ratio). If you have a standard TV screen (4:3 aspect ratio), this setting can be changed to match your TV screen size in the **Video** menu (**page 28**).

When an operation is prohibited

There are times when you are using the player and attempt to perform an operation, but for some reason it cannot be performed. When this occurs, one of the two following icons appears on the screen.



The operation is prohibited by the player.



The operation is prohibited by the programming on the disc.

When a menu screen is displayed

Menu screens are displayed for DVDs that have menu screens or Video CDs that include Playback Control (PBC). DVDs often contain extra information that can be accessed in the DVD menu and sometimes makes navigating DVD menu screens as enjoyable as watching the feature presentation.

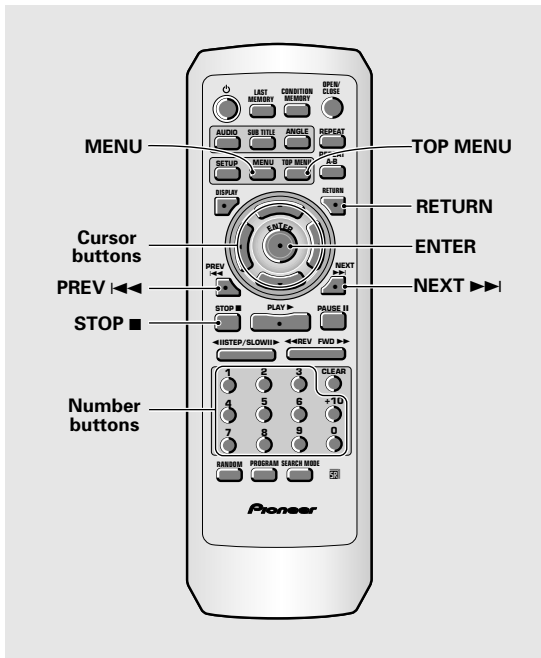

To open or return to the DVD or Video CD menu screen

Although this differs depending on the disc, pressing **MENU**, **TOP MENU**, or **RETURN** during DVD playback or **RETURN** during Video CD playback displays the menu screen. Refer to the DVD or Video CD disc jacket and accompanying documentation for more information.

To navigate a menu screen

- Although individual DVD titles may differ, when a menu screen is displayed, use the **cursor buttons** (◀/▶/▲/▼) and **ENTER** on the remote control. The **cursor buttons** are used to move around the options on the screen and **ENTER** is used for selection.
- Occasionally, the **number buttons** may also be used to make selections. If this is possible, using **number buttons** serves to directly select an option on a menu screen. Only **number buttons** are used to make selections on Video CD menu screens.
- When the Video CD has more than one menu, pages can be advanced to or returned to with **PREV** ◀◀ or **NEXT** ▶▶.

To play Video CDs without displaying menu screens

Video CDs with Playback Control (PBC) display a menu screen when play is started. It is possible, however, to play back Video CDs without displaying menu screens.

When a Video CD with PBC is loaded, press **STOP** ■, and then the **number button** of the track you want to play.

Example: When a DVD that has menu screens is loaded



Example: When a Video CD that has Playback Control is loaded



Chapter (Track) Skip Forward/ Skip Back – DVD/Video CD/CD

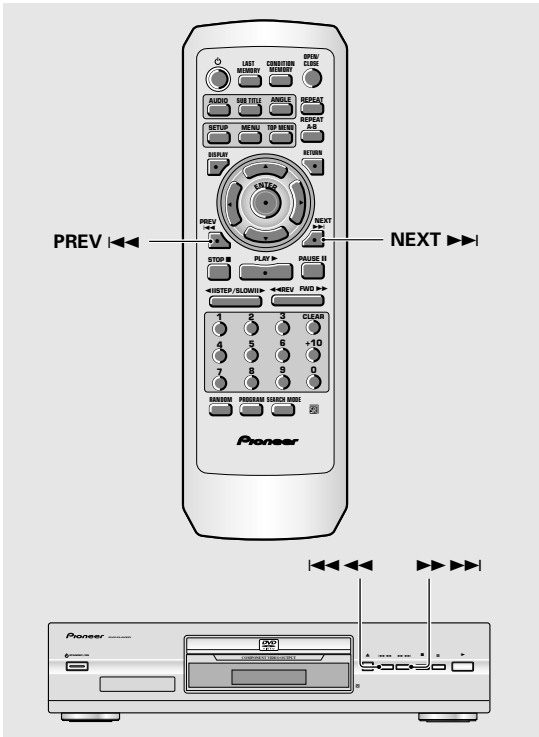

Advancing to the next chapter (track)

Press **NEXT** ►► (►► ►►► on the front panel).

- Press to skip forward to the next chapter (track).
- You can advance more than one chapter (track) forward by pressing and holding **NEXT** ►► and releasing when the desired chapter (track) number appears in the display.

Skipping back to the previous chapter (track)

Press **PREV** ◀◀ (◀◀ ◀◀◀ on the front panel).

- Press once to skip back to the start of the chapter (track) currently playing.
- Press twice to skip back to the start of the previous chapter (track).
- You can skip back to previous chapters (tracks) by pressing and holding **PREV** ◀◀ and releasing when the desired chapter (track) number appears in the display.

Forward and Reverse Scanning – DVD/Video CD/CD

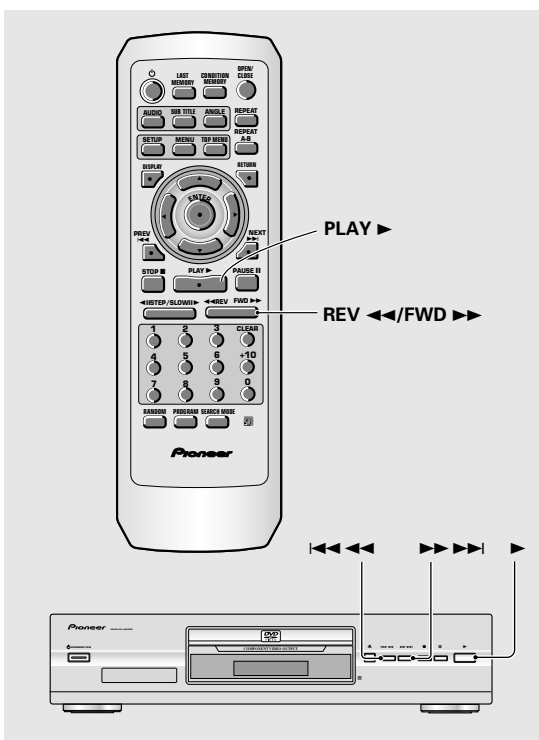

Fast forward scanning

Press and hold **FWD** ►► (►► ►►► on the front panel) during playback.

- Release **FWD** ►► when you reach the desired location. Normal playback resumes.
- When the “Scan” indicator on the screen changes from flashing to lit, fast forward scanning will continue even if the button is released. When the desired location has been reached, press **PLAY** ►.

Fast reverse scanning

Press and hold **REV** ◀◀ (◀◀ ◀◀◀ on the front panel) during playback.

- Release **REV** ◀◀ when you reach the desired location. Normal playback resumes.
- When the “Scan” indicator on the screen changes from flashing to lit, fast reverse scanning will continue even if the button is released. When the desired location has been reached, press **PLAY** ►.

Resuming Playback from Where You Stopped – DVD/Video CD

Use the resume feature to restart playback from the point that the disc was stopped last time.

Press **STOP** ■ once.

The display shows **“RESUME”** and the stop position is memorized.

- The resume position remains memorized as long as the disc is in the player — even if you switch the power off.
- Pressing **STOP** ■ twice causes the disc to return to the beginning when **PLAY** ► is pressed again. The display shows the disc type (DVDs or Video CDs)

Press **PLAY** ►.

Playback starts from the resume position.

Notes

- The actual restart position may be slightly before or after the resume position.
- If you want to remove the disc, but still want to resume playback from the last stopped position, use the **LAST MEMORY** feature instead (page 45).

Stopping Playback and Switching Power Off

– DVD/Video CD/CD

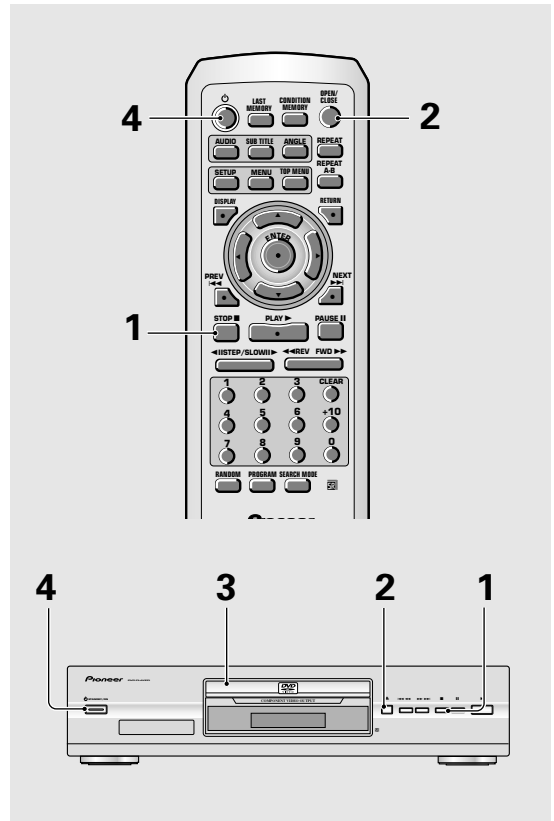

1 Press **STOP** ■ (■ on the front panel).

Playback stops.

2 Press **OPEN/CLOSE** (▲ on the front panel).

The disc tray comes out.

3 Remove the disc.

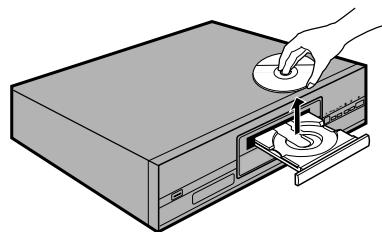

4 Press **⏻** (⏻ **STANDBY/ON** on the front panel).

The disc tray goes back in.

Adjusting Audio and Video Settings

Using the Setup Screen Menus

The procedure on this page describes how to operate the menus on the Setup screen. These menus are used to set and adjust a number of system settings. The various functions that can be adjusted are covered throughout this manual. The procedure on this page provides a basic outline for using the Setup screen menus.

When setting up for the first time

It is recommended to set up player using the Setup Navigator (page 17). If you selected [Auto Start Off] when the Setup Navigator appeared, you may still set up the player using the Setup Navigator in the **General** menu screen.

If you choose not to use the Setup Navigator, be sure to make the necessary settings in the Setup screen

Audio 1, Audio 2, Video, and Language menus as described on the following pages.

Some DVDs start playing automatically when loaded in the player. If a DVD has been loaded, be sure to press **STOP ■** before proceeding.

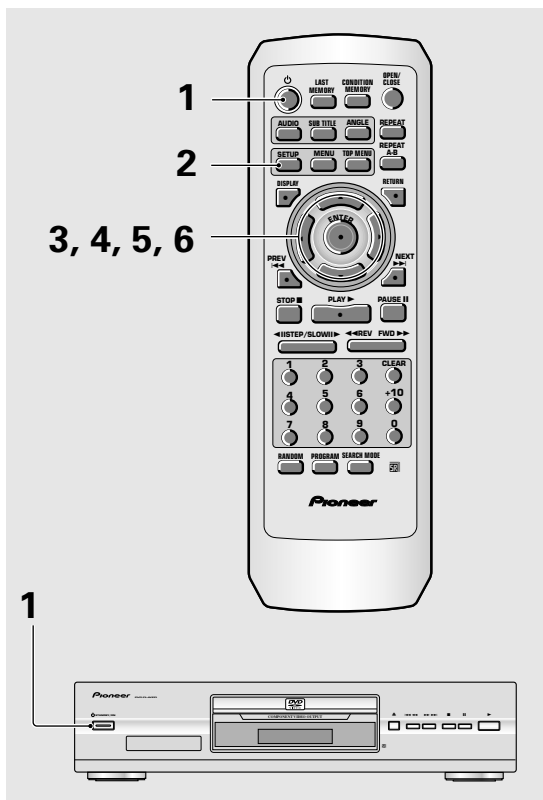

1 Press **⏻** (**STANDBY/ON** on the front panel).

2 Press **SETUP**.

The Setup screen appears.

(Example)

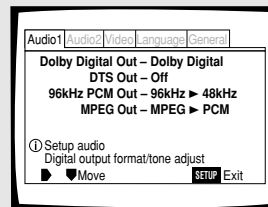

3 Use the cursor buttons (**◀/▶**) to select the menu you want.

As each menu is selected with the cursor, the settings appear below the menu heading.

4 Use the cursor buttons (**▼**) to enter the menu.

The top item within the menu becomes highlighted.

(Example)

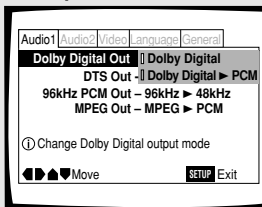

5 Use the cursor buttons (**▲/▼**) to select the setting you want to change.

The options available for each setting appear to the right when the setting is selected. The current setting appears with the setting indicator lit.

6 Use the cursor buttons (**▶**) to enter the setting options.

(Example)

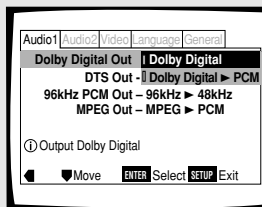

- Not all menu options can be changed while a disc is playing. In these cases, the options appear grayed out on the screen and cannot be adjusted. To change these settings, press **STOP ■** first before pressing **SETUP**.
- Operating the menu after pressing **STOP ■** may cancel the resume function.
- Some menu options are not immediately effective if set while a disc is playing. To make these settings effective, stop playback and then start again, or change the settings while the disc is stopped.

continued

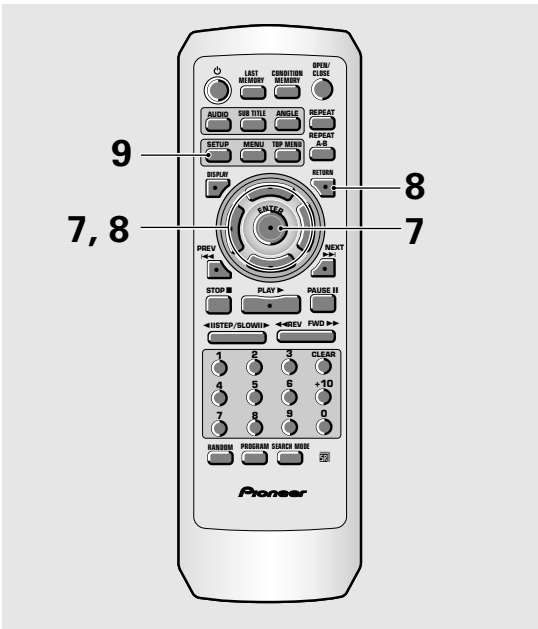

IMPORTANT

Changing to the Setup Screen “Expert” Menu Mode

The Setup screen menus are divided into two levels, **[Basic]** and **[Expert]**, to make this unit more convenient to operate for different levels of users. The **[Basic]** menu mode contains functions that may be considered necessary for the basic operations of this player and helpful on-screen information identified by the **[i]** mark. The **[Expert]** menu mode adds to the **[Basic]** menu mode additional functions of the player that can be adjusted to further personalize performance of the player.

In this manual, functions that are contained in the **[Expert]** menu mode are identified by the **[Expert]** icon. Make changes to the **[Setup Menu Mode]** setting in the Setup screen **General** menu.

7 Use the cursor buttons (▲/▼) to select a new setting and press ENTER to set the new setting in memory. Press RETURN or the cursor button (◀) to exit the options without making any changes.

8 Press RETURN or the cursor button (◀) to go back to the main menu bar to select another menu.

9 Press SETUP to close the Setup screen.
The Setup screen closes.

Note

The next time you press **SETUP**, you'll see the menu screen that you exited from last time.

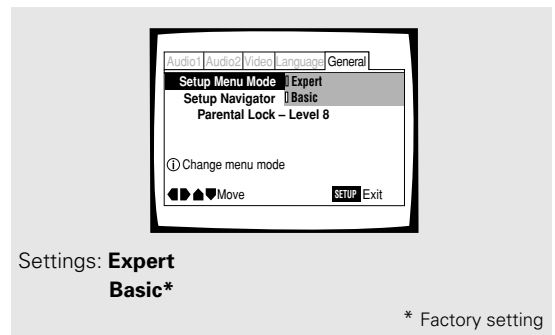

Note

On-screen information only appears if the **[OSD Language]** is set to **[English]** and menu mode is set to **[Basic]**.

How to interpret the setting indicator colors in the Setup screen menus

When setting up the system, or when making adjustments, it is convenient to know what settings are applicable to the different disc formats. When the settings appear for each menu option, the currently selected setting appears with the setting indicator highlighted in one of three colors: blue, green or yellow. These colors correspond to what formats the menu option effects as shown in the table below.

Color of indicator	Disc format(s)
Blue	DVD only
Yellow	DVD / Video CD
Green	All compatible formats

Note

If a setting applicable only to DVDs is changed while a Video CD or CD is loaded, a blue DVD icon appears in the upper right hand corner of the screen to indicate that the setting is not applicable to the currently loaded disc. The setting will be effective the next time a DVD is loaded.

Setting the Digital Audio Output to Be Compatible with Your AV Component – DVD

This player is capable of digital audio output for Dolby Digital, DTS, MPEG, and signals with a sampling rate of 96 kHz. Make settings in the Setup screen **Audio 1** menu to reflect the capabilities of the components that you have made digital connections to.

Notes

- If you have already completed the Setup Navigator screen operations, the settings on this page have already been set by the player.
- If you have made only stereo line connections (analog) using the supplied audio cord, it is not necessary to make any changes in this menu.

Dolby Digital Out

This player is capable of outputting the Dolby Digital surround sound audio signal. When the player is connected to an AV component that has a built-in Dolby Digital decoder, select **[Dolby Digital]**. This player can also convert the Dolby Digital signal to a digital Linear PCM signal, the same digital signal output from a CD. Select **[Dolby Digital ► PCM]** when you have made connections to an amplifier or receiver with a Dolby Pro Logic decoder or a Digital Analog Converter (DAC).

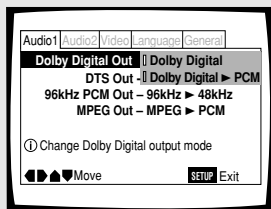

Settings: **Dolby Digital***
Dolby Digital ► PCM

* Factory setting

DTS Out

This player is capable of outputting DTS digital audio for DVDs recorded in DTS. When this player is connected to an AV component that has a built-in DTS decoder, select **[DTS]**. If your system is not equipped to decode DTS, select **[Off]**. Refer to the operating instructions supplied with your audio components if you are unsure about compatibility with DTS.

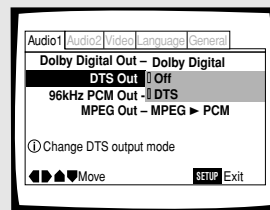

Settings: **Off***
DTS

* Factory setting

Note

If you have made digital audio connections to component(s) not equipped to decode the DTS digital bitstream, be sure to select **[Off]**. If a DTS signal is output without decoding, the output is digital noise that could potentially cause damage to your speakers.

96 kHz PCM Out

This player is capable of outputting digital signals with a sampling frequency of 96 kHz. If you have made connections to a component capable of processing this signal rate, select **[96 kHz]** for the signal to be output as is. As some components are incapable of processing digital signal input with sampling rates of 96 kHz, selecting **[96 kHz ► 48 kHz]** compresses the signal to a standard signal with a sampling rate of 48 kHz.

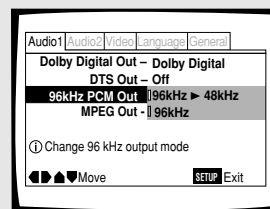

Settings: **96 kHz ► 48 kHz***
96 kHz

* Factory setting

Note

On DVDs that contain copy protection, the 96 kHz signal may only be output from the analog audio jacks.

MPEG Out

This player is capable of outputting the MPEG digital bitstream. When the player is connected to an AV component that has a built-in MPEG decoder, select the **[MPEG]** setting. Otherwise, select **[MPEG ▶ PCM]** to convert the digital signal to the PCM signal, the digital signal output from a CD.

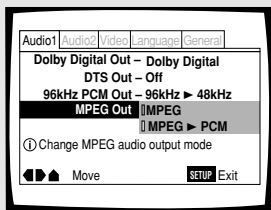

Settings: **MPEG**
MPEG ▶ PCM*

* Factory setting

Digital Out **[Expert]** – DVD/Video CD/CD

Depending on your preferences and the type of connections made, you may opt not to have the digital audio signal output at all. When this setting is set to **[Off]** there is no signal output from the digital audio output jacks.

Make changes to the **[Digital Out]** setting in the Setup screen **Audio 1** menu in the **[Expert]** menu mode (page 25).

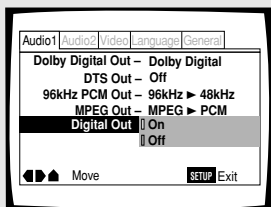

Settings: **On (Digital bitstream is output)***
Off (Digital bitstream is not output)

* Factory setting

Adjusting the Dynamic Range of the Audio Soundtrack – DVD

Audio DRC stands for Audio Dynamic Range Compression. When Audio DRC is on, soft sounds such as dialog can be heard more clearly without making loud sounds even louder. Select from three levels of compression depending on how much effect you want. When Audio DRC is set to **[Off]**, there is no effect on the audio source.

Make changes to the **[Audio DRC]** setting in the Setup screen **Audio 2** menu.

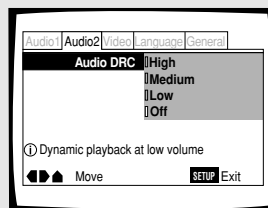

Settings: **High**
(maximum compression of audio source)
Medium
(moderate compression of audio source)
Low
(very little compression of audio source)
Off*

* Factory setting

Note

Audio DRC is only effective with Dolby Digital audio sources.

Setting the TV Screen Size – DVD

The width-to-height ratio of conventional TVs is 4:3, while the width-to-height ratio of wide screen and high-definition TVs is 16:9. This width-to-height ratio is called the aspect ratio.

When viewing software recorded in different aspect ratios, the image's height to width ratio can be switched to match the TV or monitor being used.

Make changes to the TV screen size in the **[TV Screen]** setting in the Setup screen **Video** menu. Please note that changes to the **[TV Screen]** setting cannot be made when a disc is playing. Stop playback of the disc before attempting to make any changes.

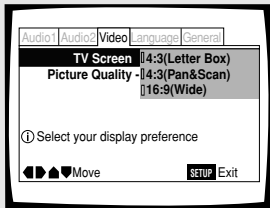

Settings: **4:3 (Letter Box)**

4:3 (Pan & Scan)

16:9 (Wide)*

* Factory setting

Notes

- If **[Standard (4:3)]** is selected in the Setup Navigator screen, **[4:3 (Letter Box)]** is selected on this screen. If you prefer the pan&scan format, change the settings on this screen.
- Whether the aspect can be switched or not depends on the disc. Please refer to the information written on the disc jacket, etc.
- Some discs may not include the screen format selected in the **[TV Screen]** setting. When this occurs, the standard TV screen format available on the disc is automatically selected.

Differences in screen sizes and DVD formats

The number of screen size formats currently available can be somewhat confusing. If set incorrectly, the video presentation may not appear as it should. The following diagrams and descriptions are intended to help you set your TV screen size in a way that will allow you to fully enjoy the digital video of DVD.

The settings in the **[TV Screen]** setting are perhaps most applicable when the DVD you are watching is programmed in the wide screen format. If you have a standard TV, select either **[4:3 (Letter Box)]** or **[4:3 (Pan & Scan)]** based on your personal preference. If you have a wide screen TV, select **[16:9 (Wide)]**.

When viewing a wide screen TV or monitor	
DVD screen size format	Setting and Appearance
Wide screen format DVD Please note that there are some wide screen letter box formats that place black bars at the top and bottom of the screen. This is not a malfunction.	<p>"Wide" setting</p>
Standard screen format DVD When viewing a standard screen format DVD on a wide screen TV, black bars may be automatically placed at the side of the screen to adjust to the DVD format.	<p>"Wide" setting</p>
Standard screen format DVD (unnatural stretched effect) If you are viewing a standard screen format DVD on a wide screen TV, the picture may appear 'stretched' on the screen. To remedy this condition, change your wide screen TV to display a standard (4:3) screen. Refer to the instructions supplied with your wide screen TV or monitor for more information.	<p>"Wide" setting</p>

When viewing a standard size TV or monitor	
DVD screen size format	Setting and Appearance
Wide screen format DVD The Letter box presentation places black bars at the top and bottom portions of the screen to provide the full wide screen presentation of a movie on a standard TV (4:3 aspect ratio).	<p>"Letter Box" setting</p>
Wide screen format DVD The Pan & Scan presentation crops both sides of the wide screen presentation to use the full standard TV screen.	<p>"Pan & Scan" setting</p>
Standard screen format DVD If you have a standard TV, the standard screen format will be presented regardless of the setting.	<p>Any setting</p>
Wide screen format DVD (unnatural squeezed effect) If you are viewing a wide screen format DVD on a standard TV and the [TV Screen] setting is set to [16:9 (Wide)] , the picture may appear 'squeezed' on the screen. To remedy this condition, select either [4:3 (Letter Box)] or [4:3 (Pan & Scan)] .	<p>"Wide" setting</p>

Selecting Picture Quality Appropriate for Program Content – DVD/Video CD

This lets you select the ideal picture quality for watching movies, animation and other video media. Make changes to the **[Picture Quality]** setting in the Setup screen **Video** menu.

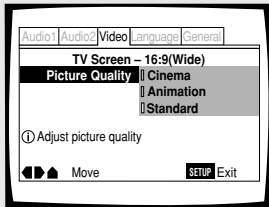

Settings: **Cinema**
Provides a sharp, clear black picture for images with high contrast.

Animation
Provides images with bright clear colors.

Standard*
Presents the video with no effect added.

* Factory setting

Selecting the Type of Paused Image to Display **Expert**

This function lets you view a clear still-image when DVD playback is paused. Make changes in the **[Still Picture]** setting in the Setup screen **Video** menu in the **[Expert]** menu mode (page 25).

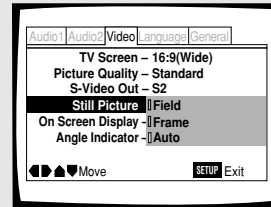

Settings: **Field**
(Picture shake will be eliminated during a paused picture.)

Frame
(Select to obtain higher picture quality.)

Auto*
(Selects **Field** or **Frame** automatically according to the disc.)

* Factory setting

Switching the S-Video Output **Expert** – DVD

You can Switch the kind of S-Video signal output from the S-Video outputs. If you connected your TV with an S-Video cord, in rare cases the TV picture may appear stretched. In this case switch the output from **[S2]** to **[S1]**.

Make changes in the **[S-Video Out]** in the Setup screen **Video** menu in the **[Expert]** menu mode (page 25).

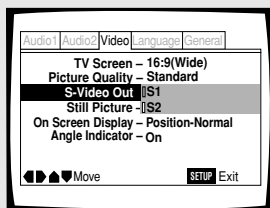

Settings: **S1**
S2*

* Factory Setting

Setting the Position of the On-screen Display **Expert**

When watching conventional software on a wide screen TV, the operation display is at the very top of the screen, and may be difficult to see. Changing the position of the display lets you see operation indicators clearly even on a wide screen TV.

Alternatively, you can choose to turn them off completely with the **[Off]** setting. Make changes in the **[On Screen Display]** in the Setup screen **Video** menu in the **[Expert]** menu mode (page 25).

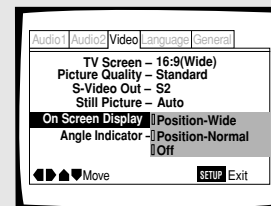

Settings: **Position-Wide**
Position-Normal*
Off

* Factory setting

Note

This setting is only effective with DVDs that contain a 4:3 aspect ratio video presentation.

Viewing from a Desired Camera Angle (Multi-Angle)

– DVD

You can select a camera angle when viewing DVDs with the multi-angle option.

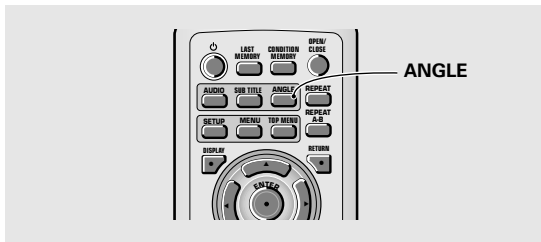

Press ANGLE during playback.

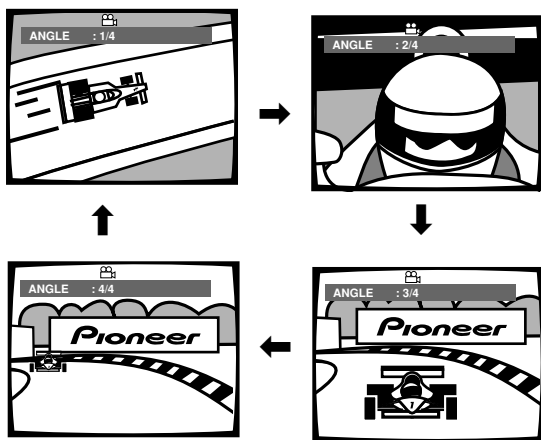

The camera angle changes each time you press the button.



Notes

- You can use the Multi-Angle function only with discs featuring recordings of images shot from different camera angles.
- During Multi-Angle playback, the  indicator in the display lights.
- For some discs, selection can be made using the DVD menu. In this case, press **MENU** to display the DVD menu screen and then make your selection.

To check whether or not a disc is recorded with angles:

The jacket of discs that are recorded with angles will be marked with . When locations on discs that are recorded with angles are played back, the  indicator can be displayed.

To cancel the angle mark, set **[Angle Indicator]** to **[Off]** in the Setup screen **Video** menu described in the section below.

Turning the angle indicator on and off **[Expert]**

When a picture recorded in different angles is played back  is displayed on the screen. This setting lets you see clearly whether the playback picture is recorded in multiple angles or not.

Turn the angle indicator on or off in the **[Angle Indicator]** setting in the Setup screen **Video** menu in the **[Expert]** menu mode (page 25).

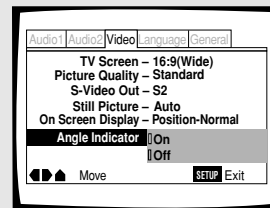

Settings: **On*** ( is displayed)

Off (Not Displayed)

* Factory setting

Note

Even when the **[Angle Indicator]** setting is set to **[Off]**, the  indicator in the display panel of the player lights during multi-angle playback. Therefore, it is possible to know when the multi-angle function can be used without having to display the icon on the screen.

Setting the Language Options

DVDs have the capacity to contain a great deal of audio information, which includes the ability to hold up to 8 different language tracks and subtitle information in as many as 32 different languages. This section outlines the variety of audio language and subtitle options available with this player.

Please note that if you have completed the Setup Navigator, the audio and subtitle language options have automatically been set in accordance with the **[OSD Language]** (the language that appears on the screen).

Note

DVDs differ in content and do not all contain multiple language or subtitle information. Therefore making settings in this section may have no effect on some DVDs.

Setting the On-screen Display (OSD) Language

This setting is used to establish the language that operation indicators and on-screen messages and operations display. Change this setting in the Setup screen **Language** menu **[OSD Language]** setting.

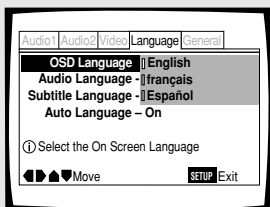

Settings: **English***
français
Español

* Factory setting

Note

The **[OSD Language]** setting is factory set to **[English]**. If you want English to be displayed, it is not necessary to adjust this setting.

Changing the Audio Language (Multi-Language Function) – DVD

Dolby Digital, PCM, and other audio data can be recorded on DVDs in a number of languages or audio tracks, letting you choose the desired language or audio.

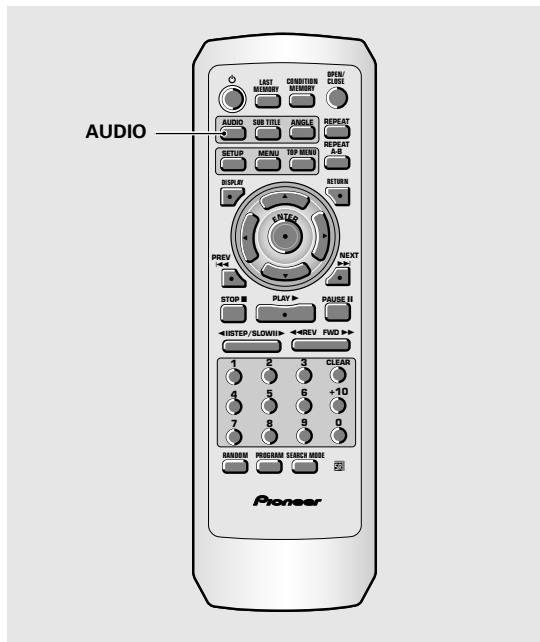

Press **AUDIO** repeatedly to select the desired language.

Pressing **AUDIO** once displays the currently selected language. Subsequent presses rotate through the audio languages available on the DVD.

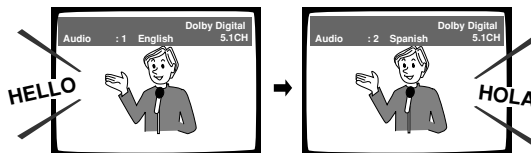

Notes

- You cannot switch languages if there is only one language recorded on the disc.
 - Switching the audio language may not be possible with some titles. In this case, the  mark is displayed.
 - For some titles, selection can be made using the DVD menu.
- In these cases, press **MENU** to display the DVD menu screen and then make your selection.

Changing Audio Type – Video CD/CD

For enjoyment of karaoke or similar format Video CDs and CDs, it is possible to select stereo audio, or either right or left channel mono depending on the requirements of the source.

Press AUDIO repeatedly during playback to switch the audio type.

Audio output changes from **[1/L]** (Left channel) to **[2/R]** (Right channel) to **[Stereo]**.

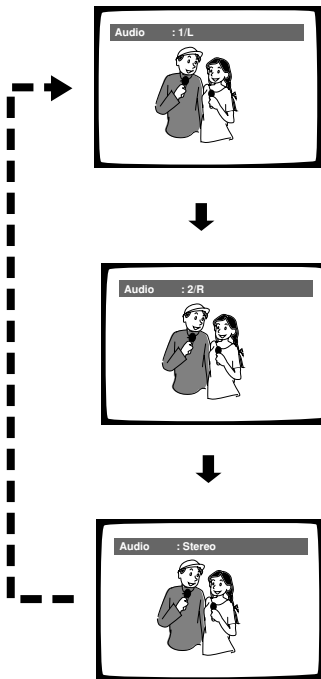

Note

With karaoke and other discs, set the appropriate audio type for singing and accompaniment after referring to information on the disc jacket or accompanying material.

Selecting an audio language preference

The audio language that you normally listen to can be selected from the various audio languages on a DVD. Even when the audio language is changed during playback by pressing **AUDIO**, the language selected at this setting will be selected as the default when the DVD is changed.

Make changes to the **[Audio Language]** setting in the Setup screen **Language** menu.

You cannot make this setting with a disc playing.



Settings: **English***

French

Spanish

Other

(For details on how to select other languages, see 'When "Other" is selected' on page 34.)

*Factory setting

Selecting a Subtitle Language (Multi-Language Subtitles)

– DVD

You can select a desired subtitle language with DVDs that have subtitle data in multiple languages recorded on them.

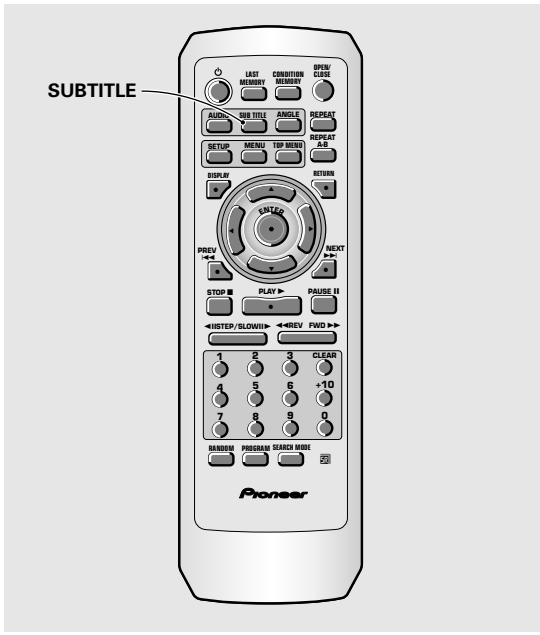

Selecting a subtitle language preference

The subtitle language that you will normally display can be selected from the subtitles programmed on a disc. Even when the subtitle language is changed during playback by pressing **SUBTITLE**, the language selected at this setting will be selected when the disc is changed. Make changes to the **[Subtitle Language]** setting in the Setup screen **Language** menu.

You cannot make this setting with a disc playing.



Settings: **English***

French

Spanish

Other

(For details on how to select other languages, see *'When "Other" is selected'* on page 34.)

*Factory setting

Press **SUBTITLE** repeatedly during playback.

Pressing **SUBTITLE** once displays the currently selected subtitle language. Subsequent presses rotates through the subtitle languages available on the DVD.

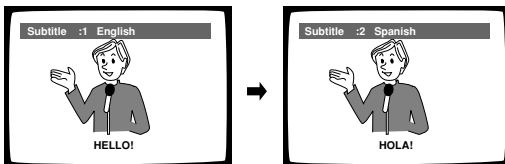

Notes

- The subtitle language cannot be switched if the subtitle language is not recorded, or if only one language is recorded.
- Switching the subtitle language may not be possible with some discs. In this case, the  mark will be displayed.
- To clear subtitles during playback, press **SUBTITLE** and then press **CLEAR**, or press **SUBTITLE** until **[Off]** appears.
- For some discs, subtitle language selection can be made using the menu on the DVD. In this case, press **MENU** to display the DVD menu screen and then make your selection.

When "Other" is selected

When you want to select one of the 136 languages as the main audio language, follow the steps below when the following screen appears.

A language code list can be found on page 51.

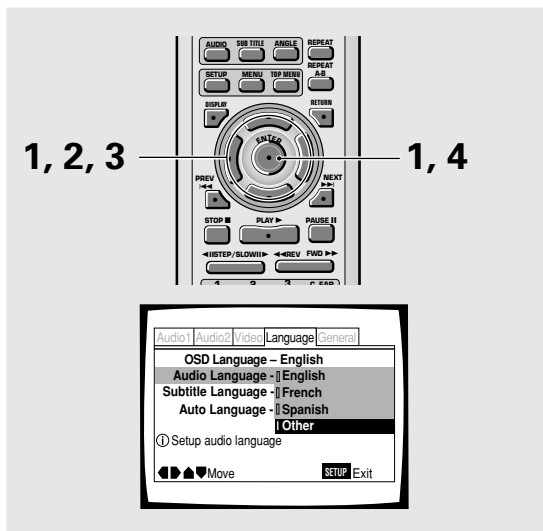

1 Use the cursor buttons to select "Other" and press ENTER.

The language selection screen appears.

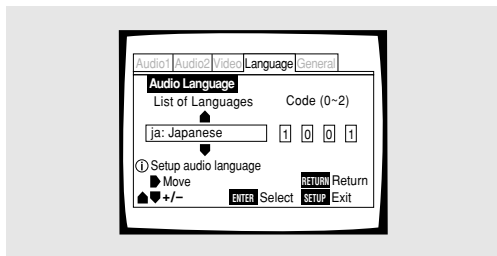

2 Use the cursor buttons (◀/▶) to select either "List of Languages" or "Code".

3 If you select "List of Languages", use the cursor buttons (▲/▼) to select the language.

For languages which are only shown as a code, please refer to 'Language Code List' on page 51.

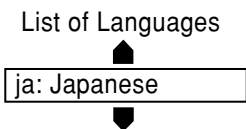

If you select "Code", use the cursor buttons (▲/▼) to input the numbers of the input code.

Use the cursor buttons (◀/▶) to change the position of the cursor. You can also use the number buttons to enter the code.

Code (0~2)

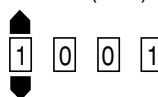

4 Press ENTER to set the new language.

To exit the screen without making any changes, press RETURN.

Setting Auto Language to control subtitle and audio language based on program content

When the Auto Language function is used, foreign movies are shown with the original audio soundtrack and subtitles in the language selected in the [Subtitle Language] menu option. Domestic films are shown with the original audio soundtrack and no subtitles (This setting may not be effective with all DVD discs.) Make changes to the [Auto Language] setting in the Setup screen Language menu.

You cannot make this setting with a disc playing.

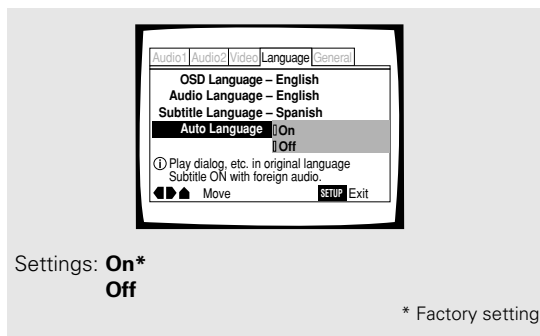

Note

The Auto Language function operates only when this function is set to [On], and the language set for the [Audio Language] and [Subtitle Language] settings is the same.

Selecting a DVD menu language preference Expert

In addition to containing different audio languages, DVD may also contain menu screens in different languages as well. Setting a DVD language preference, sets the selected language as a default when DVDs with menu information in that language are encountered.

Selecting **[w/ Subtitle Language]** automatically assigns the language selected in the **[Subtitle Language]** setting.

Make changes to the **[DVD Language]** setting in the Setup screen **Language** menu in the **[Expert]** menu mode (page 25).

You cannot make this setting with a disc playing.

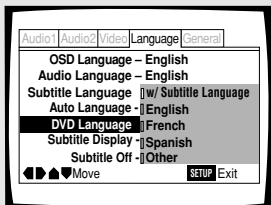

Settings: **w/ Subtitle Language***

English
French
Spanish
Other

(For details on how to select other languages, see 'When "Other" is selected' on page 34.)

* Factory setting

Notes

- The menu settings may look different from the one shown above.
- If this function is not effective, the languages that can be selected may also be selected in the DVD menu. Press **MENU** to open the DVD menu and make your selection accordingly.

Selecting subtitles, assist subtitles or no subtitles Expert

Use this function to turn the subtitles on or off.

Additionally, some DVDs provide assist subtitles that provide additional explanations of scenes in addition to the standard subtitles for viewers who are hard of hearing. Select **[Assist Subtitle]** to display these subtitles on DVDs where this function is offered.

Make changes to the **[Subtitle Display]** setting in the Setup screen **Language** menu in the **[Expert]** menu mode (page 25).

You cannot make this setting with a disc playing.

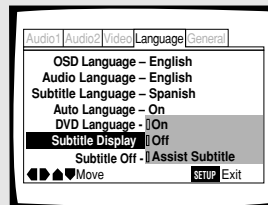

Settings: **On***

Off

Assist Subtitle

* Factory setting

Notes

- If there is no subtitle information recorded on the DVD, no subtitles are displayed even if this function is set to **[On]**.
- This setting serves as a default as whether or not to display subtitles. Even if this option is set to **[Off]**, subtitles can be displayed by pressing **SUBTITLE**. Similarly, if this option is set to **[On]**, the subtitles can be turned off by pressing **SUBTITLE** and then **CLEAR**.

Forcing subtitles to be displayed Expert

Even when the subtitles are turned off, some DVDs will nevertheless display them on the screen. This setting allows you to select the language of the subtitles to be displayed with this type of DVD.

Select **[With Audio]** to display the subtitles in the same language as the currently selected **[Audio Language]**.

Select **[Selected Subtitle]** to display the subtitles in the language set in the **[Subtitle Language]** setting.

Make changes to the **[Subtitles Off]** setting in the Setup screen **Language** menu in the **[Expert]** menu mode (page 25).

You cannot make this setting with a disc playing.

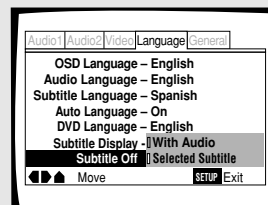

Settings: **With Audio**

Selected Subtitle*

* Factory setting

Advanced Functions

This player is compatible with DVD, Video CD, and CD disc formats. Users already familiar with Video CD or CD will already be familiar with some of the functions the player is capable of performing. With DVD, an even greater number of possibilities and functions are available.

Note

DVDs differ in content and do not all contain the same information. Therefore some functions in this section may not work or have no effect on some DVDs.

Setting the Parental Lock Level – DVD

This player lets you set the Parental Lock if the DVD has a parental lock level recorded on it. With Parental Lock capable discs, you can block access to material you feel is inappropriate for your children. Refer to the DVD disc jacket and the accompanying documentation to see if a particular disc contains a parental lock level.

Make changes to the **[Parental Lock]** setting in the Setup screen **General** menu. Please note that changes to the Parental Lock level can only be made when the player is stopped.

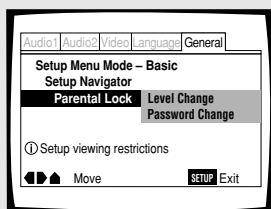

Settings: **Level Change**

(For information, refer to *'Setting the Parental Lock level'* on the following page.)

Password Change

(For information, refer to *'Changing the password'* on the following page.)

When a DVD with a set Parental Lock level is loaded

Playback cannot be started until the code number has been correctly input by using the **cursor buttons** (◀/▶/▲/▼) or the **number buttons**, and **ENTER** has been pressed.

Entering the password

When you select either **[Level Change]** or **[Password Change]**, it is necessary to enter the password (4-digit code number). Use the following steps at any time you are asked to enter or confirm your password.

1 Use the cursor buttons (▲/▼) or the number buttons to select a number between 0 and 9.

You can also use the **number buttons** to enter the numbers directly. When entering your password for the first time, or changing it, you will be asked to reenter your password. When using the **number buttons** to confirm the password, the numbers appear as asterisks, and the cursor advances automatically to the next position.

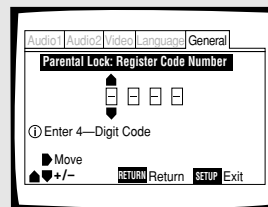

2 Use the cursor buttons (◀/▶) to move the cursor to a different position in the password.

When all four numbers of the password have been entered, **ENTER** appears on the screen.

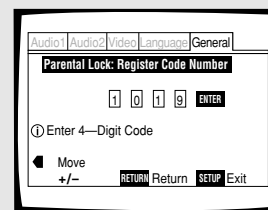

3 Press ENTER to set the new password.

The password is entered.

Note

Be sure not to forget your password. If you should forget it, reset the system, and enter a new password. To reset the system, see *'Resetting the Player to System Settings'* (page 48). Please note that this procedure resets the system, and clears all saved settings, not just the password.

Setting the Parental Lock level

Change the Parental Lock level to a higher or lower level according to the settings printed on the DVD disc jacket or accompanying documentation. If you use the Condition Memory function to save the settings for a particular disc, the Parental Lock level is saved as well. Because it is saved in memory, Parental Lock levels can be set for individual discs according to their content rather than a set level for all DVDs.

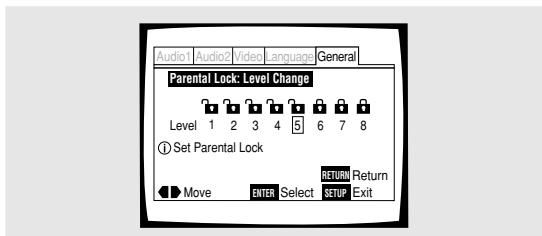

1 Select [Level Change] in the [Parental Lock] setting and press ENTER.

The screen changes to the password input screen. If you have not yet set a password, you will be asked to do so at this time. To enter the password, refer to 'Entering the password' on the previous page.

2 Use the cursor buttons (◀/▶) to adjust the Parental Lock level.

The lock icons appear "unlocked" up to the selected level to indicate that access is available.

3 Press ENTER to set the new level.

The new Parental Lock level is set and the screen returns to the **General** menu screen. To go back to the **General** menu screen without making any changes, press **RETURN**.

Changing the password

Change your password whenever you feel it is necessary. However, if you forget your existing password, you cannot enter this screen to change it.

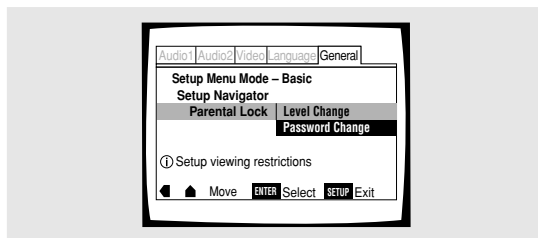

1 Select [Password Change] in the [Parental Lock] setting and press ENTER.

The screen changes to the password input screen. To enter the password, refer to 'Entering the password' on the previous page.

If you have not yet set a password, you cannot select this setting. Establish a password by selecting [Level Change] first.

2 Use the cursor buttons (◀/▶/▲/▼) or the number buttons to enter the new password.

3 When the new password has been entered, press ENTER.

The new password is set and the screen returns to the **General** menu screen. To go back to the **General** menu screen without making any changes, press **RETURN**.

Changing the Background Color of the Screen **Expert**

You can select a blue or black background to appear when the player is in the stop mode.

Make changes to the [Background Color] setting in the Setup screen **General** menu in the [Expert] menu mode (page 25).

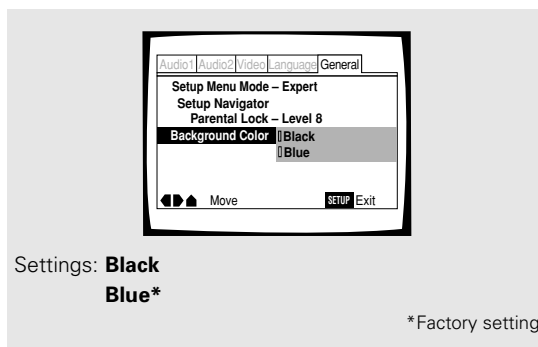

Still Frame/Slow Play/Frame Advance Playback – DVD/Video CD

The video images on DVD and Video CD can be viewed as a still frame, played back at slow speeds and even advanced frame by frame.

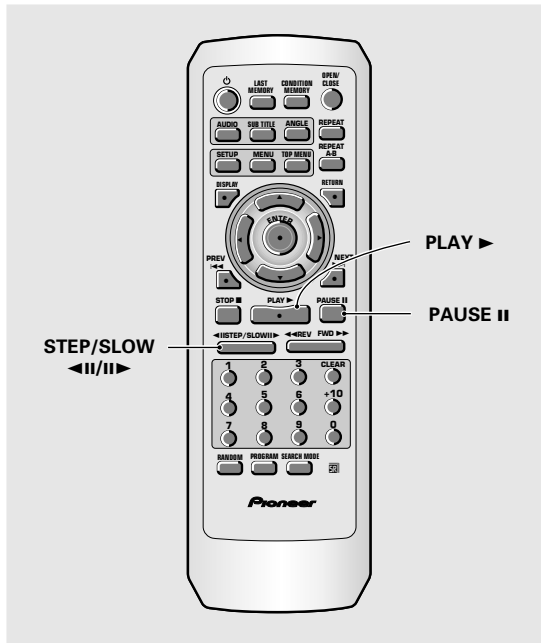

Viewing a still frame

Press PAUSE II.

When viewing a DVD, if the paused picture shakes, select the **[Field]** setting in the Setup screen **Video** menu **[Still Picture]** setting as described in the section on **page 29**.

To return to normal playback

When viewing a still frame playback, pressing **PAUSE II** or **PLAY ►** restores normal playback operation.

Viewing slow playback

Press and hold STEP/SLOW ◀II/II▶ during playback.

- Slow playback is engaged.
- During slow playback, the speed of playback can be adjusted from 1/2 normal playback speed to 1/16 normal playback speed in four steps using **STEP/SLOW ◀II** and **STEP/SLOW II▶**.

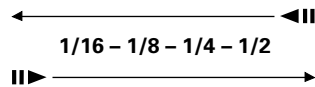

Press and hold STEP/SLOW ◀II during DVD playback.

- Slow playback in the reverse direction is engaged.
- In the reverse direction, the playback speed cannot be adjusted.

To return to normal playback

When viewing still frames or slow playback, pressing **PLAY ►** restores normal playback operation.

Frame by frame advance playback: Viewing one frame at a time

1 Press PAUSE II.

2 Press STEP/SLOW ◀II or STEP/SLOW II▶.

STEP/SLOW II▶: The picture advances one frame each time the button is pressed.

STEP/SLOW ◀II: The picture backs up a DVD a few frames each time the button is pressed.

To return to normal playback

When viewing frame by frame playback, pressing **PLAY ►** restores normal playback operation.

Notes

- There is no sound when viewing still frames or slow playback, or when advancing one frame at a time.
- Still frame, slow play, or frame advance playback may not be possible with certain titles. In this case, the  mark is displayed.

Searching for a Title, Chapter, Track, or Location on a Disc

– DVD/Video CD/CD

This player offers different ways of accessing the information on a DVD, Video CD, or CD. Using **SEARCH MODE**, you can search for titles or chapters on a DVD, tracks on a Video CD or CD, and even select the point in time to start playback.

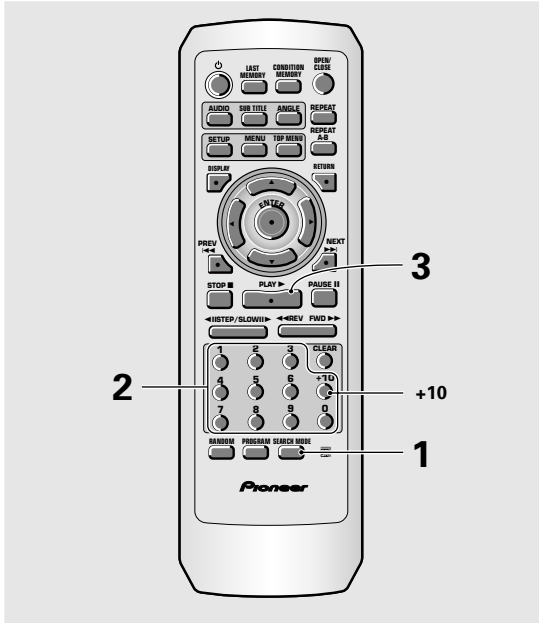

1 Press SEARCH MODE repeatedly to select the type of search.

The type of search changes which each press as follows.

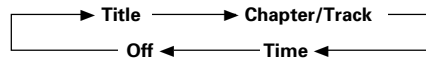

2 Press the number button(s) of the desired title, chapter or track or of the specific time where you would like to begin playback.

- To select number 3, press **3**.
- To select number 10, press **1** and **0**.
- To select number 87, press **8** and **7**.

When performing a time search:

- To select 21 minutes, 43 seconds, press **2, 1, 4,** and **3**.
- To select 1 hour, 14 minutes, press **7, 4, 0,** and **0**.

3 Press PLAY ►.

Playback of the selected title, chapter or track starts. When a time search is performed, playback begins at the appointed time.

Notes

- For some discs, selection can be made using the top menu on the DVD. In this case, press **TOP MENU** to display the menu screen and then make your selection.
- With some DVDs, the search operation may not be possible and may stop shortly after being performed. In this case, the mark is displayed.
- Time search is not possible with CDs.
- When performing DVD time search, playback may start from a slightly different time than that specified.
- Time search is not possible during when the disc is stopped.
- Search using time search is not possible during PBC playback of Video CDs.

To perform a direct title or chapter/track search using the number buttons

- Press the **number buttons** while the disc is stopped to select a title number.
- Press the **number buttons** while the disc is playing to select a chapter or track.
 - To select number 3, press **3**.
 - To select number 10, press **+10** and **0**.
 - To select number 37, press **+10,+10,+10** and **7**.

Note

Direct search cannot be performed for title, chapter, or track numbers 20 or higher. To search for titles, chapters, or tracks with numbers 20 or higher, use the title or chapter/track search procedures using **SEARCH MODE** as described on this page.

Repeat Play – DVD/Video CD/CD

You can repeat an entire title, chapter or track, or just a part.

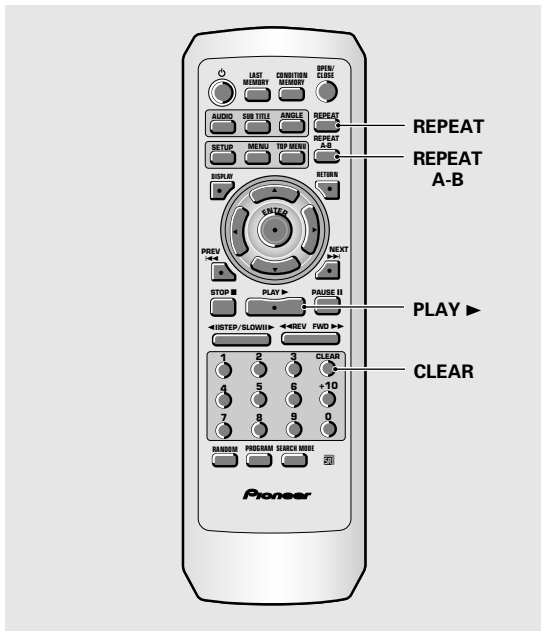

Repeat play of a chapter/track

Press **REPEAT** once during playback of the chapter or track you want to repeat.

Repeat play of a title

Press **REPEAT** twice during playback of the title you want to repeat.

- With DVDs, the title continues playing until the end, and then playback starts once more from the beginning of that title.
- With CDs and Video CDs, a disc is considered a single title, so the entire disc is repeated.

To repeat a program

Press **REPEAT** once during program playback to repeat the program.

To cancel repeat play

Press **CLEAR**. Playback continues, but the repeat function is canceled.

Repeat play of a specified section

Press **REPEAT A-B** at the beginning and end of the section you want to repeat.

- When **REPEAT A-B** is pressed a second time, the disc returns to the location where **REPEAT A-B** was pressed first and plays the selected section repeatedly.
- You can only perform A-B repeat within the same title, chapter, or track.

To cancel A-B repeat play

Press **CLEAR**. Playback continues, but the repeat function is canceled.

Return to a specified location on a disc

- 1 Press **REPEAT A-B** at the desired location.
- 2 When you want to return to the specified location, press **PLAY** ►.

To clear the specified location

Press **CLEAR** to cancel repeat play or to clear the specified location that was set using **REPEAT A-B**.

Notes

- With some DVD discs, there may be times when repeat playback is not possible. In these cases, the  mark will appear on the screen.
- With Video CDs, repeat play is not possible when the menu is displayed (PBC playback). To perform repeat play, start playback without displaying a menu by pressing the track number to be repeated when the disc is stopped, and then press **REPEAT**.
- If you switch camera angle during repeat play, repeat play is cancelled.

Random Play – DVD/Video CD/CD

Play titles, chapters, or tracks on a disc in random order.

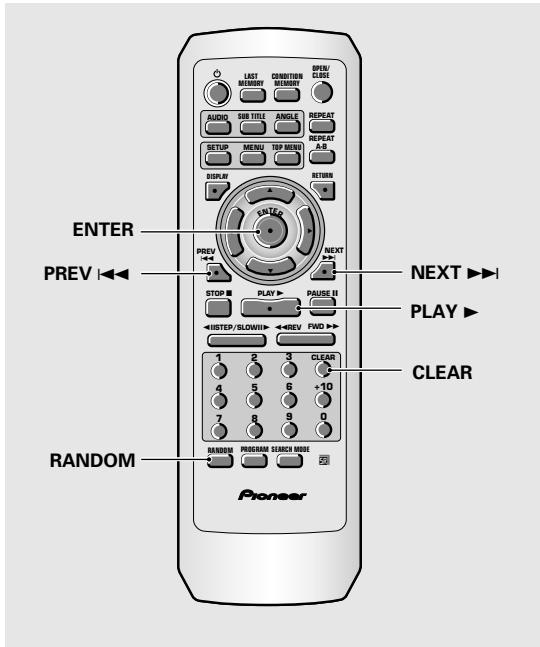

Random playback of chapters within one title – DVD

Press **RANDOM** once, then press **ENTER** or **PLAY** ▶.

“Random Chapter” appears on the screen, and chapters within the title will be played back in random order.

Random playback of titles – DVD

Press **RANDOM** twice, then press **ENTER** or **PLAY** ▶.

“Random Title” appears on the screen, and titles will be played back in random order.

Random playback of tracks – Video CD/CD

Press **RANDOM**.

“Random” appears on the screen, and random playback begins.

To change titles, chapters, or tracks during random play

- Press **NEXT** ▶▶ and the next randomly selected track starts playing.
- Press **PREV** ◀◀ and playback of the current track starts again from the beginning.

To stop random play

Press **CLEAR**. This returns you to normal playback of chapters/tracks in order from the chapter/track currently playing.

Notes

- With Video CDs, random play is not possible during playback when the menu is displayed (PBC playback). To perform random play, start playback without displaying a menu by pressing a track number button while in the stop mode, and then press **RANDOM**.
- Random play of programmed chapters/tracks is not possible.
- In the case of DVDs, random playback may not be possible with some discs.
- Repeat playback of random playback is not possible. In these cases, the  mark will appear on the screen.

Playback in a Desired Order (Program Play) – DVD/Video CD/CD

The titles and chapters within a title on a DVD and similarly the tracks on a Video CD or CD can be arranged to play in the order you want.

Programming DVDs

A program with a maximum of 24 steps can be memorized.

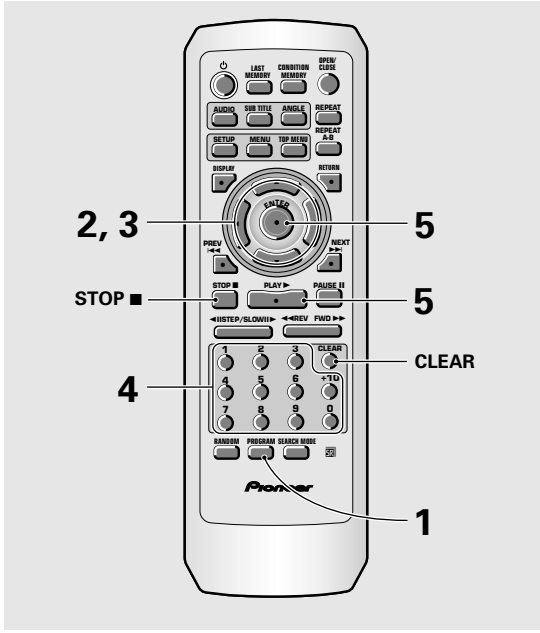

1 Press PROGRAM.

The Program screen appears.

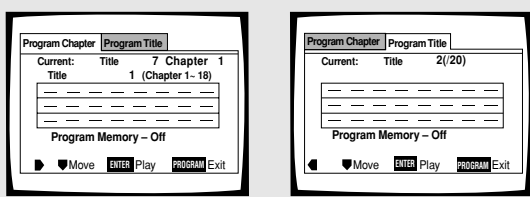

2 Use the cursor buttons (◀/▶) to select either Chapter or Title program.

3 Once the program type is selected. Use the cursor button (▼) to enter the program window.

When [Program Chapter] is selected, you must also select what title the chapters to be programmed are in. Use the **cursor button** (▲) to highlight "Title" and then use the **number buttons** to enter the title number to be used.

4 In the program window, use the number buttons to enter the numbers of the titles or chapters in the order you want to program them in.

- To program DVD titles/chapters 9, 7, and 18 in order, press **9, 7, +10** and **8**.

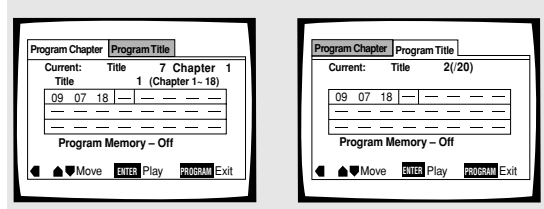

5 Press ENTER or PLAY ▶.

- Playback starts in the set order.
- Press **PROGRAM** to return to the previous display. The program will not begin until **PLAY ▶** is pressed.

To program a pause in a program

Press **PAUSE II** instead of a **number button**.

"II" appears on the screen and the pause can be programmed.

A pause cannot be programmed as the first or last position in a program, and two or more pauses cannot be programmed in succession.

To delete a number:

Use the **cursor buttons** (▲/▼/◀/▶) to highlight the incorrect number and then press **CLEAR**.

The number is deleted. If the number was before another number, the later numbers are reordered automatically.

To insert a number:

Use the **cursor buttons** (▲/▼/◀/▶) to highlight the number to be placed after the new number and then press the **number button(s)** of the number to be inserted.

The new number is inserted before the previously selected number.

To stop program play

Press **STOP ■**.

Notes

- When programming chapters, chapters not programmed may appear on the screen. This is not a malfunction.
- Programming may not be possible with certain DVD discs. On these types of discs, the  mark will appear on the screen when programming is attempted.
- Only chapters within the same title can be programmed during chapter programming.

Programming Video CDs, CDs

A program with a maximum of 24 steps can be memorized.

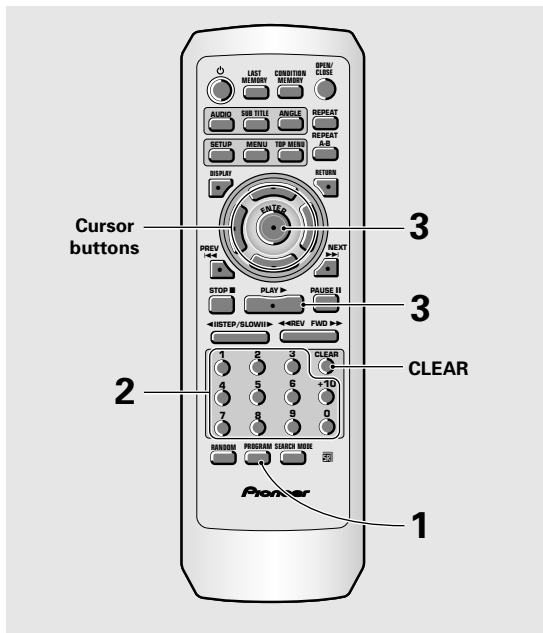

1 Press PROGRAM.

The program screen appears. When a Video CD or CD is loaded, the cursor appears in the program window.

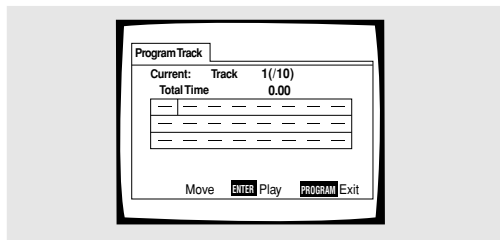

2 Use the number buttons to enter the numbers of the tracks in the order you want to program them in.

- To program tracks 9, 7, and 18 in order, press **9**, **7**, **+10** and **8**.
- To edit the program, refer to the procedures on the previous page.

3 Press ENTER or PLAY ►.

- Playback starts in the specified track order.
- To stop the program play, press **STOP** ■.

Notes

- To program a pause, or to add or delete a number, refer to the procedures for 'Programming DVDs' on **page 42**.
- You cannot program when playing a Video CD using menu selections (during PBC).

Additional programming options

– DVD/Video CD/CD

After you have made a program, it is then possible to confirm, add, or clear the contents of the program.

To confirm the contents of a program:

On a CD or Video CD track program, press **PROGRAM** to confirm. The program screen displays the current program.

On a DVD, select the program type (title or chapter) with the **cursor buttons** (◀▶). The current DVD title or chapter program can then be confirmed on the appropriate program screen.

To add to a program:

- 1 Press **PROGRAM**.
- 2 Press a **number button** to add a new title, chapter, or track at the end of the program.
- 3 Press **PROGRAM** to exit the program screen.

To delete a program:

- 1 Press **PROGRAM**.
- 2 Select the program with the **cursor buttons** (◀▶), then press **CLEAR**.
- 3 Press **PROGRAM** to exit the program screen.

Notes

- The complete program will be deleted even if the disc tray is open.
- Pressing **CLEAR** when the disc is stopped will clear all programs.

To make a program of your favorite parts of a disc as it plays – DVD/Video CD/CD

With this player, it is possible to make a program as you watch a DVD or Video CD or while listening to a CD.

Press and hold PROGRAM for at least 2 seconds at any point during playback of a title, chapter, or track you want to program, and it will be made into or added to a program without displaying a Program screen. When a title, chapter, or track is successfully added to the program, it is shown momentarily in the display as well as its position in the program.

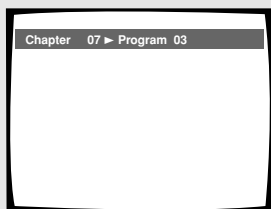

To erase a program saved in memory – DVD

The player erases programs in chronological order when the maximum number of programs that can be held in memory is exceeded. To prevent the player from erasing older programs that you may still use regularly, or when you don't want to use a program anymore, it is possible to manually erase programs stored in memory.

1 Load a DVD that has a program stored in memory.

2 Press PROGRAM.

The program screen appears.

3 Use the cursor button (▼) to highlight [Program Memory] and use the cursor buttons (▶/▼) to select [Off].

4 Press ENTER.

The program is cleared from memory.

To confirm the contents of a program:

Press **PROGRAM**.

Notes

- When using this function to program DVDs, the program being created corresponds to the Program screen (chapter or title) that appears when **PROGRAM** is pressed. Be sure to check that the appropriate program type is selected.
- You cannot make a program containing chapters in different titles.

To save a program in memory – DVD

This player can memorize the programs on up to 24 DVDs. By turning the **[Program Memory]** to **[On]**, the player will save your program and recall it the next time you use the same DVD. When the program memory exceeds 24, programs will be erased in chronological order from the oldest program in memory.

1 Use the cursor button (▼) to highlight [Program Memory] and use the cursor button (▶) to select [On].

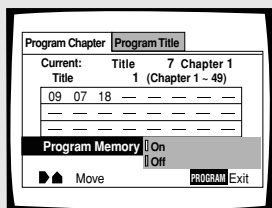

2 Press ENTER.

The program is saved in memory.

Note

When a DVD with a program stored in memory is loaded, program playback may start automatically.

Continuing Playback from a Specified Location (Last Memory) – DVD/Video CD

The Last Memory function is convenient when you want to continue viewing a disc from the point where you were watching before. Unlike the resume function, the Last Memory function is effective even if the DVD is removed from the player (Last Memory locations saved for Video CDs are effective only if the disc remains loaded in the player).

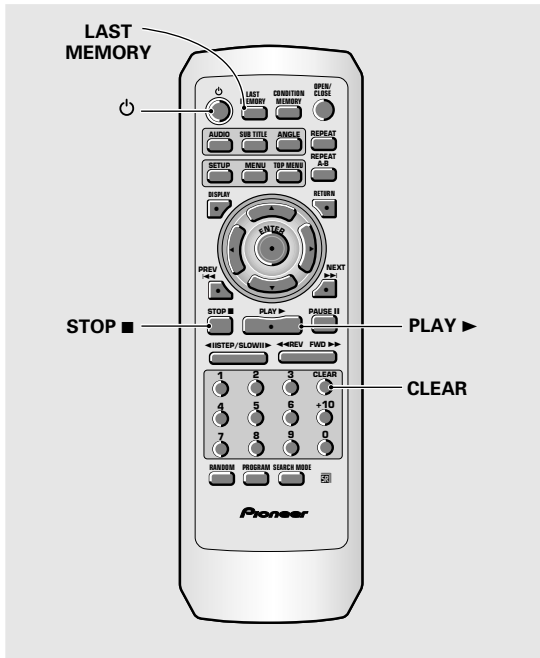

Memorizing a Last Memory location to return to later

1 Press LAST MEMORY during play.

The "LAST" indicator lights on the player.

2 Press \odot to turn the power to standby, or stop playback with STOP ■.

Once memorized, the memorized point will be recalled even if the power is turned off, or if the disc is ejected. Points on up to 5 discs can be memorized, and those points are recalled the next time any of the discs are played back.

- A Last Memory point can be memorized for only one Video CD at a time as the function is only effective until the Video CD is removed from the player.

Resuming playback from where LAST MEMORY was pressed

1 Load a disc that has a Last Memory point memorized.

Some DVDs will start playback automatically when loaded. In this case, press **STOP** ■ to stop playback.

2 Press LAST MEMORY while in the stop mode.

The disc begins playback at the memorized point.

- Last Memory mode may not function for some DVDs.
- If you register more than five DVDs, details of the latest disc are memorized, while details of the least recent disc (the disc you registered first) is erased.
- Even with a disc you have memorized with Last Memory, playback begins at the start of the disc if you press **PLAY** ►.
- This function is for playback of DVDs or Video CDs only. You cannot use it with CDs.

To clear the Last Memory location

1 Load a disc that has a Last Memory point memorized.

Some DVDs will start playback automatically when loaded. In this case, press **STOP** ■ to stop playback.

2 Press LAST MEMORY while in the stop mode.

The disc begins playback at the memorized point.

3 Once the picture appears, press LAST MEMORY again.

4 While "Last Memory" is displayed on the screen, press CLEAR.

The "LAST" indicator disappears from the display.

Memorizing Settings for Often Viewed DVDs (Condition Memory) – DVD

You can store in memory settings for DVDs you often watch. Settings remain in memory even if you remove the disc from the player, or switch power to the player to standby. If you load a disc that has its settings memorized, “COND.” appears in the display. When you start playing the disc, the memorized settings are automatically recalled.

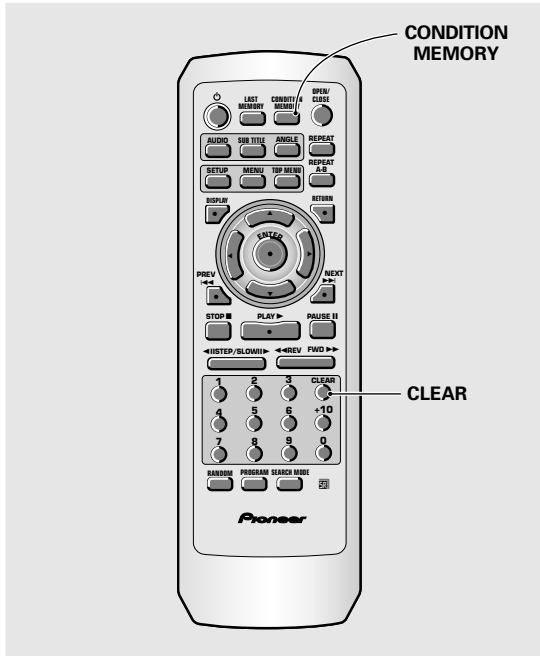

Press CONDITION MEMORY during playback.

Settings are memorized for the disc currently playing.

The following six settings are memorized:

Picture Quality (page 29)

On Screen Display (page 29)

Multi-Angle (page 30)

Multi-language (pages 31, 32)

Multi-Language subtitles (page 33)

Parental Lock Level (page 36)

When a disc that has memorized settings is loaded

“Condition Memory” will appear on the screen, and the previously memorized settings will be selected.

Erasing the recorded contents

Load a disc that has memorized settings, and press **CLEAR** while “Condition Memory” is being displayed. The disc’s recorded data will be erased.

Notes

- Settings are stored in memory for use any time.
- You can store settings for up to 15 DVDs in memory. If you memorize settings for more than 15 DVDs, previously memorized settings are erased in chronological order from the least recently memorized. Subsequently, if you load a disc with erased settings, the settings of the most recently played disc are used.
- If you make changes to any of the settings memorized in Condition Memory, press **CONDITION MEMORY** during playback to memorize new settings.
- Switching of the multi-language mode etc., is automatic on some discs.

Viewing Disc Information

– DVD/Video CD/CD

Use **DISPLAY** to get current information about the disc currently loaded. You can get information about the titles and chapters on a DVD or tracks on a Video CD or CD. When viewing DVDs, you can also check the digital bitstream transmission rate.



Press DISPLAY during while a disc is playing. Press DISPLAY repeatedly to change the information being displayed.

The disc information is displayed superimposed over the video image on the screen.

Press and hold DISPLAY to display the time remaining on the disc.

When you release the button, the information disappears.

Note

Depending on the format and type of disc being used, not all screens may be displayed.

The display changes for each type of disc as follows each time the button is pressed.

DVD



TITLE information:

Top Row: title and chapter number, elapsed time of current title

Bottom Row: remaining time in title, total time of title

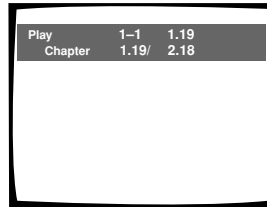

CHAPTER information:

Top Row: title and chapter number, elapsed time of current title

Bottom Row: time in current chapter, total time of chapter

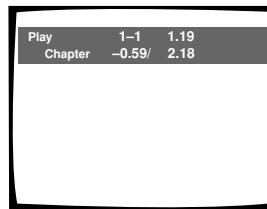

CHAPTER information:

Top Row: title and chapter number, elapsed time of current title

Bottom Row: remaining time in current chapter, total time of chapter

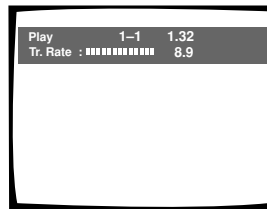

Data transmission rate information:

Top Row: title and chapter number, total elapsed time of DVD

Bottom Row: bitstream transmission rate level



Display off

CD

Play	1	0.03
Track	-3.29/	3.32

Track Information:

Top Row: current track number, track time

Bottom Row: remaining time of current track, and total time of track



Play	1/2	0.15
All	-6.15/	6.32

Disc information:

Top Row: current track number, total number of tracks on CD, total elapsed time of CD

Bottom Row: remaining time of CD, total time of CD



Display off

Video CD (with PBC disabled)

Play	5/10	20.19
All	-2.38/	22.57

Disc information:

Top Row: current track number, total number of tracks, total elapsed time of Video CD

Bottom Row: remaining time of Video CD, total time of Video CD



Play	5	20.19
Track	2.38/	4.40

Track information:

Top Row: current track number, total elapsed time of Video CD

Bottom Row: track time, total time of track



Play	5	20.19
Track	-2.02/	4.40

Track information:

Top Row: current track number, total elapsed time of Video CD

Bottom Row: remaining time of track, total time of track



Display off

Note

When playing Video CDs in PBC mode or unfinalized CD-Rs not all the above information is displayed.

Press **DISPLAY** during while a disc is stopped to display DVD title and chapter information or Video CD and CD track information. Press **DISPLAY** again to turn the display off.

Information about the titles and chapters or tracks on a disc is displayed. When the information exceeds the space on the screen, use the **cursor buttons** (◀▶) to move to other screens.

DVD

Information: DVD			
Title	Chapter	Title	Chapter
01	1- 1	06	1- 1
02	1- 1	07	1- 1
03	1- 1	08	1- 1
04	1- 1	09	1- 4
05	1- 1		
1/1		DISPLAY Exit	

DVD information

When a DVD is loaded, each title and the number of chapters within each title is displayed.

CD and Video CD

Information: Compact Disc		
Total Time	6.30	
Track	Time	
01	3.32	
02	2.58	
1/1		DISPLAY Exit

CD and Video CD information

When a CD or Video CD is loaded, the total time of the disc and the time of each track on the disc is displayed.

Resetting the Player to System Settings

To reset the player, press and hold **■ (stop)** on the front panel when pressing **⏻ STANDBY/ON** to turn the unit from standby to on .

All program memory, saved settings from functions such as Last Memory and Condition Memory are cleared, TV System is reset to **AUTO** and all Setup screen menus are returned to factory settings.

Additional Information

Disc Care

How to hold discs

When loading or removing discs, try not to touch their playing surfaces.



Cleaning

Fingerprints or other dirt on the disc may affect sound and picture quality.

To clean your discs, use a soft clean cloth to wipe them. If necessary, moisten a soft cloth with diluted neutral detergent to remove heavy dirt or fingerprints.



Do not wipe in a circular direction (Concentric scratches in the disc groove tend to cause noise.)



Gently wipe from the inside toward the outer edge.

Discs must not be cleaned with record cleaning sprays, or static prevention sprays, etc. Also do not use volatile liquids such as benzine, or thinner, etc.

Never play cracked or warped discs

The disc revolves in the player at high speed when it is played. Never play a cracked, scratched or warped disc. This may damage the player or cause it to malfunction.

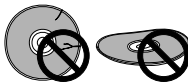

Never use discs with special shapes

CD's with special shapes (heart-shaped CDs, octagonal CDs, etc.) cannot be played on this set.

Attempting to do so may damage the set. Do not use such CDs.

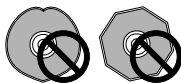

After using discs, store them upright

After playing a disc, always remove it from the player and return it to its jacket. Then store it standing upright away from heat and humidity.

- Store discs carefully. If you store discs at an angle, or stacked on top of each other, discs may become warped even when in their jackets.
- Do not leave discs in locations such as the seat of a car, which may become excessively hot.

CAUTION WHEN USING THE DISC

All rights reserved.

Unauthorized public performance, broadcasting or copying is a violation of applicable laws.

For Proper and Long Use of This Unit

Do not move the unit during playback

During playback, the disc rotates at high speed. Do NOT lift or move the unit during playback. Doing so may damage the disc.

When moving the unit

When changing places of installation or packing the unit for moving, be sure to remove the disc and return the disc table to its original position in the player. Then, press \odot **STANDBY/ON** and switch the power to standby. **Check that the "--OFF--" indication on the display goes off**, then disconnect the power cord. Moving this unit with the disc loaded may result in damage to this unit.

Installation

- Select a stable place to the side of a TV set or stereo system to be connected to the unit.
- When using the unit with a stereo system, install the speakers a little bit away from the TV.
- Do NOT install the unit on top of a TV or color monitor. Install the unit away from equipment that may be affected by magnetism, such as a cassette deck.
- Do NOT place objects on top of the unit.

Avoid installing in a place that is:

- Exposed to direct sunlight
- Exposed to humidity or where ventilation is poor
- Extremely hot or cold
- Exposed to vibration
- Exposed to dust
- Exposed to oily smoke, steam or heat (for example, a kitchen)

Do not block vents

Do NOT use the player on top of a long-fibered carpet, bed or sofa, and do not cover it with a cloth, etc. This will prevent heat radiation and could result in damage.

Avoid heat

Do NOT place the unit on equipment which generates heat, such as an amplifier.

When installing the unit in a rack, place it on the lowest shelf possible (however, not where it is exposed to dust) and separated from the amplifier to avoid the heat generated by the amplifier or other audio equipment.

CAUTION: WHEN PLACING THE UNIT IN A STEREO RACK WITH GLASS DOORS

Be sure there is ample space between the unit and the glass doors when opening the disc table using the remote control. If the disc table opens against strong resistance, such as a closed glass door, damage to the unit may result.

Condensation

Moisture may form in the operating section of the player if the player is brought from cool surroundings into a warm room or if the temperature of the room rises suddenly. When this happens, the player's performance will be impaired.

To prevent this, let the player stand in its new surroundings for about an hour before switching it on, or make sure that the room temperature rises gradually. Condensation may also form during the summer if the player is exposed to the breeze from an air conditioner. In such cases, change the location of the player.



Switch POWER to STANDBY when not using the unit

Depending on the strength of the TV or radio broadcast signal, having the TV or radio on while power to the unit is on may result in stripes on the TV screen or noise. However, this is not a malfunction of this unit or the TV or radio. In such a case, switch the power of the unit to standby.

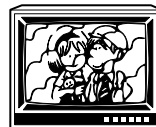

Power-cord caution

Handle the power cord by the plug. Do not pull out the plug by tugging the cord and never touch the power cord when your hands are wet as this could cause a short circuit or electric shock. Do not place the unit, a piece of furniture, etc., on the power cord, or pinch the cord. Never make a knot in the cord or tie it with other cords. The power cords should be routed in such a way that they are not likely to be stepped on. A damaged power cord can cause a fire or give you an electrical shock. Check the power cord once in a while. When you find it damaged, ask your nearest PIONEER authorized service center or your dealer for a replacement.

Cleaning the player

To clean the PLAYER, wipe with a soft, dry cloth. For stubborn dirt, wet a soft cloth with a mild detergent solution made by diluting one part detergent to 5 or 6 parts water, wring well, then wipe off the dirt. Also use a dry cloth to wipe the surface dry. Do not use volatile liquids such as benzene and thinner which are harmful to the unit.

Lens cleaner

The player's pickup lens should not become dirty in normal use, but if for some reason it should malfunction due to soiling, contact your nearest PIONEER authorized service center. Lens cleaners are commercially available, but special care should be exercised in their use since some may cause damage to the lens.

Notes on using optical cables

- Do not route cords around sharp angles. When storing, wind the cords so that they have a diameter of at least 15 cm.
- When connecting, push all the way into the terminal.
- Do not use cords with a length of over 3 m.
- If moisture or dust has collected on the plug, wipe it with a soft cloth before connecting.

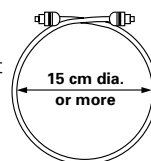

Language Code List

Language codes are used when setting the audio and subtitle language preferences (**page 34**).

Language	Input-code
Japanese (ja)	1001
English (en)	0514
French (fr)	0618
German (de)	0405
Italian (it)	0920
Spanish (es)	0519
Chinese (zh)	2608
Dutch (nl)	1412
Portuguese (pt)	1620
Swedish (sv)	1922
Russian (ru)	1821
Korean (ko)	1115
Greek (el)	0512
Afar (aa)	0101
Abkhazian (ab)	0102
Afrikaans (af)	0106
Amharic (am)	0113
Arabic (ar)	0118
Assamese (as)	0119
Aymara (ay)	0125
Azerbaijani (az)	0126
Bashkir (ba)	0201
Byelorussian (be)	0205
Bulgarian (bg)	0207
Bihari (bh)	0208
Bislama (bi)	0209
Bengali (bn)	0214
Tibetan (bo)	0215
Breton (br)	0218
Catalan (ca)	0301
Corsican (co)	0315
Czech (cs)	0319
Welsh (cy)	0325
Danish (da)	0401
Bhutani (dz)	0426
Esperanto (eo)	0515
Estonian (et)	0520
Basque (eu)	0521
Persian (fa)	0601
Finnish (fi)	0609
Fiji (fj)	0610
Faroese (fo)	0615
Frisian (fy)	0625
Irish (ga)	0701
Scots-Gaelic (gd)	0704
Galician (gl)	0712
Guarani (gn)	0714

Language	Input-code
Gujarati (gu)	0721
Hausa (ha)	0801
Hindi (hi)	0809
Croatian (hr)	0818
Hungarian (hu)	0821
Armenian (hy)	0825
Interlingua (ia)	0901
Interlingue (ie)	0905
Inupiak (ik)	0911
Indonesian (in)	0914
Icelandic (is)	0919
Hebrew (iw)	0923
Yiddish (ji)	1009
Javanese (jv)	1023
Georgian (ka)	1101
Kazakh (kk)	1111
Greenlandic (kl)	1112
Cambodian (km)	1113
Kannada (kn)	1114
Kashmiri (ks)	1119
Kurdish (ku)	1121
Kirghiz (ky)	1125
Latin (la)	1201
Lingala (ln)	1214
Laothian (lo)	1215
Lithuanian (lt)	1220
Latvian (lv)	1222
Malagasy (mg)	1307
Maori (mi)	1309
Macedonian (mk)	1311
Malayalam (ml)	1312
Mongolian (mn)	1314
Moldavian (mo)	1315
Marathi (mr)	1318
Malay (ms)	1319
Maltese (mt)	1320
Burmese (my)	1325
Nauru (na)	1401
Nepali (ne)	1405
Norwegian (no)	1415
Occitan (oc)	1503
Oromo (om)	1513
Oriya (or)	1518
Panjabi (pa)	1601
Polish (pl)	1612
Pashto, Pushto (ps)	1619
Quechua (qu)	1721

Language	Input-code
Rhaeto-Romance (rm)	1813
Kirundi (rn)	1814
Romanian (ro)	1815
Kinyarwanda (rw)	1823
Sanskrit (sa)	1901
Sindhi (sd)	1904
Sangho (sg)	1907
Serbo-Croatian (sh)	1908
Sinhalese (si)	1909
Slovak (sk)	1911
Slovenian (sl)	1912
Samoan (sm)	1913
Shona (sn)	1914
Somali (so)	1915
Albanian (sq)	1917
Serbian (sr)	1918
Siswati (ss)	1919
Sesotho (st)	1920
Sundanese (su)	1921
Swahili (sw)	1923
Tamil (ta)	2001
Telugu (te)	2005
Tajik (tg)	2007
Thai (th)	2008
Tigrinya (ti)	2009
Turkmen (tk)	2011
Tagalog (tl)	2012
Setswana (tn)	2014
Tonga (to)	2015
Turkish (tr)	2018
Tsonga (ts)	2019
Tatar (tt)	2020
Twi (tw)	2023
Ukrainian (uk)	2111
Urdu (ur)	2118
Uzbek (uz)	2126
Vietnamese (vi)	2209
Volapük (vo)	2215
Wolof (wo)	2315
Xhosa (xh)	2408
Yoruba (yo)	2515
Zulu (zu)	2621

Troubleshooting

Incorrect operations are often mistaken for trouble and malfunctions. If you think that there is something wrong with this component, check the points below. Sometimes the trouble may lie in another component. Inspect the other components and electrical appliances being used. If the trouble cannot be rectified even after exercising the checks listed below, ask your nearest PIONEER authorized service center or your dealer to carry out repair work.

The disc table comes back out automatically, shortly after the disc table is closed.

The disc is dirty or warped.

- ➔ Refer to 'Disc Care' (page 49).

The disc is not placed properly on the disc table.

- ➔ Use the disc table guide to align the disc (page 20).

Region number does not conform with this unit.

- ➔ If the region number on the disc does not match the number on the player, the disc cannot be used (page 55).

There is condensation on the operating section of the player.

- ➔ Allow time for condensation to evaporate. If player is near an air conditioning unit, you should move the player (page 50).

Playback is not possible.

The disc has been loaded upside down.

- ➔ Check that the disc has been loaded with the label side facing up.

mark appears on screen.

The selected function does not operate for that disc.

mark appears on screen.

The operation is prohibited by the player.

Picture playback stops and the operation buttons cannot be used.

Player malfunctions.

- ➔ Stop disc playback (press **STOP** ■), then start playback again.

New settings made in the Setup screen menus while a disc is playing are ineffective.

Some settings can be changed while a disc is playing, but are not effective. This is not a malfunction.

- ➔ Make the same setting when the player is stopped.
- ➔ Stop disc playback (press **STOP** ■), then start playback again. When playback is resumed, the new settings should be in effect. Please note that making settings in the Setup screen menus may cancel the resume function.

When making changes in the Setup screen menus, is displayed.

There is a Video CD or CD loaded in the player and the setting that was changed only applies to DVD performance.

- ➔ The setting will be effective the next time a DVD is loaded.

Settings are canceled.

When the power is turned off by power failure or by unplugging the power cord, settings will be canceled.

- ➔ Before unplugging the power cord, press  **STANDBY/ON** and check that "--OFF--" disappears in the display.

No picture.

The rear panel's **VIDEO OUT SELECT** switch setting is not correct.

- ➔ Check that the **VIDEO OUT SELECT** switch is set to the correct position for the monitor connection you are using (page 16).

Connection is incorrect.

- ➔ Check that cord connections are correct and that plugs are firmly connected.

Operation (settings) of TV or AV amplifier is not appropriate.

- ➔ Be sure that your TV, receiver, or amplifier is set up to view DVD playback.

The screen is stretched or aspect does not change.

The multi aspect setting is not appropriate.

- ➔ Change the aspect setting in the **[TV Screen]** setting in the Setup screen **Video** menu to the screen type most appropriate to the TV or monitor you are using (page 28).

Picture disturbance during playback or dark.

This player is compatible with Macro-Vision System copy guard. Some discs include a copy prevention signal, and when this type of disc is played back, stripes etc., may appear on some sections of the picture depending on the TV.

- ➔ This is not a malfunction.

The TV system may be set inappropriately.

- ➔ See "Setting the TV System" on page 17.

Discs respond differently to particular player functions which may result in the screen becoming black for a brief instant or shaking slightly when the function is executed.

- ➔ These problems are largely due to differences between discs and disc content and are not malfunctions of this player.

Audio is output from the analog output jacks but not from the digital output jacks.

Player settings are incorrect.

- ➔ In the **Audio 1** menu, check that the appropriate digital audio output formats are selected, and that the **[Digital Out]** setting is not set to **[Off]** (page 27).

When recorded on a VCR or passed through an AV selector, there is disturbance in the playback picture.

Due to the player's copy protection circuits, connection of this device through a VCR or an AV selector may prevent recording or cause picture problems.

- ➔ This is not a malfunction.

Remote control operation is not possible.

The rear panel control input jack on the player is being used.

- ➔ Point the remote control at the component that the player is connected to (**page 16**).

The remote control is too far from the player, or the angle with the remote sensor is too wide.

- ➔ Be sure to operate the remote from a location within its operating range (**page 8**).

The batteries are exhausted.

- ➔ Replace the exhausted batteries with all new batteries (**page 8**).

Audio is not output or is distorted.

The Setup screen **Audio 1** menu **[96 kHz PCM Out]** setting is set to **[96 kHz]**.

- ➔ Either connect using the analog outputs, or set **[96kHz PCM Out]** in the **Audio 1** menu to **[96kHz ▶ 48 kHz]** (**pages 15, 26**).

The disc is dirty.

- ➔ Refer to '*Disc Care*' (**page 49**).

The connection plugs are not inserted fully into the terminals or are not connected.

- ➔ Check that all connection plugs are firmly inserted.

The connection plug or terminal is dirty.

- ➔ Check that the plugs and terminals are wiped clean of dirt, etc.

Audio cable connection is wrong.

- ➔ Check to make sure that the audio cables are connected correctly (**page 15**).

Connection is made to the stereo amplifier's PHONO input terminal.

- ➔ Change connection to any input terminal except PHONO.

The pause mode is engaged.

- ➔ Press **PLAY ▶** or **PAUSE II** to exit the pause mode.

Stereo amplifier operation is incorrect.

- ➔ Check input (CD, AUX, etc.) selector to determine if it is selected for DVD playback.

The DVD or CD is recorded in DTS audio.

- ➔ DTS audio is only output from the digital output jacks. Connect the digital output on the player to the digital input on a receiver or amplifier with a built in DTS decoder to hear DTS audio.

Noticeable difference in DVD and CD volume.

DVDs and CDs use different recording methods.

- ➔ This is not a malfunction.

Caution

Static electricity or other external influence may cause malfunctioning of this unit. In this case, unplugging the power cord and then re-plugging it in will usually reset the unit for proper operation. If this does not correct the problem, please consult your nearest PIONEER service center.

Terms

Aspect ratio

Aspect ratio refers to the length to height ratio of TV screens. The ratio of a standard TV is 4:3, while the ratio of a high-definition or wide TV is 16:9. The latter allows you to enjoy a picture with a wider perspective.

Chapter number

Chapter numbers are the numbers assigned to sections of a title on the disc, similar to chapters in a book. If the disc includes chapter numbers, you can locate the section you want very quickly using search and other functions.

Component (color difference) video output

The color signal of the TV is divided into the luminance (Y) signal and the color (P_B and P_R) signals and then output. In this way mutual interference of each signal is avoided. On a TV with component input jacks, these signals are synthesized to produce the picture.

Condition memory

“Condition” refers to the various mode settings, etc. On this player, various conditions, such as those set during playback, can be memorized. This function allows you to play back the same disc at any time without having to redo your preferred settings.

Digital bitstream

The bitstream does not refer to the audio signal, but rather to the digital data that, once converted, becomes the audio signal. The player outputs digital bitstreams via the digital optical or digital coaxial output. If the bitstream cannot be decoded by the connected AV amplifier etc., digital noise is produced. Digital bitstream formats compatible with different entertainment systems can be selected in the Setup screen **Audio 1** menu.

Digital output (Coaxial)

Output of the digital audio signal is transmitted electronically using a coaxial cable. Because the signal being transmitted is digital, connection must be made to the coaxial digital input of another component. Noise will be output if connected to the analog audio inputs as the digital signal cannot be decoded.

Digital output (Optical)

Normally, audio is converted to an electric signal and transmitted through an electric wire from the player to the amplifier, etc. Changing this signal to a digital signal and transmitting it through a fiber-optic cable is called optical digital output. Similarly, optical digital input receives digital signals from external units such as an AV amplifier or receiver.

Dolby Digital

Using a maximum of 5.1 channels of audio, this high quality surround system is used in many of the finer movie theaters around the world.



DTS

DTS stands for Digital Theater System. DTS is a surround system different from Dolby Digital that has become a popular surround sound format for movies. In order to enjoy the benefits of DTS encoded discs, the digital output jack (either coaxial or optical) of this player needs to be connected to an AV amplifier or receiver or to a DTS decoder to be able to enjoy the surround sound of DTS audio. DTS audio is not output from the analog audio outputs.



Dynamic range

Dynamic range refers to the difference between the maximum and minimum levels of the audio soundtrack as measured in decibels (dB).

Compressing the dynamic range raises the minimum signal level and lowers the maximum signal level. This allows you to hear voices and other low level audio signals clearly while lowering strong audio signals like the sound of explosions.

MPEG

Short for Moving Picture Experts Group. This is an international standard for compression of moving images. On some DVDs, digital audio has been compressed and recorded in this format.

Multi-angle

When you watch a TV program, you are watching the image filmed through the TV camera. Because of this, the picture is displayed on your TV from the viewpoint of the TV camera's position. In a TV studio, the image is filmed by many cameras at the same time, and one of those images is selected by the program director and transmitted to your TV. If all the filmed images were transmitted to your TV you would be able to select the camera image you want. Some DVD discs are recorded with the angles of more than one camera used for filming, and these can be selected using this player. These types of discs are called multi-angle discs.

Parental lock level

This function was suggested by parents concerned about what type of media their children were able to watch. Parental lock restrictions are restrictions incorporated into titles which include scenes that parents may not wish their children to view.

PCM

PCM stands for Pulse Code Modulation and is digital audio. The digital audio of CDs is PCM. This player also has a function that converts Dolby Digital and MPEG digital bitstreams into PCM to enable you to listen to quality digital sound even without a special decoder.

Playback Control (PBC)

This refers to signals recorded on a Video CD (Version 2.0) enabling playback control.

You can use menus recorded on discs with PBC for easy, interactive search for desired scenes, and playback.

You can also enjoy viewing high-resolution/standard resolution still images.

Regional restriction codes (region number)

Regional restriction codes are built in to DVD players and DVD discs for each sales region. If the regional code of the DVD player does not match one of the regional codes of the DVD disc, playback is not possible.

The region number can be found on the rear panel of the DVD player. The illustration below shows the regions and corresponding region numbers.

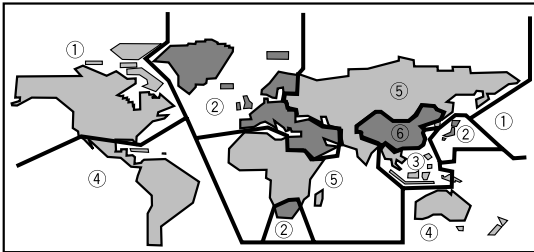

Sampling Frequency

When a sound wave is converted to a digital signal, the sound is sampled and converted to data at a specific frequency rate. For example, a signal with a 96 kHz sampling rate indicates that in one second, the analog signal was sampled 96000 times to produce the digital signal.

Subtitle

Subtitles are language titles superimposed on movies, or other media. Up to 32 different subtitle languages can be recorded on a DVD disc. The subtitle function can be used to select the language of your choice.

S-video

Connecting the S-video output on the player to a TV or monitor with S-video input via an S-video cable produces clearer picture reproduction by sending separate signals for the luminance and the color. These signals are then combined by the television to produce a better quality picture.

System control

When you connect this player via a cord with a mini plug to another Pioneer component such as a receiver or an amplifier bearing the  mark, you can control the player as though it were a component in a system. To control the player, point the player's remote control at the component that the player is connected to, and not the player itself.

Time number

The time number corresponds to the elapsed playback time of a disc from its beginning. When using the time search function, use the time number to locate scenes that occur at the time selected.

Title number

DVD discs are divided into units referred to as titles, and titles are divided into chapters. Menu screens do not belong to any title. A disc which contains a movie may have only one title with many or no chapter divisions. Karaoke discs may have many titles, assigning a title to each song on the disc.

Specifications

General

System ... DVD system and Compact Disc digital audio system
Power requirements .. AC 110~127/220~240V, 50/60 Hz
Power consumption 11 W
Power consumption in standby mode less than 1 W
Weight 2.7 kg
Dimensions 420 (W) x 281 (D) x 95.5 (H) mm
(Not including protruding cables, etc.)
Operating temperature +5°C to +35°C
Operating humidity 5% to 85% (no condensation)

S-Video output

Y (luminance) - Output level 1 Vp-p (75 Ω)
C (color) - Output level 286 mVp-p (75 Ω)
Jacks S-VIDEO jack

Video output

Output level 1 Vp-p (75 Ω)
Jacks RCA jack

Component video output

(Y, P_B, P_R)
Output level Y: 1.0 Vp-p (75 Ω)
P_B, P_R: 0.7 Vp-p (75 Ω)
Jacks RCA jacks

Audio output

Output level
During audio output 200 mVrms (1 kHz, -20 dB)
Number of channels 2
Jacks RCA jacks

Digital audio characteristics

Frequency response 4 Hz to 44 kHz (DVD fs: 96 kHz)
S/N ratio 118 dB
Dynamic range 103 dB
Total harmonic distortion 0.0016 %
Wow and flutter Limit of measurement
(±0.001% W. PEAK) or lower

Digital output

Optical digital output Optical digital jack
Coaxial digital output RCA jack

Other terminals

CONTROL IN Minijack (3.5 ø)

Accessories

Audio cord 1
Video cord 1
Power cord
Central and South American model 2
Other models 1
Remote control unit 1
AA (R6P) dry cell batteries 2
Operating Instructions 1

Note

The specifications and design of this product are subject to change without notice, due to improvement.

Published by Pioneer Corporation.
Copyright © 2001 Pioneer Corporation.
All rights reserved.

PIONEER CORPORATION 4-1, Meguro 1-Chome, Meguro-ku, Tokyo 153-8654, Japan K002AEn
PIONEER ELECTRONICS [USA] INC. P.O. BOX 1540, Long Beach, California 90801-1540, U.S.A.
PIONEER ELECTRONICS OF CANADA, INC. 300 Allstate Parkway, Markham, Ontario L3R 0P2, Canada
PIONEER EUROPE NV Haven 1087, Keetberglaan 1, B-9120 Melsele, Belgium TEL: 03/570.05.11
PIONEER ELECTRONICS AUSTRALIA PTY. LTD. 178-184 Boundary Road, Braeside, Victoria 3195, Australia, TEL: [03] 9586-6300
PIONEER ELECTRONICS DE MEXICO S.A. DE C.V. San Lorenzo 1009 3er Piso Desp. 302 Col. Del Valle Mexico D.F. C.P.
03100 TEL:5-688-52-90

Free Manuals Download Website

<http://myh66.com>

<http://usermanuals.us>

<http://www.somanuals.com>

<http://www.4manuals.cc>

<http://www.manual-lib.com>

<http://www.404manual.com>

<http://www.luxmanual.com>

<http://aubethermostatmanual.com>

Golf course search by state

<http://golfingnear.com>

Email search by domain

<http://emailbydomain.com>

Auto manuals search

<http://auto.somanuals.com>

TV manuals search

<http://tv.somanuals.com>