

**Pioneer** *sound.vision.soul*

**DVD Player**

# DV-588A-S



Register Your Product at  
[www.pioneerelectronics.com](http://www.pioneerelectronics.com) (US)  
[www.pioneerelectronics.ca](http://www.pioneerelectronics.ca) (Canada)

**RW**  
COMPATIBLE

Operating Instructions



The lightning flash with arrowhead, within an equilateral triangle, is intended to alert the user to the presence of uninsulated "dangerous voltage" within the product's enclosure that may be of sufficient magnitude to constitute a risk of electric shock to persons.

**CAUTION**  
RISK OF ELECTRIC SHOCK  
DO NOT OPEN



**CAUTION:**  
TO PREVENT THE RISK OF ELECTRIC SHOCK, DO NOT REMOVE COVER (OR BACK). NO USER-SERVICEABLE PARTS INSIDE. REFER SERVICING TO QUALIFIED SERVICE PERSONNEL.

The exclamation point within an equilateral triangle is intended to alert the user to the presence of important operating and maintenance (servicing) instructions in the literature accompanying the appliance.

D1-4-2-3\_En

**IMPORTANT NOTICE** – THE SERIAL NUMBER FOR THIS EQUIPMENT IS LOCATED IN THE REAR. PLEASE WRITE THIS SERIAL NUMBER ON YOUR ENCLOSED WARRANTY CARD AND KEEP IN A SECURE AREA. THIS IS FOR YOUR SECURITY.

D1-4-2-6-1\_En

**NOTE:** This equipment has been tested and found to comply with the limits for a Class B digital device, pursuant to Part 15 of the FCC Rules. These limits are designed to provide reasonable protection against harmful interference in a residential installation. This equipment generates, uses, and can radiate radio frequency energy and, if not installed and used in accordance with the instructions, may cause harmful interference to radio communications. However, there is no guarantee that interference will not occur in a particular installation. If this equipment does cause harmful interference to radio or television reception, which can be determined by turning the equipment off and on, the user is encouraged to try to correct the interference by one or more of the following measures:

- Reorient or relocate the receiving antenna.
- Increase the separation between the equipment and receiver.
- Connect the equipment into an outlet on a circuit different from that to which the receiver is connected.
- Consult the dealer or an experienced radio/TV technician for help.

D8-10-2\_En

**CAUTION :** USE OF CONTROLS OR ADJUSTMENTS OR PERFORMANCE OF PROCEDURES OTHER THAN THOSE SPECIFIED HEREIN MAY RESULT IN HAZARDOUS RADIATION EXPOSURE.

**CAUTION :** THE USE OF OPTICAL INSTRUMENTS WITH THIS PRODUCT WILL INCREASE EYE HAZARD.

D6-8-2-1\_En

**Information to User**

Alteration or modifications carried out without appropriate authorization may invalidate the user's right to operate the equipment.

D8-10-2\_En

**CAUTION** – TO PREVENT ELECTRIC SHOCK DO NOT USE THIS (POLARIZED) PLUG WITH AN EXTENSION CORD, RECEPTACLE OR OTHER OUTLET UNLESS THE BLADES CAN BE FULLY INSERTED TO PREVENT BLADE EXPOSURE.

**ATTENTION** – POUR PREVENIR LES CHOCS ELECTRIQUES NE PAS UTILISER CETTE FICHE POLARISEE AVEC UN PROLONGATEUR UNE PRISE DE COURANT OU UNE AUTRE SORTIE DE COURANT, SAUF SI LES LAMES PEUVENT ETRE INSEREES A FOND SANS EN LAISSER AUCUNE PARTIE A DECOUVERT.

D2-4-4-1\_EF

**WARNING** – TO PREVENT FIRE OR SHOCK HAZARD, DO NOT EXPOSE THIS APPLIANCE TO RAIN OR MOISTURE.

D1-4-2-1\_En

**WARNING:** Handling the cord on this product or cords associated with accessories sold with the product will expose you to lead, a chemical known to the State of California and other governmental entities to cause cancer and birth defects or other reproductive harm.

**Wash hands after handling**

D36-P4\_En

This product contains mercury. Disposal of this material may be regulated due to environmental considerations. For disposal or recycling information, please contact your local authorities or the Electronics Industries Alliance : [www.eiae.org](http://www.eiae.org).

K057\_En

# IMPORTANT SAFETY INSTRUCTIONS

**READ INSTRUCTIONS** — All the safety and operating instructions should be read before the product is operated.

**RETAIN INSTRUCTIONS** — The safety and operating instructions should be retained for future reference.

**HEED WARNINGS** — All warnings on the product and in the operating instructions should be adhered to.

**FOLLOW INSTRUCTIONS** — All operating and use instructions should be followed.

**CLEANING** — The product should be cleaned only with a polishing cloth or a soft dry cloth. Never clean with furniture wax, benzene, insecticides or other volatile liquids since they may corrode the cabinet.

**ATTACHMENTS** — Do not use attachments not recommended by the product manufacturer as they may cause hazards.

**WATER AND MOISTURE** — Do not use this product near water — for example, near a bathtub, wash bowl, kitchen sink, or laundry tub; in a wet basement; or near a swimming pool; and the like.

**ACCESSORIES** — Do not place this product on an unstable cart, stand, tripod, bracket, or table. The product may fall, causing serious injury to a child or adult, and serious damage to the product. Use only with a cart, stand, tripod, bracket, or table recommended by the manufacturer, or sold with the product. Any mounting of the product should follow the manufacturer's instructions, and should use a mounting accessory recommended by the manufacturer.

**CART** — A product and cart combination should be moved with care. Quick stops, excessive force, and uneven surfaces may cause the product and cart combination to overturn.



**VENTILATION** — Slots and openings in the cabinet are provided for ventilation and to ensure reliable operation of the product and to protect it from overheating, and these openings must not be blocked or covered. The openings should never be blocked by placing the product on a bed, sofa, rug, or other similar surface. This product should not be placed in a built-in installation such as a bookcase or rack unless proper ventilation is provided or the manufacturer's instructions have been adhered to.

**POWER SOURCES** — This product should be operated only from the type of power source indicated on the marking label. If you are not sure of the type of power supply to your home, consult your product dealer or local power company.

**LOCATION** — The appliance should be installed in a stable location.

**NONUSE PERIODS** — The power cord of the appliance should be unplugged from the outlet when left un-used for a long period of time.

## GROUNDING OR POLARIZATION

- If this product is equipped with a polarized alternating current line plug (a plug having one blade wider than the other), it will fit into the outlet only one way. This is a safety feature. If you are unable to insert the plug fully into the outlet, try reversing the plug. If the plug should still fail to fit, contact your electrician to replace your obsolete outlet. Do not defeat the safety purpose of the polarized plug.

- If this product is equipped with a three-wire grounding type plug, a plug having a third (grounding) pin, it will only fit into a grounding type power outlet. This is a safety feature. If you are unable to insert the plug into the outlet, contact your electrician to replace your obsolete outlet. Do not defeat the safety purpose of the grounding type plug.

**POWER-CORD PROTECTION** — Power-supply cords should be routed so that they are not likely to be walked on or pinched by items placed upon or against them, paying particular attention to cords at plugs, convenience receptacles, and the point where they exit from the product.

**OUTDOOR ANTENNA GROUNDING** — If an outside antenna or cable system is connected to the product, be sure the antenna or cable system is grounded so as to provide some protection against voltage surges and built-up static charges. Article 810 of the National Electrical Code, ANSI/NFPA 70, provides information with regard to proper grounding of the mast and supporting structure, grounding of the lead-in wire to an antenna discharge unit, size of grounding conductors, location of antenna-discharge unit, connection to grounding electrodes, and requirements for the grounding electrode. See Figure A.

**LIGHTNING** — For added protection for this product during a lightning storm, or when it is left unattended and unused for long periods of time, unplug it from the wall outlet and disconnect the antenna or cable system. This will prevent damage to the product due to lightning and power-line surges.

**POWER LINES** — An outside antenna system should not be located in the vicinity of overhead power lines or other electric light or power circuits, or where it can fall into such power lines or circuits. When installing an outside antenna system, extreme care should be taken to keep from touching such power lines or circuits as contact with them might be fatal.

**OVERLOADING** — Do not overload wall outlets, extension cords, or integral convenience receptacles as this can result in a risk of fire or electric shock.

**OBJECT AND LIQUID ENTRY** — Never push objects of any kind into this product through openings as they may touch dangerous voltage points or short-out parts that could result in a fire or electric shock. Never spill liquid of any kind on the product.

**SERVICING** — Do not attempt to service this product yourself as opening or removing covers may expose you to dangerous voltage or other hazards. Refer all servicing to qualified service personnel.

**DAMAGE REQUIRING SERVICE** — Unplug this product from the wall outlet and refer servicing to qualified service personnel under the following conditions:

- When the power-supply cord or plug is damaged.
- If liquid has been spilled, or objects have fallen into the product.
- If the product has been exposed to rain or water.
- If the product does not operate normally by following the operating instructions. Adjust only those controls that are covered by the operating instructions as an improper adjustment of other controls may result in damage and will often require extensive work by a qualified technician to restore the product to its normal operation.
- If the product has been dropped or damaged in any way.
- When the product exhibits a distinct change in performance — this indicates a need for service.

**REPLACEMENT PARTS** — When replacement parts are required, be sure the service technician has used replacement parts specified by the manufacturer or have the same characteristics as the original part. Unauthorized substitutions may result in fire, electric shock, or other hazards.

**SAFETY CHECK** — Upon completion of any service or repairs to this product, ask the service technician to perform safety checks to determine that the product is in proper operating condition.

**WALL OR CEILING MOUNTING** — The product should not be mounted to a wall or ceiling.

**HEAT** — The product should be situated away from heat sources such as radiators, heat registers, stoves, or other products (including amplifiers) that produce heat.

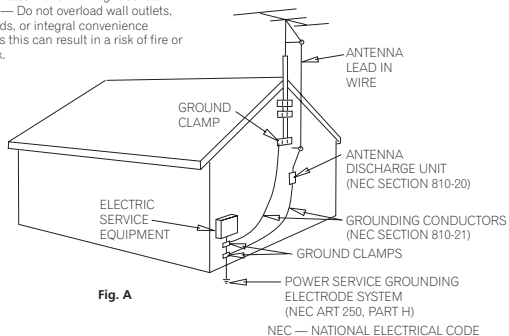

Fig. A

D1-4-2-2, En

This Class B digital apparatus complies with Canadian ICES-003.

Cet appareil numérique de la Classe B est conforme à la norme NMB-003 du Canada.

D8-10-1-3, EF

**CAUTION:** This product satisfies FCC regulations when shielded cables and connectors are used to connect the unit to other equipment. To prevent electromagnetic interference with electric appliances such as radios and televisions, use shielded cables and connectors for connections.

D8-10-3a, En

For U.S. and Australia Model



This product includes FontAvenue® fonts licenced by NEC corporation. FontAvenue is a registered trademark of NEC Corporation.

### POWER-CORD CAUTION

Handle the power cord by the plug. Do not pull out the plug by tugging the cord and never touch the power cord when your hands are wet as this could cause a short circuit or electric shock. Do not place the unit, a piece of furniture, etc., on the power cord, or pinch the cord. Never make a knot in the cord or tie it with other cords. The power cords should be routed such that they are not likely to be stepped on. A damaged power cord can cause a fire or give you an electrical shock. Check the power cord once in a while. When you find it damaged, ask your nearest PIONEER authorized service center or your dealer for a replacement. 5002\_En

This product incorporates copyright protection technology that is protected by method claims of certain U.S. patents and other intellectual property rights owned by Macrovision Corporation and other rights owners. Use of this copyright protection technology must be authorized by Macrovision Corporation, and is intended for home and other limited viewing uses only unless otherwise authorized by Macrovision Corporation. Reverse engineering or disassembly is prohibited.

This product is for general household purposes. Any failure due to use for other than household purposes (such as long-term use for business purposes in a restaurant or use in a car or ship) and which requires repair will be charged for even during the warranty period. K041\_En



### Dear Customer:

Selecting fine audio equipment such as the unit you've just purchased is only the start of your musical enjoyment. Now it's time to consider how you can maximize the fun and excitement your equipment offers. This manufacturer and the Electronic Industries Association's Consumer Electronics Group want you to get the most out of your equipment by playing it at a safe level. One that lets the sound come through loud and clear without annoying blaring or distortion-and, most importantly, without affecting your sensitive hearing.

Sound can be deceiving. Over time your hearing "comfort level" adapts to higher volumes of sound. So what sounds "normal" can actually be loud and harmful to your hearing. Guard against this by setting your equipment at a safe level BEFORE your hearing adapts.

#### To establish a safe level:

- Start your volume control at a low setting.
- Slowly increase the sound until you can hear it comfortably and clearly, and without distortion.

#### Once you have established a comfortable sound level:

- Set the dial and leave it there.

Taking a minute to do this now will help to prevent hearing damage or loss in the future. After all, we want you listening for a lifetime.

### We Want You Listening For A Lifetime

Used wisely, your new sound equipment will provide a lifetime of fun and enjoyment. Since hearing damage from loud noise is often undetectable until it is too late, this manufacturer and the Electronic Industries Association's Consumer Electronics Group recommend you avoid prolonged exposure to excessive noise. This list of sound levels is included for your protection.

#### Decibel Level Example

30	Quiet library, soft whispers
40	Living room, refrigerator, bedroom away from traffic
50	Light traffic, normal conversation, quiet office
60	Air conditioner at 20 feet, sewing machine
70	Vacuum cleaner, hair dryer, noisy restaurant
80	Average city traffic, garbage disposals, alarm clock at two feet.

#### THE FOLLOWING NOISES CAN BE DANGEROUS UNDER CONSTANT EXPOSURE

90	Subway, motorcycle, truck traffic, lawn mower
100	Garbage truck, chain saw, pneumatic drill
120	Rock band concert in front of speakers, thunderclap
140	Gunshot blast, jet plane
180	Rocket launching pad

Information courtesy of the Deafness Research Foundation.



5001\_En

# Contents

## **01 Before you start**

Features.....	6
What's in the box.....	7
Hints on installation.....	7
Disc / content format playback compatibility .....	8

## **02 Connecting up**

Easy connections.....	11
Connecting using the S-video output . . . .	12
Connecting using the component video output .....	12
Connecting to an AV receiver.....	14

## **03 Controls and displays**

Front panel.....	16
Remote control .....	17

## **04 Getting started**

Switching on .....	18
Using the on-screen displays .....	18
Setting up the player for your TV.....	19
Setting the language of this player's on-screen displays .....	19
Playing discs .....	20

## **05 Playing discs**

Scanning discs .....	24
Playing in slow motion.....	24
Frame advance/frame reverse .....	25
Viewing a JPEG slideshow .....	25
Browsing DVD or Video CD disc with the Disc Navigator .....	25
Browsing WMA, MP3, DivX video and JPEG files with the Disc Navigator .....	26
Looping a section of a disc.....	27
Using repeat play .....	28
Using random play.....	28

Creating a program list .....	29
Searching a disc .....	30
Switching subtitles .....	31
Switching audio language/channels .....	31
Zooming the screen.....	31
Switching camera angles .....	32
Displaying disc information.....	32

## **06 Audio Settings and Video Adjust menus**

Audio Settings menu.....	33
Video Adjust menu .....	34

## **07 Initial Settings menu**

Using the Initial Settings menu .....	35
Digital Audio Out settings .....	35
Video Output settings .....	36
Language settings.....	36
Display settings.....	37
Options settings .....	37
Parental Lock .....	38
Speakers settings .....	41

## **08 Additional information**

Taking care of your player and discs .....	45
Screen sizes and disc formats.....	46
Resetting the player.....	47
DVD-Video regions .....	47
Selecting languages using the language code list.....	47
Language code list .....	48
Country/Area code list.....	48
Troubleshooting .....	49
Glossary .....	52
Specifications .....	54

## Chapter 1

# Before you start

## Features

- **DVD-Audio and SACD compatible**

Experience the super high-quality audio performance of DVD-Audio and Super Audio CD (SACD).

- **24-bit/192kHz compatible DAC**

The on-board 24-bit/192kHz DAC means that this player is fully compatible with high sampling-rate discs, capable of delivering exceptional sound quality in terms of dynamic range, low-level resolution and high-frequency detail.

- **Built-in Dolby<sup>\*1</sup> Digital and DTS<sup>\*2</sup> decoding with multichannel outputs**



This player features multichannel analog outputs for connection to an AV amplifier to give you stunning surround sound from Dolby Digital, DTS and multichannel DVD-Audio discs.

- **PureCinema Progressive Scan video**

When connected to a progressive scan-compatible TV or monitor using the component video outputs, you can enjoy extremely stable, flicker free images, with the same frame refresh rate as the original movie.

- **New Disc Navigator with moving pictures**

The new Disc Navigator enables you play the first few seconds of each title or chapter in a thumbnail image on screen.

- **DSP effects for enhanced playback**

See *Audio Settings and Video Adjust menus* on page 33.

- **Picture zoom**

See *Zooming the screen* on page 31.

- **MP3 and WMA compatibility**

See *Compressed audio compatibility* on page 8.

- **JPEG compatibility**

See *JPEG file compatibility* on page 10.

- **DivX video compatibility**

See *DivX video compatibility* on page 10.

- **Energy saving design**

An auto power-off function switches the player into standby if not used for about 30 minutes.

<sup>\*1</sup> Manufactured under license from Dolby Laboratories. "Dolby" and the double-D symbol are trademarks of Dolby Laboratories.

<sup>\*2</sup> "DTS" and "DTS Digital Surround" are registered trademarks of Digital Theater Systems Inc.

## What's in the box

Please confirm that the following accessories are in the box when you open it.

- Remote control
- AA/R6P dry cell batteries x2
- Audio/video cable (red/white/yellow plugs)
- Operating instructions
- Warranty card

## Putting the batteries in the remote

### • Open the battery compartment cover and insert the batteries as shown.

Use two AA/R6P batteries and follow the indications (⊕, ⊖) inside the compartment. Close the cover when you're finished.

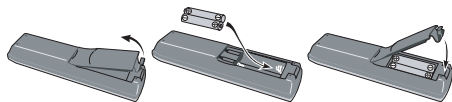

### Important

Incorrect use of batteries can result in hazards such as leakage and bursting. Please observe the following:

- Don't mix new and old batteries together.
- Don't use different kinds of battery together—although they may look similar, different batteries may have different voltages.
- Make sure that the plus and minus ends of each battery match the indications in the battery compartment.
- Remove batteries from equipment that isn't going to be used for a month or more.
- When disposing of used batteries, please comply with governmental regulations or environmental public instruction's rules that apply in your country or area.

## Hints on installation

We want you to enjoy using this product for years to come, so please use the following guidelines when choosing a suitable location:

### Do...

- Use in a well-ventilated room.
- Place on a solid, flat, level surface, such as a table, shelf or stereo rack.

### Don't...

- Use in a place exposed to high temperatures or humidity, including near radiators and other heat-generating appliances.
- Place on a window sill or a place where the player will be exposed to direct sunlight.
- Use in an excessively dusty or damp environment.
- Place directly on top of an amplifier, or other component in your stereo system that becomes hot in use.
- Use near a television or monitor as you may experience interference—especially if the television uses an indoor antenna.
- Use in a kitchen or other room where the player may be exposed to smoke or steam.
- Use on a thick rug or carpet, or cover with cloth—this may prevent proper cooling of the unit.
- Place on an unstable surface, or one that is not large enough to support all four of the unit's feet.

## Disc / content format playback compatibility

This player is compatible with a wide range of disc types (media) and formats. Playable discs will generally feature one of the following logos on the disc and/or disc packaging. Note however that some disc types, such as recordable CD and DVD, may be in an unplayable format—see below for further compatibility information.

*Please also note that recordable discs cannot be recorded using this player.*



-  is a trademark of Fuji Photo Film Co. Ltd.
- Also compatible with KODAK Picture CD

- About DualDisc playback

A DualDisc is a new two-sided disc, one side of which contains DVD content video, audio, etc. while the other side contains non-DVD content such as digital audio material.

The non-DVD, audio side of the disc is not compliant with the CD Audio specification and therefore may not play.

The DVD side of a DualDisc plays in this product.

For more detailed information on the DualDisc specification, please refer to the disc manufacturer or disc retailer.

## CD-R/RW compatibility

- Compatible formats: CD-Audio, Video CD, ISO 9660 CD-ROM\* containing MP3, WMA, JPEG or DivX video files  
\* ISO 9660 Level 1 or 2 compliant. CD physical format: Mode1, Mode2 XA Form1. Romeo and Joliet file systems are both compatible with this player.
- Multi-session playback: No
- Unfinalized disc playback: No
- File structure (may differ): Up to 299 folders on a disc; up to 648 folders and files (combined) within each folder

## DVD-R/RW compatibility

- Compatible formats: DVD-Video, Video Recording (VR)\*  
\* Edit points may not play exactly as edited; screen may go momentarily blank at edited points.
- Unfinalized playback: No
- WMA/MP3/JPEG file playback on DVD-R/RW: No



## Compressed audio compatibility

- Compatible formats: MPEG-1 Audio Layer 3 (MP3), Windows Media Audio (WMA)
- Sampling rates: 32, 44.1 or 48kHz
- Bit-rates: Any (128Kbps or higher recommended)
- VBR (variable bit rate) MP3 playback: No
- VBR WMA playback: No
- WMA lossless encoding compatible: No
- DRM (Digital Rights Management) compatible: Yes (DRM-protected audio files will *not* play in this player—see also *DRM* in the *Glossary* on page 52)
- File extensions: .mp3, .wma (these must be used for the player to recognize MP3 and WMA files – do not use for other file types)

## About WMA



The Windows Media® logo printed on the box indicates that this player can playback Windows Media Audio content.

WMA is an acronym for Windows Media Audio and refers to an audio compression technology developed by Microsoft Corporation. WMA content can be encoded by using Windows Media® Player version 7, 7.1, Windows Media® Player for Windows® XP, or Windows Media® Player 9 Series.

*Microsoft, Windows Media, and the Windows logo are trademarks, or registered trademarks of Microsoft Corporation in the United States and/or other countries.*

## About DivX

DivX is a compressed digital video format created by the DivX® video codec from DivXNetworks, Inc. This player can play DivX video files burned on CD-R/RW/ROM discs. Keeping the same terminology as DVD-Video, individual DivX video files are called "Titles". When naming files/titles on a CD-R/RW disc prior to burning, keep in mind that by default they will be played in alphabetical order.

## Displaying DivX subtitle files

The font sets listed below are available for DivX external subtitle files. You can see the proper font set on-screen by setting the **Subtitle Language** (in *Language settings* on page 36) to match the subtitle file.

This player supports the following language groups:

**Group 1:** Albanian (sq), Basque (eu), Catalan (ca), Danish (da), Dutch (nl), English (en), Faroese (fo), Finnish (fi), French (fr), German (de), Icelandic (is), Irish (ga), Italian (it), Norwegian (no), Portuguese (pt), Rhaeto-Romanic (rm), Scottish (gd), Spanish (es), Swedish (sv)

**Group 2:** Albanian (sq), Croatian (hr), Czech (cs), Hungarian (hu), Polish (pl), Romanian (ro), Slovak (sk), Slovenian (sl)

**Group 3:** Bulgarian (bg), Byelorussian (be), Macedonian (mk), Russian (ru), Serbian (sr), Ukrainian (uk)

**Group 4:** Hebrew (iw), Yiddish (ji)

**Group 5:** Turkish (tr)

*DivX, DivX Certified, and associated logos are trademarks of DivXNetworks, Inc. and are used under license.*

- Some external subtitle files may be displayed incorrectly or not at all.
- For external subtitle files the following subtitle format filename extensions are supported (please note that these files are not shown within the disc navigation menu): .srt, .sub, .ssa, .smi
- The filename of the movie file has to be repeated at the beginning of the filename for the external subtitle file.

- The number of external subtitle files which can be switched for the same movie file is limited to a maximum of 10.

## DivX video compatibility



- Official DivX<sup>®</sup> Certified product.
- Plays DivX<sup>®</sup> 5, DivX<sup>®</sup> 4, DivX<sup>®</sup> 3 and DivX<sup>®</sup> VOD video content (in compliance with DivX<sup>®</sup> Certified technical requirements).
- File extensions: .avi and .divx (these must be used for the player to recognize DivX video files). *Note that all files with the .avi extension are recognized as MPEG4, but not all of these are necessarily DivX video files and therefore may not be playable on this player.*

*DivX, DivX Certified, and associated logos are trademarks of DivXNetworks, Inc. and are used under license.*

## JPEG file compatibility

- Compatible formats: Baseline JPEG and EXIF 2.2\* still image files up to a resolution of 3072 x 2048.  
*\*File format used by digital still cameras*
- Progressive JPEG compatible: No
- File extensions: .jpg (must be used for the player to recognize JPEG files – do not use for other file types)

## PC-created disc compatibility

Discs recorded using a personal computer may not be playable in this unit due to the setting of the application software used to create the disc. In these particular instances, check with the software publisher for more detailed information.

Discs recorded in packet write mode (UDF format) are not compatible with this player.

Check the DVD-R/RW or CD-R/RW software disc boxes for additional compatibility information.

## Chapter 2

# Connecting up

### Easy connections

The setup described here is a basic setup that allows you to play discs using just the cables supplied with the player. In this setup, stereo audio is played through the speakers in your TV.

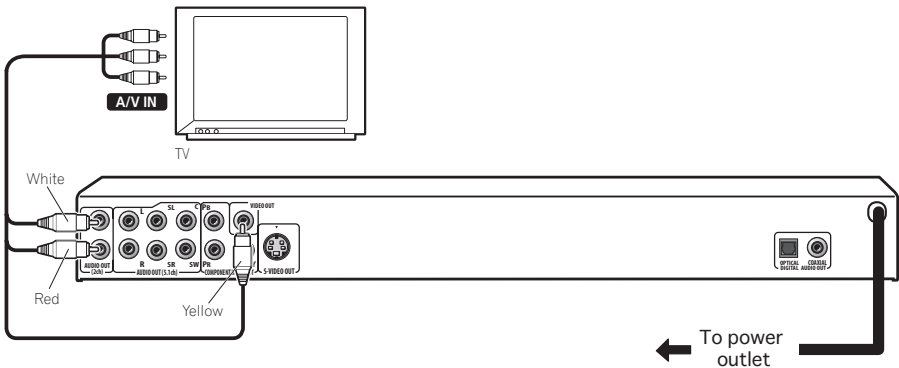

### Important

- This player is equipped with copy protection technology. Do not connect this player to your TV via a VCR using audio/video or S-video cables, as the picture from this player will not appear properly on your TV. (This player may also not be compatible with some combination TV/VCRs for the same reason; refer to the manufacturer for more information.)

### 1 Connect the VIDEO OUT and AUDIO OUT (2ch) jacks to a set of A/V inputs on your TV.

Use the supplied audio/video cable, connecting the red and white plugs to the audio outputs and the yellow plug to the video output. Make sure you match up the left and right audio outputs with their corresponding inputs for correct stereo sound.

See below if you want to use a component or S-video cable for the video connection.

- **AUDIO OUT (5.1ch) FRONT L / R** jacks (page 14).

### 2 Connect the supplied AC power cable to the AC IN inlet, then plug into a power outlet.



#### Note

- Before unplugging the player from the power outlet, make sure you first switch it into standby using either the front panel **STANDBY/ON** button, or the remote control, and wait of the **-OFF-** message to disappear from the player's display.
- For the above reasons, do not plug this player into a switched power supply found on some amplifiers and AV receivers.

## Connecting using the S-video output

If your TV (or other equipment) has an S-video (S1) input, you can use the S-video output on this player instead of the standard (composite) output for a better quality picture.

- **Use an S-video cable (not supplied) to connect the S-VIDEO OUT to an S-video input on your TV (or monitor or AV receiver).**

Line up the small triangle above the jack with the same mark on the plug before plugging in.

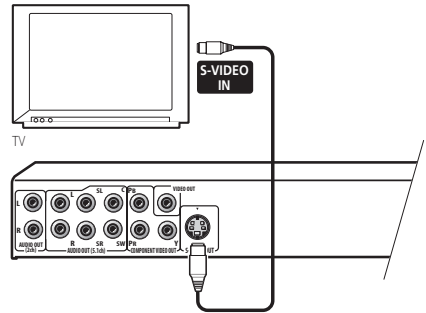

## Connecting using the component video output

You can use the component video output instead of the standard video out jack to connect this player to your TV (or other equipment). This should give you the best quality picture from the three types of video output available.

- **Use a component video cable (not supplied) to connect the COMPONENT VIDEO OUT jacks to a component video input on your TV, monitor or AV receiver.**

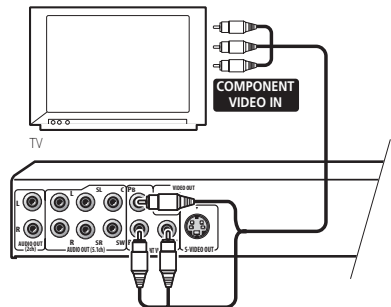

## Watching progressive scan video from the component video outputs

This player can output progressive scan video from the component video output. Compared to interlace video, progressive scan video effectively doubles the scanning rate of the picture, resulting in a very stable, flicker-free image.

To set up the player for use with a progressive scan TV, see *Video Output settings* on page 36. When the player is set to output progressive scan video, the **PRGSVE** indicator lights in the front panel display.



### Important

- If you connect a TV that is not compatible with a progressive scan signal and switch the player to progressive, you will not be able to see any picture at all. In this case, switch everything off and reconnect using the supplied video cable (see *Easy connections* on page 11), then switch back to **Interlace** (see below).

## Switching the video output to interlace using the front panel controls

Switch the player to standby then, using the front panel controls, press **STANDBY/ON** while pressing **◀◀** to switch the player back to **Interlace**.

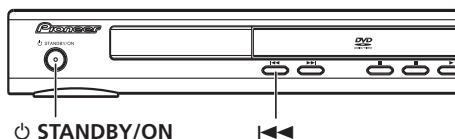

## Compatibility of this player with progressive-scan and high-definition TVs

This player is compatible with progressive video Macro Vision System Copy Guard.

Consumers should note that not all high-definition television sets are fully compatible with this product and may cause artifacts to be displayed in the picture. In case of 525 progressive scan picture problems, it is recommended that the user switch the connection to the 'standard definition' output (Interlace). If there are questions regarding our TV set compatibility with this model, please contact our customer service center.

This player is compatible with the following Pioneer displays and monitors:

### Plasma display

PDP-5040HD, PDP-4340HD, PRO-1000HDI, PRO-800HDI, PRO-1110HD, PRO-910HD, PDP-4341HD, PDP-4345HD, PDP-4350HD, PDP-4351HD, PDP-5041HD, PDP-5045HD, PDP-5050HD, PDP-5051HD, PDP-4304, PRO-1410HD, PRO-1120HD, PRO-920HD

### Projection monitor receiver

SD-533HD5, SD-643HD5, Pro-710HD, Pro-610HD, Pro-510HD, Pro-720HD, Pro-620HD, Pro-520HD, Pro-730HD, Pro-630HD, Pro-530HD, Pro-730HDI, Pro-530HDI

## Connecting to an AV receiver

You can connect this player to your AV receiver using the multichannel analog outputs or one of the digital outputs.

In addition to these connections, you should also connect the 2 channel analog outputs for compatibility with all discs.

You'll probably also want to connect a video output to your AV receiver. You can use any of the video outputs available on this player (the illustration shows a standard (composite) connection).

### 1 Connect the analog AUDIO OUT 2ch and VIDEO OUTPUT jacks on this player to a set of analog audio and video inputs on your AV receiver.

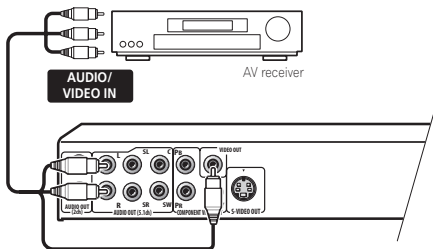

### 2 Connect the AV receiver's video output to a video input on your TV.

The diagram shows standard video connections, but you can alternatively use the S-Video or component video connections if they're available.



#### Tip

- You usually have to connect the same kind of video cable between your DVD player and AV receiver, and between your AV receiver and TV.

## Connecting the multichannel analog outputs

If your AV receiver has 5.1 channel analog inputs, we recommend connecting this player to it using the multichannel analog outputs. Doing this will ensure that you can enjoy all kinds of disc, including Dolby Digital and DTS DVD-Video discs, as well as high sampling rate and multichannel DVD-Audio and SACD discs.

### • Connect the MULTICHANNEL AUDIO outputs on this player to the multi-channel audio inputs on your AV receiver.

It's convenient to use three stereo audio cables; one for the **FRONT**, one for the **SURROUND** and one for the **CENTER** and **SUBWOOFER** channels.

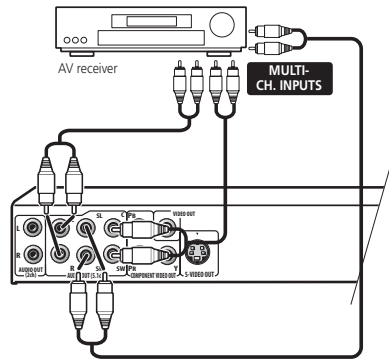

#### Tip

- After connecting up and switching on, you should change the **Audio Output Mode** setting in the Initial Setup menu from the default **2 Channel** to **5.1 Channel**. See also *Audio Output Mode* on page 41.

## Connecting the digital output

This player has both optical and coaxial-type digital audio outputs for connection to an AV receiver. Connect whichever is convenient.

Depending on the capabilities of your AV receiver, you might have to set up this player to output only digital audio in a compatible format. See *Digital Audio Out settings* on page 35 and refer to the operating instructions that came with your AV receiver.

Note that SACD audio is not output through these jacks, so this connection should be in addition to, rather than instead of, a 5.1 channel analog connection.

- **Connect one of the DIGITAL AUDIO OUT jacks on this player to a digital input on your AV receiver.**

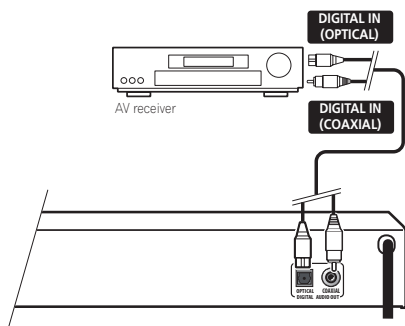

For an optical connection, use an optical cable (not supplied) to connect the **OPTICAL DIGITAL AUDIO OUT** jack to an optical input on your AV receiver.

For a coaxial connection, use a coaxial cable (similar to the supplied video cable) to connect the **COAXIAL DIGITAL AUDIO OUT** jack to a coaxial input on your AV receiver.

## Chapter 3

## Controls and displays

## Front panel

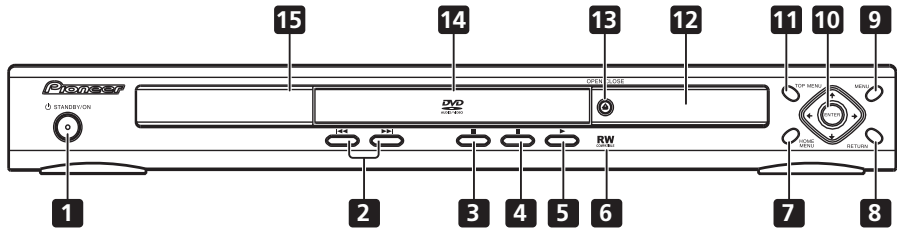

- |   |                               |    |                                             |
|---|-------------------------------|----|---------------------------------------------|
| 1 | ⏻ <b>STANDBY/ON</b> (page 18) | 9  | <b>MENU</b> (page 22)                       |
| 2 | ⏮ and ⏭ (page 21, 23)         | 10 | <b>ENTER &amp; cursor buttons</b> (page 18) |
| 3 | ■ (page 21)                   | 11 | <b>TOP MENU</b> (page 22)                   |
| 4 | ⏸ (page 21)                   | 12 | <b>Display</b>                              |
| 5 | ▶ (page 21)                   | 13 | <b>▲ OPEN/CLOSE</b> (page 20)               |
| 6 | <b>RW Compatible</b> (page 8) | 14 | <b>Disc tray</b>                            |
| 7 | <b>HOME MENU</b> (page 18)    | 15 | <b>Remote control sensor</b> (page 17)      |
| 8 | <b>RETURN</b> (page 22)       |    |                                             |



## Remote control

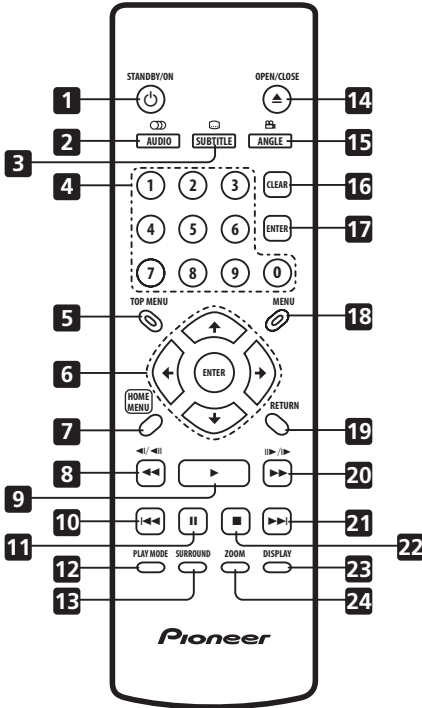

- 1 **⏻ STANDBY/ON** (page 18)
- 2 **AUDIO** (page 31)
- 3 **SUBTITLE** (page 31)
- 4 **Number buttons** (page 21)
- 5 **TOP MENU** (page 22)
- 6 **ENTER & cursor buttons** (page 18)
- 7 **HOME MENU** (page 18)
- 8 **⏮ and ⏪/⏩** (page 21, 24)
- 9 **▶** (page 21)
- 10 **⏮** (page 21)
- 11 **⏮** (page 21)
- 12 **PLAY MODE** (page 27)
- 13 **SURROUND** (page 33)
- 14 **▲ OPEN/CLOSE** (page 20)
- 15 **ANGLE** (page 32)
- 16 **CLEAR** (page 29)
- 17 **ENTER** (page 18)
- 18 **MENU** (page 22)
- 19 **RETURN** (page 18)
- 20 **▶▶ and ▶/⏩** (page 21, 24)
- 21 **▶▶** (page 21)
- 22 **■** (page 21)
- 23 **DISPLAY** (page 32)
- 24 **ZOOM** (page 31)

- 11 **⏮** (page 21)
- 12 **PLAY MODE** (page 27)
- 13 **SURROUND** (page 33)
- 14 **▲ OPEN/CLOSE** (page 20)
- 15 **ANGLE** (page 32)
- 16 **CLEAR** (page 29)
- 17 **ENTER** (page 18)
- 18 **MENU** (page 22)
- 19 **RETURN** (page 18)
- 20 **▶▶ and ▶/⏩** (page 21, 24)
- 21 **▶▶** (page 21)
- 22 **■** (page 21)
- 23 **DISPLAY** (page 32)
- 24 **ZOOM** (page 31)

## Using the remote control

Keep in mind the following when using the remote control:

- Make sure that there are no obstacles between the remote and the remote sensor on the unit.
- The remote has a range of about 7m(23ft.).
- Remote operation may become unreliable if strong sunlight or fluorescent light is shining on the unit's remote sensor.
- Remote controllers for different devices can interfere with each other. Avoid using remotes for other equipment located close to this unit.
- Replace the batteries when you notice a fall off in the operating range of the remote.

## Chapter 4

# Getting started

### Switching on

After making sure that everything is connected properly and that the player is plugged in, press  **STANDBY/ON** on the front panel or remote control to switch the player on.

Also, switch on your TV and make sure that it is set to the input you connected the DVD player to.



 **STANDBY/ON**

### FAQ

- My DVD player switches on but there is nothing displayed on my TV.





Make sure that the TV is set to the correct video input (not a TV channel). For example, if you connected this player to the **VIDEO 1** inputs on your TV, switch your TV to **VIDEO 1**.

### Note

- This player features a screen saver and an auto power off function. If the player is stopped and no button is pressed for around five minutes, the screen saver starts. If the disc tray is closed but no disc is playing and no control is pressed for about 30 minutes, the player automatically goes into standby.

### Using the on-screen displays

For ease of use, this player makes extensive use of graphical on-screen displays (OSDs).

All the screens are navigated in basically the same way, using the cursor buttons (, , , ) to change the highlighted item and pressing **ENTER** to select it.

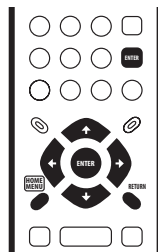

Button	What it does
<b>HOME MENU</b>	Display/exit the on-screen display.
	Changes the highlighted menu item.
<b>ENTER</b>	Selects the highlighted menu item (both <b>ENTER</b> buttons on the remote work in exactly the same way).
<b>RETURN</b>	Returns to the main menu without saving changes.

### Note

- From here on in this manual, the word 'select' generally means use the cursor buttons to highlight an item on-screen, then press **ENTER**.

## Setting up the player for your TV

If you have a widescreen (16:9) TV, you should setup the player so that the picture will be presented correctly. If you have a conventional (4:3) TV, you can leave the player on the default setting and move on to the next section.

### 1 Press HOME MENU and select 'Initial Settings'.



### 2 Select 'TV Screen' from the 'Video Output' settings.

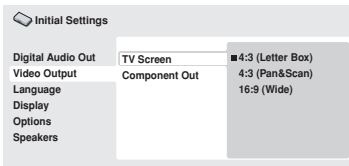

### 3 If you have a widescreen (16:9) TV, select '16:9 (Wide)'.

If you have a conventional (4:3) TV, you can change the setting from **4:3 (Letter Box)** to **4:3 (Pan & Scan)** if you prefer. See *Video Output settings* on page 36 for more details.

### 4 Press HOME MENU to exit the menu screen.

## Setting the language of this player's on-screen displays

This sets the language of the player's on-screen displays.

### 1 Press HOME MENU and select 'Initial Settings'.

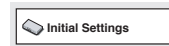

### 2 Select 'OSD Language' from the 'Display' settings.

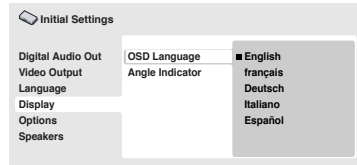

### 3 Select a language.

The on-screen language will change according to your selection.

### 4 Press HOME MENU to exit the menu screen.

## Playing discs

The basic playback controls for playing DVD, CD, SACD, Video CD, DivX video and MP3/WMA discs are covered here. Further functions are detailed in the next chapter.

For details on playing JPEG picture discs, see *Viewing a JPEG slideshow* on page 25.



### Important

- Throughout this manual, the term 'DVD' means DVD-Video, DVD-Audio and DVD-R/RW. If a function is specific to a particular kind of DVD disc, it is specified.

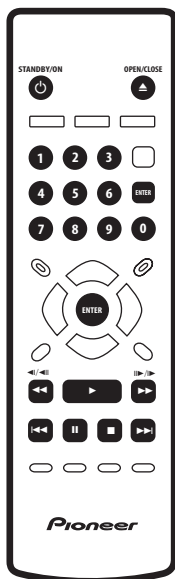

- 1 If the player isn't already on, press **STANDBY/ON** to switch it on.

If you're playing a DVD, disc containing DivX video files or Video CD, also turn on your TV and make sure that it is set to the correct video input.

- 2 Press **OPEN/CLOSE** to open the disc tray.

- 3 Load a disc.

Load a disc with the label side facing up, using the disc tray guide to align the disc (if you're loading a double-sided DVD disc, load it with the side you want to play face down).

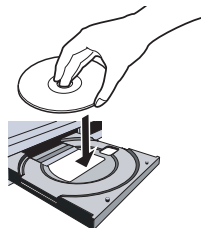

- 4 Press **▶ (play)** to start playback.

If you're playing a DVD or Video CD, an on-screen menu may appear. See *DVD disc menus* on page 22 and *Video CD PBC menus* on page 22 for more on how to navigate these.

- If you're playing a disc containing DivX video files or MP3/WMA audio files, it may take a few seconds before playback starts, etc. This is normal.
- Please see *Disc / content format playback compatibility* on page 8 if you want to play a Dual Disc (DVD/CD hybrid disc).



### Note

- You may find with some DVD discs that some playback controls don't work in certain parts of the disc. This is not a malfunction.
- If a disc contains a mixture of DivX video and other media file types (MP3, for example), first select whether to play the DivX video files (**DivX**) or the other media file types (**MP3 / WMA / JPEG**) from the on-screen display.

## Basic playback controls

The table below shows the basic controls on the remote for playing discs. The following chapter covers other playback features in more detail.

Button	What it does
▶	Starts playback. If the display shows <b>RESUME</b> or <b>LAST MEM</b> playback starts from the resume or last memory point (see also <i>Resume and Last Memory</i> below.)
	Pauses a disc that's playing, or restarts a paused disc.
■	Stops playback. See also <i>Resume and Last Memory</i> below.
◀◀ (remote only)	Press to start fast reverse scanning. Press ▶ (play) to resume normal playback.
▶▶ (remote only)	Press to start fast forward scanning. Press ▶ (play) to resume normal playback.
◀◀	Skips to the start of the current track, title or chapter, then to previous tracks/titles/chapters.
▶▶	Skips to the next track, title or chapter.

### Button What it does

**Numbers** (remote only) Use to enter a title/chapter/track number. Press **ENTER** to select.

- If the disc is stopped, playback starts from the selected title (for DVD), group (for DVD-Audio) or track (for CD/SACD/Video CD).
- If the disc is playing, playback jumps to the start of the selected title (VR mode DVD-RW), chapter (DVD-Video) or track (DVD-Audio\*/SACD/CD/Video CD).

*\*within the current group*

## Resume and Last Memory

With the exception of DVD-Audio and SACD discs, when you stop playback of a DVD, CD, Video CD or DivX video discs, **RESUME** is shown in the display indicating that you can resume playback again from that point.

If the disc tray is not opened, the next time you start playback the display shows **RESUME** and playback resumes from the resume point. (If you want to clear the resume point, press ■ (stop) while **RESUME** is displayed.)

With DVDs and Video CDs, if you take the disc out of the player after stopping playback, the last play position is stored in memory. If the next disc you load is the same one, the display shows **LAST MEM** and playback will resume. For DVD-Video discs, the player stores the play position of the last five discs. When one of these discs is next loaded, you can resume playback.



### Note

- The Last Memory function doesn't work with VR format DVD-RW, DVD-Audio or SACD discs.

- If you don't need the Last Memory function when you stop a disc, you can press ▲ **OPEN/CLOSE** to stop playback and open the disc tray.

## DVD disc menus

Many DVD-Video and DVD-Audio discs feature menus from which you can select what you want to watch. They may also give access to additional features, such as subtitle and audio language selection, or special features such as slideshows. See the disc packaging for details.

Sometimes DVD-Video menus are displayed automatically when you start playback; others only appear when you press **MENU** or **TOP MENU**.

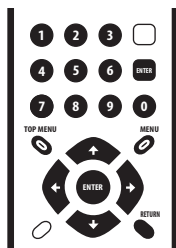

### Important

Some DVD-Audio discs feature a 'bonus group'. To play this group you first have to input a password, which you can find on the disc's packaging. Use the number buttons to input the password.

Button	What it does
<b>TOP MENU</b>	Displays the 'top menu' of a DVD disc—this varies with the disc.
<b>MENU</b>	Displays a DVD disc menu—this varies with the disc and may be the same as the 'top menu'.
↑/↓/←/→	Moves the cursor around the screen.

Button	What it does
<b>ENTER</b>	Selects the current menu option.
<b>RETURN</b>	Returns to the previously displayed menu screen. On some DVD-Audio discs featuring browsable pictures, press to display the browser screen.
<b>Numbers</b> (remote only)	Highlights a numbered menu option (some discs only). Press <b>ENTER</b> to select.

## Video CD PBC menus

Some Video CDs have menus from which you can choose what you want to watch. These are called PBC (Playback control) menus.

You can play a PBC Video CD without having to navigate the PBC menu by starting playback using a number button to select a track, rather than the ► (play) button.

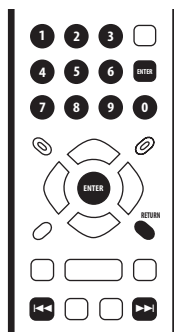

Button	What it does
<b>RETURN</b>	Displays the PBC menu.
<b>Numbers</b> (remote only)	Use to enter a numbered menu option. Press <b>ENTER</b> to select.

Button	What it does
◀◀	Displays the previous menu page (if there is one).
▶▶	Displays the next menu page (if there is one).

### FAQ

- *After I load a DVD disc, it ejects automatically after a few seconds!*

Most likely, the disc is the wrong region for your player. The region number should be printed on the disc; check it against the region number of the player (which you can find on the rear panel). See also *DVD-Video regions* on page 47.

If the region number is OK, it may be that the disc is damaged or dirty. Clean the disc and look for signs of damage. See also *Taking care of your player and discs* on page 45.

- *Why won't the disc I loaded play?*

First check that you loaded the disc the right way up (label side up), and that it's clean and undamaged. See *Taking care of your player and discs* on page 45 for information on cleaning discs.

If a disc loaded correctly won't play, it's probably an incompatible format or disc type, such as DVD-ROM. See *Disc / content format playback compatibility* on page 8 for more on disc compatibility.

- *I have a widescreen TV so why are there black bars at the top and bottom of the screen when I play some discs?*

Some movie formats are such that even when played on a widescreen TV, black bars are necessary at the top and bottom of the screen. This is not a malfunction.

- *I have a standard (4:3) TV and set the player to show widescreen DVDs in pan & scan format, so why do I still get black bars top and bottom with some discs?*

Some discs override the display preferences of the player, so even if you have **4:3 (Pan & Scan)** selected, those discs will still be shown in letter box format. This is not a malfunction.

- *My AV receiver is definitely compatible with 96/88.2kHz Linear PCM audio, but it doesn't seem to work with this player. What's wrong?*

For digital copy-protection purposes, some 96/88.2kHz DVD discs only output digital audio downsampled to 48/44.1kHz. This is not a malfunction.

To fully take advantage of the high sampling rate audio, connect the analog audio outputs to your amplifier/receiver.

- *Why can't I hear SACD audio through the digital outputs?*

SACD audio is only available through the analog outputs. This is not a malfunction. Some DVD-Audio discs too only output audio through the analog outputs.

- *Is it better to listen to DVD-Audio discs through the analog outputs?*

Some DVD-Audio discs do not output anything through the digital outputs, and multichannel discs are downmixed to stereo for the digital output. In addition, high sampling rate DVD-Audio discs (higher than 96kHz) automatically downsample audio output from the digital outputs.

Using the multichannel analog audio outputs for DVD-Audio have none of these limitations.

- *My DVD-Audio disc starts playing, but then suddenly stops!*

The disc may have been illegally copied.

## Chapter 5

# Playing discs



### Note

- Many of the functions covered in this chapter apply to DVD and SACD discs, Video CDs, CDs, DivX video and WMA/MP3 JPEG discs, although the exact operation of some varies slightly with the kind of disc loaded.
- Some DVDs restrict the use of some functions (random or repeat, for example) in some or all parts of the disc. This is not a malfunction.
- When playing Video CDs, some of the functions are not available during PBC playback. If you want to use them, start the disc playing using a number button to select a track.

## Scanning discs

You can fast-scan discs forward or backward at four different speeds (DivX video only one speed).

### 1 During playback, press ◀◀ or ▶▶ to start scanning.

- There is no sound while scanning DVDs (including DVD-Audio), DivX video and Video CDs.

### 2 Press repeatedly to increase the scanning speed.

- The scanning speed is shown on-screen.

### 3 To resume normal playback, press ▶ (play).

- When scanning a Video CD playing in PBC mode or a WMA/MP3 track, playback automatically resumes at the end or beginning of the track.

- Depending on the disc, normal playback may automatically resume when a new chapter is reached on a DVD disc.

## Playing in slow motion

You can play DVD-Videos and DVD-R/RW at four different slow motion speeds, forwards and backwards. Video CDs and DivX video can be played at four different forward slow motion speeds.

### 1 During playback, press II (pause).

### 2 Press and hold ◀|/◀◀ or ▶▶/|▶ until slow motion playback starts.

- The slow motion speed is shown on-screen.
- There is no sound during slow motion playback.

### 3 Press repeatedly to change the slow motion speed.

### 4 To resume normal playback, press ▶ (play).

- Depending on the disc, normal playback may automatically resume when a new chapter is reached.



## Frame advance/frame reverse

You can advance or back up DVD-Video and DVD-R/RW discs frame-by-frame. With Video CDs and DivX video file you can only use frame advance.

**1 During playback, press II (pause).**

**2 Press ◀I/◀II or II▶/I▶ to reverse or advance a frame at a time.**

**3 To resume normal playback, press ▶ (play).**

- Depending on the disc, normal playback may automatically resume when a new chapter is reached.

## Viewing a JPEG slideshow

After loading a CD/CD-R/RW containing JPEG picture files, press ▶ (play) to start a slideshow from the first folder/picture on the disc. The player displays the pictures in each folder in alphabetical order.

Pictures are automatically adjusted so that they fill as much of the screen as possible (if the aspect ratio of the picture is different to your TV screen you may notice black bars at the sides, or at the top and bottom of the screen).

While the slideshow is running:

Button	What it does
II	Pauses the slideshow; press again to restart.
◀◀	Displays the previous picture.
▶▶	Displays the next picture.
◀/→	Pauses the slideshow and rotates the displayed picture 90° (counter clockwise). (Press ▶ (play) to restart slideshow.)

Button	What it does
↑/↓	Pauses the slideshow and flips the displayed picture horizontally or vertically. (Press ▶ (play) to restart slideshow.)
ZOOM	Pauses the slideshow and zooms the picture. Press again to toggle between 1x, 2x and 4x zoom. (Press ▶ (play) to restart slideshow.)
MENU	Displays the Disc Navigator screen (see below).



### Note

- The time it takes for the player to load a file increases with large file sizes.

## Browsing DVD or Video CD disc with the Disc Navigator

Use the Disc Navigator to browse through the contents of a DVD-Video, DVD-RW or Video CD disc to find the part you want to play.



### Important

- You can't use the Disc Navigator with Video CDs in PBC mode.

**1 During playback, press HOME MENU and select 'Disc Navigator' from the on-screen menu.**

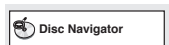

**2 Select a view option.**

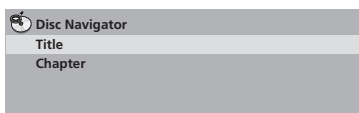

The options available depend on the kind of disc loaded and whether the disc is playing or not, but include:

- **Title** – Titles from a DVD-Video disc.
- **Chapter** – Chapters from the current title of a DVD-Video disc.
- **Track** – Tracks from a Video CD disc.
- **Time** – Thumbnails from a Video CD disc at 10 minute intervals.
- **Original: Title** – Original titles from a VR mode DVD-RW disc.
- **Playlist: Title** – Playlist titles from a VR mode DVD-RW disc.
- **Original: Time** – Thumbnails from the Original content at 10 minute intervals.
- **Playlist: Time** – Thumbnails from the Playlist at 10 minute intervals.

The screen shows up to six moving thumbnail images displayed one after another. To display the previous/next six thumbnails, press ◀◀/▶▶ (you don't have to wait for all the thumbnails to finish playing to display the previous/next page).

### 3 Select the thumbnail image for what you want to play.

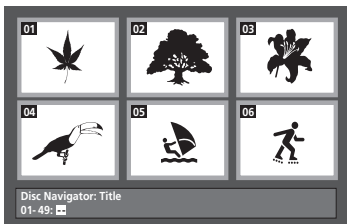

You can use either the cursor buttons (↑/↓/←/→) and **ENTER** to select a thumbnail, or the number buttons.

To select using the number buttons, enter a two-digit number then press **ENTER**.

### Tip

- Another way to find a particular place on a disc is to use one of the search modes. See *Searching a disc* on page 30.

## Browsing WMA, MP3, DivX video and JPEG files with the Disc Navigator

Use the Disc Navigator to find a particular file or folder by filename. Note that if there are other types of files on the same disc, these will not be displayed in the Disc Navigator.

### 1 Press HOME MENU and select 'Disc Navigator' from the on-screen menu.

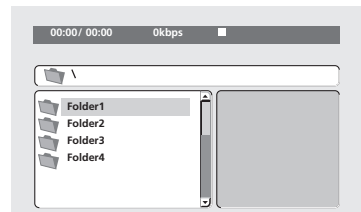

### 2 Use the cursor buttons (↑/↓/←/→) and **ENTER** to navigate.

Use the cursor up/down buttons (↑/↓) to move up and down the folder/file list.

Use the cursor left button (←) to return to the parent folder.

Use **ENTER** or cursor right (→) to open a highlighted folder.

- You can also return to the parent folder by going to the top of the list to the '..' folder, then pressing **ENTER**.

- When a JPEG file is highlighted, a thumbnail image is displayed on the right.

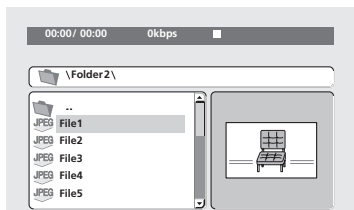

### 3 To play the highlighted track or DivX video file or display the highlighted JPEG file, press ENTER.

- When a WMA/MP3 or DivX video file is selected, playback begins, starting with the selected file, and continues until the end of the folder.
- When a JPEG file is selected, a slideshow begins, starting with that file, and continues to the end of the folder.



#### Tip

- To play the contents of the whole disc rather than just the current folder, exit the Disc Navigator and start playback using the ► (play) button.

## Looping a section of a disc

The A-B Repeat function allows you to specify two points (A and B) within a track (CD, Video CD) or title (DVD-Video and DVD-RW) that form a loop which is played over and over.

- You can't use A-B Repeat with DVD-Audio, SACD, Video CDs in PBC mode, or WMA/MP3/DivX video files.

### 1 During playback, press PLAY MODE and select 'A-B Repeat' from the list of functions on the left.

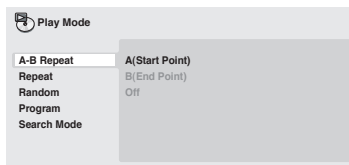

### 2 Press ENTER on 'A(Start Point)' to set the loop start point.

### 3 Press ENTER on 'B(End Point)' to set the loop end point.

After pressing **ENTER**, playback jumps back to the start point and plays the loop.

### 4 To resume normal playback, select 'Off' from the menu.

## Using repeat play

There are various repeat play options, depending on the kind of disc loaded. It's also possible to use repeat play together with program play to repeat the tracks/chapters in the program list (see *Creating a program list* on page 29).



### Important

- You can't use Repeat play with Video CDs in PBC mode, or with WMA/MP3 discs.
- You can't use repeat and random play at the same time.

**1 During playback, press PLAY MODE and select 'Repeat' from the list of functions on the left.**

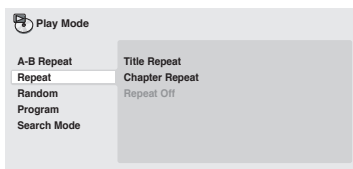

**2 Select a repeat play option.**

If program play is active, select **Program Repeat** to repeat the program list, or **Repeat Off** to cancel.

The repeat options available depend on the kind of disc loaded. For example, for DVD-Video and DVD-RW discs, you can select **Title Repeat** or **Chapter Repeat** (or **Repeat Off**).

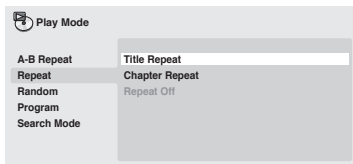

- For DVD-Audio discs, select **Group Repeat** or **Track Repeat** (or **Repeat Off**).

- For SACDs, CDs and Video CDs, select **Disc Repeat** or **Track Repeat** (or **Repeat Off**).
- For DivX video discs, select **Title Repeat** (or **Repeat Off**).

## Using random play

Use the random play function to play titles or chapters (DVD-Video), Groups (DVD-Audio), or tracks (DVD-Audio, SACD, CD, Video CD) at random. (Note that the same track/title/chapter may play more than once.)

You can set the random play option when a disc is playing or stopped.



### Important

- Random play remains in effect until you select **Random Off** from the random play menu options.
- You can't use random play with VR format DVD-RW discs, Video CDs playing in PBC mode, WMA/MP3 discs, DivX video discs, or while a DVD disc menu is being displayed.
- You can't use random play together with program or repeat play.

**1 Press PLAY MODE and select 'Random' from the list of functions on the left.**



## 2 Select a random play option.

The random play options available depend on the kind of disc loaded. For example, for DVD-Video discs, you can select **Random Title** or **Random Chapter** (or **Random Off**).

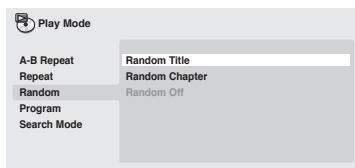

- For DVD-Audio discs, select **Random Group** or **Random Track**, (or **Random Off**).
- For CDs, SACDs and Video CDs, select **On** or **Off** to switch random play on or off.



### Tip

- Use the following controls during random play:

Button	What it does
▶▶	Selects a new track/title/chapter at random.
◀◀	Returns to the beginning of the current track/title/chapter; further presses select another random track/title/chapter.

## Creating a program list

This feature lets you program the play order of titles/chapters/groups/tracks on a disc.



### Important

- You can't use Program play with VR format DVD-RW discs, Video CDs playing in PBC mode, WMA/MP3 discs, DivX video discs, or while a DVD disc menu is being displayed.

### 1 Press PLAY MODE and select 'Program' from the list of functions on the left.

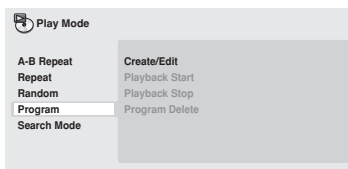

### 2 Select 'Create/Edit' from the list of program options.

### 3 Use the cursor buttons and ENTER to select a title, chapter or track for the current step in the program list.

For a DVD-Video disc, you can add a title or a chapter to the program list.

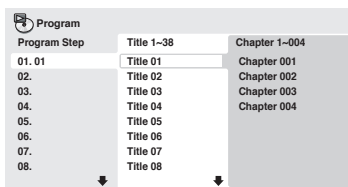

- For a DVD-Audio disc, you can add a whole group, or a track within a group to the program list.
- For a CD, SACD or Video CD, select a track to add to the program list.

After pressing **ENTER** to select the title/ chapter/group/track, the step number automatically moves down one.

#### 4 Repeat step 3 to build up a program list.

A program list can contain up to 24 titles/ chapters/tracks.

- You can insert steps into the middle of a program list by just highlighting the position where you want the new step to appear and entering a title/chapter/group/ track number.
- To delete a step, highlight it and press **CLEAR**.

#### 5 To play the program list, press ► (play).

Program play remains active until you turn off program play (see below), erase the program list (see below), eject the disc or switch off the player.



#### Tip

- Use the following controls during program play:

Button	What it does
<b>PLAY MODE</b>	Save the program list and exit the program edit screen without starting playback ( <b>HOME MENU</b> does the same).
<b>►►</b>	Skip to the next step in the program list.

### Other functions available from the program menu

There are a number of other options in the program menu in addition to Create/Edit.

- **Playback Start** – Starts playback of a saved program list
- **Playback Stop** – Turns off program play, but does not erase the program list

- **Program Delete** – Erases the program list and turns off program play

## Searching a disc

You can search DVD-Video discs by title or chapter number, or by time; DVD-Audio discs can be searched by group or track number; SACDs by track number, CDs and Video CDs by track number or time; DivX video discs by time.



### Important

- Search functions are not available with Video CDs in PBC mode, or with WMA/MP3 discs.

#### 1 Press **PLAY MODE** and select 'Search Mode' from the list of functions on the left.

#### 2 Select a search mode.

The search options available depend on the kind of disc loaded.

- The disc must be playing in order to use time search.

#### 3 Use the number buttons to enter a title, chapter or track number, or a time.

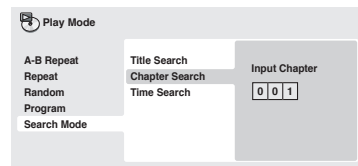

- For a time search, enter the number of minutes and seconds into the currently playing title (DVD/ DivX video) or track (CD/ Video CD) you want playback to resume from. For example, press **4, 5, 0, 0** to have playback start from 45 minutes into the disc. For 1 hour, 20 minutes and 30 seconds, press **8, 0, 3, 0**.

- Some DVD-Audio discs feature pages of browsable pictures. Enter the page number you want.

#### 4 Press ENTER to start playback.

## Switching subtitles

Some DVD-Video and DivX video discs have subtitles in one or more languages; the disc box will usually tell you which subtitle languages are available. You can switch subtitle language during playback.

#### 1 Press SUBTITLE repeatedly to select a subtitle option.

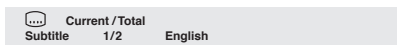

#### Note

- Some discs only allow you to change subtitle language from the disc menu. Press **TOP MENU** or **MENU** to access.
- To set subtitle preferences, see *Subtitle Language* on page 36.
- See *Displaying DivX subtitle files* on page 9 for more on DivX subtitles.

## Switching audio language/channels

When playing a DVD-Video and DivX video disc recorded with dialog in two or more languages, you can switch audio language during playback.

When playing a VR format DVD-RW disc recorded with dual-mono audio, you can switch between the main, sub, and mixed channels during playback.

When playing a DVD-Audio disc, you may be able to switch channels—see the disc box for details. (When you change the audio channel, playback restarts from the beginning of the current track.)

When playing a Video CD, you can switch between stereo, just the left channel or just the right channel.

#### 1 Press AUDIO repeatedly to select an audio language/channel option.

The language/channel information is shown on-screen.

#### Note

- Some DVD discs only allow you to change audio language from the disc menu. Press **TOP MENU** or **MENU** to access.
- To set DVD audio language preferences, see *Language settings* on page 36.

## Zooming the screen

Using the zoom feature you can magnify a part of the screen by a factor of 2 or 4, while watching a DVD, DivX video title or Video CD or playing a JPEG disc.

#### 1 During playback, use the ZOOM button to select the zoom factor (Normal, 2x or 4x).

- Since DVD, Video CD, DivX video title and JPEG pictures have a fixed resolution, picture quality will deteriorate, especially at 4x zoom. This is not a malfunction.

#### 2 Use the cursor buttons to change the zoomed area.

You can change the zoom factor and the zoomed area freely during playback.

- If the navigation square at the top of the screen disappears, press **ZOOM** again to display it.

## Switching camera angles

Some DVD discs feature scenes shot from two or more angles—check the disc box for details.

When a multi-angle scene is playing, a  icon appears on screen to let you know that other angles are available (this can be switched off if you prefer—see *Display settings* on page 37).

**1 During playback (or when paused), press ANGLE to switch angle.**

## Displaying disc information

Various track, chapter and title information, such as the elapsed and remaining playing time can be displayed on-screen while a disc is playing.

**1 To show/switch/hide the information displayed, press DISPLAY repeatedly.**

- When a disc is playing, the information appears at the top of the screen. Keep pressing **DISPLAY** to change the displayed information.



## Chapter 6

# Audio Settings and Video Adjust menus

### Audio Settings menu

The Audio Settings menu offers features for adjusting the way discs sound.

- 1 Press **HOME MENU** and select '**Audio Settings**' from the on-screen display.



- 2 Select and change settings using the **↑/↓/←/→** (cursor) buttons, and **ENTER**.

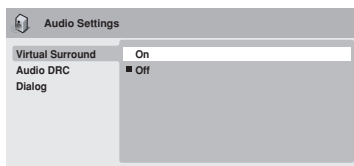

### Audio DRC

- Settings: **High, Medium, Low, Off** (default)

When watching Dolby Digital DVDs at low volume, it's easy to lose the quieter sounds completely—including some of the dialog. Switching Audio DRC (Dynamic Range Control) to on can help by bringing up the quieter sounds, while controlling loud peaks.

How much of a difference you hear depends on the material you're listening to. If the material doesn't have wide variations in volume, you may not notice much change.

### Note

- Audio DRC is only effective with Dolby Digital audio sources.
- Audio DRC is only effective through the digital output when **Digital Out** is set to **On**, and **Dolby Digital Out** is set to **Dolby Digital > PCM** (see *Digital Audio Out settings* on page 35).
- The effect of Audio DRC also depends on your speakers and AV receiver settings.

### Virtual Surround

- Settings: **On, Off** (default)

Switch on Virtual Surround to enjoy realistic surround sound effects from just two speakers.

### Tip

- You can also use the **SURROUND** button on the remote control to switch Virtual Surround on.

### Note

- 96kHz linear PCM audio is automatically downsampled to 48kHz if Virtual Surround is switched on.
- The **Audio Output Mode** (see page 41) must be set to **2 Channel** in order to be able to use Virtual Surround.

- If the player is outputting Dolby Digital, DTS or MPEG bitstream audio (in other words, no conversion to PCM), Virtual Surround has no effect on the audio from the digital output. See *Digital Audio Out settings* on page 35 for how to set up the digital output formats.
- How good the surround effect is varies with the disc.

### Dialog

- Settings: **High, Medium, Low, Off** (default)

The Dialog feature is designed to make the dialog stand out from other background sounds in the soundtrack.

### Video Adjust menu

From the Video Adjust screen you can adjust various settings that affect how the picture is presented.

**1 Press HOME MENU and select 'Video Adjust' from the on-screen display.**



**2 Make settings using the ↑/↓/←/→ (cursor) buttons, and ENTER.**

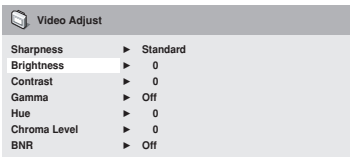

You can adjust the following picture quality settings:

- **Sharpness** – Adjusts the sharpness of edges in the picture (**Fine, Standard** (default), **Soft**).

- **Brightness** – Adjusts the overall brightness (**-20 to +20**).
- **Contrast** – Adjusts the contrast between light and dark (**-16 to +16**).
- **Gamma** – Adjusts the 'warmth' of the picture (**High, Medium, Low, Off** (default)).
- **Hue** – Adjusts the red/green balance (**Green 9 to Red 9**).
- **Chroma Level** – Adjusts how saturated colors appear (**-9 to +9**).
- **BNR** – Switches on/off block noise reduction (**On, Off** (default)).

Adjust the Brightness, Contrast, Hue and Chroma Level settings using the ←/→ (cursor left/right) buttons.



**3 Press ENTER to return to the Video Adjust screen, or HOME MENU to exit.**

## Chapter 7

# Initial Settings menu

### Using the Initial Settings menu

The Initial Settings menu provides audio and video output settings, parental lock settings, and display settings, among others.

If an option is grayed out it means that it cannot be changed at the current time. This is usually because a disc is playing. Stop the disc, then change the setting.

#### 1 Press HOME MENU and select 'Initial Settings'.

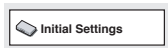

#### 2 Use the cursor buttons and ENTER to select the setting and option you want to set.

All the settings and options are explained on the following pages.

#### Note

- In the table below, the default setting is shown in **bold**; other settings are shown in *italics*.
- The Digital Audio Out settings only need to be set if you have connected the digital output of this player to an AV receiver, or other equipment.
- Check the operating instructions supplied with your other equipment to see which digital audio formats it's compatible with.
- Some settings, such as **TV Screen**, **Audio Language** and **Subtitle Language** may be overridden by the DVD disc. Often these settings can also be made from the DVD disc menu.

### Digital Audio Out settings

Setting	Option	What it means
<b>Digital Out</b>	<b>On</b>	Digital audio is output from the digital outputs. <i>Note that there is no digital output when playing SACDs and DVD-Audio discs regardless of this setting.</i>
	<i>Off</i>	No digital audio output.
<b>Dolby Digital Out</b>	<b>Dolby Digital</b>	Dolby Digital encoded digital audio is output when playing a Dolby Digital DVD disc.
	<i>Dolby Digital &gt; PCM</i>	Dolby Digital audio is converted to PCM audio before being output.
<b>DTS Out</b>	<b>DTS</b>	DTS encoded digital audio is output when playing a DTS disc. (Noise will be output if your amplifier/receiver is not compatible with DTS audio.)
	<i>DTS &gt; PCM</i>	No digital audio is output when playing a DTS disc. DTS audio is converted to PCM audio before being output.

Setting	Option	What it means
Linear PCM Out	Down Sample On	96kHz digital audio is converted to 48kHz for digital output. <i>Note that High sampling rate DVD-Audio discs (192kHz or 176.4kHz) automatically output down-sampled audio through the digital outputs.</i>
	Down Sample Off	96kHz digital audio is output as is at 96kHz.
MPEG Out	MPEG > PCM	MPEG encoded digital audio is converted to PCM audio for digital output.
	MPEG	MPEG encoded digital audio is output as is.

## Video Output settings

Setting	Option	What it means
TV Screen (See also <i>Screen sizes and disc formats</i> on page 46.)	4:3 (Letter Box)	Set if you have a conventional 4:3 TV. Widescreen movies are shown with black bars top and bottom.
	4:3 (Pan & Scan)	Set if you have a conventional 4:3 TV. Widescreen movies are shown with the sides cropped so that the image fills the screen.
	16:9 (Wide)	Set if you have a widescreen TV.
Component Out	Interlace	Set if your TV is not compatible with progressive scan video.
	Progressive	Set if your TV is compatible with progressive scan video (see your TV's instruction manual for details). See also <i>Switching the video output to interlace using the front panel controls</i> on page 13. <i>Note that progressive scan video is only output from the component video jacks.</i>

## Language settings

Setting	Option	What it means
Audio Language	English	If there is an English soundtrack on the disc then it will be played.
	Languages as displayed	If there is the language selected on the disc, then it will be played.
	Other Language	Select to choose a language other than the ones displayed (see page 47).

Setting	Option	What it means
<b>Subtitle Language</b> (See also <i>Displaying DivX subtitle files</i> on page 9.)	<b>English</b>	If there are English subtitles on the disc then they will be displayed.
	<i>Languages as displayed</i>	If there is the subtitle language selected on the disc, then it will be displayed.
	<i>Other Language</i>	Select to choose a language other than the ones displayed (see page 47).
<b>DVD Menu Language</b>	<b>w/Subtitle Lang.</b>	DVD disc menus will be displayed in the same language as your selected subtitle language, if possible.
	<i>Languages as displayed</i>	DVD disc menus will be displayed in the selected language, if possible.
	<i>Other Language</i>	Select to choose a language other than the ones displayed (see page 47).
<b>Subtitle Display</b>	<b>On</b>	Subtitles are displayed according to your selected subtitle language (see above).
	<i>Off</i>	Subtitles are always off by default when you play a DVD disc (note that some discs override this setting).

## Display settings

Setting	Option	What it means
<b>OSD Language</b>	<b>English</b>	On-screen displays of the player are in English.
	<i>Languages as displayed</i>	On-screen displays are shown in the language selected.
<b>Angle Indicator</b>	<b>On</b>	A camera icon is displayed on-screen during multi-angle scenes on a DVD disc.
	<i>Off</i>	No multi-angle indication is shown.

## Options settings

Setting	Option	What it means
<b>Parental Lock</b>	–	See <i>Parental Lock</i> on page 38.
<b>DVD Playback Mode</b>	<b>DVD-Audio</b>	All material on a DVD-Audio disc is playable.
	<i>DVD-Video</i>	Only the DVD-Video part of a DVD-Audio disc is playable.

Setting	Option	What it means
<b>SACD Playback</b>	<b>2ch Area</b>	Selects the 2 channel (stereo) SACD audio area of the disc for playback.
	<i>Multi-ch Area</i>	Selects the multi-channel SACD audio area of the disc for playback.
	<i>CD Area</i>	Selects the standard CD audio area of an SACD/CD hybrid disc for playback.
<b>DTS Downmix</b>	<b>Stereo</b>	Downmixes DTS for 2 channel output to regular stereo. (See also <i>DTS Downmix</i> on page 39.)
	<i>Lt/Rt</i>	Downmixes DTS for 2 channel output to be compatible with Dolby Surround matrix decoders. (See also <i>DTS Downmix</i> on page 39.)
<b>DivX VOD</b>	<b>Display</b>	See <i>About DivX® VOD content</i> on page 39.

## Parental Lock

- Default level: **Off**; Default password: *none*;  
Default Country/Area code: **us (2119)**

To give you some control over what your children watch on your DVD player, some DVD-Video discs feature a Parental Lock level. If your player is set to a lower level than the disc, the disc won't play.

Some discs also support the Country/Area Code feature. The player does not play certain scenes on these discs, depending on the Country/Area Code you set.



### Note

- Not all discs use Parental Lock, and will play without requiring the password first.
- If you forget your password, you'll need to reset the player to register a new password. (see *Resetting the player* on page 47)

## Registering a new password

You must register a password before you can change the Parental Lock level or enter a Country code.

### 1 Select 'Options', then 'Password'.

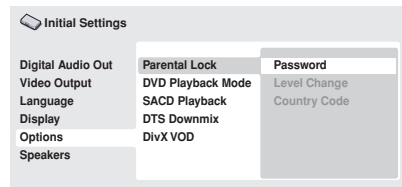

### 2 Use the number buttons to enter a 4-digit password.

The numbers you enter show up as asterisks (\*) on-screen.

### 3 Press ENTER to register the password.

You will return to the Options menu screen.

## Changing your password

To change your password, confirm your existing password then enter a new one.

### 1 Select 'Password Change'.

### 2 Use the number buttons to enter your existing password, then press ENTER.

### 3 Enter a new password and press ENTER.

This registers the new password and you will return to the Options menu screen.

## Setting/changing the Parental Lock

- 1 Select 'Level Change'.
- 2 Use number buttons to enter your password, then press ENTER.
- 3 Select a new level and press ENTER.
  - Press ← (cursor left) repeatedly to lock more levels (more discs will require the password); press → (cursor right) to unlock levels. You can't lock level 1.

This sets the new level and you will return to the Options menu screen.

## Setting/changing the Country/Area code

You can find the *Country/Area code list* on page 48.

- 1 Select 'Country Code'.
- 2 Use number buttons to enter your password, then press ENTER.
- 3 Select a Country/Area code and press ENTER.

There are two ways you can do this:

- Select by code letter: Use ↑/↓ (cursor up/down) to change the Country/Area code.
- Select by code number: Press → (cursor right) then use the number buttons to enter the 4-digit Country/Area code.

The new Country/Area code is set and you will return to the Options menu screen. Note that the new Country/Area code doesn't take effect until the next disc is loaded (or the current disc is reloaded).

## DTS Downmix

- Default setting: **Stereo**

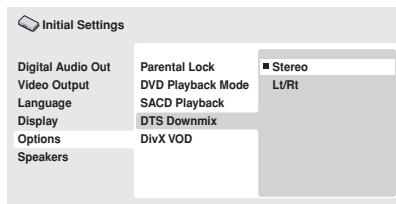

If you've selected **DTS > PCM** in *DTS Out* on page 35 or **2 Channel** in *Audio Output Mode* on page 41, you can choose the way the signal is downmixed to PCM audio. **Stereo** will downmix the DTS signal to 2-channel stereo, whereas **Lt/Rt** will downmix to a 2-channel signal compatible with Dolby surround matrix decoders. (This allows you to hear surround sound if your AV receiver or amplifier has Dolby Pro Logic capability.)

## About DivX® VOD content

In order to play DivX VOD (video on demand) content on this player, you first need to register the player with your DivX VOD content provider. You do this by generating a DivX VOD registration code, which you submit to your provider.



### Important

- DivX VOD content is protected by a DRM (Digital Rights Management) system. This restricts playback of content to specific, registered devices.
- If you load a disc that contains DivX VOD content not authorized for your player, the message **Authorization Error** is displayed and the content will not play.

- Resetting the player (as described in *Resetting the player* in the main Operating Instructions) will not cause you to lose your registration code.

## Displaying your DivX VOD registration code

- Press **HOME MENU** and select '**Initial Settings**'.
- Select '**Options**', then '**DivX VOD**'.

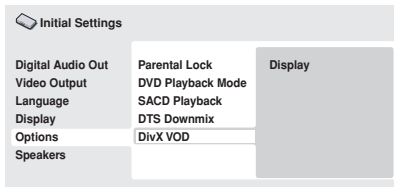

- Select '**Display**'.

Your 8-digit registration code is displayed.

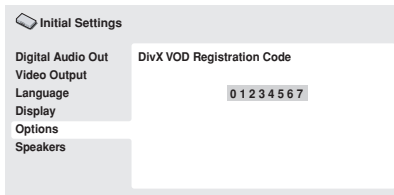

Make a note of the code as you will need it when you register with a DivX VOD provider.

## Playing DivX® VOD content

Some DivX VOD content may only be playable a fixed number of times. When you load a disc containing this type of DivX VOD content, the remaining number of plays is shown on-screen and you then have the option of playing the disc (thereby using up one of the remaining plays), or stopping. If you load a disc that contains expired DivX VOD content (for example, content that has zero remaining plays), the message **Rental Expired** is displayed.

If your DivX VOD content allows an unlimited number of plays, then you may load the disc into your player and play the content as often as you like, and no message will be displayed.



## Speakers settings

Setting	Option	What it means
<b>Audio Output Mode</b>	<b>2 Channel</b>	The player outputs analog audio in stereo only. See also <i>Audio Output Mode</i> below.
	<i>5.1 Channel</i>	The player outputs 5.1 channel analog audio. See also <i>Audio Output Mode</i> below.
<b>Speaker Installation</b>	–	Specify the number and size of speakers in your system. See also <i>Speaker Installation</i> on page 44.
<b>Speaker Distance</b>	–	Specify the distance of your speakers from your listening position. <i>Speaker Distance</i> on page 43.

### Audio Output Mode

- Default setting: **2 Channel**

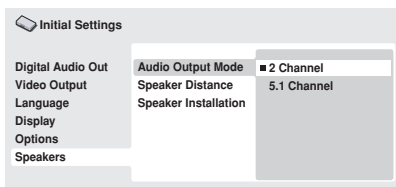

If you connected this player to your amplifier using the 5.1 channel analog outputs (front, surround, center and subwoofer outs), set this to **5.1 Channel**; if you connected only the stereo outs, set to **2 Channel**.

#### Note

- Even if you set **Audio Output Mode** to **5.1 Channel**, you'll only get sound from all speakers when playing a 5.1 channel multi-channel disc.
- When set to **5.1 Channel**, only the front left/right channels are output from the **AUDIO OUT (2ch)** jacks. Change to **2 Channel** if you want to listen to downmixed stereo audio (for example, because you are listening through the TV's built-in speakers).

- When set to **5.1 Channel** there is no digital output when playing DVD-Audio.
- If you set to **2 Channel**, Dolby Digital, DTS and MPEG audio is mixed down to two channels so you still hear all the audio recorded on the disc. With DTS encoded audio, you can choose how the signal is downmixed to PCM audio. See *DTS Downmix* on page 39 to change the downmix setting.
- Some DVD-Audio discs don't allow downmixing of audio. These discs always output multi-channel audio regardless of the setting made here.

## About the audio output settings

The table below shows how the audio settings you make in the Initial Settings menu (see page 35) affect the output from the 2 channel and the 5.1 channel analog outputs, and from the digital outputs with various types of disc.

Disc audio format	Player setting	Front L/R analog outputs*1	Surround L/R Center, SW, outputs*1	Digital outputs PCM convert*2	Bitstream*3	
DVD	Dolby Digital	2 Ch	2ch downmix	–	2ch downmix	Dolby Digital
		5.1 Ch	Front L / R	Surround L/R, Center, SW	2ch downmix	Dolby Digital
	Dolby Digital karaoke	2 Ch / 5.1 Ch	Left / Right	–	Left / Right	Dolby Digital
	Linear PCM	2 Ch / 5.1 Ch	Left / Right	–	Left / Right	Left / Right
	DTS	2 Ch	2ch downmix	–	2ch downmix	DTS
		5.1 Ch	Front L / R	Surround L/R, Center, SW	2ch downmix	DTS
	MPEG	2 Ch	Left / Right	–	Left / Right	MPEG
		5.1 Ch	Front L / R	Surround L/R, Center, SW	Left / Right	MPEG
	DVD-Audio	2 Ch	2ch downmix*4	–	2ch downmix*5	2ch downmix*5
		5.1 Ch	Front L / R	Surround L/R, Center, SW	–	–
DVD-RW (VR mode)	2 Ch / 5.1 Ch	Left / Right*6	–	Left / Right	Dolby Digital MPEG or PCM	
Super Audio CD	2 Ch	2ch downmix	–	–	–	
	5.1 Ch	Front L / R	Surround L/R, Center, SW	–	–	
CD	2 Ch / 5.1 Ch	Left / Right	–	Left / Right	Left / Right	
DTS CD	2 Ch	2ch downmix	–	2ch downmix	DTS	
	5.1 Ch	Front L / R	Surround L/R, Center, SW	2ch downmix	DTS	
Video CD	2 Ch / 5.1 Ch	Left / Right	–	Left / Right	Left / Right	

\*1 When **Audio Output Mode** is set to **2 Channel**, the **AUDIO OUT (5.1ch) FRONT L / R** jacks act as a second pair of stereo audio outputs.

\*2 **Dolby Digital > PCM**, **MPEG > PCM** or **DTS > PCM** setting (pages 35–36)

\*3 **Dolby Digital**, **MPEG** or **DTS** setting (pages 35–36)

\*4 Discs that prohibit downmixing will be output as 5.1 channel even if **2 Channel** is selected as the **Audio Output Mode** setting (see page 41).

\*5 Discs that prohibit downmixing also mute the digital output.

\*6 When **Audio Output Mode** is set to **5.1 Channel**, mono sources are heard from the center speaker only.

## Speaker Distance

- Default settings: all speakers **10.0ft.**

You only need to make this setting if you connected this player to your amplifier using the 5.1 channel analog outputs.

These settings do not affect any digital audio output.

To get the best surround sound from your system, you should set up the speaker distances from your listening position.

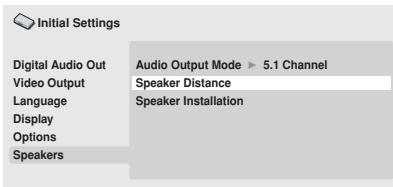

### 1 Use the ↑/↓ (cursor up/down) to select a speaker.

- The **L** and **R** speakers are paired; you can't set them differently.

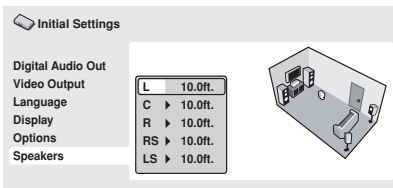

### 2 Press → (cursor right) to change the speaker distance for the highlighted speaker.

### 3 Use the ↑/↓ (cursor up/down) to change the distance.

- When you change the distance settings of the front left (**L**) or front right (**R**) speakers, all the other speaker distances change relative to it.

- Front left/right (**L/R**) speaker distances can be set from 1 ft. to 30 ft. in 1 ft. increments.
- The center speaker (**C**) can be set from -7 ft. to 0.0 ft. relative to the front left/right speakers.
- Surround left/right (**SL/SR**) speakers can be set from -20 ft. to 0.0 ft. relative to the front left/right speakers.
- You can't set the subwoofer (**SW**) distance.

### 4 Press ← (cursor left) to go back to the speaker list if you want to modify another speaker, or press ENTER to exit the Speaker Distance screen.



#### Note

During playback of SACD and MPEG-audio DVD-Video discs, the effective **C**, **SL** and **SR** speaker distance settings are -3.0ft. to 0.0ft. relative to the front left/right speakers.

## Speaker Installation

- Default settings: **L/R: Large | C: Large | SL/SR: Large | SW: On**

*You only need to make this setting if you connected this player to your amplifier using the 5.1 channel analog outputs.*

*This setting does not affect digital audio output.*

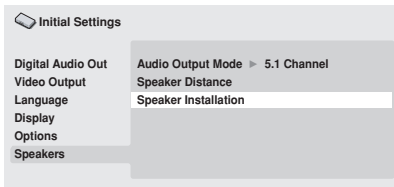

Use the Speaker Installation screen to tell the player what kinds of speakers you have connected.

### 1 Use the ↑/↓ (cursor up/down) buttons to select a speaker.

- The **L** and **R**, and **SR** and **SL** speakers are paired; you can't set them differently.

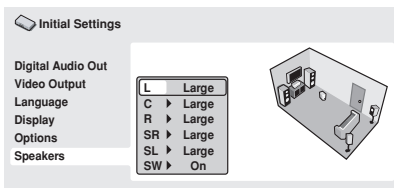

### 2 Press → (cursor right) to modify the selected speaker.

### 3 Use the ↑/↓ (cursor up/down) buttons to change the current setting.

- You can see the effect of your changes in the room graphic on the right of the screen.
- Except for the subwoofer, you can set speaker size to **Large** or **Small**. If the main speaker cone in the speaker is 12cm or more, set to **Large**, otherwise set to **Small** (or **Off** if you don't have that speaker).

- If you set the front **L** and **R** speakers to **Small**, the center and surround speakers are automatically set to **Small** and the subwoofer to **On**.
- The subwoofer can only be set to **On** or **Off**.

### 4 Press ← (cursor left) to go back to the speaker list if you want to modify another speaker, or press ENTER to exit the Speaker Installation screen.

## Chapter 8

# Additional information

### Taking care of your player and discs

#### General

Hold discs by the edge or by the center hole and edge.

When you're not using a disc, return it to its case and store upright. Avoid leaving discs in excessively cold, humid, or hot environments (including under direct sunlight).

Don't glue paper or put stickers on to discs. Do not use a pencil, ball-point pen or other sharp-tipped writing instrument to write on the disc.



Don't use self-adhesive disc labels on discs as these can cause the disc to warp slightly during playback causing distortion in the picture and/or sound.

#### Damaged and shaped discs

Do not use cracked, chipped, warped, or otherwise damaged discs as they may damage the player.

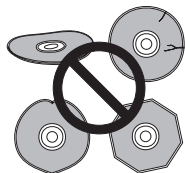

This player is designed to be used only with conventional, fully circular discs. Do not use shaped discs. Pioneer disclaims all liability arising in connection with the use of shaped discs.

#### Cleaning discs

Fingerprints and dust on discs can affect playback performance. Clean using a soft, dry cloth, wiping the disc lightly from the center to the outside edge as shown below.

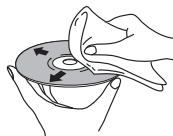

If necessary, use a cloth soaked in alcohol, or a commercially available CD/DVD cleaning kit to clean a disc more thoroughly. Never use benzene, thinner or other cleaning agents, including products designed for cleaning vinyl records.

#### Cleaning the unit's exterior

Unplug the unit before cleaning.

Use a dry cloth to wipe off dust and dirt. If the surfaces are very dirty, wipe with a soft cloth dipped in some neutral cleanser diluted five or six times with water and wrung out well, then wipe again with a dry cloth.

Do not use furniture wax or cleaners. Never use thinners, benzene or insecticide sprays or other chemicals on or near this unit.

If you use a chemical-impregnated cleaning cloth, read the instructions carefully before use. These cloths may leave smear marks on half-mirror finish surfaces; if this happens, finish with a dry cloth.

### Cleaning the pickup lens

The DVD player's lens should not become dirty in normal use, but if for some reason it should malfunction due to dust or dirt, consult your nearest Pioneer-authorized service center. We do not recommend using commercially available lens cleaners for CD players.

### Condensation

Condensation may form inside the player if it is brought into a warm room from outside, or if the temperature of the room rises quickly. Although the condensation won't damage the player, it may temporarily impair its performance. Leave it to adjust to the warmer temperature for about an hour before switching on.

### Moving the player

If you need to move the player, first press **⏻ STANDBY/ON** on the front panel to turn the player off. Wait for **-OFF-** to disappear from the display, then unplug the power cable. Never lift or move the unit during playback—discs rotate at a high speed and may be damaged.

### Screen sizes and disc formats

DVD-Video discs come in several different screen aspect ratios, ranging from TV programs, which are generally 4:3, to CinemaScope widescreen movies, with an aspect ratio of up to about 7:3.

Televisions, too, come in different aspect ratios; 'standard' 4:3 and widescreen 16:9.

### Widescreen TV users

If you have a widescreen TV, the **TV Screen** setting (page 36) of this player should be set to **16:9 (Wide)**.

When you watch discs recorded in 4:3 format, you can use the TV controls to select how the picture is presented. Your TV may offer various zoom and stretch options; see the instructions that came with your TV for details.

Please note that some movie aspect ratios are wider than 16:9, so even though you have a widescreen TV, these discs will still play in a 'letter box' style with black bars at the top and bottom of the screen.

### Standard TV users

If you have a standard TV, the **TV Screen** setting (page 36) of this player should be set to **4:3 (Letter Box)** or **4:3 (Pan&Scan)**, depending on which you prefer.

Set to **4:3 (Letter Box)**, widescreen discs are shown with black bars top and bottom.



Set to **4:3 (Pan&Scan)**, widescreen discs are shown with the left and right sides cropped. Although the picture looks larger, you don't actually see the whole picture.





Please note that many widescreen discs override the player's settings so that the disc is shown in letter box format regardless of the setting.

### Note

- Using the **16:9 (Wide)** setting with a standard 4:3 TV, or either of the 4:3 settings with a widescreen TV, will result in a distorted picture.

## Resetting the player

Use this procedure to reset all the player's settings to the factory default.

- Switch the player into standby.**
- Using the front panel buttons, hold down the  (stop) button and press  **STANDBY/ON** to switch the player back on.**

All the player's settings are now reset.

## DVD-Video regions



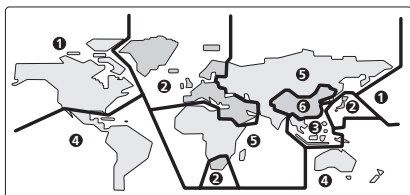

All DVD-Video discs carry a region mark on the case somewhere that indicates which region(s) of the world the disc is compatible with. Your DVD player also has a region mark, which you can find on the rear panel. Discs from incompatible regions will not play in this player. Discs marked **ALL** will play in any player.

The diagram below shows the various DVD regions of the world.



## Selecting languages using the language code list

Some of the language options (such as 'DVD Language' in the Setup Navigator) allow you to set your preferred language from any of the 136 languages listed in the language code list on page 48.

- Select 'Other Language'.**
- Use the / (cursor left/right) buttons to select either a code letter or a code number.**
- Use the / (cursor up/down) buttons to select a code letter or a code number.**  
See *Language code list* on page 48 for a complete list of languages and codes.

## Language code list

Language (Language code letter), **Language code**

Japanese (ja), <b>1001</b>	Bhutani (dz), <b>0426</b>	Kirghiz (ky), <b>1125</b>	Sinhalese (si), <b>1909</b>
English (en), <b>0514</b>	Esperanto (eo), <b>0515</b>	Latin (la), <b>1201</b>	Slovak (sk), <b>1911</b>
French (fr), <b>0618</b>	Estonian (et), <b>0520</b>	Lingala (ln), <b>1214</b>	Slovenian (sl), <b>1912</b>
German (de), <b>0405</b>	Basque (eu), <b>0521</b>	Laothian (lo), <b>1215</b>	Samoa (sm), <b>1913</b>
Italian (it), <b>0920</b>	Persian (fa), <b>0601</b>	Lithuanian (lt), <b>1220</b>	Shona (sn), <b>1914</b>
Spanish (es), <b>0519</b>	Finnish (fi), <b>0609</b>	Latvian (lv), <b>1222</b>	Somali (so), <b>1915</b>
Chinese (zh), <b>2608</b>	Fiji (fj), <b>0610</b>	Malagasy (mg), <b>1307</b>	Albanian (sq), <b>1917</b>
Dutch (nl), <b>1412</b>	Faroese (fo), <b>0615</b>	Maori (mi), <b>1309</b>	Serbian (sr), <b>1918</b>
Portuguese (pt), <b>1620</b>	Frisian (fy), <b>0625</b>	Macedonian (mk), <b>1311</b>	Siswati (ss), <b>1919</b>
Swedish (sv), <b>1922</b>	Irish (ga), <b>0701</b>	Malayalam (ml), <b>1312</b>	Sesotho (st), <b>1920</b>
Russian (ru), <b>1821</b>	Scots-Gaelic (gd), <b>0704</b>	Mongolian (mn), <b>1314</b>	Sundanese (su), <b>1921</b>
Korean (ko), <b>1115</b>	Galician (gl), <b>0712</b>	Moldavian (mo), <b>1315</b>	Swahili (sw), <b>1923</b>
Greek (el), <b>0512</b>	Guarani (gn), <b>0714</b>	Marathi (mr), <b>1318</b>	Tamil (ta), <b>2001</b>
Afar (aa), <b>0101</b>	Gujarati (gu), <b>0721</b>	Malay (ms), <b>1319</b>	Telugu (te), <b>2005</b>
Abkhazian (ab), <b>0102</b>	Hausa (ha), <b>0801</b>	Maltese (mt), <b>1320</b>	Tajik (tg), <b>2007</b>
Afrikaans (af), <b>0106</b>	Hindi (hi), <b>0809</b>	Burmese (my), <b>1325</b>	Thai (th), <b>2008</b>
Amharic (am), <b>0113</b>	Croatian (hr), <b>0818</b>	Nauru (na), <b>1401</b>	Tigrinya (ti), <b>2009</b>
Arabic (ar), <b>0118</b>	Hungarian (hu), <b>0821</b>	Nepali (ne), <b>1405</b>	Turkmen (tk), <b>2011</b>
Assamese (as), <b>0119</b>	Armenian (hy), <b>0825</b>	Norwegian (no), <b>1415</b>	Tagalog (tl), <b>2012</b>
Aymara (ay), <b>0125</b>	Interlingua (ia), <b>0901</b>	Occitan (oc), <b>1503</b>	Setswana (tn), <b>2014</b>
Azerbaijani (az), <b>0126</b>	Interlingue (ie), <b>0905</b>	Oromo (om), <b>1513</b>	Tonga (to), <b>2015</b>
Bashkir (ba), <b>0201</b>	Inupiak (ik), <b>0911</b>	Oriya (or), <b>1518</b>	Turkish (tr), <b>2018</b>
Byelorussian (be), <b>0205</b>	Indonesian (in), <b>0914</b>	Panjabi (pa), <b>1601</b>	Tsonga (ts), <b>2019</b>
Bulgarian (bg), <b>0207</b>	Icelandic (is), <b>0919</b>	Polish (pl), <b>1612</b>	Tatar (ta), <b>2020</b>
Bihari (bh), <b>0208</b>	Hebrew (iw), <b>0923</b>	Pashto, Pushto (ps), <b>1619</b>	Twi (tw), <b>2023</b>
Bislama (bi), <b>0209</b>	Yiddish (ji), <b>1009</b>	Quechua (qu), <b>1721</b>	Ukrainian (uk), <b>2111</b>
Bengali (bn), <b>0214</b>	Javanese (jw), <b>1023</b>	Rhaeto-Romance (rm), <b>1813</b>	Urdu (ur), <b>2118</b>
Tibetan (bo), <b>0215</b>	Georgian (ka), <b>1101</b>	Kirundi (rn), <b>1814</b>	Uzbek (uz), <b>2126</b>
Breton (br), <b>0218</b>	Kazakh (kk), <b>1111</b>	Romanian (ro), <b>1815</b>	Vietnamese (vi), <b>2209</b>
Catalan (ca), <b>0301</b>	Greenlandic (kl), <b>1112</b>	Kinyarwanda (rw), <b>1823</b>	Volapük (vo), <b>2215</b>
Corsican (co), <b>0315</b>	Cambodian (km), <b>1113</b>	Sanskrit (sa), <b>1901</b>	Wolof (wo), <b>2315</b>
Czech (cs), <b>0319</b>	Kannada (kn), <b>1114</b>	Sindhi (sd), <b>1904</b>	Xhosa (xh), <b>2408</b>
Welsh (cy), <b>0325</b>	Kashmiri (ks), <b>1119</b>	Sangho (sg), <b>1907</b>	Yoruba (yo), <b>2515</b>
Danish (da), <b>0401</b>	Kurdish (ku), <b>1121</b>	Serbo-Croatian (sh), <b>1908</b>	Zulu (zu), <b>2621</b>

## Country/Area code list

Country/Area, **Country/Area code**, **Country/Area code letter**

Argentina, <b>0118</b> , <b>ar</b>	Finland, <b>0609</b> , <b>fi</b>	Malaysia, <b>1325</b> , <b>my</b>	Singapore, <b>1907</b> , <b>sg</b>
Australia, <b>0121</b> , <b>au</b>	France, <b>0618</b> , <b>fr</b>	Mexico, <b>1324</b> , <b>mx</b>	Spain, <b>0519</b> , <b>es</b>
Austria, <b>0120</b> , <b>at</b>	Germany, <b>0405</b> , <b>de</b>	Netherlands, <b>1412</b> , <b>nl</b>	Sweden, <b>1905</b> , <b>se</b>
Belgium, <b>0205</b> , <b>be</b>	Hong Kong, <b>0811</b> , <b>hk</b>	New Zealand, <b>1426</b> , <b>nz</b>	Switzerland, <b>0308</b> , <b>ch</b>
Brazil, <b>0218</b> , <b>br</b>	India, <b>0914</b> , <b>in</b>	Norway, <b>1415</b> , <b>no</b>	Taiwan, <b>2023</b> , <b>tw</b>
Canada, <b>0301</b> , <b>ca</b>	Indonesia, <b>0904</b> , <b>id</b>	Pakistan, <b>1611</b> , <b>pk</b>	Thailand, <b>2008</b> , <b>th</b>
Chile, <b>0312</b> , <b>cl</b>	Italy, <b>0920</b> , <b>it</b>	Philippines, <b>1608</b> , <b>ph</b>	United Kingdom, <b>0702</b> , <b>gb</b>
China, <b>0314</b> , <b>cn</b>	Japan, <b>1016</b> , <b>jp</b>	Portugal, <b>1620</b> , <b>pt</b>	USA, <b>2119</b> , <b>us</b>
Denmark, <b>0411</b> , <b>dk</b>	Korea, Republic of, <b>1118</b> , <b>kr</b>	Russian Federation, <b>1821</b> , <b>ru</b>	



## Troubleshooting

Incorrect operation is often mistaken for trouble or malfunction. If you think that there is something wrong with this component, check the points below. Sometimes the trouble may lie in another component. Inspect the other components and electrical appliances being used. If the trouble cannot be rectified after checking the items below, ask your nearest Pioneer authorized service center or your dealer to carry out repair work.

Problem	Remedy
<b>The disc won't play or is automatically ejected after loading.</b>	<ul style="list-style-type: none"> <li>• Make sure the disc is free from dirt and dust and is not damaged (page 45).</li> <li>• Make sure the disc is loaded with the label side face-up and aligned properly in the disc tray guide.</li> <li>• Incompatible region number: If the region number on a DVD-Video disc does not match the number on the player, the disc cannot be used (page 47).</li> <li>• Condensation inside the player: Allow time for condensation to evaporate. Avoid using the player near an air-conditioning unit.</li> <li>• Disc is loaded upside down: Reload the disc with the label side face up.</li> <li>• A Super VCD that does not conform with the IEC standards might not play normally.</li> <li>• Check that the disc is not a DualDisc or other incompatible format disc (page 8).</li> </ul>
<b>DVD-Audio playback stops.</b>	<ul style="list-style-type: none"> <li>• The disc may have been illegally copied.</li> </ul>
<b>Picture playback stops and the operation buttons cannot be used.</b>	<ul style="list-style-type: none"> <li>• Press <b>■</b>, then start playback again (▶).</li> <li>• Press and hold the front panel <b>⏻</b> <b>STANDBY/ON</b> button for about 10 seconds to switch the unit off, then press again to switch back on.</li> <li>• Switch the power off once, unplug from the wall socket, then plug back in and switch on again using the front panel <b>⏻</b> <b>STANDBY/ON</b> button.</li> </ul>
<b>New settings made in the Setup screen menus while a disc is playing are ineffective.</b>	<ul style="list-style-type: none"> <li>• Some settings can be changed while a disc is playing, but are not effective until the disc is stopped then restarted: Press <b>■</b>, then start playback again (▶).</li> </ul>
<b>Settings are canceled.</b>	<ul style="list-style-type: none"> <li>• When the power is cut due to power failure or by unplugging the power cord, settings will be canceled: Press <b>⏻</b> <b>STANDBY/ON</b> on the front panel to turn the player off. Wait for <b>--OFF--</b> to disappear from the display, then unplug the power cord.</li> </ul>
<b>The remote control doesn't seem to work.</b>	<ul style="list-style-type: none"> <li>• The remote control is too far from the player, or the angle with the remote sensor is too wide: Use the remote within its operating range (page 17).</li> <li>• The batteries are exhausted: Put in new ones (page 7).</li> </ul>

Problem	Remedy
<b>No picture/No color.</b>	<ul style="list-style-type: none"> <li>• Incorrect video connections: Check that connections are correct and that plugs are inserted fully. Also check the video cable for damage.</li> <li>• TV/monitor or AV amplifier settings are incorrect: Check the instruction manual of the connected equipment.</li> <li>• The video output is set to progressive but your TV/monitor is not compatible with progressive scan: See page 13 for how to set to interlace.</li> </ul>
<b>Screen is stretched or aspect does not change.</b>	<ul style="list-style-type: none"> <li>• The <b>TV Screen</b> setting in the Initial Settings menu is incorrect. See page 46 for how to set it correctly for your TV/monitor.</li> </ul>
<b>Picture disturbance during playback or the picture is dark.</b>	<ul style="list-style-type: none"> <li>• This player is compatible with Macro-Vision System copy guard. Some discs include a copy prevention signal, and when this type of disc is played back, stripes etc., may appear on some sections of the picture depending on the TV. This is not a malfunction.</li> <li>• Due to the player's copy protection circuits, connection of this device through a VCR or an AV selector may prevent recording or cause picture problems. This is not a malfunction.</li> </ul>
<b>No audio, or audio is distorted.</b>	<ul style="list-style-type: none"> <li>• No audio is output during slow motion playback or when scanning discs other than audio CDs and SACDs.</li> <li>• Some DVD discs do not output digital audio: Switch your amplifier to the player's analog outputs.</li> <li>• Check that the disc is free from dust and dirt, and that it is not damaged (page 45).</li> <li>• Check that all interconnects are firmly inserted.</li> <li>• Check that the plugs and terminals are free of dirt, oxide, etc. and clean if necessary. Also check the cable for damage.</li> <li>• Make sure the player's output is not connected to the amplifier's phono (turntable) inputs.</li> <li>• Check your amplifier/receiver's settings (volume, input function, speaker settings, etc.).</li> </ul>
<b>The analog audio is OK, but there appears to be no digital audio signal.</b>	<ul style="list-style-type: none"> <li>• Make sure that the <b>Digital Out</b> setting is set to <b>On</b> (page 35).</li> <li>• Check that the Dolby Digital, DTS and MPEG out settings (pages 35–36) are suitable for your amplifier/receiver—check the instruction manual that came with your amplifier/receiver.</li> <li>• SACDs and DVD-Audio discs do not output digital audio. Listen through the player's analog audio outputs.</li> </ul>
<b>Noticeable difference in DVD and CD volume.</b>	<ul style="list-style-type: none"> <li>• This is due to differences in the audio format and is not a malfunction.</li> </ul>

Problem	Remedy
<p><b>Cannot play multi-channel audio</b></p>	<ul style="list-style-type: none"> <li>• Make sure that <b>Audio Output Mode</b> is set to <b>5.1 Channel</b> (page 41).</li> <li>• Check that the Dolby Digital, DTS and MPEG Out settings (pages 35–36) are suitable for your amplifier/receiver—check the instruction manual that came with your amplifier/receiver.</li> <li>• DVD-Audio and SACDs do not output multichannel digital audio. Listen through the player’s analog outputs.</li> <li>• Check that the settings in the Speaker Installation screen are correct (page 44).</li> <li>• Check the audio options available from the disc menu.</li> </ul>
<p><b>Cannot listen to high-sampling rate audio through the digital output.</b></p>	<ul style="list-style-type: none"> <li>• Make sure that <b>Linear PCM Out</b> is set to <b>Downsample Off</b> (page 36).</li> <li>• As a copy-protection measure, some DVDs do not output 96kHz audio. In this case, even if set to <b>Downsample Off</b>, the player automatically outputs the audio at 48 kHz. This is not a malfunction.</li> </ul>
<p><b>Cannot output 192kHz or 176.4kHz digital audio.</b></p>	<ul style="list-style-type: none"> <li>• The player does not output digital audio at these sampling rates. The digital output is automatically downsampled.</li> </ul>
<p><b>Cannot output 96kHz or 88.2kHz digital audio.</b></p>	<ul style="list-style-type: none"> <li>• Check that <b>Linear PCM Out</b> is set to <b>Downsample Off</b> (page 36).</li> <li>• Some discs are digital copy protected and do not output high sampling rate digital audio. In this case the output is automatically downsampled.</li> </ul>
<p><b>No DTS audio output.</b></p>	<ul style="list-style-type: none"> <li>• If this unit is connected to a non-DTS compatible amplifier or decoder using a digital audio cable, set <b>DTS Out</b> to <b>DTS &gt; PCM</b> (page 35). If you do not do this, noise will be output when you play a DTS disc.</li> <li>• If this unit is connected to a DTS-compatible amplifier or decoder using a digital audio cable, check the amplifier settings, and that the cable is properly connected.</li> </ul>
<p><b>Audio mix does not sound right or sounds incomplete (for example, inaudible dialog).</b></p>	<ul style="list-style-type: none"> <li>• Make sure that <b>Audio Output Mode</b> is set to <b>2 Channel</b> if you’ve connected to the stereo inputs on your amplifier or TV (page 41).</li> </ul>
<p><b>Can’t hear effect of Virtual Surround</b></p>	<ul style="list-style-type: none"> <li>• Virtual Surround does not work with SACD or DVD-Audio.</li> <li>• The Virtual Surround effect is only output through the <b>AUDIO OUT (2ch)</b> analog audio outputs.</li> <li>• Make sure that <b>Audio Output Mode</b> is set to <b>2 Channel</b> (page 41).</li> <li>• The effectiveness of Virtual Surround varies with the disc.</li> </ul>

**Note**

- Static electricity or other external influences may cause malfunctioning of this unit. In this case, unplug the power cord and then plug back in. This will usually reset the unit for proper operation. If this does not correct the problem, please consult your nearest Pioneer service center.

## Glossary

**Analog audio** Direct representation of sound by an electrical signal. See also *Digital audio*.

**Aspect ratio** The width of a TV screen relative to its height. Conventional TVs are 4:3; widescreen models are 16:9.

**Bonus Group (DVD-Audio only)** An 'extra' group on some DVD-Audio discs that requires a key number to access.

**Browsable pictures (DVD-Audio only)** A feature of some DVD-Audio discs in which the user can browse still pictures recorded on the disc as the audio is played. See also *Slideshow*.

**Digital audio** Indirect representation of sound using numbers. See also *Sampling frequency* and *Analog audio*.

**DivX** DivX is a compressed digital video format created by the DivX<sup>®</sup> video codec from DivXNetworks, Inc.



**Dolby Digital<sup>\*1</sup>** A multi-channel audio encoding system developed by Dolby Laboratories that enables far more audio to be stored on a disc than PCM encoding. See also *PCM (Pulse Code Modulation)*.



**DRM (WMA)** DRM (Digital Rights Management) copy protection is a technology designed to prevent unauthorized copying by restricting playback, etc. of material on devices other than the PC (or other WMA recording equipment) used to record it. For detailed information, please see the instruction manuals or help files that came with your PC (or other WMA recording equipment) and/or software.

**DTS<sup>\*2</sup>**



A multi-channel audio encoding system developed by Digital Theater Systems that enables far more audio to be stored on a disc than PCM encoding. See also *PCM (Pulse Code Modulation)*.

**EXIF (Exchangeable Image File)** A file format developed by Fuji Photo Film for digital still cameras. Digital cameras from various manufacturers use this compressed file format which carries date, time and thumbnail information, as well as the picture data.

**File extension** A tag added to the end of a filename to indicate the type of file. For example, ".mp3" indicates an MP3 file.

**ISO 9660 format** International standard for the volume and file structure of CD-ROM discs.

**JPEG** A standard file format used for still images. JPEG files are identified by the file extension ".jpg".

**MP3** MP3 (MPEG1 audio layer 3) is a compressed stereo audio file format. Files are recognized by their file extension ".mp3".

**MPEG audio** An audio format used on Video CDs and some DVD discs.

**Packed PCM (DVD-Audio only)** A lossless compression system that enables more PCM audio to be stored on a DVD-Audio disc than would otherwise be possible.

**PBC (PlayBack Control)** A system of navigating a Video CD through on-screen menus recorded onto the disc.

**PCM (Pulse Code Modulation)** Digital audio encoding system found on CDs. Good quality, but requires a lot of data compared to Dolby Digital, DTS and MPEG encoded audio. See also *Digital audio*.

**Progressive scan video** All the lines that make up a video picture are updated in one pass (compared to interlace which takes two passes to update the whole picture).

---

**Regions (DVD-Video only)** These associate DVD-Video discs and players with particular areas of the world. See *DVD-Video regions* on page 47 for more information.

---

**Sampling frequency** The rate at which sound is measured to be turned into digital audio data. The higher the rate, the better the sound quality. CD is 44.1 kHz; DVD can be up to 96 kHz. See also *Digital audio*.

---

**WMA** WMA is short for Windows Media Audio and refers to an audio compression technology developed by Microsoft Corporation. Files are recognized by their file extension ".wma". Microsoft, Windows Media, and the Windows logo are trademarks, or registered trademarks of Microsoft Corporation in the United States and/or other countries.

---

**Super Audio CD (SACD)** Super Audio CD is a high quality audio disc format that can accommodate high sampling rate stereo and multi-channel audio, as well as conventional CD audio all on the same disc.

---

*\*1 Manufactured under license from Dolby Laboratories. "Dolby" and the double-D symbol are trademarks of Dolby Laboratories.*

*\*2 "DTS" and "DTS Digital Surround" are registered trademarks of Digital Theater Systems, Inc.*

## Specifications

### General

System	DVD player
Power requirements	AC 120 V, 60 Hz
Power consumption	8 W
Power consumption (standby)	0.7 W
Weight	1.8 kg / 4 lb
Dimensions	
	420 (W) x 49.5 (H) x 225.5 (D) mm (16-9/16 (W) x 1-15/16 (H) x 8-7/8 (D) in.)
Operating temperature	+5°C to +35°C (+41°F to +95°F)
Operating humidity	5% to 85% (no condensation)

### Component video output

Y (luminance) - Output level	1 Vp-p (75 Ω)
P <sub>B</sub> (color) - Output level	0.7 Vp-p (75 Ω)
P <sub>R</sub> (color) - Output level	0.7 Vp-p (75 Ω)
Jack	RCA

### S-video output

Y (luminance) - Output level	1 Vp-p (75 Ω)
C (color) - Output level	286 mVp-p (75 Ω)
Jack	S-video

### Video output

Output level	1 Vp-p (75 Ω)
Jack	RCA

### Audio output (1 stereo pair)

Output level	During audio output 200 mVrms (1 kHz, -20 dB)
Number of channels	2
Jacks	RCA

### Audio output (multi-channel / L, R, C, SW, SL, SR)

Output level	During audio output 200 mVrms (1 kHz, -20 dB)
Number of channels	6
Jacks	RCA jack

### Digital audio characteristics

Frequency response	4 Hz to 44 kHz (DVD fs: 96 kHz) 4 Hz to 48 kHz (DVD-Audio fs: 192 kHz)
S/N ratio	115 dB
Dynamic range	101 dB
Total harmonic distortion	0.0023 %
Wow and flutter	Limit of measurement (±0.001% W. PEAK) or lower

### Digital output

Coaxial digital output	RCA jack
Optical digital output	Optical digital jack

### Accessories

Audio/video cable	1
Remote control	1
AA/R6P dry cell batteries	2
Warranty card	1
Operating Instructions	

*The specifications and design of this product are subject to change without notice, due to improvement.*

Published by Pioneer Corporation.  
Copyright © 2005 Pioneer Corporation.  
All rights reserved

Should this product require service in the U.S.A. and you wish to locate the nearest Pioneer Authorized Independent Service Company, or if you wish to purchase replacement parts, operating instructions, service manuals, or accessories, please call the number shown below.

8 0 0 - 4 2 1 - 1 4 0 4

Please do not ship your product to Pioneer without first calling the Customer Support Division at the above listed number for assistance.

PIONEER ELECTRONICS SERVICE INC.  
CUSTOMER SUPPORT DIVISION  
P.O. BOX 1760, LONG BEACH,  
CA 90801-1760, U.S.A.

For warranty information please see the Limited Warranty sheet included with your product.

S017\_En



J2G60101B SH 05/05

Published by Pioneer Corporation.  
Copyright © 2005 Pioneer Corporation.  
All rights reserved

---

## PIONEER CORPORATION

4-1, Meguro 1-Chome, Meguro-ku, Tokyo 153-8654, Japan

### PIONEER ELECTRONICS (USA) INC.

P.O. BOX 1540, Long Beach, California 90810-1540, U.S.A. TEL: (800) 421-1404

### PIONEER ELECTRONICS OF CANADA, INC.

300 Allstate Parkway, Markham, Ontario L3R OP2, Canada TEL: 1-877-283-5901

### PIONEER EUROPE NV

Haven 1087, Keetberglaan 1, B-9120 Melsele, Belgium TEL: 03/570.05.11

### PIONEER ELECTRONICS ASIACENTRE PTE. LTD.

253 Alexandra Road, #04-01, Singapore 159936 TEL: 65-6472-7555

### PIONEER ELECTRONICS AUSTRALIA PTY. LTD.

178-184 Boundary Road, Braeside, Victoria 3195, Australia, TEL: (03) 9586-6300

### PIONEER ELECTRONICS DE MEXICO S.A. DE C.V.

Bldv.Manuel Avila Camacho 138 10 piso Col.Lomas de Chapultepec, Mexico,D.F. 11000 TEL: 55-9178-4270

K002\_A\_En

## Free Manuals Download Website

<http://myh66.com>

<http://usermanuals.us>

<http://www.somanuals.com>

<http://www.4manuals.cc>

<http://www.manual-lib.com>

<http://www.404manual.com>

<http://www.luxmanual.com>

<http://aubethermostatmanual.com>

Golf course search by state

<http://golfingnear.com>

Email search by domain

<http://emailbydomain.com>

Auto manuals search

<http://auto.somanuals.com>

TV manuals search

<http://tv.somanuals.com>