

Pioneer *sound.vision.soul*

DVD Player & VCR

DV-PT100

Register Your Product on
www.pioneerelectronics.com

Operating Instructions





The lightning flash with arrowhead, within an equilateral triangle, is intended to alert the user to the presence of uninsulated "dangerous voltage" within the product's enclosure that may be of sufficient magnitude to constitute a risk of electric shock to persons.

CAUTION

**RISK OF ELECTRIC SHOCK
DO NOT OPEN**

CAUTION:
TO PREVENT THE RISK OF ELECTRIC SHOCK, DO NOT REMOVE COVER (OR BACK). NO USER-SERVICEABLE PARTS INSIDE. REFER SERVICING TO QUALIFIED SERVICE PERSONNEL.



The exclamation point within an equilateral triangle is intended to alert the user to the presence of important operating and maintenance (servicing) instructions in the literature accompanying the appliance.

D1-4-2-3_En

IMPORTANT NOTICE – THE SERIAL NUMBER FOR THIS EQUIPMENT IS LOCATED IN THE REAR. PLEASE WRITE THIS SERIAL NUMBER ON YOUR ENCLOSED WARRANTY CARD AND KEEP IN A SECURE AREA. THIS IS FOR YOUR SECURITY.

D1-4-2-6-1_En

NOTE: This equipment has been tested and found to comply with the limits for a Class B digital device, pursuant to Part 15 of the FCC Rules. These limits are designed to provide reasonable protection against harmful interference in a residential installation. This equipment generates, uses and can radiate radio frequency energy and, if not installed and used in accordance with the instructions, may cause harmful interference to radio communications. However, there is no guarantee that interference will not occur in a particular installation. If this equipment does cause harmful interference to radio or television reception, which can be determined by turning the equipment off and on, the user is encouraged to try to correct the interference by one or more of the following measures:

- Reorient or relocate the receiving antenna.
- Increase the separation between the equipment and receiver.
- Connect the equipment into an outlet on a circuit different from that to which the receiver is connected.
- Consult the dealer or an experienced radio/TV technician for help.

D8-10-1-2_En

Information to User

Alteration or modifications carried out without appropriate authorization may invalidate the user's right to operate the equipment.

D8-10-2_En

This product contains mercury. Disposal of this material may be regulated due to environmental considerations. For disposal or recycling information, please contact your local authorities or the Electronics Industries Alliance : www.eiae.org.

K057_En

WARNING – TO PREVENT FIRE OR SHOCK HAZARD, DO NOT EXPOSE THIS APPLIANCE TO RAIN OR MOISTURE.

D1-4-2-1_En

CAUTION:
THIS PRODUCT EMPLOYS A LASER SYSTEM.

TO ENSURE PROPER USE OF THIS PRODUCT, PLEASE READ THIS USER'S GUIDE CAREFULLY AND RETAIN FOR FUTURE REFERENCE. SHOULD THE UNIT REQUIRE MAINTENANCE, CONTACT AN AUTHORIZED SERVICE LOCATION-SEE SERVICE PROCEDURE.

USE OF CONTROLS, ADJUSTMENTS OR THE PERFORMANCE OF PROCEDURES OTHER THAN THOSE SPECIFIED HEREIN MAY RESULT IN HAZARDOUS RADIATION EXPOSURE.

TO PREVENT DIRECT EXPOSURE TO LASER BEAM, DO NOT TRY TO OPEN THE ENCLOSURE. VISIBLE LASER RADIATION MAY BE PRESENT WHEN THE ENCLOSURE IS OPENED. DO NOT STARE INTO BEAM.

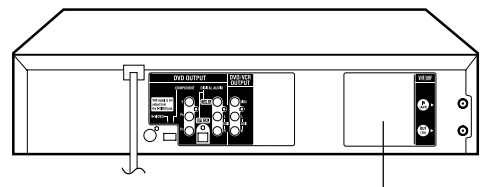

Location of the required Marking

The rating sheet and the safety caution are on the rear of the unit.

CERTIFICATION: COMPLIES WITH FDA RADIATION PERFORMANCE STANDARDS, 21 CFR SUBCHAPTER J.

IMPORTANT SAFETY INSTRUCTIONS

READ INSTRUCTIONS — All the safety and operating instructions should be read before the product is operated.

RETAIN INSTRUCTIONS — The safety and operating instructions should be retained for future reference.

HEED WARNINGS — All warnings on the product and in the operating instructions should be adhered to.

FOLLOW INSTRUCTIONS — All operating and use instructions should be followed.

CLEANING — The product should be cleaned only with a polishing cloth or a soft dry cloth. Never clean with furniture wax, benzene, insecticides or other volatile liquids since they may corrode the cabinet.

ATTACHMENTS — Do not use attachments not recommended by the product manufacturer as they may cause hazards.

WATER AND MOISTURE — Do not use this product near water — for example, near a bathtub, wash bowl, kitchen sink, or laundry tub; in a wet basement; or near a swimming pool; and the like.

ACCESSORIES — Do not place this product on an unstable cart, stand, tripod, bracket, or table. The product may fall, causing serious injury to a child or adult, and serious damage to the product. Use only with a cart, stand, tripod, bracket, or table recommended by the manufacturer, or sold with the product. Any mounting of the product should follow the manufacturer's instructions, and should use a mounting accessory recommended by the manufacturer.

CART — A product and cart combination should be moved with care. Quick stops, excessive force, and uneven surfaces may cause the product and cart combination to overturn.



VENTILATION — Slots and openings in the cabinet are provided for ventilation and to ensure reliable operation of the product and to protect it from overheating, and these openings must not be blocked or covered. The openings should never be blocked by placing the product on a bed, sofa, rug, or other similar surface. This product should not be placed in a built-in installation such as a bookcase or rack unless proper ventilation is provided or the manufacturer's instructions have been adhered to.

POWER SOURCES — This product should be operated only from the type of power source indicated on the marking label. If you are not sure of the type of power supply to your home, consult your product dealer or local power company.

LOCATION — The appliance should be installed in a stable location.

NONUSE PERIODS — The power cord of the appliance should be unplugged from the outlet when left un-used for a long period of time.

GROUNDING OR POLARIZATION

- If this product is equipped with a polarized alternating current line plug (a plug having one blade wider than the other), it will fit into the outlet only one way. This is a safety feature. If you are unable to insert the plug fully into the outlet, try reversing the plug. If the plug should still fail to fit, contact your electrician to replace your obsolete outlet. Do not defeat the safety purpose of the polarized plug.
- If this product is equipped with a three-wire grounding type plug, a plug having a third (grounding) pin, it will only fit into a grounding type power outlet. This is a safety feature. If you are unable to insert the plug into the outlet, contact your electrician to replace your obsolete outlet. Do not defeat the safety purpose of the grounding type plug.

POWER-CORD PROTECTION — Power-supply cords should be routed so that they are not likely to be walked on or pinched by items placed upon or against them, paying particular attention to cords at plugs, convenience receptacles, and the point where they exit from the product.

OUTDOOR ANTENNA GROUNDING — If an outside antenna or cable system is connected to the product, be sure the antenna or cable system is grounded so as to provide some protection against voltage surges and built-up static charges. Article 810 of the National Electrical Code, ANSI/NFPA 70, provides information with regard to proper grounding of the mast and supporting structure, grounding of the lead-in wire to an antenna discharge unit, size of grounding conductors, location of antenna-discharge unit, connection to grounding electrodes, and requirements for the grounding electrode. See Figure A.

LIGHTNING — For added protection for this product during a lightning storm, or when it is left unattended and unused for long periods of time, unplug it from the wall outlet and disconnect the antenna or cable system. This will prevent damage to the product due to lightning and power-line surges.

POWER LINES — An outside antenna system should not be located in the vicinity of overhead power lines or other electric light or power circuits, or where it can fall into such power lines or circuits. When installing an outside antenna system, extreme care should be taken to keep from touching such power lines or circuits as contact with them might be fatal.

OVERLOADING — Do not overload wall outlets, extension cords, or integral convenience receptacles as this can result in a risk of fire or electric shock.

OBJECT AND LIQUID ENTRY — Never push objects of any kind into this product through openings as they may touch dangerous voltage points or short-out parts that could result in a fire or electric shock. Never spill liquid of any kind on the product.

SERVICING — Do not attempt to service this product yourself as opening or removing covers may expose you to dangerous voltage or other hazards. Refer all servicing to qualified service personnel.

DAMAGE REQUIRING SERVICE — Unplug this product from the wall outlet and refer servicing to qualified service personnel under the following conditions:

- When the power-supply cord or plug is damaged.
- If liquid has been spilled, or objects have fallen into the product.
- If the product has been exposed to rain or water.
- If the product does not operate normally by following the operating instructions. Adjust only those controls that are covered by the operating instructions as an improper adjustment of other controls may result in damage and will often require extensive work by a qualified technician to restore the product to its normal operation.
- If the product has been dropped or damaged in any way.

REPLACEMENT PARTS — This indicates a need for service.

REPLACEMENT PARTS — When replacement parts are required, be sure the service technician has used replacement parts specified by the manufacturer or have the same characteristics as the original part. Unauthorized substitutions may result in fire, electric shock, or other hazards.

SAFETY CHECK — Upon completion of any service or repairs to this product, ask the service technician to perform safety checks to determine that the product is in proper operating condition.

WALL OR CEILING MOUNTING — The product should not be mounted to a wall or ceiling.

HEAT — The product should be situated away from heat sources such as radiators, heat registers, stoves, or other products (including amplifiers) that produce heat.

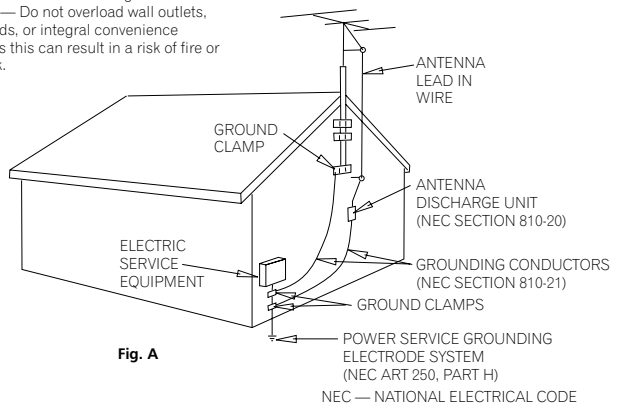

D1-4-2-2_En

This Class B digital apparatus complies with Canadian ICES-003.

Cet appareil numérique de la Classe B est conforme à la norme NMB-003 du Canada.

D8-10-1-3_EF

CAUTION: This product satisfies FCC regulations when shielded cables and connectors are used to connect the unit to other equipment. To prevent electromagnetic interference with electric appliances such as radios and televisions, use shielded cables and connectors for connections.

D8-10-3a_En

Recording equipment and copyright: You may use this product only to reproduce or copy materials for which you own the copyright or have obtained permission to copy from the copyright owner or for which you otherwise have a legal right to reproduce or copy. Unless you own the copyright or have obtained permission from the copyright owner or otherwise have a legal right to reproduce or copy, you may be violating the law, including copyright law, and may be subject to payment of damages and other remedies.

K018US_En

POWER-CORD CAUTION

Handle the power cord by the plug. Do not pull out the plug by tugging the cord and never touch the power cord when your hands are wet as this could cause a short circuit or electric shock. Do not place the unit, a piece of furniture, etc., on the power cord, or pinch the cord. Never make a knot in the cord or tie it with other cords. The power cords should be routed such that they are not likely to be stepped on. A damaged power cord can cause a fire or give you an electrical shock. Check the power cord once in a while. When you find it damaged, ask your nearest PIONEER authorized service center or your dealer for a replacement.

5002_En

CAUTION – PREVENT ELECTRIC SHOCK DO NOT USE THIS (POLARIZED) PLUG WITH AN EXTENSION CORD, RECEPTACLE OR OTHER OUTLET UNLESS THE BLADES CAN BE FULLY INSERTED TO PREVENT BLADE EXPOSURE.

ATTENTION – POUR PREVENIR LES CHOCS ELECTRIQUES NE PAS UTILISER CETTE FICHE POLARISEE AVEC UN PROLONGATEUR UNE PRISE DE COURANT OU UNE AUTRE SORTIE DE COURANT, SAUF SI LES LAMES PEUVENT ETRE INSEREES A FOND SANS EN LAISSER AUCUNE PARTIE A DECOUVERT.

D2-4-4-1_EF

This product incorporates copyright protection technology that is protected by method claims of certain U.S. patents and other intellectual property rights owned by Macrovision Corporation and other rights owners. Use of this copyright protection technology must be authorized by Macrovision Corporation, and is intended for home and other limited viewing uses only unless otherwise authorized by Macrovision Corporation. Reverse engineering or disassembly is prohibited.

NOTE TO CATV SYSTEM INSTALLER

THIS REMINDER IS PROVIDED TO CALL THE CATV SYSTEM INSTALLER'S ATTENTION TO ARTICLE 820-40 OF THE NEC THAT PROVIDES GUIDELINES FOR PROPER GROUNDING AND, IN PARTICULAR, SPECIFIES THAT THE CABLE GROUND SHALL BE CONNECTED TO THE GROUNDING SYSTEM OF THE BUILDING, AS CLOSE TO THE POINT OF CABLE ENTRY AS PRACTICAL.

D1-4-2-8_En

MOISTURE CONDENSATION

DO NOT OPERATE THIS DVD/VCR FOR AT LEAST TWO OR THREE HOURS WHEN MOISTURE IN THE AIR CONDENSES ON THE DVD/VCR.

WHAT IS MOISTURE CONDENSATION?

When cold liquid is poured into a glass, for example, water vapour in the air will condense on the surface of the glass. This is called moisture condensation.

MOISTURE WILL CONDENSE ON THE UNIT IN THE FOLLOWING CASES;

- When you move this DVD/VCR from a cold to a warm place.
- After heating a cold room or under extremely humid conditions.

WHEN YOU EXPERIENCE THE ABOVE CONDITIONS;

Plug the power cord into an AC outlet, set the STANDBY/ON switch to ON and leave the unit at room temperature until moisture condensation disappears. Depending on the surrounding conditions, this may take from two or three hours.

WARNING: Handling the cord on this product or cords associated with accessories sold with the product will expose you to lead, a chemical known to the State of California and other governmental entities to cause cancer and birth defects or other reproductive harm.

Wash hands after handling

D36-P4_En

This product is for general household purposes. Any failure due to use for other than household purposes (such as long-term use for business purposes in a restaurant or use in a car or ship) and which requires repair will be charged for even during the warranty period.

K041_En

DVD/CD Player/Video Cassette Recorder

- **DVD/CD player with Video Cassette Recorder** - Unique space saving design combines a DVD/CD player and a Hi-Fi Video cassette recorder. The DVD disc has much more capacity, but is the same size as the audio CD disc. Picture quality is higher than Super VHS. Audio quality is higher than audio CD. The DVD PLAYER can play back audio CDs.
- **High Quality Picture** - More than 500 lines (VCR mode: 230 lines) of Horizontal Resolution. It exceeds Super VHS (400 lines) or Laser Disc (430 lines) in resolution.

VCR Section

- **Stereo/SAP Reception** - This VCR is designed to receive stereo and second audio program (SAP) broadcasts where available.
- **4 Video Heads** - Provides optimal picture quality for special effects playback.
- **19µm HEAD** - For superior picture quality even in SLP mode, 19micron width technology helps to avoid crosstalk and boost SLP picture quality to near SP levels. With precision technology, ghosts and color beats are virtually eliminated.
- **Hi-Fi Stereo Sound** - With a frequency response of 20 to 20,000 Hz and a dynamic range of better than 90dB, this VCR provides a level of excellence that rivals compact discs.
- **One-touch Timer Recording (OTR)** - Simply by pressing the REC button, the VCR can be programmed for up to 6 hours of recording with an immediate start.

DVD Section

- **Compatible with a wide range of DVD audio outputs**

Digital Audio Jack (Optical or Coaxial):

- When a component with a built-in Dolby Digital decoder is connected, Dolby Digital sound can produce the effect of being in a movie theater or a concert hall.
- Surround standard different from Dolby Digital. This format is already in use in many theaters. By connecting this unit to a DTS decoder or an AV amplifier with a built-in DTS decoder, the DTS audio of DVD discs recorded in this format can be enjoyed. However, audio will not be output from the analog audio output jacks.
- The MPEG audio of DVD discs recorded in this format can be enjoyed.
- The Linear PCM sound of a 48 kHz/16 bit through 96 kHz/24 bit exceeds audio CD sound.
- **Progressive scan** - Progressive scan displays all the horizontal lines of a picture at one time, as a single frame. This unit converts the interlaced (480i) video from DVD into progressive (480p) format for connection to a progressive display. It increases the vertical resolution.
- **Multi-Language** - Since this DVD matches with 124 language-subtitles/-soundtracks, you can enjoy selecting a favorite one. (You can not select the language that is not recorded on the disc.)
- **Multi-Angle** - Pictures of Sports or a Live Concert are recorded with many cameras. When you play such a disc, you can change the angles during playback. (If a Multi-Angle is not recorded on the disc, you can not change the angle.)
- **Repeat Playback** - You can repeat chapter, track, title, sides or material between two selected points.
- **Program/Random Playback (CD)** - You can play back tracks in programmed or random-selected sequences.
- **Zoom** - You can zoom in on the selected subject on the screen during playback.
- **Video Aspect Ratio** - You can change the aspect ratio of the screen for your monitor/television on a suitable disc.
- **Parental Control** - You can limit the playback of scenes or sounds of adult DVD discs which have a parental level rating.

- *  : Manufactured under license from Dolby Laboratories. "Dolby" and the double-D symbol are trademarks of Dolby Laboratories.
- *  : "DTS" and "DTS Digital Out" are registered trademarks of Digital Theater Systems, Inc.
- *  is a trademark of DVD Format/Logo Licensing Corporation.
- * Unauthorized recording of copyrighted television programs, films, video cassettes and other materials may infringe the rights of copyright owners and be contrary to copyright laws.

THIS PRODUCT DOES NOT PROVIDE CLOSED CAPTIONING.

Contents

Features	5	Changing soundtrack language	25
Contents	6	Subtitles	25
Parts and functions	7	Karaoke playback	25
Remote control	8	Changing angles	26
Power source	9	Title selection	26
Basic connections	10	DVD menu	26
Antenna to DVD/VCR connection	10	Repeat playback	26
DVD/VCR to TV connection	10	Program playback (CD)	26
CABLE TV connections	11	Random playback (CD)	27
Playback connections	12	MP3/WMA*/JPEG playback	27
Setting up the VCR section	14	Setting the JPEG Interval	29
Setting the video channel	14	Advanced function of DVD section	30
Setting the language	14	Parental control	30
Auto clock setting	15	Temporary disabling of rating level by DVD disc	30
Manual clock setting	16	Setting language	31
Tuner setting	16	Setting the aspect ratio of TV screen	31
To add/delete channels	16	Setting on screen display	32
Noise elimination	16	Status display of disc	32
Tape playback operation	17	Dynamic Range Control	32
Loading and Unloading a cassette tape	17	Progressive scan	32
Cassette tape playback	17	Language code list	33
Special playback	17	Problems and troubleshooting	34
ZERO RETURN function	18	Video head cleaning	35
Video index search system	18	Screen sizes and disc formats	36
Recording	19	Additional information	36
Recording a TV program	19	Handling discs	36
One-touch Timer Recording (OTR)	20	Storing discs	36
Timer recording	20	Damaged discs	36
Advanced function of VCR section	22	Cleaning the pickup lens	37
Stereo recording and playback	22	Handling video tapes	37
Second Audio Program (SAP)	22	Storing video tapes	37
Duplicating a video tape	22	Moving the DVD/VCR	37
Disc playback operation	23	Hints on installation	37
Disc	23	Specifications	38
Setting setup language	23		
Playback procedure	24		
Special playback	24		
Zooming	24		
Locating desired scene	25		
Marking desired scenes	25		

* **WMA (Windows Media™ Audio) compatibility**
Microsoft, Windows Media, and the Windows logo are trademarks, or registered trademarks of Microsoft Corporation in the United States and/or other countries.

Parts and functions

Front

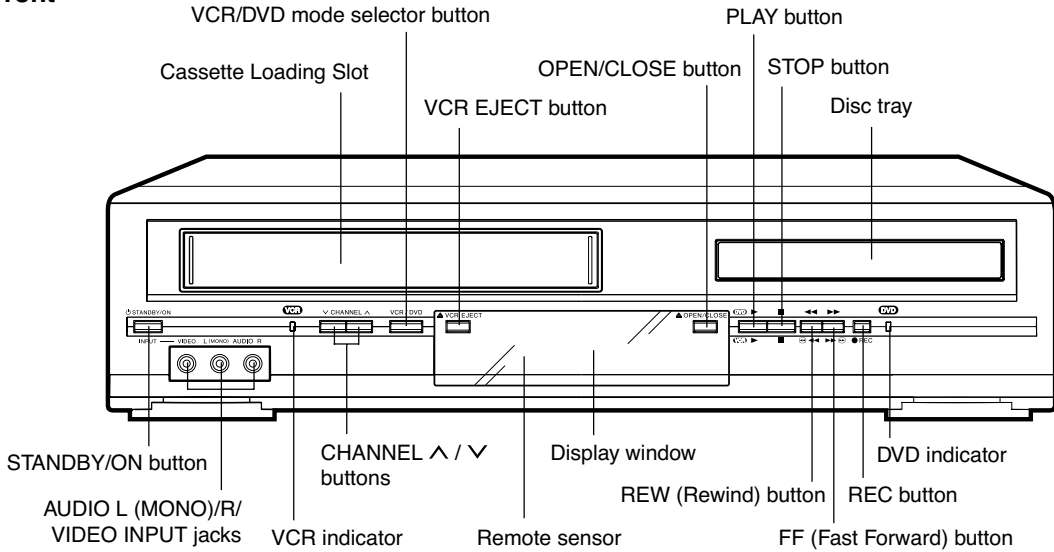

Display window

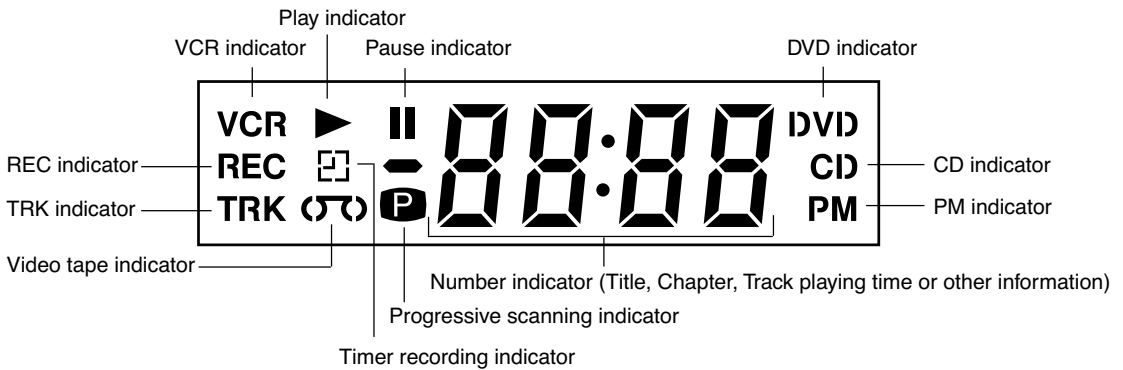

NOTE:

Some discs may be displayed wrong or e.g. chapter number, playback time, etc. may not be displayed.

Rear

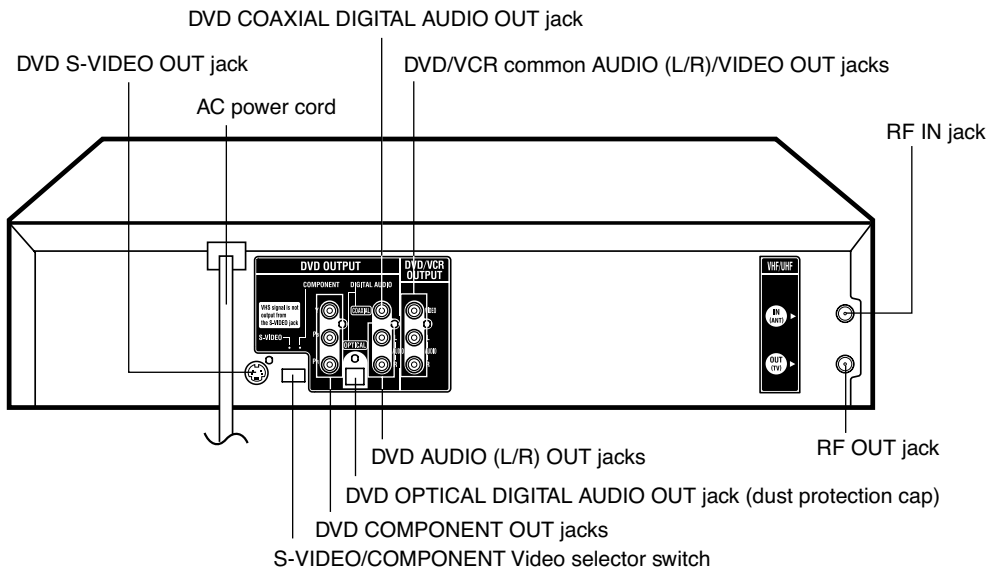

Remote control

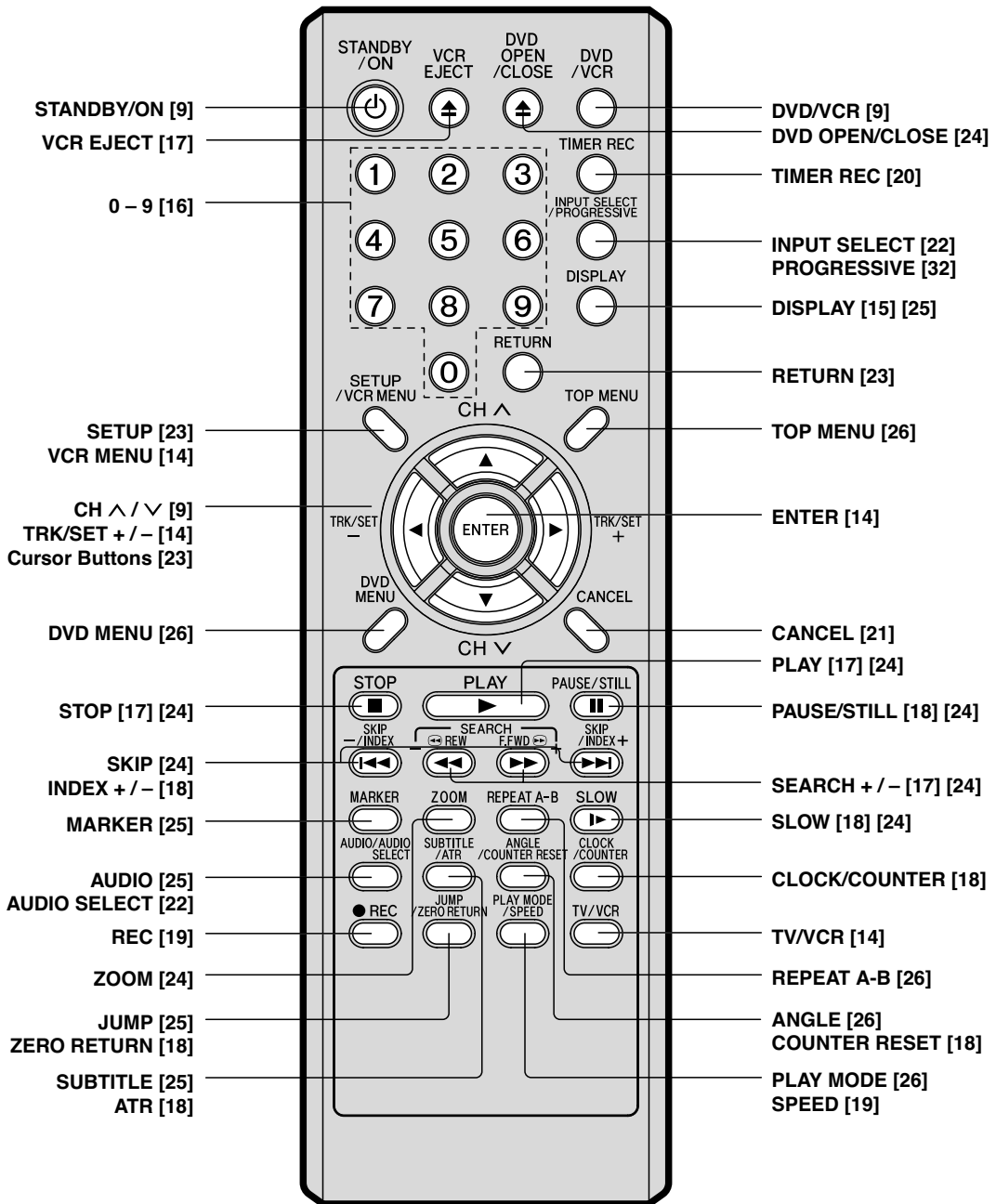

Remote control / Power source

Inserting Batteries

- 1** Open the battery compartment cover on the back of the remote control.

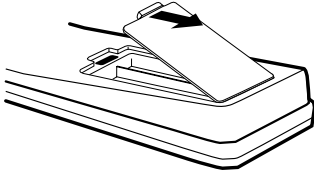

- 2** Insert two AAA/R03 batteries into the battery compartment following the indications (+, -) inside the compartment.

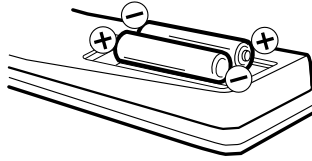

- 3** Close the cover.

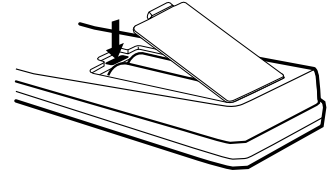

Battery precautions

Incorrect use of batteries can result in hazards such as leakage and bursting. Please observe the following:

- Don't mix new and old batteries together.
- Don't use different kinds of battery together-although they may look similar, different batteries may have different voltages.
- Make sure that the plus and minus ends of each battery match the indications in the battery compartment.
- Remove batteries from equipment that isn't going to be used for a month or more.
- Do not try to recharge batteries not intended to be recharged; they can overheat and rupture. (Follow battery manufacturer's directions.)
- When disposing of used batteries, please comply with governmental regulations or environmental public instruction's rules that apply in your country or area.

Remote control basics

- Press **STANDBY/ON** to turn the DVD/VCR on or off.
- Press **CH ^** or **CH v** to move through the channels one channel at a time.
- The **CH ^/v** and **SET +/-** are also used to navigate on-screen menu system.
- You can directly access specific channels using **Number keys** pad.
- Each press of **DVD/VCR** on the remote control, switches the screen between the VCR screen (VCR mode) and the DVD screen (DVD mode).

Operation

- Aim the remote control at the remote sensor and press control buttons to operate.
- Operate the remote control within 30° angle on either side of the remote sensor, up to a distance of Approx. 5 meters (15 ft.).

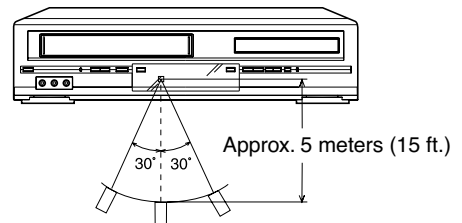

Power source

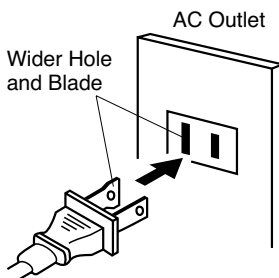

Polarized AC Cord Plug
(One blade is wider than the other.)

TO USE AC POWER SOURCE

Use the AC polarized line cord provided for operation on AC. Insert the AC cord plug into a standard 120V 60Hz polarized AC outlet.

NOTES:

- Never connect the AC line cord plug to other than the specified voltage (120V 60Hz). Use the attached power cord only.
- If the polarized AC cord does not fit into a non-polarized AC outlet, do not attempt to file or cut the blade. It is the user's responsibility to have an electrician replace the obsolete outlet.
- If you cause a static discharge when touching the unit and the unit fails to function, simply unplug the unit from the AC outlet and plug it back in. The unit should return to normal operation.

Basic connections

Before making or changing any rear panel connections, make sure that all components are switched off and unplugged from the wall outlet.

Antenna to DVD/VCR connection

The DVD/VCR must be connected "between" the antenna and the TV. First, disconnect the antenna from the TV and connect it to the DVD/VCR. Then connect the DVD/VCR to the TV. Below are 3 common methods of connecting an antenna system to a DVD/VCR. Find the type of antenna system you are using and follow the connection diagram.

Example 1: Combination VHF/UHF antenna with 75 ohm coaxial cable

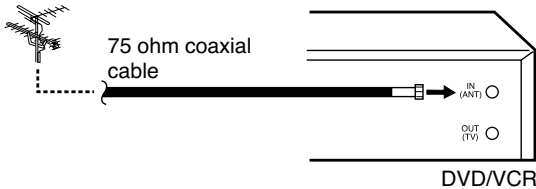

Example 2: Combination VHF/UHF antenna with 300 ohm twin lead (flat) wire

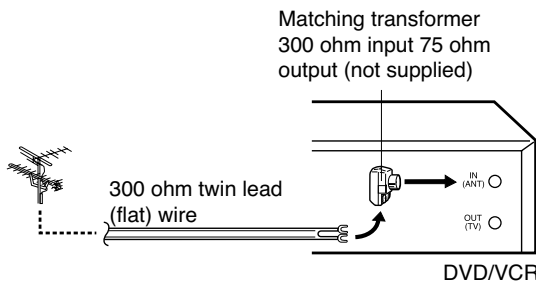

Example 3: Separate VHF and UHF antennas

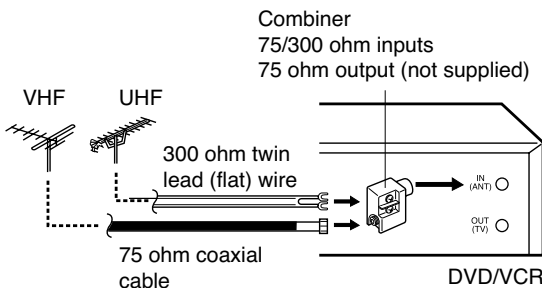

NOTE:

If both VHF and UHF antennas have 300 ohm twin lead (flat) wires, use a combiner having two 300 ohm inputs and one 75 ohm output.

NOTES:

- A clear picture will not be obtained by the main unit unless the antenna signal is good. Connect the antenna to the main unit properly.
- For better quality recording, an indoor antenna or a telescopic antenna is not recommended. The use of an outdoor type antenna is required.
- If you are not sure about the connection, please refer to qualified service personnel.

DVD/VCR to TV connection

After you have connected the antenna to the DVD/VCR, you must connect the DVD/VCR to the TV.

Below are 3 common methods of connecting your DVD/VCR to a TV. Find the type of TV you are using and follow the connection diagram.

This DVD/VCR has a single 75 ohm output for connection to a TV. If your TV has separate VHF and UHF antenna inputs (numbers 2 and 3 below), use a splitter to connect the DVD/VCR to the TV for VHF and UHF reception.

Example 1: TV with single 75 ohm VHF/UHF antenna input

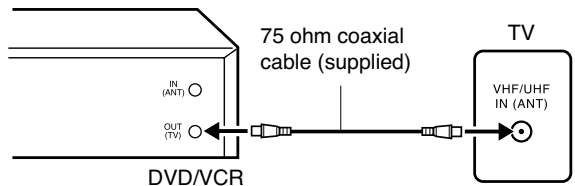

Example 2: TV with 300 ohm UHF and 75 ohm VHF antenna inputs

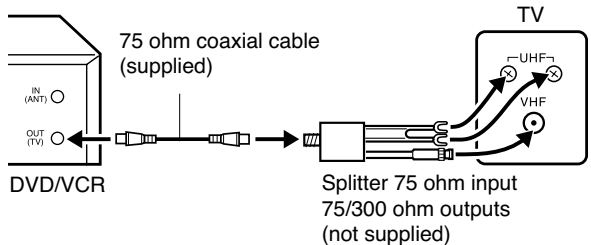

Example 3: TV with 300 ohm UHF and 300 ohm VHF antenna inputs

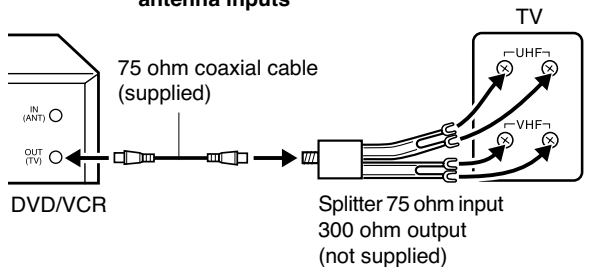

NOTE:

If a VHF or UHF antenna is used, set the TV/CABLE menu option to the "TV" mode.

CABLE TV connections

Many cable companies offer services permitting reception of extra channels including pay or subscription channels. This DVD/VCR has an extended tuning range and can be tuned to most cable channels without using a cable company supplied converter box, except for those channels which are intentionally scrambled. If you subscribe to a special channel which is scrambled, you must have a descrambler box for proper reception.

Example 1:

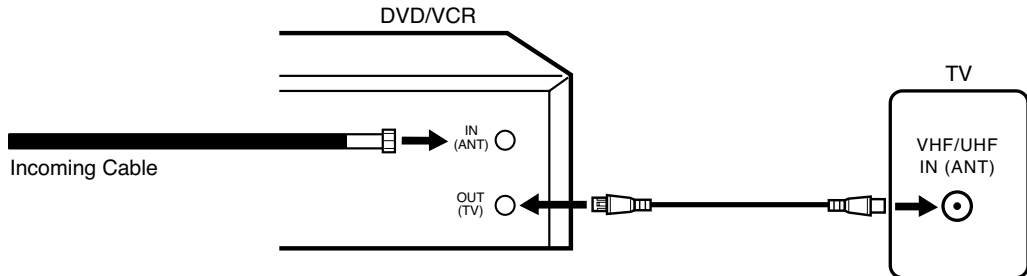

- ALLOWS:**
- * Recording of nonscrambled channels.
 - * Use of the programmable timer.
 - * Recording of one channel while watching another.

Example 2:

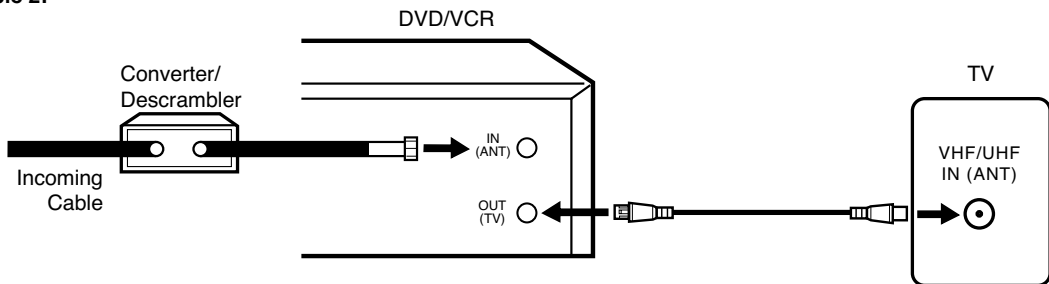

- ALLOWS:**
- * Recording of channels through the converter box (scrambled and unscrambled).
 - * Using the programmable timer to record only the channel selected at the converter box.

- PREVENTS:**
- * Recording one channel while watching another.
 - * Using the DVD/VCR tuner to select channels.

NOTE:

To record from converter/descrambler, DVD/VCR tuner must be tuned to the converter output channel, usually channel 3 or 4.

Example 3:

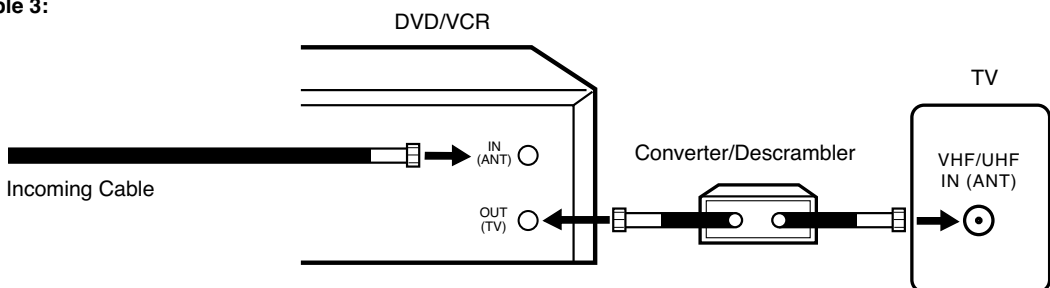

- ALLOWS:**
- * Recording of nonscrambled channels.
 - * Use of the programmable timer.
 - * Recording an unscrambled channel while watching any channel selected at the converter box.

- PREVENTS:** Recording scrambled channels.

NOTE:

If you are playing a tape or using the tuner built into the DVD/VCR, the converter must be set to the video channel output of the DVD/VCR (either 3 or 4).

NOTE: Whenever a Converter/Descrambler box is placed before the DVD/VCR, you must tune the DVD/VCR to the output of the Converter/Descrambler box, usually channel 3 or 4.

Playback connections

The exact arrangement you use to interconnect various video and audio components to the DVD/VCR is dependent on the model and features of each component. Check the Owner's Manual provided with each component for the location of video and audio inputs and outputs.

Connect to a TV with Audio/Video Output

You can enjoy playback by connecting the unit to a TV.

Connect the unit to a TV equipped with audio input (L/R) and video input jacks using the supplied audio/video cable.

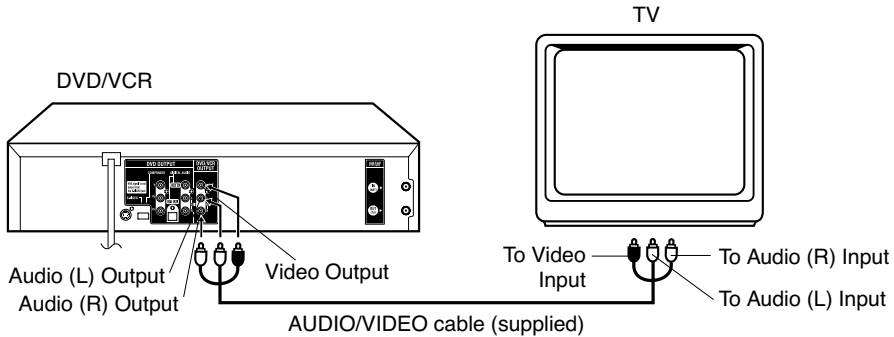

Connect to a TV with S-Video Output (for DVD/CD playback)

If your TV has an S-VIDEO input, you can get higher quality by connecting it with the S-VIDEO output of the unit using the S-video cable instead of connecting the video input of the TV to the VIDEO jack of the unit.

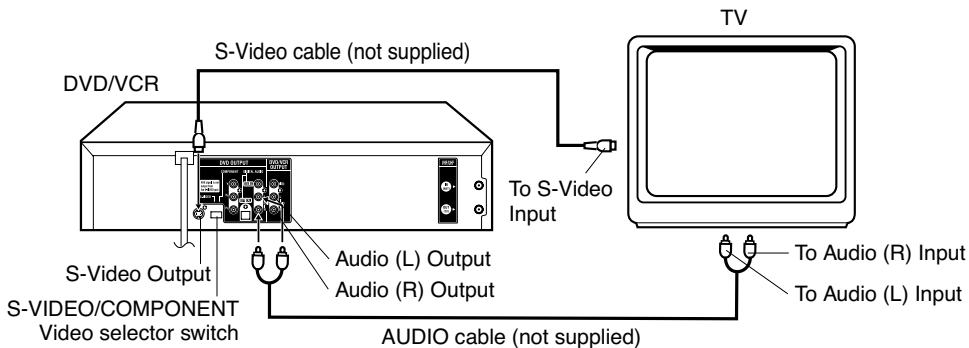

Connect to a TV with Component Video Output (for DVD/CD playback)

You can enjoy high quality picture by connecting the unit's COMPONENT VIDEO OUT jacks to the COMPONENT VIDEO IN jacks of your TV with the COMPONENT video cables (not supplied).

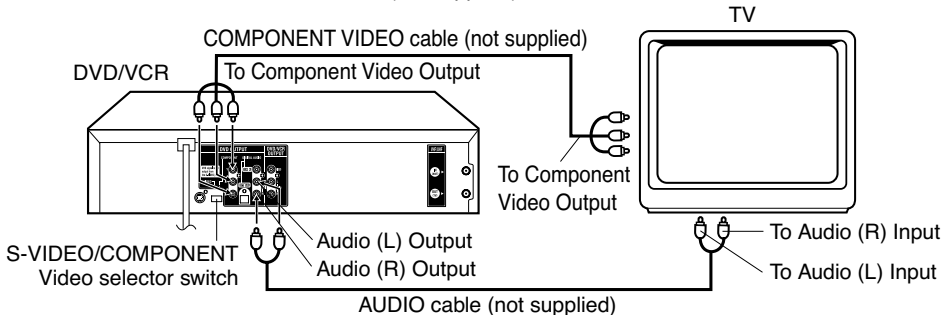

NOTES:

- When you connect to a TV with S-video jack or component jacks, set the S-VIDEO/COMPONENT Video selector switch to the desired position. And also you must select the corresponding video input on your TV.
- When connecting to a TV using the VIDEO or S-VIDEO jack, make sure that the PROGRESSIVE indicator on the display window is not lit. If it is lit, the VIDEO and S-VIDEO outputs do not feed the correct signals and you cannot see any picture. To turn off the PROGRESSIVE indicator, make the Progressive scanning mode inactive (see page 32).
- When the component video input jacks on a TV is of the BNC type, use an adapter to convert a pin jack to a BNC jack (not supplied).

Connect to a Stereo Amplifier with Audio Output

You can enjoy high quality audio by connecting the audio output to your amplifier.

Connect the AUDIO OUT jacks to any line-level inputs (such as AUX, DVD, CD, etc.) of an audio amplifier.

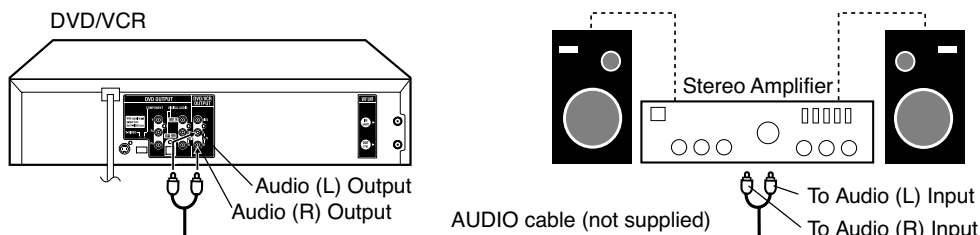

Connect to an AV Amplifier with built-in digital surround (for DVD/CD playback)

If you are using an Amplifier with a built-in digital surround as follows, you can enjoy the various audio systems such as Dolby Digital and DTS by using the Optical or Coaxial Digital Output.

Use this connection to connect an:

- AV amplifier with built-in Dolby Digital decoder
- AV amplifier with built-in DTS decoder

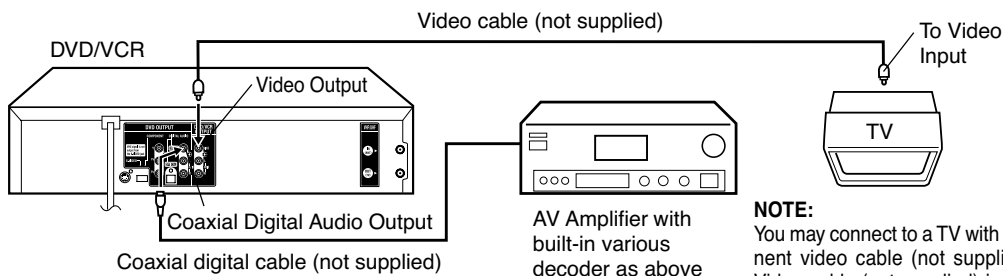

NOTE:

You may connect to a TV with a Component video cable (not supplied) or S-Video cable (not supplied) instead of a video cable (not supplied).

Connecting the optical digital cable

You may connect to an AV Amplifier with an Optical digital cable (not supplied) instead of a Coaxial digital cable.

When you connect the optical digital cable (not supplied), remove the dust protection cap from the rear panel.

When not using the optical digital cable, attach the dust protection cap to protect against dust.

NOTES:

- The DVD OUTPUT jacks (OPTICAL, COAXIAL, AUDIO L/R, S-VIDEO and COMPONENT) are useful only for DVD section.
- The VHS signal is output only from the composite jacks (DVD/VCR OUTPUT) and UHF/VHF OUT.
- When you make the connections above, do not set DOLBY DIGITAL to DOLBY DIGITAL or DTS to ON on the AV Amplifier. If you do, a loud noise will suddenly come out from the speakers, affecting your ears or causing the speakers to be damaged.
- Caution for the **optical** digital audio output connector: Do not connect to an amplifier (with an optical digital input connector) which does not contain a Dolby Digital or DTS decoder. Otherwise, any attempt to play DVDs may cause such a high level of noise that it may be harmful to your ears and damage your speakers.
- DTS audio will be output only from the COAXIAL or OPTICAL output. To hear DTS audio, DTS-Decoder is necessary.
- When playing DTS-encoded CDs, only noise will be heard from the speakers or analogue stereo outputs.
- Some DTS decoders which do not support DVD-DTS interface may not work properly with the unit.

Setting up the VCR section

Setting the video channel

To view playback of a recorded tape or DVD disc, or to watch a program selected by the VCR's channel selector, the TV must be set to channel 3 or 4 (video channel).

When a TV is connected with the 75 ohm coaxial cable only.

- 1 Press and hold **3** or **4** on the remote control for 3 seconds in the standby mode to select CH 3 or 4. The selected channel number will flash on the display for about 4 seconds.
- 2 Turn ON the TV and set to CH 3 or 4 to correspond with the channel selected in step 1.
- 3 Press **STANDBY/ON** to turn on the DVD/VCR.
- 4 Press **DVD/VCR** to select the VCR mode. The VCR indicator on the front panel will light.
- 5 Press **TV/VCR** to select the VCR position. The VCR indicator will appear in the display.
- 6 Select any channel to receive a TV station in your area. The channel number will appear on the screen for about 4 seconds.

For a push-button TV tuner

If CH 3 or 4 corresponding to the video channel cannot be tuned on your TV, proceed as follows: set the VCR 3/4 channel selector and the TV to CH 3 or 4, play back a prerecorded tape and tune the TV to receive a sharp color picture from the video cassette recorder. Refer to your TV owner's manual for details.

NOTES:

- When shipped from factory, the video channel is set to **CH 3**.
- If the unit does not operate properly, or No key operation (by the unit and/or the remote control): Static electricity, etc., may affect the player's operation. Disconnect the AC power cord once, then connect it again.

Setting the language

You can choose from three different languages (English, French and Spanish) for the on-screen displays.

1 Press **VCR MENU**.

The VCR menu screen will appear. Press **SET +** or **-** to select the "SYSTEM SETUP" menu, then press **ENTER**.

If you use the unit for the first time and press **VCR**

MENU, instead of the main menu screen on the right the "SYSTEM SETUP" menu screen in step 2 may appear.

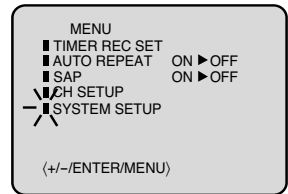

2 Press **SET +** or **-** to select the "LANGUAGE" option, then press **ENTER**.

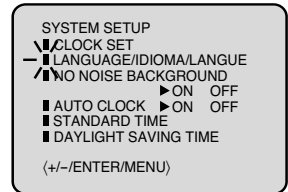

3 Press **SET +** or **-** to select the desired language: English (ENGLISH), Spanish (ESPAÑOL) or French (FRANCAIS), then press **ENTER**.



4 Press **VCR MENU** until the MENU screen is cleared.

NOTES:

- Both the VCR and the DVD have their own menu option (See page 23).
- If no buttons are pressed for more than 60 seconds, the MENU screen will return to normal TV-operation automatically.

Auto clock setting

The Auto Clock function will automatically set the built-in clock (Month, Day, Year and Time) when the DVD/VCR is connected to an Antenna or Cable system and it is turned off. As the DVD/VCR searches for a receivable station in your area and it receives a broadcast signal for Auto Clock, the Auto Clock needs several minutes to set itself.

- 1 Connect the Antenna or Cable system.
 - If you use a cable box, turn it on.
- 2 Plug the AC Power cord to the AC outlet.
- 3 Make sure the DVD/VCR is turned off.
 - If you press **STANDBY/ON**, the Auto Clock set is not effective.
- 4 Wait at least 30 minutes and press **STANDBY/ON**.
- 5 Press **DISPLAY** to check the clock on the screen.
- 6 If the clock is not set, check the Antenna condition. The Auto Clock may not function properly if the reception condition is not good.

Auto clock adjustment

The Auto Clock Adjustment will be performed at 6:00 AM, 12:00 PM and 6:00 PM everyday if you turn off the DVD/VCR.

- If you use a cable box and you want Auto Clock adjustment to be performed, the cable box must be left on.
- The Auto Clock Adjustment is not effective when there is a difference of more than 5 minutes exists between the built-in clock time and the actual time.

To set auto clock to off

When shipped from factory the "AUTO CLOCK" option is set to ON.

But if you do not want Auto Clock set (Adjustment):

- 1 Turn on the DVD/VCR.
- 2 Press **VCR MENU**.
- 3 Press **SET +** or **-** to select the "SYSTEM SETUP" option, then press **ENTER**.
- 4 Press **SET +** or **-** to select the "AUTO CLOCK" option.
- 5 Press **ENTER** to select "OFF".
- 6 Press **VCR MENU** repeatedly to return to the normal screen.
 - When the "AUTO CLOCK" is set to "OFF", the Auto Clock adjustment does not function.
 - Set the clock manually (see page 16).

To set standard time

In the rare event that you live within broadcast range of two stations in two different time zones, the DVD/VCR may recognize the wrong station for the Auto Clock set.

To correct the situation:

- 1 Press **VCR MENU**.
- 2 Press **SET +** or **-** to select the "SYSTEM SETUP" option, then press **ENTER**.
- 3 Press **SET +** or **-** to select the "STANDARD TIME" option, then press **ENTER**.

- 4 Press **SET +** or **-** to select your time zone, then press **ENTER**.

ATLANTIC	:	GMT - 4 hours
		(GMT: Greenwich Mean Time)
EASTERN	:	GMT - 5 hours
CENTRAL	:	GMT - 6 hours
MOUNTAIN	:	GMT - 7 hours
PACIFIC	:	GMT - 8 hours
ALASKA	:	GMT - 9 hours
HAWAII	:	GMT - 10 hours
AUTO	:	AUTO SET

- 5 Press **VCR MENU** twice to return to the normal screen.

NOTE:

To be able to select the standard time, the clock must first be set by "AUTO CLOCK" once. When the clock is not set or you set the clock manually, the time zone setting is not available.

Daylight saving time setting

You can set the Daylight saving time automatically or manually.

- 1 Press **VCR MENU**. Press **SET +** or **-** to select the "SYSTEM SETUP" option, then press **ENTER**.
- 2 Press **SET +** or **-** to select the "DAYLIGHT SAVING TIME" option, then press **ENTER**.
- 3 Press **SET +** or **-** to select one of the options, then press **ENTER**. Press **VCR MENU** until the MENU screen is cleared.
 - ON:** for manual setting (forward one hour)
 - OFF:** for manual setting (back one hour)
 - AUTO:** for automatic setting (read XDS in the signal)

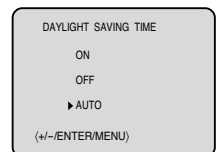
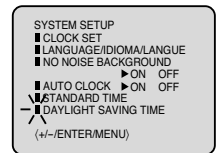
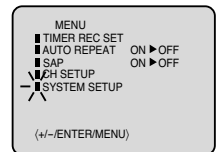

When you want to set the Daylight Saving Time manually, on the first Sunday in April you set to "ON", and on the last Sunday in October you set to "OFF".

NOTES:

- When shipped from factory, the "DAYLIGHT SAVING TIME" option is set to "AUTO" position.
- When the clock is not set, Daylight Saving Time setting is not available.
- When there is no Daylight Saving Time in your area, always select "OFF" position in step 3.

Manual clock setting

You must set the date and time manually for **Timer Recordings, ON/OFF Timer and Daylight Saving Time** if the Auto Clock process did not set them correctly.

Example: Setting the clock to "8:30 AM", 30th (SAT) October, 2004.

- 1 Press **VCR MENU**.
Press **SET +** or **-** to select the "SYSTEM SETUP" option, then press **ENTER**.
- 2 Press **SET +** or **-** to select the "CLOCK SET" option, then press **ENTER**.
- 3 Press **SET +** or **-** to set the month, then press **ENTER**.
- 4 Set the day, year and time as in step 3.

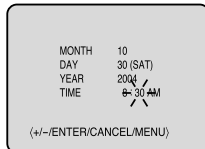
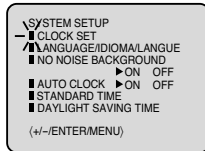
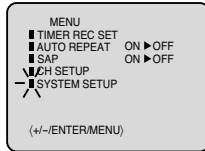

After setting the clock, date and time starts functioning automatically.

NOTES:

- After a power failure or disconnection of the power plug, the time display will be lost. In this case, set the present time again if the Auto Clock did not set correctly.
- To move cursor backward, press **CANCEL**.

Tuner setting

This DVD/VCR is equipped with a channel memory feature which allows channels to skip up or down to the next channel set into memory, skipping over unwanted channels. Before selecting channels, they must be programmed into the DVD/VCR's memory. In addition to normal VHF and UHF channels, this DVD/VCR can receive up to 113 Cable TV channels. To use this DVD/VCR with an antenna, set the TV/CABLE menu option to the TV mode. When shipped from the factory, this menu option is in the CABLE mode.

TV/CABLE selection

- 1 Press **VCR MENU**.
Press **SET +** or **-** to select the "CH SETUP" mode, then press **ENTER**.
 - 2 Press **SET +** or **-** to select the TV/CABLE mode.
 - 3 Press **ENTER** to select the TV or CABLE mode.
The arrow indicates the selected mode.
- | | |
|-------|---------------------|
| TV | - VHF/UHF channels |
| CABLE | - CABLE TV channels |
- 4 Press **VCR MENU** until the MENU screen is cleared.

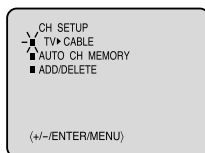
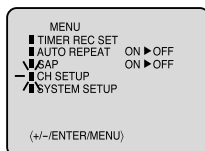

Automatic memory tuning

The VCR can receive a maximum of 181 channels by presetting the channels into memory.

- 1 In the "CH SETUP" menu, press **SET +** or **-** to select "AUTO CH MEMORY", then press **ENTER**.
- 2 The DVD/VCR will begin memorizing all the channels available in your area.

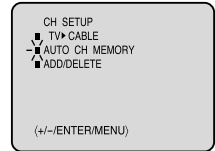

To add/delete channels

You can add the channels you want or delete the channels you do not want manually.

- 1 Press **VCR MENU**.
Press **SET +** or **-** to select the "CH SETUP" mode, then press **ENTER**.
- 2 Press **SET +** or **-** to select the "ADD/DELETE" mode, then press **ENTER**.
- 3 Select the desired channel to be memorized or deleted using **SET +** or **-** button, or using **Number keys**.
- 4 Press **ENTER** to select the "ADD" or "DELETE".
- 5 Press **VCR MENU** until the MENU screen is cleared.

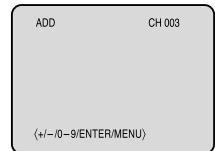
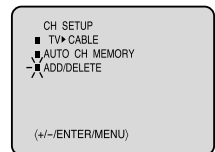

Noise elimination

When you don't want to receive a weak signal broadcast, the Blue back screen can be obtained by selecting the **NO NOISE BACKGROUND "ON"**. When the unit is shipped from the factory, the **NO NOISE BACKGROUND** is set to the "ON".

- 1 In the "SYSTEM SETUP" menu, press **SET +** or **-** to select "NO NOISE BACKGROUND".
- 2 Press **ENTER** to select the "ON" position.
- 3 Press **VCR MENU** until the MENU screen is cleared.

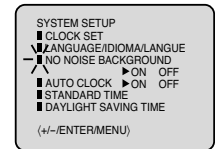

Tape playback operation

Loading and Unloading a cassette tape

Use only video cassette tapes marked **VHS**.

Loading

Push the center of the tape until it is automatically retracted into the unit.

Automatic power on and play

When loading a cassette tape without the erase prevention tab intact, the unit will turn on automatically and playback will start immediately.

Insert the cassette with its labeled side facing you. An inverted video cassette cannot be inserted.

Unloading

To unload a video cassette, press **VCR EJECT**.

Automatic eject

If the unit automatically rewinds the tape to the beginning (AUTO REWIND FEATURE), the tape will be ejected automatically.

To prevent accidental erasure

After recording, break off the erase prevention tab if you do not wish to record over the tape.

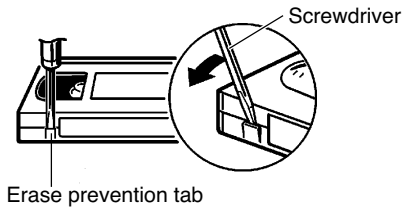

To record again

Cover the hole with adhesive tape. Be careful the tape does not extend past the edges of the video cassette housing.

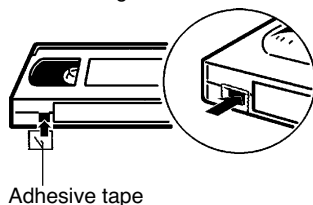

Tape speed and maximum recording time

We do not recommend using video tapes longer than 160 minutes.

Tape Speed	Video cassette tape		
	T-160	T-120	T-60
SP (Standard Play)	2-2/3 hours	2 hours	1 hour
SLP (Super Long Play)	8 hours	6 hours	3 hours

Cassette tape playback

Load a prerecorded tape (When loading a cassette tape without the erase prevention tab, playback will start automatically).

To start playback

Press **PLAY** to begin playback. "▶" will appear on the screen.

To stop playback

Press **STOP** once. The tape will stop, but remain fully loaded and ready to play. "■" will appear on the screen.

NOTES:

- This unit selects the playback tape speed SP, LP or SLP automatically.
- The Cassette tape and DVD disc can be played back simultaneously. If you press **DVD/VCR**, the tape playback and DVD playback alternate with each other on the screen.

To rewind or forward the tape rapidly

Press **REW** or **F.FWD** in the Stop mode. "◀◀" or "▶▶" will appear on the screen.

FORWARD/REVERSE PICTURE SEARCH

If you want to see the tape during **REW** or **FWD** mode, press and hold the **REW** or **F.FWD**. The backward or forward visual search picture will be seen on the screen. Release to return to the **REW** or **FWD** mode.

Special playback

Picture Search

Reverse picture search function

Press **REW** x 1 or x 2 during the playback.

Forward picture search function

Press **F.FWD** x 1 or x 2 during the playback. To return to playback: Press **PLAY**.

SPEED SEARCH TIMES

TAPE SPEED	PICTURE SEARCH SPEED	
	PRESS ONCE	PRESS TWICE
SP (Standard Play)	3 X	5 X
LP (Long Play)	7 X	9 X
SLP (Super Long Play)	9 X	15 X

Still Picture

Press **PAUSE** during playback. To resume normal playback: Press **PLAY**.

Slow Motion

During playback press **SLOW**.

To return to playback: Press **PLAY** or **SLOW**.

Slow tracking and vertical lock adjustment

If noise bars appear in the picture during slow motion, press the **TRK +** or **-** to reduce the noise bars.

If the still picture jitters excessively, press **TRK +** or **-** to stabilize the still picture.

Frame by Frame picture

Press **PAUSE** during playback.

Press **SLOW** one by one: The picture advances frame by frame.

To return to playback: Press **PLAY** or **PAUSE**.

Adjusting tracking condition

Automatic tracking adjustment

Whenever you insert a tape and start playback, automatic tracking starts working and continuously analyzes the signal to enable optimum picture quality during playback.

Manual tracking adjustment

If automatic tracking cannot eliminate noises well during playback, press **TRK +/-** to eliminate the noises.

"MANUAL TR." will appear. Press it briefly for a fine adjustment, or press and hold for a coarse adjustment.

- Press **ATR** to reactivate automatic tracking again. "AUTO TR." will appear.

Repeat playback

The entire video tape will be played until its end. The tape will then automatically rewind to the beginning and the playback will be repeated.

- 1 Press **VCR MENU**. Press **SET +** or **-** to select "AUTO REPEAT".

- 2 Then press **ENTER** to select "ON" or "OFF".
If "ON" is selected, the playback will be repeated endlessly.

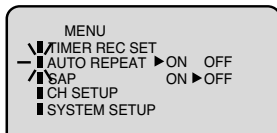

- 3 Press **VCR MENU** until the menu screen is cleared. If you press **DISPLAY**, "⏻" will appear on the screen.

- 4 To start the playback, press **PLAY**.
The playback will be repeated endlessly.

To cancel repeat mode:

Follow the above step 1, then press **ENTER** to select the OFF position. Press **VCR MENU** to return to the TV.

NOTES:

- The audio output is muted during SPEED SEARCH, STILL, FRAME ADVANCE and SLOW MOTION.
- During picture search mode there will be noise bars which are caused by the system.
- The Special Playback will automatically change to playback after approx. 5 minutes to protect the video tape against excessive wear.

ZERO RETURN function

This function makes tape-rewinding stop at the counter 00:00:00 position automatically.

- 1 Press **DISPLAY**.

The counter display shows the tape running time during playback or recording.

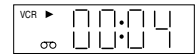

- 2 Press **COUNTER RESET** at the desired tape position. The counter display will be reset to the "00:00:00" position (e.g. the beginning of recording).

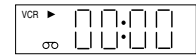

- 3 Press **STOP** when playback or recording is finished. Press **ZERO RETURN**.

The tape will be rewound or fast forwarded and automatically stop at the "00:00:00" position.

The CLOCK/COUNTER-button

Press **CLOCK/COUNTER**. The clock and tape counter alternate with each other in the display.

NOTES:

- If you rewind the tape beyond "00:00:00", a minus sign ("-") will be displayed in front of the time.
- When you load a tape, the counter will reset to "00:00:00".
- The counter does not function on nonrecorded (blank) sections of the tape. When you rewind, fast forward or play tapes through blank sections, the counter stops.

Video index search system

This function enables you to locate the beginning of any recording made on the VCR.

Recording an INDEX MARK

The Index Search function automatically records an INDEX mark on the tape whenever a recording is initiated.

Index Search

Press **INDEX** **▶▶** or **◀◀** during stop or play mode.

For Succeeding programs: Press **INDEX** **▶▶**.

For Preceding programs: Press **INDEX** **◀◀**.

(Additional press increases the INDEX NO. up to 9.)

When the **INDEX** **▶▶** or **◀◀** is pressed, the unit starts searching the INDEX NO. selected and finds the portion, then playback starts automatically.

To stop the Index Search, press **STOP**.

NOTES:

- When you record an INDEX mark at the very beginning of the tape, the mark may not be found.
- During INDEX search, the tape may stop and begin to play at a slightly different location.
- INDEX may not function properly with old or worn out video tapes.
- INDEX marks may not be found if it is extremely close to the point where the search began.
- In recording, if you stop recording temporarily, the INDEX mark is not recorded on the tape.

Recording a TV program

Recording and viewing the same TV program.

- 1 Load a cassette tape with the erase prevention tab intact. The unit will automatically turn on.
- 2 Press **SPEED** to select the desired tape speed SP or SLP. The tape counter and SP or SLP will appear on the screen for about 4 seconds.
- 3 Set the TV/CABLE option to the appropriate position (See page 16).
- 4 Press **Number keys** or **CH** \wedge / \vee to select the channel to be recorded.
 - 1-9 Press **0** twice and then **1-9** as required. Example: To select 2, Press "002".
 - 10-12 Press **0** first and then the remaining 2 digits in order from left to right. Example: Press **012** for "12".
 - 13-99 Press 2 digits in order. Example: Press **22** for "22".
 - 100-125 Press the 3 digits in order. Example: Press **110** for "110".

VHF/UHF/CABLE CHANNELS

TV	CABLE
VHF 2-13	VHF 2-13
UHF 14-69	STD/HRC/IRC 14-36 (A) (W) 37-59 (AA) (WW) 60-85 (AAA) (ZZZ) 86-94 (86) (94) 95-99 (A-5) (A-1) 100-125 (100)(125) 01 (5A)

- 5 Press **REC**. "●" will appear on the screen for about 4 seconds and "REC" will appear on the display.

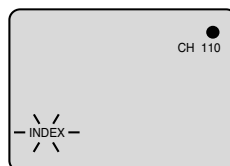

NOTES:

- If the erase prevention tab is removed, the tape will eject when **REC** is pressed for recording.
- If you wish to watch the DVD playback during the normal recording on VCR, press **DVD/VCR** to change to DVD mode and perform the DVD playback (see page 24).
- You can not record disc material in DVD, Audio CD, etc. onto a video tape with this DVD/VCR.

To stop recording

Press **STOP** to stop recording. "■" will appear on screen for about 4 seconds.

To stop recording temporarily

Press **PAUSE/STILL** to avoid recording unwanted material. "●●" will appear on screen for about 4 seconds. Press again to continue the recording.

NOTES:

- The pause function will be released after 5 minutes to prevent damage to the tape or the VCR. The VCR will change to the STOP mode.
- You can select a recording channel in the recording pause mode.

Recording one program while watching another

While the VCR is recording, press **TV/VCR** to select the TV position. The "VCR" will go off and recording will continue. Select the TV channel you want to watch by using the TV channel selector.

NOTE:

Some CABLE hookups do not permit viewing one channel while recording another. See page 11.

To Display VCR operation Status

Press **DISPLAY**. The clock, day of the week and more information will be indicated.

While watching TV

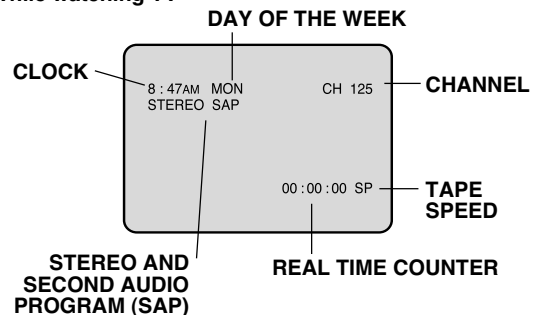

While operating a tape

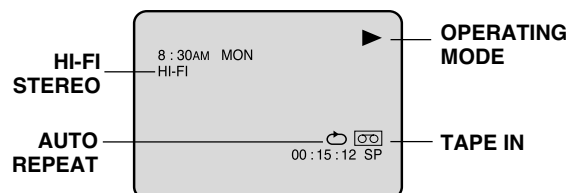

To cancel the display: Press **DISPLAY** until all indicators disappear.

Auto Rewind feature

This VCR will automatically rewind the tape when the tape has ended (except during OTR and TIMER REC). It will also eject the tape.

One-touch Timer Recording (OTR)

The One-touch Timer Recording feature provides a simple and convenient way to make a timed recording.

Example: One-touch Timer Recording for 30 minutes.

- 1 Load a cassette tape with the erase prevention tab intact.
The unit will automatically turn on.
- 2 Press **SPEED** to select the desired tape speed SP or SLP.
The tape counter and SP or SLP will appear on the screen for about 4 seconds.
- 3 Set the TV/CABLE option to the appropriate position.
- 4 Press **Number keys** or **CH** \wedge/\vee to select the channel to be recorded.
- 5 Press **REC**. Press the button again to stop recording after 30 minutes. Each additional press of **REC** will increase recording time as shown in the chart below, up to a maximum of 6 hours. The OTR and recording time will appear on the screen for about 4 seconds. And, REC will keep blinking in the display.

Press	Recording time	Press	Recording time
once	NORMAL REC	6 times	3:00
twice	0:30	7 times	4:00
3 times	1:00	8 times	5:00
4 times	1:30	9 times	6:00
5 times	2:00	10 times	NORMAL REC

To cancel OTR

Press **STOP** or turn off the power.

"■" will appear on screen for about 4 seconds.

NOTE:

If you wish to watch the DVD playback during the OTR, press **DVD/VCR** to change to DVD mode and perform the DVD playback (see page 24).

Timer recording

Timer recording can be programmed on-screen with the remote control. The built-in timer allows automatic unattended recording of up to 8 programs within 1 month.

Example: Program a timer recording for the 26th day, channel 125 (CABLE), 11:00 - 11:30 PM on timer program number 1 (Tape speed: SLP).

- 1 Press **VCR MENU**. Select the "TIMER REC SET" option, then press **ENTER**.
- 2 Press **SET +** or **-** to select one of the program line, then press **ENTER**.
- 3 Press **SET +** or **-** to select the date, then press **ENTER**.
- 4 Set the **start time, end time, channel and tape speed** as in step 3.

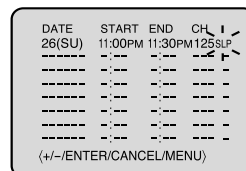
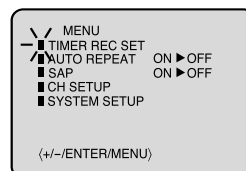

NOTES:

- Press **CANCEL** to move cursor backward for correction.
- To record from external source set the channel to "L". "L" will appear next to CH 125 (or 69).

- 5 To enter other programs, repeat step 2 through 4.
• To return to the normal screen, press **VCR MENU** twice.
- 6 Press **TIMER REC**. The clock symbol (⌚) will appear on the display and the VCR stands by for recording. At the same time, VCR mode will change to DVD mode automatically. You can use DVD even if the VCR is in the Timer recording mode.

If you do not use the DVD, turn the power off.
The timer recording will start at 20 seconds before the time you predetermined.

If you do not use the DVD, turn the power off.
The timer recording will start at 20 seconds before the time you predetermined.

NOTES:

- If the clock symbol (⌚) does not appear on the display in spite of the pressing of **TIMER REC**, the cassette may not have been loaded yet. (see page 17)
- If the cassette is ejected in spite of the pressing of **TIMER REC**, the erase prevention tab of the cassette may have been removed. (see page 17)

NOTES:

- If the clock symbol (⌚) blinks when the timer recording ended, the TV program has not been completely recorded because of an insufficient tape supply. Press **TIMER REC** to cancel the timer program or press **VCR EJECT** to remove the cassette tape.
- During timer recording standby mode, the VCR mode cannot be selected. To use the VCR, press **TIMER REC** at first, then press **DVD/VCR** to change to VCR mode. After you use the VCR, press **TIMER REC** again to put the VCR into timer recording standby mode.
- If you press **TIMER REC** during timer recording, the recording operation will be interrupted. If you press **TIMER REC** again within the programmed time, the recording operation will start again.
- After a power failure or disconnection of the power plug, all programmed recording settings and time display will be lost upon resumption of power. In this case, reset the clock (see page 16) and reprogram any timer recordings.

Timer recording special case

Weekly (e.g. WKL-TU: each Tuesday) or daily (e.g. MO-SA: Monday to Saturday) Timer recording.

Follow the procedure of timer recording on the previous page. At picture 3 press **SET +** or **-** repeatedly until the desired setting appears. Then press **ENTER**.

When you press **SET -** repeatedly, the indicator at DATE will change as follows, in this case the day is Friday.

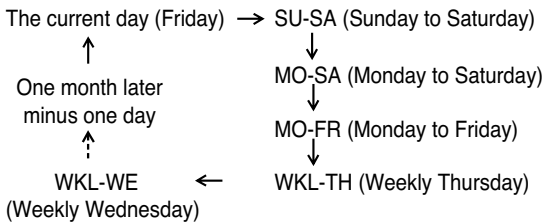

DATE	START	END	CH
WKL-WE	-:-	-:-	-:-
-:-	-:-	-:-	-:-
-:-	-:-	-:-	-:-
-:-	-:-	-:-	-:-
-:-	-:-	-:-	-:-
-:-	-:-	-:-	-:-
-:-	-:-	-:-	-:-
-:-	-:-	-:-	-:-
-:-	-:-	-:-	-:-
-:-	-:-	-:-	-:-

(+/-/ENTER/CANCEL/MENU)

In case Timer programs-overlap

- Do not overlap timer programs as portions of the conflicting programs will be lost. The first recording time has priority over the next recording time as shown in the diagram below.

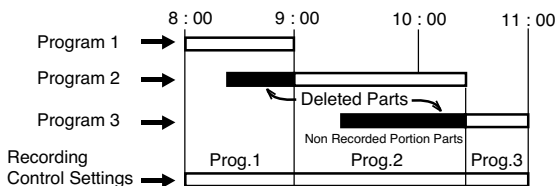

NOTES:

- The daily/weekly recording can be made continuously until the recording is canceled or the tape reaches the end.
- During timer recording the automatic rewinding mechanism does not function.

Confirmation / Cancellation of the Timer recording

1 If the Timer has been activated, press **TIMER REC** to deactivate the Timer. The clock symbol(⌚) will disappear. Then press **DVD/VCR** to change to VCR mode.

2 To confirm Timer program:

At picture 1 on the previous page select the "TIMER REC SET" option and press **ENTER**.

Then the timer program list as right will appear on the screen.

DATE	START	END	CH
26(SU)	11:00PM	11:30PM	125SLP
-:-	-:-	-:-	-:-
-:-	-:-	-:-	-:-
-:-	-:-	-:-	-:-
-:-	-:-	-:-	-:-
-:-	-:-	-:-	-:-
-:-	-:-	-:-	-:-
-:-	-:-	-:-	-:-
-:-	-:-	-:-	-:-
-:-	-:-	-:-	-:-

(+/-/ENTER/CANCEL/MENU)

3 To cancel Timer program:

Press **SET +** or **-** to select the unnecessary program, then press **CANCEL** to cancel the program.

DATE	START	END	CH
-:-	-:-	-:-	-:-
-:-	-:-	-:-	-:-
-:-	-:-	-:-	-:-
-:-	-:-	-:-	-:-
-:-	-:-	-:-	-:-
-:-	-:-	-:-	-:-
-:-	-:-	-:-	-:-
-:-	-:-	-:-	-:-
-:-	-:-	-:-	-:-
-:-	-:-	-:-	-:-

(+/-/ENTER/CANCEL/MENU)

4 Press **VCR MENU** repeatedly until the TV-picture appears.

NOTES:

- If there are other timer record programs remaining, **TIMER REC** must be pressed to reactivate the timer, otherwise the remaining timer record programs will be ignored.
- You cannot confirm the Timer program during timer recording operation.
- You can also correct the programmed setting in program confirm mode. At step 2 above, press **ENTER** to enter the program input mode. Then press **ENTER** repeatedly until the item you wish to correct blinks. Then correct the data with **SET +** or **-**. Then press **VCR MENU** repeatedly until the TV-picture appears.

DATE	START	END	CH
26(SU)	11:00PM	11:30PM	125 SLP
-:-	-:-	-:-	-:-
-:-	-:-	-:-	-:-
-:-	-:-	-:-	-:-
-:-	-:-	-:-	-:-
-:-	-:-	-:-	-:-
-:-	-:-	-:-	-:-
-:-	-:-	-:-	-:-
-:-	-:-	-:-	-:-
-:-	-:-	-:-	-:-

(+/-/ENTER/CANCEL/MENU)

Advanced function of VCR section

Stereo recording and playback

The VHS Hi-Fi audio system permits high fidelity recording of MTS STEREO TV broadcasts.

When a MTS STEREO broadcast is received, the word STEREO will appear on the screen and the program can be viewed or recorded in stereo.



The Hi-Fi STEREO recording procedure is the same as for normal recordings.

NOTE:

When using a CABLE system, stereo TV programs may be transmitted over a mono cable channel. In this case the word "STEREO" will not appear and the sound will be in mono.

Output selection

When viewing an MTS STEREO TV program, or playing a prerecorded VHS Hi-Fi STEREO videotape, press **AUDIO SELECT** to select how the audio will be heard through the speakers. Normally set to the Hi-Fi STEREO position, this button can be set to the MONO position if the stereo broadcast or videotape audio is of poor quality. The "R" and "L" positions allow the audio from the Right or Left Hi-Fi channel to be heard over both TV speakers. This button has no effect when viewing a MONO videotape or TV program. Each time when you press the button, output selection display appears on the screen for several seconds. Refer to the chart below.

OUTPUT SELECTION	SOUND HEARD ON BOTH SPEAKERS
STEREO	STEREO
L ch	LEFT CHANNEL AUDIO
R ch	RIGHT CHANNEL AUDIO
MONO	MONO

Second Audio Program (SAP)

Your VCR is fitted with a SAP broadcast system which enables you to switch to a second audio program when viewing a selected channel.

This function applies only when the program is broadcast in multi-languages through the SAP broadcast system.

- 1 Press **VCR MENU**. Then press **SET + or -** to select "SAP".
- 2 Then press **ENTER** to select "ON".
- 3 Then press **VCR MENU** until the menu screen is cleared.

Listening to SAP

When the VCR is turned on or a channel selection is made, make certain the letters "SAP" appears on the screen. This means that the "Second Audio Program" broadcasting is available.

NOTES:

- When playing back a tape that is not recorded in Hi-Fi stereo mode, the audio will automatically be monaural.
- When listening to a VHS Hi-Fi video tape or MTS broadcast through the VHF/UHF jack (Audio/Video cord not connected), the sound will be monaural.

Duplicating a video tape

If you connect the VCR to another VCR or camcorder, you can duplicate a previously recorded tape.

Make all connections before turning on the power.

- 1 Load a blank cassette tape with the erase prevention tab intact into the recording VCR. Load a previously recorded tape into the playback VCR or CAMCORDER.
- 2 Press **SPEED** to select the desired tape speed SP or SLP. It is recommended that you set the Speed to the SP mode on the recording VCR for best results.
- 3 Press **INPUT SELECT** to select AUDIO/VIDEO input position. "L" will appear in the display.
- 4 Press **REC** on the recording VCR, then press **PAUSE/STILL**.
- 5 Press the **PLAY** button on the playback VCR or CAMCORDER, then press the **PAUSE/STILL** button.
- 6 Release the recording pause and the playback still simultaneously to begin the duplicating process.

Connection with second Video recorder

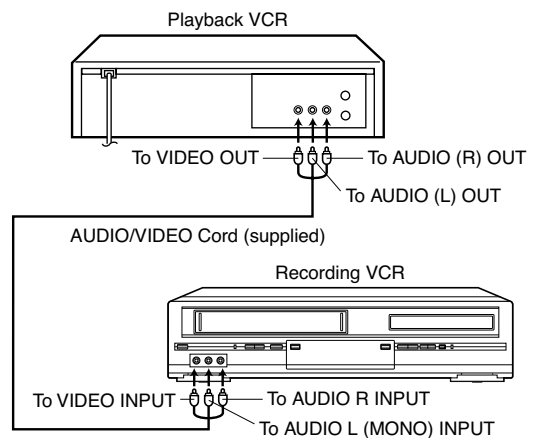

Connection with Video camera

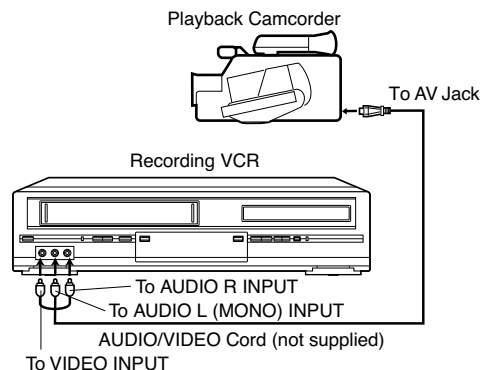

For duplicating a previously recorded tape from a camcorder, follow the camcorder manufacturer's instructions. A typical camcorder dubbing hookup is shown above.

NOTE:

A copy-protected tape cannot be duplicated.

Disc playback operation

Disc

This unit applies to DVD discs from Region 1 or Region ALL. The loaded Disc (DVD, Audio-CD and CD-R/RW (MP3/WMA/JPEG-CD)) will be recognized automatically.

The suitable Disc-formats are: DVD, DVD-R/RW of DVD Video format (finalized), Audio-CD, CD-R/RW of CD-DA, MP3, WMA and JPEG format.

Some discs may not be playable due to different recording formats or physical condition of the disc at the time of recording or playback.

Do not play DVD-ROM, DVD-RAM, DVD+R/RW, DVD-Audio, CD-ROM, CDV, Video-CD, CD-G or Photo CD to prevent accidental erasure of prerecorded material.

This unit cannot record disc material in DVD, Audio CD etc. onto a video tape.

If you press **REC** during DVD playback, a symbol mark “” will appear on the screen for approx.4 seconds.

Title

When two or more movies are recorded on a disc, the disc is divided into two or more sections. Each section is called a “TITLE”.

Chapter

The titles can be subdivided into many sections. Each section is called a “CHAPTER”.

Track

An Audio CD can contain several items. These are assigned to the tracks.

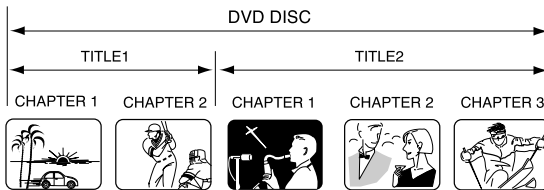

Setting setup language

The setup language can be selected.

1 Press **DVD/VCR** to select the DVD mode. (The DVD indicator will light)

“No Disc” will appear on the screen. (If a DVD disc has already loaded, the playback will start automatically.)

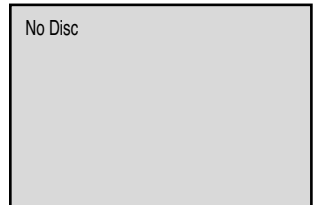

2 Press **SETUP** in the stop mode. The SETUP MENU of DVD will appear on the screen.

Then press **▶** to select “Other”.

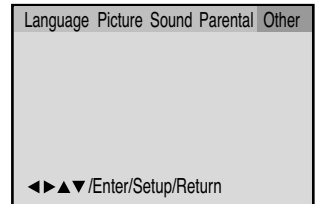

3 Press **▼** or **ENTER** to select “OSD Language”.

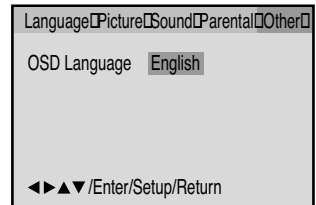



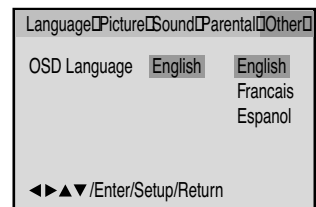



4 Press **▶** or **ENTER** and then press **▲** or **▼** to select desired language (e.g. English), then press **ENTER**.



5 To make the SETUP screen disappear, press **SETUP** (or **RETURN**).

If the DVD/VCR does not operate properly: Static electricity, etc., may affect the player's operation. Disconnect the AC power cord once, then connect it again.

Playback procedure

- 1 Press **DVD OPEN/CLOSE**.
The disc tray will open.
- 2 Place a disc onto the tray.
Hold the disc, position it with the printed label side up, align it with the guides, and place it in its proper position.
- 3 Press **PLAY** or **DVD OPEN/CLOSE**.
The disc tray closes automatically.
On the screen,  changes to "Reading" and then playback will commence.
 - A menu screen may appear on the TV screen, if the disc has a menu feature. In this case, press , , ,  or **ENTER** to operate a menu feature.
- 4 Press **STOP** to end playback.
 - The DVD/VCR memorizes the stopped point, depending on the disc.  appears on the screen. Press **PLAY** to resume playback (from the scene point).
 - If you press **STOP** again ( appears on the screen) or unload the disc, the DVD/VCR will clear the stopped point.
- 5 Then press **DVD OPEN/CLOSE**.
The disc tray opens.
Remove the disc and press **STANDBY/ON**.
The disc tray closes automatically and DVD/VCR turns off.

NOTES:





- If a non-compatible disc is loaded, "Incorrect Disc", "Region Code Error" or "Parental Error" will appear on the TV screen according to the type of loaded disc. In this case, check your disc again (See pages 23 and 30).
- Some discs may take a minute or so to start playback.
- A "Prohibition" symbol  may appear at the upper left of the screen. This symbol means either the feature you tried is not available on the disc, or the DVD/VCR can not access the feature at this time. This does not indicate a problem with the DVD/VCR.
- When you set a single-faced disc label downwards (ie. the wrong way up) and press **PLAY** or **DVD OPEN/CLOSE**, "Reading" will appear and remain on the screen for approx. 40 seconds and then it will change to "Incorrect Disc".
- Some playback operations of DVDs may be intentionally fixed by software producers. Since this DVD/VCR plays DVDs according to the disc contents the software producers designed, some playback features may not be available. Also refer to the instructions supplied with the DVDs.
- When playing DTS-encoded Audio CDs, excessive noise will be heard from the analog stereo outputs. To avoid possible damage to the audio system, the consumer should take proper precautions when the analog stereo outputs of the DVD/VCR are connected to an amplification system.
- This DVD/VCR features a screen saver function. If the unit is stopped and no button is pressed for around five minutes, the screen saver starts.

Special playback

There may be a slight delay between pressing the button and the function activation.

Fast Forward Playback





Press **F.FWD** during normal playback.

Each press of **F.FWD** will increase the speed of the search  (x2),  (x4),  (x8),  (x20).

- To resume normal playback, press **PLAY**.

Review Playback

Press **REW** during normal playback.

Each press of **REW** will increase the speed of the search  (x2),  (x4),  (x8),  (x20).

- To resume normal playback, press **PLAY**.

Still Playback

Press **PAUSE/STILL** during normal playback.

To resume normal playback, press **PLAY**.

Frame Advance

Press **PAUSE/STILL** during still playback.

One frame is advanced each time you press **PAUSE/STILL**.

To resume normal playback, press **PLAY**.



Slow-motion Playback

Press **SLOW** during normal playback or still playback.

Each press of **SLOW** will change the speed of the slow x1/2, x1/4, x1/6, x1/7.

- To resume normal playback, press **PLAY**.
- To resume the still playback, press **PAUSE/STILL**.

Locating a chapter or track

Press **SKIP**  Forward or **SKIP**  Reverse during playback to locate a chapter that you want to watch.

Each time you press the button, a chapter or track is skipped.

NOTES:



- The unit is capable of holding a still video image or On screen display image on your television screen indefinitely. If you leave the still video image or On screen display image displayed on your TV for an extended period of time, you risk permanent damage to your television screen. Projection televisions are very susceptible.
- Fast forward and review playback does not work with a MP3/WMA/JPEG-CD.
- Frame advance and slow motion does not work with a CD.

Zooming

This unit will allow you to zoom in on the frame image. You can then make selections by switching the position of the frame.

- 1 Press **ZOOM** during playback.

The center part of the image will be zoomed in.

Each press of **ZOOM** will change the ZOOM  1 (x 1.3),  2 (x 1.5) and  3 (x 2.0).

- 2 Press  /  or  /  to view a different part of the frame.

You may move the frame from the center position to UP, DOWN, LEFT or RIGHT direction.

- 3 In the zoom mode press **ZOOM** repeatedly to return to a 1:1 view ( Off).

NOTE:

You can use the Pause, Slow, Search or Skip feature in the zoom mode.

Locating desired scene

Use the title, chapter and time recorded on the disc to locate the desired point to playback.

To check the title, chapter and time, press **DISPLAY**. (see page 32)

- 1 Press **JUMP** during playback or stop mode.
- 2 Press **▲** or **▼** to select the "Time", "Title" or "Chapter".
- 3 Press **Number keys** to change the number.
 - If you input a wrong number, press **CANCEL**.
 - Refer to the package supplied with the disc to check the numbers.
- 4 Press **ENTER**. Playback starts.
 - When you change the title, playback starts from Chapter 1 of the selected title.
 - Some discs may not work in the above operation.

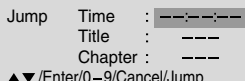

Jump Time : ----
Title : ----
Chapter : ----
▲▼/Enter/0-9/Cancel/Jump

Marking desired scenes

The unit stores the points that you want to watch again up to 3 points. You can resume playback from each scene.

Marking the Scenes

- 1 Press **MARKER** during playback.
- 2 Select the blank Marker using **▲/▼**. Then press **ENTER** at the desired scene.
 - Repeat this procedure to set the other 2 scenes.
- 3 Press **MARKER** to remove this display.

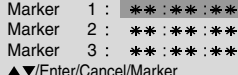

Marker 1 : *:*:*:*
Marker 2 : *:*:*:*
Marker 3 : *:*:*:*
▲▼/Enter/Cancel/Marker

Returning to the Scenes

- 1 Press **MARKER** during playback or stop mode.
- 2 Press **▲/▼** to select the Marker 1-3.
- 3 Press **ENTER**. Playback starts from the marked scene.

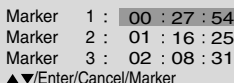

Marker 1 : 00 : 27 : 54
Marker 2 : 01 : 16 : 25
Marker 3 : 02 : 08 : 31
▲▼/Enter/Cancel/Marker

To Cancel the Mark

- 1 Press **MARKER**.
- 2 Press **▲/▼** to select the Marker 1-3.
- 3 Press **CANCEL**. To remove this display, press **MARKER**.

NOTES:

- Some discs may not work with the marking operation.
- The marking is canceled when you open the disc tray or turn the power off.
- Some subtitles recorded around the marker may fail to appear.

Changing soundtrack language

You can select the language when you play a multilingual disc.

- 1 Press **AUDIO** during playback. The current soundtrack language will appear.
- 2 Press **AUDIO** repeatedly until the desired language is selected. The on-screen display will disappear after a few seconds.

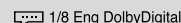

1/8 Eng DolbyDigital

Subtitles

Turning the Subtitles On and Off

When playing back a disc recorded with subtitles, you can turn the subtitles on or off.

Press **SUBTITLE** during playback until "Off" appears.



Off

Changing the subtitle language

You can select the language when playing back a disc recorded with multi-lingual subtitles.

Press **SUBTITLE** repeatedly during playback until your desired language appears. The on-screen display will disappear after a few seconds.



1/32 Eng

NOTES:

- If the desired language is not heard after pressing the button several times, the language is not recorded on the disc.
- Changing soundtrack or subtitle language is cancelled when you open the disc tray. The initial default language or available language will be heard and seen if the disc is played back again.
- Depending on the DVD you may be unable to turn on, turn off, or change the subtitles, even if they are recorded on the disc. While playing the DVD, the subtitle may change while opening or closing the disc tray, or while changing the title.
- In some cases, the subtitle language is not changed to the selected one immediately.

Karaoke playback

When playing back a DVD KARAOKE disc, you can turn the vocal on or off.

- 1 Press **AUDIO** during DVD KARAOKE disc playback.
- 2 Press **◀** or **▶** to select "On" or "Off".
 - On:** The primary vocal is output when it is recorded on the disc.
 - Off:** The primary vocal is not output.

NOTES:

- The vocal output feature is used during playback of Dolby Digital (multi-channel) recorded DVD KARAOKE discs. This feature allows you to turn off vocal audio tracks, or restore them for background accompaniment.
- When playing KARAOKE, connect appropriate audio equipment such as an amplifier to the DVD/VCR.

Changing angles

When playing back a disc recorded with multi-angle facility, you can change the angle that you are viewing the scene from.

- 1 Press **ANGLE** during playback.
The current angle will appear.

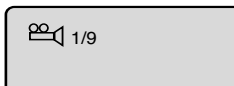

- 2 Press **ANGLE** repeatedly until the desired angle is selected.

NOTE:

Depending on the DVD, you may not be able to change the angles even if multi-angles are recorded on the disc.

Title selection

Two or more titles are recorded on some discs. If the title menu is recorded on the disc, you can select the desired title.

- 1 Press **TOP MENU** during playback.
Title menu appears on the screen.
 - Press **TOP MENU** again to resume playback at the scene when you pressed **TOP MENU**.
- 2 Press **▲/▼** or **◀/▶** to select the desired title.
- 3 Press **ENTER** or **PLAY**.
The playback of the selected title will start.

DVD menu

Some DVDs allow you to select the disc contents using the menu. When you play back these DVDs, you can select the subtitle language and soundtrack language, etc. using the DVD menu.

- 1 Press **DVD MENU** during playback.
The DVD menu appears on the screen.
 - Press **DVD MENU** again to resume playback at the scene when you pressed **DVD MENU**.
- 2 Press **▲/▼** or **◀/▶** to select the desired item.
- 3 Press **ENTER**. The menu continues to another screen. Repeat steps 2 and 3 to set the item completely.

NOTE:

Depending on the DVD, you may be unable to select the title, and a "title menu" may simply be called a "menu" or "title" in the instructions supplied with the disc.

Repeat playback

Title, Chapter, Track Playback

- 1 Press **PLAY MODE** during playback or stop mode.

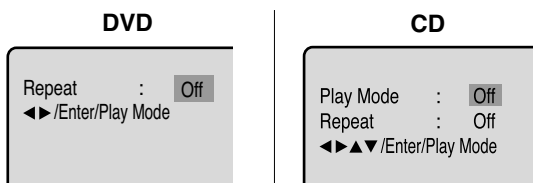

- 2 Press **ENTER** once or twice to select "Chapter" or "Title".
In case of CD, at first press **▼** to select "Repeat" and then press **ENTER** once or twice to select "Track" or "All".

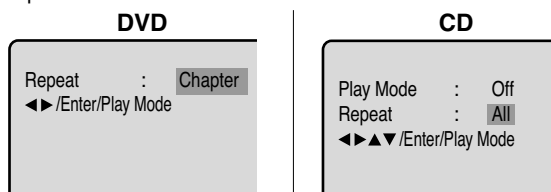

- 3 Press **PLAY MODE** again to make the screen disappear.
 - Press **PLAY** to start Repeat playback.
 - To resume normal playback, select Repeat "Off".

A-B Repeat Playback

A-B repeat playback allows you to repeat material between two selected points.

- 1 Press **REPEAT A-B** during playback.
The start point is selected.
- 2 Press **REPEAT A-B** again.
The end point is selected.
Playback starts at the point that you selected.
Playback stops at the end point, returns to Point A automatically, then starts again.
To resume normal playback press **REPEAT A-B** again.
"Off" appears on the screen.

NOTES:

- Some discs may not work with the repeat operation.
- In A-B repeat mode, subtitles near point A or B may not appear.
- During the A-B Repeat Playback the ANGLE feature will not operate.
- You may not be able to set A-B Repeat, depending on the scenes of the DVD.
- A-B repeat does not work with an interactive DVD and MP3/WMA/JPEG-CD.

Program playback (CD)

You can arrange the order of tracks on the disc.

- 1 Press **PLAY MODE** in the stop mode.
- 2 Press **ENTER** repeatedly until the program table shown at right appears.
- 3 **Example:** In case you wish to program in order of 7, 3, 11:
Enter as **7 ▼, 3 ▼, 11**.
If you input a wrong number, press **CANCEL**.
- 4 Press **▲/▼** or **◀/▶** to select "Program Playback" and press **ENTER**. "Program Playback" will appear on the screen.
The program you selected will begin to playback in the order set. To return to normal playback, select "Play Mode: Off" at step 2 above.

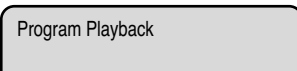
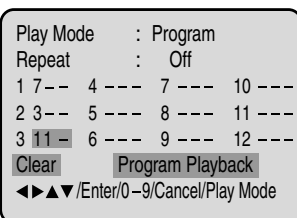
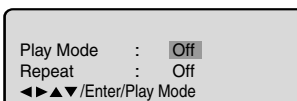

Random playback (CD)

- 1 Press **PLAY MODE** in the stop mode.
- 2 Press **◀/▶** to select "Random".

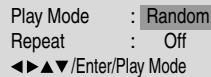

Play Mode : Random
Repeat : Off
◀▶▲▼/Enter/Play Mode

- 3 Press **PLAY**.
"Random Play" will appear on the screen and Random Playback will start.

NOTES:

- To cancel program play, select "Clear" at step 4 and press **ENTER**.
- The program is cancelled when you open the disc tray or turn the power off.
- Random playback can not be combined with Repeat playback.

MP3/WMA/JPEG playback

MP3/WMA/JPEG CD Information

This player can play back MP3/WMA/JPEG files recorded on a CD-R or CD-RW.

MP3 is an audio file format, which compresses recorded music. It was developed by Fraunhofer Gesellschaft in collaboration with Thomson Inc. The main advantage of the MP3 format is that it means CD-quality music tracks can be stored on a personal computer.

WMA (Windows Media Audio) is another audio file format developed by Microsoft.

JPEG files are image files.

To create these files you need a Windows-PC with CD-ROM drive and MP3/WMA/JPEG-encoding software (not supplied). The Apple-HFS-System cannot be played.

Playback Limitations

- File names on a MP3/WMA/JPEG CD must include 3-digit extension letters such as, "mp3", "wma" or "jpg".
- This unit can read 200 files per disc. Keep directory sizes to 200 files or less. Anything over that limit will be omitted.
- This unit is able to recognize up to a maximum of 50 directories per disc.
- If a CD has both audio and graphic files on the same CD, only the audio tracks will play.
- It may take more than one minute for MP3/WMA/JPEG files to play depending on their structure.
- Music recorded by "Joliet Recording Specification" can be played back.
- The unit can play back baseline and progressive JPEG files.
- Music files recorded by "Hierarchical File System" (HFS) cannot be played.

Notes on MP3/WMA/JPEG files

- To play MP3/WMA/JPEG files in the recorded order,
1. Use MP3/WMA/JPEG software that records data alphabetically or numerically.
 2. Name each file including a two-digit or three-digit number (e.g. "01" "02" or "001" "002").
 3. Refrain from creating too many subfolders.

WMA disc compatibility with this player is limited as follows:

- 1) Sampling Frequency: within 32 – 48 kHz
- 2) Bit Rate: within 48 – 192kbps
Mono WMA files and WMA files (under 48kbps) cannot be played back on this player.

Limitations on display

- File names are displayed (within 16 characters) on the screen. File names longer than 16 letters are condensed. Available letters for display are the following: capital or small letters A through Z, numbers 0 through 9, and _ (under score).
- Letters other than those above are replaced with a hyphen. Press **ENTER**. The selected file starts playing back. Press **STOP** to end playback.

CAUTION:

- Some MP3/WMA/JPEG files cannot be played back depending on the recording conditions.
- The CD-R/RW that has no music data or non-MP3/WMA/JPEG files cannot be played back.

About file menu

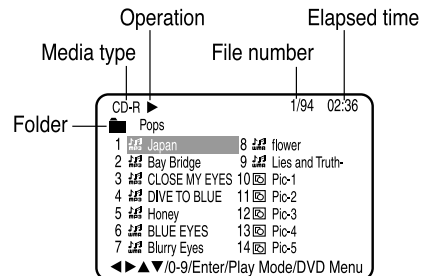

 : Indicates MP3 file

 : Indicates WMA file

 : Indicates JPEG file

NOTES:

- The picture menu is displayed when the FUJICOLOR CD or the Kodak Picture CD are played. To display the file menu press **TOP MENU**.
- MP3 or WMA file on the KODAK Picture CD is not recognized on this TV/VCR/DVD.

MP3/WMA CD playback

- 1 Press **DVD OPEN/CLOSE**.
The disc tray will open.
Place a disc on which MP3 or WMA files have been recorded onto the tray.

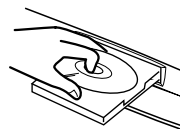

- 2 Press **DVD OPEN/CLOSE** or **PLAY**. The disc tray closes automatically. On the TV-screen, "Reading" will appear. Reading will take as much time as the number of file.

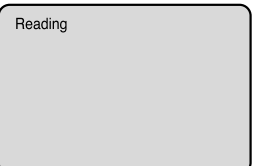

- 3 A file menu screen will appear on the TV screen.

Press ◀/▶ to select folder.

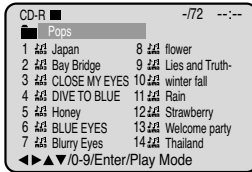

- 4 Press ▲/▼ or ◀/▶ or the **Number keys** to select the desired file.

• In case the folder includes more than 15 files, press ◀ or ▶ to display next file list.

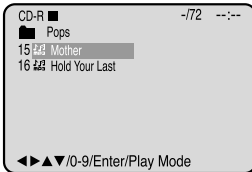
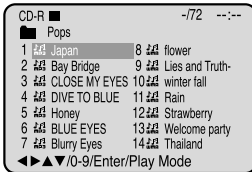

• When **PLAY** has been pressed after displaying the file menu, or when the disc tray has been closed after pressing **PLAY** in step 2, playback begins automatically starting from the first file. In this case, if the first file is an MP3/WMA file, only MP3/WMA files are played back in order. If the first file is a JPEG file, the first JPEG file is played back.

- 5 Press **ENTER**.

The selected file starts playing back.

- 6 Press **STOP** to end playback.

• The TV/VCR/DVD records the stopped point. "■" appears on the screen. Press **PLAY** to resume playback (from the scene point).
• If you press **STOP** again or unload the disc, the TV/VCR/DVD will clear the stopped point.

NOTES:

- During MP3/WMA/JPEG-Playback, you cannot use SEARCH, A-B Repeat functions.
- You can use Repeat (Track or All), Random functions and Program playback for MP3/WMA/JPEG CD Playback (see pages 26, 27).
- In the case of a CD containing a mixture of MP3, WMA and JPEG files, the files are played back by selecting them from the file menu.

JPEG CD playback

- 1 Press **DVD OPEN/CLOSE**.

The disc tray will open. Place a disc on which JPEG files have been recorded onto the tray.

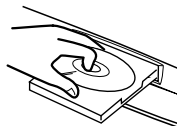

- 2 Press **DVD OPEN/CLOSE** or **PLAY**. The disc tray closes automatically. On the TV screen, "Reading" will appear. Reading will take as much time as the number of file.

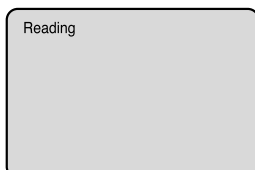

- 3 A file menu screen will appear on the TV screen.

Press ◀/▶ to select folder.

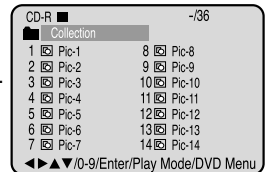

- 4 Press ▲/▼ or ◀/▶ or the **Number keys** to select the desired file.

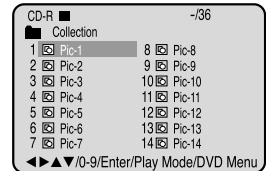

To display a picture menu, press **DVD MENU**. (To return to a file menu, press **TOP MENU**.)

Press ▲/▼ or ◀/▶ to select the desired file.

• To display next list, press **SKIP** ▶▶/◀◀.



• When **PLAY** has been pressed after displaying the file menu, or when the disc tray has been closed after pressing **PLAY** in step 2, playback begins automatically starting from the first file. In this case, if the first file is a JPEG file, the first JPEG file is played back. If the first file is an MP3/WMA file, only MP3/WMA files are played back in order.

- 5 Press **ENTER**.

The selected picture appears on the TV screen.

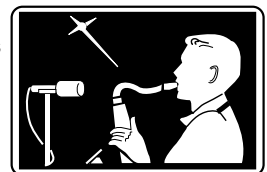

- 6 Press **STOP** to end playback.

The file menu appears on the TV screen. If you want to watch another file, repeat steps 4-5.

Setting the JPEG Interval

You can continuously play back all JPEG files automatically.

- 1 Press **SETUP** in the stop mode.
Press ◀/▶ to select "Picture", then press ▼ or **ENTER**.

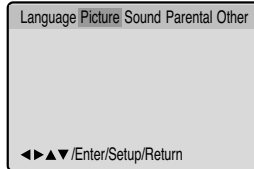

- 2 Press ▲ or ▼ to select "JPEG Interval".

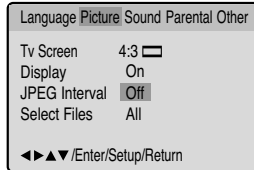

- 3 Press **ENTER** or ◀/▶ to select your desired time.

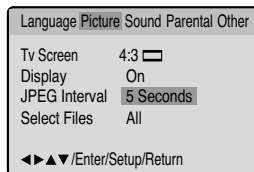

Off:

Plays back one file at a time.

5 Seconds:

Displays images in the form of a slide show. Every 5 seconds the image changes.

10 Seconds:

Displays images in the form of a slide show. Every 10 seconds the image changes.

15 Seconds:

Displays images in the form of a slide show. Every 15 seconds the image changes.

- 4 Press **SETUP** or **RETURN** to remove the MENU screen.

Setting language

You can select the language of the disc menu messages of DVDs.

- 1 Press **SETUP** in the stop mode.
Press ◀ or ▶ to select "Language".
- 2 Press ▼ or **ENTER**, then press ▲ or ▼ to select desired option.
- 3 Press ▶ or **ENTER**.
Press ▲ or ▼ to select your desired language, then press **ENTER**.

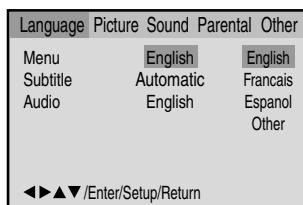

English, Francais, Espanol:

The selected language will be heard or seen.

Other:

Other language can be selected (see the "Language code list" on page 33).

Automatic: (Subtitle)

- The unit will automatically select the same language in the AUDIO setting.
- When the unit selects the same language as the AUDIO, the subtitles will not appear during playback.
- When you do not use the same language as the AUDIO, the subtitles will appear during playback.

Off: (Subtitle)

Subtitles do not appear.

Original: (Audio)

The unit will select the first priority language of each disc.

- 4 To make SETUP screen disappear, press **SETUP**.

NOTE:

If the selected language is not recorded on the disc, the first-priority language is selected.

Setting the aspect ratio of TV screen

You can select the aspect ratio for your TV.

- 1 Press **SETUP** in the stop mode.
Press ◀ or ▶ to select "Picture".
- 2 Press ▼ or **ENTER**, then press ▲ or ▼ to select "Tv Screen".
- 3 Press ▶ or **ENTER**.
Press ▲ or ▼ to select your desired screen type, then press **ENTER**.

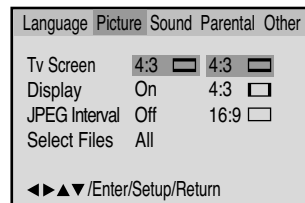

You have the following screen sizes to choose from:

4:3 Letter box

Select this mode when connecting to a conventional TV. When playing back a wide screen-DVD disc, it displays the wide picture with black bands at the top and bottom of screen.

4:3 Pan Scan

It displays the wide picture on the whole screen with left and right edges automatically cut off.

16:9 Wide

Select this mode when connecting to a wide-screen TV. A wide screen picture is displayed full size.

- 4 To make SETUP screen disappear, press **SETUP**.

NOTE:

If the DVD disc is not formatted in the pan & scan style, it displays 4:3 style.

Setting on screen display

On screen display can be switched on or off when you press the **DISPLAY** button.

1 Press **SETUP** in the stop mode.

Press ◀ or ▶ to select "Picture".

2 Press ▼ or **ENTER**, then press ▲ or ▼ to select "Display".

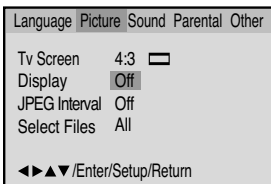

3 Press ▶ or **ENTER** to select "On" or "Off".

On: On screen displays appears when you press any buttons (factory setting).

Off: On screen displays do not appear when you press any buttons except **SETUP**, **SEARCH**, **PLAY MODE**, **MARKER** and **DISPLAY**.

4 To make SETUP screen disappear, press **SETUP**.

Status display of disc

Each press of **DISPLAY**, the status display of the disc will appear on the screen and change as follows.

DVD

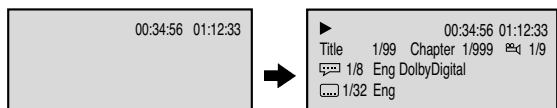

To make status display disappear, press **DISPLAY** again.

AUDIO CD

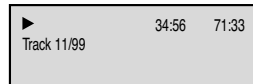

When you playback the CD disc, the status display will appear on the screen and continue displaying.

Dynamic Range Control

DRC (Dynamic Range Control) enables you to control the dynamic range so as to achieve a suitable sound for your equipment.

1 Press **SETUP** in the stop mode.

Press ◀ or ▶ to select "Sound".

2 Press ▼ or **ENTER** to select "DRC".

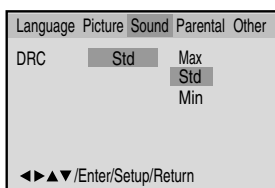

3 Press ▶ or **ENTER**, then press ▲ or ▼ to select desired setting.

Max: Full dynamic range is increased.

Std: Full dynamic range is maintained.

Min: Dynamic range is reduced.

NOTES:

- This function works only during playback of Dolby Digital recorded discs.
- The level of Dynamic Range Reduction may differ depending on DVD video disc.

Progressive scan

The unit supports the Progressive scanning system as well as the conventional interlaced scanning system. If your TV is equipped with component jacks which support the progressive video input, you can enjoy high quality picture by making the Progressive scanning mode active.

S-VIDEO/COMPONENT
Video selector switch

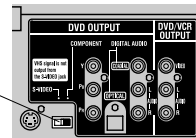

1 Press **PROGRESSIVE** in the stop mode.

The PROGRESSIVE indicator "P" on the display window will light.

- The unit recognizes the picture source (film or video) of the current disc according to the disc information.

2 Press **PLAY** to start playback.

- To make the progressive scanning mode inactive, press **PROGRESSIVE** in the stop mode.

The PROGRESSIVE indicator "P" on the display window will go off.

About PROGRESSIVE SCANNING MODE

To display video on the TV screen, the conventional scanning method is called "Interlaced scanning." With this method, only half of the horizontal lines are displayed at a time. So two fields complete a single picture (frame); i.e., the first field, containing all the odd-numbered lines, is displayed followed by the second field, containing all the even-numbered lines.

The Progressive scanning system scans all horizontal lines at a time, so you can double the number of lines compared with the interlaced scanning, resulting in a high-density, flicker-free picture.

To enjoy a progressive scanned video, the TV connected to the unit must have Progressive inputs.

Depending on the material source format, DVD discs can be classified into two categories; film and video (note that some DVD discs contain both a film source and a video source). Film sources are recorded as 24-frame-per-second information, while (NTSC) video sources are recorded as 30-frame-per second (60-field-per-second interlaced) information.

When the unit plays back a film source material, uninterlaced progressive output signals are created using the original information. When a video source material is played back, the unit interleaves lines between the interlaced lines on each to create the interpolated picture and outputs as the progressive signal.

NOTES:

- Some discs may not be played back with the progressive scanning mode correctly because of the disc characteristics or recording condition.
- There are some progressive TV and High-Definition TV sets that are not fully compatible with the unit, resulting in the unnatural picture when playing back a DVD disc in the Progressive scanning mode. In such a case, use the Interlaced scanning mode.
- You cannot make the progressive scanning mode active in following cases.
 - The unit is in the VCR mode.
 - The disc is played back in the DVD mode.
 - The S-VIDEO/COMPONENT video selector switch is set to S-VIDEO position.

Language code list

Enter the appropriate code number for the initial settings "Menu", "Subtitle" and/or "Audio" (see page 31).

Language Name Code	Language Name Code	Language Name Code	Language Name Code
Abkhazian 1112	Fiji 1620	Lingala 2224	Singhalese 2919
Afar 1111	Finnish 1619	Lithuanian 2230	Slovak 2921
Afrikaans 1116	French 1628	Macedonian 2321	Slovenian 2922
Albanian 2927	Frisian 1635	Malagasy 2317	Somali 2925
Amharic 1123	Galician 1722	Malay 2329	Spanish 1529
Arabic 1128	Georgian 2111	Malayalam 2322	Sundanese 2931
Armenian 1835	German 1415	Maltese 2330	Swahili 2933
Assamese 1129	Greek 1522	Maori 2319	Swedish 2932
Aymara 1135	Greenlandic 2122	Marathi 2328	Tagalog 3022
Azerbaijani 1136	Guarani 1724	Moldavian 2325	Tajik 3017
Bashkir 1211	Gujarati 1731	Mongolian 2324	Tamil 3011
Basque 1531	Hausa 1811	Nauru 2411	Tatar 3030
Bengali; Bangla 1224	Hebrew 1933	Nepali 2415	Telugu 3015
Bhutani 1436	Hindi 1819	Norwegian 2425	Thai 3018
Bihari 1218	Hungarian 1831	Oriya 2528	Tibetan 1225
Breton 1228	Icelandic 1929	Panjabi 2611	Tigrinya 3019
Bulgarian 1217	Indonesian 1924	Pashto, Pushto 2629	Tonga 3025
Burmese 2335	Interlingua 1911	Persian 1611	Turkish 3028
Byelorussian 1215	Irish 1711	Polish 2622	Turkmen 3021
Cambodian 2123	Italian 1930	Portuguese 2630	Twi 3033
Catalan 1311	Japanese 2011	Quechua 2731	Ukrainian 3121
Chinese 3618	Javanese 2033	Rhaeto-Romance 2823	Urdu 3128
Corsican 1325	Kannada 2124	Romanian 2825	Uzbek 3136
Croatian 1828	Kashmiri 2129	Russian 2831	Vietnamese 3219
Czech 1329	Kazakh 2121	Samoan 2923	Volapük 3225
Danish 1411	Kirghiz 2135	Sanskrit 2911	Welsh 1335
Dutch 2422	Korean 2125	Scots Gaelic 1714	Wolof 3325
English 1524	Kurdish 2131	Serbian 2928	Xhosa 3418
Esperanto 1525	Laothian 2225	Serbo-Croatian 2918	Yiddish 2019
Estonian 1530	Latin 2211	Shona 2924	Yoruba 3525
Faroese 1625	Latvian, Lettish 2232	Sindhi 2914	Zulu 3631

Problems and troubleshooting

Incorrect operation is often mistaken for trouble and malfunction. If you think there is something wrong with this unit, please check the points below. Sometimes the trouble may lie in another component. Investigate the other components and electrical appliances being used. If the trouble cannot be rectified even after checking the points below, ask your nearest Pioneer authorized service center or your dealer to carry out repair work.

NOTE:

- If the unit does not operate normally due to external effects such as static electricity, disconnect the power plug from the outlet and insert again to return to normal operating conditions.

SYMPTOMS	POSSIBLE SOLUTIONS	PAGE
DVD/VCR		
DVD/VCR does not operate.	<ul style="list-style-type: none"> • Make sure the power cord is plugged in. • Try another AC outlet. • Power is off, check fuse or circuit breaker. • Unplug unit, then plug it back in. • Select the DVD or VCR mode before operating. 	9 – – 9 –
No picture.	<ul style="list-style-type: none"> • Antenna connection is not correct or antenna cable is disconnected. • Check the unit is connected correctly. • The video channel is not in the correct position or the TV is not set to the video channel 3 or 4. • The video input selector of the TV is not set to VIDEO. Set to VIDEO (or equivalent). • Channel is set to the external mode. 	10,11 10~13 14 – –
No sound.	<ul style="list-style-type: none"> • Check the unit is connected correctly. • Check the input selector of the amplifier is set properly. • The unit is in the Special playback mode. 	10~13 – 17,24
The remote control does not function.	<ul style="list-style-type: none"> • Aim at the remote control at the remote sensor. • Operate within Approx. 5 Meters (15 ft.) or reduce the light in the room. • Clear the path of the beam. • The batteries are weak. Replace the batteries. • Check the batteries are inserted correctly. 	9
No CABLE reception.	<ul style="list-style-type: none"> • Check all CABLE connections. • Station or CABLE system problems, try another station. 	11
VCR		
TV recording does not work.	<ul style="list-style-type: none"> • The erase prevention tab of the video cassette is broken off. • The unit is in the external input mode. 	17,19
Timer recording does not work.	<ul style="list-style-type: none"> • The time is not set correctly. • The recording start/end time is not set correctly. • TIMER REC has not been pressed (E is not lit). 	15,16 20 20
Noise bars on screen.	<ul style="list-style-type: none"> • Tracking adjustment beyond range of automatic tracking circuit. Try Manual tracking adjustment. • Video heads are dirty. • The tape is worn or damaged. 	18 35 –
DVD		
Display is not shown in your language.	<ul style="list-style-type: none"> • Select proper language in the menu options. 	23
Playback doesn't start.	<ul style="list-style-type: none"> • No disc is inserted. • The unit cannot play DVD-ROMs, etc. • The disc may be dirty. Clean up the disc. 	24 23 36
Stopping playback, search, slow-motion play, repeat play, or program play, etc. cannot be performed.	<ul style="list-style-type: none"> • Some discs may not do some of the functions. 	–
No picture, or the screen is blurred or divided into two parts.	<ul style="list-style-type: none"> • The S-VIDEO/COMPONENT selector is not set correctly. • The progressive scanning mode is active through the unit is connected to a TV via the VIDEO OUT jack. 	12 32

Problems and troubleshooting / Video head cleaning

SYMPTOMS	POSSIBLE SOLUTIONS	PAGE
No 4:3 (16:9) picture.	• The setup does not match your TV.	31
No on-screen display.	• Select Display On.	32
No surround sound.	• The setup does not match your stereo system.	13
The unit or remote operation key is not functioning.	• Turn off the unit and unplug the AC power cord for several minutes, then replug it.	–
Playback does not start when the title is selected.	• Check the Parental setup.	30
Audio soundtrack and/or subtitle language is not changed when you play back a DVD.	• Multilingual language is not recorded on the DVD disc.	31
No subtitle.	• Some discs have no subtitles. • Subtitles are cleared. Press SUBTITLE.	25,31
Angle cannot be changed.	• Multi-angles are not recorded on the DVD disc.	26
 appears on the screen.	• The function is prohibited with the unit or the disc.	24

Video head cleaning

Video head clogging

The video heads are the means by which the DVD/VCR reads the picture from the tape during playback. In the unlikely event that the heads become dirty enough to be clogged, no picture will be played back. This can easily be determined if, during playback of a known good tape, there is good sound, but no picture (picture is extremely snowy). If this is the case, have the DVD/VCR checked by qualified service personnel.



Normal



When head is dirty







NOTES:

- DO NOT ATTEMPT TO CLEAN THE VIDEO HEADS OR SERVICE THE UNIT BY REMOVING THE TOP COVER.
- Video heads may eventually wear out and should be replaced when they fail to produce clear pictures.
- To help prevent video head clogging, use only good quality VHS tapes. Discard worn out tapes.
- We do not recommend using wet-type head-cleaning cassettes as they may damage the unit.





Screen sizes and disc formats / Additional information

Screen sizes and disc formats

When viewing on a standard TV or monitor

Screen format of disc	Setting	Appearance
16:9 	4:3 (Letter box)	The program is shown in widescreen with black bars at the top and bottom of the screen. 
	4:3 (Pan Scan)	The sides of the program are cropped so that the picture fills the whole screen. Please note that many widescreen discs override the player's settings so that the disc is shown in letter box format regardless of the setting. 
4:3 	16:9	The program appears squashed. Set to either 4:3 (Letter box) or 4:3 (Pan Scan). 
	4:3 (Pan Scan)	The program is presented correctly on either setting. 

When viewing on a widescreen TV or monitor

Screen format of disc	Setting	Appearance
16:9 	16:9	The program is presented in widescreen. 
4:3 	16:9	Your TV will determine how the picture is presented-check the manual that came with the TV for details. 
		

NOTE:

- Using the 16:9 (Wide) setting with a standard 4:3 TV, or either of the 4:3 settings with a widescreen TV, will result in a distorted picture.

Handling discs

When holding discs of any type, take care not to leave fingerprints, dirt or scratches on the disc surface. Hold the disc by its edge or by the center hole and edge. Damaged or dirty discs can affect playback and recording performance. Take care also not to scratch the label side of the disc. Although not as fragile as the recorded side, scratches can still result in a disc becoming unusable. Should a disc become marked with fingerprints, dust, etc., clean using a soft, dry cloth, wiping the disc lightly from the center to the outside edge as shown in the diagram below.



If necessary, use a cloth soaked in alcohol, or a commercially available CD/DVD cleaning kit to clean a disc more thoroughly. Never use benzine, thinner or other cleaning agents, including products designed for cleaning vinyl records.

Storing discs

Although CDs and DVD discs are more durable than vinyl records, you should still take care to handle and store discs correctly. When you're not using a disc, return it to its case and store upright. Avoid leaving discs in excessively cold, humid, or hot environments (including under direct sunlight). Don't glue paper or put stickers onto the disc, or use a pencil, ball-point pen or other sharp-tipped writing instrument. These could all damage the disc.



For more detailed care information see the instructions that come with discs. Do not load more than one disc into the player.

Damaged discs

Discs spin at high speed inside the player. If you can see that a disc is cracked, chipped, warped, or otherwise damaged, don't risk using it; you could end up damaging the player.

This player is designed for use with conventional, fully circular discs only. Use of shaped discs is not recommended for this product. Pioneer disclaims all liability arising in connection with the use of shaped discs.

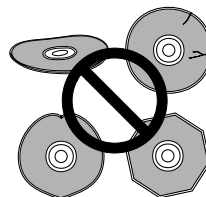

Cleaning the pickup lens

The DVD player's lens should not become dirty in normal use, but if for some reason it should malfunction due to dust or dirt, consult your nearest Pioneer-authorized service center. Although lens cleaners for CD players are commercially available, we do not recommend using them since some may damage the lens.

Handling video tapes

Please do not use the following kinds of video tape:

- Dusty or mouldy tape
- Tape on which liquid has been spilled
- Tape which has been broken and then repaired
- Tape which has become unwound from the spools in the cassette
- Dirty heads and very long length, thin video tape can cause problems such as uneven playback.
- When using a new video tape, fast-forward to the end, then rewind it back to the start before using.
- Avoid dropping video tapes or exposing them to severe vibration.

Storing video tapes

- After using a video tape, rewind it back to the beginning and return to its case.
- Do not store tapes:
 - in excessively dusty places
 - in excessively hot or humid places
 - in direct sunlight
 - near air-conditioners or heaters
 - near strong magnetic fields

Moving the DVD/VCR

If you need to move this unit, first remove the disc and the cassette, if they are loaded, and close the disc tray. Next press STANDBY/ON to switch the power to standby. Lastly, disconnect the power cord.

Hints on installation

We want you to enjoy using this unit for years to come, so please bear in mind the following points when choosing a suitable location for it:

Do...

- ✓ Use in a well-ventilated room.
- ✓ Place on a solid, flat, level surface, such as a table, shelf or stereo rack.

Don't...

- × Use in a place exposed to high temperatures or humidity, including near radiators and other heat-generating appliances.
- × Place on a window sill or other place where the DVD/VCR will be exposed to direct sunlight.
- × Use in a dusty or damp environment or in a room where it will be exposed to excessive cigarette smoke.
- × Place directly on top of an amplifier, or other component in your stereo system that becomes hot in use.
- × Use near a television or monitor as you may experience interference-especially if the television uses an indoor antenna.
- × Use in a kitchen or other room where the DVD/VCR may be exposed to smoke or steam.
- × Use on a thick rug or carpet, or cover with cloth-this may prevent proper cooling of the unit.
- × Place on an unstable surface, or one that is not large enough to support all four of the unit's feet.

Specifications

GENERAL

Power supply:	AC 120V 60Hz
Power consumption:	Operation: 18W Stand by: 2W
Weight:	7.7 lbs (3.5 kg)
Dimensions:	Width : 16-15/16 inches (430 mm) Height : 3-7/8 inches (99 mm) Depth : 9-3/8 inches (237 mm)
Inputs/Outputs:	
Video:	In: 1 Vp-p/75 ohm Out: 1 Vp-p/75 ohm
Audio:	In: -8 dBm/50k ohm Out: -8 dBm/1k ohm
Antenna:	UHF/VHF IN/OUT: 75 ohm coaxial
Hi-Fi frequency response:	20Hz to 20,000Hz
Hi-Fi dynamic range:	More than 90dB

VCR section

Video head:	4 Rotary Heads
Audio track:	Hi-Fi Sound - 2 Tracks / MONO Sound - 1 Track
Tuner:	181 Channel Freq. Synthesized VHF 2-13 UHF 14-69 CABLE TV 14-36 (A)-(W) 37-59 (AA)-(WW) 60-85 (AAA)-(ZZZ) 86-94 (86)-(94) 95-99 (A-5)-(A-1) 100-125 (100)-(125) 01 (5A)
RF channel output:	Channel 3 or 4, Switchable
F.FWD/REW Time:	F.FWD Time: Approx. 4 minutes and 50 seconds REW Time: Approx. 2 minutes and 30 seconds (with T-120 Cassette Tape)(at +25°C)

DVD section

Signal system:	NTSC
Applicable disc:	DVD (12cm, 8cm), CD (12cm, 8cm)
Audio characteristics frequency response:	DVD: 4Hz - 22kHz CD: 4Hz - 20kHz
S/N Ratio:	90dB
Harmonic distortion:	0.02%
Wow and flutter:	Less than 0.01% Wrms
Dynamic range:	More than 90 dB
Output:	Video : (RCA) 1 Vp-p/75 ohm Audio : (RCA) -12 dBm/1k ohm Digital Audio : 0.5 Vp-p/75 ohm
Pickup:	CD : Wavelength: 790 nm Maximum output power: 7 mW DVD :Wavelength: 655 nm Maximum output power: 5 mW

ACCESSORIES:

Remote control x 1
Dry cell batteries (AAA/R03) x 2
75 ohm Coaxial Cable x 1
AUDIO/VIDEO Cable x 1
Warranty card x 1
Operating Instructions

Note: The specifications and design of this product are subject to change without notice, due to improvement.



Dear Customer:

Selecting fine audio equipment such as the unit you've just purchased is only the start of your musical enjoyment. Now it's time to consider how you can maximize the fun and excitement your equipment offers. This manufacturer and the Electronic Industries Association's Consumer Electronics Group want you to get the most out of your equipment by playing it at a safe level. One that lets the sound come through loud and clear without annoying blaring or distortion-and, most importantly, without affecting your sensitive hearing.

Sound can be deceiving. Over time your hearing "comfort level" adapts to higher volumes of sound. So what sounds "normal" can actually be loud and harmful to your hearing. Guard against this by setting your equipment at a safe level BEFORE your hearing adapts.

To establish a safe level:

- Start your volume control at a low setting.
- Slowly increase the sound until you can hear it comfortably and clearly, and without distortion.

Once you have established a comfortable sound level:

- Set the dial and leave it there.

Taking a minute to do this now will help to prevent hearing damage or loss in the future. After all, we want you listening for a lifetime.

We Want You Listening For A Lifetime

Used wisely, your new sound equipment will provide a lifetime of fun and enjoyment. Since hearing damage from loud noise is often undetectable until it is too late, this manufacturer and the Electronic Industries Association's Consumer Electronics Group recommend you avoid prolonged exposure to excessive noise. This list of sound levels is included for your protection.

Decibel Level Example

30	Quiet library, soft whispers
40	Living room, refrigerator, bedroom away from traffic
50	Light traffic, normal conversation, quiet office
60	Air conditioner at 20 feet, sewing machine
70	Vacuum cleaner, hair dryer, noisy restaurant
80	Average city traffic, garbage disposals, alarm clock at two feet.

THE FOLLOWING NOISES CAN BE DANGEROUS UNDER CONSTANT EXPOSURE

90	Subway, motorcycle, truck traffic, lawn mower
100	Garbage truck, chain saw, pneumatic drill
120	Rock band concert in front of speakers, thunderclap
140	Gunshot blast, jet plane
180	Rocket launching pad

Information courtesy of the Deafness Research Foundation.



S001_En

Should this product require service in the U.S.A. and you wish to locate the nearest Pioneer Authorized Independent Service Company, or if you wish to purchase replacement parts, operating instructions, service manuals, or accessories, please call the number shown below.

8 0 0 - 4 2 1 - 1 4 0 4

Please do not ship your product to Pioneer without first calling the Customer Support Division at the above listed number for assistance.

Pioneer Electronics (USA) Inc.
Customer Support Division
P.O. BOX 1760, Long Beach,
CA 90801-1760, U.S.A.

For warranty information please see the Limited Warranty sheet included with your product.

Should this product require service in Canada, please contact a Pioneer Canadian Authorized Dealer to locate the nearest Pioneer Authorized Service Company in Canada.
Alternatively, please contact the Customer Satisfaction Department at the following address:

Pioneer Electronics of Canada, Inc.
Customer Satisfaction Department
300 Allstate Parkway, Markham, Ontario L3R OP2
(905)479-4411
1(877)283-5901

For warranty information please see the Limited Warranty sheet included with your product.

Si ce produit doit être réparé au Canada, veuillez vous adresser à un distributeur autorisé Pioneer du Canada pour obtenir le nom du Centre de Service Autorisé Pioneer le plus près de chez-vous. Vous pouvez aussi contacter le Service à la clientèle de Pioneer:

Pioneer Electroniques du Canada, Inc.
Service à la clientèle
300, Allstate Parkway, Markham, Ontario L3R OP2
(905)479-4411
1(877)283-5901

Pour obtenir des renseignements sur la garantie, veuillez vous reporter au feuillet sur la garantie restreinte qui accompagne le produit.

S018D_enfr

Published by Pioneer Corporation.
Copyright © 2004 Pioneer Corporation.
All rights reserved.

PIONEER CORPORATION

4-1, Meguro 1-Chome, Meguro-ku, Tokyo 153-8654, Japan

PIONEER ELECTRONICS (USA) INC.

P.O. BOX 1540, Long Beach, California 90810-1540, U.S.A. TEL: (800) 421-1404

PIONEER ELECTRONICS OF CANADA, INC.

300 Allstate Parkway, Markham, Ontario L3R OP2, Canada TEL: (905) 479-4411

PIONEER EUROPE NV

Haven 1087, Keetberglaan 1, B-9120 Melsele, Belgium TEL: 03/570.05.11

PIONEER ELECTRONICS ASIACENTRE PTE. LTD.

253 Alexandra Road, #04-01, Singapore 159936 TEL: 656-472-1111

PIONEER ELECTRONICS AUSTRALIA PTY. LTD.

178-184 Boundary Road, Braeside, Victoria 3195, Australia, TEL: (03) 9586-6300

PIONEER ELECTRONICS DE MEXICO S.A. DE C.V.

Bldv.Manuel Avila Camacho 138 10 piso Col.Lomas de Chapultepec, Mexico,D.F. 11000 TEL: 55-9178-4270

K002E

Printed in Thailand

<VRB1362-A>



J2E51401A

04/10

Download from Www.Somanuals.com. All Manuals Search And Download.

Free Manuals Download Website

<http://myh66.com>

<http://usermanuals.us>

<http://www.somanuals.com>

<http://www.4manuals.cc>

<http://www.manual-lib.com>

<http://www.404manual.com>

<http://www.luxmanual.com>

<http://aubethermostatmanual.com>

Golf course search by state

<http://golfingnear.com>

Email search by domain

<http://emailbydomain.com>

Auto manuals search

<http://auto.somanuals.com>

TV manuals search

<http://tv.somanuals.com>