

Pioneer

DVD Player

DVD-V5000



Operating Instructions



The lightning flash with arrowhead symbol, within an equilateral triangle, is intended to alert the user to the presence of uninsulated "dangerous voltage" within the product's enclosure that may be of sufficient magnitude to constitute a risk of electric shock to persons.

CAUTION

**RISK OF ELECTRIC SHOCK
DO NOT OPEN**



The exclamation point within an equilateral triangle is intended to alert the user to the presence of important operating and maintenance (servicing) instructions in the literature accompanying the appliance.

D1-4-2-3-A_En

IMPORTANT SAFETY INSTRUCTIONS

READ INSTRUCTIONS — All the safety and operating instructions should be read before the product is operated.

RETAIN INSTRUCTIONS — The safety and operating instructions should be retained for future reference.

HEED WARNINGS — All warnings on the product and in the operating instructions should be adhered to.

FOLLOW INSTRUCTIONS — All operating and use instructions should be followed.

CLEANING — The product should be cleaned only with a polishing cloth or a soft dry cloth. Never clean with furniture wax, benzene, insecticides or other volatile liquids since they may corrode the cabinet.

ATTACHMENTS — Do not use attachments not recommended by the product manufacturer as they may cause hazards.

WATER AND MOISTURE — Do not use this product near water — for example, near a bathtub, wash bowl, kitchen sink, or laundry tub; in a wet basement; or near a swimming pool; and the like.

ACCESSORIES — Do not place this product on an unstable cart, stand, tripod, bracket, or table.

The product may fall, causing serious injury to a child or adult, and serious damage to the product. Use only with a cart, stand, tripod, bracket, or table recommended by the manufacturer, or sold with the product. Any mounting of the product should follow the manufacturer's instructions, and should use a mounting accessory recommended by the manufacturer.

CART — A product and cart combination should be moved with care. Quick stops, excessive force, and uneven surfaces may cause the product and cart combination to overturn.



VENTILATION — Slots and openings in the cabinet are provided for ventilation and to ensure reliable operation of the product and to protect it from overheating, and these openings must not be blocked or covered. The openings should never be blocked by placing the product on a bed, sofa, rug, or other similar surface. This product should not be placed in a built-in installation such as a bookcase or rack unless proper ventilation is provided or the manufacturer's instructions have been adhered to.

POWER SOURCES — This product should be operated only from the type of power source indicated on the marking label. If you are not sure of the type of power supply to your home, consult your product dealer or local power company.

LOCATION — The appliance should be installed in a stable location.

NONUSE PERIODS — The power cord of the appliance should be unplugged from the outlet when left unused for a long period of time.

GROUNDING OR POLARIZATION

- If this product is equipped with a polarized alternating current line plug (a plug having one blade wider than the other), it will fit into the outlet only one way. This is a safety feature. If you are unable to insert the plug fully into the outlet, try reversing the plug. If the plug should still fail to fit, contact your electrician to replace your obsolete outlet. Do not defeat the safety purpose of the polarized plug.

- If this product is equipped with a three-wire grounding type plug, a plug having a third (grounding) pin, it will only fit into a grounding type power outlet. This is a safety feature. If you are unable to insert the plug into the outlet, contact your electrician to replace your obsolete outlet. Do not defeat the safety purpose of the grounding type plug.

POWER-CORD PROTECTION — Power-supply cords should be routed so that they are not likely to be walked on or pinched by items placed upon or against them, paying particular attention to cords at plugs, convenience receptacles, and the point where they exit from the product.

OUTDOOR ANTENNA GROUNDING — If an outside antenna or cable system is connected to the product, be sure the antenna or cable system is grounded so as to provide some protection against voltage surges and built-up static charges. Article 810 of the National Electrical Code, ANSI/NFPA 70, provides information with regard to proper grounding of the mast and supporting structure, grounding of the lead-in wire to an antenna discharge unit, size of grounding conductors, location of antenna-discharge unit, connection to grounding electrodes, and requirements for the grounding electrode. See Figure A.

LIGHTNING — For added protection for this product during a lightning storm, or when it is left unattended and unused for long periods of time, unplug it from the wall outlet and disconnect the antenna or cable system. This will prevent damage to the product due to lightning and power-line surges.

POWER LINES — An outside antenna system should not be located in the vicinity of overhead power lines or other electric light or power circuits, or where it can fall into such power lines or circuits. When installing an outside antenna system, extreme care should be taken to keep from touching such power lines or circuits as contact with them might be fatal.

OVERLOADING — Do not overload wall outlets, extension cords, or integral convenience receptacles as this can result in a risk of fire or electric shock.

OBJECT AND LIQUID ENTRY — Never push objects of any kind into this product through openings as they may touch dangerous voltage points or short-out parts that could result in a fire or electric shock. Never spill liquid of any kind on the product.

SERVICING — Do not attempt to service this product yourself as opening or removing covers may expose you to dangerous voltage or other hazards. Refer all servicing to qualified service personnel.

DAMAGE REQUIRING SERVICE — Unplug this product from the wall outlet and refer servicing to qualified service personnel under the following conditions:

- When the power-supply cord or plug is damaged.
 - If liquid has been spilled, or objects have fallen into the product.
 - If the product has been exposed to rain or water.
 - If the product does not operate normally by following the operating instructions. Adjust only those controls that are covered by the operating instructions as an improper adjustment of other controls may result in damage and will often require extensive work by a qualified technician to restore the product to its normal operation.
 - If the product has been dropped or damaged in any way.
 - When the product exhibits a distinct change in performance — this indicates a need for service.
- REPLACEMENT PARTS** — When replacement parts are required, be sure the service technician has used replacement parts specified by the manufacturer or have the same characteristics as the original part. Unauthorized substitutions may result in fire, electric shock, or other hazards.

SAFETY CHECK — Upon completion of any service or repairs to this product, ask the service technician to perform safety checks to determine that the product is in proper operating condition.

WALL OR CEILING MOUNTING — The product should not be mounted to a wall or ceiling.

HEAT — The product should be situated away from heat sources such as radiators, heat registers, stoves, or other products (including amplifiers) that produce heat.

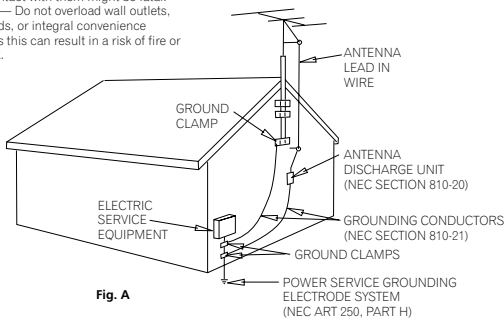

Fig. A

NEC — NATIONAL ELECTRICAL CODE

D1-4-2-2_En

WARNING

This equipment is not waterproof. To prevent a fire or shock hazard, do not place any container filled with liquid near this equipment (such as a vase or flower pot) or expose it to dripping, splashing, rain or moisture.

D3-4-2-1-3_A_En

WARNING: Handling the cord on this product or cords associated with accessories sold with the product will expose you to lead, a chemical known to the State of California and other governmental entities to cause cancer and birth defects or other reproductive harm.

Wash hands after handling

D36-P4_En

CAUTION – PREVENT ELECTRIC SHOCK DO NOT USE THIS (POLARIZED) PLUG WITH AN EXTENSION CORD. RECEPTACLE OR OTHER OUTLET UNLESS THE BLADES CAN BE FULLY INSERTED TO PREVENT BLADE EXPOSURE.

ATTENTION – POUR PREVENIR LES CHOCS ELECTRIQUES NE PAS UTILISER CETTE FICHE POLARISEE AVEC UN PROLONGATEUR UNE PRISE DE COURANT OU UNE AUTRE SORTIE DE COURANT, SAUF SI LES LAMES PEUVENT ETRE INSEREES A FOND SANS EN LAISSER AUCUNE PARTIE A DECOUVERT.

D2-4-4-1_EF

CAUTION : USE OF CONTROLS OR ADJUSTMENTS OR PERFORMANCE OF PROCEDURES OTHER THAN THOSE SPECIFIED HEREIN MAY RESULT IN HAZARDOUS RADIATION EXPOSURE.

CAUTION : THE USE OF OPTICAL INSTRUMENTS WITH THIS PRODUCT WILL INCREASE EYE HAZARD.

D6-8-2-1_En

NOTE: This equipment has been tested and found to comply with the limits for a Class B digital device, pursuant to Part 15 of the FCC Rules. These limits are designed to provide reasonable protection against harmful interference in a residential installation. This equipment generates, uses, and can radiate radio frequency energy and, if not installed and used in accordance with the instructions, may cause harmful interference to radio communications. However, there is no guarantee that interference will not occur in a particular installation. If this equipment does cause harmful interference to radio or television reception, which can be determined by turning the equipment off and on, the user is encouraged to try to correct the interference by one or more of the following measures:

- Reorient or relocate the receiving antenna.
- Increase the separation between the equipment and receiver.
- Connect the equipment into an outlet on a circuit different from that to which the receiver is connected.
- Consult the dealer or an experienced radio/TV technician for help.

D8-10-1-2_En

Information to User

Alteration or modifications carried out without appropriate authorization may invalidate the user's right to operate the equipment.

D8-10-2_En

CAUTION: This product satisfies FCC regulations when shielded cables and connectors are used to connect the unit to other equipment. To prevent electromagnetic interference with electric appliances such as radios and televisions, use shielded cables and connectors for connections.

D8-10-3a_En

This Class B digital apparatus complies with Canadian ICES-003.

Cet appareil numérique de la Classe B est conforme à la norme NMB-003 du Canada.

D8-10-1-3_EF

IMPORTANT NOTICE – THE SERIAL NUMBER FOR THIS EQUIPMENT IS LOCATED IN THE REAR. PLEASE WRITE THIS SERIAL NUMBER ON YOUR ENCLOSED WARRANTY CARD AND KEEP IN A SECURE AREA. THIS IS FOR YOUR SECURITY.

D1-4-2-6-1_En

This product incorporates copyright protection technology that is protected by U.S. patents and other intellectual property rights. Use of this copyright protection technology must be authorized by Rovi Corporation, and is intended for home and other limited viewing uses only unless otherwise authorized by Rovi Corporation. Reverse engineering or disassembly is prohibited.

This product includes FontAvenue® fonts licenced by NEC corporation. FontAvenue is a registered trademark of NEC Corporation.

Thank you for buying this Pioneer product.
Please read through these operating instructions so you will know how to operate your model properly.

- This component may not stand up to continuous long use in severe environments.
- Pioneer disclaims all responsibility for any losses or other incidental damages arising from accidents or other use of this component.



Dear Customer:

Selecting fine audio equipment such as the unit you've just purchased is only the start of your musical enjoyment. Now it's time to consider how you can maximize the fun and excitement your equipment offers. This manufacturer and the Electronic Industries Association's Consumer Electronics Group want you to get the most out of your equipment by playing it at a safe level. One that lets the sound come through loud and clear without annoying blaring or distortion-and, most importantly, without affecting your sensitive hearing.

Sound can be deceiving. Over time your hearing "comfort level" adapts to higher volumes of sound. So what sounds "normal" can actually be loud and harmful to your hearing. Guard against this by setting your equipment at a safe level BEFORE your hearing adapts.

To establish a safe level:

- Start your volume control at a low setting.
- Slowly increase the sound until you can hear it comfortably and clearly, and without distortion.

Once you have established a comfortable sound level:

- Set the dial and leave it there.

Taking a minute to do this now will help to prevent hearing damage or loss in the future. After all, we want you listening for a lifetime.

We Want You Listening For A Lifetime

Used wisely, your new sound equipment will provide a lifetime of fun and enjoyment. Since hearing damage from loud noise is often undetectable until it is too late, this manufacturer and the Electronic Industries Association's Consumer Electronics Group recommend you avoid prolonged exposure to excessive noise. This list of sound levels is included for your protection.

Decibel Level Example

30	Quiet library, soft whispers
40	Living room, refrigerator, bedroom away from traffic
50	Light traffic, normal conversation, quiet office
60	Air conditioner at 20 feet, sewing machine
70	Vacuum cleaner, hair dryer, noisy restaurant
80	Average city traffic, garbage disposals, alarm clock at two feet.

THE FOLLOWING NOISES CAN BE DANGEROUS UNDER CONSTANT EXPOSURE

90	Subway, motorcycle, truck traffic, lawn mower
100	Garbage truck, chain saw, pneumatic drill
120	Rock band concert in front of speakers, thunderclap
140	Gunshot blast, jet plane
180	Rocket launching pad

Information courtesy of the Deafness Research Foundation.



5001_En

Contents

01 Before you start

Features	7
What's in the box	8
Putting the batteries in the remote control	8
Using the remote control	8
Disc / Content Format Playback Compatibility	9
General disc compatibility	9
CD-R/RW compatibility	9
DVD-R/RW compatibility	9
PC-created disc compatibility	9
DVD-Video regions	9

02 Connecting up

Rear panel connections	10
Easy connections	11
Connecting using the S-video output	12
Connecting using the component video output	12
Connecting to an AV receiver	13

03 Controls and displays

Front panel	14
About progressive scan video	15
Remote control	16
Displaying disc information	17

04 Getting started

Switching on	18
Using the on-screen displays	18

05 Initial Settings menu

Using the Initial Settings menu	19
Digital Audio Out settings	19
Digital Out	19
Dolby Digital Out	20
DTS Out	20
96kHz PCM Out	20
MPEG Out	20
Video Output settings	21
TV Screen	21
S-Video Out	21
Still Picture	21

Language settings	22
Audio Language	22
Subtitle Language	22
Selecting languages using the Language Code List	22
Auto Language	23
DVD Menu Language	23
Subtitle Display	23
Display settings	24
On Screen Display	24
Angle Indicator	24
Background	24
Screen Saver	24
Option	25
Parental Lock	25

06 Playing discs

Basic playback controls	28
DVD-Video disc menus	29
Video CD PBC menus	29
Using the Disc Navigator to browse the contents of a disc	30
Switching subtitles	31
Switching DVD audio language	31
Switching VR format DVD-RW audio channel	31
Switching Video CD audio channel	31
Switching camera angles	31
Scanning discs	32
Playing in slow motion	32
Frame advance/frame reverse	32
Looping a section of a disc	33
Using repeat play	33
Creating a program list	34
Editing a program list	35
Other functions available from the program menu	35
Searching a disc	36
Zooming the screen	36

07 Audio Settings menu

Audio DRC	37
Virtual Surround	37

Contents

08 Video Adjust menu

Video Adjust	39
Creating your own interlace output presets	39
Creating your own progressive output presets	40

09 Advanced Setup Menu

To access the ADV. SETUP menu	41
Power On Start	42
Key Lock	44
To Temporarily Suspend KEY LOCK	44
KEY LOCK Indicator Display Specifications	45
Extend Terminal	46
Recording Settings	46
Changing The Setting	48

10 Barcode Stack / Command Stack

Barcode / Command Stack Function	49
Basic Operation	49
Advanced Functions	50
Barcode Stack/Command Stack Settings	50
How to set SUBTITLE, AUDIO, ANGLE	56
Performing chapter search or frame search only	56
To change numbers during input	56
To cancel an operation during input	56
Retain (Preserve) Barcode Stack/Command Stack Settings	57
Erase Barcode Stack/Command Stack Settings	57
Modify Barcode Stack/Command Stack Settings	57
Add Barcode Stack/Command Stack Settings	58
Grouping Barcode Stacks and Command Stacks	59
Create a Group	59
Switch Between Groups	59

Delete Groups	59
Divid a Previously Input Group	60
Merge Groups	61
Execute a Barcode Stacks / Command Stacks	62

11 Additional information

Taking care of your player and discs	63
Handling discs	63
Storing discs	63
Discs to avoid	63
Cleaning the unit's exterior	64
Cleaning the pickup lens	64
Problems with condensation	64
Hints on installation	64
Moving the player	64
Power cable caution	64
Screen sizes and disc formats	65
Widescreen TV users	65
Standard TV users	65
Titles, Chapters and Tracks	65
DVD-Video Regions	65
Play Duration & Power-On Time Display	66
Confirm the Firmware Version	66
Resetting the Player	66
Language Code List	67
Country Code List	67
Extend Terminal	68
Function Assignment	68
Controller	70
Interface Connector	71
Serial Interface Pin Specification	71
Computer Control Functions	72
Serial Control	72
Command Structure	73
Glossary	76
Trobleshooting	77
Specifications	79

Chapter 1

Before you start

Features

NTSC/PAL dual playback

DVD discs in either the NTSC format or the PAL format can be played back.

Interface with external signals (RS-232C, extend terminal)

The device is fitted with an RS-232C connection so that commands can be given to support DVD, Video CD and CD.

Other than the RS-232C interface connector, an extend terminal is provided. By simply connecting a switch to this terminal, operation is possible for DVD-VIDEO menu selection calls as well as operation of the remote control unit.

24-bit/192kHz compatible DAC

This player is fully compatible with high sampling-rate discs, capable of delivering better-than-CD sound quality in terms of dynamic range, low-level resolution and high-frequency detail.

Excellent audio performance with Dolby^{*1} Digital and DTS^{*2} software

Logos:  

When connected to a suitable AV amplifier or receiver, this player gives great surround sound with Dolby Digital and DTS discs.

Virtual Dolby Digital using SRS TruSurround^{*3}

Logo: 

SRS TruSurround creates a realistic surround-sound effect from any Dolby Digital source using just two speakers. SRS TruSurround is a process

approved by Dolby Laboratories for Virtual Dolby Digital sound. See *Virtual Surround* on page 37.

PureCinema progressive scan

When connected to a progressive scan-compatible TV or monitor using the component video outputs, you can enjoy extremely stable, flicker free images, with the same frame refresh rate as the original movie.

Frame search function

When the frame search function is used, searching is possible in units smaller than when searching by chapter and time, and any point can be found.

When frame segment playback is used, it is possible to play back from any point to any point in a video with still playback at the end.

- The frame search function cannot be used with a multi PGC disc (time is not displayed on the TV screen), with a VR format DVD-RW or with a Video CD, etc. Frame segment playback is possible with the DVD barcode, RS-232C control and a Barcode/Command stack.

Picture zoom

While a DVD or Video CD is playing, you can zoom in on any part of the picture at up to 4x magnification for a closer look. See *Zooming the screen* on page 36.

*1 *Manufactured under license from Dolby Laboratories. "Dolby" and the double-D symbol are trademarks of Dolby Laboratories.*

*2 *"DTS" and "DTS Digital Out" are registered trademarks of Digital Theater Systems, Inc.*

*3 *TruSurround, SRS and  symbol are trademarks of SRS Labs, Inc. TruSurround technology is incorporated under license from SRS Labs, Inc.*

What's in the box

Please confirm that the following accessories are in the box when you open it.

- Remote control
- AA/R6P dry cell batteries x2
- Audio/video cable (red/white/yellow plugs)
- Power cable
- Operating instructions
- Warranty card

Putting the batteries in the remote control



Important

Incorrect use of batteries can result in hazards such as leakage and bursting. Please observe the following:

- Don't mix new and old batteries together.
- Don't use different kinds of battery together although they may look similar, different batteries may have different voltages.
- Make sure that the plus and minus ends of each battery match the indications in the battery compartment.
- Remove batteries from equipment that isn't going to be used for a month or more.
- When disposing of used batteries, please comply with governmental regulations or environmental public instruction's rules that apply in your country or area.

- 1 **Open the battery compartment cover on the back of the remote control.**

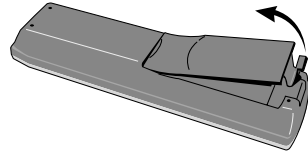

- 2 **Insert two AA/R6P batteries into the battery compartment following the indications (+, -) inside the compartment.**

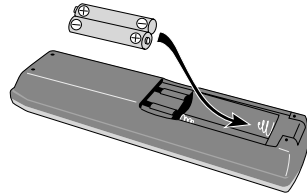

- 3 **Close the cover.**

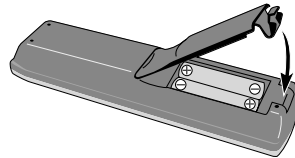

Using the remote control

Keep in mind the following when using the remote control:

- Make sure that there are no obstacles between the remote and the remote sensor on the unit.
- The remote has a range of about 7 m (23ft.).
- Remote operation may become unreliable if strong sunlight or fluorescent light is shining on the unit's remote sensor.
- Remote controllers for different devices can interfere with each other. Avoid using remotes for other equipment located close to this unit.
- Replace the batteries when you notice a fall off in the operating range of the remote.

Disc / Content Format Playback Compatibility

General disc compatibility

This player was designed and engineered to be compatible with software bearing one or more of the following logos:



DVD-Video



DVD-R



DVD-RW



Audio CD



Video CD



CD-R



CD-RW

DVD is a trademark of DVD Format/Logo Licensing Corporation.

This player can play discs recorded in either PAL or NTSC format. Use those discs which indicates "NTSC" or "PAL" on the jacket.

Other formats, including but not limited to the following, are not playable in this player:

**DVD-Audio / SACD / DVD-RAM
DVD-ROM / CD-ROM**

DVD-R/RW and CD-R/RW discs (Audio CDs and Video CDs) recorded using a DVD recorder, CD recorder or personal computer may not be playable on this unit. This may be caused by a number of possibilities, including but not limited to: the type of disc used; the type of recording; damage, dirt or condensation on either the disc or the player's pick-up lens. See below for notes about particular software and formats.

CD-R/RW compatibility

- This unit will play CD-R and CD-RW discs recorded in CD Audio or Video CD format. However, any other content may cause the disc not to play, or create noise/distortion in the output.
- This unit cannot record CD-R or CD-RW discs.
- Unfinalized CD-R/RW discs recorded as CD Audio can be played, but the full Table of Contents (playing time, etc.) will not be displayed.

DVD-R/RW compatibility

- This unit will play DVD-R/RW discs recorded using the DVD-Video format that have been finalized using a DVD-recorder.
- This unit will play DVD-RW discs recorded using the Video Recording (VR) format.
- When playing a VR format DVD-RW discs that was edited on a DVD recorder, the screen may go momentarily black at edited points and/or you may see scenes from immediately before the edited point.
- This unit cannot record DVD-R/RW discs.
- Unfinalized DVD-R/RW discs cannot be played in this player.

PC-created disc compatibility

- If you record a disc using a personal computer, even if it is recorded in a "compatible format" as listed above, there will be cases in which the disc may not be playable in this machine due to the setting of the application software used to create the disc. In these particular instances, check with the software publisher for more detailed information.
- Check the DVD-R/RW or CD-R/RW software disc boxes for additional compatibility information.

Due to the unique construction of DVD-R/RW and CD-R/RW discs, leaving them for extended periods of time in the pause mode at a single place on the disc may result in the discs' becoming difficult to play at that location on the disc. When playing discs containing important data, users are recommended to construct backup archive discs.

DVD-Video regions



All DVD-Video discs carry a region mark on the case somewhere that indicates which region(s) of the world the disc is compatible with. Your DVD player also has a region mark, which you can find on the rear panel. Discs from incompatible regions will not play in this player. Discs marked ALL will play in any player.

Chapter 2

Connecting up

Rear panel connections

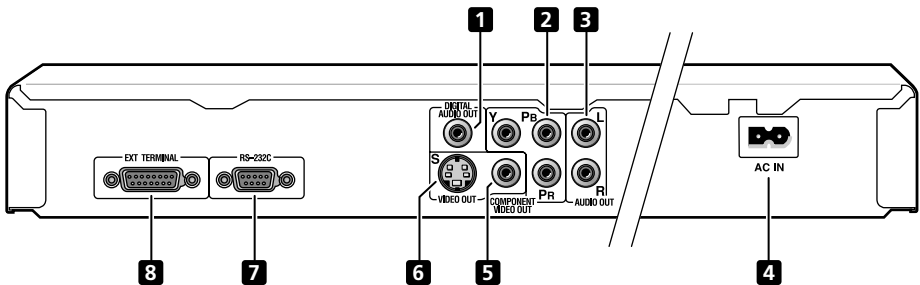
**Important**

When connecting this player up to your TV, AV receiver or other components, make sure that all components are switched off and unplugged.

1 DIGITAL AUDIO OUT

This is a digital audio output for connection to a PCM, Dolby Digital and/or DTS-compatible AV receiver that has a coaxial digital input. Connect using a commercially available coaxial digital cable.

2 COMPONENT VIDEO OUT

This is a high quality video output for connection to a TV, monitor or AV receiver that has component video inputs. Connect using a commercially available three-way component video cable. Be careful to match the colors of the jacks and cables for correct connection.

3 AUDIO OUT L / R

This pair of analog audio outputs connects to your TV, AV receiver or stereo system. Even if you are connecting up one of the digital outputs, we still recommend you connect these jacks. Use the supplied audio/video cable when connecting these jacks. Match the colors of the jacks and cables for correct stereo sound.

4 AC IN

Connect the supplied power cable here, then plug into a power outlet.

5 VIDEO OUT

This is a standard video output that you can connect to your TV or AV receiver using the supplied audio/video cable.

6 S (S-video output)

This is an S-video output that you can use instead of the video output described in **5** above.

7 RS-232C

This is a RS-232C terminal (D-sub 9-pin, male).

8 EXT TERMINAL

This is a RS-232C and Extend terminal (D-sub 15-pin, female).

**Tip**

You may find it useful to have the manuals supplied with your other components handy when connecting this player.

Easy connections

The setup described here is a basic setup that allows you to play discs using just the cables supplied with the player. In this setup, stereo audio is played through the speakers in your TV.

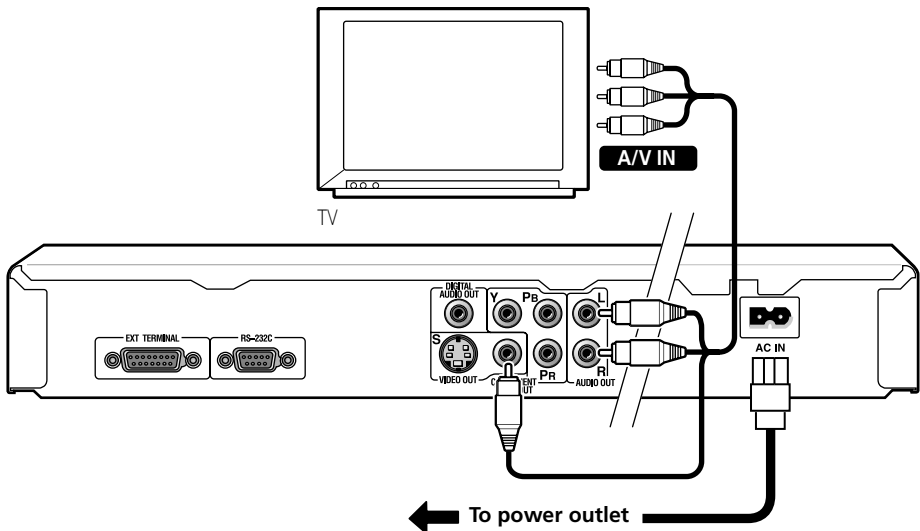

Important

- This player is equipped with copy protection technology. Do not connect this player to your TV via a VCR using AV cables, as the picture from this player will not appear properly on your TV. (This player may also not be compatible with some combination TV/VCRs for the same reason; refer to the manufacturer for more information.)
- When connecting to your TV as shown above, do not set the **COMPONENT VIDEO OUT** setting to **Progressive** (page 15).

1 Connect the VIDEO OUT and AUDIO OUT L/R jacks to a set of A/V inputs on your TV.

Use the supplied Audio/video cable, connecting the red and white plugs to the audio outputs and the yellow plug to the video output.

See next page if you want to use a component or S-video cable for the video connection.

2 Connect the supplied AC power cable to the AC IN inlet, then plug into a power outlet.



Note

When **COMPONENT VIDEO OUT** is set to **Progressive**, there is no video output from the **VIDEO OUT** (composite) and **S** (S-video) jacks. If you want to display video on more than one monitor simultaneously, make sure that it is set to **Interlace**. Press **PROGRESSIVE** on the front panel to switch the player back to **Interlace**.

Connecting using the S-video output

If your TV (or other equipment) has an S-video input, you can use this instead of the standard (composite) output for a better quality picture.

- **Use an S-video cable (not supplied) to connect the S-VIDEO OUT to an S-video input on your TV (or monitor or AV receiver).**

Line up the small triangle above the jack with the same mark on the plug before plugging in.

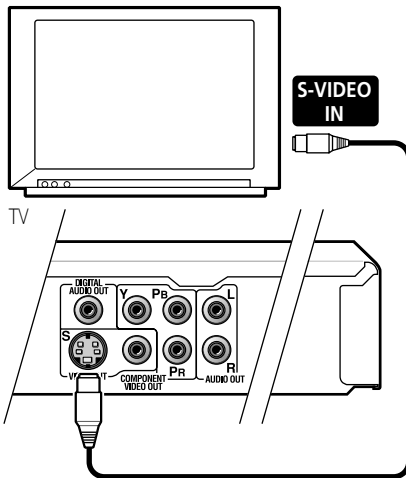

Note

When **COMPONENT VIDEO OUT** is set to **Progressive**, there is no video output from the **S** (S-video) jack. If you want to display video on the monitor, make sure that it is set to **Interlace**. Press **PROGRESSIVE** on the front panel to switch the player back to **Interlace**.

Connecting using the component video output

You can use the component video output instead of the standard video out jack to connect this player to your TV (or other equipment). This should give you the best quality picture from the three types of video output available.

- **Use a component video cable (not supplied) to connect the COMPONENT VIDEO OUT jacks to a component video input on your TV, monitor or AV receiver.**

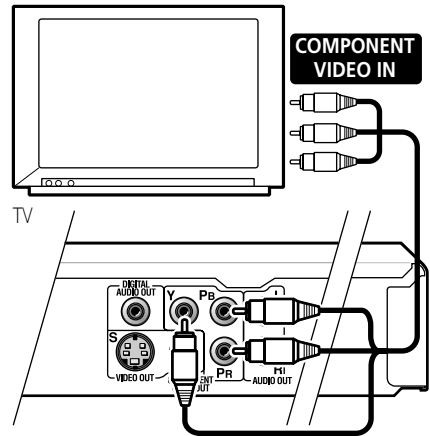

Note

- Only NTSC video is output when set to progressive scan.
- To set up the player for use with a progressive scan TV, see *About progressive scan video* on page 15.

Connecting to an AV receiver

To enjoy multichannel surround sound you need to connect this player to an AV receiver using a digital output. This player has coaxial digital jack. In addition to a digital connection, we recommend also connecting using the stereo analog connection.

You'll probably also want to connect a video output to your AV receiver. You can use any of the video outputs available on this player (the illustration shows a standard (composite) connection).

- 1 **Connect DIGITAL AUDIO OUT jack on this player to a digital input on your AV receiver.**

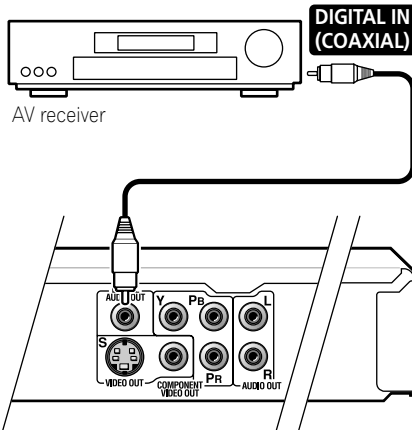

This enables you to listen to multichannel surround sound.

For a coaxial connection, use a coaxial cable (similar to the supplied video cable) to connect the **DIGITAL AUDIO OUT** jack to a coaxial input on your AV receiver.

- 2 **Connect the analog AUDIO OUT L/R and VIDEO OUT jacks on this player to a set of analog audio and video inputs on your AV receiver.**

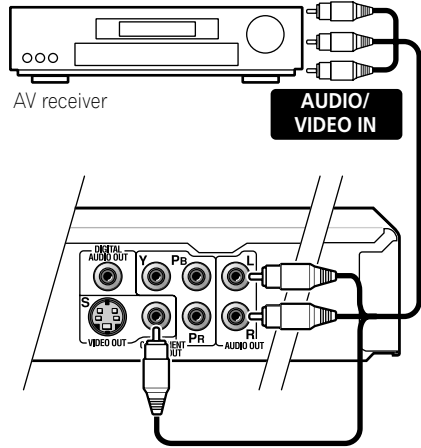

The diagram shows standard video connections, but you can alternatively use the S-video or component video connections if they're available.

- 3 **Connect the AV receiver's video output to a video input on your TV.**

Tip

- You usually have to connect the same kind of video cable between your DVD player and AV receiver, and between your AV receiver and TV.
- If you don't mind mono sound, you can buy a stereo RCA-to-mono RCA cable from an electronics store. Connect the stereo end to this player and the mono end to your TV.

Chapter 3

Controls and displays

Front panel

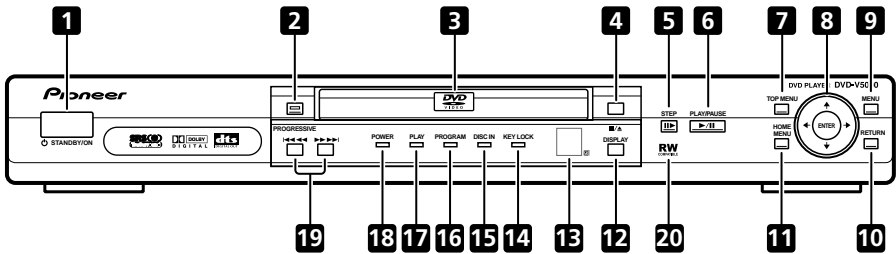
**1** **⏻ STANDBY/ON**

Press to switch the player on or into standby.

2 **PROGRESSIVE button/indicator**

Press to switch the component video output mode between **Progressive** and **Interlace**. The indicator lights in progressive scan mode. See page 15 for more information.

3 **Disc tray****4** **■/▲**

Press to stop the disc.

In the stop mode, press to open or close the disc tray.

5 **STEP **II**▶**

Use for frame advance.

6 **PLAY/PAUSE **▶**/■**

Press to start playback.

In the play mode, press to pause playback. Press again to restart.

7 **TOP MENU**

Press to display the top menu of a DVD disc.

8 **ENTER & cursor buttons**

Use to navigate on-screen displays and menus. Press **ENTER** to select an option or execute a command.

9 **MENU**

Press to display a DVD disc menu, or the Disc Navigator if a VR format DVD-RW, CD or Video CD disc is loaded.

10 **RETURN**

Press to return to a previous menu screen.

11 **HOME MENU**

Press to display (or exit) the on-screen display.

12 **DISPLAY**

Press to display information about the disc playing (see *Displaying disc information* on page 17).

13 **Remote control sensor**

The remote control has a range of up to about 7m (23ft).

14 **KEY LOCK**

When this indicator is lighted, the player cannot be operated using the front panel controls or the remote control unit.

Settings can be changed by ADV. SETUP. (See *Key Lock* on page 44.)

15 **DISC IN**

Flashes during disc discriminating, and lights when a disc is loaded,

16 PROGRAM

Lights when repeat play, program play or command stack function is operated.

17 PLAY

Lights during playback, and flashes when starting up.

18 POWER

Lights green when the player is on.

Lights orange when the player is in the standby mode.

19 and

Press and hold for fast reverse/forward scanning. Press to jump to the previous/next chapter or track.

20

This mark indicates compatibility with DVD-RW discs recorded on a DVD recorder in Video Recording mode.

About progressive scan video

Compared to interlace video, progressive scan video effectively doubles the scanning rate of the picture, resulting in a very stable, flicker-free image.

Progressive scan video is available only from the **COMPONENT VIDEO OUT**. Use the **PROGRESSIVE** button on the front panel to switch the **COMPONENT VIDEO OUT** between **Interlace** and **Progressive**. With a DVD-Video disc you can do this during playback, or when the disc is stopped. For other types of disc, the player must be stopped.



Important

If you connect a TV that is not compatible with a progressive scan signal and switch the player to **Progressive**, you will not be able to see any picture at all. In this case, press the **PROGRESSIVE** button on the front panel to switch back to **Interlace** (the **PROGRESSIVE** indicator should be unlit).



Note

- When **COMPONENT VIDEO OUT** is set to **Progressive**, there is no video output from the **VIDEO OUT** (composite) and **S** (S-video) jacks. If you want to display video on more than one monitor simultaneously, make sure that it is set to **Interlace**. Press **PROGRESSIVE** on the front panel to switch the player back to **Interlace**.

- You can't switch the video output when an OSD is on-screen.
- The picture on some TVs may momentarily break up when you switch the video output of this player.

Compatibility of this unit with progressive-scan TVs.

This player is compatible with progressive video Macro Vision System Copy Guard.

CONSUMERS SHOULD NOTE THAT NOT ALL HIGH DEFINITION TELEVISION SETS ARE FULLY COMPATIBLE WITH THIS PRODUCT AND MAY CAUSE ARTIFACTS TO BE DISPLAYED IN THE PICTURE. IN CASE OF 525 PROGRESSIVE SCAN PICTURE PROBLEMS, IT IS RECOMMENDED THAT THE USER SWITCH THE CONNECTION TO THE "STANDARD DEFINITION" OUTPUT. IF THERE ARE QUESTIONS REGARDING OUR TV SET COMPATIBILITY WITH THIS MODEL 525p DVD PLAYER, PLEASE CONTACT OUR CUSTOMER SERVICE CENTER.

Remote control

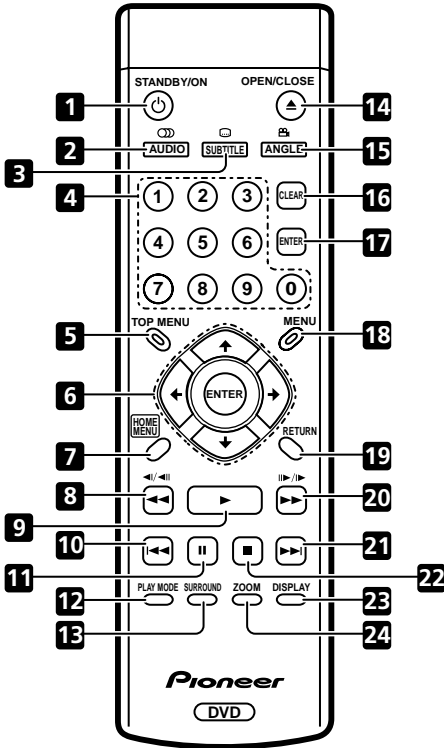

1 **STANDBY/ON**

Press to switch the player on or into standby.

2 **AUDIO**

Press to select the audio channel or language (see *Switching DVD audio language* on page 31).

3 **SUBTITLE**

Press to select a subtitle display (see *Switching subtitles* on page 31).

4 **Number buttons**

5 **TOP MENU**

Press to display the top menu of a DVD disc.

6 **ENTER & cursor buttons**

Use to navigate on-screen displays and menus. Press **ENTER** to select an option or execute a command.

7 **HOME MENU**

Press to display (or exit) the on-screen display.

8 **◀◀ and ◀/▶**

Use for reverse slow motion playback, frame reverse and reverse scanning.

9 **▶**

Press to start playback.

10 **◀◀**

Press to jump to the beginning of the current chapter or track, then to previous chapters/tracks.

11 **||**

Press to pause playback (still); press again to restart.

12 **PLAY MODE**

Press to display the Play Mode menu. (You can also get to the Play Mode menu by pressing **HOME MENU** and selecting Play Mode).

13 **SURROUND**

Press to activate/switch off **DV/SRS** TruSurround.

14 **▲ OPEN/CLOSE**

Press to open or close the disc tray.

15 **ANGLE**

Press to change the camera angle during DVD multi-angle scene playback (see *Switching camera angles* on page 31).

16 **CLEAR**

Press to clear a numeric entry.

17 **ENTER**

Use to select menu options, etc. (works exactly the same as the **ENTER** button in **6** above).

18 **MENU**

Press to display a DVD disc menu, or the Disc Navigator if a VR format DVD-RW, CD or Video CD disc is loaded.

19 **RETURN**

Press to return to a previous menu screen.

20 **▶▶ and ||▶/▶**

Use for forward slow motion playback, frame advance and forward scanning.

21 **▶▶**

Press to jump to the next chapter or track.

Controls and displays

22 ■

Press to stop the disc.

23 DISPLAY

Press to display information about the disc playing (see *Displaying disc information*).

Displaying disc information

Various track, chapter and title information, as well as the video transmission rate for DVD discs, can be displayed on-screen while a disc is playing.

To show/switch the information displayed, press DISPLAY.

When a disc is playing, the information appears at the top of the screen. Press **DISPLAY** again to change the displayed information.

• DVD displays

Play		DVD			
Title	Current / Total	Elapsed	Remain	Total	
Frame	1/3	2.23 4295	138.36	138.59 250470	
Audio	1 English Dolby Digital	3/2.1CH	Subtitle	1 English	Angle 1

Play		DVD			
Chapter	Current / Total	Elapsed	Remain	Total	
Frame	2/36	0.06 196	1.40	1.46 3180	
#	Tr. Rate :	■■■■■■■■			6.0Mbps

The # mark displayed with some DVD-Video discs means that the video is playing at 24 frames/second, progressive.

When the disc is paused, the display also shows the frame number.

Still		DVD			
Title	Current / Total	Elapsed	Remain	Total	
Frame	1/1	0.05 00 151	19.55	20.00 36000	
Audio	1 English	Subtitle	--	Angle	1

24 ZOOM

Press to change the zoom level (see *Zooming the screen* on page 36).

• VR format DVD-RW displays

Play		DVD-RW		Original	
Title	Current / Total	Elapsed	Remain	Total	
	1/32	0.08	30.22	30.30	
Audio	Dolby Digital	2/0CH	Subtitle	--	

Play		DVD-RW		Original	
Chapter	Current / Total				
	1/1				
Tr. Rate	■■■■■■			4.3Mbps	

• Video CD displays

Play		VCD			
Track	Current / Total	Elapsed	Remain	Total	
	2/16	0.23	4.20	4.43	

Play		VCD			
Disc	Elapsed	Remain	Total		
	0.23	58.51	57.14		

• CD displays

Play		CD			
Track	Current / Total	Elapsed	Remain	Total	
	2/16	1.07	4.40	5.47	

Play		CD			
Track	Elapsed	Remain	Total		
	28.00	30.20	58.20		



Note

You can see disc information (number of titles/chapters, tracks and so on) from the Disc Navigator screen. See *Using the Disc Navigator to browse the contents of a disc* on page 30.

Chapter 4

Getting started

Switching on

After making sure that everything is connected properly and that the player is plugged in, press **STANDBY/ON** on the front panel, or on the remote control to switch the player on.

Also, switch on your TV and make sure that it is set to the input you connected the DVD player to. Make sure that the TV is set to the correct video input (not a TV channel). For example, if you connected this player to the **VIDEO 1** inputs on your TV, switch your TV to **VIDEO 1**.

Using the on-screen displays

For ease of use, this player makes extensive use of graphical on-screen displays (OSDs). You should get used to the way these work as you'll need to use them when setting up the player, using some of the playback features, such as program play, and when making more advanced settings for audio and video.

All the screens are navigated in basically the same way, using the cursor buttons (**↑/↓/←/→**) to change the highlighted item and pressing **ENTER** to select it.



Important

Throughout this manual, "Select" means use the cursor buttons to highlight an item on-screen, then press **ENTER**.

Button	What it does
HOME MENU	Display/exit the on-screen display.
↑/↓/←/→	Changes the highlighted menu item.
ENTER	Selects the highlighted menu item.
RETURN	Returns to the main menu without saving changes.



Tip

- The buttons to navigate the on-screen displays are available on the remote control as well as the front panel.
- The button guide at the bottom of every OSD screen shows you which buttons you'll need to use for that screen.

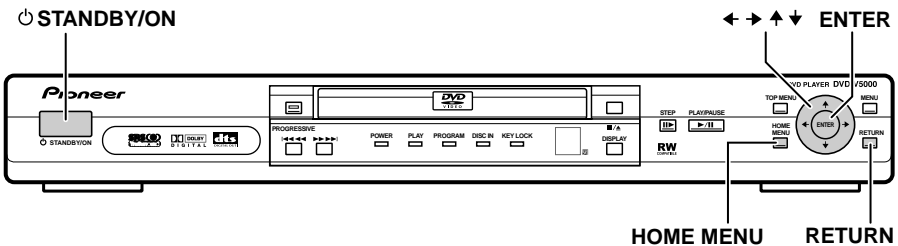

Chapter 5

Initial Settings menu

Using the Initial Settings menu

The Initial Settings menu is where you can set preferences for language, audio and video output, and so on.

If a menu option is grayed out it means that it cannot be changed at the current time. This is usually because a disc is playing. Stop the disc, then change the setting.

- 1 Press **HOME MENU** and select “Initial Settings” from the on-screen display.

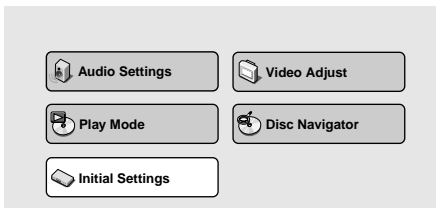

- 2 Select the setup category from the list on the left, then select an item from the menu list to the right.
- 3 Make the setting you want.



Note

The language options shown in the on-screen display illustrations on the following pages may not correspond to those available in your country or region.

Digital Audio Out settings

Digital Out

You only need to make this setting if you connected this system to an AV receiver (or other component) using the digital output.

- Default setting is **On**.

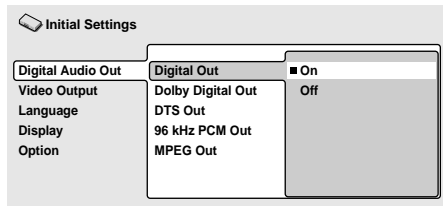

If at any time you need to switch off the digital audio output, set this to **Off**, otherwise leave it **On**.

Dolby Digital Out

You only need to make this setting if you connected this system to an AV receiver (or other component) using the digital output.

- Default setting is **Dolby Digital**.

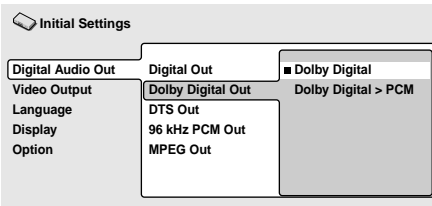

If your AV receiver (or other connected component) is Dolby Digital compatible, set to **Dolby Digital**, otherwise set to **Dolby Digital > PCM**.

DTS Out

You only need to make this setting if you connected this player to an AV receiver (or other component) using the digital output.

- Default setting is **Off**.

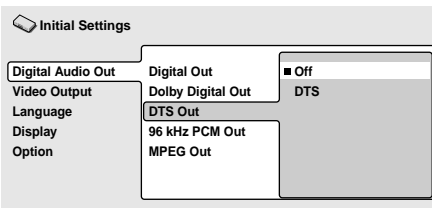

If your AV receiver (or other connected component) has a built-in DTS decoder, set this to **DTS**, otherwise set to **Off**. Check the manual that came with the other component if you're unsure whether it is DTS compatible.

Note

- If you set to DTS with a non-DTS compatible amplifier, noise will be output when you play a DTS disc.
- DTS sound is no output from the AUDIO OUT (analog audio output) jacks.

96kHz PCM Out

You only need to make this setting if you connected this player to an AV receiver (or other component) using the digital output.

- Default setting is **96kHz > 48kHz**.

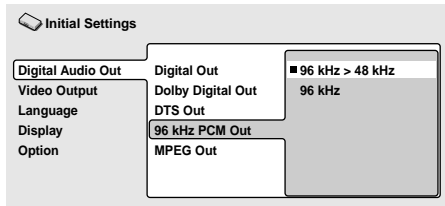

If your AV receiver (or other connected component) is compatible with high sampling rates (96 kHz), set this to **96kHz**, otherwise set it to **96kHz > 48kHz** (96 kHz audio is converted to a more compatible 48 kHz). Check the manual that came with the other component if you're unsure whether it is 96 kHz compatible.

MPEG Out

You only need to make this setting if you connected this player to an AV receiver (or other component) using the digital output.

- Default setting is **MPEG > PCM**.

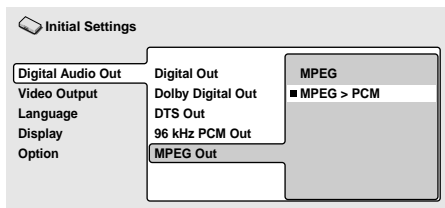

If your AV receiver (or other connected component) is compatible with MPEG audio, set this to **MPEG**, otherwise set it to **MPEG > PCM** (MPEG audio is converted to more compatible PCM audio). Check the manual that came with the other component if you're unsure whether it is MPEG audio compatible.

Video Output settings

TV Screen

- Default setting is **16:9 (Wide)**.

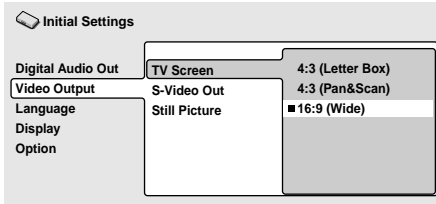

If you have a widescreen TV, select the **16:9 (Wide)** setting-widescreen DVD software is then shown using the full screen area. When playing software recorded in conventional (4:3) format, the settings on your TV will determine how the material is presented-see the manual that came with your TV for details on what options are available.

If you have a conventional TV, select either **4:3 (Letter Box)** or **4:3 (Pan & Scan)**. In Letter Box mode, widescreen software is shown with black bars at the top and bottom of the screen. Pan & Scan chops the sides off widescreen material to make it fit the 4:3 screen (so even though the image looks larger on the screen, you're actually seeing less of the picture). See also *Screen sizes and disc formats* on page 65.

S-Video Out

You only need to make this setting if you connected this player to your TV using an S-video cable.

- Default setting is **S2**.

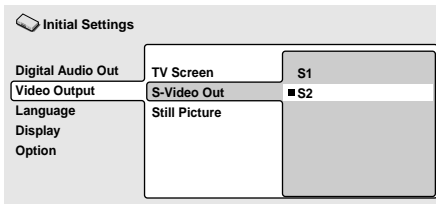

If you find that the picture is stretched or distorted on the default **S2** setting, try changing it to **S1**.

Still Picture

This player uses one of two processes when displaying a still frame from a DVD disc.

- Default setting is **Frame**.

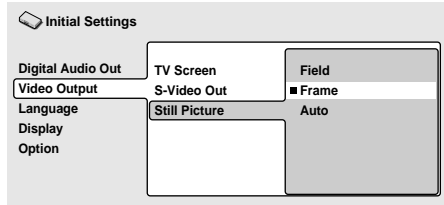

The default **Frame** setting produces a sharper image, but more prone to shake than field stills.

- **Field** – produces a stable, generally shake-free image
- **Auto** – automatically chooses the best setting each time



Note

Depending on the disc, there are times when the picture quality may not become clear, even if **Field** is selected.

Language settings

Audio Language

- Default setting is **English**.

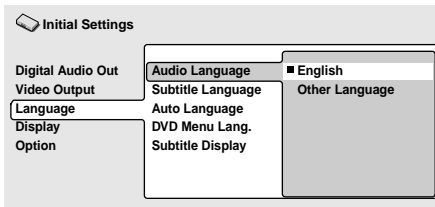

This setting is your preferred audio language for DVD discs. If the language you specify here is recorded on a disc, the player automatically plays the disc in that language. The DVD format recognizes 136 different languages. Select **Other Language** if you want to specify a language other than English. See also *Selecting languages using the Language Code List*.

Tip

- You can switch between the languages recorded on a DVD disc during playback using the **AUDIO** button. (This does not affect this setting.) See *Switching DVD audio language* on page 31.
- Some DVD discs set the audio language automatically when loaded, overriding the **Audio Language** setting.
- Discs with two or more audio languages usually allow you to select the audio language from the disc menu. Press **MENU** to access the disc menu.

Selecting languages using the Language Code List

Some of the language options (such as "Audio Language" in the Language setting) allow you to set your preferred language from any of the 136 languages listed in the *Language Code List* on page 67.

Subtitle Language

- Default setting is **English**.

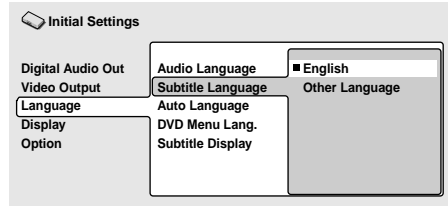

This setting is your preferred subtitle language for DVD discs. If the language you specify here is recorded on a disc, the player automatically plays the disc with those subtitles. The DVD format recognizes 136 different languages. Select **Other Language** if you want to specify a language other than English. See also *Selecting languages using the Language Code List*.

Tip

- You can change or switch off the subtitles on a DVD disc during playback using the **SUBTITLE** button. (This does not affect this setting.) See *Switching subtitles* on page 31.
- Some DVD discs set the subtitle language automatically when loaded, overriding the **Subtitle Language** setting.
- Discs with two or more subtitle languages usually allow you to select the subtitle language from the disc menu. Press **MENU** to access the disc menu.

- 1 Select "Other Language."
- 2 Use the **←/→** (cursor left/right) buttons to select either a code letter or a code number.
- 3 Use the **↑/↓** (cursor up/down) buttons to select a code letter or a code number. See *Language Code List* on page 67 for a complete list of languages and codes.

Auto Language

- Default setting is **On**.

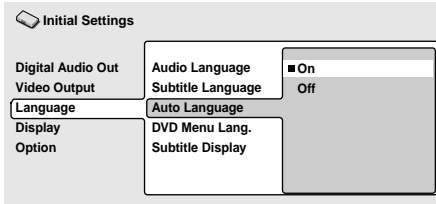

When set to **On**, the player always selects the default audio language on a DVD-Video disc (French dialog for a French movie, for example), and displays subtitles in your preferred subtitle language only if that is set to something different. In other words, movies in your native language won't have any subtitles, while foreign language movies will be shown with subtitles. Set to **Off** to have the player play discs strictly according to your **Audio Language** and **Subtitle Language** settings.

For **Auto Language** to work, the **Audio Language** and **Subtitle Language** settings must be the same (see also page 22).



Tip

You can still switch audio and subtitle language on playback using the **AUDIO** and **SUBTITLE** buttons.

DVD Menu Language

- Default setting is **w/Subtitle Lang..**

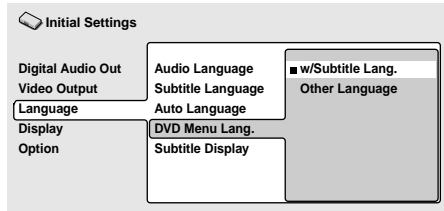

Some multilingual discs have disc menus in several languages. This setting specifies in which language the disc menus should appear. Leave on the default setting for menus to appear in the same language as your **Subtitle Language**—see page 22.

The DVD format recognizes 136 different languages. Select **Other Language** if you want to specify a language other than those listed. See also *Selecting languages using the Language Code List* on page 22.

Subtitle Display

- Default setting is **On**.

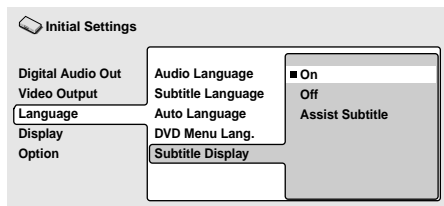

When set to **On**, the player displays subtitles according to the Subtitle Language and Auto Language settings. Set to **Assist Subtitle** to have the player display the extra assistive subtitles recorded on to some DVD discs. Set to **Off** to switch subtitles off altogether.

Display settings

On Screen Display

- Default setting is **On**.

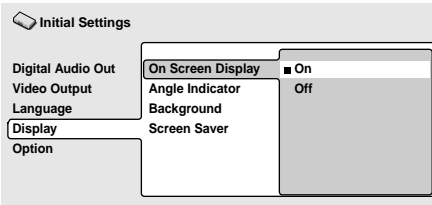

This sets whether operation displays are shown on-screen (**Play**, **Scan** and so on.)

Angle Indicator

- Default setting is **On**.

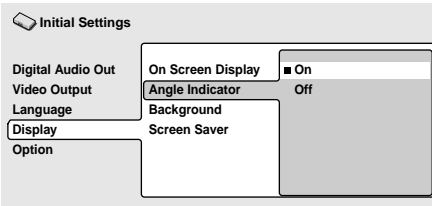

If you prefer not to see the camera icon on-screen during multi-angle scenes on DVD discs, change this setting to **Off**.

Background

- Default setting is **Blue**.

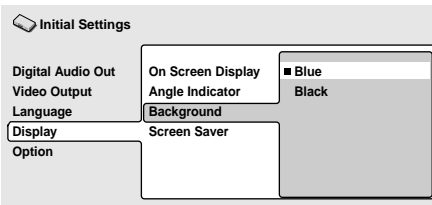

This specifies the color of the screen when the player is stopped.

Screen Saver

- Default setting is **Off**.

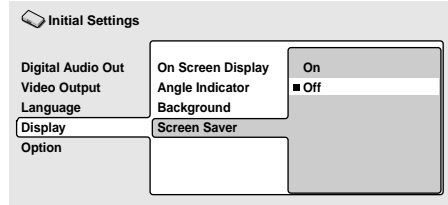

If a constant image is displayed on a conventional CRT-type TV, it can "burn in" leaving a ghost image on the screen. Switch to **On** to make sure that a constant image is not displayed for a dangerously long time.

Option

Parental Lock

- Default level: **Off**
- Default password: none
- Default Country code: **us (2119)**

Some DVD-Video discs feature a Parental Lock level. If your player is set to a lower level than the disc, the disc won't play. This gives you some control about what your children watch on your DVD player.

Some discs also support the Country code feature. The player does not play certain scenes on these discs, depending on the Country code you set.

Before you can set the Parental Lock level or the Country code you must register a password. As the password owner, you can change the Parental Lock level or Country code whenever you like. You can also change the password.



Note

- Not all discs that you may consider inappropriate for your children use the Parental Lock feature. These discs will always play without requiring the password first.
- If you forget your password, you'll need to reset the player to its factory settings (see *Resetting the Player* on page 66), then register a new password.

Registering a new password

You must register a password before you can change the Parental Lock level or enter a Country code.

1 Select "Password."

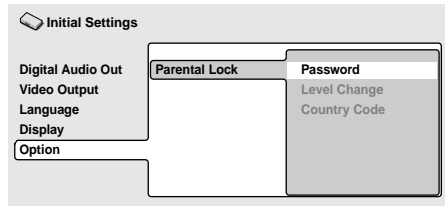

2 Use the number buttons on the Remote control to enter a 4-digit password.

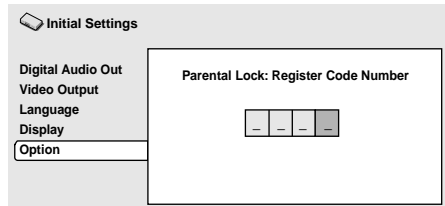

The numbers you enter show up as asterisks (*) on-screen.

3 Press ENTER to register the password and return to the Option menu screen.

If you forget your password, you can reset the player then register a new one. See *Resetting the Player* on page 66 for how to reset the player.

Changing your password

To change your password, confirm your existing password then enter a new one.

1 Select "Password Change."

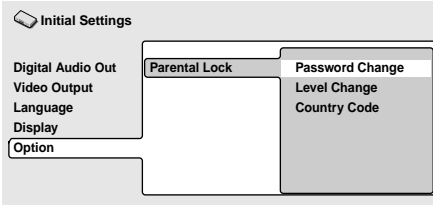

2 Use the number buttons on the Remote control to enter your existing password, then press ENTER.

The numbers appear as asterisks as you enter them.

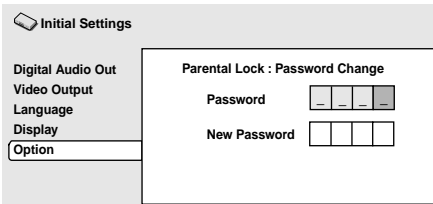

3 Enter a new password.

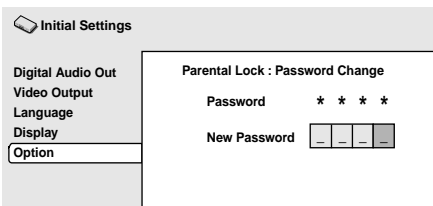

4 Press ENTER to register the new password and return to the Option menu screen.

Setting/changing the Parental Lock level

1 Select "Level Change."

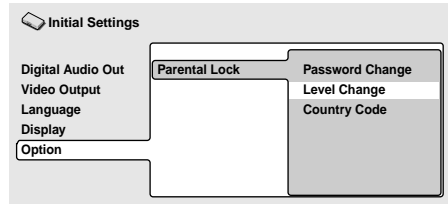

2 Use number buttons on the Remote control to enter your password, then press ENTER.

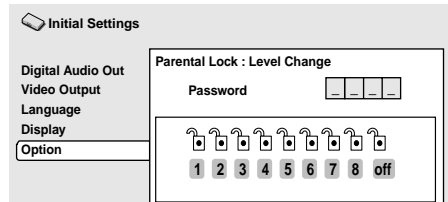

3 Select a new level.

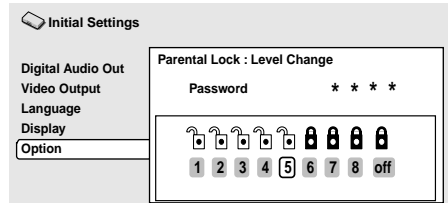

Press ← (cursor left) repeatedly to lock more levels (more discs will require the password); press → (cursor right) to unlock levels. You can't lock level 1.

4 Press ENTER to set the new level and return to the Option menu screen.

Setting/changing the Country code

You may also want to refer to the *Country Code List* on page 67.

1 Select "Country Code."

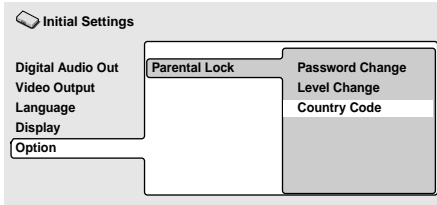

2 Use number buttons on the Remote control to enter your password, then press ENTER.

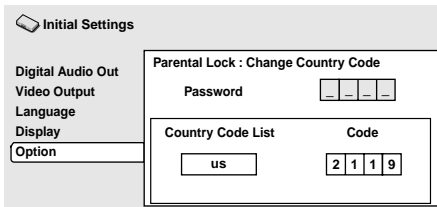

3 Select a Country code.

There are two ways you can do this.

- **Select by code number:**

Use \uparrow/\downarrow (cursor up/down) to change the Country code.

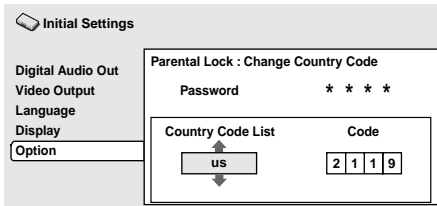

- **Select by code number:**

Press \rightarrow (cursor right) to select the 4-digit Country code input.

Then use \uparrow/\downarrow (cursor up/down) to select the number for each digit and use \leftarrow/\rightarrow (cursor left/right) to move the digit, or use the number buttons on the Remote control to enter the 4-digit Country code (you can find the *Country Code List* on page 67).

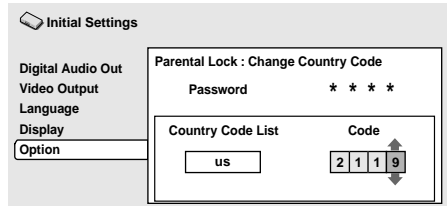

4 Press ENTER to set the new Country code and return to the Option menu screen.



Note

Changing the Country code does not take effect until the next disc is loaded (or the current disc is reloaded).

Chapter 6

Playing discs

Throughout this manual, the term “DVD” means DVD-Video and DVD-R/RW. If a function is specific to a particular kind of DVD disc, it is specified.

- If the player isn't already on, press **STANDBY/ON** to switch it on.**
If you're playing a DVD or Video CD, also turn on your TV and make sure that it is set to the correct video input.
- Press **■/▲** (stop, open/close) to open the disc tray.**
- Load a disc.**
 - Load a disc with the label side facing up, using the disc tray guide to align the disc.
 - Never load more than one disc at a time.

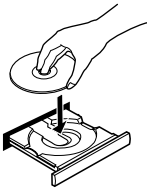

- Press **PLAY/PAUSE ▶/||** to start playback.**
If you're playing a DVD or Video CD, a menu may appear. See *DVD-Video disc menus* on page 29 and *Video CD PBC menus* on page 29 for more on how to navigate these.

Basic playback controls

The table below shows the basic controls on the remote for playing discs. The following chapter covers more playback features in more detail.

Button	What it does
▶/	Starts playback. Pauses a disc that's playing, or restarts a paused disc.
■/▲	Stops playback. Open/close the disc tray.
◀◀◀◀	Press and hold for fast reverse scanning; press for previous track/chapter skip.
▶▶▶▶	Press and hold for fast forward scanning; press for next track/chapter skip.
Numbers (remote buttons)	Use to enter a title/track number. Press ENTER to select (or wait a few seconds). <ul style="list-style-type: none"> If the disc is stopped, playback starts from the selected title (for DVD) or track number (for CD/Video CD). If the disc is playing, playback jumps to the start of the selected chapter or track.

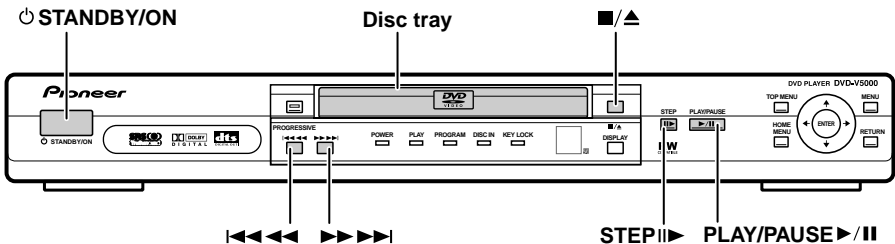

Button	What it does
II▶	Press to advance a frame at a time.

DVD-Video disc menus

Many DVD-Video discs contain menus from which you can select what you want to watch. They may give access to additional features, such as subtitle and audio language selection, or special features such as slideshows. See the disc packaging for details. Sometimes DVD-Video menus are displayed automatically when you start playback; others only appear when you press **MENU** or **TOP MENU**.

Button	What it does
TOP MENU	Displays the "top menu" of a DVD disc-this varies with the disc.
MENU	Displays a DVD disc menu-this varies with the disc and may be the same as the "top menu."
↑/↓/←/→	Moves the cursor around the screen.
ENTER	Selects the current menu option.
RETURN	Returns to the previously displayed menu screen.
Numbers (remote buttons)	Highlights a numbered menu option (some discs only). Press ENTER to select.

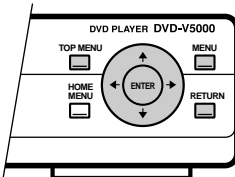

Video CD PBC menus

Some Video CDs have menus from which you can choose what you want to watch. These are called PBC (Playback control) menus. You can play a PBC Video CD without having to navigate the PBC menu by starting playback using a number button to select a track, rather than the ▶ (play) button.

Button	What it does
RETURN	Displays the PBC menu.
Numbers (remote buttons)	Use to enter a numbered menu option. Press ENTER to select.
◀◀ (remote button)	Displays the previous menu page (if there is one).
▶▶ (remote button)	Displays the next menu page (if there is one).

Remote control

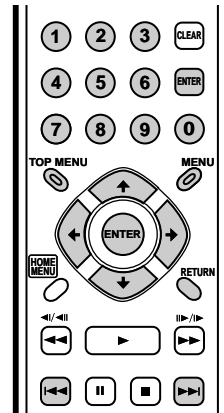

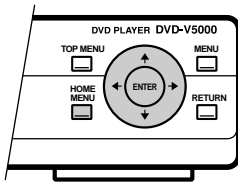

Using the Disc Navigator to browse the contents of a disc

Use the Disc Navigator to browse through the contents of a disc to find the part you want to play. You can use the Disc Navigator when a disc is playing or stopped.

- 1 **Press HOME MENU and select “Disc Navigator” from the on-screen display.** Alternatively, if a VR format DVD-RW, CD or Video CD disc is loaded, you can press **MENU**, which takes you straight to the Disc Navigator screen.



- 2 **Select what you want to play.** Depending on the type of disc you have loaded, the Disc Navigator looks slightly different. The screen for DVD discs shows the titles on the left and the chapters on the right. Select a title, or a chapter within a title.

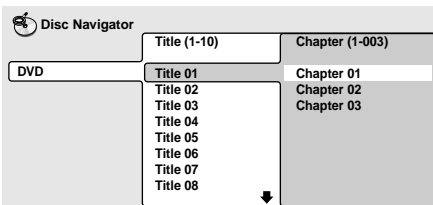

For a VR (Video Recording) mode DVD-RW disc select between the **Playlist** and **Original** areas of the disc, or a title. Press **→** (cursor right) to preview the title.

- It's not possible to switch between Original and Playlist during playback.
- Not all VR format DVD-RW discs have a Playlist.

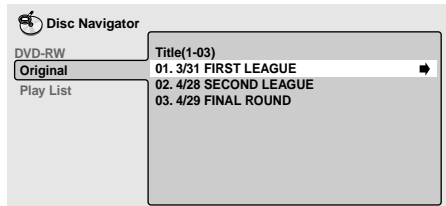

The screen for CDs and Video CDs shows a list of tracks. (The screen below show a CD loaded.)

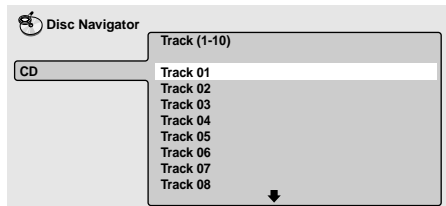

- 3 **Playback starts after you press ENTER.**



Tip

- The Disc Navigator is not available unless there is a disc loaded.
- It's not possible to use the Disc Navigator when playing a Video CD in PBC mode, or an unfinalized CD-R/RW disc.
- Another way to find a particular place on a disc is to use one of the search modes. See *Searching a disc* on page 36.

Remote control

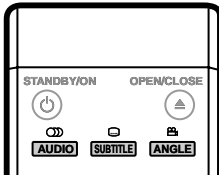

Switching subtitles

Some DVD discs have subtitles in one or more languages; the disc box will usually tell you which subtitle languages are available. You can switch subtitle language during playback.

Press **SUBTITLE** repeatedly to select a subtitle option.

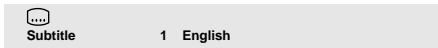

Note

- Some discs only allow you to change subtitle language from the disc menu. Press **TOP MENU** to access.
- To set subtitle preferences, see *Subtitle Language* on page 22.

Switching DVD audio language

When playing a DVD disc recorded with dialog in two or more languages, you can switch audio language during playback.

Press **AUDIO** repeatedly to select an audio language option.



Note

- Some discs only allow you to change audio language from the disc menu. Press **TOP MENU** to access.
- To set audio language preferences, see *Audio Language* on page 23.

Switching VR format DVD-RW audio channel

When playing a VR format DVD-RW disc recorded with dual-mono audio, you can switch between the main, sub, and mixed channels during playback.

Press **AUDIO** repeatedly to select an audio channel option.

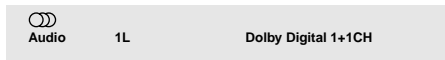

Switching Video CD audio channel

When playing a Video CD, you can switch between stereo, just the left channel or just the right channel.

Press **AUDIO** repeatedly to select an audio channel option.



Switching camera angles

Some DVD discs feature scenes shot from two or more angles-check the disc box for details. When a multi-angle scene is playing, a  icon appears on screen to let you know that other angles are available (this can be switched off if you prefer-see *Angle Indicator* on page 24).

During playback (or when paused), press **ANGLE** to switch angle.

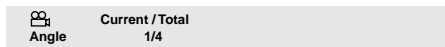

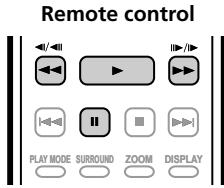

Scanning discs

You can fast-scan discs forward or backward at various different speeds.

During playback, press and hold **◀◀◀◀** or **▶▶▶▶** **on the front panel to scan.**

[When using remote control]

- 1 **During playback, press** **◀◀** or **▶▶** **to start scanning.**
- 2 **Press repeatedly to increase the scanning speed.**
The scanning speed is shown on-screen.
- 3 **To resume normal playback, press** **▶ (play).**



Note

- Sound can be heard while scanning audio CDs.
- When scanning a Video CD track, playback automatically resumes at the end or beginning of the track.
- There is no sound while scanning DVDs and Video CDs, and no subtitles while scanning DVDs.
- Depending on the disc, normal playback may automatically resume when a new chapter is reached on a DVD disc.

Playing in slow motion

You can play DVDs and Video CDs at four different forward slow motion speeds. DVD discs can also be played at two reverse speeds. (With Video CDs, you can only use forward slow motion playback.)

- 1 **During playback, press** **II (pause) (PLAY/PAUSE ▶/II or STEP II▶ on the front panel).**

- 2 **Press and hold** **◀/◀◀ or II▶/II▶ until slow motion playback starts.**
 - The slow motion speed is shown on-screen.
 - There is no sound during slow motion playback.
- 3 **Press repeatedly to change the slow motion speed.**
The slow motion speed is displayed on-screen.
- 4 **To resume normal playback, press** **▶ (play) (PLAY/PAUSE ▶/II on the front panel).**



Note

- The picture quality during slow motion playback is not as good as during normal playback.
- Depending on the disc, normal playback may automatically resume when a new chapter is reached.

Frame advance/frame reverse

You can advance or back up a DVD disc frame-by-frame. With Video CDs and VR format DVD-RWs, you can only use frame advance.

- 1 **During playback, press** **II (pause) (PLAY/PAUSE ▶/II or STEP II▶ on the front panel).**
- 2 **Press** **◀/◀◀ or II▶/II▶ to reverse or advance a frame at a time.**
- 3 **To resume normal playback, press** **▶ (play) (PLAY/PAUSE ▶/II on the front panel).**



Note

- The picture quality when using frame reverse is not as good as frame advance.
- Depending on the disc, normal playback may automatically resume when a new chapter is reached.
- When changing direction with a DVD disc, the picture may "move" in an unexpected way. This is not a malfunction.

Looping a section of a disc

The A-B Repeat function allows you to specify two points (A and B) within a track (CD and Video CD) or title (DVD) that form a loop which is played over and over.



Important

You can't use A-B Repeat with Video CDs in PBC mode, or unfinalized CD-R/RW discs.

- 1 During playback, press **PLAY MODE** and select **"A-B Repeat"** from the list of functions on the left.

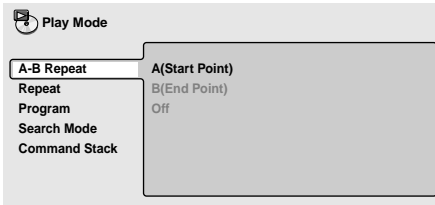

- 2 Press **ENTER** on **"A(Start Point)"** to set the loop start point.

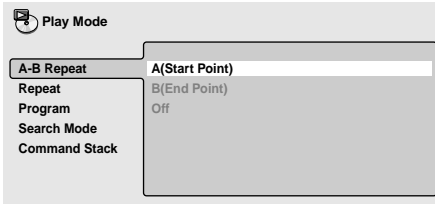

- 3 Press **ENTER** on **"B(End Point)"** to set the loop end point.

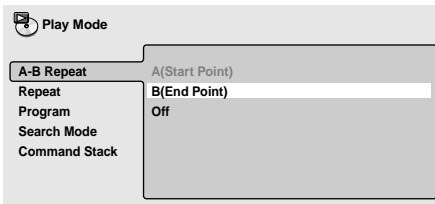

- After pressing **ENTER**, playback jumps back to the start point and plays the loop.
- The minimum loop time is 2 seconds.

- 4 To resume normal playback, select **"Off"** from the menu.

Using repeat play

There are various repeat play options, depending on the kind of disc loaded. It's also possible to use repeat play together with program play to repeat the tracks/chapters in the program list (see *Creating a program list* on page 34).



Important

You can't use Repeat play with Video CDs in PBC mode, or unfinalized CD-R/RW discs.

- 1 During playback, press **PLAY MODE** and select **"Repeat"** from the list of functions on the left.

"All Repeat" will be displayed as an option when the **TITLE PLAY MODE** is set to **"All"** on the ADV. SETUP menu (see page 41).

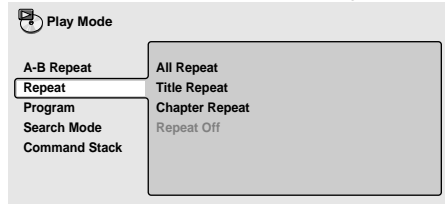

- 2 Select a repeat play option. If program play is active, select **Program Repeat** to repeat the program list, or **Repeat Off** to cancel.

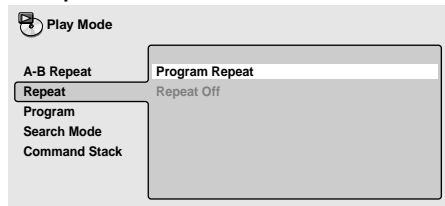

For DVD discs, select **All Repeat**, **Title Repeat** or **Chapter Repeat** (or **Repeat Off**).

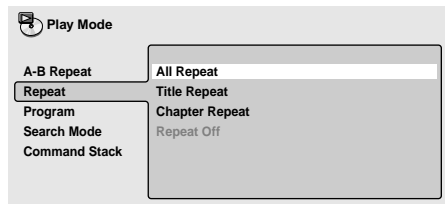

For CDs and Video CDs, select **Disc Repeat** or **Track Repeat** (or **Repeat Off**).

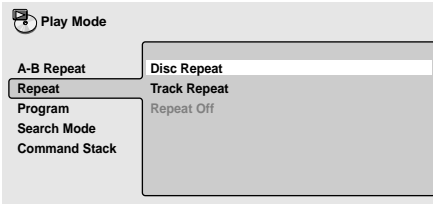

Note

If you switch camera angle during repeat play, repeat play is canceled.

Creating a program list

This feature lets you program the play order of titles/chapters/tracks on a disc.



Important

You can't use Program play with VR format DVD-RW discs, Video CDs playing in PBC mode, or while a DVD disc menu is being displayed.

- 1 Press **PLAY MODE** and select "Program" from the list of functions on the left.

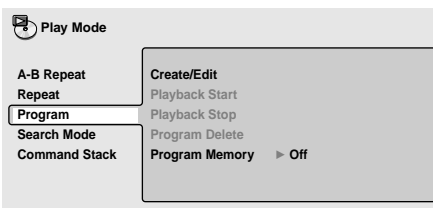

- 2 Select "Create/Edit" from the list of program options.

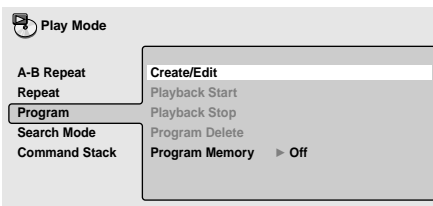

The Program edit screen that appears depends on the kind of disc loaded.

On the left side is the program list, then to the right is a list of titles (if a DVD disc is loaded) or tracks (for CDs and Video CDs). On the far right is a list of chapters (for DVD).

- 3 Select a title, chapter or track for the current step in the program list.

For a DVD disc, you can add a whole title, or a chapter within a title to the program list.

- To add a title, select the title.

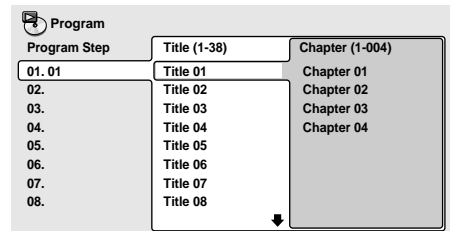

- To add a chapter, first highlight the title, then press **→** (cursor right) and select a chapter from the list.

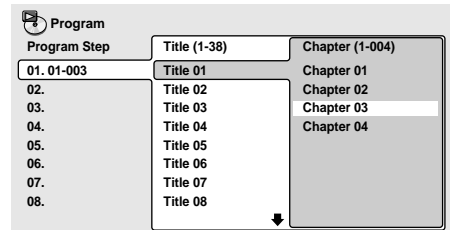

For a CD or Video CD, select a track to add to the program list.

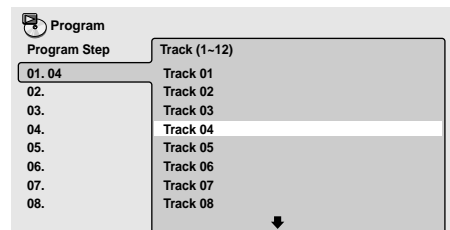

After pressing **ENTER** to select the title/chapter/track, the step number automatically moves down one.

4 Repeat step 3 to build up a program list.

A program list can contain up to 24 titles/chapters/tracks.

5 To play the program list, press ► (play).

Program play remains active until you turn off program play (see below), erase the program list (see below), eject the disc or switch off the player.

When an item on the step is currently being played, its title characters change color.



Tip

- To save your program list and exit the program edit screen without starting playback, press **PLAY MODE** or **HOME MENU**. (Don't press **RETURN** – your program list won't be saved.)
- During program play, press ►► to skip to the next program step.
- Press **CLEAR** during playback to switch off program play. Press while stopped to erase the program list.

Editing a program list

After creating a program list, you can add, delete and change steps.

1 Press **PLAY MODE** and select "Program" from the list of functions on the left.

2 Select "Create/Edit" from the list of program options.

3 To clear a step, highlight the step number and press **CLEAR**.

4 To insert a step in the middle of the program list, highlight the step where you want the new step to appear, then select a title/chapter/track to add.

After pressing **ENTER**, the new step is inserted into the list.

5 To add a step to the end of the program list, highlight the next free step then select a title/chapter/track to add.



Tip

- To save your program list and exit the program edit screen without starting playback, press **PLAY MODE** or **HOME MENU**.
- If you want to exit the program edit screen without saving the changes you made, press **RETURN**.

Other functions available from the program menu

As well as creating and editing a program list, you can start program play, cancel program play, erase the program list, and memorize a program list from the Play Mode menu.

1 Press **PLAY MODE** and select "Program" from the list of functions on the left.

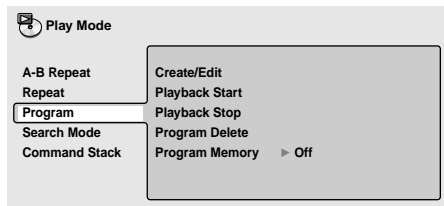

2 Select a program play function.

- **Create/Edit** – See above
- **Playback Start** – Starts playback of a saved program list
- **Playback Stop** – Turns off program play, but does not erase the program list
- **Program Delete** – Erases the program list and turns off program play
- **Program Memory** (DVD only) – Select **On** to save the program list for the disc loaded. (Select **Off** to cancel the program memory for the disc loaded)



Tip

- Program lists are saved for the DVD disc loaded. When you load a disc with a saved program list, program play is automatically turned on.
- You can save program lists for up to 24 discs. After that, the oldest one is replaced with the new one saved.

Searching a disc

You can search DVD discs by title or chapter number, by time or frame. CDs can be searched by track number, and Video CDs by track number or time.

1 Press **PLAY MODE** and select "Search Mode" from the list of functions on the left.

The search options that appear depend on the kind of disc loaded. The screen below shows the DVD search options.

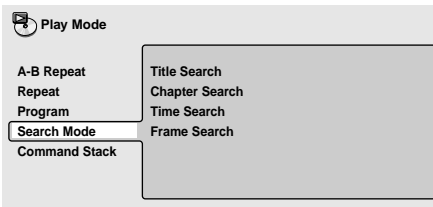

2 Select a search mode.

3 Use the number buttons to enter a title, chapter, track number, a time or a frame.

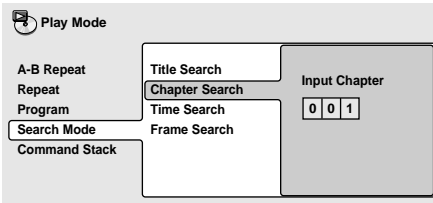

For a time search, enter the number of minutes and seconds into the currently playing title (DVD) or track (Video CD) you want playback to resume from. For example, press **4, 5, 0, 0** to have playback start from 45 minutes into the disc. For 1 hour, 20 minutes and 30 seconds, press **8, 0, 3, 0**.

4 Press **ENTER** to start playback.

Note

- The disc must be playing in order to use time search or frame search.
- Search functions are not available with Video CDs in PBC mode, or unfinalized CD-R/RW discs.
- The frame search function cannot be used with a VR format DVD-RW.

Zooming the screen

Using the zoom feature you can magnify a part of the screen by a factor of 2 or 4, while watching a DVD or Video CD.

1 During playback, use the **ZOOM** button to select the zoom factor.

- Normal
- 2x
- 4x

Normal

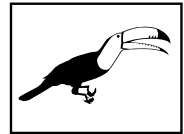

Zoom 2x

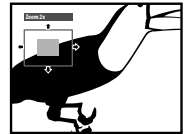

Zoom 4x

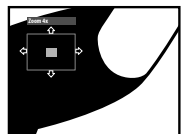

Since DVD and Video CD have a fixed resolution, picture quality will deteriorate, especially at 4x zoom. This is not a malfunction.

2 Use the cursor buttons to change the zoomed area.

You can change the zoom factor and the zoomed area freely during playback.

- If the navigation square at the top of the screen disappears, press **ZOOM** again to display it.

Note

- We do not recommend using DVD disc menus when the screen is zoomed as menu options will not be highlighted.
- If you are displaying subtitles, these will disappear when the screen is zoomed. They will reappear when you return the screen to normal.

Chapter 7

Audio Settings menu

Audio DRC

- Default setting is **Off**.

When watching Dolby Digital DVDs at low volume, it's easy to lose the quieter sounds completely—including some of the dialog. Switching Audio DRC (Dynamic Range Control) to On can help by bringing up the quieter sounds, while controlling loud peaks. How much of a difference you hear depends on the material you're listening to. If the material doesn't have wide variations in volume, you may not notice much change.

- 1 Press **HOME MENU** and select "Audio Settings" from the on-screen display.

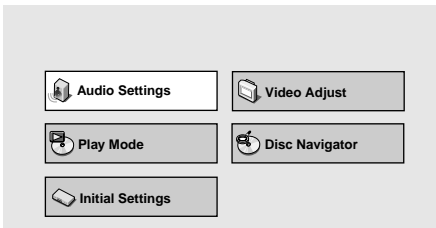

- 2 Highlight Audio DRC, then use the **←/→** (cursor left/right) buttons to change to "On" or "Off," as required.



- 3 Press **ENTER** to make the setting and exit the Audio Settings screen.

Note

- Audio DRC is only effective with Dolby Digital audio sources.
- Audio DRC is only effective through the digital output when **Digital Out** (see page 19) is set to **On**, and **Dolby Digital Out** (see page 20) is set to **Dolby Digital > PCM**.
- The effect of Audio DRC depends on your speakers and AV receiver settings.

Virtual Surround

- Default setting is **Off**.

Switch on Virtual Surround to enjoy surround sound effects from just two speakers. When you play a Dolby Digital soundtrack, TruSurround technology from SRS produces a deep, realistic 3D soundspace from a pair of stereo speakers. SRS TruSurround is a process approved by Dolby Laboratories for Virtual Dolby Digital sound.

- 1 Press **HOME MENU** and select "Audio Settings" from the on-screen display.

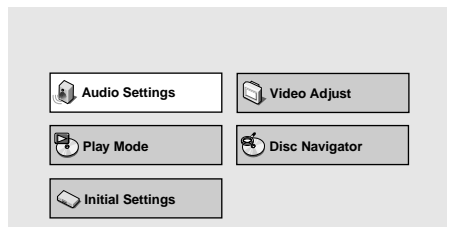

- 2 Highlight **Virtual Surround**, then use the **←/→** (cursor left/right) buttons to change to "**Dolby/SRS TruSurround**" or "**Off**" as required.



- 3 Press **ENTER** to make the setting and exit the **Audio Settings** screen.



Tip

You can also use the **SURROUND** button on the remote control to switch Virtual Surround on (**Dolby/SRS TruSurround**)/**Off**.



Note

- Virtual Surround doesn't work with DTS or 96kHz linear PCM audio through either the analog or digital outputs.
- If the player is outputting Dolby Digital or MPEG bitstream audio (in other words, no conversion to PCM), Virtual Surround has no effect on the audio from the digital output. See *Digital Audio Out settings* on page 19 for how to set up the digital output formats.
- How good the surround effect is varies with the disc.

Chapter 8

Video Adjust menu

Video Adjust

- Default setting is **Standard**.

From the Video Adjust screen you can select the standard video presentation or define presets of your own.

- 1 Press **HOME MENU** and select “Video Adjust” from the on-screen display.

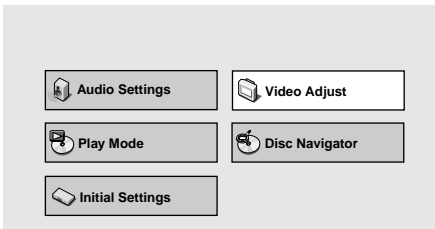

- 2 Use the **←/→** buttons (cursor left/right) to select a preset.

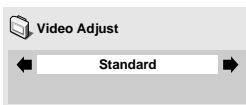

- **Standard** – Normal
 - **I. Memory1–2 / P. Memory1–2** – Use for making your own interlaced / progressive presets (see below)
- 3 Press **ENTER** to make the setting and exit the Video Adjust screen.



Note

Depending on the disc and the TV/monitor, you may not see the effect clearly.

Creating your own interlace output presets

These presets are available when the video output is set to interlace. (Use the front panel **PROGRESSIVE** button to switch between interlace and progressive video output. See also page 15)

- 1 Select one of the Memory presets (see above).
- 2 Press **↓** (cursor down) to select “Detailed Settings” then press **ENTER**.

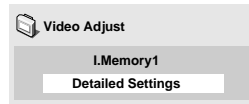

- 3 Adjust the picture quality settings.

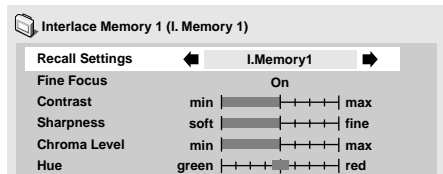

- Use the **↑/↓** buttons (cursor up/down) to select a setting.
- Use the **←/→** buttons (cursor left/right) to adjust the current setting.
- Press **DISPLAY** to switch between full and single view.
- You can change the preset number from the **Recall Settings** menu item.
You can adjust any or all of the following picture quality settings:
 - **Fine Focus** – Switch **On** to reveal greater detail (high resolution) in the picture.
 - **Contrast** – Adjusts the contrast between light and dark elements in the picture.

- **Sharpness** – Adjusts the sharpness of the mid-frequency (less detailed) elements in the picture. (This setting is only effective when **Fine Focus** is **On**.)
 - **Chroma Level** – Adjusts how saturated colors appear.
 - **Hue** – Adjusts the overall color balance between red and green. (This is only effective when the player is connected using the **VIDEO OUT** or **S-VIDEO OUT** jacks.)
- 4 Press **ENTER** to save the preset and exit the Video Adjust screen.

Creating your own progressive output presets

These presets are available when the video output is set to progressive. (Use the front panel **PROGRESSIVE** button to switch between interlace and progressive video output. See also page 15)

- 1 Select one of the Memory presets (see above).
- 2 Press **↓** (cursor down) to select “Detailed Settings” then press **ENTER**.

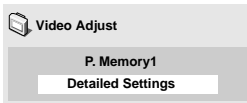

- 3 Adjust the picture quality settings.

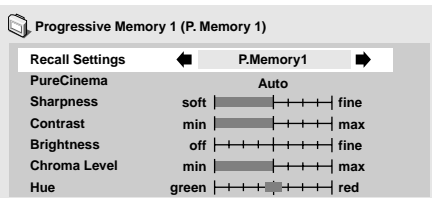

- Use the **↑/↓** buttons (cursor up/down) to select a setting.
- Use the **←/→** buttons (cursor left/right) to adjust the current setting.
- Press **DISPLAY** to switch between full and single view.
- You can change the preset number from the **Recall Settings** menu item.

You can adjust any or all of the following picture quality settings:

- **PureCinema** – When watching DVD movies, PureCinema optimizes the picture quality. The default setting is **Auto**, but if the picture appears unnatural, then set to **On** or **Off**, as appropriate.
 - **Sharpness** – Adjusts the sharpness of the mid-frequency (less detailed) elements in the picture. (This setting is only effective when **Fine Focus** is **On**.)
 - **Contrast** – Adjusts the contrast between light and dark elements in the picture.
 - **Brightness** – Adjusts the overall brightness of the picture.
 - **Chroma Level** – Adjusts how saturated colors appear.
 - **Hue** – Adjusts the overall color balance between red and green.
- 4 Press **ENTER** to save the preset and exit the Video Adjust screen.



Note

Video on a DVD discs may be either video material (originally shot on video) or film material (originally shot on film). Video material has a frame rate of 30 frames/sec. (NTSC), compared with 24 frames/sec. for film. This player converts film material to 60 frames/sec. (in progressive scan mode). PureCinema adjusts the picture so that it matches more closely the picture quality of a cinema screen.

You can see whether video on a DVD disc is film or video material by displaying the video transmission rate (see page 17). If a hash mark (#) appears next to the transmission rate display, it is film material.

Chapter 9

Advanced Setup Menu

In addition to the normal setup menu, this player includes an advanced setup menu for selecting special functions.

To access the ADV. SETUP menu

Press and hold HOME MENU button for one second.

The screen displays the Advanced Setup (ADV. SETUP) menu.

```

ADV. SETUP
▶COMMAND STACK
POWER ON START      OFF
TITLE PLAY MODE     Single
KEY LOCK            OFF
REPEAT MODE         OFF
SERIAL PORT         15 Pin
BAUD RATE           19200 bps
EXTEND TERMINAL     Standard
SYNC OUT (DURING SQ) OFF
  
```

- **COMMAND STACK**

Press **ENTER** to begin inputting Command Stacks (see page 49).

- **POWER ON START**

Automatic playback has no effect on the POWER ON START function.

Use **←/→** (cursor left/right) buttons to alternate between **ON** and **OFF** (Default setting is **OFF**).

OFF: POWER ON START function is disabled.

ON: POWER ON START function is enabled. Press **ENTER** to set this function (see page 42).

- **TITLE PLAY MODE**

Use **←/→** (cursor left/right) buttons to alternate between **Single** and **All** (Default setting is **Single**).

Single: When a NAVI command ("Return to Menu", "Search for Specific Title", "Playback from Beginning of Title", etc.) follows a title, the specified operation is performed after the title finishes playing.

All: When playback of a single DVD disc title is complete, the next title plays and so on until all titles have played.

- **KEY LOCK**

The Key Lock allows commands to be sent through the remote control and front panel buttons. However, **EXTEND TERMINAL** commands are always supported, regardless of this setting.

Use **←/→** (cursor left/right) buttons to alternate between **ON** and **OFF** (Default setting is **OFF**).

OFF: Commands from remote control and front panel buttons are allowed.

ON: Commands from remote control and front panel buttons are limited. Press **ENTER** to set the KEY LOCK (see page 44).

- **REPEAT MODE**

The Repeat command provides a way to loop playback for all or part of a DVD-Video disc. Use **←/→** (cursor left/right) buttons to select **OFF/CHAPTER/TITLE/DISC** (Default setting is **OFF**).

(When **TITLE PLAY MODE** is set to **All**, "**DISC**" appears as an additional option).

OFF: No repeat play is performed.

CHAPTER: With DVD discs, repeat play is performed for a single chapter. With CD and video CD discs, repeat play is performed of a single track.

TITLE: A single title is repeated.

DISC: All content on the disc plays back again (repeats).

• SERIAL PORT

Set the RS-232C interface to use with a 15-pin connector or 9-pin connector. Only a single type of connector may be used at a time.

Use **←/→** (cursor left/right) buttons to alternate between **15 Pin** and **9 pin** (Default setting is **15 Pin**).

15 Pin: When connecting to a PC using a Pioneer or other brand 15-pin to 9-pin cable.

9 Pin: When connecting to a PC using a commercial 9-pin cross-cable.

• BAUD RATE

Sets the Baud rate for the RS-232C interface.

Use **←/→** (cursor left/right) buttons to alternate between **19200 bps** and **9600 bps** (Default setting is **19200 bps**).

• EXTEND TERMINAL

Use the Extend Terminal to select a switch-key setting.

Use **←/→** (cursor left/right) buttons to alternate between **Standard** and **User** (Default setting is **Standard**).

Standard: The unit responds according to established standard setting (see pages 68 – 70).

User: The user selects how the external option key responds. Press **ENTER** to activate this option (see page 46).

• SYNC OUT (DURING SQ)

Use SYNC OUT to determine if a video signal is sent when the player is not playing video.

Use **←/→** (cursor left/right) buttons to alternate between **ON** and **OFF** (Default setting is **OFF**).

OFF: Video is output constantly; the sync signal is ON.

ON: Video is not output except during playback and when displaying menu screens (sync signal is off).



Note

- If the power is interrupted while saving the ADV. SETUP menu settings during video playback and the disc is still spinning, the settings are not recorded. When disconnecting the power cord, always turn off the main power switch first (the power indicator is not lit) or use the remote control to set the unit to Standby mode (the power indicator changes to orange).

Power On Start

Sets playback mode when power is turned on.

- 1 **Press and hold HOME MENU for one second.**

The screen displays the ADV. SETUP menu.

- 2 **Use the ↓ (cursor down) button to select POWER ON START.**

```

ADV. SETUP
COMMAND STACK
▶POWER ON START      OFF
TITLE PLAY MODE     Single
KEY LOCK             OFF
REPEAT MODE         OFF
SERIAL PORT          15 Pin
BAUD RATE            19200 bps
EXTEND TERMINAL     Standard
SYNC OUT(DURING SQ) OFF
  
```

- 3 **Use the ←/→ (cursor left/right) buttons to select a mode other than OFF, then press ENTER.**

When OFF is selected, Power On Start function is disabled.

```

POWER ON START

▶1. TOP MENU

2. TITLE

3. BARCODE/COMMAND STACK
  
```

- 4 **Use the ↑/↓ (cursor up/down) buttons to select 1, 2, or 3, then press ENTER.**

If "TOP MENU" is selected in step 4

Press **ENTER** again to set the Power On Start mode. This option displays the top menu when the power is turned ON.

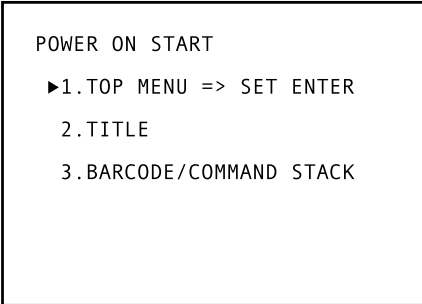

- If the loaded disc does not have a top menu, the player enters the Stop mode.
- If the ← (cursor left) button is pressed before **ENTER** is pressed, the selection is canceled.
- When **RETURN** is pressed, the option is not set and the POWER ON START screen returns to the ADV. SETUP menu.

If "TITLE" is selected in step 4

When "TITLE" flashes, use the ↑/↓ (cursor up/down) buttons or number buttons to input the desired title number.

When either **ENTER** or → (cursor right) button is pressed, the "CHAPTER" flashes. Use the ↑/↓ (cursor up/down) buttons or number buttons to input the chapter number.

Press **ENTER** again to confirm playback of a title or chapter when power is turned on.

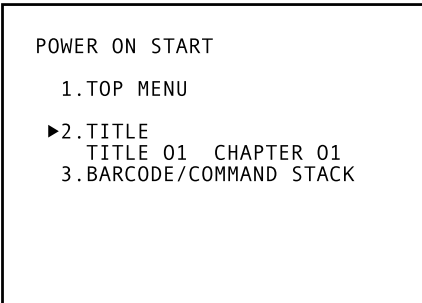

- If the ← (cursor left) button is pressed before **ENTER** is pressed, the menu returns to the TITLE option screen.
- When **RETURN** is pressed, the option is not set and the POWER ON START screen returns to the ADV. SETUP menu.

If "BARCODE/COMMAND STACK" is selected in step 4

When "GROUP" flashes, use the ↑/↓ (cursor up/down) buttons or number buttons to input the group number.

Press **ENTER** to perform the series of commands in the barcode when the power is turned on.

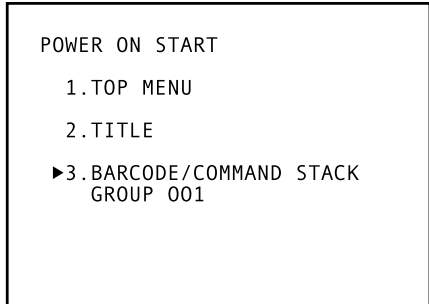

- If the ← (cursor left) button is pressed before **ENTER** is pressed, the menu returns to the BARCODE/COMMAND setting screen.
- When **RETURN** is pressed, the option is not set and the POWER ON START screen returns to the ADV. SETUP menu.



Note

The selected group is automatically set "Stack Repeat" function.

Setting to turn on player power only

When selecting a title, enter a title which is not on the disc.

Example: Enter title 99.

Key Lock

The Key Lock sets whether remote control or front panel buttons are enabled or disabled.

- 1 **Press and hold HOME MENU for one second.**

The screen displays the ADV. SETUP menu.

- 2 **Use the ↓ (cursor down) button to select KEY LOCK.**

```

ADV. SETUP
COMMAND STACK
POWER ON START      OFF
TITLE PLAY MODE     Single
▶KEY LOCK           OFF
REPEAT MODE         OFF
SERIAL PORT         15 Pin
BAUD RATE           19200 bps
EXTEND TERMINAL     Standard
SYNC OUT(DURING SQ) OFF
  
```

- 3 **Use the ←/→ (cursor left/right) buttons to toggle the setting ON then press ENTER.**

Select **OFF** to disable the Key Lock function.

```

KEY LOCK
▶1. TRAY LOCK      Off
  2. IR            Enable
  3. FRONT         Enable
  
```

- 4 **Use the ↑/↓ (cursor up/down) buttons to select an item, then the ←/→ (cursor left/right) buttons to set the item.**

- **1. TRAY LOCK (Off/On)**

With the Tray Lock **ON**, the disc tray cannot be opened by using the remote control's **OPEN/CLOSE ▲** button, the front panel's **■/▲** button, or the RS-232C Tray Open command.

- **2. IR (Enable/Disable)**

With the IR **Disable**, the unit ignores commands sent from the remote control or through barcodes.

- **3. FRONT (Enable/Disable)**

With the Front **Disable**, the unit ignores commands issued from the front panel.

- 5 **Press RETURN to cause the display to return from the KEY LOCK setting screen to the ADV. SETUP menu.**

To Temporarily Suspend KEY LOCK

The Key Lock setting is preserved even when the player's power is turned OFF. However, the Key Lock function can be temporarily suspended if necessary to change discs or modify other settings.

To temporarily suspend the Key Lock, hold down the RETURN, the ↓ (cursor down), and the ◀◀◀◀ buttons simultaneously for approximately 2 seconds.

- This release operation can be performed during playback if necessary.
- All KEY LOCK, TRAY LOCK functions are released and ordinary operations can be performed. This condition does not change any settings preserved in the player. If the power is turned off then back on, the unit reverts to the previous locked condition.
- With the KEY LOCK function temporarily suspended, hold down the **RETURN**, the **↓** (cursor down), and the **◀◀◀◀** buttons simultaneously for approximately 2 seconds. The suspended condition ends and the unit returns to a locked status.



Note

While the KEY LOCK function is temporarily suspended, even if the ADV. SETUP menu is opened and the KEY LOCK setting is changed, the temporarily suspended state continues when the ADV. SETUP menus is closed. The newly selected KEY LOCK setting only takes effect when the temporary suspension is ended.

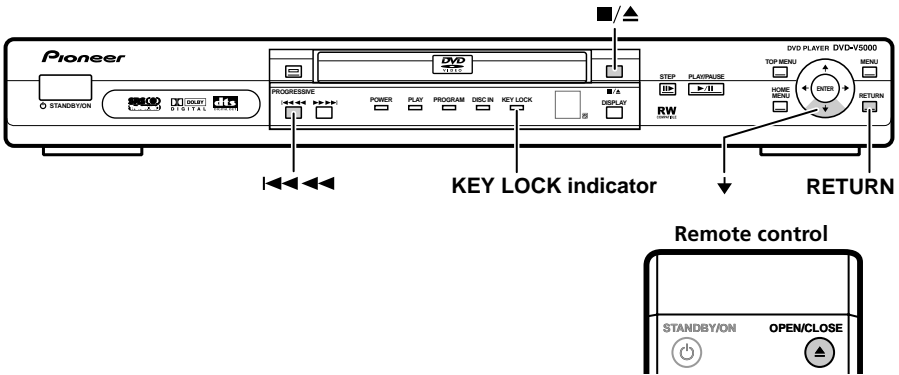

KEY LOCK Indicator Display Specifications

The status of the KEY LOCK indicator on the front panel is as follows:

KEY LOCK Setting			KEY LOCK indicator display
TRAY LOCK	IR	FRONT	
Off	Enable	Enable	[Not lighted]
On	Enable	Enable	[Not lighted] Flashes for 2 seconds when remote control's OPEN/CLOSE ▲ button is pressed or when the front panel's ■/▲ button is pressed while the unit is in the stop mode.
Off	Disable	Enable	[Lighted] Flashes for 2 seconds when remote control button is pressed.
On	Disable	Enable	[Lighted] Flashes for 2 seconds when a remote control button is pressed or when the front panel's ■/▲ button is pressed while the unit is in the stop mode.
Off	Enable	Disable	[Lighted] Flashes for 2 seconds when the front panel's control button is pressed.
On	Enable	Disable	[Lighted] Flashes for 2 seconds when the front panel's control button or the remote control's OPEN/CLOSE ▲ button is pressed.
Off	Disable	Disable	[Lighted] Flashes for 2 seconds when the front panel's control button or the remote control's OPEN/CLOSE ▲ button is pressed.
On	Disable	Disable	[Lighted] Flashes for 2 seconds when the front panel's control button or the remote control button is pressed.

Extend Terminal

Sets the function of the switch connected to the **EXT TERMINAL** (see page 68).

1 Press and hold HOME MENU for one second.

The screen displays the ADV. SETUP menu.

2 Use the ↓ (cursor down) button to select EXTEND TERMINAL.

ADV. SETUP	
COMMAND STACK	
POWER ON START	OFF
TITLE PLAY MODE	Single
KEY LOCK	OFF
REPEAT MODE	OFF
SERIAL PORT	15 Pin
BAUD RATE	19200 bps
▶ EXTEND TERMINAL	Standard
SYNC OUT (DURING SQ)	OFF

3 Use the ←/→ (cursor left/right) buttons to select "User" then press ENTER.

- Selecting "**Standard**" sets the unit to respond according to established standard setting (see pages 68 – 70).
- When "**User**" is selected, the function of the terminal switch can be set by the user.

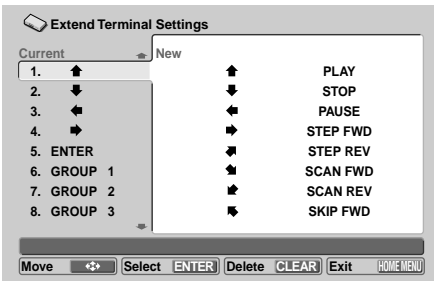

4 Press RETURN to move from the Extend Terminal Setting menu to the ADV. SETUP menu.

Press **HOME MENU** to return from Extend Terminal Setting menu to the idle condition.

Recording Settings

● Selecting "Current" Settings

- Up to 30 "Current" settings can be recorded.
- Use the ↑/↓ (cursor up/down) buttons to select the desired item.

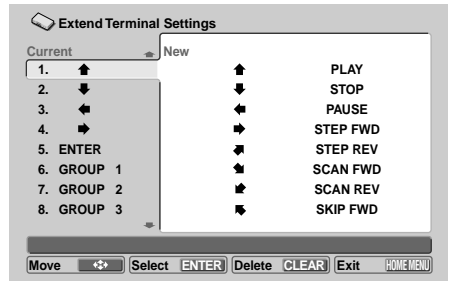

● Selecting Cursor Functions

- Eight cursor functions can be selected
- Use the ←/→/↑/↓ (cursor left/right/up/down) buttons to select then press **ENTER**. Cancellation is not possible.

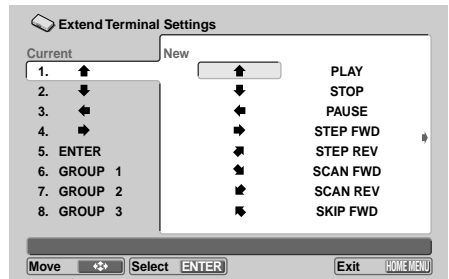

● Operation functions

- Up to 24 operation functions are available.
- Use the ←/→/↑/↓ (cursor left/right/up/down) buttons to select then press **ENTER**. Cancellation is not possible.

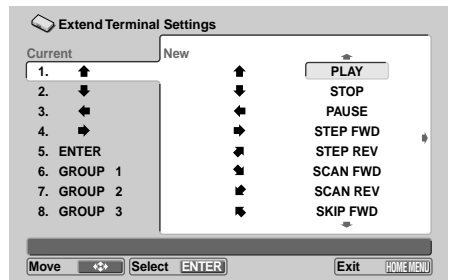

● Number Functions

- Up to 21 number functions are available.
- Use the ←/→/↑/↓ (cursor left/right/up/down) buttons to select then press **ENTER**. Cancellation is not possible.

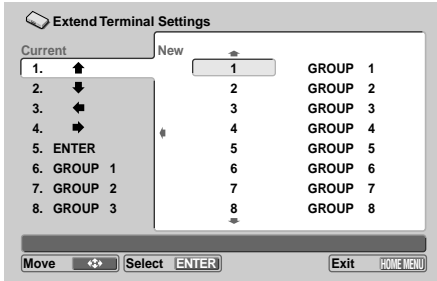

● Return To Factory Default Setting

With "Default Setting" selected, press **ENTER** to reset the unit to its factory default settings.

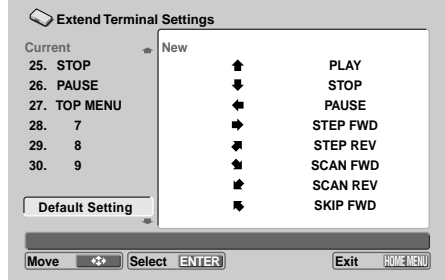

● Command Stack Functions

- Up to 27 command stack functions are available.
- Use the ←/→/↑/↓ (cursor left/right/up/down) buttons to select then press **ENTER**. Cancellation is not possible.

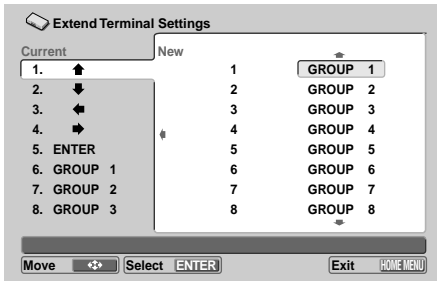

● Not-Set Function

In the Current mode, press **CLEAR** to force the non-set condition (a button does not respond even if pressed).

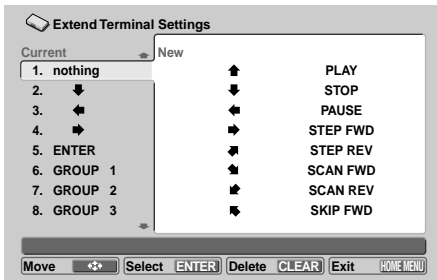

Changing The Setting

The function of the diode assignment can be changed within a range of 1 to 30 (Current).

Example:

Changing "GROUP 3" (Default) to "MENU".

- 1 Press and hold HOME MENU for one second.
The screen displays the ADV. SETUP menu.
- 2 Use ↓ button (cursor down) to select EXTEND TERMINAL.
- 3 Use ←/→ button (cursor left/right) to select "User" then press ENTER.

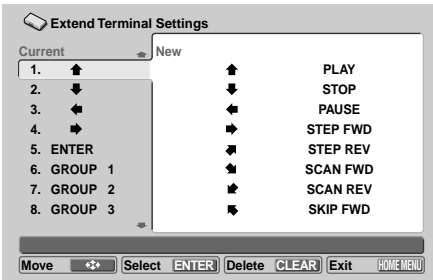

- 4 Use ↓ button (cursor down) to select "GROUP 3."

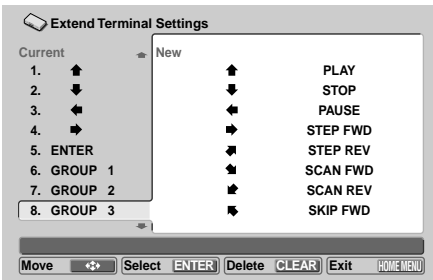

- 5 Press → button (cursor right) .

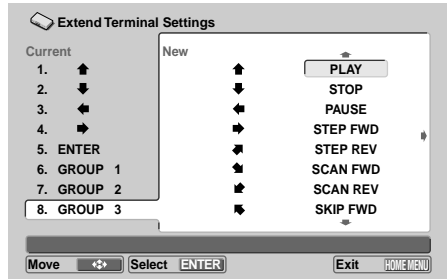

- 6 Use ↓ button (cursor down) to select MENU.

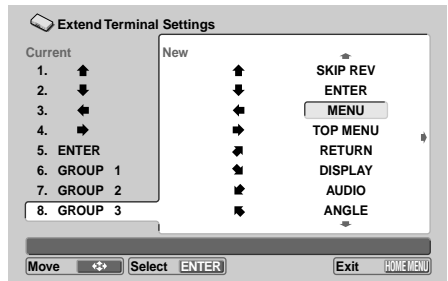

- 7 Press ENTER.

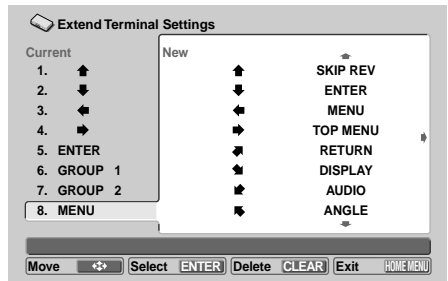

- 8 Press RETURN to move from the Extend Terminal Setting menu to the ADV. SETUP menu.
 - Press HOME MENU to return from Extend Terminal Setting menu to the idle condition.
 - Changed settings are saved within the player even if the power is disconnected.

Chapter 10

Barcode Stack / Command Stack

Barcode / Command Stack Function

The following operations can be performed within a Barcode Stack / Command Stack function:

- Pre-recording of barcode commands in player (barcode stack function).
- Remote control used to set commands when barcodes are not available or when desired commands are not available in barcodes (command stack function).
- Remote control can be used to call up recorded contents for continuous or step-by-step performance.



Important

Barcode stack and command stack functions cannot be used with video CDs or music CDs.



Note

- The player allows a maximum of 300 steps.
- The recorded data is preserved even if the power is disconnected.

Basic Operation

Basic use of barcode stack/command stack functions are as follows:

For detailed explanations of each item, refer to the page indicated after the arrow (➔):

- 1 Use the remote control to select the barcode stack/command stack setting menu**
➔ Page 50
- 2 Use a barcode reader to read barcodes and transfer the data to the player**
➔ Page 51
Use the remote control to read/transfer barcodes
➔ Pages 50 – 56
- 3 Perform repetitive input as from step 2 (Using a barcode reader to read barcodes and transfer data to the player)**
- 4 Retain data in player memory after input**
➔ Page 57
- 5 Command execution**
➔ Page 62

Advanced Functions

The barcode stack/command stack functions can be memorized in separate groups so as not to affect previously input commands. For example, recording the contents of multiple discs separately or allow multiple people to use a single player.

Record commands in a separate group from previously input contents

1 Create new group

→ Page 59

At the left side of the barcode stack/command stack input screen is the current memory group number (ex. **Group001**). This group number is necessary for performing commands. The user should make note of these for later reference.

2 Use a barcode reader to read barcodes and transmit to player

→ Page 51

The remote control unit can also be used to input the numbers.

→ Pages 50 – 56

3 Repeat step 2 in the desired playback order

4 After inputting the commands, retain the data in player memory

→ Page 57

5 Execute

→ Page 62

Select the group number as noted in step 1.



Tip

Commands already recorded in the player's memory can be reordered in one or more groups.

→ Pages 60 – 61

However, the order of commands cannot be changed.

Barcode Stack/Command Stack Settings

DVD barcode commands are recorded by the player. These commands can be called up to perform continuous or step-by-step playback. The recorded data is retained even if the power is disconnected.

Access Barcode Stack / Command Stack Menu

1 Press and hold HOME MENU for one second.

The screen displays the ADV. SETUP menu.

2 Use the ↓ (cursor down) button to select "COMMAND STACK."

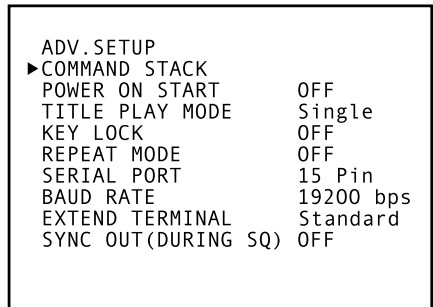

3 Press ENTER.

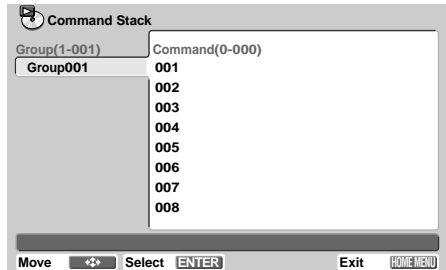

- Instructions for using this menu screen are available in the following sections.
- To set a barcode stack/command stack, use either a barcode reader (sold separately) or the remote control.

Direct setting using a barcode reader

- 1 Use the barcode reader to input the barcodes.
- 2 Transmit to player.

[Example 1]

Read in and transmit to player: "PLAY."

[Example 2]

Read in and transmit to player: "Playback chapters 5 – 12 of title 8 as subtitle 3, audio 2, angle 1."

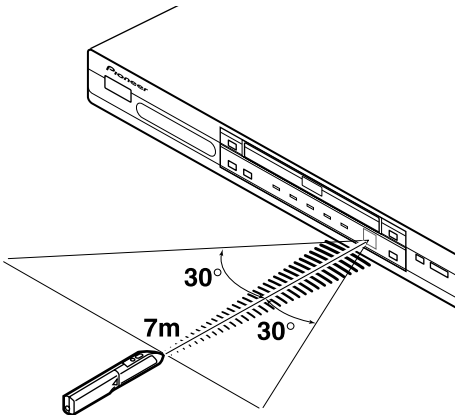

Note

- Attempting to use the remote control or player control buttons while performing barcode operations can cause the player to malfunction.
- When barcodes are used to operate the player, On Screen Displays (OSD: operation indicators such as [Play] and [Stop]) do not appear.
- Commands other than DVD barcodes are ignored.

Using the remote control unit to make settings

The remote control unit can be used to set the five operating commands **PLAY**, **PAUSE**, **STEP FWD/REV**, and **STOP**, as well as **WAIT** and **GO TO GROUP**.

Other related commands available through the remote control include Chapter Search, Chapter Play, Frame Search, and Frame Segment Play.*

* Frame Segment Play plays back a desired frame interval.

Example 1: "PLAY"

- 1 Press **ENTER** in the command input area.
- 2 Use the **↑/↓** (cursor up/down) buttons to select "COMMAND" then press **ENTER**.

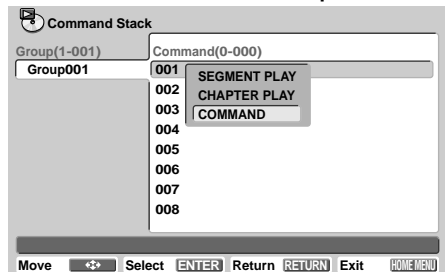

- 3 Use the **↑/↓/←/→** (cursor up/down/left/right) buttons to select "PLAY" then press **ENTER**.

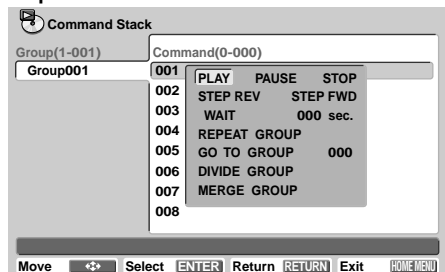

Example 2: Input wait time

- 1 Press ENTER in the command input area.
- 2 Use the ↑/↓ (cursor up/down) buttons to select "COMMAND" then press ENTER.

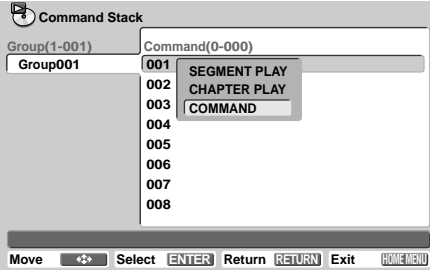

- 3 Use the ↑/↓/←/→ (cursor up/down/left/right) buttons to select "WAIT" then use the number buttons to select the desired time (wait for 'x' seconds) and press ENTER.

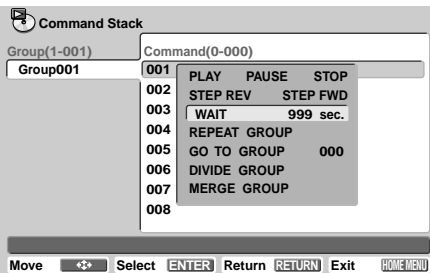

The wait length can be set up to 999 seconds.

Example 3: "Play title 3, frames 123000 to 129000"

- 1 Press ENTER in the command input area.
- 2 Use the ↑/↓ (cursor up/down) buttons to select "SEGMENT PLAY" then press ENTER.

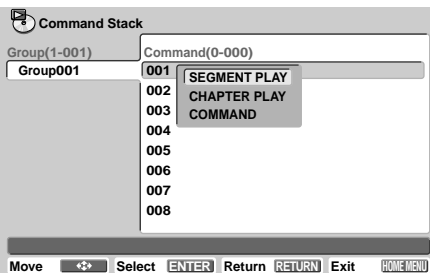

- 3 Press number button 3 then press ENTER. Title 3 is designated and frame input mode is set.
- 4 Press 1 → 2 → 3 → 0 → 0 → 0 → ENTER.
 - The starting frame number is designated.
 - To enter this sequence during playback, use the search function to find the desired starting frame.
 - It does not operate the search function, when the ↓ (cursor down) button is pressed without pressing the ENTER.
- 5 Press 1 → 2 → 9 → 0 → 0 → 0 → ENTER.
 - The ending frame number is marked.
 - During playback, press the ENTER button instead of using the number buttons from steps 4 – 5. This action causes the currently playing frame to be input as the ending frame number.
- 6 Use the ↑/↓/←/→ (cursor up/down/left/right) buttons to select "OK" then press ENTER.

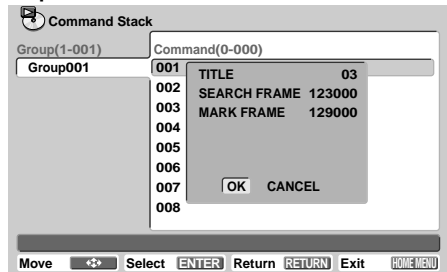
**Note**

- There must be a difference of at least 25 frames between the "SEARCH FRAME" (starting frame) and the "MARK FRAME" (ending frame). This method is unavailable for fewer than 24 frames.
- Frame search and frame segment playback cannot be used with VR formatted DVD-RW discs.

Example 4: "Play title 5, chapter 3 to 7, subtitle 3, audio 2, angle 1"

- 1 Press ENTER in the command input area.
- 2 Use the ↑/↓ (cursor up/down) buttons to select "CHAPTER PLAY" then press ENTER.

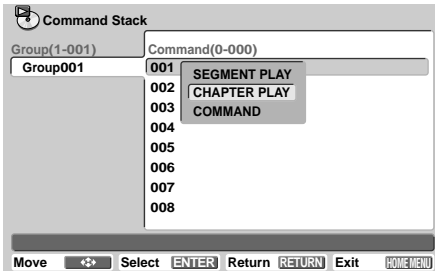

- 3 Press number button 5 then press ENTER. Title 5 is selected and the chapter input mode is set.
- 4 Press number button 3 then press ENTER. The starting chapter number is assigned.
- 5 Press number button 8 then press ENTER.

To play to the end of chapter 7, the "MARK CHAPTER" command is given a value of 1 increment higher (8).

- The ending chapter number is assigned.
- 6 Press number button 3 then press ENTER. Subtitle 3 is selected.
- 7 Press number button 2 then press ENTER. Audio 2 is selected.
- 8 Press number button 1 then press ENTER. Angle 1 is selected.
- 9 Use the ↑/↓/←/→ (cursor up/down/left/right) buttons to select "OK" then press ENTER.

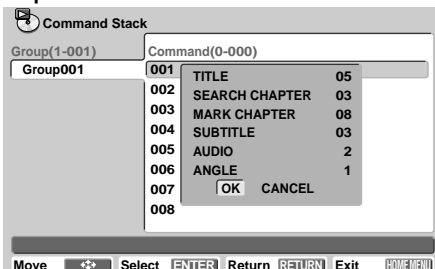
**Example 5: Select subtitle 1, audio 2, angle 3**

- 1 Press ENTER in the command input area.
- 2 Use the ↑/↓ (cursor up/down) buttons to select "SEGMENT PLAY" then press ENTER.

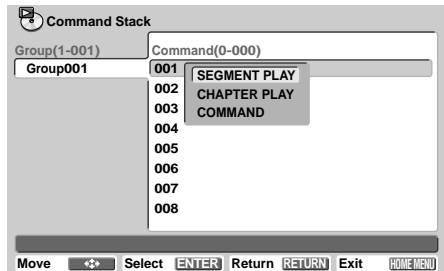

- 3 Use the ↑/↓ (cursor up/down) buttons to select "SUBTITLE" then press number button 1 followed by ENTER. Subtitle 1 is selected and the audio input mode is set.
- 4 Press number button 2 then press ENTER. Audio 2 is selected and angle input mode is set.
- 5 Press number button 3 then press ENTER. Angle 3 is assigned.
- 6 Use the ↑/↓/←/→ (cursor up/down/left/right) buttons to select "OK" then press ENTER.

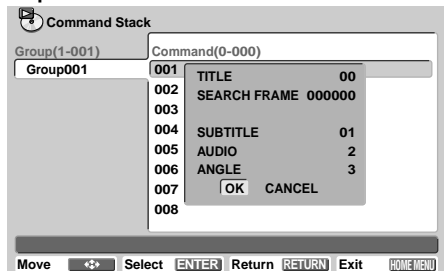

When using the play command with a starting frame and ending frame, the subtitle, audio, and angle commands cannot be set simultaneously. By inputting the subtitle, audio, and angle setting commands before the frame interval play command, the selected settings are applied to the selected playback interval.

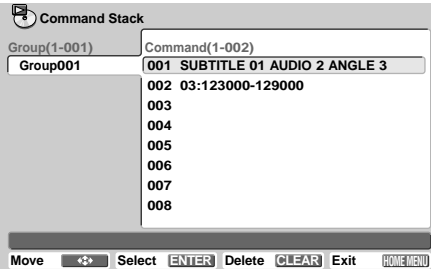

In this example, if commands are input in the order shown above then Title 3 Frames 123000 – 129000 are played back as subtitle 1, audio 2, angle 3.



Tip

With the exception of the frame interval play command, when the frame search, chapter search, or chapter interval play commands are used, the various settings designated within the commands are supported.

Example 6: To loop commands in example 3 — Play title 3, frames 123000 – 129000 — (repeat play)

- 1 Perform steps 1 through 6 in example 3.
- 2 Press ENTER after all commands noted above are entered.

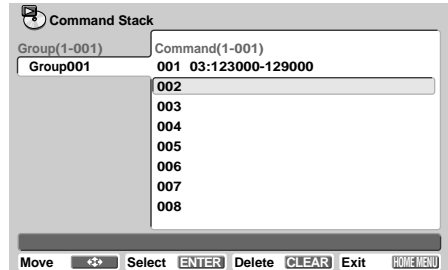

- 3 Use the ↑/↓ (cursor up/down) buttons to select "COMMAND" then press ENTER.

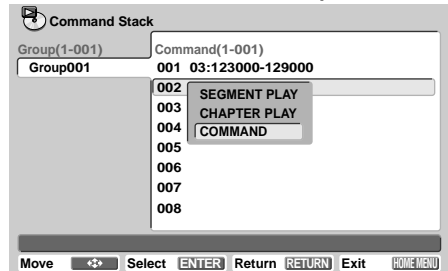

- 4 Use the ↑/↓/←/→ (cursor up/down/left/right) buttons to select "REPEAT" then press ENTER.

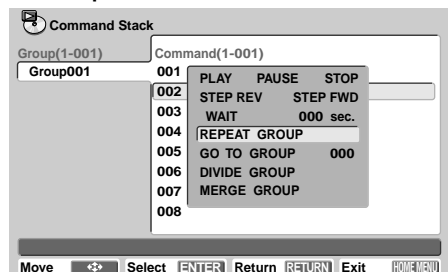

Example 7: Input command to jump to another group

- 1 Press ENTER in the command input area.
- 2 Use the ↑/↓ (cursor up/down) buttons to select "COMMAND" then press ENTER.

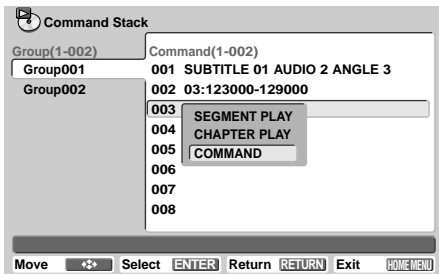

- 3 Use the ↑/↓/←/→ (cursor up/down/left/right) buttons to select "GO TO GROUP." Press a number button corresponding to the number of the group you wish to jump to then press ENTER.

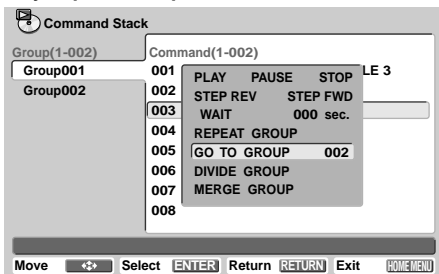

- To modify (correct) the number of a previously input GO TO GROUP command, the number must be input again.

→ Page 57 (Modify Barcode Stack / Command Stack Settings)

By using this command, multiple groups of commands can be executed in sequence.

By creating a wait-screen group to run after each group of commands is executed, the display can return to the wait screen rather than continuing.

<Conceptual Diagram>

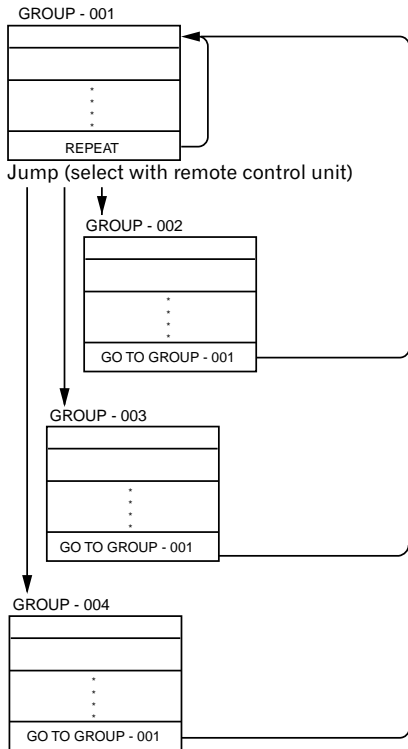

<Conceptual Diagram>

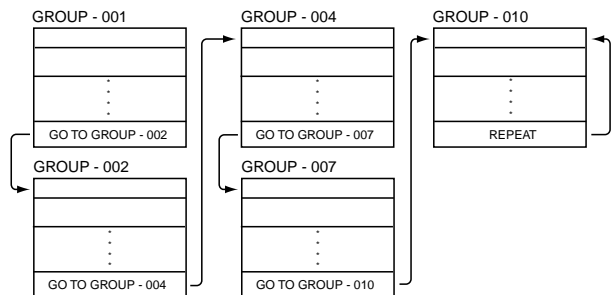

How to set SUBTITLE, AUDIO, ANGLE

SUBTITLE:

- Input 00 to cause the background to change to the GUI menu's background color and the Playback Menu to disappear.
- Input 01 – 32 to display the corresponding subtitle.
- Input 33 to hide any subtitles when playback starts.
- Input 34 to restore the Playback Menu previously hidden with the 00 command.
- Input 99 to retain the previous status. Use this command to preserve the SUBTITLE setting while changing other settings.
- Numbers 35 – 98 are not supported.

AUDIO

- Input 0 to playback video without audio.
- Input 1 – 8 to select the corresponding audio for playback.
- Input 9 to preserve the previous status.

ANGLE

- Input 1 – 8 to select the corresponding angle for playback.
- Input 9 to preserve the previous status.
- Input 0 to select angle 9 for playback.



Note

- When a command is used to "preserve the previous status," an asterisk (*) appears on the input screen.
- If an input number does not correspond to a number actually recorded on the disc, the command stack is ignored.

Performing chapter search or frame search only

At a MARK CHAPTER or MARK FRAME item, do not enter a setting but press ENTER at the "OK" message.

After performing search, the player displays a still image.



Note

The frame search function cannot be used on DVD-VR discs.

To change numbers during input

Use the number buttons to input the correct number (including "0") again.

To return to the above setting location, press the **↑** (cursor up) button.

To cancel an operation during input

Press RETURN.

Retain (Preserve) Barcode Stack/Command Stack Settings

- 1 Press HOME MENU or RETURN with the group or command selected.
- 2 Use the ←/→ (cursor left/right) buttons to select "OK" then press ENTER.

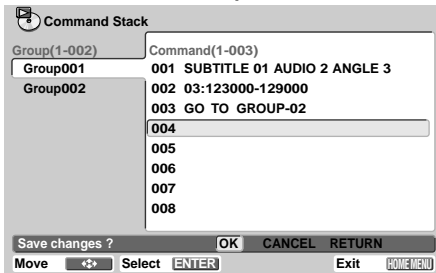

Note

Settings are not be saved if ENTER is pressed when "CANCEL" is highlighted.

Erase Barcode Stack/Command Stack Settings

- 1 Use the ↑/↓ (cursor up/down) buttons to select the step to be erased.

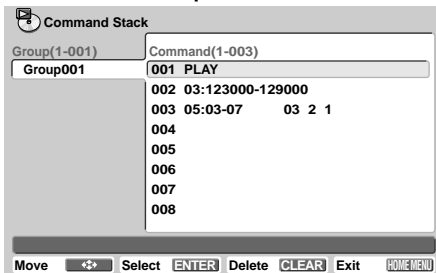

- 2 Press CLEAR.

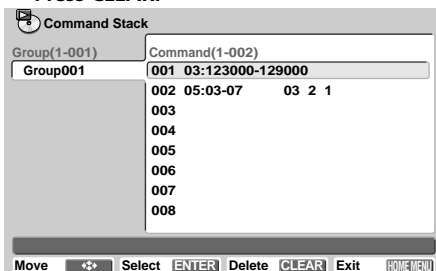

The selected step is erased and the following steps increment up.

- 3 Save the change.



Important

During the save step after an erase operation, the step will not be erased if ENTER is pressed on "CANCEL." The erasure is confirmed and recorded only when ENTER is pressed on "OK."

Modify Barcode Stack/Command Stack Settings

Example: To change audio setting from 2 to 1 on step 003

- 1 Use the ↑/↓ (cursor up/down) buttons to select step 003 then press ENTER.

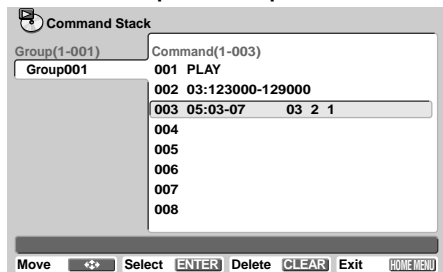

- 2 Use the ↑/↓ (cursor up/down) buttons to select "STACK CORRECTING" then press ENTER. "STACK CORRECTING" appears only after a step has been entered.

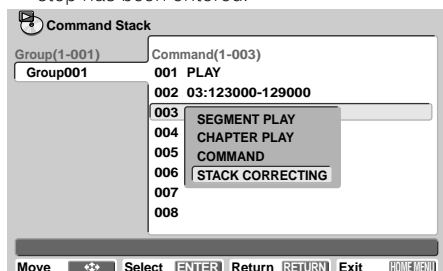

- Press ENTER or the ↓ (cursor down) button 4 times to select "AUDIO." Press the number button 1 followed by ENTER.

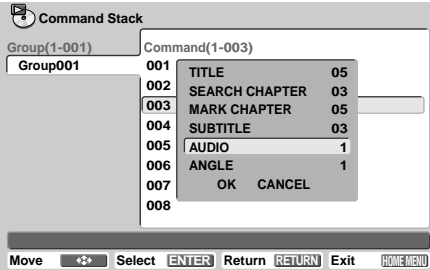

- Use the ↑/↓/←/→ (cursor up/down/left/right) buttons to select "OK" then press ENTER.

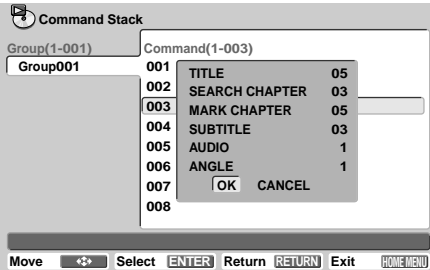

- Save the change.



Important

Changes are only saved when "OK" is highlighted and **ENTER** is pressed. If "CANCEL" is highlighted when the **ENTER** is pressed, all corrections are lost.

Add Barcode Stack/Command Stack Settings

- Use the ↑/↓ (cursor up/down) buttons to select where the new command will be inserted.
- Press ENTER.
- Build a Barcode Stack/Command Stack according to the previous instructions (Pages 50 – 56).
- Save the addition.



Important

Changes are only saved when "OK" is highlighted and **ENTER** is pressed. If "CANCEL" is highlighted when the **ENTER** is pressed, all corrections are lost.

Grouping Barcode Stacks and Command Stacks

Barcode stacks and command stacks can be assembled into groups. By creating multiple groups, their commands can be saved together. When executed, stacks can be performed as a single series of commands, or a single step can be selected from a group for independent execution. Grouped stack can also be divided and/or steps erased if desired.

Create a Group

- 1 Highlight GROUP and press ENTER.
- 2 Use the ↑/↓ (cursor up/down) buttons to select "CREATE GROUP."

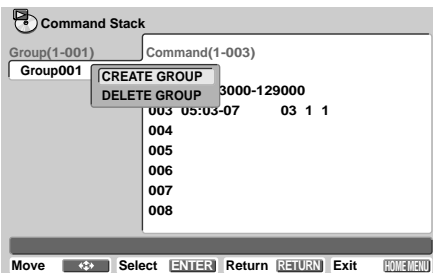

- 3 Press ENTER.

The display changes to the input screen for the first step of the next group.

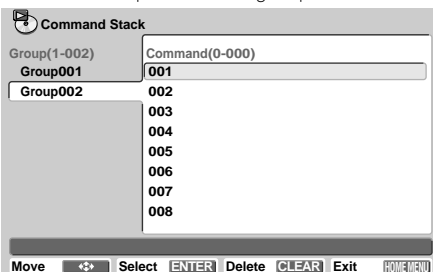

From this point, you can select the next barcode stack/command stack step for the group.

Switch Between Groups

Use the ↑/↓ (cursor up/down) buttons to highlight the desired group.

- Press the ↓ (cursor down) button to move to the next group.
- Press the ↑ (cursor up) button to move to the previous group.

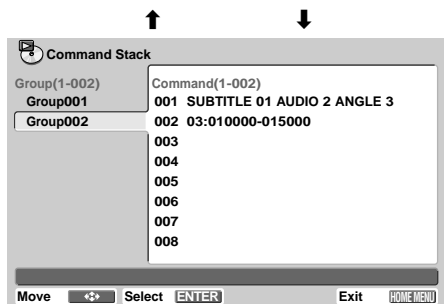
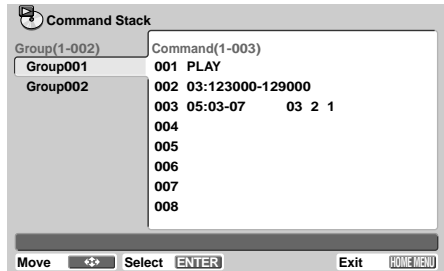

Delete Groups

- 1 Use the ↑/↓ (cursor up/down) buttons to select the group to be deleted.

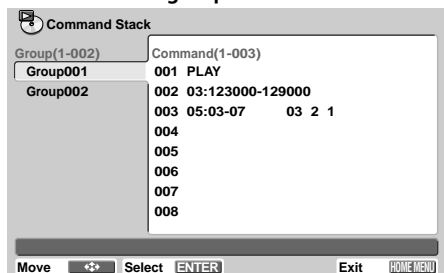

- 2 Press ENTER then use the ↑/↓ (cursor up/down) buttons to select "DELETE GROUP."

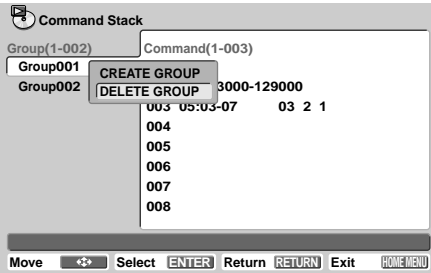

3 Press ENTER.

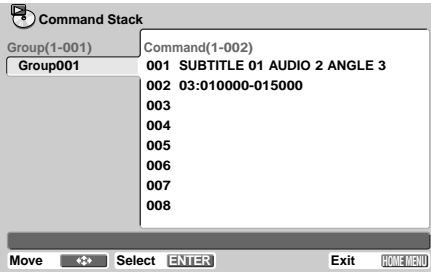

4 Save the change.



Important

Deletions are only saved when "OK" is highlighted and ENTER is pressed. If "CANCEL" is highlighted when the ENTER is pressed, all deletions are ignored.

Divid a Previously Input Group

1 Use the ↑/↓ (cursor up/down) buttons to select the group to be divided.

Highlight the first step of the group to be separated.

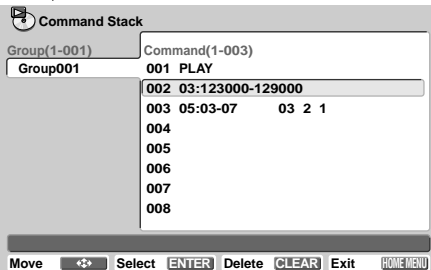

2 Press ENTER.

3 Use the ↑/↓ (cursor up/down) buttons to select "COMMAND" then press ENTER.

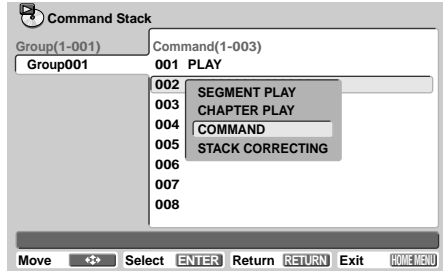

4 Use the ↑/↓/←/→ (cursor up/down/left/right) buttons to select "DIVIDE GROUP."

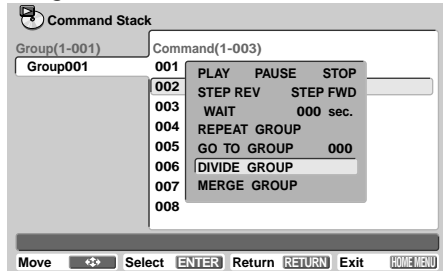

5 Press ENTER.

The group is divided and a new group is created.

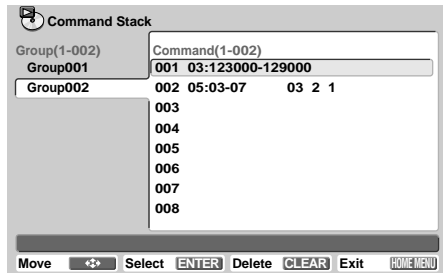

The display changes to the barcode stack/ command stack input menu at the first step of the newly created group.

6 Save the change.



Important

Group splits are only saved when "OK" is highlighted and ENTER is pressed. If "CANCEL" is highlighted when the ENTER is pressed, all divisions are removed.

Merge Groups

- 1 Use the **↑/↓** (cursor up/down) buttons to select the next available step.
The group divider is here.

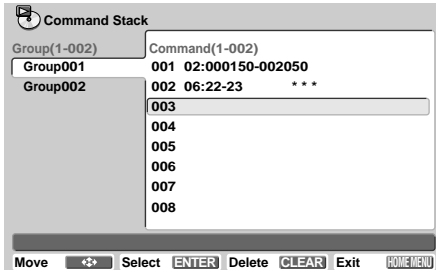

- 2 Press **ENTER**.

- 3 Use the **↑/↓** (cursor up/down) buttons to select "COMMAND" then press **ENTER**.

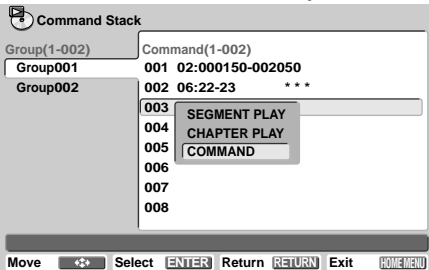

- 4 Use the **↑/↓** (cursor up/down) buttons to select "MERGE GROUP."

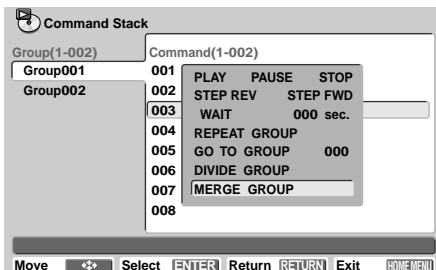

- 5 Press **ENTER**.

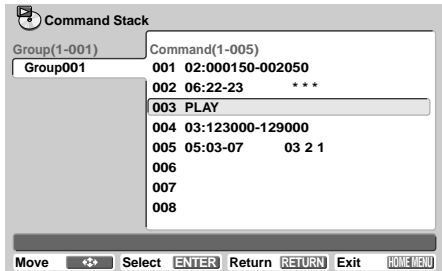

- The group divider is erased and the previous group is merged with the following group.
- The group number is adjusted for each subsequent group.

- 6 Save the change.



Important

Merges are only saved when "OK" is highlighted and **ENTER** is pressed. If "CANCEL" is highlighted when the **ENTER** is pressed, all merges are reversed.



Note

If the power is interrupted while saving a barcode stack/command stack during video playback and the disc is still spinning, the settings are not recorded.

When disconnecting the power cord, always turn off the main power switch first (the power indicator is not lit) or use the remote control to set the unit to Standby mode (the power indicator changes to orange).

Execute a Barcode Stacks / Command Stacks

Execute a Group

- 1 Load the disc.
- 2 Press PLAY MODE and select "Command Stack."

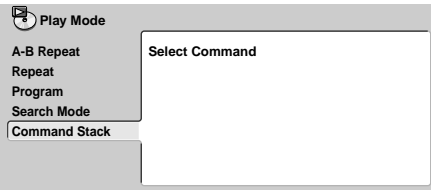

- 3 Select "Select Command" and press ENTER.

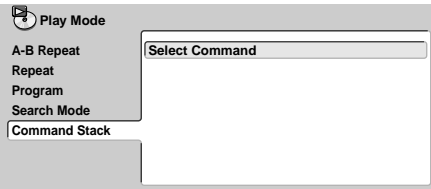

- 4 Use the ↑/↓ (cursor up/down) buttons to select the number of the command group you wish to execute.

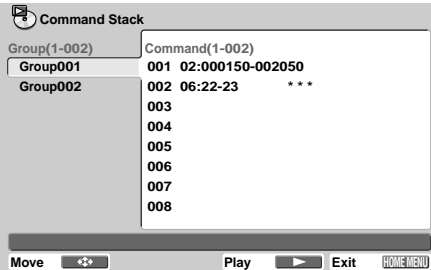

- 5 Press PLAY ►. The set group begins executing.

Note

When playing VR formatted DVD-RW discs, steps including frame search or frame segment play commands are ignored and operation skips to the next step.

Execute a Step within a Group

- 1 Load the disc.
- 2 Press PLAY MODE and select "Command Stack."
- 3 Select "Select Command" and press ENTER.
- 4 Use the ↑/↓ (cursor up/down) buttons to select the number of the command group you wish to execute and press ENTER or the → (cursor right) button.
- 5 Use the ↑/↓ (cursor up/down) buttons to select the number of the step you wish to execute.

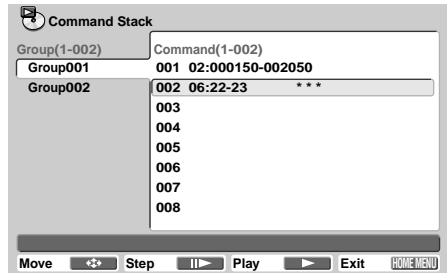

- 6 Press PLAY ► or ENTER.
 - The set group and step begin executing.
 - If the ►/► button is pressed instead of PLAY ►, execution proceeds one step at a time. To proceed to the next step, press the ►| button. To return to the previous step, press the ◀◀ button.
 - If "Stack Repeat" is selected in PLAY MODE, execution of the group plays/loops repeatedly.

Important

Some titles do not support calling up and executing steps.

Example: Titles without on-screen chapters, time displays or that do not support search functions will reject a search command.

Chapter 11

Additional information

Taking care of your player and discs

Handling discs

When holding discs of any type, take care not to leave fingerprints, smears or scratches on the disc surface. Hold the disc by an edge or pinched between the center hole and an edge. Damaged or dirty discs can affect playback performance. Take care also not to scratch the label side of the disc. Although not as fragile as the recorded side, scratches can still result in a disc becoming corrupted or unusable. Should a disc become marked with fingerprints, dust, etc., clean using a soft, dry cloth, wiping the disc lightly from the center to an outside edge as shown in the diagram below.

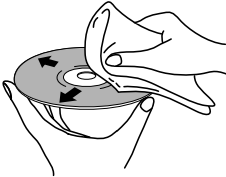

Wipe lightly from the center of the disc using straight strokes.



Don't wipe the disc surface using circular strokes.

If necessary, use a cloth soaked in alcohol, or a commercially available CD/DVD cleaning kit to clean a disc more thoroughly. Never use benzene or any other cleaning agents, including products designed for cleaning vinyl records.

Storing discs

Although CDs and DVD discs are more durable than vinyl records, you should still handle and store discs carefully. When not in use, return the disc to its jewel case or jacket and store vertically. Avoid leaving discs in excessively cold, humid, or hot environments (including in direct sunlight).

Do **NOT** place paper stickers onto the disc. When writing on a disc, do **NOT** mark with a pencil, ball-point pen, or other sharp-tipped writing instrument that may damage a disc.

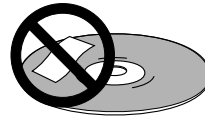

For more detailed care information see the instructions that come with discs.

Do not load more than one disc into the player at a time.

Discs to avoid

Discs spin at high speeds inside the player. Discs that are cracked, chipped or warped can damage or possibly destroy the player's optics.

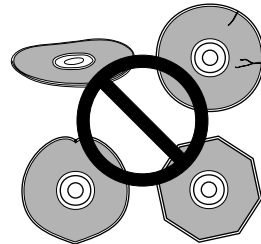

This player is designed for use with conventional, circular discs only. Shaped discs such as business card sized are not recommended for this product. Pioneer disclaims all liability arising in connection with the use of shaped discs.

Cleaning the unit's exterior

- Use a polishing cloth or dry cloth to wipe off dust and dirt. If the surfaces are very dirty, wipe with a soft cloth dipped in some neutral cleanser diluted five or six times with water. Wring out the cloth well before wiping then use a dry cloth to wipe again.
- Do not use furniture wax or cleaners. Never use thinners, benzine or insecticide sprays or other chemicals on or near this unit since these chemicals can corrode the surfaces.
- If you use a chemically-treated cleaning cloth, read the instructions carefully before use. These cloths may leave smear marks on half-mirror finish surfaces; if this happens, finish with a dry cloth.
- Unplug the unit when cleaning.

Cleaning the pickup lens

The DVD player's lens should not become dirty in normal use, but if for some reason it should malfunction due to dust or dirt, consult your nearest Pioneer-authorized service center. Although lens cleaners for CD players are commercially available, we do not recommend using them since some may damage the lens.

Problems with condensation

Condensation may form inside the player if it is brought into a warm room from outside, or if the temperature of the room rises quickly. Although the condensation won't damage the player, it may temporarily impair its performance. For this reason you should allow it to adjust to the warmer/cooler temperature for approximately an hour before switching on the unit.

Hints on installation

We want you to enjoy using this product for years to come, so please bear in mind the following points when choosing a suitable location for it:

Do...

- Use in a well-ventilated room.
- Place on a solid, flat, level surface, such as a table, shelf or stereo rack.

Don't...

- Place where exposed to high temperatures or humidity, including near radiators and other heat-generating appliances.
- Place on a window sill or other place where the player will be exposed to direct sunlight.
- Use in an excessively dusty or damp environment.
- Place directly on top of an amplifier, or other component in your playback system that becomes hot in use.
- Use near a television or monitor as you may experience interference-especially if the television uses an indoor antenna.
- Use close to a room where the player may be exposed to smoke or steam.
- Use on a thick rug or carpet or cover with cloth-this may prevent proper cooling of the unit.
- Place on an unstable surface, or one that is not large enough to support all four of the unit's supports.

Moving the player

If you need to move the player, first press **STANDBY/ON** on the front panel to turn the player off. Wait for **POWER** indicator to turn orange, then unplug the power cable. Never lift or move the unit when a disc is playing or is still spinning as this shift may cause damage.

Power cable caution

Handle the power cable by the plug part. Do not pull out the plug by tugging the cable. Never touch the power cable when your hands are wet as this could cause a short circuit or electrical shock. Do not place anything on the power cord that could pinch or damage the cable in any other way. Never make a knot in the cable or tie it in a bundle with other cables. Power cables should be routed so that they are not likely to be stepped on. A damaged power cable can cause a fire or give an electric shock. Inspect the cord periodically for damage or wear. If it needs to be replaced, ask your nearest Pioneer authorized service center or your dealer for a replacement.

Screen sizes and disc formats

DVD-Video discs come in several different screen aspect ratios, ranging from TV programs, which are generally 4:3, to CinemaScope widescreen movies, with an aspect ratio of up to about 7:3. Televisions, too, come in different aspect ratios; "standard" 4:3 and widescreen 16:9.

Widescreen TV users

For Widescreen TVs, set the player's **TV Screen** option (page 21) to the widescreen aspect ratio **16:9 (Wide)**.

When watching discs with the standard 4:3, use the TV controls to select how the picture appears. Your TV may offer various zoom and stretch options; see the operating instructions provided with your TV or monitoring system. Please note that some movie aspect ratios are wider than 16:9. Thus, although the picture is shown in widescreen, these video clips play in a "letter box" style with black bars at the top and bottom of the screen.

Standard TV users

If you have a standard TV, the **TV Screen** setting (page 21) of this player should be set to **4:3 (Letter Box)** or **4:3 (Pan&Scan)**, depending on you preferences.

4:3 (Letter Box), widescreen discs are shown with black bars above and below the picture.



4:3 (Pan&Scan), widescreen discs are shown with the left and right sides cropped. While the picture appears larger, the visible area is actually reduced.



Please note that many widescreen productions override the player's settings so that the disc is shown in the author's chosen aspect ratio, regardless of the setting.



Note

Using the 16:9 (Wide) setting with a standard 4:3 TV/monitor, or either of the 4:3 settings with a widescreen TV, results in a distorted picture.

Titles, Chapters and Tracks

DVD discs are generally divided into one or more titles. Titles may be further subdivided into chapters.

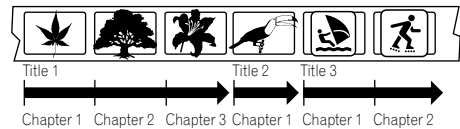

CDs and Video CDs are divided into tracks.

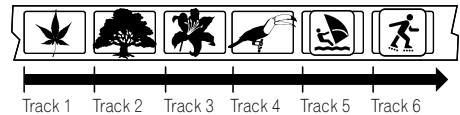

DVD-Video Regions

DVD-Video region marks designate compatible playback area(s) for each DVD-Video disc. DVD players also have a region mark, usually found on the rear panel. Discs and players with different regions are incompatible.

Discs marked **ALL** are compatible with this player model.

The diagram below shows the various DVD regions of the world.

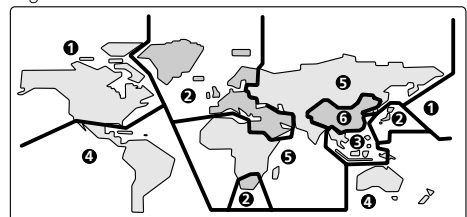

Play Duration & Power-On Time Display

This unit is capable of displaying how long the unit has been playing discs (accumulative) and how long the power has been turned ON.

The play time and power ON time can be displayed as described below.

- 1 Press and hold **DISPLAY** on the front panel of the main unit before turning power ON then press **⏻ STANDBY/ON**. The following is an example:

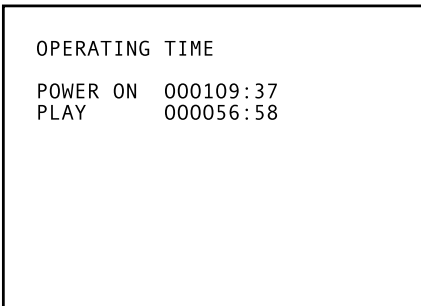

- Power on time: 109 hours 37 minutes
 - Total play time: 56 hours 58 minutes
- 2 When an operation (playback from the remote, for example) is performed, the time information disappears and normal operation begins.



Note

- Time is measured by the CPU clock thus the information includes up to a 2% error margin.
- This feature is incapable of resetting the total play time or power ON time to a working condition or maintenance timing of 0.

Confirm the Firmware Version

- 1 Press **HOME MENU** and select "Initial Settings" from the on-screen display.

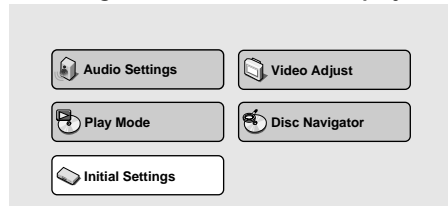

- 2 Select "Option" and press **DISPLAY**. The firmware version appears in the window.

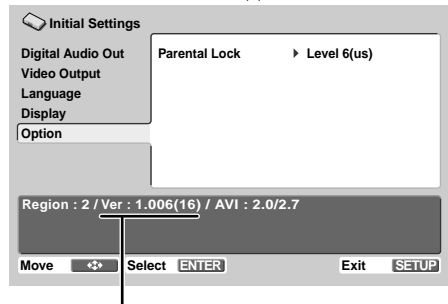

Here, the "Ver: 1.006" indicates the version of firmware; "(16)" indicates the capacity of the Flash Memory (16 Mbit) being used.

Resetting the Player

Use this procedure to reset all the player's settings to the factory default.

- 1 Switch the player into Standby mode.
- 2 Using the front panel buttons, hold down **⏪⏪⏪** and press **⏻ STANDBY/ON** to turn the player back on. The settings have returned to the defaults.

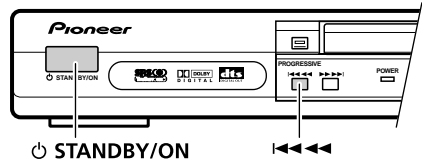

Language Code List

Language (Language code letter), **Language code**

Japanese (ja), 1001	Bhutani (dz), 0426	Kirghiz (ky), 1125	Sinhalese (si), 1909
English (en), 0514	Esperanto (eo), 0515	Latin (la), 1201	Slovak (sk), 1911
French (fr), 0618	Estonian (et), 0520	Lingala (ln), 1214	Slovenian (sl), 1912
German (de), 0405	Basque (eu), 0521	Loathian (lo), 1215	Samoa (sm), 1913
Italian (it), 0920	Persian (fa), 0601	Lithuanian (lt), 1220	Shona (sn), 1914
Spanish (es), 0519	Finnish (fi), 0609	Latvian (lv), 1222	Somali (so), 1915
Chinese (zh), 2608	Fiji (fj), 0610	Malagasy (mg), 1307	Albanian (sq), 1917
Dutch (nl), 1412	Faroese (fo), 0615	Maori (mi), 1309	Serbian (sr), 1918
Portuguese (pt), 1620	Frisian (fy), 0625	Macedonian (mk), 1311	Siswati (ss), 1919
Swedish (sv), 1922	Irish (ga), 0701	Malayalam (ml), 1312	Sesotho (st), 1920
Russian (ru), 1821	Scots-Gaelic (gd), 0704	Mongolian (mn), 1314	Sundanese (su), 1921
Korean (ko), 1115	Galician (gl), 0712	Moldavian (mo), 1315	Swahili (sw), 1923
Greek (el), 0512	Guarani (gn), 0714	Marathi (mr), 1318	Tamil (ta), 2001
Afar (aa), 0101	Gujarati (gu), 0721	Malay (ms), 1319	Telugu (te), 2005
Abkhazian (ab), 0102	Hausa (ha), 0801	Maltese (mt), 1320	Tajik (tg), 2007
Afrikaans (af), 0106	Hindi (hi), 0809	Burmese (my), 1325	Thai (th), 2008
Amharic (am), 0113	Croatian (hr), 0818	Nauru (na), 1401	Tigrinya (ti), 2009
Arabic (ar), 0118	Hungarian (hu), 0821	Nepali (ne), 1405	Turkmen (tk), 2011
Assamese (as), 0119	Armenian (hy), 0825	Norwegian (no), 1415	Tagalog (tl), 2012
Aymara (ay), 0125	Interlingua (ia), 0901	Occitan (oc), 1503	Setswana (tn), 2014
Azerbaijani (az), 0126	Interlingue (ie), 0905	Oromo (om), 1513	Tonga (to), 2015
Bashkir (ba), 0201	Inupiak (ik), 0911	Oriya (or), 1518	Turkish (tr), 2018
Byelorussian (be), 0205	Indonesian (in), 0914	Panjabi (pa), 1601	Tsonga (ts), 2019
Bulgarian (bg), 0207	Icelandic (is), 0919	Polish (pl), 1612	Tatar (tt), 2020
Bihari (bh), 0208	Hebrew (iw), 0923	Pashto, Pushto (ps), 1619	Twi (tw), 2023
Bislama (bi), 0209	Yiddish (ji), 1009	Quechua (qu), 1721	Ukrainian (uk), 2111
Bengali (bn), 0214	Javanese (jw), 1023	Rhaeto-Romance (rm), 1813	Urdu (ur), 2118
Tibetan (bo), 0215	Georgian (ka), 1101	Kirundi (rn), 1814	Uzbek (uz), 2126
Breton (br), 0218	Kazakh (kk), 1111	Romanian (ro), 1815	Vietnamese (vi), 2209
Catalan (ca), 0301	Greenlandic (kl), 1112	Kinyarwanda (rw), 1823	Volapuk (vo), 2215
Corsican (co), 0315	Cambodian (km), 1113	Sanskrit (sa), 1901	Wolof (wo), 2315
Czech (cs), 0319	Kannada (kn), 1114	Sindhi (sd), 1904	Xhosa (xh), 2408
Welsh (cy), 0325	Kashmiri (ks), 1119	Sangho (sg), 1907	Yoruba (yo), 2515
Danish (da), 0401	Kurdish (ku), 1121	Serbo-Croatian (sh), 1908	Zulu (zu), 2621

Country Code List

Country, **Country code**, **Country code letter**

Argentina, 0118 , ar	Hong Kong, 0811 , hk	Philippines, 1608 , ph
Australia, 0121 , au	India, 0914 , in	Portugal, 1620 , pt
Austria, 0120 , at	Indonesia, 0904 , id	Russian Federation, 1821 , ru
Belgium, 0205 , be	Italy, 0920 , it	Singapore, 1907 , sg
Brazil, 0218 , br	Japan, 1016 , jp	Spain, 0519 , es
Canada, 0301 , ca	Korea, Republic of, 1118 , kr	Sweden, 1905 , se
Chile, 0312 , cl	Malaysia, 1325 , my	Switzerland, 0308 , ch
China, 0314 , cn	Mexico, 1324 , mx	Taiwan, 2023 , tw
Denmark, 0411 , dk	Netherlands, 1412 , nl	Thailand, 2008 , th
Finland, 0609 , fi	New Zealand, 1426 , nz	United Kingdom, 0702 , gb
France, 0618 , fr	Norway, 1415 , no	USA, 2119 , us
Germany, 0405 , de	Pakistan, 1611 , pk	

Extend Terminal

To activate a function, create a switch contact with an electrical ground (Pin 1). Refer to page 71 "Interface Connector" to verify pin (Pin 6 through Pin 13) and terminal (SW1 – SW8) assignments. There are three (SW) functions in the **EXTEND TERMINAL CONTROL**.

1 To recall Barcode/Command Stacks and execute

The function, STACK GROUP 1 to STACK GROUP 27, is similar to a combination of remote control buttons to recall and execute a stack.

2 To execute the function as a remote control command

The function acts in the same manner as remote control the buttons (ENTER, PLAY, STOP, etc.) excluding SCAN FWD/REV.

When the remote control's SCAN buttons (◀◀, ▶▶) are pressed and released, the scan operation continue. However, the SCAN FWD/SCAN REV keys on the Extend Terminal operate only while held down; the operation stops when the keys are released.

3 To execute as an advanced remote control button

Advanced remote control commands such as numbers from 10 to 20 may be sent as a switch control command.

Function Assignment

Create a Circuit Controller or a Diode Matrix Circuit (refer to the table below).

Diode Assignment List (Standard setting and User default setting)

No.	SW1 ↑	SW2 ↓	SW3 ←	SW4 →	SW5 ENTER	SW6 X	SW7 Y	SW8 Z	Function
1	X								↑
2		X							↓
3			X						←
4				X					→
5					X				ENTER
6						X			STACK GROUP1
7							X		STACK GROUP2
8								X	STACK GROUP3
9		X						X	10
10			X					X	11
11				X				X	12
12	X	X							OPEN/CLOSE
13			X	X					DISPLAY
14	X					X			1
15		X				X			2
16			X			X			3
17				X		X			4
18	X						X		5
19		X					X		6
20	X			X					↗
21		X		X					↘
22		X	X						↙
23	X		X						↖

No.	SW1 ↑	SW2 ↓	SW3 ←	SW4 →	SW5 ENTER	SW6 X	SW7 Y	SW8 Z	Function
24					X	X			PLAY
25					X		X		STOP
26					X			X	PAUSE
27							X	X	TOP MENU
28			X				X		7
29				X			X		8
30	X							X	9
31					X	X	X		STEP FWD
32					X	X		X	STEP REV
33					X		X	X	RETURN
34	X	X	X						SCAN FWD
35	X	X		X					SCAN REV
36	X		X	X					SKIP FWD
37		X	X	X					SKIP REV
38			X			X	X		STACK GROUP4
39				X		X	X		STACK GROUP5
40	X	X					X		STACK GROUP6
41	X	X				X			13
42	X		X			X			14
43	X			X		X			15
44		X	X			X			16
45		X		X		X			17
46			X	X		X			18
47	X					X	X		19
48		X				X	X		20
49	X		X				X		STACK GROUP7
50	X			X			X		STACK GROUP8
51		X	X				X		STACK GROUP9
52		X		X			X		STACK GROUP10
53			X	X			X		STACK GROUP11
54	X						X	X	STACK GROUP12
55		X					X	X	STACK GROUP13
56			X				X	X	STACK GROUP14
57				X			X	X	STACK GROUP15
58	X	X						X	STACK GROUP16
59	X		X					X	STACK GROUP17
60	X			X				X	STACK GROUP18
61		X	X					X	STACK GROUP19
62		X		X				X	STACK GROUP20
63			X	X				X	STACK GROUP21
64	X					X		X	STACK GROUP22
65		X				X		X	STACK GROUP23
66			X			X		X	STACK GROUP24
67				X		X		X	STACK GROUP25
68						X	X		STACK GROUP26
69						X		X	STACK GROUP27
70						X	X	X	MENU
71	X				X	X			RECALL

No.	SW1	SW2	SW3	SW4	SW5	SW6	SW7	SW8	Function
	↑	↓	←	→	ENTER	X	Y	Z	
72	X				X		X		HOME MENU
73	X				X			X	MEMORY
74		X			X	X			> 10
75		X			X		X		REPEAT
76		X			X			X	REPEAT A-B
77			X		X	X			AUDIO
78			X		X		X		ANGLE
79			X		X			X	SUBTITLE
80				X	X	X			TITLE/CHP/FRM/TIME
81				X	X		X		0
82				X	X			X	CLEAR

Controller

Switch Specifications

On Resistance	Less than 1 ohm
Off Resistance	More than 1 M ohms
Type	Non-Locking

Diode Specifications

Forward Voltage Drop (VF)	Less than 0.7 (IF 1 ma)
Surge Forward Current (IFSM)	Less than 100 ma
Forward Current	Less than 10 µa

Diode Matrix Circuit

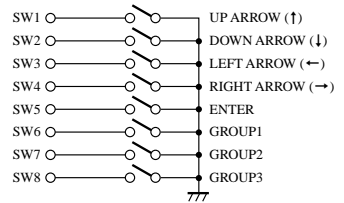
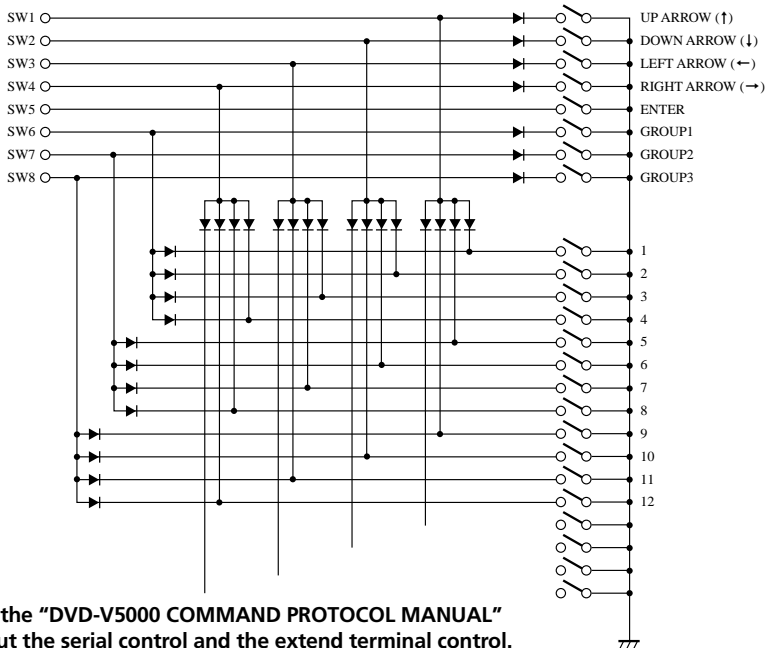

Please refer to the "DVD-V5000 COMMAND PROTOCOL MANUAL" for details about the serial control and the extend terminal control.

Interface Connector

A computer may be connected to the DVD-V5000 using a 15-pin D-Sub connector (e.g., a JAE DALC-J15SAF connector with a suitable plug such as the JAE DA-15PF-N) to the RS-232C serial port or to the parallel port.

This unit includes a 9-pin male connector for use as a serial control connector. Through the ADV. SETUP menu, either a 15-pin or 9-pin connector can be used. However, the 9-pin and 15-pin connectors cannot be accessed simultaneously.

The pins are identified below:

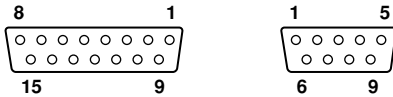

Serial Interface Pin Specification

15-pin D-Sub connector

Pin #	Terminal	Input/Output	Function
1	GND	--	ground
2	TxD	Output	send data
3	RxD	Input	receive data
4	DTR	Output	enable data receiving
5	POWER	Input	external power control
6	SW1	Input	Extend Terminal
7	SW2	Input	Extend Terminal
8	SW3	Input	Extend Terminal
9	SW4	Input	Extend Terminal
10	SW5	Input	Extend Terminal
11	SW6	Input	Extend Terminal
12	SW7	Input	Extend Terminal
13	SW8	Input	Extend Terminal
14	DLTST	Input	Extend Terminal
15		NC	used only for servicing the unit — reserved

9-pin D-Sub connector

Pin #	Terminal	Input/Output	Function
1	NC		
2	RxD	Input	receive data
3	TxD	Output	send data
4	DTR	Output	enable data receiving
5	GND	--	ground
6	DSR	Input	data set ready
7	RTS	Output	request to send
8	CTS	Input	clear to send
9	NC		

Computer Control Functions

Serial Control

The player and computer are based upon the RS-232C protocol and connect through the **TxD**, **RxD**, **DTR** and **GND** terminals.

Extend Terminal

Control the player with the Extend Terminal (SW#).

External Power Control

Control the player's power with the Power Pin within the Interface Connector.

If the player detects a high signal throughput (100 msec or more) during the Standby mode, the player powers ON. If the player detects the same signal during the Power ON mode, the player powers OFF and switches to the Standby mode. The specifications for the Power pin are as follows:

Maximum Input Voltage	Less Than 12 V
High Level Signal	More Than 4.5 V
Low level Signal	Less Than 0.5 V

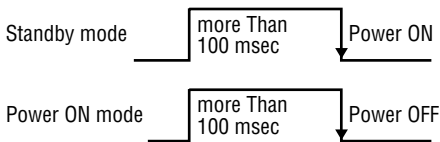

Serial Control

The signal interface is a standard RS-232C connection.

Data Type

Data Length: 8 bit
 Stop Bit: 1 bit
 Parity bit: No Parity

Data Transfer Speed (Baud Rate)

The data transfer speed may be set to either 19200 or 9600 bps through the ADV. SETUP menu (see page 42).



Note

The factory default is 19200 bps.

Communication with a Computer

The DVD-V5000 communicates to the computer through the RS-232C port using pins 2 and 3 for communication and Pin 1 on the 15-pin D-sub connector or Pin 5 on the 9-pin D-sub connector for grounding. Control or "handshaking" lines other than the **TxD** and **RxD** connections are not required. Please refer to the diagram below for clarification.

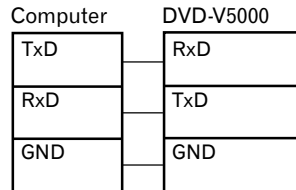

Some computers require the **CTS** port to be set to **HIGH** during communication. It is best to connect the **CTS** and **DSR** port on the computer to the **DTR** port on the player. During normal operation the player's **DTR** is set to **HIGH** thus the unit is able to receive a command at any time.

Command and Status

During normal operation when a computer transmits commands to a DVD-V5000, the player responds with the status message, "execution complete".

Example

COMPUTER	DVD-V5000
(1) "Search to Frame 1000"	→ (2) Search Execution
	← (3) Complete
(4) "Play to Frame 2000"	→ (5) Play Execution
	← (6) Complete

Example

10SE 20PL <CR> : Search to Chapter 10 then play to 20

The command string enters the buffer with the first character and continues sequentially from left to right. When <CR> is entered, the commands are executed sequentially beginning with the first command in the buffer. In the example above, the first command is **10SE**.

When all the commands in a string have finished executing, the player transmits or returns the "complete" message that is represented by a capital letter **R**.

If an error occurs, the player returns an error message such as **E04**. The message indicates an error has occurred as well as the type of error. Error messages are in the form of **EXX** where **XX** represents a 2-digit error code.

Error Messages

If an error occurs during a command execution, the player returns an error code. The table below lists each code with a description of the error:

Code	Message	Description
E00	Communication error	Communication Line Error due to framing error or buffer overflow
E04	Feature not available	Non-Usable Function has been tried – either the command mnemonic is wrong or the command can not be used in this mode
E06	Missing argument	Correct parameter is not specified
E11	Disc does not exist	There is no disc in the tray
E12	Search error	Search address is missing
E15	Picture stop	Playback has been stopped by VOBUs Still while in the Auto Play mode
E16	Interrupt by other device	The command(s) sent via the serial line were not executed before commands were sent from the front panel buttons and/or remote control
E99	Panic	Unrecoverable Error occurred – possible that a disc cannot be loaded and/or playing cannot continue

Command Structure

The DVD-V5000 supports the commands listed below.

COMMAND			SUPPORTING FORMAT		
Name		Mnemonic	DVD	CD	VCD
Open		OP	X	X	X
Close		CO	X	X	X
Reject		RJ	X	X	X
Start		SA	X	X	X
Play	(adrs)	PL	X	X	X
Pause		PA	X	X	X
Still		ST	X		X
Step Forward		SF	X		X
Step Reverse		SR	X		
Scan Forward		NF	X	X	X
Scan Reverse		NR	X	X	X
Scan Stop		NS	X	X	X
Multi-Speed Forward	(adrs)	MF	X		X
Multi-Speed Reverse	(adrs)	MR	X		
Speed	arg	SP	X		X
Search	adrs	SE	X	X	X
Search & Play	adrs	SL	X	X	X
Stop Marker	adrs	SM	X	X	X
Lead Out Symbol		LO	X	X	X
Clear		CL	X	X	X
Frame		FR	X		

COMMAND			SUPPORTING FORMAT		
Name		Mnemonic	DVD	CD	VCD
Time		TM	X	X	X
Chapter		CH	X		
Title		TI	X		
Track		TR		X	X
Select Subtitle	arg	SU	X		
Select Audio	arg	AU	X		
Select Aspect	arg	AP	X		
Select Angle	arg	AG	X		
Select Parental-Level	arg	PT	X		
Audio Control	arg	AD	X	X	X
Video Control	arg	VD	X	X	X
Display Control	arg	DS	X	X	X
Keylock	arg	KL	X	X	X
Stack Group Set	arg	GP	X		
Barcode / Command Stack Play	arg	BS	X		
Command Stack Data Upload		BU	X	X	X
Command Stack Data Download		BD	X	X	X
P-Block Number Request		?A	X	X	X
Title/Track Number Request		?R	X	X	X
Chapter Number Request		?C	X		
Time Code Request		?T	X	X	X
Frame Number Request		?F	X		
Total Frame Request		?Y	X		
TOC Information Request		?Q		X	X
Disc Region Code Request		?G	X		
DVD Disc Status Request		?V	X		
CD Disc Status Request		?K		X	X
Register A Set (Display)	arg	RA	X	X	X
Register D Set (TxD Term)	arg	RD	X	X	X
Print Character	arg	PR	X	X	X
Clear Screen		CS	X	X	X
Advanced Setup	arg	MS	X	X	X
Communication Control Set	arg	CM	X	X	X
Player Active Mode Request		?P	X	X	X
Player Model Name Request		?X	X	X	X
Advanced Setup Request		?S	X	X	X
Player Region Code Request		?H	X	X	X
CCR Mode Request		?M	X	X	X
Input Number Request		?N	X	X	X
Error Code Request		?E	X	X	X
Firmware Version Request		?Z	X	X	X
Input Unit Request		#I	X	X	X
Input Barcode Data Request		#B	X	X	X
Register A Request		\$A	X	X	X
Register D Request		\$D	X	X	X
Menu Call	arg	MC	X		

COMMAND		SUPPORTING FORMAT		
Name	Mnemonic	DVD	CD	VCD
Numeric Button	arg NB	X		
Button Select	arg CU	X		
ENTER Button	(arg) ET	X		
Get Information	arg GI	X		
Memory Data Upload *1	MU	X	X	X



Note

arg (argument) or **ards** (address) prefaces a command with an argument or address parameter. If the arg or ards is in parentheses (), the parameter is optional.

Command Mnemonic

Each command is expressed as two (2) ASCII characters. There is no distinction between uppercase and lowercase letters except when the Character strings are in a **PR** command.

Argument

An Argument, expressed in either ASCII characters or ten digits, consists of either an address or an integer. If a command requires an argument, it is always placed before the command.

An Address can be a Title, a Chapter, a Track, a Frame Number, or a Time Code depending upon how the address flag is set. The Address must not exceed ten characters and/or digits.

Address Type	Media Type	Format	Range (Min – Max)
Title Number	DVD	N ₁ N ₂	0 – 99
Chapter Number	DVD	N ₁ N ₂	0 – 99
Frame Number	DVD	N ₁ N ₂ N ₃ N ₄ N ₅ N ₆ N ₇	0 – 1079999
Time Code	DVD	N ₁ N ₂ N ₃ N ₄ N ₅	0 – 599 : 59
Track Number	CD/VCD	N ₁ N ₂ N ₃ N ₄	0 – 99 : 59
	CD/VCD	N ₁ N ₂	1 – 99

Glossary

Analog audio

An electrical signal that directly represents sound. Compare this to digital audio which can be an electrical signal, but is an indirect representation of sound. See also *Digital audio*.

Aspect ratio

The width of a TV screen relative to its height. Conventional TVs are 4:3 (in other words, the screen is almost square); widescreen models are 16:9 (the screen is almost twice as wide as it is high).

Digital audio

An indirect representation of sound by numbers. During recording, the sound is measured at discrete intervals (44,100 times a second for CD audio) by an analog-to-digital converter, generating a stream of numbers. On playback, a digital-to-analog converter generates an analog signal based on these numbers. See also *Sampling frequency* and *Analog audio*.

Dolby Digital



Using a maximum of 5.1 channels of audio, this high quality surround system is used in many of the finer movie theaters around the world.

The on-screen display shows which channels are active, for example showing 3/2.1. The 3 being the two front channels and the center channel; the 2 being the surround channels, and the .1 being the LFE channel.

DTS



DTS stands for Digital Theater Systems. DTS is a surround system different from Dolby Digital that has become a popular surround sound format for movies.

Dynamic range

The difference between the quietest and loudest sounds possible in an audio signal (without distorting or getting lost in noise). Dolby Digital and DTS soundtracks are capable of a very wide range, delivering dramatic cinema-like effects.

MPEG audio

An audio format used on Video CDs and some DVD discs. This unit can convert MPEG audio to PCM format for wider compatibility with digital recorders and AV amplifiers. See also *PCM (Pulse Code Modulation)*.

MPEG video

The video format used for Video CDs and DVDs. Video CD uses the older MPEG-1 standard, while DVD uses the newer and much better quality MPEG-2 standard.

PBC (PlayBack Control) (Video CD only)

A system of navigating a Video CD through on-screen menus recorded onto the disc. Especially good for discs that you would normally not watch from beginning to end all at once—karaoke discs, for example.

PCM (Pulse Code Modulation)

The most common system of encoding digital audio, found on CDs and DAT. Excellent quality, but requires a lot of data compared to formats such as Dolby Digital and MPEG audio. For compatibility with digital audio recorders (CD, MD and DAT) and AV amplifiers with digital inputs, this unit can convert Dolby Digital, DTS and MPEG audio to PCM. See also *Digital audio*.

Regions (DVD-Video only)

These associate discs and players with particular areas of the world. This unit will only play discs that have compatible region codes. You can find the region code of your unit by looking on the rear panel. Some discs are compatible with more than one region (or all regions).

Sampling frequency

The rate at which sound is measured to be turned into digital audio data. The higher the rate, the better the sound quality, but the more digital information is generated. Standard CD audio has a sampling frequency of 44.1kHz, which means 44,100 samples (measurements) per second. See also *Digital audio*.

Troubleshooting

A slight operational mistake may make the DVD player appear to be broken. Always check other factors in your system such as the monitor or television, the AV amplifier and speakers, etc. When the problem is not obvious after this inspection, please review the points below before contacting the store where you bought the player or the take the player to your nearest PIONEER authorized service center.

Power does not come on.

- ➔ Connect the power cord to the outlet properly.

Even when the disc tray is closed, it comes out.

- ➔ Set the disc in the disc tray properly (page 28).
- ➔ Clean the disc (page 63).
- ➔ Check the region no. (pages 9, 65).

The screen does not appear.

- ➔ Check the setting of the video output selector at the rear of this player with the connected video terminal (page 11, 12).
- ➔ Confirm that connections are correct (pages 11–13).
- ➔ Make the television or AV amplifier setting, etc., to DVD playback setting.

Cannot play back.

- ➔ Clean the disc (page 63).
- ➔ Set the disc in the disc tray properly (page 28).
- ➔ Remove the condensation in the player (page 64).
- ➔ SECAM format discs cannot be played back.
- ➔ Insert the disc with the proper side up.

The contents of the settings disappear.

- ➔ When the power has been turned off due to a power outage and the power cord having been pulled out while the power is turned on, the contents of the settings disappear. Make sure to pull out the power cord after the **STANDBY/ON** button has been

pressed and the **POWER** indicator has turned orange.

The screen stops and the commands from the buttons are not accepted.

- ➔ After pressing **STOP** button, play back once more.
- ➔ The player is set "**Key Lock**" (page 44).

Cannot use the remote control.

- ➔ Operate within the usage range of the remote control (page 8).
- ➔ Replace the dry cell batteries of the remote control with new ones (page 8).
- ➔ The player is set "**Key Lock**" (page 44).

No sound comes from the speakers or the sound is distorted.

- ➔ Confirm that the audio cable is properly connected (pages 11, 13).
- ➔ Some discs prohibit 96 kHz digital output of Linear PCM audio. With these kinds of discs, even if the **[96 kHz PCM Out]** setting of **[Digital Audio Out]** of Initial setting menu screen is set to **[96 kHz]**, it is automatically changed to 48 kHz and output (page 20).
- ➔ Clean the disc (page 63).
- ➔ If it has been set to the pause or slow playback mode, change to the playback mode (page 32).
- ➔ If the volume of the television or AV amplifier, etc., has been set to "minimum," raise the volume.
- ➔ Confirm that the connector plug has been sufficiently inserted and that it has not been disconnected.
- ➔ If the connector plug and terminal are dirty, wipe them.
- ➔ DTS sound is no output from the AUDIO OUT (analog audio output) jacks.

Screen is extended vertically or horizontally.

- ➔ Adjust the **[TV Screen]** setting (pages 21, 65).

There are difference in volume between DVD and CD.

- ➔ This is due to the difference in the disc recording methods.

The picture is distorted or dark during DVD playback

- ➔ This player has the copy guard of an analog copy protect system. Some discs have a copy prohibition signal. When those types of discs are played back, a condition such as lateral stripes on part of the screen appears, but this is not a malfunction.

The playback screen is distorted when a DVD video has been recorded on a VCR and played back on a VCR

- ➔ This player has the copy guard of an analog copy protect system. Some discs have a copy prohibition signal and when that kind of disc is played back on a VCR, and recorded and played back on a VCR, it cannot be played back normally due to the copy guard.

The television, etc., malfunctions

- ➔ Some televisions with a wireless remote control function malfunction due to the remote control of this player. Use them separated from this player.

Cannot control the player with RS-232C interface.

- ➔ Confirm the "SERIAL PORT" setting in ADV. SETUP menu (page 42).

**Tip**

This player may not operate normally due to outside influences such as static electricity. At such times it may operate normally after the power cord has been temporarily unplugged and plugged in again. When the problem has not been solved by this procedure, consult the store where you purchased the player or the nearest service provider.

Specifications

General

System DVD player
 Power requirements AC 120 V, 50/60 Hz
 Power consumption 11 W
 Power consumption (standby) 0.7 W
 Weight 2.5 kg / 5 lb 8 oz
 Dimensions 420 (W) x 55 (H) x 283 (D) mm
 (16.5 (W) x 2.2 (H) x 11.1 (D) in.)
 Operating temperature +5 °C to +35 °C
 (+41 °F to +95 °F)
 Operating humidity 5 % to 85 %
 (no condensation)

Component video output

Y (luminance) - Output level 1 Vp-p (75 Ω)
 Pb (color) - Output level 0.65 Vp-p (75 Ω)
 Pr (color) - Output level 0.65 Vp-p (75 Ω)
 Jack RCA jacks

S-video output

Y (luminance) - Output level 1 Vp-p (75 Ω)
 C (color) - Output level 265 mVp-p (75 Ω)
 Jack S-video jack

Video output

Output level 1 Vp-p (75 Ω)
 Jack RCA jack

Audio output (1 stereo pair)

Output level During audio output
 200 mVrms (1 kHz, -20 dB)
 Number of channels 2
 Jack RCA jacks

Digital audio characteristics

Frequency response 4 Hz to 44 kHz
 (DVD fs: 96 kHz)
 S/N ratio 118 dB
 Dynamic range 105 dB
 Total harmonic distortion 0.0025 %
 Wow and flutter Limit of measurement
 (±0.001 % W. PEAK) or lower

Other terminals

Coaxial digital output RCA jack
 RS-232C D-sub 9-pin, male
 RS-232C and extended D-sub 15-pin, female

Accessories

Audio/video cable 1
 Power cable 1
 Remote control 1
 AA/R6P dry cell batteries 2
 Operating Instructions 1
 Warranty card 1



Note

The specifications and design of this product are subject to change without notice, due to improvement.

Should this product require service in the U.S.A. and you wish to locate the nearest Pioneer Authorized Independent Service Company, or if you wish to purchase replacement parts, operating instructions, service manuals, or accessories, please call the number shown below.

(800) 421-1404

Please do not ship your product to Pioneer without first calling the Customer Support Division at the above listed number for assistance.

Pioneer Electronics (USA) Inc.
Customer Support Division
P.O. BOX 1760, Long Beach,
CA 90801-1760, U.S.A.

For warranty information please see the Limited Warranty sheet included with your product.

Should this product require service in Canada, please contact a Pioneer Canadian Authorized Dealer to locate the nearest Pioneer Authorized Service Company in Canada. Alternatively, please contact the Customer Satisfaction Department at the following address:

Pioneer Electronics of Canada, Inc.
Customer Satisfaction Department
300 Allstate Parkway, Markham, Ontario L3R OP2
(905)479-4411
1(877)283-5901

For warranty information please see the Limited Warranty sheet included with your product.

Si ce produit doit être réparé au Canada, veuillez vous adresser à un distributeur autorisé Pioneer du Canada pour obtenir le nom du Centre de Service Autorisé Pioneer le plus près de chez-vous. Vous pouvez aussi contacter le Service à la clientèle de Pioneer:

Pioneer Électroniques du Canada, Inc.
Service à la clientèle
300, Allstate Parkway, Markham, Ontario L3R OP2
(905)479-4411
1(877)283-5901

Pour obtenir des renseignements sur la garantie, veuillez vous reporter au feuillet sur la garantie restreinte qui accompagne le produit.

502115_EF

Published by Pioneer Corporation.
Copyright © 2004 Pioneer Corporation.
All rights reserved.

PIONEER CORPORATION

1-1, Shin-ogura, Saiwai-ku, Kawasaki-shi, Kanagawa 212-0031, Japan

PIONEER ELECTRONICS (USA) INC.

P.O. BOX 1540, Long Beach, California 90801-1540, U.S.A. TEL: (800) 421-1404

PIONEER ELECTRONICS OF CANADA, INC.

Industrial Products Department: 300 Allstate Parkway, Markham, Ontario L3R OP2, Canada TEL: +1-905-479-4411

Printed in

<DRC1219-D>

Free Manuals Download Website

<http://myh66.com>

<http://usermanuals.us>

<http://www.somanuals.com>

<http://www.4manuals.cc>

<http://www.manual-lib.com>

<http://www.404manual.com>

<http://www.luxmanual.com>

<http://aubethermostatmanual.com>

Golf course search by state

<http://golfingnear.com>

Email search by domain

<http://emailbydomain.com>

Auto manuals search

<http://auto.somanuals.com>

TV manuals search

<http://tv.somanuals.com>