

# Operation Manual

Multi-CD control high power DVD/Video CD/CD/MP3/  
WMA player with FM/AM tuner

# DVH-P5650MP

**SUPER**  **TUNER III D**

*English*

## Thank you for buying this Pioneer product.

Please read through these operating instructions so you will know how to operate your model properly. *After you have finished reading the instructions, keep this manual in a safe place for future reference.*



### Be sure to read this

- Playable discs 6
- DVD video disc region numbers 6
- When an operation is prohibited 9

### 01 Precautions

To ensure safe driving 5

### 02 Before You Start

Playable discs 6  
DVD video disc region numbers 6  
About this manual 6  
Precautions 7  
Features 7  
About WMA 8  
What the marks on DVDs indicate 8  
Use and care of the remote control 9

### 03 What's What

Head unit 10  
Remote control 11

### 04 Basic Operations

Using the remote control operation mode switch 14  
Turning the unit on 14  
Selecting a source 14  
Loading a disc 15  
Adjusting the volume 15  
Turning the unit off 15  
Protecting your unit from theft 16

### 05 Tuner

Listening to the radio 17  
Introduction of advanced tuner operation 18

Storing and recalling broadcast frequencies 18

Tuning in strong signals 18

Storing the strongest broadcast frequencies 19

### 06 Playing DVD video discs

Watching a DVD video 20  
Basic operation of DVD video 20  
Specifying title 21  
Specifying chapter 21  
Selecting a chapter directly 21  
Frame-by-frame playback 22  
Pausing DVD video playback 22  
Slow motion playback 22  
Changing audio language during playback (Multi-audio) 22  
Changing the subtitle language during playback (Multi-subtitle) 23  
Changing the viewing angle during playback (Multi-angle) 23  
Resume playback (Bookmark) 24  
Operating from the information displays 24  
Operating from the function display 27

### 07 Playing Video CDs

Watching a Video CD 28  
Basic operation of Video CD 28  
Specifying track 29  
Selecting a track directly 29  
Pausing Video CD playback 29  
Slow motion playback 30  
Operating from the information display 30  
Operating from the function display 32

### 08 Playing CDs

Listening to a CD 34  
Basic operation of CD 34  
Operating from the information display 35

- Operating from the function display **37**
- 09 Playing MP3/WMA**
  - Listening to MP3/WMA **41**
  - Basic operation of MP3/WMA **41**
  - Operating from the information display **43**
  - Operating from the function display **45**
- 10 Multi-CD Player**
  - Playing a CD **49**
  - Selecting a track directly **49**
  - 50-disc multi-CD player **50**
  - Introduction of advanced multi-CD player operation **50**
  - Repeating play **50**
  - Playing tracks in a random order **51**
  - Scanning CDs and tracks **51**
  - Pausing CD playback **52**
  - Using ITS playlists **52**
  - Using disc title functions **53**
  - Using CD TEXT functions **54**
  - Using compression and dynamic bass emphasis **55**
- 11 Audio Adjustments**
  - Introduction of audio adjustments **56**
  - Compensating for equalizer curves (EQ-EX) **57**
  - Setting the sound focus equalizer (SFEQ) **57**
  - Using balance adjustment **57**
  - Using the equalizer **58**
  - Adjusting bass and treble **59**
  - Adjusting loudness **60**
  - Using subwoofer output **60**
  - Using nonfading output **61**
  - Using the high pass filter **61**
  - Adjusting source levels **62**
- 12 Digital Signal Processor**
  - Introduction of DSP adjustments **63**
  - Using the sound field control **64**
  - Using the position selector **64**
  - Using balance adjustment **65**
  - Adjusting source levels **65**
  - Using the dynamic range control **66**
  - Using the direct control **66**
  - Using the down-mix function **66**
  - Using the Dolby Pro Logic II **66**
  - Setting the speaker setting **67**
  - Selecting a cross-over frequency **68**
  - Adjusting the speaker output levels **69**
  - Adjusting the speaker output levels using a test tone **69**
  - Using the time alignment **70**
  - Using the auto-equalizer **71**
  - Auto TA and EQ (auto-time alignment and auto-equalizing) **71**
  - Using the equalizer **73**
- 13 Setting up the DVD player**
  - Introduction of DVD setup adjustments **76**
  - Returning to the previous display **76**
  - Setting the subtitle language **76**
  - Setting the audio language **77**
  - Setting the menu language **77**
  - Setting assist subtitles on or off **78**
  - Setting angle icon display **78**
  - Setting the aspect ratio **78**
  - Setting the parental lock **79**
  - Automatic playback of DVDs **80**
  - Setting remote control code type **80**
- 14 Initial Settings**
  - Adjusting initial settings **81**
  - Setting the clock **81**
  - Setting the FM tuning step **81**
  - Setting the AM tuning step **82**

- Switching the warning tone **82**
- Switching the auxiliary setting **82**
- Switching the dimmer setting **82**
- Setting the rear output and subwoofer controller **83**
- Switching the telephone muting/attenuation **83**
- Switching the automatic disc playback **84**
- Correcting distorted sound **84**
- Resetting the audio functions **84**

## **15 Other Functions**

- Turning the clock display on or off **85**
- Setting the level indicator **85**
- Using the AUX source **85**
- Switching between digital and analog **86**
- Introduction of DVD operation **86**
- Using the PGM button **87**

## **Additional Information**

- Troubleshooting **88**
- Error messages **90**
- Understanding auto TA and EQ error messages **91**
- DVD player and care **92**
- DVD discs **92**
- CD-R/CD-RW discs **93**
- MP3 and WMA files **93**
- About folders and MP3/WMA files **94**
- Language code chart for DVD **96**
- Terms **97**
- Specifications **100**

## Precautions

### To ensure safe driving

#### WARNING

- **LIGHT GREEN LEAD AT POWER CONNECTOR IS DESIGNED TO DETECT PARKED STATUS AND MUST BE CONNECTED TO THE POWER SUPPLY SIDE OF THE PARKING BRAKE SWITCH. IMPROPER CONNECTION OR USE OF THIS LEAD MAY VIOLATE APPLICABLE LAW AND MAY RESULT IN SERIOUS INJURY OR DAMAGE.**
- To avoid the risk of accident and the potential violation of applicable laws, the front DVD or TV (sold separately) feature should never be used while the vehicle is being driven. Also, rear displays should not be in a location where it is a visible distraction to the driver.
- In some countries or states the viewing of images on a display inside a vehicle even by persons other than the driver may be illegal. Where such regulations apply, they must be obeyed and this unit's DVD features should not be used.

This unit detects whether your car's parking brake is engaged or not, and prevents you from watching a DVD or Video CD on the display connected to **FRONT VIDEO OUTPUT** while driving. When you attempt to watch a DVD/Video CD, the screen will turn black. When you park your car in a safe place and apply the parking brake, the picture appears on the screen.

### When using a display connected to DVD REAR MONITOR OUTPUT

This unit's **DVD REAR MONITOR OUTPUT** is for connection of a display to enable passengers in the rear seats to watch the DVD or Video CD.

#### WARNING

**NEVER** install the display in a location that enables the driver to watch the DVD or Video CD while driving. 

## Playable discs

DVD, Video CD and CD discs that display the logos shown below can be played back on this player.

### DVD video



### Video CD



### CD



### Note

It is not possible to play back DVD audio disc. This player can only play back discs bearing the marks shown above. ■

## DVD video disc region numbers

DVD video discs that have incompatible region numbers cannot be played on this player. The region number of the player can be found on the bottom of this unit.

The illustration below shows the regions and corresponding region numbers.



## About this manual

This unit features a number of sophisticated functions ensuring superior reception and operation. All the functions have been designed for the easiest possible use, but many are not self-explanatory. This operation manual will help you benefit fully from this unit's potential and to maximize your listening enjoyment.

We recommend that you familiarize yourself with the functions and their operation by reading through the manual before you begin using this unit. It is especially important that you read and observe precautions noted on the next page and in other sections.

This manual mainly explains remote control operation. However, in addition to those functions related with DVD/Video CD/CD/MP3/WMA operation that can only be operated by the remote control, there are also functions that can be operated similarly by the head unit and functions that can only be operated by the buttons provided for the head unit. ■

## Before You Start

### Precautions

**CAUTION:**  
**USE OF CONTROL OR ADJUSTMENT OR PERFORMANCE OF PROCEDURES OTHER THAN THOSE SPECIFIED HEREIN MAY RESULT IN HAZARDOUS RADIATION EXPOSURE.**

**CAUTION:**  
**THE USE OF OPTICAL INSTRUMENTS WITH THIS PRODUCT WILL INCREASE EYE HAZARD.**

- Keep this manual handy as a reference for operating procedures and precautions.
- Always keep the volume low enough so that you can hear sounds from outside the vehicle.
- Protect this unit from moisture.
- If the battery is disconnected or discharged, the preset memory will be erased and must be reprogrammed.
- Should this product fail to operate properly, contact your dealer or nearest authorized Pioneer Service Station. 

### Features

#### DVD video playback

It is possible to play back DVD video, DVD-R (video mode) and DVD-RW (video mode). Remember that use of this system for commercial or public viewing purposes may constitute an infringement on the author's rights protected by the Copyright Law.

#### Video CDs featuring PBC compatibility

It is possible to play back Video CDs featuring PBC (playback control).

#### CD playback

Music CD/CD-R/CD-RW playback is possible.

#### MP3 file playback

You can play back MP3 files recorded on CD-ROM/CD-R/CD-RW (ISO9660 Level 1/Level 2 standard recordings).

- Supply of this product only conveys a license for private, non-commercial use and does not convey a license nor imply any right to use this product in any commercial (i.e. revenue-generating) real time broadcasting (terrestrial, satellite, cable and/or any other media), broadcasting/streaming via internet, intranets and/or other networks or in other electronic content distribution systems, such as pay-audio or audio-on-demand applications. An independent license for such use is required. For details, please visit <http://www.mp3licensing.com>.

#### WMA file playback

You can play back WMA files recorded on CD-ROM/CD-R/CD-RW (ISO9660 Level 1/Level 2 standard recordings).

#### NTSC/PAL compatibility

This unit is NTSC/PAL system compatible. When connecting other components to this unit, be sure components are compatible with the same video system otherwise images will not be correctly reproduced.

#### Dolby Digital/DTS compatibility

When using this unit with a Pioneer multi-channel processor, you can enjoy the atmosphere and excitement provided by DVD movie and music software featuring 5.1 channel recordings.

- Manufactured under license from Dolby Laboratories. "Dolby", "Pro Logic", and the double-D symbol are trademarks of Dolby Laboratories.



- “DTS” is a registered trademark of Digital Theater Systems, Inc.



### Multi-aspect

Switching between wide screen, letterbox and panscan display is possible.

### Multi-audio

You can switch between multiple audio systems recorded on a DVD as desired.

### Multi-subtitle

You can switch between multiple subtitle languages recorded on a DVD as desired.

### Multi-angle

You can switch between multiple viewing angles of a scene recorded on a DVD as desired.



#### Note

This product incorporates copyright protection technology that is protected by method claims of certain U.S. patents and other intellectual property rights owned by Macrovision Corporation and other rights owners. Use of this copyright protection technology must be authorized by Macrovision Corporation, and is intended for home and other limited viewing uses only unless otherwise authorized by Macrovision Corporation. Reverse engineering or disassembly is prohibited. 

## About WMA



The Windows Media™ logo printed on the box indicates that this unit can play back WMA data.

WMA is short for Windows Media Audio and refers to an audio compression technology that is developed by Microsoft Corporation. WMA data can be encoded by using Windows Media Player version 7 or later.

Microsoft, Windows Media, and the Windows logo are trademarks, or registered trademarks of Microsoft Corporation in the United States and/or other countries.





#### Notes

- With some applications used to encode WMA files, this unit may not operate correctly.
- With some applications used to encode WMA files, album names and other text information may not be correctly displayed. 



## What the marks on DVDs indicate

The marks below may be found on DVD disc labels and packages. They indicate the type of images and audio recorded on the disc, and the functions you can use.

Mark	Meaning
	Indicates the number of audio systems.
	Indicates the number of subtitle languages.





## Before You Start

Mark	Meaning
	Indicates the number of viewing angles.
	Indicates the picture size (aspect ratio: screen width-to-height ratio) type.
	Indicates the number of the region where playback is possible.

### When an operation is prohibited

When you are watching a DVD and attempt to perform an operation, it may not be performed because of the programming on the disc. When this happens, the icon  appears on the screen.

- The icon  may not appear with certain discs. 

## Use and care of the remote control

### Installing the battery

Slide the tray out on the back of the remote control and insert the battery with the plus (+) and minus (-) poles pointing in the proper direction.

- When using for the first time, pull out the film protruding from the tray.

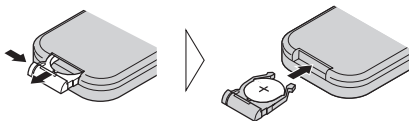

### WARNING

Keep the battery out of the reach of children. Should the battery be swallowed, immediately consult a doctor.

### CAUTION

- Use only one **CR2025 (3 V)** lithium battery.
- Remove the battery if the remote control is not used for a month or longer.
- Do not recharge, disassemble, heat or dispose of the battery in fire.
- Do not handle the battery with metallic tools.
- Do not store the battery with metallic materials.
- In the event of battery leakage, wipe the remote control completely clean and install a new battery.
- When disposing of used batteries, please comply with governmental regulations or environmental public institutions' rules that apply in your country/area.
- Always check carefully that you are loading the battery with its plus (+) and minus (-) poles facing in the proper directions.

### Using the remote control

Point the remote control in the direction of the front panel to operate.

- The remote control may not function properly in direct sunlight.

### Important

- Do not store the remote control in high temperatures or direct sunlight.
- Do not let the remote control fall onto the floor, where it may become jammed under the brake or accelerator pedal. 

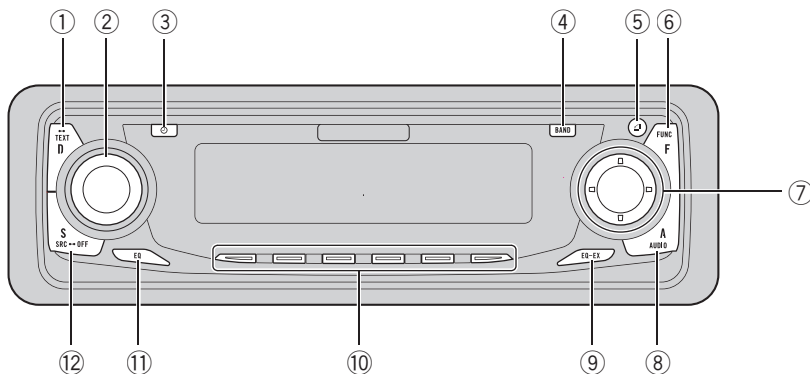

## Head unit

### ① DISPLAY button

This button is only available on the head unit.  
Press to select different displays.

### ② VOLUME

When you press **VOLUME**, it extends outward so that it becomes easier to turn. To retract **VOLUME**, press it again. Rotate it to increase or decrease the volume.

### ③ CLOCK button

This button is only available on the head unit.  
Press to change to the clock display.

### ④ BAND button

Press to select among three FM bands and one AM band and to cancel the control mode of functions.

### ⑤ OPEN button

This button is only available on the head unit.  
Press to open the front panel.

### ⑥ F (function) button

Press to select functions.

### ⑦ ▲/▼/◀/▶ buttons

When controlling sources

- These buttons can perform the same operation as ◀◀/▶▶/|◀◀/▶▶/||/◀|| buttons on the remote control. Press to do manual seek tuning, fast forward, reverse, track search and folder select controls.

When controlling functions

- These buttons can perform the same operation as ||/◀||/◀◀/▶▶ buttons on the remote control.

### ⑧ A (audio) button

Press to select various sound quality controls.

### ⑨ EQ-EX button

This button is only available on the head unit.  
Press and hold to switch between EQ-EX and SFEQ functions. Press to operate each function.

### ⑩ 1-6 buttons

These buttons can perform the same operation as **NUMBER (1-6)** buttons on the remote control. Press for preset tuning and

# What's What

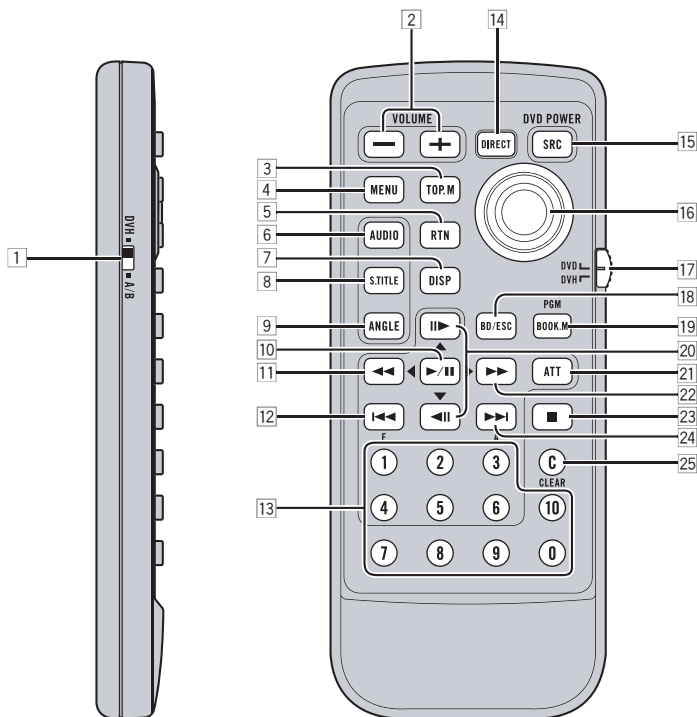

disc number search when using a multi-CD/DVD player.

## ⑪ EQ button

This button is only available on the head unit.

Press to select various equalizer curves.

## ⑫ SOURCE button

This unit is turned on by selecting a source.

Press to cycle through all the available sources. 

## Remote control

### ① Remote control selection switch

Switch to change the setting of the remote control. For details, refer to *Setting remote control code type* on page 80.

### ② VOLUME button

Press to increase or decrease the volume.

### ③ TOP MENU (TOP.M) button

Press to return to the top menu during DVD playback.

### ④ MENU button

Press to display the DVD menu during DVD playback.

## What's What

- 5 RETURN button**  
Press to return to the previous display when the **SET-UP MENU** is displayed.
- 6 AUDIO button**  
Press to change the audio language during DVD playback.
- 7 DISP button**  
Press to change the information display while the DVD player is playing as the source.
- 8 SUBTITLE (S.TITILE) button**  
Press to change the subtitle language during DVD playback.
- 9 ANGLE button**  
Press to change the viewing angle during DVD playback.
- 10 PLAY/PAUSE (▶/||) button**  
Press to switch sequentially between playback and pause.
- 11 REVERSE (◀◀) button**  
Press to perform fast reverse playback or seek tuning while the tuner is playing as the source.
- 12 PREVIOUS (◀◀)/F (function) button**  
When the remote control is set to **DVD** mode, press to return to the previous track (chapter). If the remote control is set to **DVH** mode, the function menu appears on the head unit display.
- 13 NUMBER buttons**  
Press to directly select the desired track, chapter, preset tuning and disc. **1–6** buttons can operate the preset tuning for the tuner or disc number search for the multi-CD player.
- 14 DIRECT button**  
Press to do direct channel select.
- 15 SOURCE button**  
This unit is turned on by selecting a source. Press to cycle through all the available sources.
- 16 Joystick**  
Move to select the setting. Click to set the setting or select on or off.
- 17 Remote control operation mode switch**  
Switch the operation mode between **DVD** mode (only the DVD player can be operated by the remote control) or **DVH** mode (all sources of this unit can be operated by the remote control). (Refer to page 14.)
- 18 BAND button**  
Press to select among three FM bands and one AM band and to cancel the control mode of functions.
- 19 BOOKMARK (BOOK.M) button**  
**DVH mode**  
Press to operate the preprogrammed functions for each source. (Refer to *Using the PGM button* on page 87.)  
**DVD mode**  
Press to turn the bookmark function on or off. For details, refer to *Resume playback (Bookmark)* on page 24.
- 20 STEP (||▶/◀||) button**  
Press to move ahead one frame at a time during DVD/VideoCD playback. Press and hold for one second to activate slow playback.
- 21 ATT button**  
Press to quickly lower the volume level, by about 90%. Press once more to return to the original volume level.

## What's What

### 22 FORWARD (▶▶) button

Press to perform fast forward playback or seek tuning while the tuner is playing as the source.

### 23 STOP (■) button

Press to stop playback.

### 24 NEXT (▶▶|)/A (audio) button

When the remote control is set to **DVD** mode, press to return to the previous track (chapter). If the remote control is set to **DVH** mode, the audio menu appears on the head unit display.

### 25 CLEAR button

Press to cancel the input number when **NUMBER** are used. □

## Using the remote control operation mode switch

There are two remote control operation modes on the remote control. If you want to operate this unit by remote control, turn the mode switch to **DVH** mode. In this case, both the head unit's buttons and remote control can control this unit.

### DVH mode operation

When operating this unit by remote control, the mode is normally switched to **DVH**.

- It is possible to use the joystick on the remote control to perform the same operations as the ▲/▼/◀/▶ buttons on the head unit.
- Numbers (1–6) can perform the same operations as 1–6 buttons on the head unit.
  - If you want to select a disc located at 7 to 12 by using buttons 1–6, press and hold the corresponding numbers, such as 1 for disc 7, until the disc number appears in the display.

### DVD mode operation

If you switch the mode to **DVD**, the joystick and **NUMBER** operations are changed for DVD player.

#### • When you want to operate the following functions, switch the mode to **DVD**:

- When operating the DVD menu by using the joystick. (Refer to *Basic operation of DVD video* on page 20.)
- When operating the PBC menu by using **NUMBER**. (Refer to *Watching a Video CD* on page 28.)
- When specifying title or track by using **NUMBER**. (Refer to *Specifying title* on page 21 and *Specifying track* on page 29.)



#### Note

If the remote control is set to **DVH** mode, ◀◀ and ▶▶ are assigned to other functions. Use ◀◀ and ▶▶ instead for the **DVD** mode functions controlled by ◀◀ and ▶▶. □

## Turning the unit on

#### • Press **SOURCE** to turn the unit on.

When you select a source the unit is turned on. □

## Selecting a source

You can select a source you want to listen to. If **DSC-A** is turned on, load a disc in the unit to switch to **DVD** (refer to *Switching the automatic disc playback* on page 84).

#### • Press **SOURCE** to select a source.

Press **SOURCE** repeatedly to switch between the following sources:

**TUNER** (tuner)—**TV** (television)—**AV** (video input)—**DVD** (built-in DVD player)—**S-DVD** (DVD player/multi-DVD player)—**MULTI-CD** (multi-CD player)—**EXT** (external unit 1)—**EXT** (external unit 2)—**AUX** (AUX)



#### Notes

- In the following cases, the sound source will not change:
  - When there is no unit corresponding to the selected source connected to this unit.
  - When there is no disc in the unit.
  - When there is no disc in the DVD player.
  - When there is no magazine in the multi-CD player.
  - When there is no magazine in the multi-DVD player.

## Basic Operations

- When the AUX (auxiliary input) is set to off (refer to page 82).
- External unit refers to a Pioneer product (such as one available in the future) that, although incompatible as a source, enables control of basic functions by this unit. Two external units can be controlled by this unit. When two external units are connected, the allocation of them to external unit 1 or external unit 2 is automatically set by this unit.
- When this unit's blue/white lead is connected to the car's auto-antenna relay control terminal, the car's antenna extends when this unit's source is turned on. To retract the antenna, turn the source off. (When you connected a Pioneer multi-channel processor (DEQ-P7650) to this unit, auto-antenna cannot be controlled.)

### Loading a disc

#### 1 Press OPEN to open the front panel.

Disc loading slot appears.

- After a disc has been inserted, press **SOURCE** to select the DVD player.

#### 2 Insert a disc into the disc loading slot.

When you set **DSC-A: ON**, playback will automatically start. If you set **DSC-A: OFF**, press **SOURCE** to select **DVD** (refer to the previous page).

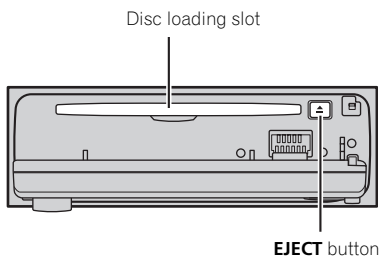

- To eject a disc, press **EJECT**.

- To avoid a malfunction, make sure that no metal object comes into contact with the terminals when the front panel is open.

### 3 Close the front panel.

#### Notes

- The DVD player plays one, standard, 12-cm or 8-cm (single) disc at a time. Do not use an adapter when playing 8-cm discs.
- Do not insert anything other than a disc into the disc loading slot. Discs which can be played back are listed on *Playable discs* on page 6.
- If you cannot insert a disc completely or if after you insert a disc the disc does not play, check that the label side of the disc is up. Press **EJECT** to eject the disc, and check the disc for damage before inserting it again.
- If the DVD player does not operate properly, an error message such as **ERROR-02** may be displayed. Refer to *Error messages* on page 90.
- If bookmark function is on, DVD playback resumes from the selected point. For more details, refer to *Resume playback (Bookmark)* on page 24.

### Adjusting the volume

- Use **VOLUME** to adjust the sound level.

With the head unit, rotate **VOLUME** to increase or decrease the volume.

With the remote control, press **VOLUME** to increase or decrease the volume.

### Turning the unit off

- Press **SOURCE** and hold until the unit turns off.

## Protecting your unit from theft

The front panel can be detached from the head unit and stored in the protective case provided to discourage theft.

- If the front panel is not detached from the head unit within five seconds of turning off the ignition, a warning tone will sound.
- You can turn off the warning tone. See *Switching the warning tone* on page 82.

### Important

- Never use force or grip the display and the buttons too tightly when removing or attaching.
- Avoid subjecting the front panel to excessive shocks.
- Keep the front panel out of direct sunlight and high temperatures.

## Removing the front panel

**1 Press OPEN to open the front panel.**

**2 Gently grip the left side of the front panel and slowly pull it outward.**

Take care not to grip it too tightly or to drop the front panel and protect it from contact with water or other fluids to prevent permanent damage.

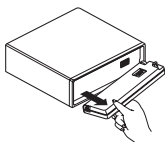

**3 Put the front panel into the protective case provided for safe keeping.**

## Attaching the front panel

- Replace the front panel by holding it upright to the unit and clipping it securely into the mounting hooks.

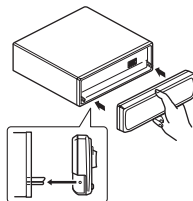



# Tuner

## Listening to the radio

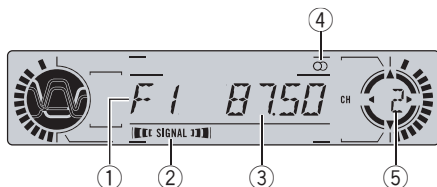

These are the basic steps necessary to operate the radio. More advanced tuner operation is explained starting on the next page.

### ① Band indicator

Shows which band the radio is tuned to, AM or FM.

### ② Signal level indicator

Shows the radio wave strength.

### ③ Frequency indicator

Shows to which frequency the tuner is tuned.

### ④ Stereo (Ⓢ) indicator

Shows that the frequency selected is being broadcast in stereo.

### ⑤ Preset number indicator

Shows which preset has been selected.

### 1 Press SOURCE to select the tuner.

Press **SOURCE** until you see **TUNER** displayed.

### 2 Press BAND to select a band.

Press **BAND** until the desired band is displayed, **F1**, **F2**, **F3** for FM or **AM**.

### 3 To perform manual tuning, press ◀◀ or ▶▶ with quick presses.

The frequencies move up or down step by step.

### 4 To perform seek tuning, press and hold ◀◀ or ▶▶ for about one second and release.

The tuner will scan the frequencies until a broadcast strong enough for good reception is found.

- You can cancel seek tuning by pressing either ◀◀ or ▶▶ with a quick press.
- If you press and hold ◀◀ or ▶▶ you can skip broadcasting stations. Seek tuning starts as soon as you release the buttons.



### Note

When the frequency selected is being broadcast in stereo the stereo (Ⓢ) indicator will light. ◻

## Introduction of advanced tuner operation

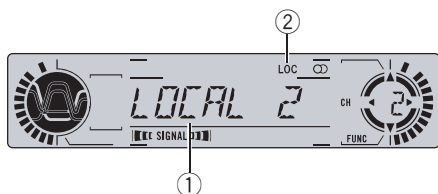

### ① Function display

Shows the function status.

### ② LOC indicator

Shows when local seek tuning is on.

### ● Press F to display the function names.

Press **F** repeatedly to switch between the following functions:

**BSM** (best stations memory)—**LOCAL** (local seek tuning)

- To return to the frequency display, press **BAND**.

### Note

If you do not operate the function within about 30 seconds, the display is automatically returned to the frequency display. 

## Storing and recalling broadcast frequencies

If you press any of the **NUMBER (1–6)** you can easily store up to six broadcast frequencies for later recall with the touch of a button.

- **When you find a frequency that you want to store in memory press a NUMBER (1–6) and hold until the preset number stops flashing.**

The number you have pressed will flash in the preset number indicator and then remain lit. The selected radio station frequency has been stored in memory.

The next time you press the same **NUMBER (1–6)** the radio station frequency is recalled from memory.

### Notes

- Up to 18 FM stations, six for each of the three FM bands, and six AM stations can be stored in memory.
- You can also use **◀II** and **II▶** to recall radio station frequencies assigned to **NUMBER (1–6)**. 

## Tuning in strong signals

Local seek tuning lets you tune in only those radio stations with sufficiently strong signals for good reception.

### 1 Press F to select LOCAL.

Press **F** until **LOCAL** appears in the display.

### 2 Press II▶ to turn local seek tuning on.

Local seek sensitivity (e.g., **LOCAL 2**) appears in the display.

### 3 Press ◀◀ or ▶▶ to set the sensitivity.

There are four levels of sensitivity for FM and two levels for AM:

FM: **LOCAL 1—LOCAL 2—LOCAL 3—LOCAL 4**

AM: **LOCAL 1—LOCAL 2**

The **LOCAL 4** setting allows reception of only the strongest stations, while lower settings let you receive progressively weaker stations.

**4 When you want to return to normal seek tuning, press ◀II to turn local seek tuning off.**

**LOCAL:OFF** appears in the display. ◻

## Storing the strongest broadcast frequencies

BSM (best stations memory) lets you automatically store the six strongest broadcast frequencies under **NUMBER (1–6)** and once stored there you can tune in to those frequencies with the touch of a button.

### 1 Press F to select BSM.

Press **F** until **BSM** appears in the display.

### 2 Press II▶ to turn BSM on.

**BSM** begins to flash. While **BSM** is flashing the six strongest broadcast frequencies will be stored under **NUMBER (1–6)** in order of their signal strength. When finished, **BSM** stops flashing.

- To cancel the storage process, press ◀II.



### Note

Storing broadcast frequencies with BSM may replace broadcast frequencies you have saved using **NUMBER (1–6)**. ◻

## Watching a DVD video

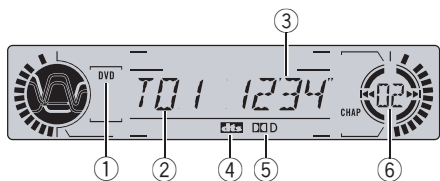

Head unit's display

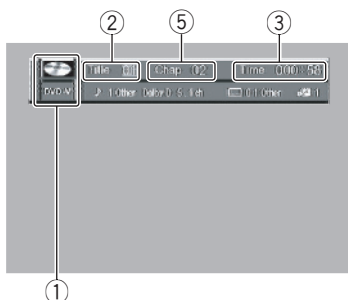

When the separately sold display is connected to this unit, the listed information will appear on it.

Information display

These are the basic steps necessary to play a DVD video with your DVD player. More advanced DVD video operation is explained starting on page 24.

- ① **DVD (DVD-V) indicator**  
Shows when a DVD video is playing.
- ② **Title number indicator**  
Shows the title currently playing.
  - On the head unit's display, if the elapsed playing time of current chapter is more than 100 minutes, **T** in the title number indicator disappears.
- ③ **Play time indicator**  
Shows the elapsed playing time of the current chapter.

- ④ **dts indicator**  
Shows the DTS is on when the multi-channel processor (DEQ-P7650) is connected to this unit.
- ⑤ **Dolby Digital indicator**  
Shows when the Dolby Digital is turned on.
- ⑥ **Chapter number indicator**  
Shows the chapter currently playing.

## Basic operation of DVD video

### 1 Use the joystick to select the desired menu option.

When the DVD offers a menu, a menu is displayed.

### 2 Click the joystick.

Playback starts from the selected menu item.

- You can display the menu by pressing the **MENU** or **TOP MENU (TOP.M)** while a disc is playing. Pressing either of these buttons again lets you start playback from the location selected from the menu. For details, refer to the instructions provided with the disc.
- The way to display the menu differs depending on the disc.

### 3 To perform fast forward or reverse, press and hold ◀◀ or ▶▶.

- If you continue pressing ◀◀ or ▶▶ for five seconds, the color of the icon ◀◀/▶▶ changes from white to blue. When this happens, fast reverse/fast forward continues even if you release ◀◀ or ▶▶. To resume playback at a desired point, press ▶/||.
- Fast forward/fast reverse may not be possible at certain locations on some discs. If this happens, normal playback automatically resumes.

## Playing DVD video discs

### 4 To skip back or forward to another chapter, press **I◀◀** or **▶▶I**.

Pressing **▶▶I** skips to the start of the next chapter. Pressing **I◀◀** once skips to the start of the current chapter. Pressing again will skip to the previous chapter.

Chapter numbers are displayed for eight seconds.

- Using **NUMBER** also performs the same operation. For more details, refer to *Specifying chapter* on this page.
- If the remote control is set to **DVH** mode, **I◀◀** and **▶▶I** are assigned to other functions. Use **◀◀** and **▶▶** instead for the **DVD** mode functions controlled by **I◀◀** and **▶▶I**.

### 5 To stop playback, press **■**.

- When you stop DVD playback by pressing **■**, that location on the disc is memorized enabling playback from that point when you play the disc again.
- To resume playback, press **▶/II**.
- If the remote control is set to **DVH**, **■** does not operate. 

## Specifying title

To perform this function, set the remote control to **DVD** mode.

- You cannot operate this function by using **NUMBER** when the remote control is set to **DVH** mode.

### ● Press **NUMBER** corresponding to a desired title number when the disc is stopped.

Title number is displayed for eight seconds and playback starts from the selected title.

- To select 3, press **3**.
- To select 10, press **10** and **0** in that order.
- To select 23, press **10**, **10** and **3** in that order. 

## Specifying chapter

To perform this function, set the remote control to **DVD** mode.

- You cannot operate this function by using **NUMBER** when the remote control is set to **DVH** mode.
- **Press **NUMBER** corresponding to a desired chapter number during playback.**  
Chapter number is displayed for eight seconds and playback starts from the selected chapter.
  - To select 3, press **3**.
  - To select 10, press **10** and **0** in that order.
  - To select 23, press **10**, **10** and **3** in that order. 

## Selecting a chapter directly

When using the remote control, you can select a chapter directly by entering the desired chapter number.

### 1 Press **DIRECT**.

Chapter number input display appears.

### 2 Press **NUMBER** buttons to enter the desired chapter number.

- To select 3, press **3**.
- To select 10, press **1** and **0** in order.
- You can cancel the input number by pressing **CLEAR**.

### 3 Press **DIRECT**.

The chapter of entered number will play.



#### Note

After entering the number input mode, if you do not perform an operation within about eight seconds, the mode is automatically canceled. 

## Frame-by-frame playback

This lets you move ahead one frame at a time during playback.



### ● Press **II▶**.

Each time you press **II▶**, you move ahead one frame.

- To return to normal playback, press **▶/II**.



### Notes

- There is no sound during frame-by-frame playback.
- Depending on the disc and the playback location on the disc, the icon  may be displayed, indicating that frame-by-frame playback is not possible.
- With some discs, images may be unclear during frame-by-frame playback.
- Reverse frame-by-frame playback is not possible. 

## Pausing DVD video playback

Pause lets you temporarily stop disc playback.



### ● Press **▶/II** during playback.

The icon **II** is displayed and playback is paused, letting you view a still image.

- To resume playback at the same point that you turned pause on, press **▶/II** again.



### Note

Depending on the disc and the playback location on the disc, the icon  may be displayed, indicating that still playback is not possible. 

## Slow motion playback

This lets you slow down playback speed.

### 1 Press **II▶** and hold during playback.

The icon **▶▶** is displayed, forward slow motion playback begins.

- To return to normal playback, press **▶/II**.



### 2 Press **◀II** or **II▶** to adjust playback speed during slow motion playback.

Each time you press **◀II** or **II▶** it changes the speed in four steps in the following order:

1/16—1/8—1/4—1/2



### Notes

- There is no sound during slow motion playback.
- Depending on the disc and the playback location on the disc, the icon  may be displayed, indicating that slow motion playback is not possible.
- With some discs, images may be unclear during slow motion playback. 

## Changing audio language during playback (Multi-audio)

DVDs can provide audio playback with different languages and different systems (Dolby Digital, DTS etc.). With DVDs featuring multi-audio recordings, you can switch between languages/audio systems during playback.

### 1 Press **AUDIO** during playback.



The audio selection icon  is displayed for eight seconds.

### 2 Press **AUDIO** while the audio selection icon is displayed.

The audio changes each time you press **AUDIO**.

## Playing DVD video discs

### Notes

- The number in the  mark on a DVD's package indicates the number of recorded languages/audio systems.
- With some DVDs, switching between languages/audio systems may only be possible using a menu display.
- You can also switch between languages/audio systems using **SET-UP MENU**. For details, refer to *Setting the audio language* on page 77.
- Only digital output of DTS audio is possible. If this unit's optical digital outputs are not connected, DTS audio will not be output, so select an audio setting other than DTS.
- While the audio selection icon is displayed, you can also switch to a desired audio language number using **NUMBER**.
- Display indications such as **Dolby D** and **5.1ch** indicate the audio system recorded on the DVD. Depending on the setting, playback may not be with the same audio system as that indicated. .

## Changing the subtitle language during playback (Multi-subtitle)

With DVDs featuring multi-subtitle recordings, you can switch between subtitle languages during playback.



### 1 Press **SUBTITLE (S.TITILE)** during playback.

The subtitle selection icon  is displayed for eight seconds.

### 2 Press **SUBTITLE (S.TITILE)** while the subtitle selection icon is displayed.

The subtitle language changes each time you press **SUBTITLE (S.TITILE)**.

### Notes

- The number in the  mark on a DVD's package indicates the number of recorded subtitle languages.
- With some DVDs, switching between subtitle languages may only be possible using a menu display.
- You can also switch between subtitle languages using **SET-UP MENU**. For details, refer to *Setting the subtitle language* on page 76.
- While the subtitle selection icon is displayed, you can also switch to a desired subtitle language number using **NUMBER**. At this time, you can also switch subtitle display off by pressing **CLEAR**. .

## Changing the viewing angle during playback (Multi-angle)

With DVDs featuring multi-angle (scenes shot from multiple angles) recordings, you can switch among viewing angles during playback.

- During playback of a scene shot from multiple angles, the angle icon  is displayed. Turn angle icon display on or off using **SET-UP MENU**. For details, refer to *Setting angle icon display* on page 78.



### 1 Press **ANGLE** during playback of a scene shot from multiple angles.

The angle icon  and angle number **1** are displayed for eight seconds.

### 2 Press **ANGLE** while the angle icon and angle number are displayed.

The angle changes each time you press **ANGLE**.

### Notes

- The  mark on a DVD's package indicates it features multi-angle scenes. The number in the  mark indicates the number of angles from which scenes were shot.
- Pressing **ANGLE** during fast forward/fast reverse, pause or slow motion playback returns you to normal playback, but the viewing angle does not change.
- While the angle icon and angle number are displayed, you can also switch to a desired angle number using **NUMBER**. 

## Resume playback (Bookmark)

The Bookmark function lets you resume playback from a selected scene the next time the disc is loaded.

To perform this function, set the remote control to **DVD** mode.

- **During playback, press BOOKMARK (BOOK.M) at the point you want to resume playback next time.**

The selected scene will be bookmarked so that playback resumes from that point next time. You can bookmark up to five discs. After that, the oldest bookmark is replaced by the new one.

- To clear the bookmark on a disc, press and hold **BOOKMARK (BOOK.M)** during playback.
- You can also bookmark a disc by pressing and holding **EJECT** at the point you want to bookmark. Next time you load the disc, playback will resume from the bookmarked point. Note that you can only bookmark one disc using this method. To clear the bookmark on a disc, press **EJECT**. 

## Operating from the information displays

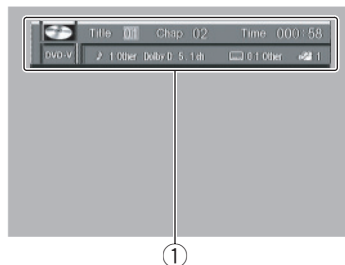

Information display 1 lets you use the search function to specify a title or chapter to search for a desired scene, use the time search function to specify a time to search for a desired scene, select the desired audio and subtitle language, and select the angle.

In addition to the search and time search functions of the information display 1, information display 2 lets you select the range for repeat play.

### ① Information display

Shows the function status.

- **Press DISP to switch the information display.**

Press **DISP** repeatedly to switch between the following display modes:

**Information display 1—Information display 2—Normal playback display**

### Notes

- You can perform title, chapter and time settings with either the information display 1 or 2. This manual explains how to use the information display 1 to perform title, chapter and time settings.
- Pressing **DISP** during fast forward/reverse returns you to normal playback.



## Playing DVD video discs

### Searching for a desired scene, starting playback from a specified time

You can use the search function to search for a desired scene by specifying a title or chapter, and the time search function to specify the time on a disc at which play starts.

#### 1 Move the joystick left or right to select a desired option.

The selected option is highlighted.

#### 2 Press NUMBER to input the desired number.

##### For titles and chapters

- To select 3, press **3**.
- To select 10, press **1** and **0** in order.
- To select 23, press **2** and **3** in order.
  - To jump 10 titles or chapters ahead of the selected one, press **10**.

##### For time (time search)

- To select 21 minutes 43 seconds, press **2**, **1**, **4** and **3** in order.
- To select 1 hour 11 minutes, convert the time into 71 minutes 00 seconds and press buttons **7**, **1**, **0** and **0** in order.
  - To jump 10 seconds ahead of the selected time, press **10**.
- Pressing **BAND/ESC** cancels the input number.
- You can also select titles and chapters by moving the joystick up or down.
  - You cannot select titles and chapters by using **NUMBER** when the remote control is set to **DVH** mode. In this case, use the joystick to select titles and chapters.

#### 3 While the input number is displayed, click the joystick.

This starts playback from the selected scene.



#### Notes

- With discs featuring a menu, you can also press **MENU** or **TOP MENU (TOP.M)** and then make selections from the displayed menu.
- With some discs, the icon  may be displayed, indicating that titles, chapters and time cannot be specified.
- Chapter search and time search are not possible when disc playback has been stopped.
- Even without using an information display you can start playback from a specified title or chapter. For details, refer to *Specifying title* on page 21 and *Specifying chapter* on page 21.

### Selecting audio, subtitle and angle

You can perform audio (language, stereo, audio type as Dolby Digital etc.), subtitle language and angle selection.

#### 1 Move the joystick left or right to select a desired option.

The selected option is highlighted.

#### 2 Move the joystick up or down to switch to the desired setting.

This switches you to the selected setting.

##### For Audio

Selection options switch as follows:

**Audio 1—Audio 2—Audio 3**

##### For Subtitles

Selection options switch as follows:

**Subtitles 1—Subtitles 2—Subtitles 3**

##### For Angle

Selection options switch as follows:

**Angle 1—Angle 2—Angle 3**



#### Notes

- The number of switching options depends on how many options are recorded on the DVD.
- You can switch audio, subtitle and angle during playback using the respective buttons.

## Playing DVD video discs

- You can also switch settings by inputting numbers with **NUMBER**.
- Display indications such as **Dolby D** and **5.1ch** indicate the audio system recorded on the DVD. Depending on the setting, playback may not be with the same audio system as that indicated.

### Selecting repeat range

You can choose between repeat play of a disc, title or chapter.

**1 Press DISP to switch to the information display 2.**

**2 Move the joystick left or right to select the repeat range option.**

The repeat range option is highlighted.

**3 Move the joystick up or down to switch to the desired setting.**

This switches you to the selected setting.

- **Disc** – Repeat the current disc
- **Title** – Repeat just the current title
- **Chapter** – Repeat just the current chapter

#### Note

Certain DVD discs display a menu upon completion of repeat playback.

### Selecting audio output

You can switch between stereo and monaural audio output.

**1 Press DISP to switch to the information display 2.**

**2 Move the joystick left or right to select the audio option.**

The audio option is highlighted.

**3 Move the joystick up or down to switch to the desired setting.**

This switches you to the selected setting.

- **L+R** – Left and right
- **L** – Left
- **R** – Right

#### Note

This function is possible only with Linear PCM sound. 

## Playing DVD video discs

### Operating from the function display

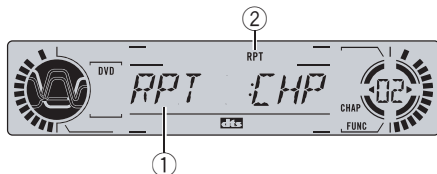

The following functions can also be operated from the head unit's display.

#### ① Function display

Shows the function status.

#### ② RPT indicator

Shows when repeat range is selected to current chapter.

#### ● Press F to display the function names.

Press **F** repeatedly to switch between the following functions:

**RPT** (repeat play)—**PAUSE** (pause)

- To return to the playback display, press **BAND**.



#### Note

If you do not operate the function within about 30 seconds, the display is automatically returned to the playback display.

### Repeating play

There are three repeat play ranges for the DVD playback: **DSC** (disc repeat), **CHP** (chapter repeat), and **TTL** (title repeat).

#### 1 Press F to select RPT.

Press **F** until **RPT** appears in the display.

#### 2 During DVD playback, press ◀◀ or ▶▶ to select the repeat range.

Press ◀◀ or ▶▶ until the desired repeat range appears in the display.

- DSC** – Repeat the current disc
- TTL** – Repeat just the current title
- CHP** – Repeat just the current chapter



#### Notes

- If you perform chapter search or fast forward/reverse during **CHP**, the repeat play range changes to **DSC**.
- You cannot operate repeating play when **DVD AUTO PLAY** is on (refer to *Automatic playback of DVDs* on page 80).

### Pausing DVD video playback

Pause lets you temporarily stop disc playback.

#### 1 Press F to select PAUSE.

Press **F** until **PAUSE** appears in the display.

#### 2 Press II▶ to turn pause on.

**PAUSE:ON** appears in the display. Play of the current track pauses.

#### 3 Press ◀◀ to turn pause off.

**PAUSE:OFF** appears in the display. Play will resume at the same point that you turned pause on. □

## Watching a Video CD

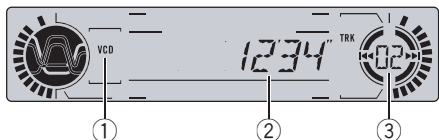

Head unit's display

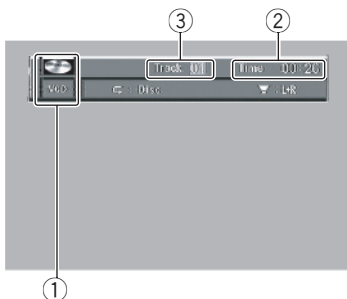

Information display

When the separately sold display is connected to this unit, the listed information will appear on it.

These are the basic steps necessary to play a Video CD with your DVD player. More advanced Video CD operation is explained starting on page 30.

### ① VCD indicator

Shows when a Video CD is playing.

### ② Play time indicator

Shows the elapsed playing time of the current track.

### ③ Track number indicator

Shows the track currently playing.

## Basic operation of Video CD

### 1 Press NUMBER to select the desired menu option.

When a Video CD featuring the PBC (playback control) function starts playing, a menu is displayed.

- Playback starts from the selected menu item.
- When the menu is two or more pages long, press **I◀◀** or **▶▶I** to switch between displays.
- You can display the menu by pressing **RETURN** during PBC playback. For details, refer to the instructions provided with the disc.
- Operation with the joystick is not possible.
- If the remote control is set to **DVH** mode, **I◀◀** and **▶▶I** are assigned to other functions. Use **◀◀** and **▶▶** instead for the **DVD** mode functions controlled by **I◀◀** and **▶▶I**.

### 2 To perform fast forward or reverse, press and hold ◀◀ or ▶▶.

- If you continue pressing **◀◀** or **▶▶** for five seconds, the color of the icon **◀◀/▶▶** changes from white to blue. When this happens, fast reverse/fast forward continues even if you release **◀◀** or **▶▶**. To resume playback at a desired point, press **▶/II**.
- Fast forward/fast reverse may not be possible at certain locations on some discs. If this happens, normal playback automatically resumes.

### 3 To skip back or forward to another track, press I◀◀ or ▶▶I.

Pressing **▶▶I** skips to the start of the next track. Pressing **I◀◀** once skips to the start of the current track. Pressing again will skip to the previous track. Track numbers are displayed for eight seconds.

- Using **NUMBER** also performs the same operation. For more details, refer to *Specifying track* on the next page.

## Playing Video CDs

- If the remote control is set to **DVH** mode, **I◀◀** and **▶▶I** are assigned to other functions. Use **◀◀** and **▶▶** instead for the **DVD** mode functions controlled by **I◀◀** and **▶▶I**.

### 4 To stop playback, press ■.

- When you stop Video CD playback by pressing **■**, that location on the disc is memorized enabling playback from that point when you play the disc again.
- To resume playback, press **▶/II**.
- If the remote control is set to **DVH**, **■** does not operate. 

## Specifying track

To perform this function, set the remote control to **DVD** mode.



- You cannot operate this function by using **NUMBER** when the remote control is set to **DVH** mode.

### ● Press NUMBER corresponding to a desired track number during playback.

Track number is displayed for eight seconds and playback starts from the selected track.

- To select 3, press **3**.
- To select 10, press **10** and **0** in that order.
- To select 23, press **10**, **10** and **3** in that order.

### Notes

- With some discs, the icon  may be displayed and operation may not be possible.
- With Video CD, direct search is not possible during PBC playback. 

## Selecting a track directly

When using the remote control, you can select a track directly by entering the desired track number.

### 1 Press DIRECT.

Track number input display appears.

### 2 Press NUMBER buttons to enter the desired track number.

- To select 3, press **3**.
- To select 10, press **1** and **0** in order.
- You can cancel the input number by pressing **CLEAR**.

### 3 Press DIRECT.

The track of entered number will play.



### Notes

- After entering the number input mode, if you do not perform an operation within about eight seconds, the mode is automatically canceled.
- During playback of Video CDs featuring PBC (playback control), this function cannot be operated. 

## Pausing Video CD playback

Pause lets you temporarily stop disc playback.



### ● Press ▶/II during playback.

The icon **II** is displayed and playback is paused, letting you view a still image.

- To resume playback at the same point that you turned pause on, press **▶/II** again.



### Note

Depending on the disc and the playback location on the disc, the icon  may be displayed, indicating that still playback is not possible. 

## Slow motion playback

This lets you slow down playback speed.

### 1 Press **II>** and hold during playback.

The icon **II>** is displayed, forward slow motion playback begins.



- To return to normal playback, press **II>/II**.

### 2 Press **<II** or **II>** to adjust playback speed during slow motion playback.

Each time you press **<II** or **II>** it changes the speed in four steps in the following order:  
1/16—1/8—1/4—1/2



#### Notes

- There is no sound during slow motion playback.
- Depending on the disc and the playback location on the disc, the icon  may be displayed, indicating that slow motion playback is not possible.
- With some discs, images may be unclear during slow motion playback. .

## Operating from the information display



This display lets you use the search function to specify a track to search for desired scenes, use the time search function to specify a time to search for a desired scene, switch audio output, and select the range for repeat play. During playback of Video CDs featuring PBC (Playback Control), **PLAYBACK CONTROL ON** is displayed. During such playback, search and time search functions cannot be used nor can you select the range for repeat play. (Refer to *Selecting repeat range* on the next page.)

- PBC playback of Video-CD cannot be cancelled.

### ① Information display

Shows the function status.

### ● Press **DISP** to switch the information display.

Press **DISP** repeatedly to switch between the following display modes:

**Information display—Normal playback display**

## Playing Video CDs

### Searching for a desired scene, starting playback from a specified time

You can use the search function to search for a desired scene by specifying a track, and the time search function to specify the time on a disc at which play starts.

- During playback of Video CDs featuring PBC (playback control), this function cannot be operated.
- Track search and time search are not possible when disc playback has been stopped.

#### 1 Move the joystick left or right to select a desired option.

The selected option is highlighted.

#### 2 Press NUMBER to input the desired number.

##### For tracks

- To select 3, press **3**.
- To select 10, press **1** and **0** in order.
- To select 23, press **2** and **3** in order.
  - To jump 10 tracks ahead of the selected one, press **10**.

##### For time (time search)

- To select 21 minutes 43 seconds, press **2**, **1**, **4** and **3** in order.
- To select 1 hour 11 minutes, convert the time into 71 minutes 00 seconds and press buttons **7**, **1**, **0** and **0** in order.
  - To jump 10 seconds ahead of the selected time, press **10**.
- Pressing **CLEAR** cancels the input number.
- You can also select tracks by moving the joystick up or down.
- You cannot select tracks by using **NUMBER** when the remote control is set to **DVH** mode. In this case, use the joystick to select tracks.

#### 3 While the input number is displayed, click the joystick.

This starts playback from the selected scene.



#### Notes

- Time search is not possible when disc playback has been stopped.
- Even without using an information display you can start playback from a specified track. For details, refer to *Specifying track* on page 29.

### Selecting repeat range

You can choose between repeat play of a disc or a track.

#### 1 Move the joystick left or right to select the repeat range option.

The repeat range option is highlighted.

#### 2 Move the joystick up or down to switch to the desired setting.

This switches you to the selected setting.

- **Disc** – Repeat the current disc
- **Track** – Repeat just the current track



#### Notes

- When repeat play of a Video CD disc is selected, a menu may be displayed after playback depending on the disc.
- During playback of Video CDs featuring PBC (playback control), this function cannot be operated.

### Selecting audio output

You can switch between stereo and monaural audio output.

#### 1 Move the joystick left or right to select the audio option.

The audio option is highlighted.

#### 2 Move the joystick up or down to switch to the desired setting.

This switches you to the selected setting.

- **L+R** – Left and right
- **L** – Left
- **R** – Right 

## Operating from the function display

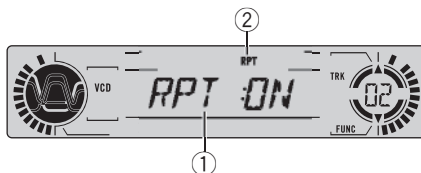

Repeat and pause functions can also be operated from the head unit's display.

### ① Function display

Shows the function status.

### ② RPT indicator

Shows when repeat play is turned on.

### ● Press F to display the function names.

Press **F** repeatedly to switch between the following functions:

**RPT** (repeat play)—**PAUSE** (pause)

- During PBC (Playback Control) playback, you cannot select **RPT**.
- To return to the playback display, press **BAND**.



### Note

If you do not operate the function within about 30 seconds, the display is automatically returned to the playback display.

## Repeating play

Repeat play lets you play the same track over again.

- During playback of Video CDs featuring PBC (playback control), this function cannot be operated.



## Playing Video CDs

### 1 Press **F** to select **RPT**.

Press **F** until **RPT** appears in the display.

### 2 Press **II▶** to turn repeat play on.

**RPT:ON** appears in the display. The track currently playing will play to the end and then repeat.

### 3 Press **◀II** to turn repeat play off.

**RPT:OFF** appears in the display. The track currently playing will continue to play and then play the next track.



#### Note

If you perform track search or fast forward/reverse, repeat play is automatically cancelled.

## Pausing playback

Pause lets you temporarily stop disc playback.

### 1 Press **F** to select **PAUSE**.

Press **F** until **PAUSE** appears in the display.

### 2 Press **II▶** to turn pause on.

**PAUSE:ON** appears in the display. Play of the current track pauses.

### 3 Press **◀II** to turn pause off.

**PAUSE:OFF** appears in the display. Play will resume at the same point that you turned pause on. 

## Listening to a CD

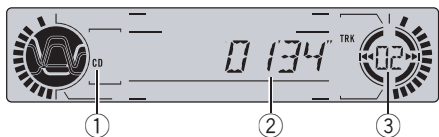

Head unit's display

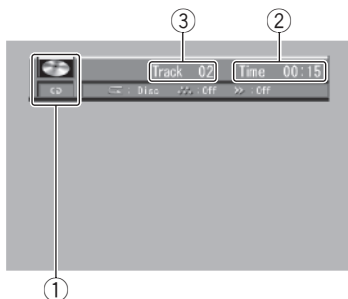

When the separately sold display is connected to this unit, the listed information will appear on it.

Information display

These are the basic steps necessary to play a CD with your DVD player. More advanced CD operation is explained starting on the next page.

- ① **CD indicator**  
Shows when a CD is playing.
- ② **Play time indicator**  
Shows the elapsed playing time of the current track.
- ③ **Track number indicator**  
Shows the track currently playing. ■

## Basic operation of CD

**1 To perform fast forward or reverse, press and hold ◀◀ or ▶▶.**

- This is fast forward and reverse operation only for the track being played. This operation is canceled when the previous or next track is reached.
- If you select **ROUGH**, pressing and holding ◀◀ or ▶▶ enables you to search every 10 tracks in the current disc. (Refer to *Selecting the search method* on page 38.)

**2 To skip back or forward to another track, press ◀ or ▶.**

Pressing ▶ skips to the start of the next track. Pressing ◀ once skips to the start of the current track. Pressing again will skip to the previous track.

- If the remote control is set to **DVH** mode, ◀◀ and ▶▶ are assigned to other functions. Use ◀◀ and ▶▶ instead for the **DVD** mode functions controlled by ◀◀ and ▶▶.

**3 To stop playback, press ■.**

- When you stop CD playback by pressing ■, that location on the disc is memorized enabling playback from that point when you play the disc again.
- To resume playback, press ▶/II.
- If the remote control is set to **DVH**, ■ does not operate.

## Selecting a track directly

When using the remote control, you can select a track directly by entering the desired track number.

**1 Press DIRECT.**

Track number input display appears.

**2 Press NUMBER buttons to enter the desired track number.**

- To select 3, press **3**.
- To select 10, press **1** and **0** in order.

## Playing CDs

- You can cancel the input number by pressing **CLEAR**.

### 3 Press **DIRECT**.

The track of entered number will play.



#### Note

After entering the number input mode, if you do not perform an operation within about eight seconds, the mode is automatically canceled.

## Operating from the information display

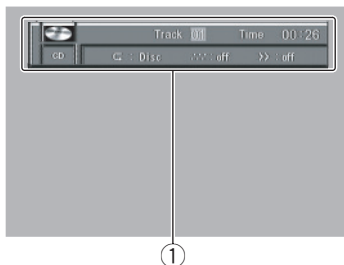

This display lets you use the search function to specify a track to search for desired track, select the range for repeat play, and switch random play and scan play on or off.

### ① Information display

Shows the function status.

## Searching for a desired track

You can use the search function to specify a track to search for a desired track.

### 1 Move the joystick left or right to select the track option.

The track option is highlighted.

### 2 Press **NUMBER** to input the desired number.

- To select 3, press **3**.
- To select 10, press **1** and **0** in order.
- To select 23, press **2** and **3** in order.
  - To jump 10 tracks ahead of the selected one, press **10**.
- Pressing **CLEAR** cancels the input number.
- You can also select tracks by moving the joystick up or down.
- You cannot select tracks by using **NUMBER** when the remote control is set to **DVH** mode. In this case, use the joystick to select tracks.

### 3 While the input number is displayed, click the joystick.

Play of the selected track starts.

## Selecting repeat range

You can choose between repeat play of a disc or a track.

### 1 Move the joystick left or right to select the repeat range option.

The repeat range option is highlighted.

### 2 Move the joystick up or down to switch to the desired setting.

This switches you to the selected setting.

- **Disc** – Repeat the current disc
- **Track** – Repeat just the current track



#### Note

If you perform track search or fast forward/reverse, repeat play is automatically cancelled.

## Setting random play

Random play lets you play back tracks on the CD in a random order.

### 1 Move the joystick left or right to select the random option.

The random option is highlighted.

### 2 Move the joystick up or down to switch to the desired setting.

This switches you to the selected setting.

- **ON** – Tracks will play in a random order
- **OFF** – Tracks will continue to play in order

## Setting scan play

Scan play lets you hear the first 10 seconds of each track on the CD.

### 1 Move the joystick left or right to select the scan option.

The scan option is highlighted.

### 2 Move the joystick up or down to switch to the desired setting.

This switches you to the selected setting.

- **ON** – The first 10 seconds of each track is played
- **OFF** – Tracks will continue to play

### 3 When you find the desired track, move the joystick up or down to cancel the scan play.



#### Note

After scanning of a CD is finished, normal playback of the tracks will begin again.

## Pausing CD playback

Pause lets you temporarily stop disc playback.

### ● Press ►/II during playback.

The icon **II** is displayed and playback is paused, letting you view a still image.

- To resume playback at the same point that you turned pause on, press ►/II again.

## Using CD TEXT functions

Some discs have certain information encoded on the disc during manufacture. These discs may contain such information as the CD title, track title, artist's name and playback time and are called CD TEXT discs. Only these specially encoded CD TEXT discs support the functions listed below.

## Playing CDs

### Displaying titles on CD TEXT discs

- Press **DISP** to switch the information display.

Press **DISP** repeatedly to switch between the following display modes:

**Information display** —**Disc Title** (disc title display)—**Disc Artist** (disc artist name display)  
—**Track Title** (track title display)—**Track Artist** (track artist name display)

- If specific information has not been recorded on a CD TEXT disc, **No XXXX** will be displayed (e.g., **No Track Title**).
- Some characters may not be displayed properly.

### Scrolling titles in the display

This unit can display the first 8 letters only of **DISC TTL**, **ART NAME**, **TRK TTL** and **ART NAME**. When the recorded information is longer than 8 letters, you can scroll the text to the left so that the rest of the title can be seen.

- Press **DISPLAY** and hold until the title begins to scroll to the left.

The rest of the title will appear in the display. 

### Operating from the function display

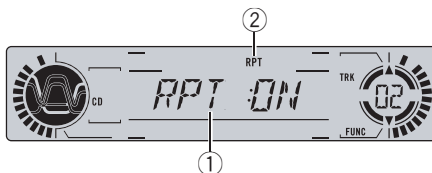

The following functions can also be operated from the head unit's display.

#### ① Function display

Shows the function status.

#### ② RPT indicator

Shows when repeat play is turned on.

- Press **F** to display the function names.

Press **F** repeatedly to switch between the following functions:

**RPT** (repeat play)—**RDM** (random play)  
—**SCAN** (scan play)—**PAUSE** (pause)  
—**FF/REV** (search method)

- To return to the playback display, press **BAND**.



#### Note

If you do not operate the function within about 30 seconds, the display is automatically returned to the playback display.

### Repeating play

Repeat play lets you hear the same track over again.

#### 1 Press **F** to select **RPT**.

Press **F** until **RPT** appears in the display.

## Playing CDs

### 2 Press **II▶** to turn repeat play on.

**RPT:ON** appears in the display. The track currently playing will play to the end and then repeat.

### 3 Press **◀II** to turn repeat play off.

**RPT:OFF** appears in the display. The track currently playing will continue to play and then play the next track.



#### Note

If you perform track search or fast forward/reverse, repeat play is automatically cancelled.

## Playing tracks in a random order

Random play lets you play back tracks on the CD in a random order.

### 1 Press **F** to select **RDM**.

Press **F** until **RDM** appears in the display.

### 2 Press **II▶** to turn random play on.

**RDM:ON** appears in the display. Tracks will play in a random order.

### 3 Press **◀II** to turn random play off.

**RDM:OFF** appears in the display. Tracks will continue to play in order.

## Scanning tracks of a CD

Scan play lets you hear the first 10 seconds of each track on the CD.

### 1 Press **F** to select **SCAN**.

Press **F** until **SCAN** appears in the display.

### 2 Press **II▶** to turn scan play on.

**SCAN:ON** appears in the display. The first 10 seconds of each track is played.

### 3 When you find the desired track press

#### **◀II** to turn scan play off.

**SCAN:OFF** appears in the display. The track will continue to play.

- If the display has automatically returned to the playback display, select **SCAN** again by pressing **F**.



#### Note

After scanning of a CD is finished, normal playback of the tracks will begin again.

## Pausing CD playback

Pause lets you temporarily stop disc playback.

### 1 Press **F** to select **PAUSE**.

Press **F** until **PAUSE** appears in the display.

### 2 Press **II▶** to turn pause on.

**PAUSE:ON** appears in the display. Play of the current track pauses.

### 3 Press **◀II** to turn pause off.

**PAUSE:OFF** appears in the display. Play will resume at the same point that you turned pause on.

## Selecting the search method

You can switch the search method between fast forward/reverse and searching every 10 tracks.

### 1 Press **F** to select **FF/REV**.

Press **F** until **FF/REV** appears in the display.

- If the search method **ROUGH** has been previously selected, **ROUGH** will be displayed.

### 2 Press **◀◀** or **▶▶** to select the search method.

Press **◀◀** or **▶▶** until the desired search method appears in the display.

- **FF/REV** – Fast forward and reverse
- **ROUGH** – Searching every 10 tracks

## Playing CDs

### Using disc title functions

You can input CD titles and display the title. The next time you insert a CD for which you have entered a title, the title of that CD will be displayed.

### Entering disc titles

Use the disc title input feature to store up to 48 CD titles in the unit. Each title can be up to 8 characters long.

#### 1 Play the CD that you want to enter a title for.

#### 2 Press **F** and hold until **TITLE IN** appears in the display.

▪ When playing a CD TEXT disc, you cannot switch to **TITLE IN**. The disc title will have already been recorded on a CD TEXT disc.

#### 3 Press **II▶** or **◀II** to select a letter of the alphabet.

Each press of **II▶** will display a letter of the alphabet in **A B C ... X Y Z**, numbers and symbols in **1 2 3 ... > [ ]** order. Each press of **◀II** will display a letter in the reverse order, such as **Z Y X ... C B A** order.



#### 4 Press **▶▶** to move the cursor to the next character position.

When the desired letter is displayed, press **▶▶** to move the cursor to the next position and then select the next letter. Press **◀◀** to move backwards in the display.

#### 5 Move the cursor to the last position by pressing **▶▶** after entering the title.

When you press **▶▶** one more time, the entered title is stored in memory.

#### 6 Press **BAND** to return to the playback display.



#### Notes

- Titles remain in memory, even after the disc has been removed from the unit, and are recalled when the disc is reinserted.
- After data for 48 discs has been stored in memory, data for a new disc will overwrite the oldest one.

### Displaying disc titles

You can display the title of any disc that has had a disc title entered.

#### ● Press **DISPLAY** on the head unit.

Press **DISPLAY** on the head unit repeatedly to switch between the following settings:  
Play time—**DISC TTL** (disc title)

When you select **DISC TTL**, the title of the currently playing disc is shown in the display.

- When a CD with a disc title is inserted, the disc title automatically begins to scroll through the display.
- If no title has been entered for the currently playing disc, **NO D-TTL** is displayed.

### Using CD TEXT functions

Some discs have certain information encoded on the disc during manufacture. These discs may contain such information as the CD title, track title, artist's name and playback time and are called CD TEXT discs. Only these specially encoded CD TEXT discs support the functions listed below.

### Displaying titles on CD TEXT discs

#### ● Press **DISPLAY** on the head unit.

Press **DISPLAY** on the head unit repeatedly to switch between the following settings:

Play time—**DISC TTL** (disc title)—**ART NAME**  
(disc artist name)—**TRK TTL** (track title)  
—**ART NAME** (track artist name)

▪ If specific information has not been recorded on a CD TEXT disc, **NO XXXX** will be displayed (e.g., **NO T-TTL**).

### Scrolling titles in the display

This unit can display the first 8 letters only of **DISC TTL**, **ART NAME**, **TRK TTL** and **ART NAME**. When the recorded information is longer than 8 letters, you can scroll the text to the left so that the rest of the title can be seen.

- **Press DISPLAY on the head unit and hold until the title begins to scroll to the left.**

The rest of the title will appear in the display. ▣



## Playing MP3/WMA

### Listening to MP3/WMA

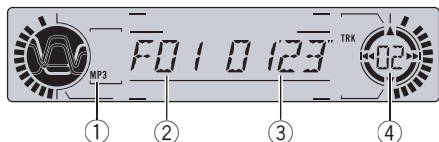

Head unit's display

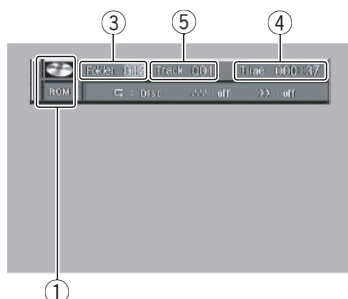

When the separately sold display is connected to this unit, the listed information will appear on it.

Information display

These are the basic steps necessary to play an MP3/WMA with your DVD player. More advanced MP3/WMA operation is explained starting on page 43.

#### ① ROM indicator

Shows when the MP3/WMA file is playing. When playing discs with MP3/WMA files and audio data (CD-DA) such as CD-EXTRA and MIXED-MODE CDs, **CD/ROM** is displayed.

#### ② Folder number indicator

Shows the number of folder currently playing.

- On the head unit's display, if the folder number is more than 100, **F** in the folder number indicator disappears.

#### ③ Play time indicator

Shows the elapsed playing time of the current track.

- If the play time is more than 100 minutes, only the last two digits of play time (minute) is displayed on the head unit's display.

#### ④ Track number indicator

Shows the track currently playing.

- If a track number 100 to 199 is selected, ► will light up above the last two digits of the track number.
- If a track number 200 or more is selected, ► will blink above the last two digits of the track number. ◻

## Basic operation of MP3/WMA

### 1 Press ►► or ◀◀ to select a folder.

- You cannot select a folder that does not have an MP3/WMA file recorded in it.
- To return to folder 01 (ROOT), press and hold **BAND**. However, if folder 01 (ROOT) contains no files, playback commences with folder 02.

### 2 To perform fast forward or reverse, press and hold ◀◀ or ►►.

- This is fast forward and reverse operation only for the file being played. This operation is canceled when the previous or next file is reached.
- If the remote control is set to **DVH** mode, ◀◀ and ►► are assigned to other functions. Use ◀◀ and ►► instead for the **DVD** mode functions controlled by ◀◀ and ►►.

### 3 To skip back or forward to another track, press ◀◀ or ►►.

Pressing ►► skips to the start of the next track. Pressing ◀◀ once skips to the start of the current track. Pressing again will skip to the previous track.

## Playing MP3/WMA

- If the remote control is set to **DVH** mode, **I◀◀** and **▶▶I** are assigned to other functions. Use **◀◀** and **▶▶** instead for the **DVD** mode functions controlled by **I◀◀** and **▶▶I**.

### 4 To stop playback, press ■.

- When you stop MP3/WMA playback by pressing **■**, that location on the disc is memorized enabling playback from that point when you play the disc again.
  - To resume playback, press **▶/II**.
  - If the remote control is set to **DVH**, **■** does not operate.



### Notes

- When playing discs with MP3/WMA files and audio data (CD-DA) such as CD-EXTRA and MIXED-MODE CDs, both types can be played only by switching mode between MP3/WMA and CD-DA with **BAND**.
- If you have switched between playback of MP3/WMA files and audio data (CD-DA), playback starts at the first track on the disc.
- This DVD player can play back an MP3/WMA file recorded on CD-ROM. (Refer to page 93 for files that can be played back.)
- There is sometimes a delay between starting up CD playback and the sound being issued. When being read in, **FRMTREAD** is displayed.
- Playback is carried out in order of file number. Folders are skipped if they contain no files. (If folder 01 (ROOT) contains no files, playback commences with folder 02.)
- When playing back files recorded as VBR (variable bit rate) files, the play time will not be correctly displayed if fast forward or reverse operations are used.
- This unit does not play back WMA files recorded as VBR (variable bit rate).
- If the inserted disc contains no files that can be played back, **NON-PLAY** is displayed.
- There is no sound on fast forward or reverse.
- If the inserted disc contains WMA files that are protected by digital rights management

(DRM), **SKIPPED** is displayed while the protected file is skipped.

- If all the files on the inserted disc are secured by DRM, **PROTECT** is displayed.
- When an MP3/WMA disc is inserted, folder name and file name begin to scroll to the left automatically.

## Selecting a track directly

When using the remote control, you can select a track directly by entering the desired track number.

### 1 Press DIRECT.

Track number input display appears.

### 2 Press NUMBER buttons to enter the desired track number.

- To select 3, press **3**.
- To select 10, press **1** and **0** in order.
  - You can cancel the input number by pressing **CLEAR**.

### 3 Press DIRECT.

The track of entered number will play.



### Note

After entering the number input mode, if you do not perform an operation within about eight seconds, the mode is automatically canceled. **□**

## Playing MP3/WMA

### Operating from the information display



This display lets you use the search function to specify a track or a folder to search for desired track or folder, select the range for repeat play, and switch random play, scan play and pause playback on or off.

#### ① Information display

Shows the function status.

#### ● Press DISP to switch the information display.

Press **DISP** repeatedly to switch between the following display modes:

**Information display** — **Folder Name** (folder name display)—**File Name** (file name display)  
 —**Track Title** (track title display)  
 —**Artist Name** (artist name display)  
 —**Album Title** (album title display)  
 —**Comment** (comment display)—**Bit Rate** (bit rate display)

- When playing back WMA files, album title and comment are not displayed.
- When playing back MP3 files recorded as VBR (variable bit rate) files, the bit rate value is not displayed even after switching to bit rate. (**VBR** will be displayed.)
- This unit does not play back WMA files recorded as VBR (variable bit rate).

- If specific information has not been recorded on an MP3/WMA disc, **No XXXX** will be displayed (e.g., **No Track Title**).
- Some characters may not be displayed properly.

### Scrolling titles in the display

This unit can display the first 8 letters only of **FOLDER**, **FILE**, **TRK TTL**, **ART NAME**, **ALBM TTL**, **COMMENT** and **Bit Rate**. When the recorded information is longer than 8 letters, you can scroll the text to the left so that the rest of the text information can be seen.

#### ● Press DISPLAY and hold until the title begins to scroll to the left.

The rest of the title will appear in the display.

### Searching for a desired track

You can use the search function to specify a track to search for a desired track.

#### 1 Move the joystick left or right to select the track option.

The track option is highlighted.

#### 2 Press NUMBER to input the desired number.

- To select 3, press **3**.
- To select 10, press **1** and **0** in order.
- To select 23, press **2** and **3** in order.
  - To jump 10 tracks ahead of the selected one, press **10**.
- Pressing **CLEAR** cancels the input number.
- You can also select tracks by moving the joystick up or down.
- You cannot select tracks by using **NUMBER** when the remote control is set to **DVH** mode. In this case, use the joystick to select tracks.

## Playing MP3/WMA

### 3 While the input number is displayed, click the joystick.

Play of the selected track starts.

## Selecting repeat range

For MP3/WMA playback, there are three repeat play ranges: **Folder** (folder repeat), **Disc** (one-track repeat) and **Track** (repeat all tracks).

### 1 Move the joystick left or right to select the repeat range option.

The repeat range option is highlighted.

### 2 Move the joystick up or down to switch to the desired setting.

This switches you to the selected setting.

- **Folder** – Repeat the current folder
- **Disc** – Repeat the current disc
- **Track** – Repeat just the current track



#### Notes

- If you select other folder during repeat play, the repeat play range changes to **Disc**.
- If you perform track search or fast forward/reverse during **Track**, the repeat play range changes to **Folder**.
- When **Folder** is selected, it is not possible to play back a subfolder of that folder.
- When playing discs with MP3/WMA files and audio data (CD-DA), repeat play performs within the currently playing data type even if **Disc** is selected.

## Setting random play

Random play lets you play back tracks in a random order within the repeat range, **Folder** and **Disc**.

### 1 Move the joystick left or right to select the random option.

The random option is highlighted.

### 2 Move the joystick up or down to switch to the desired setting.

This switches you to the selected setting.

- **ON** – Tracks will play in a random order within the previously selected **Folder** or **Disc** ranges
- **OFF** – Tracks will continue to play in order

## Setting scan play

While you are using **Folder**, the beginning of each track in the selected folder plays for about 10 seconds. When you are using **Disc**, the beginning of the first track of each folder is played for about 10 seconds.

### 1 Move the joystick left or right to select the scan option.

The scan option is highlighted.

### 2 Move the joystick up or down to switch to the desired setting.

This switches you to the selected setting.

- **ON** – The first 10 seconds of each track of the current folder (or the first track of each folder) is played
- **OFF** – Tracks will continue to play

### 3 When you find the desired track, move the joystick up or down to cancel the scan play.



#### Note

After track or folder scanning is finished, normal playback of the tracks will begin again.

## Pausing playback

Pause lets you temporarily stop disc playback.

## Playing MP3/WMA

- **Press ►/|| during playback.**

The icon **||** is displayed and playback is paused, letting you view a still image.

- To resume playback at the same point that you turned pause on, press ►/|| again. 

## Operating from the function display

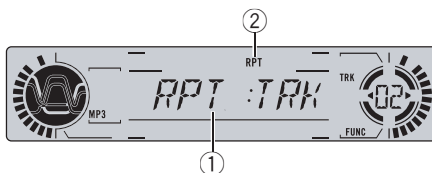

The following functions can also be operated from the head unit's display.

① **Function display**

Shows the function status.

② **RPT indicator**

Shows when repeat play is turned on.

- **Press F to display the function names.**

Press **F** repeatedly to switch between the following functions:

**RPT** (repeat play)—**RDM** (random play)

—**SCAN** (scan play)—**PAUSE** (pause)

—**FF/REV** (search method)

- To return to the playback display, press **BAND**.



### Note

If you do not operate the function within about 30 seconds, the display is automatically returned to the playback display.

## Repeating play

For MP3/WMA playback, there are three repeat play ranges: **FLD** (folder repeat), **TRK** (one-track repeat) and **DSC** (repeat all tracks).

**1 Press F to select RPT.**

Press **F** until **RPT** appears in the display.

## Playing MP3/WMA

### 2 Press ◀◀ or ▶▶ to select the repeat range.

Press ◀◀ or ▶▶ until the desired repeat range appears in the display.

- **FLD** – Repeat the current folder
- **TRK** – Repeat just the current track
- **DSC** – Repeat all tracks

#### Notes

- If you select another folder during repeat play, the repeat play range changes to **DSC**.
- If you perform track search or fast forward/reverse during **TRK**, the repeat play range changes to **FLD**.
- When **FLD** is selected, it is not possible to play back a subfolder of that folder.
- When playing discs with MP3/WMA files and audio data (CD-DA), repeat play performs within the currently playing data type even if **DSC** is selected.

## Playing tracks in a random order

Random play lets you play back tracks in a random order within the repeat range, **FLD** and **DSC**.

### 1 Select the repeat range.

Refer to *Repeating play* on the previous page.

### 2 Press F to select RDM.

Press **F** until **RDM** appears in the display.

### 3 Press **||▶** to turn random play on.

**RDM:ON** appears in the display. Tracks will play in a random order within the previously selected **FLD** or **DSC** ranges.

### 4 Press ◀◀ to turn random play off.

**RDM:OFF** appears in the display. Tracks will continue to play in order.

#### Note

If you turn random play on during **FLD** and then return to the playback display, **FRDM** appears in the display.

## Scanning folders and tracks

While you are using **FLD**, the beginning of each track in the selected folder plays for about 10 seconds. When you are using **DSC**, the beginning of the first track of each folder is played for about 10 seconds.

### 1 Select the repeat range.

Refer to *Repeating play* on the previous page.

### 2 Press F to select SCAN.

Press **F** until **SCAN** appears in the display.

### 3 Press **||▶** to turn scan play on.

**SCAN:ON** appears in the display. The first 10 seconds of each track of the current folder (or the first track of each folder) is played.

### 4 When you find the desired track (or folder) press ◀◀ to turn scan play off.

**SCAN:OFF** appears in the display. The track (or folder) will continue to play.

- If the display has automatically returned to the playback display, select **SCAN** again by pressing **F**.

#### Notes

- After track or folder scanning is finished, normal playback of the tracks will begin again.
- If you turn scan play on during **FLD** and then return to the playback display, **FSCN** appears in the display.

## Pausing MP3/WMA playback

Pause lets you temporarily stop disc playback.

## Playing MP3/WMA

### 1 Press F to select PAUSE.

Press **F** until **PAUSE** appears in the display.

### 2 Press II▶ to turn pause on.

**PAUSE:ON** appears in the display. Play of the current track pauses.

### 3 Press ◀II to turn pause off.

**PAUSE:OFF** appears in the display. Play will resume at the same point that you turned pause on.

## Selecting the search method

You can switch the search method between fast forward/reverse and searching every 10 tracks.

### 1 Press F to select FF/REV.

Press **F** until **FF/REV** appears in the display.

- If the search method **ROUGH** has been previously selected, **ROUGH** will be displayed.

### 2 Press ◀◀ or ▶▶ to select the search method.

Press ◀◀ or ▶▶ until the desired search method appears in the display.

- **FF/REV** – Fast forward and reverse
- **ROUGH** – Searching every 10 tracks

## Searching every 10 tracks in the current disc

If a disc contains over 10 tracks, you can search every 10 tracks. When a disc contains a lot of tracks, you can roughly search for the track you want to play.

### 1 Select the search method ROUGH.

Refer to *Selecting the search method* on this page.

### 2 Press and hold ◀◀ or ▶▶ to search every 10 tracks on a disc.

- If a disc contains less than 10 tracks, pressing and holding ▶▶ recalls the last track of the disc. Also, if the remaining number of tracks after searching every 10 tracks is less than 10, pressing and holding ▶▶ recalls the last track of the disc.
- If a disc contains less than 10 tracks, pressing and holding ◀◀ recalls the first track of the disc. Also, if the remaining number of tracks after searching every 10 tracks is less than 10, pressing and holding ◀◀ recalls the first track of the disc.

## Displaying text information on MP3/WMA disc

Text information recorded on a MP3/WMA disc can be displayed.

### ● Press DISPLAY.

Press **DISPLAY** repeatedly to switch between the following settings:

Play time—**FOLDER** (folder name)—**FILE** (file name)—**TRK TTL** (track title)—**ART NAME** (artist name)—**ALBM TTL** (album title)—**COMMENT** (comment)—Bit rate

- When playing back WMA files, album title and comment are not displayed.
- When playing back MP3 files recorded as VBR (variable bit rate) files, the bit rate value is not displayed even after switching to bit rate. (**VBR** will be displayed.)
- This unit does not play back WMA files recorded as VBR (variable bit rate).
- If specific information has not been recorded on an MP3/WMA disc, **NO XXXX** will be displayed (e.g., **NO NAME**).

## Scrolling text information in the display

This unit can display the first 8 letters only of **FOLDER**, **FILE**, **TRK TTL**, **ART NAME**, **ALBM TTL** and **COMMENT**. When the recorded information is longer than 8 letters, you can scroll the text to the left so that the rest of the text information can be seen.

- **Press DISPLAY and hold until the text information begins to scroll to the left.**

The rest of the text information will appear in the display. 



## Multi-CD Player

### Playing a CD

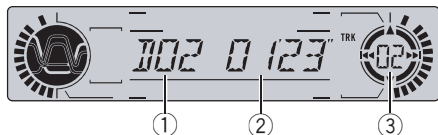

You can use this unit to control a multi-CD player, which is sold separately.

These are the basic steps necessary to play a CD with your multi-CD player. More advanced CD operation is explained starting on the next page.

#### ① Disc number indicator

Shows the disc currently playing.

#### ② Play time indicator

Shows the elapsed playing time of the current track.

#### ③ Track number indicator

Shows the track currently playing.

### 1 Press SOURCE to select the multi-CD player.

Press **SOURCE** until you see **MULTI-CD** displayed.

### 2 Select a disc you want to listen to with the NUMBER (1–6) buttons.

For discs located at 1 to 6, press the corresponding button number.

If you want to select a disc located at 7 to 12, press and hold the corresponding numbers, such as **1** for disc 7, until the disc number appears in the display.

- You can also sequentially select a disc by pressing **II▶** or **◀II**.

### 3 To perform fast forward or reverse, press and hold ◀◀ or ▶▶.

### 4 To skip back or forward to another track, press ◀◀ or ▶▶.

Pressing ◀◀ skips to the start of the next track. Pressing ▶▶ once skips to the start of the current track. Pressing again will skip to the previous track.



#### Notes

- When the multi-CD player performs the preparatory operations, **READY** is displayed.
- If the multi-CD player does not operate properly, an error message such as **ERROR-02** may be displayed. Refer to the multi-CD player owner's manual.
- If there are no discs in the multi-CD player magazine, **NO DISC** is displayed.
- When you select a CD TEXT disc on a CD TEXT compatible multi-CD player, the disc and track titles begin to scroll to the left automatically. 

### Selecting a track directly

When using the remote control, you can select a track directly by entering the desired track number.

#### 1 Press DIRECT.

Track number input display appears.

#### 2 Press NUMBER buttons to enter the desired track number.

- To select 3, press **3**.
- To select 10, press **1** and **0** in order.
- You can cancel the input number by pressing **CLEAR**.

#### 3 Press DIRECT.

The track of entered number will play.

**Note**

After entering the number input mode, if you do not perform an operation within about eight seconds, the mode is automatically canceled. 

**50-disc multi-CD player**

Only those functions described in this manual are supported for 50-disc multi-CD players.

This unit is not designed to operate disc title list functions with a 50-disc multi-CD player.

About the disc title list functions, please refer to *Selecting discs from the disc title list* on page 54. 

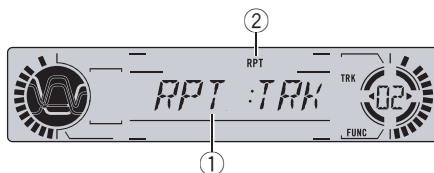
**Introduction of advanced multi-CD player operation****① Function display**

Shows the function status.

**② RPT indicator**

Shows when repeat range is selected to current track.

**● Press F to display the function names.**

Press **F** repeatedly to switch between the following functions:

**RPT** (repeat play)—**LIST** (disc title list)—**RDM** (random play)—**SCAN** (scan play)—**ITS-P** (ITS play)—**PAUSE** (pause)—**COMP** (compression and DBE)

- To return to the playback display, press **BAND**.

**Note**

If you do not operate the function within about 30 seconds, the display is automatically returned to the playback display. 

**Repeating play**

There are three repeat play ranges for the multi-CD player: **MCD** (multi-CD player repeat), **TRK** (one-track repeat) and **DSC** (disc repeat).

**1 Press F to select RPT.**

Press **F** until **RPT** appears in the display.

## Multi-CD Player

### 2 Press ◀◀ or ▶▶ to select the repeat range.

Press ◀◀ or ▶▶ until the desired repeat range appears in the display.

- **MCD** – Repeat all discs in the multi-CD player
- **TRK** – Repeat just the current track
- **DSC** – Repeat the current disc



#### Notes

- If you select other discs during repeat play, the repeat play range changes to **MCD**.
- If you perform track search or fast forward/reverse during **TRK**, the repeat play range changes to **DSC**. ◻

## Playing tracks in a random order

Random play lets you play back tracks in a random order within the repeat range, **MCD** and **DSC**.

### 1 Select the repeat range.

Refer to *Repeating play* on the previous page.

### 2 Press F to select RDM.

Press **F** until **RDM** appears in the display.

### 3 Press II▶ to turn random play on.

**RDM:ON** appears in the display. Tracks will play in a random order within the previously selected **MCD** or **DSC** ranges.

### 4 Press ◀II to turn random play off.

**RDM:OFF** appears in the display. Tracks will continue to play in order.



#### Note

If you turn random play on during **DSC** and then return to the playback display, **DRDM** appears in the display. ◻

## Scanning CDs and tracks

While you are using **DSC**, the beginning of each track on the selected disc plays for about 10 seconds. When you are using **MCD**, the beginning of the first track of each disc is played for about 10 seconds.

### 1 Select the repeat range.

Refer to *Repeating play* on the previous page.

### 2 Press F to select SCAN.

Press **F** until **SCAN** appears in the display.

### 3 Press II▶ to turn scan play on.

**SCAN:ON** appears in the display. The first 10 seconds of each track of the current disc (or the first track of each disc) is played.

### 4 When you find the desired track (or disc) press ◀II to turn scan play off.

**SCAN:OFF** appears in the display. The track (or disc) will continue to play.

- If the display has automatically returned to the playback display, select **SCAN** again by pressing **F**.



#### Notes

- After track or disc scanning is finished, normal playback of the tracks will begin again.
- If you turn scan play on during **DSC** and then return to the playback display, **DSCN** appears in the display. ◻

## Pausing CD playback

Pause lets you temporarily stop disc playback.

### 1 Press F to select PAUSE.

Press **F** until **PAUSE** appears in the display.

### 2 Press **II▶** to turn pause on.

**PAUSE:ON** appears in the display. Play of the current track pauses.

### 3 Press **◀II** to turn pause off.

**PAUSE:OFF** appears in the display. Play will resume at the same point that you turned pause on.



#### Note

Press **▶/II** on the remote control repeatedly during playback to turn pause on or off. 

## Using ITS playlists

ITS (instant track selection) lets you make a playlist of favorite tracks from those in the multi-CD player magazine. After you have added your favorite tracks to the playlist you can turn on ITS play and play just those selections.

## Creating a playlist with ITS programming

You can use ITS to enter and play back up to 99 tracks per disc, up to 100 discs (with the disc titles). (With multi-CD players sold before the CDX-P1250 and CDX-P650, up to 24 tracks can be stored in the playlist.)

### 1 Play a CD that you want to program.

Press **II▶** or **◀II** to select a CD.

### 2 Press F and hold until TITLE IN appears in the display, then press F to select ITS.

After **TITLE IN** is displayed, press **F** repeatedly, the following functions appear in the display: **TITLE IN** (disc title input)—**ITS** (ITS programming)

### 3 Select a desired track by pressing **◀◀** or **▶▶**.

### 4 Press **II▶** to store the currently playing track in the playlist.

**ITS IN** is displayed briefly and the currently playing selection is added to your playlist. The display then shows **ITS** again.

### 5 Press BAND to return to the playback display.



#### Note

After data for 100 discs has been stored in memory, data for a new disc will overwrite the oldest one.

## Playback from your ITS playlist

ITS play lets you listen to the tracks that you have entered into your ITS playlist. When you turn on ITS play, tracks from your ITS playlist in the multi-CD player will begin to play.

### 1 Select the repeat range.

Refer to *Repeating play* on page 50.

### 2 Press F to select ITS-P.

Press **F** until **ITS-P** appears in the display.

### 3 Press **II▶** to turn ITS play on.

**ITS-P:ON** appears in the display. Playback begins of those tracks from your playlist within the previously selected **MCD** or **DSC** ranges.

- If no tracks in the current range are programmed for ITS play then **EMPTY** is displayed.

## Multi-CD Player

### 4 Press ◀|| to turn ITS play off.

ITS-P:OFF appears in the display. Playback will continue in normal order from the currently playing track and CD.

## Erasing a track from your ITS playlist

To delete a track from your ITS playlist, make sure ITS play is on.

If ITS play is already on, skip to step 2.

### 1 Play the CD that contains the track you want to delete from your ITS playlist and turn ITS play on.

Refer to *Playback from your ITS playlist* on the previous page.

### 2 Press F and hold until TITLE IN appears in the display, then press F to select ITS.

After TITLE IN is displayed, press F until ITS appears in the display.

### 3 Select a desired track by pressing ◀◀ or ▶▶.

### 4 Press ◀|| to erase the track from your ITS playlist.

The currently playing selection is erased from your ITS playlist and playback of the next track from your ITS playlist begins.

- If there are no tracks from your playlist in the current range, EMPTY is displayed and normal play resumes.

### 5 Press BAND to return to the playback display.

## Erasing a CD from your ITS playlist

To delete all tracks of a CD from your ITS playlist, make sure ITS play is off.

### 1 Play the CD that you want to delete.

Press II▶ or ◀II to select a CD.

### 2 Press F and hold until TITLE IN appears in the display, then press F to select ITS.

After TITLE IN is displayed, press F until ITS appears in the display.

### 3 Press II▶ to erase all tracks on the currently playing CD from your ITS playlist.

All tracks on the currently playing CD are erased from your playlist and ITS CLR is displayed.

### 4 Press BAND to return to the playback display. ◻

## Using disc title functions

You can input CD titles and display the titles. Then you can easily search for and play a desired disc.

## Entering disc titles

Use the disc title input feature to store up to 100 CD titles (with ITS playlist) into the multi-CD player. Each title can be up to 8 characters long.

### 1 Play the CD with the title you want to enter.

Press II▶ or ◀II to select a CD.

### 2 Press F and hold until TITLE IN appears in the display.

After TITLE IN is displayed, press F repeatedly, the following functions appear in the display: TITLE IN (disc title input)—ITS (ITS programming)

- When playing a CD TEXT disc on a CD TEXT compatible multi-CD player, you cannot switch to **TITLE IN**. The disc title will have already been recorded on a CD TEXT disc.

### 3 Press **II▶** or **◀II** to select a letter of the alphabet.

Each press of **II▶** will display a letter of the alphabet in **A B C ... X Y Z**, numbers and symbols in **1 2 3 ... > [ ]** order. Each press of **◀II** will display a letter in the reverse order, such as **Z Y X ... C B A** order.

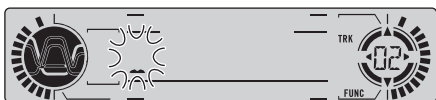

### 4 Press **▶▶** to move the cursor to the next character position.

When the desired letter is displayed, press **▶▶** to move the cursor to the next position and then select the next letter. Press **◀◀** to move backwards in the display.

### 5 Move the cursor to the last position by pressing **▶▶** after entering the title.

When you press **▶▶** one more time, the entered title is stored in memory.

### 6 Press **BAND** to return to the playback display.



#### Notes

- Titles remain in memory, even after the disc has been removed from the magazine, and are recalled when the disc is reinserted.
- After data for 100 discs has been stored in memory, data for a new disc will overwrite the oldest one.

## Displaying disc titles

You can display the title of any disc that has had a disc title entered.

### ● Press **DISPLAY** on the head unit.

Press **DISPLAY** on the head unit repeatedly to switch between the following settings:

Play time—**DISC TTL** (disc title)

When you select **DISC TTL**, the title of the currently playing disc is shown in the display.

- If no title has been entered for the currently playing disc, **NO D-TTL** is displayed.

## Selecting discs from the disc title list

Disc title list lets you see the list of disc titles that have been entered into the multi-CD player and lets you select one for playback.

### 1 Press **F** to select **LIST**.

Press **F** until **LIST** appears in the display.

### 2 Press **◀◀** or **▶▶** to scroll through the list of titles that have been entered.

- If no title has been entered for a disc, title is not displayed.

### 3 Press **II▶** to play your favorite CD title.

That selection will begin to play.

## Using CD TEXT functions

*You can use these functions only with a CD TEXT compatible multi-CD player.*

Some discs have certain information encoded on the disc during manufacture. These discs may contain such information as the CD title, track title, artist's name and playback time and are called CD TEXT discs. Only these specially encoded CD TEXT discs support the functions listed below.

## Multi-CD Player

### Displaying titles on CD TEXT discs

- **Press DISPLAY on the head unit.**

Press **DISPLAY** on the head unit repeatedly to switch between the following settings:  
 Play time—**DISC TTL** (disc title)—**ART NAME** (disc artist name)—**TRK TTL** (track title)—**ART NAME** (track artist name)

- If specific information has not been recorded on a CD TEXT disc, **NO XXXX** will be displayed (e.g., **NO T-TTL**).

### Scrolling titles in the display

This unit can display the first 8 letters only of **DISC TTL**, **ART NAME**, **TRK TTL** and **ART NAME**. When the recorded information is longer than 8 letters, you can scroll the text to the left so that the rest of the title can be seen.

- **Press DISPLAY on the head unit and hold until the title begins to scroll to the left.**

The rest of the title will appear in the display. 

### Using compression and dynamic bass emphasis

*You can use these functions only with a multi-CD player that supports them.*

Using COMP (compression) and DBE (dynamic bass emphasis) functions lets you adjust the sound playback quality of the multi-CD player. Each of the functions has a two-step adjustment. The COMP function balances the output of louder and softer sounds at higher volumes. DBE boosts bass levels to give playback a fuller sound. Listen to each of the effects as you select them and use the one that best enhances the playback of the track or CD that you are listening to.

#### 1 Press F to select COMP.

Press **F** until **COMP** appears in the display.

- If the multi-CD player does not support COMP/DBE, **NO COMP** is displayed when you attempt to select it.

#### 2 Press **II▶** or **◀II** to select your favorite setting.

Press **II▶** or **◀II** repeatedly to switch between the following settings:

**COMP OFF—COMP 1—COMP 2—  
 COMP OFF—DBE 1—DBE 2** 

## Introduction of audio adjustments

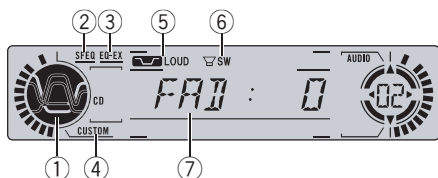

- ① **Preset equalizer indicator**  
Shows which equalizer preset is currently selected.  
When CUSTOM is selected, equalizer curve does not display.
- ② **SFEQ indicator**  
Appears in the display when SFEQ function can be activated.
- ③ **EQ-EX indicator**  
Appears in the display when EQ-EX function can be activated.
- ④ **CUSTOM indicator**  
Shows when custom equalizer curve is currently selected.
- ⑤ **Loudness indicator**  
Appears in the display when loudness is turned on.
- ⑥ **SW indicator**  
Shows when the subwoofer output is turned on.
- ⑦ **Audio display**  
Shows the audio adjustments status.

### Important

If the multi-channel processor (DEQ-P7650) is connected to this unit, the audio function will be

changed into the multi-channel processor's audio menu. For details, refer to *Introduction of DSP adjustments* on page 63.

### ● Press A to display the audio function names.

Press **A** repeatedly to switch between the following audio functions:

**FAD** (balance adjustment)—**EQ** (equalizer curve adjustment)—**B** (bass and treble level adjustment)—**LOUD** (loudness)—**SUB, W** (subwoofer on/off setting)/**NOFAD** (non fading output on/off setting)—**80: 0** (subwoofer setting)/**NOFAD** (non fading output setting)—**HPF** (high pass filter)—**SLA** (source level adjustment)

- If EQ-EX function has been selected and only when EQ-EX is turned on and **CUSTOM** is selected as the equalizer curve, you can switch to **B**.
- When the subwoofer controller setting is only **P/O :FUL**, you cannot switch to **SUB, W**. (Refer to page 83.)
- You can select the **80: 0** only when subwoofer output is turned on in the **SUB, W**.
- When the subwoofer controller setting is only **P/O :FUL**, you can switch to the nonfading output on/off setting. (Refer to page 83.)
- You can select the nonfading output setting only when nonfading output is turned on in the nonfading output on/off setting.
- When selecting the FM tuner as the source, you cannot switch to **SLA**.
- To return to the display of each source, press **BAND**.

### Note

If you do not operate the audio function within about 30 seconds, the display is automatically returned to the source display. 



## Audio Adjustments

### Compensating for equalizer curves (EQ-EX)

The EQ-EX function smoothes the effects of each equalizer curve. Furthermore, you can adjust bass and treble for each source when **CUSTOM** curve is selected.

- If SFEQ has been previously selected, press **EQ-EX** and hold to switch to EQ-EX and **EQ-EX** appears in the display.
- You cannot use EQ-EX function and SFEQ function simultaneously.

#### ● Press EQ-EX to turn EQ-EX on.

**EQ-EX:ON** appears in the display. EQ-EX is now on.

- To turn EQ-EX off, press **EQ-EX**. 

### Setting the sound focus equalizer (SFEQ)

Clarifying the sound image of vocals and instruments allows the simple staging of a natural, pleasant sound environment. Even greater listening enjoyment will be obtained if seating positions are chosen carefully. **FRT1** boosts the treble on the front output and the bass on the rear output. **FRT2** boosts the treble and the bass on the front output and the bass on the rear output. (The bass boost is the same for both front and rear.) For both **FRT1** and **FRT2**, **H** setting provides a more pronounced effect than **L** setting.

- You cannot use EQ-EX function and SFEQ function simultaneously.

#### 1 Press EQ-EX and hold to switch to SFEQ function.

Press **EQ-EX** and hold until **SFEQ** indicator appears in the display.

- To switch to EQ-EX function, press **EQ-EX** and hold.

#### 2 Press EQ-EX to select the desired SFEQ setting.

Press **EQ-EX** repeatedly to switch between the following settings:

- FRT1-H** (front 1-high)—**FRT1-L** (front 1-low)
- FRT2-H** (front 2-high)—**FRT2-L** (front 2-low)
- CUSTOM** (custom)—**SFEQ OFF** (off)

#### 3 Press ◀◀ or ▶▶ to select the desired position.

Press ◀◀ or ▶▶ until the desired position appears in the display.

**L** (left)—**C** (center)—**R** (right)



#### Notes

- If you adjust the bass or treble, **CUSTOM** memorizes an SFEQ setting in which the bass and treble are adjusted for personal preference.
- If you switch the SFEQ setting, the HPF function is automatically turned off. By turning the HPF function on after selecting the SFEQ setting, you can combine HPF function with SFEQ function. 

### Using balance adjustment

You can select a fader/balance setting that provides an ideal listening environment in all occupied seats.

#### 1 Press A to select FAD.

Press **A** until **FAD** appears in the display.

- If the balance setting has been previously adjusted, **BAL** will be displayed.

#### 2 Press ►► or ◀◀ to adjust front/rear speaker balance.

Each press of ►► or ◀◀ moves the front/rear speaker balance towards the front or the rear. **FAD:F15 – FAD:R15** is displayed as the front/rear speaker balance moves from front to rear.

- **FAD : 0** is the proper setting when only two speakers are used.
- When the rear output setting is **R-SP :S/W**, you cannot adjust front/rear speaker balance. Refer to *Setting the rear output and subwoofer controller* on page 83.

### 3 Press ◀◀ or ▶▶ to adjust left/right speaker balance.

When you press ◀◀ or ▶▶, **BAL : 0** is displayed. Each press of ◀◀ or ▶▶ moves the left/right speaker balance towards the left or the right.

**BAL : L9 – BAL : R9** is displayed as the left/right speaker balance moves from left to right. □

## Using the equalizer

The equalizer lets you adjust the equalization to match car interior acoustic characteristics as desired.

### Recalling equalizer curves

There are six stored equalizer curves which you can easily recall at any time. Here is a list of the equalizer curves:

Display	Equalizer curve
<b>POWERFUL</b>	Powerful
<b>NATURAL</b>	Natural
<b>VOCAL</b>	Vocal
<b>CUSTOM</b>	Custom
<b>EQ FLAT</b>	Flat
<b>SPR-BASS</b>	Super bass

- **CUSTOM** is an adjusted equalizer curve that you create.
- A separate **CUSTOM** curve can be created for each source. If you make adjustments,

the equalizer curve settings will be memorized in **CUSTOM**.

- When **EQ FLAT** is selected no supplement or correction is made to the sound. This is useful to check the effect of the equalizer curves by switching alternatively between **EQ FLAT** and a set equalizer curve.

### ● Press EQ to select the equalizer.

Press **EQ** repeatedly to switch between the following equalizers:

**POWERFUL—NATURAL—VOCAL—CUSTOM—EQ FLAT—SPR-BASS**

## Adjusting equalizer curves

You can adjust the currently selected equalizer curve setting as desired. Adjusted equalizer curve settings are memorized in **CUSTOM**.

### 1 Press A to select EQ.

Press **A** until **EQ** appears in the display.

### 2 Press ◀◀ or ▶▶ to select the equalizer band to adjust.

Each press of ◀◀ or ▶▶ selects equalizer bands in the following order:

**EQ-L** (low)—**EQ-M** (mid)—**EQ-H** (high)

### 3 Press ||▶ or ◀|| to adjust the level of the equalizer band.

Each press of ||▶ or ◀|| increases or decreases the level of the equalization band.

**+6 – –6** is displayed as the level is increased or decreased.

- You can then select another band and adjust the level.



### Note

If you make adjustments, **CUSTOM** curve is updated.

## Audio Adjustments

### Fine-adjusting equalizer curve

You can adjust the center frequency and the Q factor (curve characteristics) of each currently selected curve band (**EQ-L/EQ-M/EQ-H**).

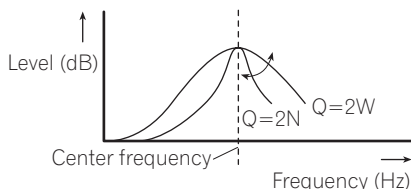

**1 Press A and hold until frequency and the Q factor (e.g., F-80:Q1W) appears in the display.**

**2 Press A to select the band for adjustment from among low, mid and high.**

Press **A** repeatedly to switch between the following functions:

Low—Mid—High—**B** (bass adjustment)—**T** (treble adjustment)

▪ If EQ-EX function has been selected and only when EQ-EX is turned on and **CUSTOM** is selected as the equalizer curve, you can switch to **B** and **T**.

**3 Press ◀◀ or ▶▶ to select the desired frequency.**

Press ◀◀ or ▶▶ until the desired frequency appears in the display.

Low: **40—80—100—160** (Hz)

Mid: **200—500—1k—2k** (Hz)

High: **3k—8k—10k—12k** (Hz)

**4 Press ||▶ or ◀|| to select the desired Q factor.**

Press ||▶ or ◀|| until the desired Q factor appears in the display.

**2N—1N—1W—2W**



#### Note

If you make adjustments, **CUSTOM** curve is updated. □

### Adjusting bass and treble

You can adjust bass and treble settings.

- If EQ-EX function has been selected and EQ-EX turned on and **CUSTOM** selected as the equalizer curve, you can adjust bass and treble settings.
- If SFEQ has been set to **FRT1**, bass adjustment affects only the rear output: front output cannot be adjusted.
- If SFEQ has been set to **FRT1** or **FRT2**, treble adjustment affects only the front output: rear output cannot be adjusted.

### Adjusting bass and treble level

You can adjust the bass and treble level.

**1 Press A to select B.**

Press **A** until **B** appears in the display.

▪ If the treble level has been previously adjusted, **T** will be displayed.

**2 Press ◀◀ or ▶▶ to select bass or treble.**

Press ◀◀ and **B** is displayed. Press ▶▶ and **T** is displayed.

**3 Press ||▶ or ◀|| to adjust the level.**

Each press of ||▶ or ◀|| increases or decreases the selected bass or treble level. **+6—-6** is displayed as the level is increased or decreased.

### Selecting bass frequency

You can select the bass frequency for level adjustment.

## Audio Adjustments

**1 Press A and hold until frequency and the Q factor (e.g., F- 80:Q1W) appears in the display.**

**2 Press A to select B.**

Press **A** until **B** appears in the display.

**3 Press ◀◀ or ▶▶ to select the desired frequency.**

Press ◀◀ or ▶▶ until the desired frequency appears in the display.

**40—63—100—160 (Hz)**

### Selecting treble frequency

You can select the treble frequency for level adjustment.

**1 Press A and hold until frequency and the Q factor (e.g., F- 80:Q1W) appears in the display.**

**2 Press A to select T.**

Press **A** until **T** appears in the display.

**3 Press ◀◀ or ▶▶ to select the desired frequency.**

Press ◀◀ or ▶▶ until the desired frequency appears in the display.

**2.5k—4k—6k—10k (Hz) ◻**

### Adjusting loudness

Loudness compensates for deficiencies in the low- and high-sound ranges at low volume.

**1 Press A to select LOUD.**

Press **A** until **LOUD** appears in the display.

**2 Press ◻▶ to turn loudness on.**

Loudness level (e.g., **LOUD :MID**) appears in the display.

**3 Press ◀◀ or ▶▶ to select a desired level.**

Each press of ◀◀ or ▶▶ selects level in the following order:

**LOW** (low)—**MID** (mid)—**HI** (high)

**4 Press ◻◻ to turn loudness off.**

**LOUD :OFF** appears in the display. ◻

### Using subwoofer output

This unit is equipped with a subwoofer output which can be turned on or off.

**1 Press A to select SUB, W.**

Press **A** until **SUB, W** appears in the display.

- When the subwoofer controller setting is **P/O :FUL**, you cannot select **SUB, W**.

**2 Press ◻▶ to turn subwoofer output on.**

**SUB, W:NOR** appears in the display. Subwoofer output is now on.

- If the subwoofer output phase has been set to the reverse, **SUB, W:REV** will be displayed.
- To turn subwoofer output off, press ◻◻.

**3 Press ◀◀ or ▶▶ to select the phase of subwoofer output.**

Press ◀◀ to select reverse phase and **REV** appears in the display. Press ▶▶ to select normal phase and **NOR** appears in the display.

### Adjusting subwoofer settings

When the subwoofer output is on, you can adjust the cut-off frequency and the output level of the subwoofer.

**1 Press A to select 80: 0.**

Press **A** until **80: 0** appears in the display.

- When the subwoofer output is on, you can select **80: 0**.

## Audio Adjustments

- If the subwoofer setting has been previously adjusted, the frequency of that previously selected will be displayed instead of **80**.

### 2 Press ◀◀ or ▶▶ to select cut-off frequency.

Each press of ◀◀ or ▶▶ selects cut-off frequencies in the following order:

**50—80—125** (Hz)

Only frequencies lower than those in the selected range are outputted from the subwoofer.

### 3 Press II▶ or ◀II to adjust the output level of the subwoofer.

Each press of II▶ or ◀II increases or decreases the level of the subwoofer. **+6 – –6** is displayed as the level is increased or decreased. ◻

## Using nonfading output

When the nonfading output setting is on, the audio signal does not pass through this unit's low pass filter (for the subwoofer), but is outputted through the RCA output.

### 1 Press A to select non fading output on/off setting.

Press **A** until **NOFAD:ON** appears in the display.

- When the subwoofer controller setting is only **P/O :FUL**, you can switch to the nonfading output on/off setting. (Refer to page 83.)

### 2 Press II▶ to turn non fading output on.

**NOFAD:ON** appears in the display. Nonfading output is now on.

- To turn non fading output off, press ◀II.

## Adjusting nonfading output level

When the nonfading output is on, you can adjust the level of nonfading output.

### 1 Press A to select non fading output setting.

Press **A** until **NOFAD: 0** appears in the display.

### 2 Press II▶ or ◀II to adjust the output level of the non fading.

Each press of II▶ or ◀II increases or decreases the level of the non fading. **+6 – –6** is displayed as the level is increased or decreased. ◻

## Using the high pass filter

When you do not want low sounds from the subwoofer output frequency range to play from the front or rear speakers, turn on the HPF (high pass filter). Only frequencies higher than those in the selected range are outputted from the front or rear speakers.

### 1 Press A to select HPF.

Press **A** until **HPF** appears in the display.

### 2 Press II▶ to turn high pass filter on.

**HPF: 80** appears in the display. High pass filter is now on.

- If the high pass filter has been previously adjusted, the frequency of that previously selected will be displayed instead of **HPF: 80**.
- To turn high pass filter off, press ◀II.

### 3 Press ◀◀ or ▶▶ to select cut-off frequency.

Each press of ◀◀ or ▶▶ selects cut-off frequencies in the following order:

**50—80—125** (Hz)

Only frequencies higher than those in the selected range are outputted from the front or rear speakers.



#### Note

If you switch the SFEQ setting, the HPF function is automatically turned off. By turning the HPF function on after selecting the SFEQ setting, you can combine HPF function with SFEQ function.

- DVD and the optional DVD player are set to the same source level adjustment volume automatically.
- External unit 1 and external unit 2 are set to the same source level adjustment volume automatically.

## Adjusting source levels

SLA (source level adjustment) lets you adjust the volume level of each source to prevent radical changes in volume when switching between sources.

- Settings are based on the FM tuner volume level, which remains unchanged.

**1 Compare the FM tuner volume level with the level of the source you wish to adjust.**

**2 Press A to select SLA.**

Press **A** until **SLA** appears in the display.

**3 Press  $\blacktriangleright$  or  $\blacktriangleleft$  to adjust the source volume.**

Each press of  $\blacktriangleright$  or  $\blacktriangleleft$  increases or decreases the source volume.

**SLA: +4 – SLA: -4** is displayed as the source volume is increased or decreased.



#### Notes

- The AM tuner volume level can also be adjusted with source level adjustments.
- Video CD, CD and MP3/WMA are set to the same source level adjustment volume automatically.

# Digital Signal Processor

## Introduction of DSP adjustments

### Important

Following functions are effective only when you connected a Pioneer multi-channel processor (DEQ-P7650) to this unit.

By carrying out the following settings/adjustments in the order shown, you can create a finely-tuned sound field effortlessly.

- 1 *Setting the speaker setting*
- 2 *Using the position selector*
- 3 *Auto TA and EQ (auto-time alignment and auto-equalizing)*
- 4 *Adjusting the time alignment*
- 5 *Adjusting the speaker output levels using a test tone*
- 6 *Selecting a cross-over frequency*
- 7 *Adjusting the speaker output levels*
- 8 *Adjusting 3-band parametric equalizer*

## Operating the DSP menu

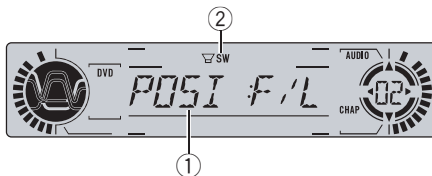

- ① **DSP display**  
Shows the DSP status.
- ② **Subwoofer indicator**  
Shows when the subwoofer output is turned on.

### ● Press **A** to display the DSP function names.

Press **A** repeatedly to switch between the following DSP functions:

- POSI** (position selector)—**FAD** (balance adjustment)—**SLA** (source level adjustment)  
—**DRC** (dynamic range control)—**DIRCT** (direct)—**Lo/Ro** (down mix)
- When selecting the FM tuner as the source, you cannot switch to **SLA**, **DRC**.
  - When playing other than the DVD disc, you cannot switch to **DRC**.
  - To return to the display of each source, press **BAND**.



### Note

If you do not operate the DSP function within about 30 seconds, the display is automatically returned to the source display.

## Operating the DSP details menu

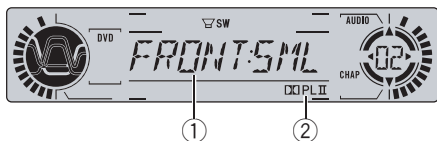

### ① DSP display

Shows the DSP status.

### ② PLII indication

Shows when the Dolby Pro Logic II is turned on.

- **Press A and hold until FRONT appears in the display, then press A to display the DSP function names.**

After **FRONT** is displayed, press **A** repeatedly, the following DSP functions appear in the display:

**FRONT** (speaker setting)—**HPF** (cross-over frequency)—**FRT-L** (speaker output level)  
—**T TONE** (test tone)—**INITIAL** (time alignment mode)—**FL** (time alignment adjustment)  
—**AT EQ** (auto-equalizer on/off)—**PEQ** (3-band parametric equalizer)

- When neither **F/L** nor **F/R** is selected in **POSI**, you cannot switch to **INITIAL** or **FL**
- To return to the display of each source, press **BAND**.

## Using the sound field control

The SFC function creates the sensation of a live performance.

- The acoustics of different performance environments are not the same and depend on the extent and contour of space through which sound waves move and on how sounds bounce off the stage, walls, floors and ceilings. At a live performance you

hear music in three stages: direct sound, early reflections, and late reflections, or reverberations. Those factors are programmed into the SFC circuitry to recreate the acoustics of various performance settings.

- **Press EQ-EX to select the desired SFC mode.**

Press **EQ-EX** repeatedly to switch between the following mode:

**MUSICAL** (musical)—**DRAMA** (drama)  
—**ACTION** (action)—**JAZZ** (jazz)—**HALL** (hall)  
—**CLUB** (club)—**OFF** (off)

### Note

If the source is a 2-channel LPCM audio or a 2-channel Dolby Digital audio and you select SFC effects that are most applicable for 5.1-channel audio (i.e., **MUSICAL**, **DRAMA** or **ACTION**), we recommend turning Dolby Pro Logic II on. On the other hand, when selecting SFC effects that are intended for use with 2-channel audio (i.e., **JAZZ**, **HALL** or **CLUB**), we recommend turning Dolby Pro Logic II off.

## Using the position selector

One way to assure a more natural sound is to accurately position the stereo image, putting you right in the center of the sound field. The position selector function lets you automatically adjust the speaker output levels and inserts a delay time to match the number and position of occupied seats. When used in conjunction with the SFC, the feature will make the sound image more natural and offer a panoramic sound that envelops you.

### 1 Press A to select POSI.

Press **A** until **POSI** appears in the display.



## Digital Signal Processor

### 2 Press ◀◀/▶▶/||▶/◀|| to select a listening position.

Press one of these, ◀◀/▶▶/||▶/◀||, to select a listening position as listed in the table.

Button	Display	Position
◀◀	F/L	Front seat left
▶▶	F/R	Front seat right
▶	FRT	Front seats
◀	ALL	All seats

- To cancel the selected listening position, press the same button again.



#### Note

When you make adjustments for listening position, the speakers are automatically set for appropriate output levels. You can tailor them if you want as discussed under the heading of *Adjusting the speaker output levels using a test tone or Adjusting the speaker output levels*. □

## Using balance adjustment

You can select a fader/balance setting that provides an ideal listening environment in all occupied seats.

### 1 Press A to select FAD.

Press **A** until **FAD** appears in the display.

- If the balance setting has been previously adjusted, **BAL** will be displayed.

### 2 Press ||▶ or ◀|| to adjust front/rear speaker balance.

Each press of ||▶ or ◀|| moves the front/rear speaker balance towards the front or the rear. **FAD:F25 – FAD:R25** is displayed as the front/rear speaker balance moves from front to rear.

- **FAD:0** is the proper setting when only two speakers are used.

### 3 Press ◀◀ or ▶▶ to adjust left/right speaker balance.

When you press ◀◀ or ▶▶, **BAL:0** is displayed. Each press of ◀◀ or ▶▶ moves the left/right speaker balance towards the left or the right.

**BAL:L25 – BAL:R25** is displayed as the left/right speaker balance moves from left to right. □

## Adjusting source levels

SLA (source level adjustment) lets you adjust the volume level of each source to prevent radical changes in volume when switching between sources.

- Settings are based on the FM tuner volume level, which remains unchanged.

### 1 Compare the FM tuner volume level with the level of the source you wish to adjust.

### 2 Press A to select SLA.

Press **A** until **SLA** appears in the display.

### 3 Press ||▶ or ◀|| to adjust the source volume.

Each press of ||▶ or ◀|| increases or decreases the source volume.

**SLA:+4 – SLA:-4** is displayed as the source volume is increased or decreased.



#### Notes

- The AM tuner volume level can also be adjusted with source level adjustments.
- Video CD, CD and MP3/WMA are set to the same source level adjustment volume automatically.
- DVD and the optional DVD player are set to the same source level adjustment volume automatically.

- External unit 1 and external unit 2 are set to the same source level adjustment volume automatically. 

## Using the dynamic range control

The dynamic range refers to the difference between the largest and softest sounds. The dynamic range control compresses this difference so that you can clearly hear sounds even at low volume levels.

- The dynamic range control is effective only on Dolby Digital sounds.

### 1 Press **A** to select **DRC**.

Press **A** until **DRC** appears in the display.

- When playing other than the DVD disc, you cannot switch this mode.

### 2 Press **II▶** to turn the dynamic range control on.

**DRC:ON** appears in the display. Dynamic range control is now on.

- To turn dynamic range control off, press **◀II**. 

## Using the direct control

You can override audio settings to check for effectiveness of your audio settings.

### 1 Press **A** to select **DIRCT**.

Press **A** until **DIRCT** appears in the display.

### 2 Press **II▶** to turn the direct control on.

**DIRCT:ON** appears in the display. Direct control is now on.

- To turn direct control off, press **◀II**.



### Notes

- All audio functions are locked out during **DIRCT:ON** except **VOLUME** and **PLII**.
- If the source is a 2-channel LPCM audio or a 2-channel Dolby Digital audio and you select **DIRCT:ON**, audio is heard only over front left/right speakers. 

## Using the down-mix function

*Only when the multi-channel processor (e.g., DEQ-P7650) is connected to this unit, you can operate this function.*

The down-mix function allows you to play back multi-channel audio in 2 channels.

### 1 Press **A** to select **Lo/Ro**.

Press **A** until **Lo/Ro** appears in the display.

- If the down mix **Lt/Rt** has been previously selected, **Lt/Rt** will be displayed.

### 2 Press **◀◀** or **▶▶** to switch the down mix settings.

- **Lt/Rt** – Down mix so that the surround components can be restored (decoded).
- **Lo/Ro** – Stereo mix the original audio that do not contain channel modes such as surround components. 

## Using the Dolby Pro Logic II

*Only when the multi-channel processor (e.g., DEQ-P7650) is connected to this unit, you can operate this function.*

Dolby Pro Logic II creates five full-bandwidth output channels from two-channel sources to achieve high-purity matrix surround.

- If both the center and the rear speakers are set to **OFF**, you cannot use this function.

## Digital Signal Processor

- Dolby Pro Logic **II** supports up to 48kHz sampling rate stereo source and has no effect on other types of source.

### 1 Press and hold EQ-EX until PLII appears in the display.

### 2 Press EQ-EX to select the desired mode.

- **MOV (movie)** – The Movie mode suitable for movie playback
- **MUS (music)** – The Music mode suitable for music playback
- **MAT (matrix)** – The Matrix mode for when FM radio reception is weak
- **PL II :OFF**– Turn Dolby Pro Logic **II** off
  - You can operate **music adjust** only when **MUS (music)** has been selected.
  - To cancel Dolby Pro Logic **II**, press **EQ-EX** again to select **PL II :OFF**.

## Adjusting the Music mode

You can adjust the Music mode with the following three controls.

- Panorama (**PANO**) extends the front stereo image to include the surround speakers for an exciting “wraparound” effect.
- Dimension (**DIME**) allows you to gradually adjust the sound field either towards the front or the rear.
- Center Width Control (**CENT**) allows center-channel sounds to be positioned between the center speaker and the left/right speakers. It improves the left-center-right stage presentation for both the driver and the front passenger.

### 1 Press EQ-EX until MUS (music) appears in the display.

### 2 Press ►► to select PANO.

Press ◀◀ or ►► to turn **PANO** on/off.

### 3 Press ►► again to select DIME.

Each time you press ◀◀ or ►► it moves the sound towards the front or the surrounds. **+3 – –3** is displayed as the front/surround speaker balance moves from front to surrounds.

### 4 Press ►► again to select CENT.

Each time you press ◀◀ or ►► it gradually spreads the center channel sound into the front left and right speakers over a range **0–7**. **3** is the default and it's recommended for most recordings. **0** places all center sound in the center speaker. **7** places all center sound equally in the left/right speakers. □

## Setting the speaker setting

You need to make with/without (or yes/no) and size (bass reproducing capacity) selection/adjustments depending on the installed speakers. The size needs to be set to **LRG** (large) if the speaker is capable of reproducing sounds of about 100 Hz or below. Otherwise select **SML** (small).

- Low frequency range is not output if the subwoofer is set to **OFF** and the front and rear speakers set to **SML** or **OFF**.
- It is imperative that non-installed speakers be set to **OFF**.
- Set the front or rear speaker to **LRG** if the speaker is capable of reproducing bass content, or if no subwoofer is installed.

### 1 Press A and hold until FRONT appears in the display.

### 2 Press ◀◀ or ►► to select the speaker to be adjusted.

Each press of ◀◀ or ►► selects the speaker in the following order:

**FRONT** (front speakers)—**CENT** (center speaker)—**REAR** (rear speakers)—**SUB.W** (subwoofer)—**PHASE** (subwoofer setting)

- You can switch to **PHASE** only when the subwoofer has been set to **ON**.

### 3 Press **II▶** or **◀II** to select the correct size for the selected speaker.

Each press of **II▶** or **◀II** selects the size in the following order:

**SML** (small)—**LRG** (large)—**OFF** (off)

- You cannot select **OFF**, when **FRONT** (front speakers) have been selected.
- You can select **ON** or **OFF**, when **SUB.W** (subwoofer) has been selected.
- You can switch **REV** (reverse phase) or **NOR** (normal phase), when **PHASE** (subwoofer setting) has been selected.

### 4 Press **BAND** to return to the playback display.

## Correcting the subwoofer's phase

If trying to boost the bass output of the subwoofer doesn't do much or rather makes you feel that the bass gets more murky, this may indicate that the subwoofer's output and bass content you hear over other speakers cancel each other out. To remove this problem, try changing the phase setting for the subwoofer.

### 1 Press **A** and hold until **FRONT** appears in the display.

### 2 Press **◀◀** or **▶▶** to select the subwoofer.

Each press of **◀◀** or **▶▶** selects the speaker in the following order:

**FRONT** (front speakers)—**CENT** (center speaker)—**REAR** (rear speakers)—**SUB.W** (subwoofer)—**PHASE** (subwoofer setting)

### 3 Press **II▶** to turn the subwoofer output on.

### 4 Press **▶▶** to select **PHASE** (subwoofer setting).

### 5 Press **◀II** or **II▶** to select the subwoofer output phase.

Press **II▶** to select **NOR** (normal phase). Press **◀II** to select **REV** (reverse phase).

### 6 Press **BAND** to return to the playback display.



#### Note

When playing a 2-channel mono source with Pro Logic **II** turned on, there may be occasions when the following will occur:

- No audio is outputted if the center speaker setting is **SML** or **LRG** and no center speaker is installed.
- Audio is heard only over the center speaker if installed and the center speaker setting is **SML** or **LRG**. 

## Selecting a cross-over frequency

You can select a frequency, under which sounds are reproduced through the subwoofer. If the installed speakers include one whose size has been set to **SML**, you can select a frequency, under which sounds are reproduced through a **LRG** speaker or subwoofer.

### 1 Press **A** and hold until **FRONT** appears in the display, then press **A** to select **HPF**.

After **FRONT** is displayed, press **A** until **HPF** appears in the display.

## Digital Signal Processor

### 2 Press ◀◀ or ▶▶ to select the speaker to be adjusted.

Each press of ◀◀ or ▶▶ selects the speaker in the following order:

**FRONT** (front speakers)—**CENT** (center speaker)—**REAR** (rear speakers)—**SUB.W** (subwoofer)

### 3 Press ◀|| or ||▶ to select cross-over frequency for the selected speaker.

Each press of ◀|| or ||▶ selects cross-over frequencies in the following order:

**63—80—100—125—160—200** (Hz)

### 4 Press BAND to return to the playback display.



#### Note

Selecting a cross-over frequency is to set a cross-over frequency of the subwoofer's L.P.F. (low-pass filter) and that of the **SML** speaker H.P.F. (high-pass filter). The cross-over frequency setting has no effect if the subwoofer is set to **OFF** and other speakers are set to **LRG** or **OFF**. □

## Adjusting the speaker output levels

You can readjust the speaker output levels using a test tone while listening to music.

### 1 Press A and hold until FRONT appears in the display, then press A to select FRT-L.

After **FRONT** is displayed, press **A** until **FRT-L** appears in the display.

### 2 Press ◀◀ or ▶▶ to select the speaker to be adjusted.

Each press of ◀◀ or ▶▶ selects the speaker in the following order:

**FRT-L** (front speaker left)—**CENT** (center speaker)—**FRT-R** (front speaker right)—**RER-R**

(rear speaker right)—**RER-L** (rear speaker left)—**SUB.W** (subwoofer)

■ You cannot select speakers whose size is set at **OFF**.

### 3 Press ||▶ or ◀|| to adjust the speaker output level.

Each press of ||▶ or ◀|| increases or decreases the speaker output level. **+10—-10** is displayed as the level is increased or decreased.

### 4 Press BAND to return to the playback display.



#### Note

To adjust the speaker output levels in this mode is the same as making the speaker output levels at **T TONE**. Both provide the same results. □

## Adjusting the speaker output levels using a test tone

A convenient test tone allows you to easily get the overall balance right among the speakers.

### 1 Press A and hold until FRONT appears in the display, then press A to select T TONE.

After **FRONT** is displayed, press **A** until **T TONE** appears in the display.

### 2 Press ▶▶ to start the test tone output.

The test tone is outputted. It rotates from speaker to speaker in the following sequence at intervals of about two seconds. The current settings for the speaker over which you hear the test tone are shown in the display.

**FRT-L** (front speaker left)—**CENT** (center speaker)—**FRT-R** (front speaker right)—**RER-R** (rear speaker right)—**RER-L** (rear speaker left)—**SUB.W** (subwoofer)

- Check each speaker output level. If no adjustments are needed, perform step 4 to stop the test tone.
- The settings do not appear for speakers whose size is set **OFF**.

### 3 Press **▶▶** or **◀◀** to adjust the speaker output level.

Each press of **▶▶** or **◀◀** increases or decreases the speaker output level. **+10 – –10** is displayed as the level is increased or decreased.

- The test tone rotates to the next speaker after about two seconds from the last operation.

### 4 Press **◀◀** to stop the test tone output.

### 5 Press **BAND** to return to the playback display.



#### Notes

- If needed, select speakers and adjust their 'absolute' output levels. (Refer to *Adjusting the speaker output levels* on the previous page.)
- To adjust the speaker output levels in this mode is the same as making the speaker output levels at **FRT-L**. Both provide the same results.

## Using the time alignment

Only when the multi-channel processor (e.g., DEQ-P7650) is connected to this unit, you can operate this function.

The time alignment lets you adjust the distance between each speaker and the listening position.

### 1 Press **A** repeatedly until **INITIAL** appears in the display.

- You cannot select **INITIAL** when neither **F/L** nor **F/R** is selected in **POSI**.

### 2 Press **◀◀** or **▶▶** to select the time alignment.

- **INITIAL** – Initial time alignment (factory setting)
- **CUSTOM** – Adjusted time alignment that you can create for yourself
- **AUTO TA** – Time alignment created by auto TA and EQ. (Refer to *Auto TA and EQ (auto-time alignment and auto-equalizing)* on the next page.)
- **OFF** – Turn the time alignment off
  - To turn time alignment off, select **TA:OFF**.
  - You cannot select **AUTO TA** if auto TA and EQ has not been carried out.
  - You cannot select **ADJUSTMENT** when neither **F/L** nor **F/R** is selected in **POSI**.

### 3 Press **BAND** to cancel the time alignment mode.

## Adjusting the time alignment

By adjusting the distance between each speaker and a selected listening position, you can insert delay times into the speaker output to obtain a correct sound image and overall level balance. Although this is automatically achieved when you set the listening position, the time alignment feature provides a fine adjustment.

### 1 Press **A** and hold until **FRONT** appears in the display, then press **A** to select **FL**.

After **FRONT** is displayed, press **A** until **FL** appears in the display.

- You cannot select **FL** when neither **F/L** nor **F/R** is selected in **POSI**.

### 2 Press **◀◀** or **▶▶** to select the speaker to be adjusted.

Each press of **◀◀** or **▶▶** selects the speaker in the following order:

## Digital Signal Processor

**FL** (front speaker left)—**C** (center speaker)—**FR** (front speaker right)—**RR** (rear speaker right)—**RL** (rear speaker left)—**SW** (subwoofer)

- You cannot select speakers whose size is set at **OFF**.

### 3 Press **II▶** or **◀II** to adjust the distance between the selected speaker and the listening position.

Each press of **II▶** or **◀II** increases or decreases the distance. **500.0** (cm)—**0.0** (cm) is displayed as the distance is increased or decreased.

### 4 Press **BAND** to return to the playback display.

## Using the auto-equalizer

The auto-equalizer is the equalizer curve created by auto TA and EQ (refer to *Auto TA and EQ (auto-time alignment and auto-equalizing)* on this page).

You can turn the auto-equalizer on or off.

### 1 Press **A** and hold until **FRONT** appears in the display, then press **A** to select **AT EQ: OFF**.

After **FRONT** is displayed, press **A** until **PLII** appears in the display.

- You cannot use this function if auto TA and EQ has not been carried out.

### 2 Press **II▶** to turn the auto-equalizer on. **AT EQ: ON** appears in the display.

- To turn auto-equalizer off, press **◀II**. 

## Auto TA and EQ (auto-time alignment and auto-equalizing)

*Only when the multi-channel processor (e.g., DEQ-P7650) is connected to this unit, you can operate this function.*

The auto-time alignment is automatically adjusted for the distance between each speaker and the listening position.

The auto-equalizer automatically measures the car interior acoustic characteristics, and then creates the auto-equalizer curve based on that information.

### **WARNING**

To prevent accidents, never carry out auto TA and EQ while driving. When this function measures the car interior acoustic characteristics to create an auto-equalizer curve, a loud measurement tone (noise) may be outputted from the speakers.

### **CAUTION**

- Carrying out auto TA and EQ under the following conditions may damage the speakers. Be sure to check the conditions thoroughly before carrying out auto TA and EQ.
  - When speakers are incorrectly connected. (e.g., When a rear speaker is connected to a subwoofer output.)
  - When a speaker is connected to a power amp delivering output higher than the speaker's maximum input power capability.
- If the microphone is placed in an unsuitable position the measurement tone may become loud and measurement may take a long time, resulting in a drain on battery power. Be sure to place the microphone in the specified location.

## Before operating the auto TA and EQ function

- Carry out auto TA and EQ in as quiet a place as possible, with the car engine and air conditioning switched off. Also cut power to car phones or portable telephones in the car, or remove them from the car before carrying out auto TA and EQ. Sounds other than the measurement tone (surrounding sounds, engine sound, telephones ringing etc.) may prevent correct measurement of the car interior acoustic characteristics.
- Be sure to carry out auto TA and EQ using the supplied microphone. Using another microphone may prevent measurement, or result in incorrect measurement of the car interior acoustic characteristics.
- When front speaker is not connected, auto TA and EQ cannot be carried out.
- When this unit is connected to a power amp with input level control, auto TA and EQ may not be possible if you lower power amp input level. Set the power amp's input level to the standard position.
- When this unit is connected to a power amp with an LPF, turn off the LPF on the power amp before carrying out auto TA and EQ. In addition, the cross-over frequency for built-in LPF of an active subwoofer should be set to the highest frequency.
- The time alignment value calculated by auto TA and EQ may differ from the actual distance in the following circumstances. However, the distance has been calculated by computer to be the optimum delay to give accurate results for the circumstances, so please continue to use this value.
  - When the reflected sound within a vehicle is strong and delays occur.
  - When delays occur for low sounds due to the influence of the LPF on active subwoofers or external amps.

- Auto TA and EQ changes the audio settings as below:
  - The fader/balance settings return to the center position. (Refer to page 57.)
  - The graphic equalizer curve switches to **EQ FLAT**. (Refer to the next page.)
  - When a subwoofer is connected to this unit, it will be adjusted automatically to both subwoofer output and high pass filter setting for rear speaker.
- If you carry out auto TA and EQ when a previous setting of this already exists, the setting will be replaced.

## Carrying out auto TA and EQ

### 1 Stop the car in a place that is as quiet as possible, close all doors, windows and the sun roof, and then turn the engine off.

If the engine is left running, engine noise may prevent correct auto TA and EQ.

### 2 Fix the supplied microphone in the center of the headrest of the driver's seat, facing forward, using the belt (sold separately).

The auto TA and EQ may differ depending on where you place the microphone. If desired, place the microphone on the front passenger seat to carry out auto TA and EQ.

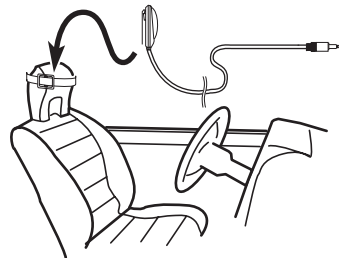

### 3 Turn the ignition switch to ON or ACC.

If the car's air conditioner or heater is turned on, turn it off. Noise from the fan in the air



## Digital Signal Processor

conditioner or heater may prevent correct auto TA and EQ.

- Press **SOURCE** to turn the source on if this unit is turned off.

### 4 Select the position for the seat on which the microphone is placed.

Refer to *Using the position selector* on page 64.

- If no position is selected before you start auto TA and EQ, **FL** is selected automatically.

### 5 Press SOURCE and hold until the unit turns off.

### 6 Press and hold EQ to enter the auto TA and EQ measurement mode.

### 7 Plug the microphone into the microphone input jack on the multi-channel processor.

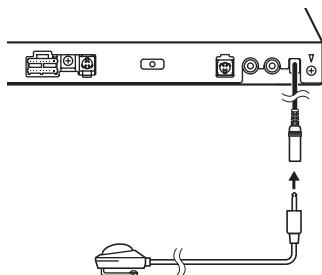

### 8 Press **||▶** to start the auto TA and EQ.

### 9 Get out of the car and close the door within 10 seconds when the 10-second count-down starts.

The measurement tone (noise) is outputted from the speakers, and auto TA and EQ begins.

- When all speakers are connected, auto TA and EQ is completed in about six minutes.
- To stop auto TA and EQ, press any keys.

- To cancel auto TA and EQ part way through, press **BAND**.

### 10 When auto TA and EQ is completed, COMPLETE is displayed.

When correct measurement of car interior acoustic characteristics is not possible, an error message is displayed. (Refer to *Understanding auto TA and EQ error messages* on page 91.)

### 11 Press BAND to cancel the auto TA and EQ mode.

### 12 Store the microphone carefully in the glove compartment.

Store the microphone carefully in the glove compartment or any other safe place. If the microphone is subjected to direct sunlight for an extended period, high temperatures may cause distortion, color change or malfunction. 

## Using the equalizer

The equalizer lets you adjust the equalization to match car interior acoustic characteristics as desired.

### Recalling equalizer curves

There are seven stored equalizer curves which you can easily recall at any time. Here is a list of the equalizer curves:

Display	Equalizer curve
<b>POWERFUL</b>	Powerful
<b>NATURAL</b>	Natural
<b>VOCAL</b>	Vocal
<b>EQ FLAT</b>	Flat
<b>CUSTOM1</b>	Custom 1

Display	Equalizer curve
CUSTOM2	Custom 2
SPR-BASS	Super bass

- **CUSTOM1** and **CUSTOM2** are adjusted equalizer curves.
- When **EQ FLAT** is selected no supplement or correction is made to the sound. This is useful to check the effect of the equalizer curves by switching alternatively between **EQ FLAT** and a set equalizer curve.

#### ● Press EQ to select the equalizer.

Press **EQ** repeatedly to switch between the following equalizers:

**POWERFUL—NATURAL—VOCAL—EQ FLAT—CUSTOM1—CUSTOM2—SPR-BASS**

## Adjusting 3-band parametric equalizer

For **CUSTOM1** and **CUSTOM2** equalizer curves, you can adjust the front, rear and center equalizer curves separately by selecting a center frequency, an equalizer level and a Q factor for each band.

- A separate **CUSTOM1** curve can be created for each source.
- A **CUSTOM2** curve can be created common to all sources.
- The center speaker largely determines the sound image and getting the balance right isn't easy. We recommend reproducing a 2-ch. audio (a CD for example) and getting the balance right among the speakers except for the center, and then reproducing a 5.1-ch. audio (Dolby Digital or DTS) and adjusting the center speaker output to the balance you have already got among the other speakers.

### 1 Press A and hold until FRONT appears in the display, then press A to select PEQ.

After **FRONT** is displayed, press **A** until **PEQ** appears in the display.

- Adjusted **PEQ** settings are memorized in **CUSTOM1**.

### 2 Press **II▶** or **◀II** to select the speaker to be adjusted.

Each press of **II▶** or **◀II** selects the speaker in the following order:

**FRT** (front speakers)—**CEN** (center speaker)  
—**RER** (rear speakers)

- You cannot select speakers whose size is set at **OFF**.

### 3 Press **▶▶** and then press **II▶** or **◀II** to select the equalizer band to be adjusted.

Each press of **II▶** or **◀II** selects equalizer bands in the following order:

**LOW** (low)—**MID** (mid)—**HI** (high)

### 4 Press **▶▶** and then press **II▶** or **◀II** to select the center frequency of selected band.

Each press of **II▶** or **◀II** selects the frequency in the following order:

**40Hz—50Hz—63Hz—80Hz—100Hz—125Hz—160Hz—200Hz—250Hz—315Hz—400Hz—500Hz—630Hz—800Hz—1kHz—1.2kHz—1.6kHz—2kHz—2.5kHz—3.1kHz—4kHz—5kHz—6.3kHz—8kHz—10kHz—12kHz**

### 5 Press **▶▶** and then press **II▶** or **◀II** to adjust the equalizer level.

Each press of **II▶** or **◀II** increases or decreases the equalizer level. **+6—-6** is displayed as the level is increased or decreased.

### 6 Press **▶▶** and then press **II▶** or **◀II** to select the desired Q factor.

Each press **II▶** or **◀II** switches between the following Q factor:

**WID** (wide)—**NAR** (narrow)

## Digital Signal Processor

- You can adjust parameters for each band of the other speakers in the same way.

### 7 Press **BAND** to return to the playback display.



#### Note

You can select a center frequency from among 20 frequencies for each band. You can change the center frequency in 1/3-octave steps, but you cannot select frequencies that have intervals shorter than 1 octave among the center frequencies of the three bands.

## Introduction of DVD setup adjustments



You can use this menu to change audio, subtitle, parental lock and other DVD settings. This menu can be operated only by using the remote control.

### ① SET-UP MENU

Shows the setup menu status.

#### 1 Press ■.

#### 2 Press MENU when the disc is stopped. SET-UP MENU is displayed.

#### 3 Move the joystick left or right to switch between LANG (language settings), PICT (picture settings) and GEN (general settings).



#### Note

If you press **MENU** during display of a **SET-UP MENU**, the **SET-UP MENU** is canceled and the unit returns to the previous display.

## Returning to the previous display

The **SET-UP MENU** lets you switch between displays of different setting options. To continue performing different settings, or if you make a mistake during setting, pressing **RETURN** takes you back to the previous display each time you press it.

## Setting the subtitle language

You can set a desired subtitle language. If the selected subtitle language is recorded on the DVD, subtitles are displayed in that language.

### 1 Move the joystick up or down to select SUBTITLE LANG. in the SET-UP MENU (LANG.). SUBTITLE LANG. is highlighted.

### 2 Click the joystick.

A subtitle language menu is displayed.

### 3 Move the joystick up or down to select the desired language.

The currently set language is indicated with the blue box. The language selected with the joystick is highlighted.

- To switch to the second language select menu, move the joystick left or right.
- To return to the first language select menu, move the joystick left or right.

### 4 Click the joystick.

A subtitle language is set.



#### Notes

- If the selected language is not recorded on the disc, the language specified on the disc is displayed.

## Setting up the DVD player

- You can also switch the subtitle language during playback with **SUBTITLE (S.TITLE)**. (Refer to *Changing the subtitle language during playback (Multi-subtitle)* on page 23.)
- Even if you use **SUBTITLE (S.TITLE)** to switch the subtitle language, this does not affect the settings here.
- Pressing **RETURN** takes you back to the previous display.

### When you select GENERAL

When you select **GENERAL**, a language code input display is shown. Refer to *Language code chart for DVD* on page 96, use the number buttons to input the four digit code of the desired language, and then click the joystick.

#### Note

Pressing **CLEAR** cancels the input numbers. 

## Setting the audio language

You can set the preferred audio language.

**1 Move the joystick up or down to select AUDIO LANG. in the SET-UP MENU (LANG.).**  
**AUDIO LANG.** is highlighted.

**2 Click the joystick.**

An audio language menu is displayed.

**3 Move the joystick up or down to select the desired audio language.**

The currently set language is indicated with the blue box. The language selected with the joystick is highlighted.

- To switch to the second audio language select menu, move the joystick left or right.
- To return to the first audio language select menu, move the joystick left or right.

**4 Click the joystick.**

The audio language is set.

#### Notes

- If the selected language is not recorded on the disc, the language specified on the disc is outputted.
- You can also switch the audio language during playback with **AUDIO**. (Refer to *Changing audio language during playback (Multi-audio)* on page 22.)
- Even if you use **AUDIO** to switch the audio language, this does not affect the settings here.
- Pressing **RETURN** takes you back to the previous display.
- If you have selected **GENERAL**, refer to *When you select GENERAL on this page.* 

## Setting the menu language

You can set the preferred language for displays of menus recorded on a disc.

**1 Move the joystick up or down to select MENU LANG. in the SET-UP MENU (LANG.).**  
**MENU LANG.** is highlighted.

**2 Click the joystick.**

A menu language menu is displayed.

**3 Move the joystick up or down to select the desired menu language.**

The currently set language is indicated with the blue box. The language selected with the joystick is highlighted.

- To switch to the second menu language select menu, move the joystick left or right.
- To return to the first menu language select menu, move the joystick left or right.

**4 Click the joystick.**

The menu language is set.

**Notes**

- If the selected language is not recorded on the disc, the language specified on the disc is outputted.
- Pressing **RETURN** takes you back to the previous display.
- If you have selected **GENERAL**, refer to *When you select GENERAL on the previous page.* 

## Setting assist subtitles on or off

Assist subtitles offer explanations for the aurally impaired. However, they are only displayed if they are recorded on the DVD. You can turn assist subtitles on or off as desired.

**1 Move the joystick up or down to select ASSIST in the SET-UP MENU (LANG.).**

**ASSIST** is highlighted.

**2 Click the joystick.**

Each time you click the joystick the selected setting switches on or off. 

## Setting angle icon display

You can set it up so that the angle icon appears on scenes where the angle can be switched.

**1 Move the joystick up or down to select ANGLE in the SET-UP MENU (PICT).**

**ANGLE** is highlighted.

**2 Click the joystick.**

Angle icon display is set on or off.

**Notes**

- You can also switch the angle during playback with **ANGLE**. (Refer to *Changing the viewing angle during playback (Multi-angle)* on page 23.)
- Pressing **RETURN** takes you back to the previous display. 

## Setting the aspect ratio

There are two kinds of display. A wide screen display has a width-to-height ratio (TV aspect) of 16:9, while a regular display has a TV aspect of 4:3. Be sure to select the correct TV aspect for the display you use.

- When using a regular display, select either **LETTER BOX** or **PANSCAN**. Selecting **16:9** may result in an unnatural picture.

**1 Move the joystick up or down to select TV ASPECT in the SET-UP MENU (PICT).**

**TV ASPECT** is highlighted.

**2 Click the joystick.**

TV aspect menu is displayed.

**3 Move the joystick up or down to select the desired TV aspect.**

The currently set TV aspect is indicated with blue box. The TV aspect selected with the joystick is highlighted.

- **16:9** – Wide screen picture (16:9) is displayed as it is (initial setting)
- **LETTER BOX** – The picture is the shape of a letterbox with black bands at the top and bottom of the screen
- **PANSCAN** – The picture is cut short at the right and left of the screen

## Setting up the DVD player

### 4 Click the joystick.

The selected TV aspect is set.



#### Notes

- When playing discs that do not specify **PANSCAN**, playback is with **LETTER BOX** even if you select **PANSCAN** setting. Confirm whether the disc package bears the **16:9 LB** mark. (See page 8.)
- Some discs do not enable changing of the TV aspect. For details, refer to the disc's instructions.
- Pressing **RETURN** takes you back to the previous display. 

## Setting the parental lock

Some DVD video discs let you use parental lock to restrict the viewing of violent and adult-oriented scenes by children. You can set the parental lock level in steps as desired.

- When you set a parental lock level and then play a disc featuring parental lock, code number input indications may be displayed. In this case, playback will begin when the correct code number is input.

## Setting the code number and level

When you first use this function, register your code number. If you do not register a code number, parental lock will not operate.

- 1 Move the joystick up or down to select PARENTAL in the SET-UP MENU (GEN).**  
**PARENTAL** is highlighted.

- 2 Click the joystick.**

Parental lock setting menu is displayed.

- 3 Press NUMBER buttons to input a four digit code number.**

### 4 Click the joystick.

The code number is set, and you can now set the level.

### 5 Move the joystick left or right to select the desired level.

- **LEVEL 8** – Playback of the entire disc is possible (initial setting)
- **LEVEL 7–LEVEL 2** – Playback of discs for children and non-adult-oriented discs is possible
- **LEVEL 1** – Playback of discs for children only is possible

### 6 Click the joystick.

The parental lock level is set.



#### Notes

- We recommend to keep a record of your code number in case you forget it.
- The parental lock level is recorded on the disc. You can confirm it by looking at the disc package, included literature or on the disc itself. With discs that do not feature a recorded parental lock level, you cannot use parental lock.
- With some discs, parental lock operates to skip certain scenes only, after which normal playback resumes. For details, refer to the disc's instructions.
- Pressing **RETURN** takes you back to the previous display.

## Changing the level

You can change the set parental lock level.

- 1 Move the joystick up or down to select PARENTAL in the SET-UP MENU (GEN).**  
**PARENTAL** is highlighted.

- 2 Click the joystick.**

Parental lock setting menu is displayed.

## Setting up the DVD player

**3 Press NUMBER buttons to input the registered code number.**

**4 Click the joystick.**

This enters the code number, and you can now change the level.

- If you input an incorrect code number, the icon  is displayed. Press **CLEAR** and input the correct code number.
- If you forget your code number, refer to *If you forget your code number* on this page.

**5 Move the joystick left or right to select the desired level.**

**6 Click the joystick.**

The parental lock level is set.



### Note

Pressing **RETURN** takes you back to the previous display.

### If you forget your code number

Refer to *Changing the level* on the previous page, and press **CLEAR** 10 times. The registered code number is canceled, letting you register a new one. 

### Automatic playback of DVDs

When a DVD's disc with DVD menu is inserted, this unit will cancel the DVD menu automatically and start playback from the first chapter of the first title.

- Some DVDs may not operate properly. If this function is not fully operated, turn this function off and start playback.

**1 Move the joystick up or down to select DVD AUTO PLAY in the SET-UP MENU (GEN).**

**DVD AUTO PLAY** is highlighted.

**2 Click the joystick to turn automatic playback on or off.**

- When the automatic playback is on, you cannot operate repeating play of DVD disc (refer to *Repeating play* on page 27). 

### Setting remote control code type

When the remote control operation switch is set to **DVD**, changing the remote control code type enables you to operate the Pioneer DVD player by the supplied remote control. There are three remote codes, code type **A**, code type **B** and code type **DVH**. When using this unit with a multi-DVD player (e.g. XDV-P9), select code **A**. When using this unit only, select code **DVH**.

- With this unit, code **B** cannot be used.

**1 Set the remote control selection switch on the left side of the remote control to the appropriate position with a pen tip or other pointed instrument .**

- If you select **DVH** mode, there is no need to take the following procedure.
- If you select **A/B** mode, take the following procedure and change the code type to the appropriate type.

**2 Press 7 and 0 on the remote control simultaneously to change the code type.**

Initially, the code type is set to **A**. Each time you press **7** and **0** simultaneously on the remote control the code type switches between **A** and **B**. 



## Initial Settings

### Adjusting initial settings

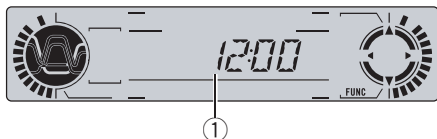

Initial settings lets you perform initial setup of different settings for this unit.

#### ① Function display

Shows the function status.

**1 Press SOURCE and hold until the unit turns off.**

**2 Press F and hold until function name appears in the display.**

**3 Press F to select one of the initial settings.**

Press **F** repeatedly to switch between the following settings:

Clock—**FM** (FM tuning step)—**AM** (AM tuning step)—**WARN** (warning tone)—**AUX** (auxiliary setting)—**DIMMR** (dimmer)—**R-SP** (rear output and subwoofer controller)—**TEL** (telephone muting/attenuation)—**DSC-A** (disc auto)—**D\_ATT** (digital attenuation)—**A-RESET** (audio reset)

- To cancel initial settings, press **BAND**.
- You can also cancel initial settings by holding down **F** until the unit turns off.
- When the multi-channel processor (e.g., DEQ-P7650) is connected to this unit, you can operate **D\_ATT** and **A-RESET** instead of **R-SP**. □

### Setting the clock

Use these instructions to set the clock.

**1 Press F to select clock.**

Press **F** repeatedly until clock appears in the display.

**2 Press ◀◀ or ▶▶ to select the segment of the clock display you wish to set.**

Pressing ◀◀ or ▶▶ will select one segment of the clock display:

Hour—Minute

As you select segments of the clock display the segment selected will blink.



**3 Press ||▶ or ◀|| to set the clock.**

Pressing ||▶ will increase the selected hour or minute. Pressing ◀|| will decrease the selected hour or minute. □

### Setting the FM tuning step

The FM tuning step employed by seek tuning can be switched between 100 kHz, the preset step, and 50 kHz.

**1 Press F to select FM.**

Press **F** repeatedly until **FM** appears in the display.

**2 Press ◀◀ or ▶▶ to select the FM tuning step.**

Pressing ◀◀ or ▶▶ will switch the FM tuning step between 100 kHz and 50 kHz. The selected FM tuning step will appear in the display.

 **Note**

If seek tuning is performed in 50 kHz steps, stations may be tuned in imprecisely. Tune in the stations with manual tuning or use seek tuning again. 

## Setting the AM tuning step

The AM tuning step can be switched between 9 kHz, the preset step, and 10 kHz. When using the tuner in North, Central or South America, reset the tuning step from 9 kHz (531 – 1,602 kHz allowable) to 10 kHz (530 – 1,640 kHz allowable).

### 1 Press F to select AM.

Press **F** repeatedly until **AM** appears in the display.

### 2 Press ◀◀ or ▶▶ to select the AM tuning step.

Pressing ◀◀ or ▶▶ will switch the AM tuning step between 9 kHz and 10 kHz. The selected AM tuning step will appear in the display. 

## Switching the warning tone

If the front panel is not detached from the head unit within five seconds of turning off the ignition, a warning tone will sound. You can turn off the warning tone.

### 1 Press F to select WARN.

Press **F** repeatedly until **WARN** appears in the display.

### 2 Press II▶ to turn warning tone on.

**WARN:ON** appears in the display.

- To turn warning tone off, press ◀◀II. 

## Switching the auxiliary setting

It is possible to use auxiliary equipment with this unit. Activate the auxiliary setting when using auxiliary equipment connected to this unit.

### 1 Press F to select AUX.

Press **F** repeatedly until **AUX** appears in the display.

### 2 Press II▶ to turn auxiliary setting on.

**AUX:ON** appears in the display.

- To turn auxiliary setting off, press ◀◀II.

 **Note**

When this unit is connected to the DEQ-P7650, you can switch to the AUX mode to analog or digital. However, when you use **AUX** as the source, make sure the AUX mode is set to analog. AUX digital should not be used with this unit. 

## Switching the dimmer setting

To prevent the display from being too bright at night, the display is automatically dimmed when the car's headlights are turned on. You can turn the dimmer on or off.

### 1 Press F to select DIMMR.

Press **F** repeatedly until **DIMMR** appears in the display.

### 2 Press II▶ to turn dimmer on.

**DIMMR:ON** appears in the display.

- To turn dimmer off, press ◀◀II. 

## Initial Settings

### Setting the rear output and subwoofer controller

This unit's rear output (rear speaker leads output) can be used for full-range speaker (**R-SP:FUL**) or subwoofer (**R-SP:S/W**) connection. If you switch the rear output setting to the **R-SP:S/W**, you can connect a rear speaker lead directly to a subwoofer without using an auxiliary amp.

Initially, the unit is set for rear full-range speaker connection (**R-SP:FUL**). When rear output is connected to full range speakers (when **R-SP:FUL** is selected), you can connect the RCA subwoofer output to a subwoofer. In this case, you can select whether to use the subwoofer controller's (low pass filter, phase) built-in **P/O :S/W** or the auxiliary **P/O :FUL**.

#### 1 Press F to select R-SP.

Press **F** repeatedly until **R-SP** appears in the display.

#### 2 Press **II** or **◀II** to switch the rear output setting.

Pressing **II** or **◀II** will switch between **R-SP:FUL** (full-range speaker) and **R-SP:S/W** (subwoofer) and that status will be displayed.

- When no subwoofer is connected to the rear output, select **R-SP:FUL**.
- When a subwoofer is connected to the rear output, set for subwoofer **R-SP:S/W**.
- When the rear output setting is **R-SP:S/W**, you cannot change the subwoofer controller.

#### 3 Press **◀◀** or **▶▶** to switch the subwoofer output or non fading output.

Pressing **◀◀** or **▶▶** will switch between **P/O :S/W** and **P/O :FUL** and that status will be displayed.



#### Notes

- Even if you change this setting, there is no output unless you turn the nonfading output

(refer to *Using nonfading output* on page 61) or subwoofer output (refer to *Using subwoofer output* on page 60) in the audio menu on.

- If you change the subwoofer controller, subwoofer output and nonfading output in the audio menu return to the factory settings.

### Switching the telephone muting/attenuation

Sound from this system is muted or attenuated automatically when a call is made or received using a cellular telephone connected to this unit.

#### 1 Press F to select TEL.

Press **F** repeatedly until **TEL** appears in the display.

#### 2 Press **◀◀** or **▶▶** to switch the telephone muting/attenuation.

Pressing **◀◀** or **▶▶** will switch between **TEL:ATT** (attenuation) and **TEL:MUT** (muting) and that status will be displayed.

- You can select in the following setting:
  - **TEL:MUT** – Muting
  - **TEL:A20** – Attenuation (**TEL:A20** has a stronger effect than **TEL:A10**)
  - **TEL:A10** – Attenuation



#### Notes

- The sound is turned off, **MUTE** or **ATT** is displayed and no audio adjustment is possible.
- Operation returns to normal when the phone connection is ended.

## Switching the automatic disc playback

You can turn automatic disc playback on or off when you insert a disc into the disc loading slot. When this function is on, the disc will be automatically played after it is inserted into the disc loading slot.

Initially, this function is set to on.

### 1 Press F to select DSC-A.

Press **F** repeatedly until **DSC-A** appears in the display.

### 2 Press **II▶** to turn automatic playback on.

**DSC-A: ON** appears in the display.

- Press **◀II** to turn automatic playback off.

## Correcting distorted sound

You can minimize distortion that may be caused by the equalizer curve settings. Setting an equalizer level high can cause distortion. If high sound is crippled or distorted, try switching to **LOW**. Normally, leave the setting at **HI** to ensure quality sound.

- Only when the multi-channel processor (e.g., DEQ-P7650) is connected to this unit, you can operate this function.

### 1 Press F to select D\_ATT.

Press **F** repeatedly until **D\_ATT** appears in the display.

### 2 Press **II▶** or **◀II** to select LOW or HI.

Pressing **II▶** or **◀II** will switch between **HI** (high) and **LOW** (low) and that status will be displayed.

- To cancel initial settings, press **BAND**.
- You can also cancel initial settings by holding down **F** until the unit turns off.

## Resetting the audio functions

You can reset all audio functions except volume.

- Only when the multi-channel processor (e.g., DEQ-P7650) is connected to this unit, you can operate this function.

### 1 Press F to select A-RESET.

Press **F** repeatedly until **A-RESET** appears in the display.

### 2 Press **II▶** to display RESET OK?.

**RESET OK?** appears in the display.

- To cancel resetting the audio functions, press **BAND/ESC**.

### 3 Press **▶▶** to display REALLY?.

**REALLY?** appears in the display.

- To cancel resetting the audio functions, press **BAND/ESC**.

### 4 Press **II▶** to reset audio functions.

**COMPLETE** appears in the display.

## Other Functions

### Turning the clock display on or off

You can turn the clock display on or off.

- **Press CLOCK to turn the clock display on or off.**

Each press of **CLOCK** turns the clock display on or off.

- The clock display disappears temporarily when you perform other operations, but the clock display appears again after 25 seconds.



#### Note

Even when the sources are off, the clock display appears on the display. Pressing **CLOCK** turns the clock display on or off. 

### Setting the level indicator

These are two stored level indicator to select from.

- **Press EQ and hold to select the level indicator.**

Press **EQ** and hold repeatedly to switch between the following settings:

Level indicator 1—Level indicator 2—Level indicator full—Level indicator off



#### Note

When the optical inputs 1 and 2 on DEQ-P7650 are occupied and AUX is connected to this unit, the level indicators may be incorrectly displayed. 

### Using the AUX source

An IP-BUS-RCA Interconnector such as the CD-RB20/CD-RB10 (sold separately) lets you

connect this unit to auxiliary equipment featuring RCA output. For more details, refer to the IP-BUS-RCA Interconnector owner's manual.

### Selecting AUX as the source

- **Press SOURCE to select AUX as the source.**

Press **SOURCE** until **AUX** appears in the display.

- If the auxiliary setting is not turned on, **AUX** cannot be selected. For more details, see *Switching the auxiliary setting* on page 82.

### Setting the AUX title

The title displayed for the **AUX** source can be changed.

- 1 After you have selected AUX as the source, press F and hold until TITLE IN appears in the display.**

- 2 Press **II▶** or **◀II** to select a letter of the alphabet.**

Each press of **II▶** will display a letter of the alphabet in **A B C ... X Y Z**, numbers and symbols in **1 2 3 ... > [ ]** order. Each press of **◀II** will display a letter in the reverse order, such as **Z Y X ... C B A** order.



- 3 Press **▶▶** to move the cursor to the next character position.**

When the letter you want is displayed, press **▶▶** to move the cursor to the next position and then select the next letter. Press **◀◀** to move backwards in the display.

#### 4 Move the cursor to the last position by pressing ►► after entering the title.

When you press ►► one more time, the entered title is stored in memory.

#### 5 Press BAND to return to the playback display. ◻

## Switching between digital and analog

When this unit is connected to the DEQ-P7650, you can switch to the AUX mode to analog or digital.

#### 1 Press SOURCE to select AUX as the source.

Press **SOURCE** until **AUX** appears in the display.

- If the auxiliary setting is not turned on, **AUX** cannot be selected. For more details, see *Switching the auxiliary setting* on page 82.

#### 2 Press BAND to switch the modes.

Press **BAND** repeatedly to switch between the following modes:

**ANALOG** (analog) — **DIGITAL** (digital)



#### Note

When this unit is connected to the DEQ-P7650, you can switch to the AUX mode to analog or digital. However, when you use **AUX** as the source, make sure the AUX mode is set to analog. AUX digital should not be used with this unit. ◻

## Introduction of DVD operation

You can use this unit with a separately sold DVD player or multi-DVD player.

For details concerning operation, refer to the DVD player's or multi-DVD player's operation

manual. This section provides information on DVD operations with this unit which differs from that described in the DVD player's or multi-DVD player's operation manual.

## Operation

You can use the following function with this unit. (Reference page is in this manual.)

- *Using ITS playlist and disc title functions* (Refer to the next page.)

Also, operation of the following function with this unit differs. (Reference page is in this manual.)

- *Function menu switching* (Refer to this page.)

## Function menu switching

#### ● During DVD playback, press F to display the function names.

Press **F** repeatedly to switch between the following functions:

**RPT** (repeat play)—**PAUSE** (pause)

#### ● During Video CD playback, press F to display the function names.

Press **F** repeatedly to switch between the following functions:

**RPT** (repeat play)—**PAUSE** (pause)

#### ● During CD playback, press F to display the function names.

Press **F** repeatedly to switch between the following functions:

**RPT** (repeat play)—**RDM** (random play)

—**SCAN** (scan play)—**ITS-P** (ITS play)—**PAUSE** (pause)



#### Notes

- When using this unit with multi-DVD player, you can switch to **ITS-P**.

## Other Functions

- Repeat play function is different depending on the disc types.
  - During DVD playback, press ◀◀ or ▶▶ to select the repeat range.
  - During Video CD or CD playback, press ⏮ or ◀⏮ to turn repeat play on or off.

### Using ITS playlist and disc title functions

During CD playback when using this unit with a multi-DVD player, you can use these functions. Operation is same as for multi-CD player. Please refer to multi-CD player section. 

### Using the PGM button

You can operate the preprogrammed functions for each source by using **BOOK.M**.

- **Press BOOK.M to turn pause on when selecting the following sources:**
  - **DVD** – Built-in DVD player
  - **S-DVD** – DVD player/multi-DVD player
  - **MULTI-CD** – Multi-CD player
  - To turn pause off, press **BOOK.M** again.
- **Press BOOK.M and hold to turn BSM on when selecting TUNER as the source.**

Press **BOOK.M** and hold until the BSM turns on.

  - To cancel the storage process, press **BOOK.M** again.
- **Press BOOK.M and hold to turn BSSM on when selecting TV as the source.**

Press **BOOK.M** and hold until the BSSM turns on.

  - To cancel the storage process, press **BOOK.M** again. 

## Additional Information

### Troubleshooting

#### Common

Symptom	Cause	Action (See)
Power doesn't turn on. The unit doesn't operate.	Leads and connectors are incorrectly connected.	Confirm once more that all connections are correct.
	The fuse is blown.	Rectify the reason for the fuse blowing, then replace the fuse. Be very sure to install the correct fuse with the same rating.
	Noise and other factors are causing the built-in microprocessor to operate incorrectly.	Turn the unit off and then on.
Operation with the remote control isn't possible. The unit does not operate correctly even when the appropriate remote control buttons are pressed.	The remote control operation mode is incorrect.	Switch to the correct remote control mode. (Page 14)
	The remote control code is incorrect.	Make sure the remote control selection switch setting and code type setting are the same. (Page 80)
	Battery power is low.	Load new battery. (Page 9)
	Some operations are prohibited with certain discs.	Check by using another disc.
Playback is not possible.	The disc is dirty.	Clean disc. (Page 92)
	The loaded disc is a type this unit cannot play.	Check what type the disc is.
	Non compatible video system disc is loaded.	Change to a disc compatible to your video system.
No sounds are heard. The volume level will not rise.	Cables are not connected correctly.	Connect the cables correctly.
	The unit is performing still, slow motion or frame-by-frame playback.	There is no sound during still, slow motion or frame-by-frame playback.
There is no picture.	The parking brake cord is not connected.	Connect a parking brake cord, and apply the parking brake.
	The parking brake is not applied.	Connect a parking brake cord, and apply the parking brake.
The icon  is displayed, and operation is not possible.	The operation is prohibited for the disc.	This operation is not possible.
	The operation is not compatible with the disc's organization.	This operation is not possible.
The picture stops (pauses) and the unit cannot be operated.	Reading of data has become impossible during playback.	After pressing  once, start playback once more.
There is no sound. Volume level is low.	The volume level is low.	Adjust the volume level.
	The attenuator is on.	Turn the attenuator off.
There is audio and video skipping.	The unit is not firmly secured.	Secure the unit firmly.
The picture is stretched, the aspect is incorrect.	The aspect setting is incorrect for the display.	Select the appropriate setting for your display. (Page 78)



## Additional Information

Symptom	Cause	Action (See)
When the ignition switch is turned ON (or turned to ACC), the motor sounds.	The unit is confirming whether a disc is loaded or not.	This is a normal operation.

### Problems during DVD playback

Symptom	Cause	Action (See)
Playback is not possible.	The loaded disc has a different region number from this unit.	Replace the disc with one featuring the same region number as this unit. (Page 6, Page 98)
A parental lock message is displayed and playback is not possible.	Parental lock is on.	Turn parental lock off or change the level. (Page 79)
Parental lock cannot be canceled.	The code number is incorrect.	Input the correct code number. (Page 79)
	You have forgotten your code number.	Press <b>CLEAR</b> 10 times to cancel the code number. (Page 80)
Dialog language (and subtitle language) cannot be switched.	The DVD playing does not feature multiple language recordings.	You cannot switch among multiple languages if they are not recorded on the disc.
	You can only switch between items indicated in the disc menu.	Switch using the disc menu.
No subtitles are displayed.	The DVD playing does not feature subtitles.	Subtitles are not displayed if they are not recorded on the disc.
	You can only switch between items indicated in the disc menu.	Switch using the disc menu.
Playback is not with the audio language and subtitle language settings selected in <b>SET-UP MENU</b> .	The DVD playing does not feature dialog or subtitles in the language selected in <b>SET-UP MENU</b> .	Switching to a selected language is not possible if the language selected in <b>SET-UP MENU</b> is not recorded on the disc.
Switching the viewing angle is not possible.	The DVD playing does not feature scenes shot from multiple angles.	You cannot switch between multiple angles if the DVD does not feature scenes recorded from multiple angles.
	You are trying to switch to multiple angle viewing of a scene that is not recorded from multiple angles.	Switch between multiple angles when watching scenes recorded from multiple angles.
The picture is extremely unclear/distorted and dark during playback.	The disc features a signal to prohibit copying. (Some discs may have this.)	Since this unit is compatible with the copy guard analog copy protect system, when playing a disc that has a signal prohibiting copying, the picture may suffer from horizontal stripes or other imperfections when viewed on some displays. This does not mean this unit is malfunctioning.

### Problems during Video CD playback

## Additional Information

Symptom	Cause	Action (See)
The PBC (playback control) menu display cannot be called up.	The Video CD playing does not feature PBC.	This operation is not possible with Video CDs not featuring PBC.

### Audio/DSP

Symptom	Cause	Action
Speakers are not available to be adjusted.	Their size settings is at <b>OFF</b> .	Make the correct size settings. (Page 67)
Time alignment is not available.	Listening position is not set correctly.	Set listening position correctly. (Page 64)
	Their size settings is at <b>OFF</b> .	Make the correct size settings. (Page 67)
The subwoofer is not available to switch its phase.	The subwoofer is set to <b>OFF</b> .	Set the subwoofer to <b>ON</b> . (Page 67)
Bass content is not heard.	The subwoofer is set to <b>OFF</b> and yet other speakers are set to <b>OFF</b> or <b>SML</b> in size.	Make the correct settings. (If no subwoofer is installed, the front or rear speaker needs to be set to <b>LRG</b> .) (Page 67)
Occasionally no sounds are output when Dolby Pro Logic II is turned on.	The center speaker setting is at <b>SML</b> or <b>LRG</b> whereas no center speaker is installed.	Change the center speaker size setting to <b>OFF</b> . (If the audio source is mono and Dolby Pro Logic II is turned on, sound is heard over the center speaker only.) (Page 67)
Occasionally no sounds are heard over speakers other than the center one.	Dolby Pro Logic II is turned on.	Turn Dolby Pro Logic II off. (If the audio source is mono and Dolby Pro Logic II is turned on, sound is heard over the center speaker only.) (Page 66)
Turning dynamic range control on has no effects.	The currently reproduced sound is not Dolby Digital coded.	The feature is only effective on Dolby Digital sounds. (Page 66)
No sounds are heard.	Optical cables are incorrectly connected.	Connect the cables correctly.



## Error messages

When problems occur with disc playback, an error message appears on the display. Refer to the table below to identify the problem, then take the suggested corrective action. If the error persists, contact your dealer or your nearest PIONEER Service Center.

### Error messages

Message	Cause	Action (See)
<b>ERROR-02</b>	Dirty disc	Clean disc.
	Scratched disc	Replace disc.

## Additional Information

Message	Cause	Action (See)
<b>TEMP</b>	The temperature of this unit is outside the normal operating range	Wait until the unit's temperature returns to within normal operating limits.
<b>NON-PLAY</b>	The disc does not have the same region number as this unit	Replace the DVD video with one bearing the correct region number.
	This type of disc cannot be played by this unit	Replace the disc with one this unit can play.
	The disc is loaded upside down	Check that the disc is loaded correctly.
<b>ERROR-05</b>	Electrical or mechanical	Turn the ignition ON and OFF, or switch to a different source, then back to the DVD player.
<b>PROTECT</b>	All the files on the inserted disc are secured by digital rights management (DRM)	Replace disc.
<b>SKIPPED</b>	The inserted disc contains WMA files that are protected by digital rights management (DRM)	Replace disc.

### Error messages on the display

Message	Cause	Action (See)
<b>ERROR-02</b>	Dirty disc	Clean disc.
	Scratched disc	Check that the disc is loaded correctly.
<b>THERMAL PROTECTION IN MOTION</b>	The temperature of this unit is outside the normal operating range	Wait until the unit's temperature returns to within normal operating limits.
<b>DIFFERENT REGION DISC</b>	The disc does not have the same region number as this unit	Replace the DVD video with one bearing the correct region number.
<b>NON-PLAYABLE DISC</b>	This type of disc cannot be played by this unit	Replace the disc with one this unit can play.
	The disc is loaded upside down	Check that the disc is loaded correctly.



## Understanding auto TA and EQ error messages

When correct measurement of car interior acoustic characteristics is not possible using the auto TA and EQ, an error message may appear on the display. If an error message appears, refer to the table below to see what the problem is and the suggested method of correcting the problem. After checking, try again.

Message	Cause	Action
<b>ERR MIC</b>	Microphone is not connected.	Plug the supplied microphone securely into the jack.

## Additional Information

Message	Cause	Action
<b>ERR FSP, ERR FLSP, ERR FRSP, ERR CSP, ERR RLSP, ERR RRSP, ERR SW</b>	The microphone cannot pick up the measuring tone of a speaker.	<ul style="list-style-type: none"> <li>• Confirm that the speakers are connected correctly.</li> <li>• Correct the input level setting of the power amp connected to the speakers.</li> <li>• Set the microphone correctly.</li> </ul>
<b>ERR NOIS</b>	The surrounding noise level is too high.	<ul style="list-style-type: none"> <li>• Stop your car in a place that is as quiet as possible, and switch off the engine, air conditioner or heater.</li> <li>• Set the microphone correctly.</li> </ul>



## DVD player and care

- Use only normal, round discs. If you insert irregular, non-round, shaped discs they may jam in the DVD player or not play properly.

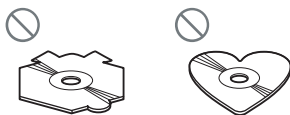

- Check all discs for cracks, scratches or warping before playing. Discs that have cracks, scratches or are warped may not play properly. Do not use such discs.
- Avoid touching the recorded (non-printed) surface when handling the disc.
- Store discs in their cases when not in use.
- Keep discs out of direct sunlight and do not expose the discs to high temperatures.
- Do not attach labels, write on or apply chemicals to the surface of the discs.
- To clean a disc, wipe the disc with a soft cloth outward from the center.



- If the heater is used in cold weather, condensation may form on components inside the DVD player. Condensation may cause the DVD player to not operate properly. If you think that condensation is a problem turn off the DVD player for an hour or so to allow it to dry out and wipe any damp discs with a soft cloth to remove the moisture.
- Road shocks may interrupt disc playback. ■

## DVD discs

- With some DVD video discs, it may not be possible to use certain functions.
- It may not be possible to play back some DVD video discs.
- When DVD-R/DVD-RW discs are used, playback is possible only for discs which have been finalized.
- When DVD-R/DVD-RW discs are used, playback is possible only for discs which have been recorded with the Video format (video mode). It is not possible to play back DVD-RW discs which have been recorded with the Video Recording format (VR mode).
- It may not be possible to play back DVD-R/DVD-RW discs which have been recorded

## Additional Information

with the Video format (video mode), because of disc characteristics, scratches or dirt on the disc, or dirt, condensation, etc. on the lens of this unit.

- Playback of discs recorded on a personal computer may not be possible, depending on the application settings and the environment. Please record with the correct format. (For details, contact the manufacturer of the application.)

### CD-R/CD-RW discs

- When CD-R/CD-RW discs are used, playback is possible only for discs which have been finalized.
- It may not be possible to play back CD-R/CD-RW discs recorded on a music CD recorder or a personal computer because of disc characteristics, scratches or dirt on the disc, or dirt, condensation, etc., on the lens of this unit.
- Playback of discs recorded on a personal computer may not be possible, depending on the application settings and the environment. Please record with the correct format. (For details, contact the manufacturer of the application.)
- Playback of CD-R/CD-RW discs may become impossible in case of direct exposure to sunlight, high temperatures, or the storage conditions in the vehicle.
- Titles and other text information recorded on a CD-R/CD-RW disc may not be displayed by this unit (in the case of audio data (CD-DA)).
- This unit conforms to the track skip function of the CD-R/CD-RW disc. The tracks containing the track skip information are skipped automatically (in case of audio data (CD-DA)).
- If you insert a CD-RW disc into this unit, time to playback will be longer than when you insert a conventional CD or CD-R disc.
- Read the precautions with CD-R/CD-RW discs before using them.

### MP3 and WMA files

- MP3 is short for MPEG Audio Layer 3 and refers to an audio compression technology standard.
- WMA is short for Windows Media™ Audio and refers to an audio compression technology that is developed by Microsoft Corporation. WMA data can be encoded by using Windows Media Player version 7, 7.1 or Windows Media Player for Windows XP.
- With some applications used to encode WMA files, this unit may not operate correctly.
- With some applications used to encode WMA files, album names and other text information may not be correctly displayed.
- This unit allows playback of MP3 files on CD-ROM, CD-R and CD-RW discs. Disc recordings compatible with level 1 and level 2 of ISO9660 and with the Romeo and Joliet file system can be played back.
- It is possible to play back multi-session compatible recorded discs.
- MP3/WMA files are not compatible with packet write data transfer.
- The maximum number of characters which can be displayed for a file name, including the extension (.mp3 or .wma), is 64, from the first character.
- The maximum number of characters which can be displayed for a folder name is 64.
- In case of files recorded according to the Romeo file system, only the first 64 characters can be displayed.

## Additional Information

- When playing discs with MP3/WMA files and audio data (CD-DA) such as CD-EXTRA and MIXED-MODE CDs, both types can be played only by switching mode between MP3/WMA and CD-DA.
- The folder selection sequence for playback and other operations becomes the writing sequence used by the writing software. For this reason, the expected sequence at the time of playback may not coincide with the actual playback sequence. However, there also is some writing software which permits setting of the playback order.
- Some audio CDs contain tracks that merge into one another without a pause. When these discs are converted to MP3/WMA files and burned to a CD-R/CD-RW/CD-ROM, the files will be played back on this player with a short pause between each one, regardless of the length of the pause between tracks on the original audio CD.

### Important

- When naming an MP3 or a WMA file, add the corresponding filename extension (.mp3 or .wma).
- This unit plays back files with the filename extension (.mp3 or .wma) as an MP3 or a WMA file. To prevent noise and malfunctions, do not use these extensions for files other than MP3 or WMA files.

### MP3 additional information

- Files are compatible with the ID3 Tag Ver. 1.0, 1.1, 2.2 and 2.3 formats for display of album (disc title), track (track title), artist (track artist) and comments. Ver. 2.x of ID3 Tag is given priority when both Ver. 1.x and Ver. 2.x exist.
- The emphasis function is valid only when MP3 files of 32, 44.1 and 48 kHz frequencies are played back. (16, 22.05, 24, 32,

44.1, 48 kHz sampling frequencies can be played back.)

- There is no m3u playlist compatibility.
- There is no compatibility with the MP3i (MP3 interactive) or mp3 PRO formats.
- The sound quality of MP3 files generally becomes better with an increased bit rate. This unit can play recordings with bit rates from 8 kbps to 320 kbps, but in order to be able to enjoy sound of a certain quality, we recommend using only discs recorded with a bit rate of at least 128 kbps.

### WMA additional information

- This unit plays back WMA files encoded by Windows Media Player version 7 and 8.
- You can only play back WMA files in the frequencies 32, 44.1 and 48 kHz.
- The sound quality of WMA files generally becomes better with an increased bit rate. This unit can play recordings with bit rates from 48 kbps to 192 kbps, but in order to be able to enjoy sound of a certain quality, we recommend using discs recorded with a higher bit rate.
- This unit does not play back WMA files recorded as VBR (variable bit rate).
- This unit doesn't support the following formats.
  - Windows Media Audio 9 Professional (5.1ch)
  - Windows Media Audio 9 Lossless
  - Windows Media Audio 9 Voice

### About folders and MP3/WMA files

- An outline of a CD-ROM with MP3/WMA files on it is shown below. Subfolders are shown as folders in the folder currently selected.

## Additional Information

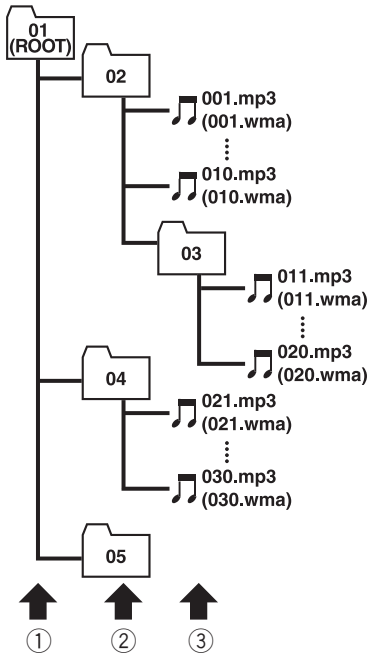

- ① First level
- ② Second level
- ③ Third level



### Notes

- This unit assigns folder numbers. The user can not assign folder numbers.
- It is not possible to check folders that do not include MP3/WMA files. (These folders will be skipped without displaying the folder number.)
- MP3/WMA files in up to 8 tiers of folders can be played back. However, there is a delay in the start of playback on discs with numerous tiers. For this reason we recommend creating discs with no more than 2 tiers.
- It is possible to play back up to 253 items from folders on one disc. ▣

## Additional Information

### Language code chart for DVD

Language (code), input code	Language (code), input code	Language (code), input code
Japanese (ja), <b>1001</b>	Guarani (gn), <b>0714</b>	Pashto, Pushto (ps), <b>1619</b>
English (en), <b>0514</b>	Gujarati (gu), <b>0721</b>	Quechua (qu), <b>1721</b>
French (fr), <b>0618</b>	Hausa (ha), <b>0801</b>	Rhaeto-Romance (rm), <b>1813</b>
Spanish (es), <b>0519</b>	Hindi (hi), <b>0809</b>	Kirundi (rn), <b>1814</b>
German (de), <b>0405</b>	Croatian (hr), <b>0818</b>	Romanian (ro), <b>1815</b>
Italian (it), <b>0920</b>	Hungarian (hu), <b>0821</b>	Kinyarwanda (rw), <b>1823</b>
Chinese (zh), <b>2608</b>	Armenian (hy), <b>0825</b>	Sanskrit (sa), <b>1901</b>
Dutch (nl), <b>1412</b>	Interlingua (ia), <b>0901</b>	Sindhi (sd), <b>1904</b>
Portuguese (pt), <b>1620</b>	Interlingue (ie), <b>0905</b>	Sangho (sg), <b>1907</b>
Swedish (sv), <b>1922</b>	Inupiak (ik), <b>0911</b>	Serbo-Croatian (sh), <b>1908</b>
Russian (ru), <b>1821</b>	Indonesian (in), <b>0914</b>	Sinhalese (si), <b>1909</b>
Korean (ko), <b>1115</b>	Icelandic (is), <b>0919</b>	Slovak (sk), <b>1911</b>
Greek (el), <b>0512</b>	Hebrew (iw), <b>0923</b>	Slovenian (sl), <b>1912</b>
Afar (aa), <b>0101</b>	Yiddish (ji), <b>1009</b>	Samoan (sm), <b>1913</b>
Abkhazian (ab), <b>0102</b>	Javanese (jw), <b>1023</b>	Shona (sn), <b>1914</b>
Afrikaans (af), <b>0106</b>	Georgian (ka), <b>1101</b>	Somali (so), <b>1915</b>
Amharic (am), <b>0113</b>	Kazakh (kk), <b>1111</b>	Albanian (sq), <b>1917</b>
Arabic (ar), <b>0118</b>	Greenlandic (kl), <b>1112</b>	Serbian (sr), <b>1918</b>
Assamese (as), <b>0119</b>	Cambodian (km), <b>1113</b>	Siswati (ss), <b>1919</b>
Aymara (ay), <b>0125</b>	Kannada (kn), <b>1114</b>	Sesotho (st), <b>1920</b>
Azerbaijani (az), <b>0126</b>	Kashmiri (ks), <b>1119</b>	Sundanese (su), <b>1921</b>
Bashkir (ba), <b>0201</b>	Kurdish (ku), <b>1121</b>	Swahili (sw), <b>1923</b>
Byelorussian (be), <b>0205</b>	Kirghiz (ky), <b>1125</b>	Tamil (ta), <b>2001</b>
Bulgarian (bg), <b>0207</b>	Latin (la), <b>1201</b>	Telugu (te), <b>2005</b>
Bihari (bh), <b>0208</b>	Lingala (ln), <b>1214</b>	Tajik (tg), <b>2007</b>
Bislama (bi), <b>0209</b>	Laothian (lo), <b>1215</b>	Thai (th), <b>2008</b>
Bengali (bn), <b>0214</b>	Lithuanian (lt), <b>1220</b>	Tigrinya (ti), <b>2009</b>
Tibetan (bo), <b>0215</b>	Latvian (lv), <b>1222</b>	Turkmen (tk), <b>2011</b>
Breton (br), <b>0218</b>	Malagasy (mg), <b>1307</b>	Tagalog (tl), <b>2012</b>
Catalan (ca), <b>0301</b>	Maori (mi), <b>1309</b>	Setswana (tn), <b>2014</b>
Corsican (co), <b>0315</b>	Macedonian (mk), <b>1311</b>	Tonga (to), <b>2015</b>
Czech (cs), <b>0319</b>	Malayalam (ml), <b>1312</b>	Turkish (tr), <b>2018</b>
Welsh (cy), <b>0325</b>	Mongolian (mn), <b>1314</b>	Tsonga (ts), <b>2019</b>
Danish (da), <b>0401</b>	Moldavian (mo), <b>1315</b>	Tatar (tt), <b>2020</b>
Bhutani (dz), <b>0426</b>	Marathi (mr), <b>1318</b>	Twi (tw), <b>2023</b>
Esperanto (eo), <b>0515</b>	Malay (ms), <b>1319</b>	Ukrainian (uk), <b>2111</b>
Estonian (et), <b>0520</b>	Maltese (mt), <b>1320</b>	Urdu (ur), <b>2118</b>
Basque (eu), <b>0521</b>	Burmese (my), <b>1325</b>	Uzbek (uz), <b>2126</b>
Persian (fa), <b>0601</b>	Nauru (na), <b>1401</b>	Vietnamese (vi), <b>2209</b>
Finnish (fi), <b>0609</b>	Nepali (ne), <b>1405</b>	Volapük (vo), <b>2215</b>
Fiji (fj), <b>0610</b>	Norwegian (no), <b>1415</b>	Wolof (wo), <b>2315</b>
Faroese (fo), <b>0615</b>	Occitan (oc), <b>1503</b>	Xhosa (xh), <b>2408</b>
Frisian (fy), <b>0625</b>	Oromo (om), <b>1513</b>	Yoruba (yo), <b>2515</b>
Irish (ga), <b>0701</b>	Oriya (or), <b>1518</b>	Zulu (zu), <b>2621</b>
Scots-Gaelic (gd), <b>0704</b>	Panjabi (pa), <b>1601</b>	
Galician (gl), <b>0712</b>	Polish (pl), <b>1612</b>	





## Additional Information

### Terms

#### Aspect ratio

This is the width-to-height ratio of a TV screen. A regular display has an aspect ratio of 4:3. Wide screen displays have an aspect ratio of 16:9, providing a bigger picture for exceptional presence and atmosphere.

#### Bit rate

This expresses data volume per second, or bps units (bits per second). The higher the rate, the more information is available to reproduce the sound. Using the same encoding method (such as MP3), the higher the rate, the better the sound.

#### Chapter

DVD titles are in turn divided into chapters which are numbered in the same way as the chapters of a book. With DVD video discs featuring chapters, you can quickly find a desired scene with chapter search.

#### Dolby Digital

Dolby Digital provides multi-channel audio from up to 5.1 independent channels. This is the same as the Dolby Digital surround sound system used in theaters.



#### DTS

This stands for Digital Theater Systems. DTS is a surround system delivering multi-channel audio from up to 6 independent channels.



#### ID3 tag

This is a method of embedding track-related information in an MP3 file. This embedded information can include the track title, the artist's name, the album title, the music genre,

the year of production, comments and other data. The contents can be freely edited using software with ID3 Tag editing functions. Although the tags are restricted as to the number of characters, the information can be viewed when the track is played back.

#### ISO9660 format

This is the international standard for the format logic of CD-ROM folders and files. For the ISO9660 format, there are regulations for the following two levels.

##### Level 1:

The file name is in 8.3 format (the name consists of up to 8 characters, half-byte English capital letters and half-byte numerals and the "\_" sign, with a file-extension of three characters.)

##### Level 2:

The file name can have up to 31 characters (including the separation mark "." and a file extension). Each folder contains less than 8 hierarchies.

#### Extended formats

Joliet:

File names can have up to 64 characters.

Romeo:

File names can have up to 128 characters.

#### Linear PCM (LPCM)/Pulse code modulation

This stands for linear pulse code modulation, which is the signal recording system used for music CDs and DVDs. Generally, DVDs are recorded with higher sampling frequency and bit rate than CDs. Therefore, DVDs can provide higher sound quality.

#### m3u

Playlists created using the "WINAMP" software have a playlist file extension (.m3u).

## Additional Information

### MP3

MP3 is short for MPEG Audio Layer 3. It is an audio compression standard set by a working group (MPEG) of the ISO (International Standards Organization). MP3 is able to compress audio data to about 1/10th the level of a conventional disc.

### MPEG

This stands for Moving Pictures Experts Group, and is an international video image compression standard. Some DVDs feature digital audio compressed and recorded using this system.

### Multi-angle

With regular TV programs, although multiple cameras are used to simultaneously shoot scenes, only images from one camera at a time are transmitted to your TV. Some DVDs feature scenes shot from multiple angles, letting you choose your viewing angle as desired.

### Multi-audio (Multilingual dialog)

Some DVDs feature dialog recorded in multiple languages. Dialog in up to 8 languages can be recorded on a single disc, letting you choose as desired.

### Multi-session

Multi-session is a recording method that allows additional data to be recorded later. When recording data on a CD-ROM, CD-R or CD-RW, etc., all data from beginning to end is treated as a single unit or session. Multi-session is a method of recording more than 2 sessions on one disc.

### Multi-subtitle

Subtitles in up to 32 languages can be recorded on a single DVD, letting you choose as desired.

### Optical digital output/input

By transmitting and receiving audio signals in a digital signal format, the chance of sonic quality deteriorating in the course of transmission is minimized. An optical digital output/input is designed to transmit and receive digital signals optically.

### Packet write

This is a general term for a method of writing on CD-R, etc., at the time required for a file, just as is done with files on floppy or hard discs.

### Parental lock

Some DVD video discs with violent or adult-oriented scenes feature parental lock which prevents children from viewing such scenes. With this kind of disc, if you set the unit's parental lock level, playback of scenes inappropriate for children will be disabled, or these scenes will be skipped.

### Playback control (PBC)

This is a playback control signal recorded on Video CDs (Version 2.0). Using menu displays provided by Video CDs with PBC lets you enjoy playback of simple interactive software and software with search functions. You can also enjoy viewing high- and standard-resolution still images.

### Region number

DVD players and DVD discs feature region numbers indicating the area in which they were purchased. Playback of a DVD is not possible unless it features the same region number as the DVD player. This unit's region number is displayed on the bottom of the unit.

### Title

DVD video discs have high data capacity, enabling recording of multiple movies on a single disc. If, for example, one disc contains three separate movies, they are divided into

## Additional Information

title 1, title 2 and title 3. This lets you enjoy the convenience of title search and other functions.

### VBR

VBR is short for variable bit rate. Generally speaking CBR (constant bit rate) is more widely used. But by flexibly adjusting the bit rate according to the needs of audio compression, it is possible to achieve compression-priority sound quality.

### WMA

WMA is short for Windows Media™ Audio and refers to an audio compression technology that is developed by Microsoft Corporation. WMA data can be encoded by using Windows Media Player version 7 or later. Microsoft, Windows Media, and the Windows logo are trademarks, or registered trademarks of Microsoft Corporation in the United States and/or other countries. ■

# Additional Information

## Specifications

### General

Power source .....	14.4 V DC (10.8 – 15.1 V al- lowable)
Grounding system .....	Negative type
Max. current consumption .....	10.0 A
Dimensions (W × H × D):	
DIN	
Chassis .....	178 × 50 × 160 mm
Nose .....	188 × 58 × 20 mm
D	
Chassis .....	178 × 50 × 165 mm
Nose .....	170 × 46 × 15 mm
Weight .....	1.4 kg

### Audio

Continuous power output is 22 W per channel minimum into 4 ohms, both channels driven 50 to 15,000 Hz with no more than 5% THD.	
Maximum power output .....	50 W × 4 50 W × 2/4 $\Omega$ + 70 W × 1/2 $\Omega$ (for subwoofer)
Load impedance .....	4 $\Omega$ (4 – 8 $\Omega$ [2 $\Omega$ for 1 ch] al- lowable)
Preout max output level/output impedance .....	2.2 V/1k $\Omega$
Equalizer (3-Band Parametric Equalizer):	
Low	
Frequency .....	40/80/100/160 Hz
Q Factor .....	0.35/0.59/0.95/1.15 (+6 dB when boosted)
Gain .....	$\pm 12$ dB
Mid	
Frequency .....	200/500/1k/2k Hz
Q Factor .....	0.35/0.59/0.95/1.15 (+6 dB when boosted)
Gain .....	$\pm 12$ dB
High	
Frequency .....	3.15k/8k/10k/12.5k Hz
Q Factor .....	0.35/0.59/0.95/1.15 (+6 dB when boosted)
Gain .....	$\pm 12$ dB
Loudness contour	
Low .....	+3.5 dB (100 Hz), +3 dB (10 kHz)
Mid .....	+10 dB (100 Hz), +6.5 dB (10 kHz)
High .....	+11 dB (100 Hz), +11 dB (10 kHz) (volume: –30 dB)

### Tone controls:

Bass	
Frequency .....	40/63/100/160 Hz
Gain .....	$\pm 12$ dB
Treble	
Frequency .....	2.5k/4k/6.3k/10k Hz
Gain .....	$\pm 12$ dB

### HPF:

Frequency .....	50/80/125 Hz
Slope .....	–12 dB/oct

### Subwoofer:

Frequency .....	50/80/125 Hz
Slope .....	–18 dB/oct
Gain .....	$\pm 12$ dB
Phase .....	Normal/Reverse

### DVD Player

System .....	DVD video, Video CD, Com- pact disc audio system
Usable discs .....	DVD video, Video CD, Com- pact disc
Region number:	
for Southeast Asian models	3
for South American and Oceanian models	4
Signal format:	
Sampling frequency .....	44.1/48/96 kHz
Number of quantization bits	16/20/24; linear
Frequency response .....	5 – 44,000 Hz (with DVD, at sampling frequency 96 kHz)
Signal-to-noise ratio .....	97 dB (1 kHz) (IEC-A net- work) (CD: 96 dB (1 kHz) (IEC-A network))
Dynamic range .....	95 dB (1 kHz) (CD: 94 dB (1 kHz))
Distortion .....	0.008 % (1 kHz)
Output level:	
Video .....	1.0 Vp-p/75 $\Omega$ ( $\pm 0.2$ V)
Audio .....	1.0 V (1 kHz, 0 dB)
Number of channels .....	2 (stereo)
MP3 decoding format .....	MPEG-1 & 2 Audio Layer 3
WMA decoding format .....	Ver. 7 & 8

### FM tuner

Frequency range .....	87.5 – 108.0 MHz
Usable sensitivity .....	8 dBf (0.7 $\mu$ V/75 $\Omega$ mono, S/N: 30 dB)
50 dB quieting sensitivity .....	10 dBf (0.9 $\mu$ V/75 $\Omega$ mono)

## Additional Information

Signal-to-noise ratio .....	75 dB (IEC-A network)
Distortion .....	0.3 % (at 65 dBf, 1 kHz, stereo)
	0.1 % (at 65 dBf, 1 kHz, mono)
Frequency response .....	30 – 15,000 Hz ( $\pm 3$ dB)
Stereo separation .....	45 dB (at 65 dBf, 1 kHz)

### AM tuner

Frequency range .....	531 – 1,602 kHz (9 kHz)
	530 – 1,640 kHz (10 kHz)
Usable sensitivity .....	18 $\mu$ V (S/N: 20 dB)
Signal-to-noise ratio .....	65 dB (IEC-A network)

### Infrared remote control

Wavelength .....	940 nm $\pm 50$ nm
Output .....	typ; 12 mw/sr per Infrared LED



#### Note

Specifications and the design are subject to possible modifications without notice due to improvements.



## **PIONEER CORPORATION**

4-1, MEGURO 1-CHOME, MEGURO-KU, TOKYO 153-8654, JAPAN

### **PIONEER ELECTRONICS (USA) INC.**

P.O. Box 1540, Long Beach, California 90801-1540, U.S.A.  
TEL: (800) 421-1404

### **PIONEER EUROPE NV**

Haven 1087, Keetberglaan 1, B-9120 Melsele, Belgium  
TEL: (0) 3/570.05.11

### **PIONEER ELECTRONICS ASIACENTRE PTE. LTD.**

253 Alexandra Road, #04-01, Singapore 159936  
TEL: 65-6472-7555

### **PIONEER ELECTRONICS AUSTRALIA PTY. LTD.**

178-184 Boundary Road, Braeside, Victoria 3195, Australia  
TEL: (03) 9586-6300

### **PIONEER ELECTRONICS OF CANADA, INC.**

300 Allstate Parkway, Markham, Ontario L3R OP2, Canada  
TEL: 1-877-283-5901

### **PIONEER ELECTRONICS DE MEXICO, S.A. de C.V.**

Bldv.Manuel Avila Camacho 138 10 piso  
Col.Lomas de Chapultepec, Mexico, D.F. 11000  
TEL: 55-9178-4270

### **先鋒股份有限公司**

總公司：台北市中山北路二段44號13樓  
電話：(02) 2521-3588

### **先鋒電子（香港）有限公司**

香港九龍尖沙咀海港城世界商業中心  
9樓901-6室  
電話：(0852) 2848-6488

Published by Pioneer Corporation.  
Copyright © 2004 by Pioneer Corporation.  
All rights reserved.

Printed in Japan

<KNNZF> <04C00000>

<CRB1935-A> RD,RC

Download from [Www.Somanuals.com](http://Www.Somanuals.com). All Manuals Search And Download.

## Free Manuals Download Website

<http://myh66.com>

<http://usermanuals.us>

<http://www.somanuals.com>

<http://www.4manuals.cc>

<http://www.manual-lib.com>

<http://www.404manual.com>

<http://www.luxmanual.com>

<http://aubethermostatmanual.com>

Golf course search by state

<http://golfingnear.com>

Email search by domain

<http://emailbydomain.com>

Auto manuals search

<http://auto.somanuals.com>

TV manuals search

<http://tv.somanuals.com>