

Pioneer *sound.vision.soul*

PLASMA DISPLAY SYSTEM

PRO-1110HD
PRO-910HD

ELITE

Register Your Product on
www.pioneerelectronics.com

Operating Instructions

DOLBY
DIGITAL

SRS
WOW

IMPORTANT



The lightning flash with arrowhead symbol, within an equilateral triangle, is intended to alert the user to the presence of uninsulated "dangerous voltage" within the product's enclosure that may be of sufficient magnitude to constitute a risk of electric shock to persons.

CAUTION

**RISK OF ELECTRIC SHOCK
DO NOT OPEN**

CAUTION:
TO PREVENT THE RISK OF ELECTRIC SHOCK, DO NOT REMOVE COVER (OR BACK). NO USER-SERVICEABLE PARTS INSIDE. REFER SERVICING TO QUALIFIED SERVICE PERSONNEL.



The exclamation point within an equilateral triangle is intended to alert the user to the presence of important operating and maintenance (servicing) instructions in the literature accompanying the appliance.

IMPORTANT



Ce symbole de l'éclair, placé dans un triangle équilatéral, a pour but d'attirer l'attention de l'utilisateur sur la présence, à l'intérieur du coffret de l'appareil, de tensions dangereuses non isolées d'une grandeur suffisante pour représenter un risque d'électrocution pour les êtres humains.

ATTENTION

**DANGER D'ELECTROCUTION
NES PAS OUVRIR**

ATTENTION:
POUR EVITER TOUT RISQUE D'ELECTROCUTION, NE PAS ENLEVER LE COUVERCLE (NI LE PANNEAU ARRIERE). AUCUNE PIECE REPARABLE PAR L'UTILISATEUR NE SE TROUVE A L'INTERIEUR. CONFIER TOUT ENTRETIEN A UN PERSONNEL QUALIFIE UNIQUEMENT.



Ce point d'exclamation, placé dans un triangle équilatéral, a pour but d'attirer l'attention de l'utilisateur sur la présence, dans les documents qui accompagnent l'appareil, d'explications importantes du point de vue de l'exploitation ou de l'entretien.

IMPORTANT SAFETY INSTRUCTIONS

- 1) Read these instructions.
- 2) Keep these instructions.
- 3) Heed all warnings.
- 4) Follow all instructions.
- 5) Do not use this apparatus near water.
- 6) Clean only with dry cloth.
- 7) Do not block any ventilation openings. Install in accordance with the manufacturer's instructions.
- 8) Do not install near any heat sources such as radiators, heat registers, stoves, or other apparatus (including amplifiers) that produce heat.
- 9) Do not defeat the safety purpose of the polarized or grounding-type plug. A polarized plug has two blades with one wider than the other. A grounding type plug has two blades and a third grounding prong. The wide blade or the third prong are provided for your safety. If the provided plug does not fit into your outlet, consult an electrician for replacement of the obsolete outlet.
- 10) Protect the power cord from being walked on or pinched particularly at plugs, convenience receptacles, and the point where they exit from the apparatus.
- 11) Only use attachments/accessories specified by the manufacturer.
- 12) Use only with the cart, stand, tripod, bracket, or table specified by the manufacturer, or sold with the apparatus. When a cart is used, use caution when moving the cart/apparatus combination to avoid injury from tip-over.
- 13) Unplug this apparatus during lightning storms or when unused for long periods of time.
- 14) Refer all servicing to qualified service personnel. Servicing is required when the apparatus has been damaged in any way, such as power-supply cord or plug is damaged, liquid has been spilled or objects have fallen into the apparatus, the apparatus has been exposed to rain or moisture, does not operate normally, or has been dropped.



WARNING: THE APPARATUS IS NOT WATER-PROOFS, TO PREVENT FIRE OR SHOCK HAZARD, DO NOT EXPOSE THIS APPLIANCE TO RAIN OR MOISTURE AND DO NOT PUT ANY WATER SOURCE NEAR THIS APPARATUS, SUCH AS VASE, FLOWER POT, COSMETICS CONTAINER AND MEDICINE BOTTLE ETC.

AVERTISSEMENT: CET APPAREIL N'EST PAS ÉTANCHE. POUR ÉVITER TOUT RISQUE D'INCENDIE OU TOUTE SECOUSSE ÉLECTRIQUE, NE L'EXPOSEZ PAS À LA PLUIE NI À L'HUMIDITÉ, NE LE PLACEZ PAS À PROXIMITÉ D'UN POINT D'EAU NI D'UN VASE, D'UN FLACON DE COSMÉTIQUE OU DE MÉDICAMENT, ETC.

Note to CATV system installer.

This reminder is provided to call the CATV system installer's attention to Article 820-40 of the NEC that provides guidelines for proper grounding and, in particular, specifies that the cable ground shall be connected to the grounding system of the building, as close to the point of cable entry as practical.



WARNING: Handling the cord on this product or cords associated with accessories sold with the product will expose you to lead, a chemical known to the State of California and other governmental entities to cause cancer and birth defects or other reproductive harm. **Wash hands after handling.**

NOTE: This equipment has been tested and found to comply with the limits for a class B digital device, pursuant to Part 15 of the FCC Rules. These limits are designed to provide reasonable protection against harmful interference in a residential installation. This equipment generates, uses, and can radiate radio frequency energy and, if not installed and used in accordance with the instructions, may cause harmful interference to radio communications. However, there is no guarantee that interference will not occur in a particular installation. If this equipment does cause harmful interference to radio or television reception, which can be determined by turning the equipment off and on, the user is encouraged to try to correct the interference by one or more of the following measures:

- Reorient or relocate the receiving antenna.
- Increase the separation between the equipment and receiver.
- Connect the equipment into an outlet on a circuit different from that to which the receiver is connected.
- Consult the dealer or an experienced radio/TV technician for help.

Information to User
Alteration or modifications carried out without appropriate authorization may invalidate the user's right to operate the equipment.

[For Canadian model]
This Class B digital apparatus complies with Canadian ICES-003.

[Pour le modèle destiné au Canada]
Cet appareil numérique de la classe B est conforme à la norme canadienne ICES-003.

CAUTION
DO NOT PLACE THIS PRODUCT ON AN UNSTABLE CART, STAND, TRIPOD, BRACKET, OR TABLE. THE PRODUCT MAY FALL, CAUSING SERIOUS PERSONAL INJURY AND SERIOUS DAMAGE TO THE PRODUCT. USE ONLY WITH A CART, STAND, TRIPOD, BRACKET, OR TABLE RECOMMENDED BY THE MANUFACTURER, OR SOLD WITH THE PRODUCT. FOLLOW THE MANUFACTURE'S INSTRUCTIONS WHEN INSTALLING THE PRODUCT AND USE MOUNTING ACCESSORIES RECOMMENDED BY THE MANUFACTURER.
A PRODUCT AND CART COMBINATION SHOULD BE MOVED WITH THE CARE. QUICK STOPS, EXCESSIVE FORCE, AND UNEVEN SURFACES MAY CAUSE THE PRODUCT AND CART COMBINATION TO OVERTURN.



CAUTION:
This product satisfies FCC regulations when shielded cables and connectors are used to connect the unit to other equipment. To prevent electromagnetic interference with electric appliances such as radios and televisions, use shielded cables and connectors for connections.

**FEDERAL COMMUNICATIONS COMMISSION
DECLARATION OF CONFORMITY**

This device complies with part 15 of the FCC Rules. Operation is subject to the following two conditions: (1) This device may not cause harmful interference, and (2) this device must accept any interference received, including interference that may cause undesired operation.

Product Name: Plasma Display System
(Plasma Display)
(Media Receiver)

Model Number: PRO-1110HD / PRO-910HD
(PRO-504PU) / (PRO-434PU)
(PRO-R04U) / (PRO-R04U)

Product Category: Class B Personal Computers & Peripherals

Responsible Party Name: PIONEER ELECTRONICS (USA), INC., Customer Support Div.

Address: P.O. BOX 1760, LONG BEACH, CA., 90801-1760 U.S.A.

Phone: (800) 421-1625

For Business Customer URL
<http://www.PioneerUSA.com>

IMPORTANT NOTICE: The serial number for this equipment is located on the rear panel. Please write this serial number on your enclosed warranty card and keep it in a secure area. This is for your security.

DANGER
NE DÉPOSEZ PAS L'APPAREIL SUR UNE TABLE, UN CHARIOT, UN SUPPORT, UN TRÉPIED, UNE CONSOLE INSTABLES. CET APPAREIL POURRAIT TOMBER, PROVOQUANT DES BLESSURES GRAVES OU DES DOMMAGES PHYSIQUES IMPORTANTS. UTILISEZ UNIQUEMENT UN CHARIOT, UN SUPPORT, UN TRÉPIED, UNE CONSOLE OU UNE TABLE CONSEILLÉS PAR LE FABRICANT OU VENDUS AVEC L'APPAREIL. RESPECTEZ LES INSTRUCTIONS DU FABRICANT POUR TOUT CE QUI CONCERNE L'INSTALLATION DE L'APPAREIL ET L'EMPLOI DES ACCESSOIRES DE MONTAGE QU'IL CONSEILLE.
L'ENSEMBLE QUE FORME UN APPAREIL ET LE CHARIOT À L'AIDE DUQUEL ON LE DÉPLACE, DOIT ÊTRE MANŒVRÉ AVEC PRÉCAUTION. LES ARRÊTS BRUSQUES, LES POUSSÉES EXCESSIVES ET LES IRRÉGULARITÉS DU PLANCHER, PEUVENT PROVOQUER LE BASCULEMENT DU CHARIOT ET LA CHUTE DE L'APPAREIL.



Contents

Thank you for buying this Pioneer product.

Please read through these operating instructions so you will know how to operate your model properly. After you have finished reading the instructions, put them away in a safe place for future reference.

In some countries or regions, the shape of the power plug and power outlet may sometimes differ from that shown in the explanatory drawings. However the method of connecting and operating the unit is the same.

01 Important User Guidance Information

02 Safety Precautions

03 Operational Precautions

04 Features

05 Supplied Accessories

Plasma Display	12
Media Receiver	12

06 Part Names

Plasma Display	13
Media Receiver	14
Remote control unit	16

07 Preparation

Allowed operation range of the remote control unit	17
Installing the Plasma Display	17
Installing the Media receiver	18
Installing the Media Receiver vertically	19
Setting the system	20
Routing cables	21
Using the remote control unit	22
Cautions regarding the remote control unit	22
Inserting batteries	22
Cautions regarding batteries	23
Cable connections for watching conventional TV channels	24
Connecting a VHF/UHF antenna	24
Connecting a Cable Converter	24
Connecting a VHF/UHF antenna and Cable Converter	25
Switching between tuner A and B	25
Cable connections for watching digital TV channels	26
Connecting a VHF/UHF antenna	26
Connecting for cable TV	26
Connecting the power cord	27

08 Basic Operations

Turning on the power	28
Turning off the power	29
Watching conventional TV channels	30
Selecting the antenna	30
Changing channels	30
Changing the volume and sound	31
Setting MTS/SAP mode	32
Watching digital TV channels	34
Selecting the digital TV input	34
Changing channels	34
Changing the volume and sound	35
Changing the language	35
Viewing DTV banners	36

Using the multiscreen functions	36
Splitting the screen	36
Freezing images	37

09 Basic Adjustment Settings

Using the menu	38
AV mode menus	38
PC mode menus	39
Menu operation keys	40
Setting up conventional TV channels	41
Using Auto Channel Preset	41
Setting for skipping unwanted channels	42
Setting your favorite channels	43
Setting up digital TV channels	44
Using Auto Channel Preset	44
Setting for skipping unwanted channels	45
Checking signal strength	45
Language setting	46
Clock setting	46
AV Selection	47
Picture adjustments	48
PureCinema	49
Color temperature	50
MPEG NR	51
DNR	51
CTI	52
DRE	52
Color Management	53
Sound adjustments	53
FOCUS	54
Front Surround	54
Power Control	55
Power Control for AV source	55
Power Control for PC source	56

10 Electronic Program Guide (EPG) (for DTV Only)

EPG display format	57
Using the EPG	58
Presetting TV programs using the EPG	59
Using auto channel select	59
Recording TV programs using a D-VHS recorder	60
Recording TV programs via a VCR controller	61
Setting the timer manually	62
Priority rules for overlapped presettings	63
Changing/ canceling TV program presettings	64
Using the EPG	64
Using the menu	64

Contents

11 Enjoying through External Equipment

Watching a DVD image	65
Connecting a DVD player	65
Displaying a DVD image	65
Watching a VCR image	66
Connecting a VCR	66
Displaying a VCR image	66
Enjoying a game console or watching camcorder images	67
Connecting a game console or camcorder	67
Displaying an image of the game console or camcorder	67
Recording digital TV programs using a VCR or DVD recorder	68
Connecting a recorder	68
Connecting other audio equipment	69
Connecting an AV receiver	69
Switching the optical audio signal type	69
Watching a D-VHS image	70
What is i.LINK?	70
Which i.LINK devices are connectable?	70
What can be recorded through i.LINK?	70
Connecting D-VHS recorders	70
Displaying a D-VHS image	72
Useful and important notification	72
Setting up for controlling a D-VHS recorder	73
Operating the control panel screen	74
Editing the i.LINK list	74
Setting up for i.LINK standby	76
Watching an image from a personal computer	77
Connecting a personal computer	77
Displaying an image from a personal computer	77
Connecting a VCR controller	78
The lists of controllable recording equipment manufactures	79
Connecting control cords	80
About SR+	80

12 Useful Adjustment Settings

Adjusting image positions (AV mode only)	81
Adjusting image positions and clock automatically (PC mode only)	81
Adjusting image positions and clock manually (PC mode only)	82
Selecting a screen size	83
Changing the brightness at both sides of the screen (Side Mask)	84
Sleep Timer	85
Closed caption for conventional TV channels	86
Activating the closed caption	86
Selecting the type of closed captions	86

Closed caption for digital TV channels	87
Activating the closed caption	87
Selecting the type of conventional closed captions (for digital TV channels)	87
Selecting digital closed captions	88
Selecting digital closed caption parameters	88
Parental Control (setting the V-CHIP level)	90
Activating the Parental Control	90
Setting the voluntary moving rating system (MPAA)	91
Blocking Not Rated (NR) TV programs	91
Setting the TV Parental Guidelines (TV Guidelines) ...	92
Canadian rating systems	92
Setting Canadian English ratings	93
Setting Canadian French ratings	93
Temporarily deactivating the V-CHIP Block	94
Reactivating the V-CHIP Block	94
Programming a password (AV mode only)	95
Setting and changing the password	95
Resetting the password	96

13 Useful Features

Learning function of the remote control unit	97
Using the learning function	97
Presetting manufacture codes	98
Manufacture codes	99
Using the remote control unit to control other devices	100
Receiver control buttons	100
Cable control buttons	101
SAT control buttons	102
VCR control buttons	103
DVD/DVR control buttons	104

14 Appendix

Troubleshooting	106
Computer compatibility chart	107
Specifications	108

In order to obtain maximum enjoyment from this Pioneer PureVision PRO-1110HD/PRO-910HD Plasma Display System, please first read this information carefully.

With the Pioneer PureVision PRO-1110HD/PRO-910HD, you can be assured of a high quality Plasma Display System with long-life and high reliability. To achieve images of exceptional quality, this Pioneer Plasma Display System incorporates state-of-the-art design and construction, as well as very precise and highly advanced technology.

Over the course of its lifetime, the luminosity of the Pioneer PRO-1110HD/PRO-910HD Plasma Display System will diminish very slowly, such as with all phosphor-based screens (for example, a traditional tube-type television). To enjoy beautiful and bright images on your Pioneer Plasma Display System for many years to come, please carefully read and follow the usage guidelines below.

Usage guidelines

All phosphor-based screens (including conventional tube-type televisions) can be affected by displaying static images for a prolonged period. Plasma Display Systems are no exception to this rule. After-image and permanent effects on the screen can be avoided by taking some basic precautions. By following the recommendations listed below, you can ensure longer and satisfactory results from your plasma:

- Whenever possible, avoid frequently displaying the same image or virtually still moving pictures (e.g. closed-captioned images or video game images which have static portions).
- Avoid viewing the On Screen Display for extended periods, from a DVD player, VCR, and all other components.
- Do not leave the same picture freeze-framed or paused continuously over a long period of time, when using the still picture mode from a TV, VCR, DVD player or any other component.
- Images which have both very bright areas and very dark areas side by side should not be displayed for a prolonged period of time.
- When playing a game, the "GAME" mode setting within "AV Selection" is strongly recommended. However, please limit its use to less than 2 hours at a time.
- After playing a game, or displaying a PC image or any still image, it is best to view a normal moving picture in the "WIDE" or "FULL" screen setting for over 3 times longer than the previous still/moving image.
- After using the Plasma Display System, always switch the display to "STANDBY" mode.

Installation guidelines

The Pioneer PureVision PRO-1110HD/PRO-910HD Plasma Display System incorporates a very thin design. To ensure safety, please take the proper measures to mount or install the Plasma Display, in order to prevent the unit from tipping over in the event of vibration or accidental movement.

This product should be installed by using only parts and accessories designed by PIONEER. Use of accessories other than the PIONEER stand or installation bracket may result in instability, and could cause injury. For custom installation, please consult the dealer where the unit was purchased. To ensure correct installation, experienced and qualified experts must install the unit. PIONEER will not be held responsible for accident or damage caused by the use of parts and accessories manufactured by other companies.

To avoid malfunction and overheating when installing, make sure that the vents on the main unit are not blocked. To ensure proper heat emission:

- Distance the unit slightly from other equipment, walls, etc. For the minimum space required around the unit, see pages 17 and 18.
- Do not fit the unit inside narrow spaces where ventilation is poor.
- Do not cover with a cloth, etc.
- Clean the vents on the sides and rear of the unit to remove dust build-up by using a vacuum cleaner set to its lowest suction setting.
- Do not place the product on a carpet or blanket.
- Do not leave the product tilted over except the case of vertical installation of the Media Receiver.
- Do not reverse the product.

Using the unit without proper ventilation may cause the internal temperature to rise, and could result in possible malfunction. When the surrounding or internal temperature exceeds a certain degree, the display will automatically power off in order to cool the internal electronics and prevent a hazardous occurrence.

Malfunction can be caused by many factors: inappropriate installation site, improper assembly/installation/mounting, improper operation of or modifications made to this product. However, PIONEER cannot be held responsible for accidents or malfunction caused by the above.

NOTE

Typical effects and characteristics of a phosphor-based matrix display such as permanent residual images upon the phosphors of the panel and the existence of a minute number of inactive light cells in the screen are not covered by local warranties.

CAUTION

Panel sticking and after-image lag

- Displaying the same images such as still images for a long time may cause after-image lagging. This may occur in the following two cases.

1. After-image lagging due to remaining electric load

When image patterns with very high peak luminance are displayed more than 1 minute, after-image lagging may occur due to the remaining electric load. The after-images remaining on the screen will disappear when moving images are displayed. The time for the after-images to disappear depends on the luminance of the still images and the time they had been displayed.

2. After-image (lag image) due to burning

Avoid displaying the same image on the Plasma Display continuously over a long period of time. If the same image is displayed continuously for several hours, or for shorter periods of time over several days, a permanent after-image may remain on the screen due to burning of the fluorescent materials. Such images may become less noticeable if moving images are later displayed, but they will not disappear completely.

- The Energy save function can be set to help prevent damage from screen burning (see page 55).

About operations through i.LINK

PIONEER shall not always assure normal video/audio recording or playback when a D-VHS is operated through i.LINK.

Electricity is used to perform many useful functions, but it can also cause personal injuries and property damage if improperly handled. This product has been engineered and manufactured with the highest priority on safety. However, improper use can result in electric shock and/or fire. In order to prevent potential danger, please observe the following instructions when installing, operating and cleaning the product. To ensure your safety and prolong the service life of your product, please read the following precautions carefully before using the product.

1. Read instructions—All operating instructions must be read and understood before the product is operated.
 2. Keep this manual in a safe place—These safety and operating instructions must be kept in a safe place for future reference.
 3. Observe warnings—All warnings on the product and in the instructions must be observed closely.
 4. Follow instructions—All operating instructions must be followed.
 5. Cleaning—Unplug the power cord from the AC outlet before cleaning the product. Use a damp cloth to clean the product. Do not use liquid cleaners or aerosol cleaners.
 6. Attachments—Do not use attachments not recommended by the manufacturer. Use of inadequate attachments can result in accidents.
 7. Water and moisture—Do not use the product near water, such as bathtub, washbasin, kitchen sink and laundry tub, swimming pool and in a wet basement.
 8. Stand—Do not place the product on an unstable cart, stand, tripod or table. Placing the product on an unstable base can cause the product to fall, resulting in serious personal injuries as well as damage to the product. Use only a cart, stand, tripod, bracket or table recommended by the manufacturer or sold with the product. When mounting the product on a wall, be sure to follow the manufacturer's instructions. Use only the mounting hardware recommended by the manufacturer.
 9. When relocating the product placed on a cart, it must be moved with utmost care. Sudden stops, excessive force and uneven floor surface can cause the product to fall from the cart.
-
10. Ventilation—The vents and other openings in the cabinet are designed for ventilation. Do not cover or block these vents and openings since insufficient ventilation can cause overheating and/or shorten the life of the product. Do not place the product on a bed, sofa, rug or other similar surface, since they can block ventilation openings. This product is not designed for built-in installation; do not place the product in an enclosed place such as a bookcase or rack, unless proper ventilation is provided or the manufacturer's instructions are followed.
 11. Power source—This product must operate on a power source specified on the specification label. If you are not sure of the type of power supply used in your home, consult your dealer or local power company.
 12. Power cord protection—The power cords must be routed properly to prevent people from stepping on them or objects from resting on them. Check the cords at the plugs and product.
 13. The plasma Display used in this product is made of glass. Therefore, it can break when the product is dropped or applied with impact. Be careful not to be injured by broken glass pieces in case the plasma Display breaks.
 14. Overloading—Do not overload AC outlets or extension cords. Overloading can cause fire or electric shock.
 15. Entering of objects and liquids—Never insert an object into the product through vents or openings. High voltage flows in the product, and inserting an object can cause electric shock and/or short internal parts. For the same reason, do not spill water or liquid on the product.
 16. Servicing—Do not attempt to service the product yourself. Removing covers can expose you to high voltage and other dangerous conditions. Request a qualified service person to perform servicing.
 17. Repair—If any of the following conditions occurs, unplug the power cord from the AC outlet, and request a qualified service person to perform repairs.
 - a. When the power cord or plug is damaged.
 - b. When a liquid was spilled on the product or when objects have fallen into the product.
 - c. When the product has been exposed to rain or water.
 - d. When the product does not operate properly as described in the operating instructions. Do not touch the controls other than those described in the operating instructions. Improper adjustment of controls not described in the instructions can cause damage, which often requires extensive adjustment work by a qualified technician.
 - e. When the product has been dropped or damaged.
 - f. When the product displays an abnormal condition. Any noticeable abnormality in the product indicates that the product needs servicing.
 18. Replacement parts—In case the product needs replacement parts, make sure that the service person uses replacement parts specified by the manufacturer, or those with the same characteristics and performance as the original parts. Use of unauthorized parts can result in fire, electric shock and/or other danger.
 19. Safety checks—Upon completion of service or repair work, request the service technician to perform safety checks to ensure that the product is in proper operating condition.
 20. Wall or ceiling mounting—When mounting the product on a wall or ceiling, be sure to install the product according to the method recommended by the manufacturer.
 21. Heat sources—Keep the product away from heat sources such as radiators, heaters, stoves and other heat-generating products (including amplifiers).
 22. Unplug the power cord from the AC outlet before installing the speakers.
 23. Never expose the screen of the Plasma Display to a strong impact, for example, by hitting it. The screen may be broken, resulting in fire or personal injury.
 24. Do not expose the Plasma Display to direct sunlight for a long period of time. The optical characteristics of the front protection panel changes, resulting in discoloration or warp.
 25. The Plasma Display weighs about 38 kg (83.8 lbs.) for the PRO-504PU and about 30.5 kg (67.3 lbs.) for the PRO-434PU. Because it has small depth and is unstable, unpack, carry, and install the product with one more person at least and use the handles.

Safety Precautions

02

Installation Precautions

Observe the following precautions when installing with any items such as the optional stand.

When using the optional stand, brackets, or equivalent items

- Ask your dealer to perform the installation.
- Be sure to use the supplied bolts.
- For details, see the instruction manual that comes with the optional stand (or equivalent items).

When using other items

- Consult your dealer.
- The following six mounting holes can be used for the installation:

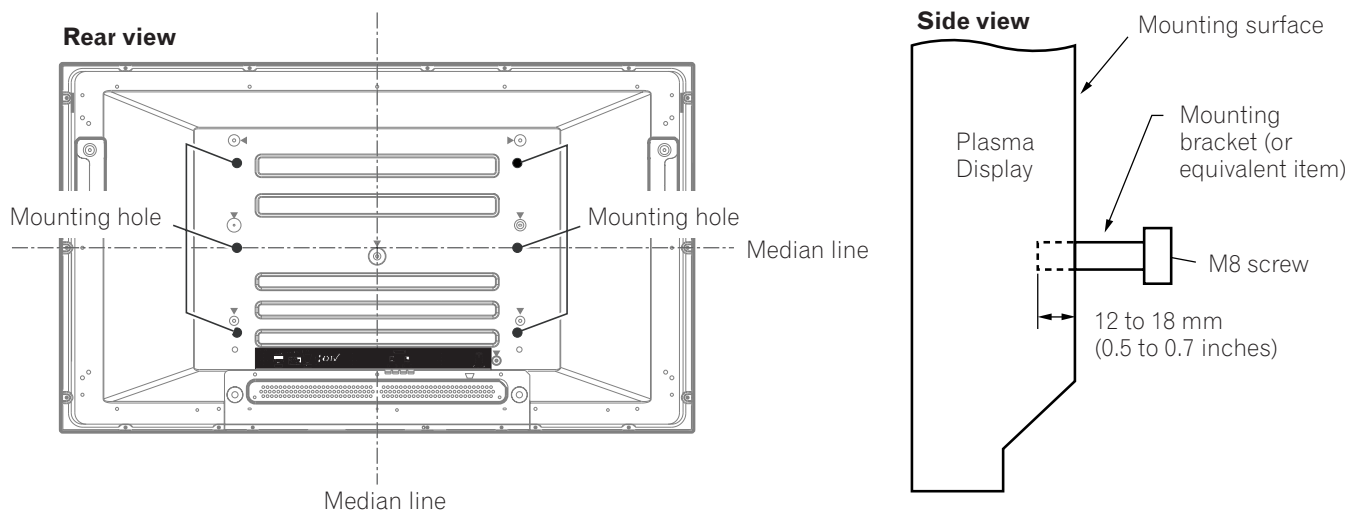

⚠ CAUTION

- Be sure to use four or more mounting holes symmetrical to the vertical and horizontal median lines.
- Use M8 screws, which go 12 to 18 mm (0.5 to 0.7 inches) in depth from the mounting surface of the Plasma Display. See the side view above.
- Be careful not to block the ventilation opening at the rear of the Plasma Display.
- Be sure to install the Plasma Display on a flat surface because it contains glass.
- The screw holes other than the above are to be used only for the specified products. Never use them for mounting non-specified products.
- Do not mount or remove the Plasma Display to or from the stand, with speakers attached.

📝 NOTE

- It is strongly recommended to use the optional PIONEER mounting products.
- PIONEER shall not be liable for any personal injury or product damage that results from the use of mounting items other than the optional PIONEER products.

CAUTION

PIONEER bears no responsibility for any damages arising from incorrect use of the product by you or other people, malfunctions when in use, other product related problems, and use of the product except in cases where the company must be liable.

Plasma Display protection function

When still images (such as photos and computer images) stay on the screen for an extended period of time, the screen will be slightly dimmed. This is because the protection function of the Plasma Display automatically adjusts the brightness to protect the screen when detecting still images; so this does not designate malfunction. The screen is dimmed when a still image is detected for about three minutes.

Infrared rays

The Plasma Display releases infrared rays because of its characteristics. Depending on how the Plasma Display is in use, the remote controls of nearby equipment may be adversely affected or wireless headphones using infrared rays are interfered by noise. If this is the case, place that equipment at a location where its remote control sensor is not affected.

Radio interference

While this product meets the required specifications, it emits a small amount of noise. If you place such equipment as an AM radio, personal computer, and VCR close to this product, that equipment may be interfered. If this happens, place that equipment far enough from this product.

Fan motor noise

When ambient temperature of the Media Receiver becomes high, the rotation speed of the cooling fan motor increases. This may make you feel that the fan motor is noisy at such an occasion.

Do not attach such items as labels and tape to the product.

- This may result in the discoloration or scratch of the cabinet.

When not using the product for a long period of time

- If you do not use the product for a long period of time, the functions of the product may be adversely affected. Switch on and run the product occasionally.

Condensation

- Condensation may take place on the surface or inside of the product when the product is rapidly moved from a cold place to a warm place or just after a heater is switched on in winter morning, for example. When condensation takes place, do not switch on the product and wait until condensation disappears. Using the product with condensation may result in malfunction.

Cleaning the screen

- When cleaning the screen of this product, gently wipe it with a dry soft cloth; the supplied cleaning cloth or other similar cloths (e.g., cotton and flannel). If you use a hard cloth or rub the screen hard, the surface of the screen will be scratched.
- If you clean the surface of the screen with a wet cloth, water droplets on the surface may enter into the product, resulting in malfunction.

Cleaning the cabinet

- The cabinet of this product is mostly composed of plastic. Do not use chemicals such as benzine or thinner to clean the cabinet. Using these chemicals may result in quality deterioration or coating removal.
- Do not expose the product to volatile gas or fluid such as pesticide. Do not make the product contact with rubber or vinyl products for a long period of time. The effect of plasticizer in the plastic may result in quality deterioration or coating removal.
- If you clean the surface of the cabinet with a wet cloth, water droplets on the surface may enter into the product, resulting in malfunction.

Handles at the rear of the Plasma Display

- Do not remove the handles from the rear of the Plasma Display.
- When moving the Plasma Display, ask another person for help and use the handles attached to the rear of the Plasma Display. Do not move the Plasma Display by holding only a single handle. Use the handles as shown.
- Do not use the handles to hang the product when installing or carrying the product, for example. Do not use the handles for the purpose of preventing the product from tilting over.

- **Built-in Digital Television (DTV) Tuner**
- **EPG for DTV programs**
- **New WIDE XGA Plasma Panel**
 - **PRO-1110HD: 1280 x 768 (H x V) pixels**
 - **PRO-910HD: 1024 x 768 (H x V) pixels**
- **PureCinema**
- **TruBass, FOCUS, and SRS sound systems**
- **Dual TV Tuner**
- **Multi-screen display (2-screen/picture-in-picture)**
- **Still image function**
- **4-Language On Screen Display**
- **4-Video Input and PC (XGA) Input**
- **3-Component Video Input**
- **2-i.LINK interface**
- **Parental Control System (V-CHIP)**
- **Power-Saving Design**

Plasma Display

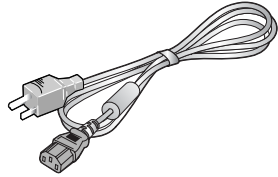

Power cord (2 m/6.6 feet)

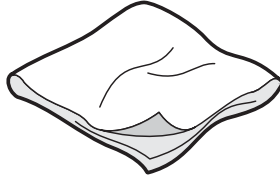

Cleaning cloth

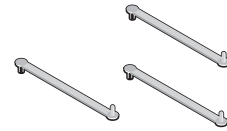

Speed clamp x 3

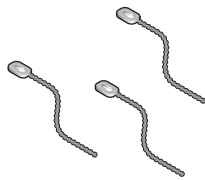

Bead band x 3

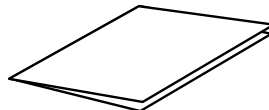

Warranty card

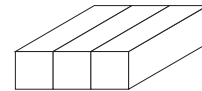
Speaker cushion x 3
(Use when installing the optional speakers at the bottom of the Plasma Display.)

Media Receiver

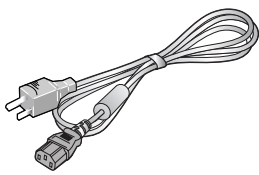

Power cord (2 m/6.6 feet)

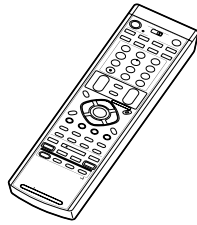

Remote control unit

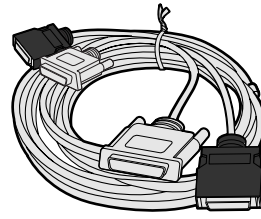

System cable (3 m/9.8 feet)

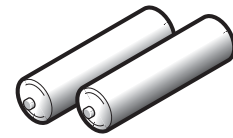
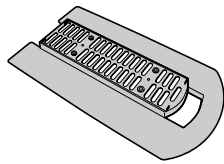
AA size battery x 2
(Alkaline battery)

Stand

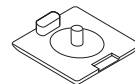
Screw x 4
(for stand)

Screw hole cap x 4

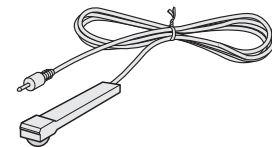
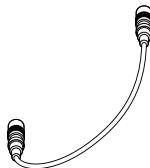
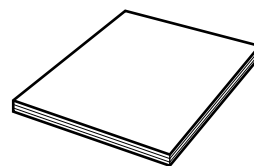
VCR controller x 1
(1.8 m/5.9 feet)Coaxial cable (0.15 m/0.49 feet) x 1
(Already set at the rear of the Media Receiver)

Operating instruction

NOTE

- Always use the power cord supplied with the Plasma Display and the one supplied with the Media Receiver for each respective unit.

Plasma Display
Front view

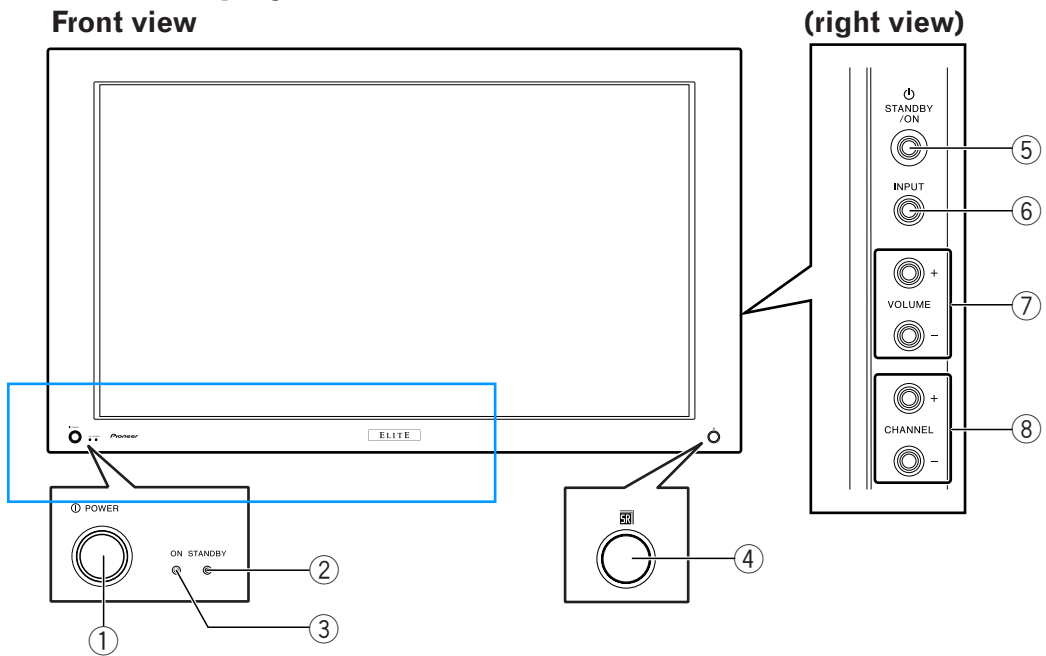

- ① **POWER** button
- ② **STANDBY** indicator
- ③ **POWER ON** indicator
- ④ Remote control sensor
- ⑤ **STANDBY/ON** button
- ⑥ **INPUT** button
- ⑦ **VOLUME +/-** buttons
- ⑧ **CHANNEL +/-** buttons

Rear view

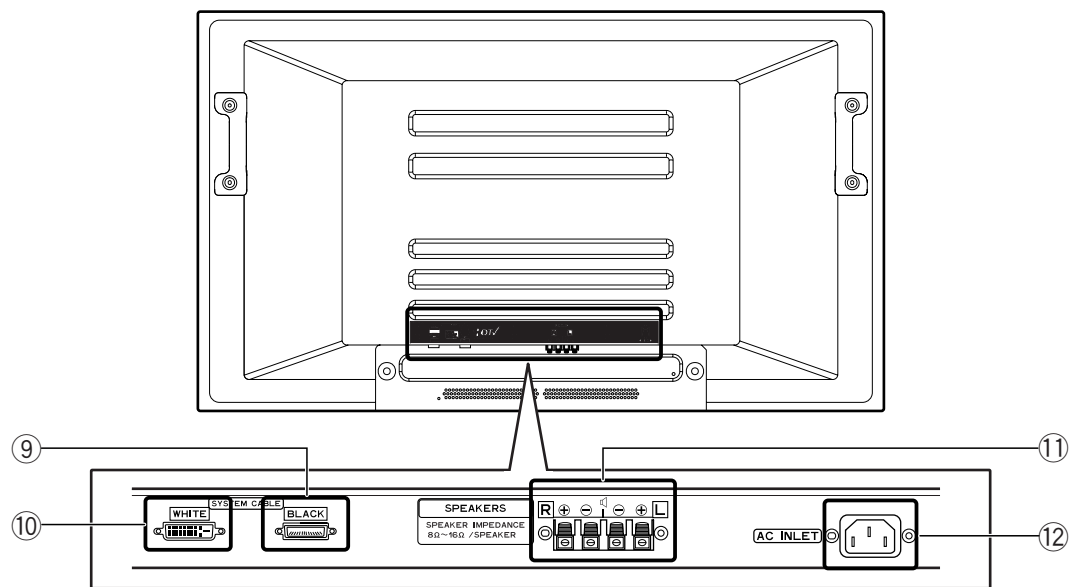

The terminals have faced downward.

- ⑨ **SYSTEM CABLE** terminal (BLACK)
- ⑩ **SYSTEM CABLE** terminal (WHITE)
- ⑪ **SPEAKER** (right/left) terminals
- ⑫ **AC INLET** terminal

Media Receiver

Front view

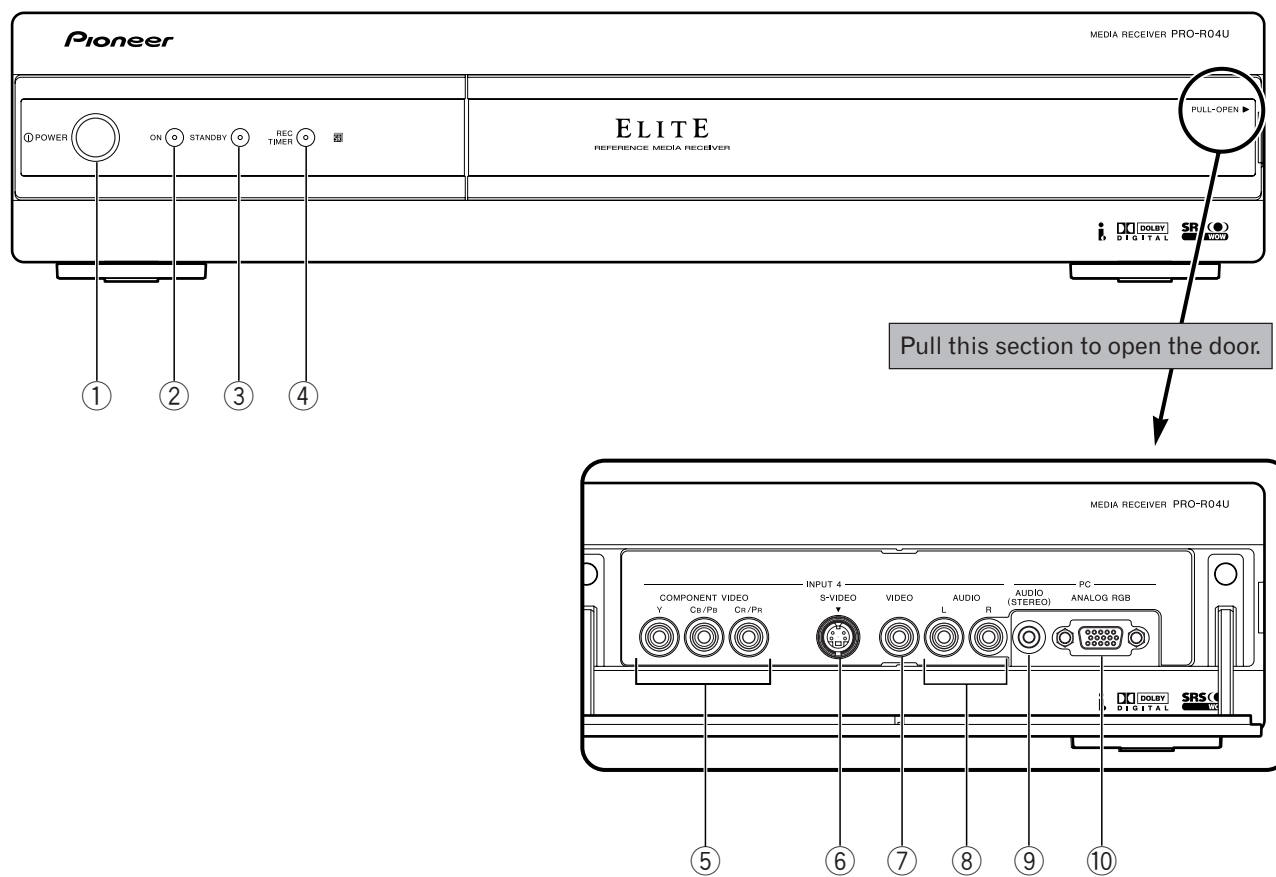

- ① **POWER** button
- ② POWER ON indicator
- ③ STANDBY indicator
- ④ REC TIMER indicator
- ⑤ INPUT 4 COMPONENT VIDEO terminals (Y, CB/PB, CR/PR)
- ⑥ INPUT 4 terminal (S-VIDEO)
- ⑦ INPUT 4 terminal (VIDEO)
- ⑧ INPUT 4 terminals (AUDIO)
- ⑨ PC INPUT terminal (AUDIO)
- ⑩ PC INPUT terminal (ANALOG RGB)

Rear view

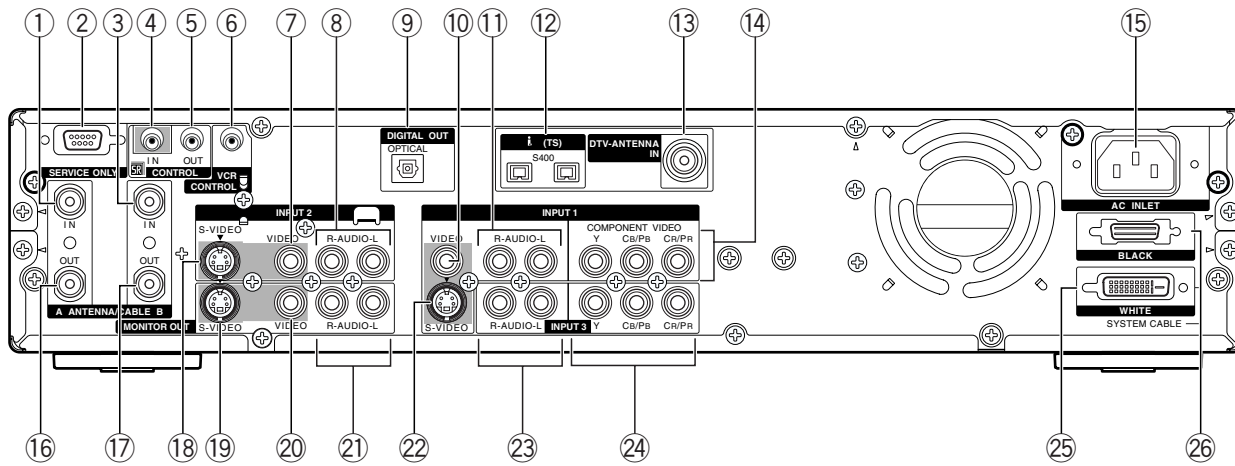

- | | |
|--|---|
| ① Antenna A input terminal | ⑭ INPUT 1 COMPONENT VIDEO terminals (Y, CB/PB, CR/PR) |
| ② RS-232C terminal (used in the factory setup) | ⑮ AC INLET terminal |
| ③ Antenna B input terminal | ⑯ Antenna A output terminal |
| ④ Control input terminal | ⑰ Antenna B output terminal |
| ⑤ Control output terminal | ⑱ INPUT 2 terminal (S-VIDEO) |
| ⑥ VCR control terminal | ⑲ MONITOR OUT terminal (S-VIDEO) |
| ⑦ INPUT 2 terminal (VIDEO) | ⑳ MONITOR OUT terminal (VIDEO) |
| ⑧ INPUT 2 terminals (AUDIO) | ㉑ MONITOR OUT terminals (AUDIO) |
| ⑨ DIGITAL AUDIO output terminal (OPTICAL) | ㉒ INPUT 1 terminal (S-VIDEO) |
| ⑩ INPUT 1 terminal (VIDEO) | ㉓ INPUT 3 terminals (AUDIO) |
| ⑪ INPUT 1 terminals (AUDIO) | ㉔ INPUT 3 COMPONENT VIDEO terminals (Y, CB/PB, CR/PR) |
| ⑫ i.LINK terminals | ㉕ SYSTEM CABLE terminal (WHITE) |
| ⑬ DTV Antenna input terminal | ㉖ SYSTEM CABLE terminal (BLACK) |

Remote control unit

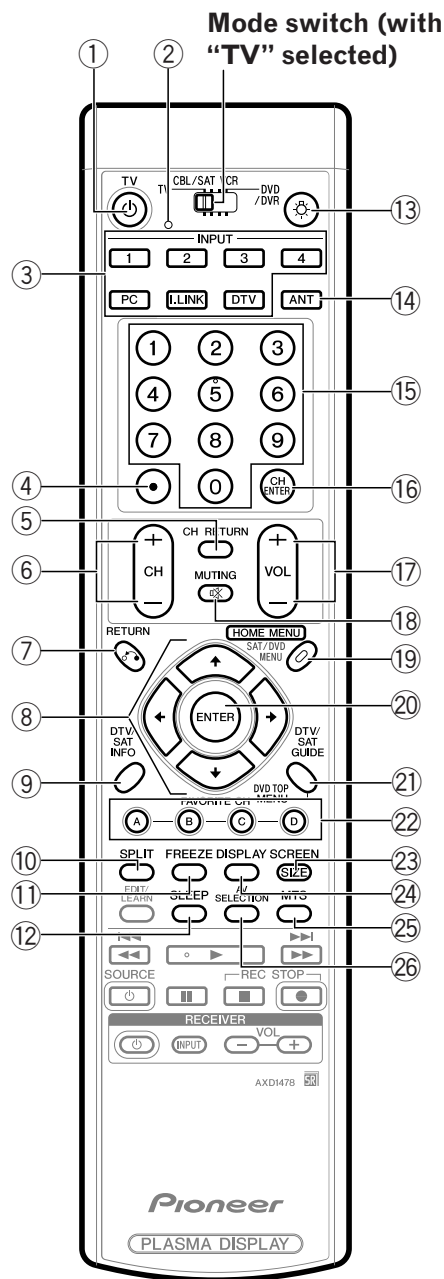

With the mode switch set to TV

- ① **TV** : Turns on the power to the Plasma Display or places it into standby mode.
- ② Transmission confirmation LED
- ③ **INPUT**: Selects an input source of the Plasma Display. (DTV, i.LINK, INPUT 1, INPUT 2, INPUT 3, INPUT 4, PC)
- ④ **• (dot)**: Enters a dot.
- ⑤ **CH RETURN**: Returns to the previous channel.

- ⑥ **CH +/-**: Selects the channel.
- ⑦ **RETURN**: Returns to the previous menu screen.
- ⑧ **▲/▼/◀/▶**: Selects a desired item on the menu screen.
- ⑨ **DTV INFO**: Shows more information on DTV programs.
- ⑩ **SPLIT**: Switches the screen mode among 2-screen, picture-in-picture, and single-screen.
- ⑪ **FREEZE**: Freezes a frame from a moving image. Press again to cancel the function.
- ⑫ **SLEEP**: Sets the sleep timer.
- ⑬ : When pressed, all buttons on the remote control unit will light. The lighting will turn off if no operations are performed within about 5 seconds. This button is used for performing operations in dark places.
- ⑭ **ANT**: Selects the antenna (A, B). See pages 24 to 26 for details.
- ⑮ **0 - 9**: Sets the channel.
- ⑯ **CH ENTER**: Executes a channel number.
- ⑰ **VOL +/-**: Sets the volume.
- ⑱ **MUTING**: Mutes the sound.
- ⑲ **HOME MENU**: Displays the menu screen.
- ⑳ **ENTER**: Executes a command.
- ㉑ **DTV GUIDE**: Displays the DTV Electronic Program Guide (EPG).
- ㉒ **FAVORITE CH (A, B, C, D)**: Selects any of the four preset channels. See page 43 for details to set the FAVORITE CH. While watching, you can toggle the set channels by pressing **A**, **B**, **C** and **D**.
- ㉓ **SCREEN SIZE**: Selects the screen size.
- ㉔ **DISPLAY**: Displays the channel information.
- ㉕ **MTS**: Selects the MTS/SAP.
- ㉖ **AV SELECTION**: Selects audio and video settings. (AV mode: STANDARD, DYNAMIC, MOVIE, GAME, USER. PC mode: STANDARD, USER.)

NOTE

- When using the remote control unit, point it at the Plasma Display.
- See pages 97 to 105 for operating buttons not listed on this page.

Allowed operation range of the remote control unit

Operate the remote control unit while pointing it toward the remote control sensor (SR) located at the bottom right of the front panel of the Plasma Display. The distance from the remote control sensor must be within 7 m (276 inches) and the angle relative to the sensor must be within 30 degrees in the right, left, upward, or downward direction.

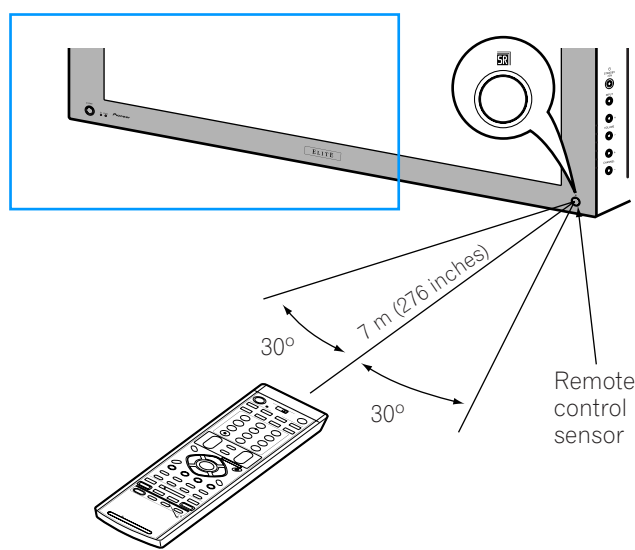

When the remote control unit does not function properly

- When any obstacle exists between the remote control unit and the remote control sensor, the remote control unit may not function.
- As the batteries become empty, the remote control unit can function within a shorter distance from the remote control sensor. Replace the batteries with new ones early enough.
- The Plasma Display emits very weak infrared rays from its screen. If you place such equipment operated through infrared remote control as a VCR nearby, that equipment may not receive commands from its remote control unit properly or entirely. If this is the case, place that equipment at a location far enough from the Plasma Display.
- Depending on the installation environment, infrared rays from the Plasma Display may not allow this system to properly receive commands from the remote control unit or may shorten allowable distances between the remote control unit and the remote control sensor. The strength of infrared rays emitted from the screen differs, depending on images displayed on the screen.

Installing the Plasma Display

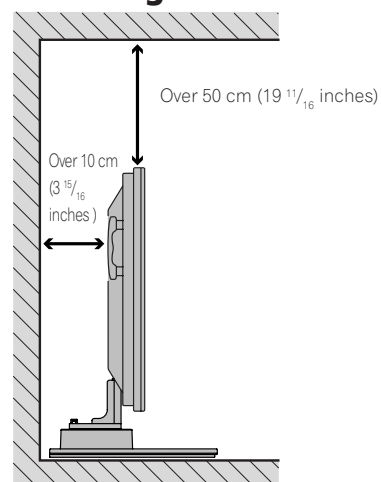

Locating

- Avoid direct sunlight. Maintain adequate ventilation.
- The length of the system cable used to connect the Plasma Display and the Media Receiver is about 3 m (118 inches).
- Because the Plasma Display is heavy, be sure to have someone help you when moving it.

CAUTION

- If you place anything on the top of the Media Receiver it will not receive enough ventilation and will not operate properly.

NOTE

- Allow enough space around the upper and back parts when installing to ensure ventilation around the backside.

Using the optional PIONEER stand

- For details on installation, refer to the instruction manual provided with the stand.

CAUTION

- This product may be used only with model PDK-TS04 stand, use with other stands may result in instability causing possible injury.

Using the optional PIONEER speakers

- For details on installation, refer to the instruction manual provided with the speaker.

CAUTION

Operating Environment

Operating environment temperature and humidity; +0°C to +40°C (+32°F to +104°F); less than 85% RH (cooling vents not blocked)

Avoid installing at the following locations:

- Under direct exposure to sunlight
- Under strong artificial light
- In high humidity
- Poorly ventilated

Installing the Media receiver

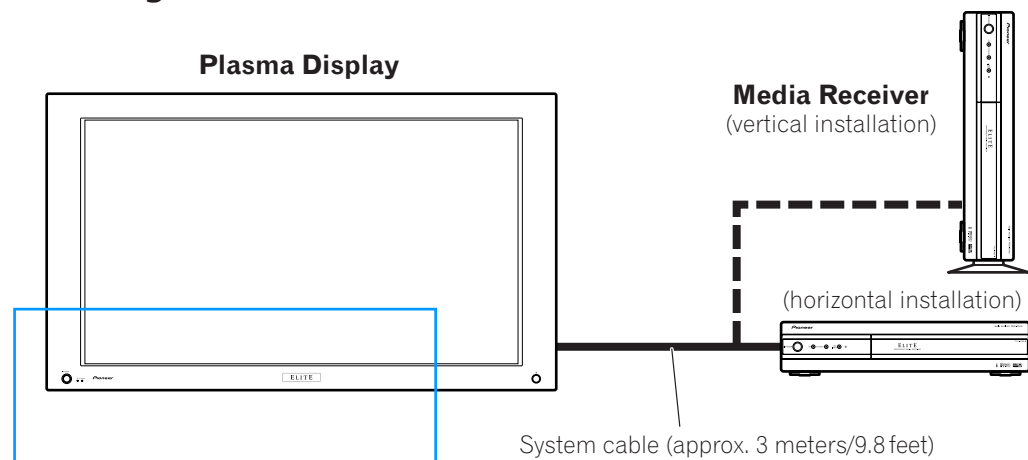

CAUTION

- Do not place a VCR or any other device on top of the Media Receiver.
- When installing, allow enough space on the sides and above the Media Receiver.
- Do not block the side cooling vents or the rear ventilation fan opening of the Media Receiver.

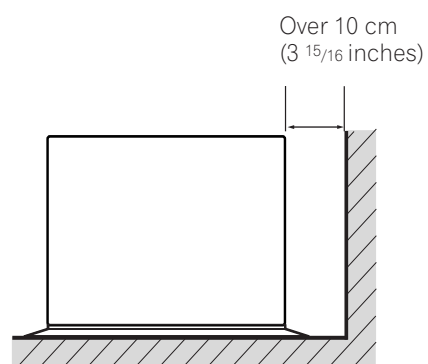
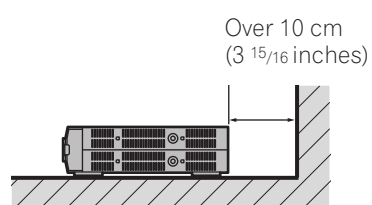
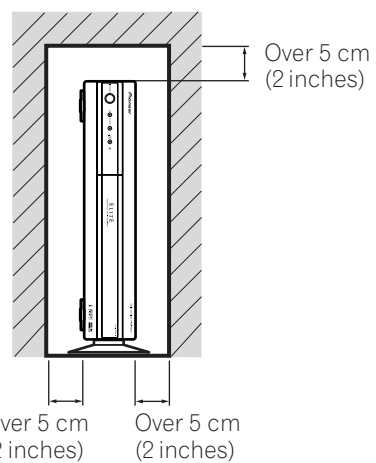
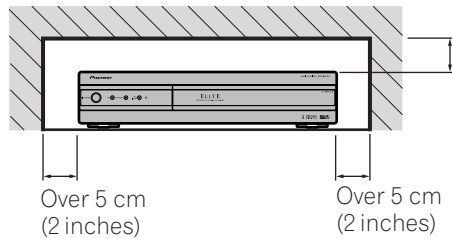

Preparation

07

Installing the Media Receiver vertically

You can use the accompanying stand to install the Media Receiver vertically.

Installing the Media Receiver vertically

Insert the vertical installation stand into the side of the Media Receiver.

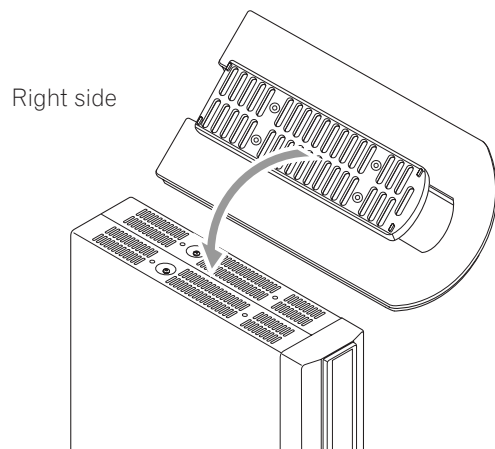

You can remove the shock absorbing pads.

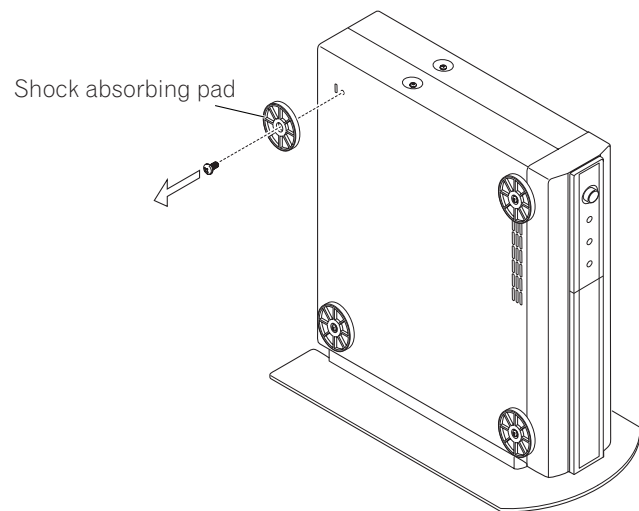

Keep the shock absorbing pads and screws. They are required when you place the Media Receiver in the horizontal position.

Secure the vertical installation stand with screws.

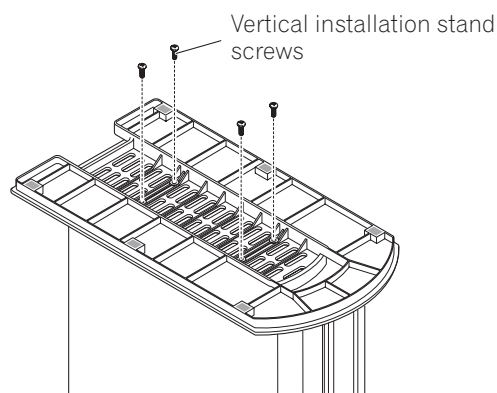

Plug the screw holes using the caps provided.

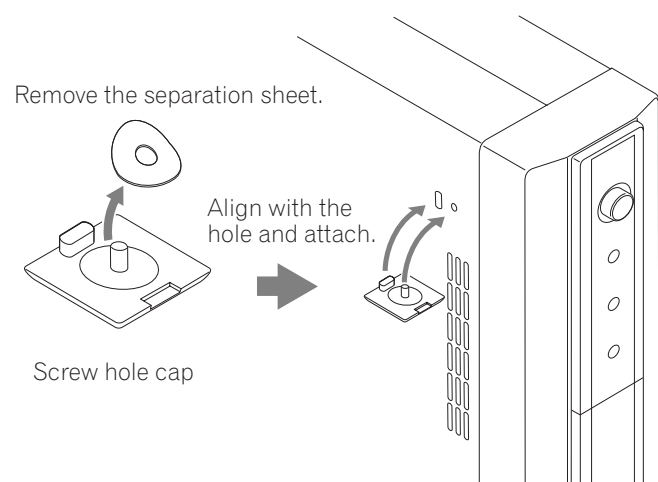

CAUTION

- When you have installed the Media Receiver vertically, always use the accompanying stand. If you place the unit directly on the floor the cooling vents will be blocked which will result in mechanical failure.

Setting the system

Connecting the system cable to the Plasma Display

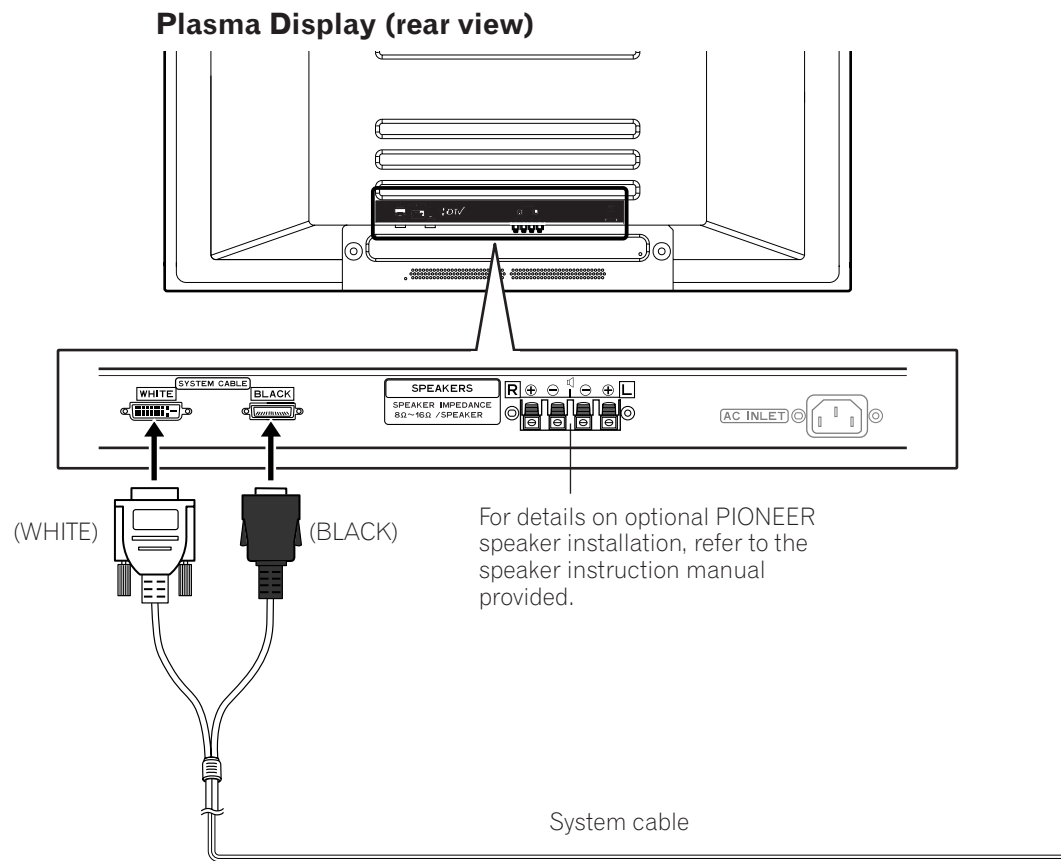

Connecting the system cable to the Media Receiver

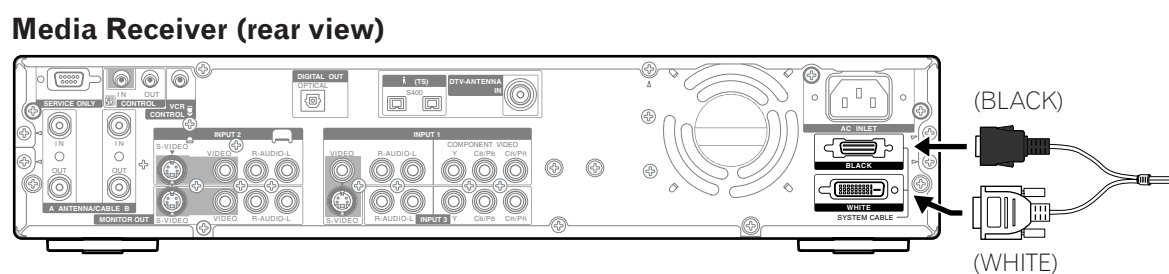

CAUTION

- THESE SPEAKER TERMINALS CAN BE UNDER HAZARDOUS VOLTAGE WHEN YOU CONNECT OR DISCONNECT THE SPEAKER CABLES. TO PREVENT THE RISK OF ELECTRIC SHOCK, DO NOT TOUCH UNINSULATED PARTS BEFORE DISCONNECTING THE POWER CORD.

Routing cables

Speed clamps and bead bands are included with this system for bunching cables. Once properly bunched, follow the steps below to route the cables.

When the speakers are installed on the sides

(rear view)

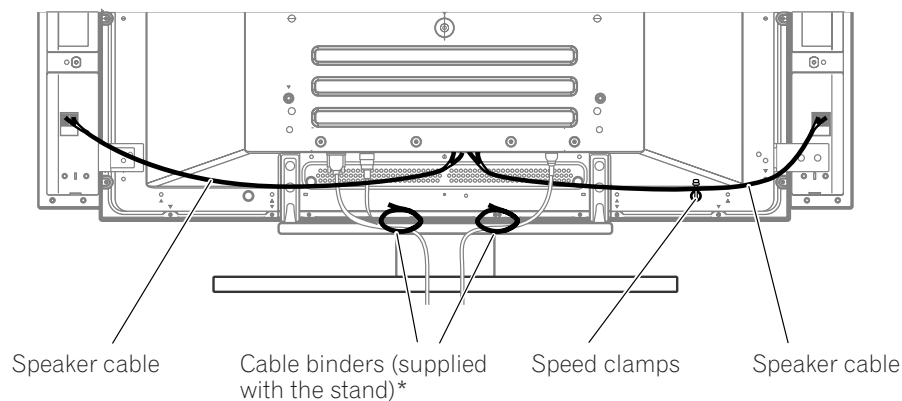

Attaching speed clamps to the main unit

Attach the speed clamps using the 4 holes marked with ↑ below, depending on your routing system.

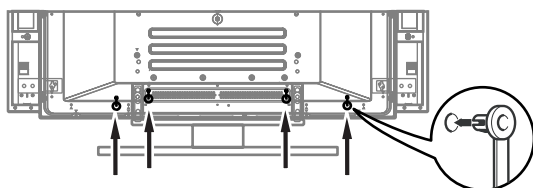

Attaching and removing speed clamps

Insert ① into an appropriate hole on the rear of the Plasma Display and snap ② into the back of ① to lock the clamp.

Speed clamps are designed to be difficult to undo once in place. Please attach them carefully.

Use pliers to twist the clamp 90°, pulling outward. The clamp may deteriorate over time and become damaged if removed.

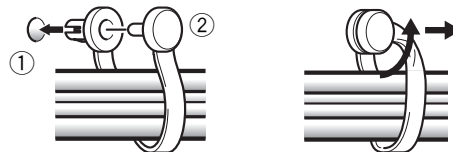

When the speakers are installed at the bottom

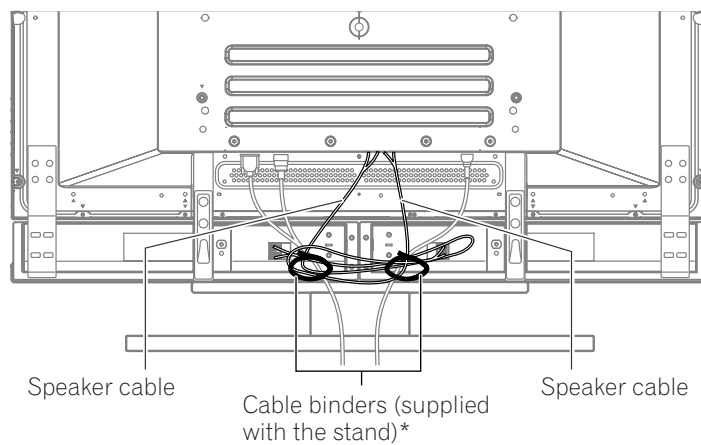

* Cable binder
Using the cable binders supplied with the stand, put the speaker and system cables together so that the cables are invisible from the front. At that time be careful not to apply any force to the connection sections of the cables.



07

Preparation

Using the remote control unit

Use the remote control unit by pointing it towards the remote sensor window. Objects between the remote control unit and sensor window may prevent proper operation.

Cautions regarding the remote control unit

- Do not expose the remote control unit to shock. In addition, do not expose the remote control unit to liquids, and do not place in an area with high humidity.
- Do not install or place the remote control unit under direct sunlight. The heat may cause deformation of the unit.
- The remote control unit may not work properly if the remote sensor window of the Plasma Display is under direct sunlight or strong lighting. In such case, change the angle of the lighting or Plasma Display set, or operate the remote control unit closer to the remote sensor window.

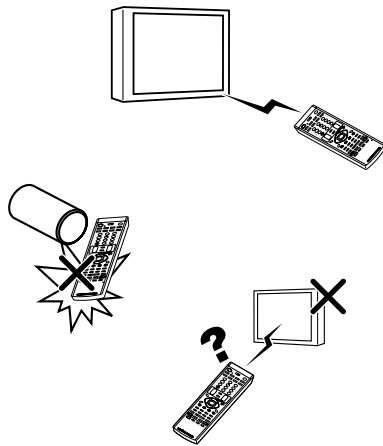

Inserting batteries

If the remote control unit fails to operate Plasma Display System functions, replace the batteries in the remote control unit.

- 1 Open the battery cover.

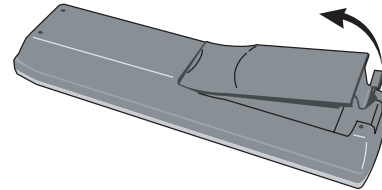

- 2 Insert the two AA size batteries supplied with the product.

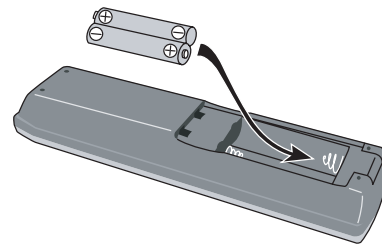

- Place batteries with their terminals corresponding to the (+) and (-) indicators in the battery compartment.

- 3 Close the battery cover.

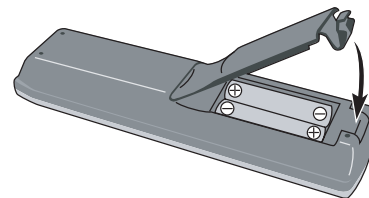

Cautions regarding batteries

Improper use of batteries can result in chemical leakage or explosion. Be sure to follow the instructions below.

- Do not use manganese batteries. When you replace the batteries, use alkaline ones.
- Place the batteries with their terminals corresponding to the (+) and (-) indicators.
- Do not mix batteries of different types. Different types of batteries have different characteristics.
- Do not mix old and new batteries. Mixing old and new batteries can shorten the life of new batteries or cause chemical leakage in old batteries.
- Remove batteries as soon as they have worn out. Chemicals that leak from batteries can cause a rash. If you find any chemical leakage, wipe thoroughly with a cloth.
- The batteries supplied with this product may have a shorter life expectancy due to storage conditions.
- If you will not use the remote control unit for an extended period of time, remove the batteries from it.

⚠ CAUTION

- **WHEN DISPOSING OF USED BATTERIES, BE SURE TO COMPLY WITH GOVERNMENT REGULATIONS AND ENVIRONMENTAL PROTECTION GUIDELINES THAT APPLY IN YOUR COUNTRY OR AREA.**

Cable connections for watching conventional TV channels

In order to watch conventional TV channels, connect coaxial cables as shown below. To enjoy a clearer picture, use an outdoor antenna. If your outdoor antenna uses a 75-ohm coaxial cable with an F-type connector, plug it into the antenna terminal at the rear of the Media Receiver.

Connecting a VHF/UHF antenna

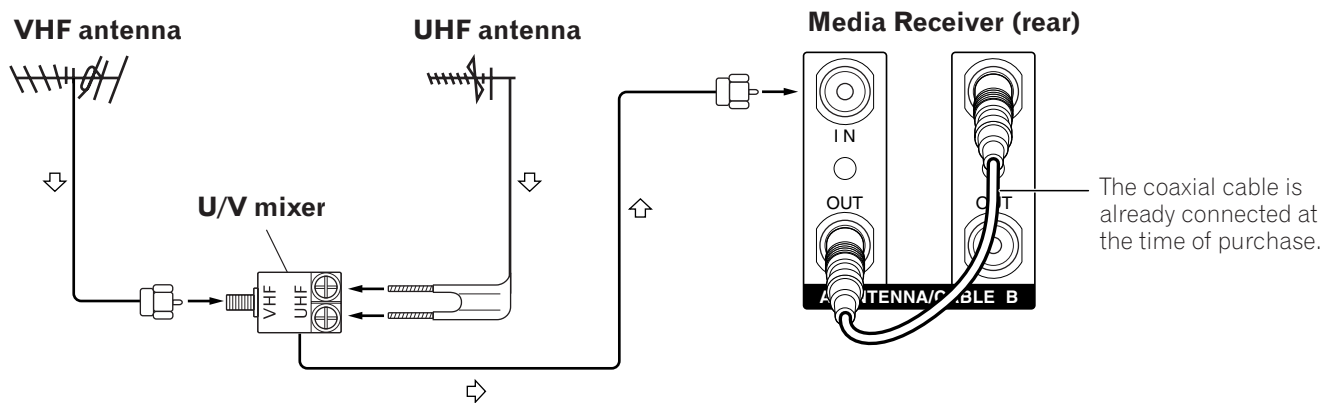

Connecting a Cable Converter

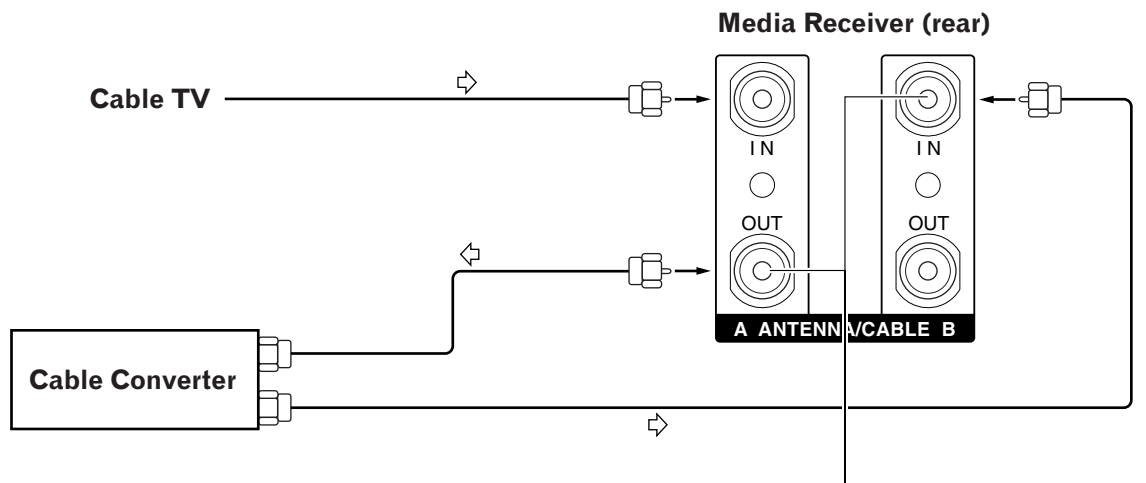

When making the above connections, first remove the coaxial cable attached before shipment.

Connecting a VHF/UHF antenna and Cable Converter

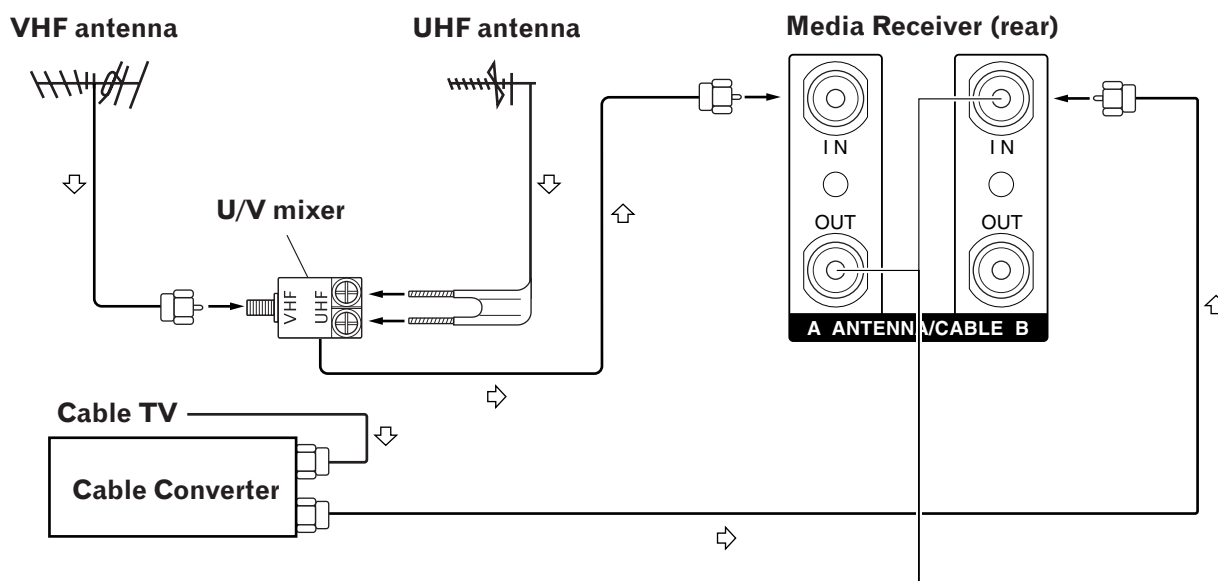

When making the above connections, first remove the coaxial cable attached before shipment.

NOTE

- **Be sure to connect the antenna or the Cable Converter as shown above. Signal reception may fail if not properly connected.**
- Be sure that the Cable Converter output signal is assigned to the ANTENNA/CABLE B input on the Media Receiver.
- How to change channels when the Cable Converter output signal is connected to the ANTENNA/CABLE B input on the Media Receiver.
 - Press **ANT** on the remote control unit to switch to ANTENNA/CABLE B.
 - You can view an image right after selecting the output channel on the Cable Converter.

Switching between antenna A and B

To watch broadcasts via the two antennas, you can select it by pressing **ANT** on the remote control unit.

- While watching a broadcast, press **ANT** to view the image received from the other antenna.
- Pressing **ANT** while viewing in Dual Screen mode (TV image and video image) with TV selected will display the TV image of the other antenna.
- Pressing **ANT** while viewing Dual Screen with two TV images displayed will not have any effect.
- Pressing **ANT** while viewing Dual Screen with two video images displayed will switch the selected screen to a TV image.

Cable connections for watching digital TV channels

In order to watch digital TV channels, connect coaxial cables as shown below. To enjoy a clearer picture, use an outdoor antenna. If your outdoor uses a 75-ohm coaxial cable with an F-type connector, plug it into the antenna terminal at the rear of the Media Receiver.

Connecting a VHF/UHF antenna

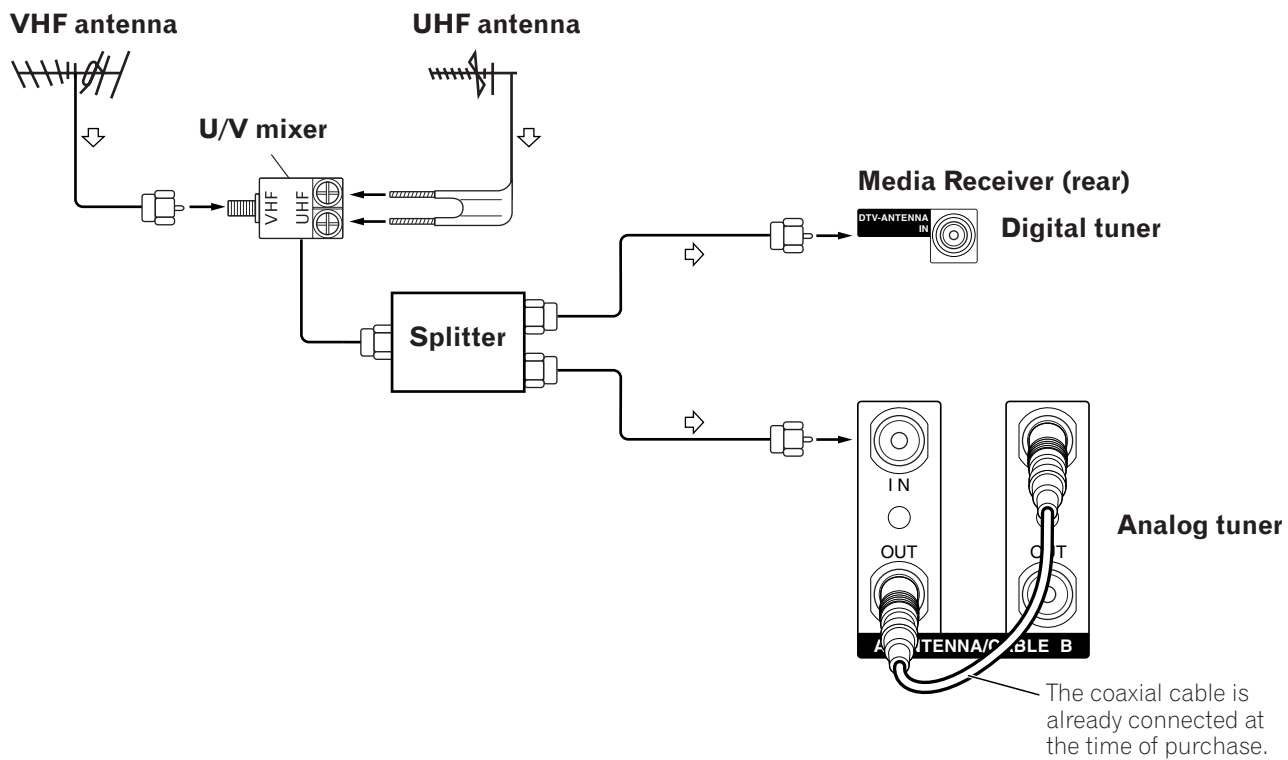

Connecting for cable TV

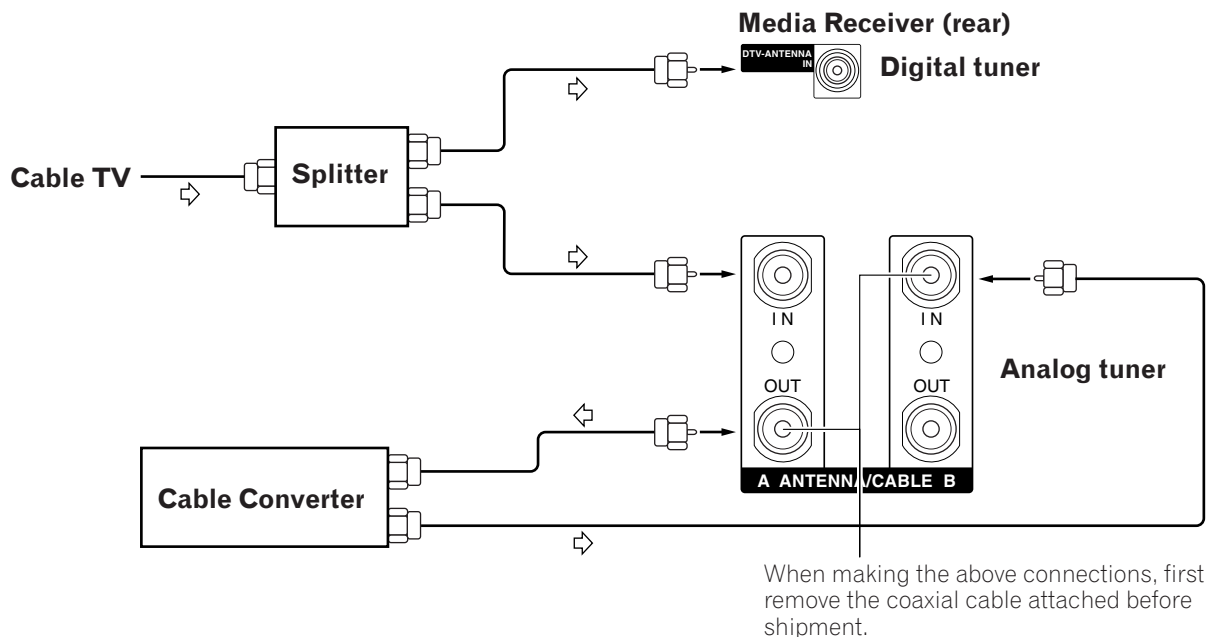

NOTE

- Be sure to connect coaxial cables as shown above. Signal reception may fail if not properly connected.

Connecting the power cord

Connect the power cord after all component connections have been completed.

Plasma Display (rear view)

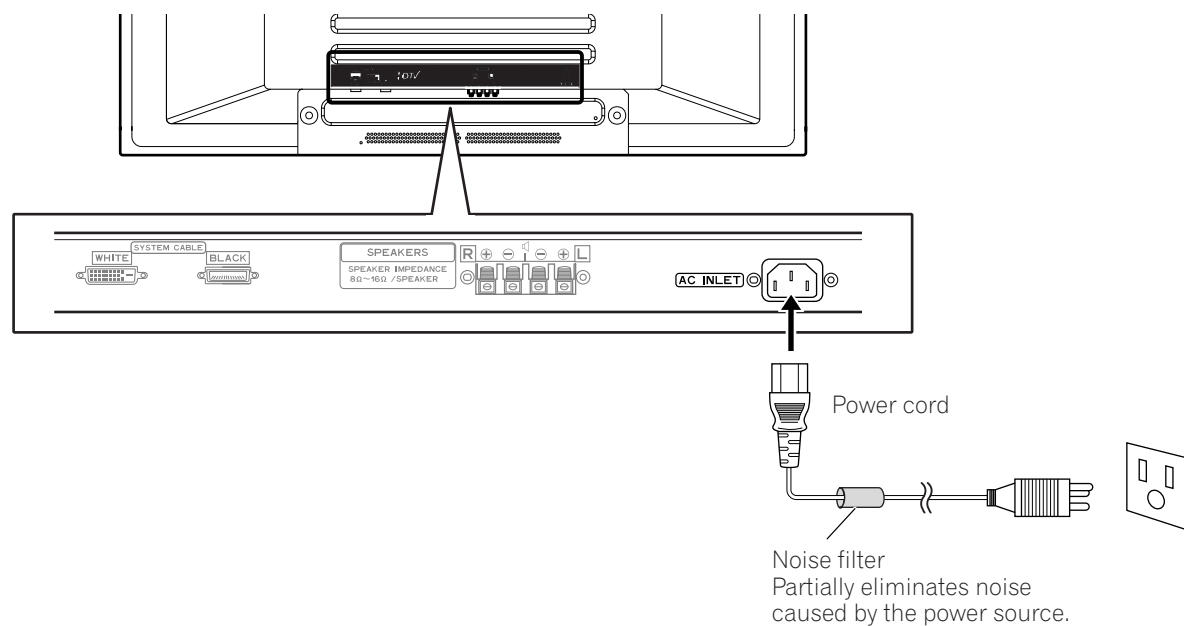

Media Receiver (rear view)

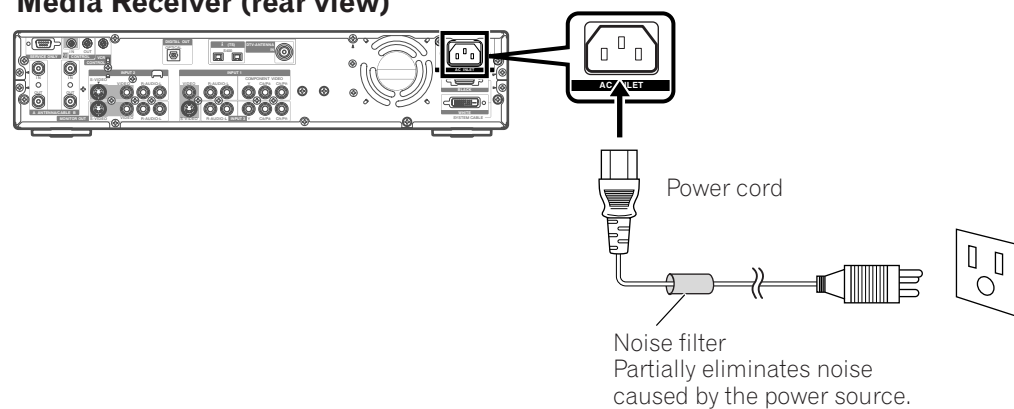

CAUTION

- Use only the power cord provided.
- Do not use a power supply voltage other than that indicated as this may cause fire or electric shock.
- For the Plasma Display System, a three-core power cord with a ground terminal is used for efficiency protection. Always connect the power cord to a three-pronged outlet and make sure that the cord is properly grounded. If you use a power source converter plug, use an outlet with a ground terminal and screw down the ground line.

NOTE

- Always turn off the power of the Plasma Display and Media Receiver when connecting the power cords.
- Disconnect the power cord from the power outlet when the Plasma Display System is not going to be used for a long period of time.

Plasma Display

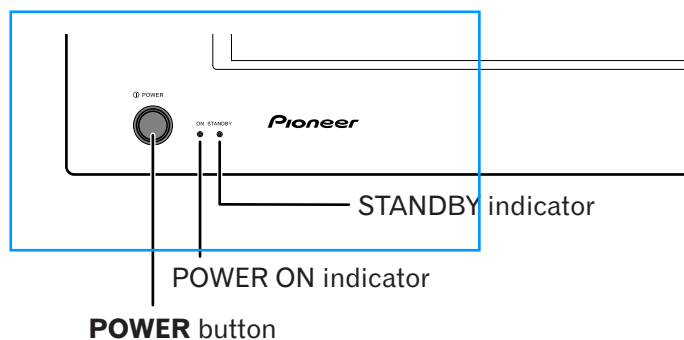

Turning on the power

- 1 Press **POWER** on the Plasma Display.
 - The **STANDBY** indicator on the Plasma Display flashes red.
- 2 Press **POWER** on the Media Receiver.
 - The system is turned on or placed into the standby mode.
- 3 Confirm that the **STANDBY** indicators light up red, and then press **TV**  on the remote control unit or **STANDBY/ON** on the Plasma Display to turn the system on.
 - The **POWER ON** indicators on the Plasma Display and Media Receiver light up green.

(right view)

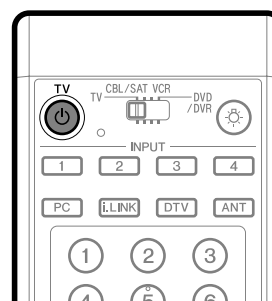
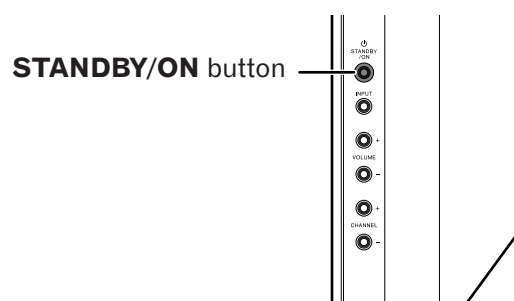
 **NOTE**

- In this manual, "system" means the Plasma Display Panel and Media Receiver.
- You can also reverse steps 1 and 2.

Media Receiver

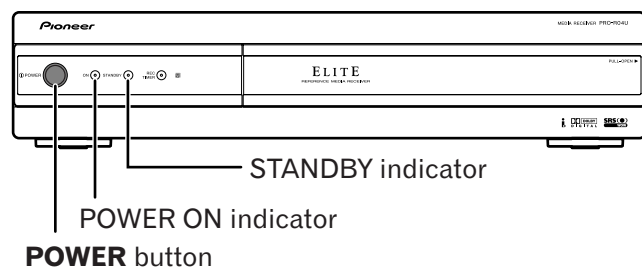

Turning off the power

- 1 Press **TV**  on the remote control unit or **STANDBY/ON** on the Plasma Display.
 - The system enters the standby mode and the image on the screen disappears.
 - Both STANDBY indicators light up red.

• It is recommended to place the system into the standby mode by pressing **TV**  on the remote control unit. This allows the system to automatically receive Electronic Program Guide information signals in the standby mode.

- 2 Press **POWER** on the Media Receiver.
 - The STANDBY indicator on the Media Receiver turns off and the one on the Plasma Display flashes red.
- 3 Press **POWER** on the Plasma Display.
 - The STANDBY indicator on the Plasma Display turns off.

 **NOTE**

- You can also reverse steps 2 and 3.
- If you are not going to use this system for a long period of time, be sure to remove the power cord from the power outlet.

Plasma Display/Media Receiver status indicators

Indicator Status				System Status
Plasma Display		Media Receiver		
POWER ON	STANDBY	POWER ON	STANDBY	
●	●	●	●	Power to the Plasma Display and Media Receiver is off. Or the power cords have been disconnected.
☀	●	☀	●	Power to the system is on.
●	☀	●	☀	The system is in the standby mode.
●	☀ Flashing	●	●	Power to the Media Receiver is off. Or the power cord has been disconnected from the Media Receiver.
●	●	●	☀ Flashing	Power to the Plasma Display is off. Or the power cord has been disconnected from the Plasma Display.

For other than the above, see "Troubleshooting" on page 106.

Plasma Display (right view)

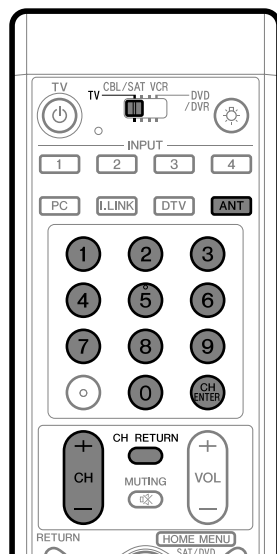
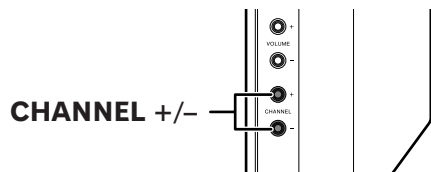

Channel display

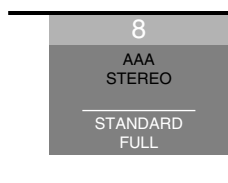

Watching conventional TV channels

Unless you set up conventional TV channels that you can watch under the current conditions, you cannot tune in those channels. For the procedure, see "Setting up conventional TV channels" on page 41.

NOTE

- Conventional TV channels in this manual designate TV channels that are received through the conventional VHF/UHF frequencies or conventional cable TV channels.

Selecting the antenna

After confirming that the Mode switch on the remote control unit has been set to "TV", press **ANT** on the remote control unit to select antenna A or B.

- Make this selection depending on the connections to the antenna input terminals on the Media Receiver (pages 24 to 26).

Changing channels

Using CH +/- on the remote control unit

- Press **CH +** to increase the channel number.
- Press **CH -** to decrease the channel number.

NOTE

- CHANNEL +/-** on the Plasma Display operates the same as **CH +/-**.

Using CH RETURN on the remote control unit

Press **CH RETURN** to switch the currently tuned channel to the previously tuned channel.

Press **CH RETURN** again to switch back to the currently tuned channel.

Using 0 - 9 on the remote control unit

Select channels directly by pressing buttons **0** to **9**.

EXAMPLE

- To select channel 5 (1-digit channel), press **5**.
- To select channel 25 (2-digit channel), press **2**, followed by **5**.
- To select channel 125 (3-digit channel), press **1**, then **2**, followed by **5**.

NOTE

- After entering a channel number, you may press **CH ENTER** to tune in the channel more quickly.

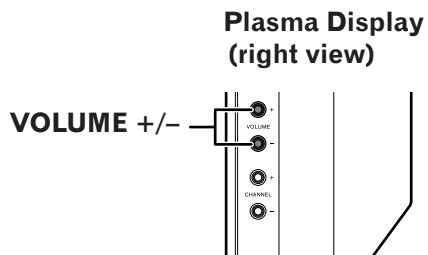

Changing the volume and sound

Using VOL +/- on the remote control unit

- To increase the volume, press **VOL +**.
- To decrease the volume, press **VOL -**.

NOTE

- **VOLUME +/-** on the Plasma Display operates the same as **VOL +/-**.

Using **MUTING** on the remote control unit

mutes the current sound output.

- 1 Press **MUTING**.
 - "" appears on the screen.
- 2 Press **MUTING** again to cancel the mute mode.
 - Pressing **VOL +** can also cancel the mute mode.

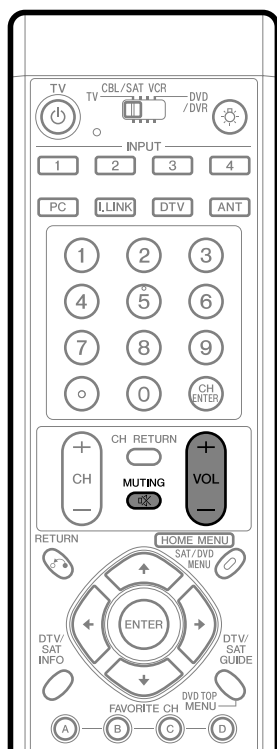

Volume adjustment



Mute



Setting MTS/SAP mode

The Plasma Display System has a feature that allows reception of sound other than the main audio for the program. This feature is called Multi-channel Television Sound (MTS). The Plasma Display System with MTS can receive mono sound, stereo sound and Secondary Audio Programs (SAP). The SAP feature allows a TV station to broadcast other information, which could be audio in another language or something completely different like weather information.

You can enjoy Hi-Fi stereo sound or SAP broadcasts where available.

• Stereo broadcasts

View programs like live sporting events, shows and concerts in dynamic stereo sound.

• SAP broadcasts

Receive TV broadcasts in either MAIN or SAP sound.

MAIN sound: The normal program soundtrack (either in mono or stereo).

SAP sound: Listen to second language, supplementary commentary and other information. (SAP is mono sound.)

If stereo sound is difficult to hear:

- Obtain a clearer sound by manually switching to the MONO mode.

NOTE

- Once the MONO mode is selected, the Plasma Display System sound remains mono even if the system receives a stereo broadcast. You must reselect the STEREO mode if you want to hear stereo sound again.
- Selecting MTS while the input source is INPUT 1 to 4 or PC does not change the type of sound. In this case, sound is determined by the video source.

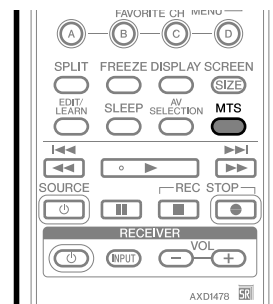

Each time you press **MTS**, MTS toggles as shown below.

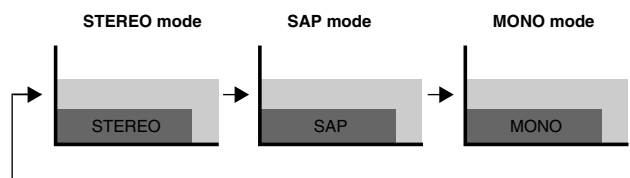

NOTE

- In each of the MTS/SAP modes selected using the **MTS** button, the display changes depending on broadcasting signals being received. See page 33.

When receiving STEREO sound signals

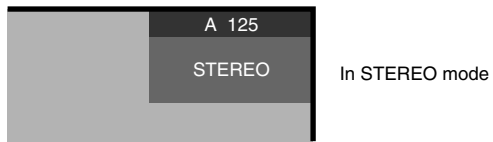

When receiving STEREO + SAP sound signals

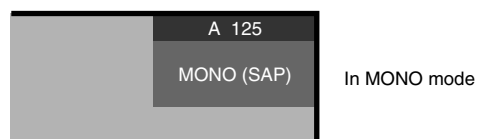
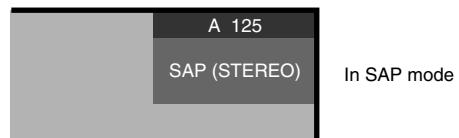
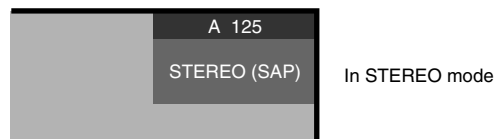

When receiving MAIN + SAP sound signals

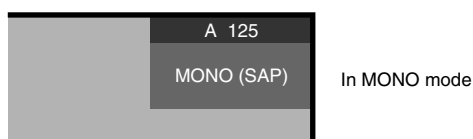
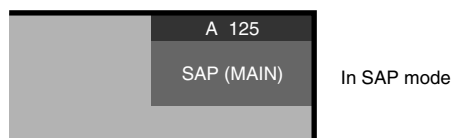
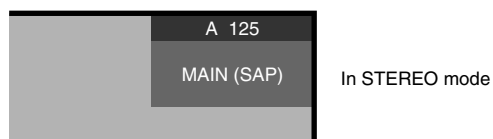

When receiving MONO sound signals

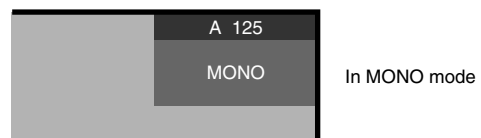
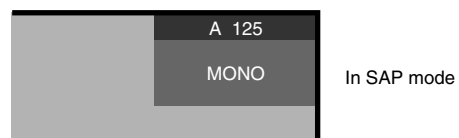

Plasma Display (right view)

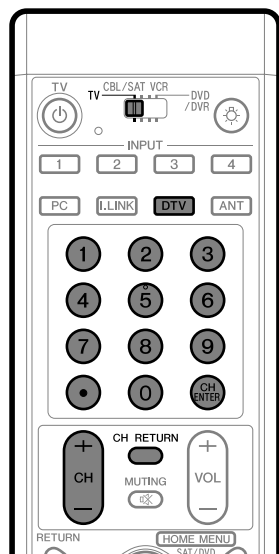
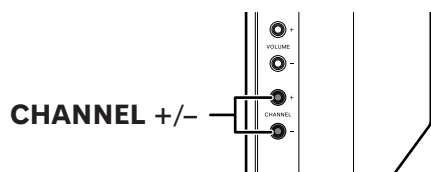

Channel display

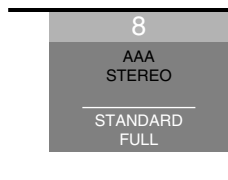

Watching digital TV channels

Unless you set up digital TV channels that you can watch under the current conditions, you cannot tune in those channels. For the procedure, see "Setting up digital TV channels" on page 44.

Selecting the digital TV input

After confirming that the Mode switch on the remote control unit has been set to "TV", press **DTV** on the remote control unit to select the input source for digital TV channels.

Changing channels

Using CH +/- on the remote control unit

- Press **CH +** to increase the channel number.
- Press **CH -** to decrease the channel number.

NOTE

- **CHANNEL +/-** on the Plasma Display operates the same as **CH +/-**.

Using CH RETURN on the remote control unit

Press **CH RETURN** to switch the currently tuned channel to the previously tuned channel.

Press **CH RETURN** again to switch back to the currently tuned channel.

Using 0 – 9 and • (dot) on the remote control unit

Select channels directly by pressing buttons **0** to **9**. To select subchannels, also use the **•** (dot) button.

EXAMPLE

- To select channel 5 (1-digit channel), press **5**.
- To select channel 25 (2-digit channel), press **2**, followed by **5**.
- To select channel 125 (3-digit channel), press **1**, then **2**, followed by **5**.
- To select subchannel 2.1, press **2**, **•** (dot), then **1**.
- To select subchannel 10.1, press **1**, **0**, **•** (dot), then **1**.

NOTE

- After entering a channel or subchannel number, you may press **CH ENTER** to tune in the channel more quickly.

Plasma Display
(right view)

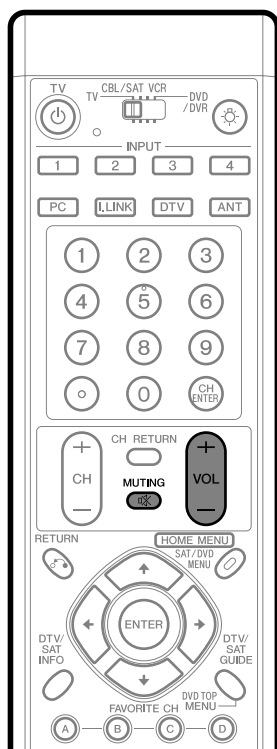
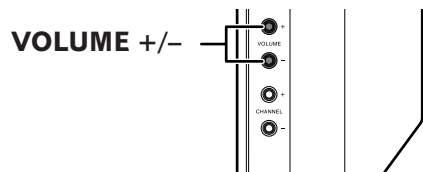

Changing the volume and sound

Using VOL +/- on the remote control unit

- To increase the volume, press **VOL +**.
- To decrease the volume, press **VOL -**.

NOTE

- **VOLUME +/-** on the Plasma Display operates the same as **VOL +/-**.

Using **MUTING** on the remote control unit

MUTING mutes the current sound output.

- 1 Press **MUTING**.
 - "M" appears on the screen.
- 2 Press **MUTING** again to cancel the mute mode.
 - Pressing **VOL +** can also cancel the mute mode.

Changing the language

If you have selected a digital TV program that provides multi-language services, you can switch among the languages by pressing **MTS** on the remote control unit.

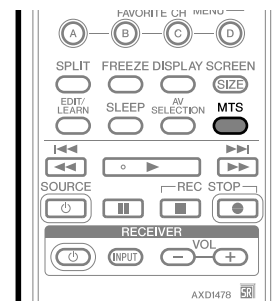

Each time you press **MTS**, the language switches.

NOTE

- Switchable languages differ depending on the current broadcast.
- If the language selected through language setting is available when the channel or program is changed, you will hear that language.

Volume adjustment



Mute



Viewing DTV banners

While watching a digital TV program, pressing **DTV INFO** causes the following banner to appear.

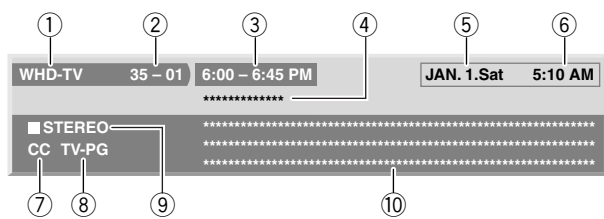

- ① Station name
- ② Channel number
- ③ Program time schedule
- ④ Program title
- ⑤ Date
- ⑥ Time
- ⑦ Appears if closed captions (CC) are available.
- ⑧ Shows the parental control ratings.
- ⑨ Shows available audio services.
- ⑩ Information about the program

NOTE

- The above information is not displayed if not included in broadcast signals.

Using the multiscreen functions

Splitting the screen

Use the following procedure to select the 2-screen or picture-in-picture mode.

2-screen



Picture-in-picture

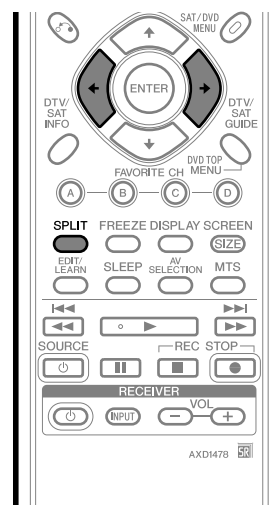
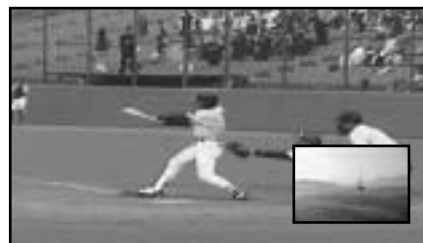

- 1 Press **SPLIT** to select the display mode.
 - Each time you press **SPLIT**, the display mode is switched among 2-screen, picture-in-picture, and single-screen.
- 2 When in the 2-screen or picture-in-picture mode, press **◀/▶** to select a screen to be active.
 - “♪” appears on the active screen, which outputs sound.
- 3 To select the desired input source, press the appropriate input source button.
 - If watching TV programs, press **CH +/-** to change the channel.

NOTE

- The multiscreen function cannot display images from the same input source at the same time. If you make such an attempt, a warning message appears.
- When you press **HOME MENU**, **DTV GUIDE**, or **DTV INFO**, the single-screen mode is restored and the corresponding menu is displayed.

Freezing images

Use the following procedure to capture and freeze one frame from a moving image that you are watching.

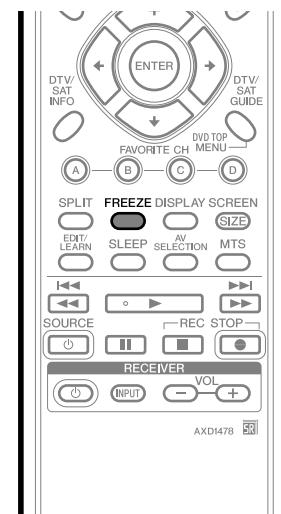
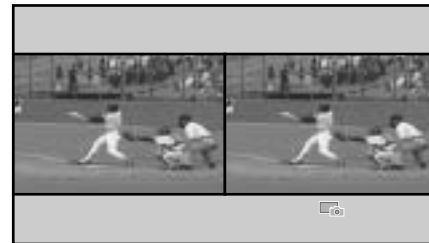

- 1 Press **FREEZE**.
 - A still image appears on the right screen while a moving image is shown on the left screen.
- 2 Press **FREEZE** again to cancel the function.

NOTE

- With the screen split, any image cannot be frozen.
- When this function is not available, a warning message appears.

Using the menu

AV mode menus

Home Menu	Item	Description	Page
Picture	AV Selection	Select from the five display mode options; STANDARD, DYNAMIC, MOVIE, GAME and USER.	47
	Contrast	Adjusts the picture between light and shade.	49
	Brightness	Adjusts picture brightness.	49
	Color	Adjusts color intensity.	49
	Tint	Adjusts skin color to a more natural tone.	49
	Sharpness	Adjusts picture sharpness.	49
	Pro Adjust	Adjusts the levels of PureCinema, Color Temp, MPEG NR, DNR, CTI, DRE, and Color Management.	49-53
	Reset	All image adjustment settings return to the factory defaults.	49
Sound	Treble	Adjusts the treble weaker or stronger.	53
	Bass	Adjusts the bass weaker or stronger.	53
	Balance	Adjusts audio output between left and right speakers.	53
	Reset	All audio adjustment settings return to the factory defaults.	53
	FOCUS	Shift the sound coming direction (sound images) upward and produces clear sound contours.	54
	Front Surround	Provides three-dimensional sound effects and/or deep, rich bass.	54
Power Control	Energy Save	Saves power by decreasing picture brightness.	55
	No Signal off	Places the system into the standby mode when no signal is received for 15 minutes.	55
	No Operation off	Places the system into the standby mode when no operation is performed for three hours.	56
Sleep Timer		Automatically places the system into the standby mode when the selected time elapses.	85
Option	Position	Adjusts the vertical and horizontal positions of displayed images.	81
	Side Mask	With the 4:3 screen size selected, sets the brightness of the gray side masks that appear at both sides of the screen.	84
Setup	Channel Setup	Sets up for conventional TV channels.	41, 42
	Favorite Channel	Sets your favorite TV channels to the four color buttons on the remote control unit.	43
	Parental Control	Prevents your children from watching specified types of TV programs.	90-94
	Password	Prevents other persons from changing especially Parental Control settings.	95, 96
	Closed Caption	Sets up for closed captions for conventional TV channels. For DTV channels, use "DTV Closed Caption" under "DTV Setup".	86
	Clock	Corrects the date and time.	46, 47
	Language	Select the language to be used for on-screen display such as menus and instructions.	46
DTV Setup	DTV Channel Setup	Sets up for receiving DTV channels.	44-45
	DTV Closed Caption	Sets up for closed captions for DTV channels.	87-89
	Digital Audio Out	Sets up for optical digital audio output.	69
	i.LINK Setup	Sets up for the i.LINK interface.	73-76
	VCR Control	Sets up for the manufacture and model of recording equipment to be connected.	78, 79
Rec/View Timer		Allows you to make DTV program presets by manually specifying date and time.	62-64

Basic Adjustment Settings

09

PC mode menus

Home Menu	Item	Description	Page
Picture	AV Selection	Select from the two display mode options; STANDARD and USER.	47
	Contrast	Adjusts the picture between light and shade.	49
	Brightness	Adjusts picture brightness.	49
	Red	Adjusts red color intensity.	49
	Green	Adjusts green color intensity.	49
	Blue	Adjusts blue color intensity.	49
	Reset	All image adjustment settings return to the factory defaults.	49

Sound	Treble	Adjusts the treble weaker or stronger.	53
	Bass	Adjusts the bass weaker or stronger.	53
	Balance	Adjusts audio output between left and right speakers.	53
	Reset	All audio adjustment settings return to the factory defaults.	53
	FOCUS	Shifts the sound coming direction (sound images) upward and produces clear sound contours.	54
	Front Surround	Provides three-dimensional sound effects and/or deep, rich bass.	54

Power Control	Energy Save	Saves power by decreasing picture brightness.	55
	Power Management	Automatically places the system into the standby mode when no signal is received from the personal computer.	56

Sleep Timer		Automatically places the system into the standby mode when the selected time elapses.	85
-------------	--	---	----

Option	Auto Setup	Automatically optimizes image positions and clock.	81
	Manual Setup	Allows you to manually adjust image positions and clock.	82

39

En

Menu operation keys

Use the following keys on the remote control to operate the menu. For detailed menu operations, see appropriate pages that describe individual functions.

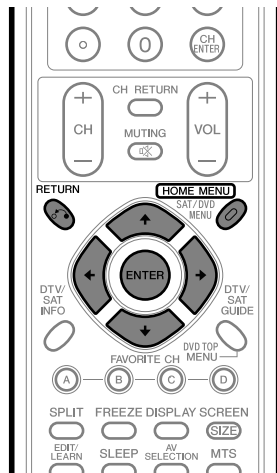

- HOME MENU:** Press to open or close the Home menu.
- ↑/↓:** Press to select a menu item. For some menu items, you can select parameters using these keys.
- ←/→:** Press to select a parameter or adjustment level for menu items.
- ENTER:** Press to proceed to lower menu levels. For some menu items, you need to press this key to complete selections.
- RETURN:** Press to return to upper menu levels.

Setting up conventional TV channels

This section describes how to search and set up conventional TV channels that you can watch under the current conditions. Unless you set up conventional TV channels using Auto channel Preset, you may not be able to tune in those channels.

NOTE

- Conventional TV channels in this manual designate TV channels that are received through the conventional VHF/ UHF frequencies or conventional cable TV channels.

Using Auto Channel Preset

Auto Channel Preset automatically searches and sets up conventional TV channels.

- 1 Press **HOME MENU**.
- 2 Press **↑/↓** to select "Setup", and then press **ENTER**.
- 3 Press **↑/↓** to select "Channel Setup", and then press **ENTER**.
- 4 Press **↑/↓** to select "Auto Channel Preset", and then press **ENTER**.
- 5 Press **↑/↓** to select "Antenna", and then press **←/→** to select "A" or "B".

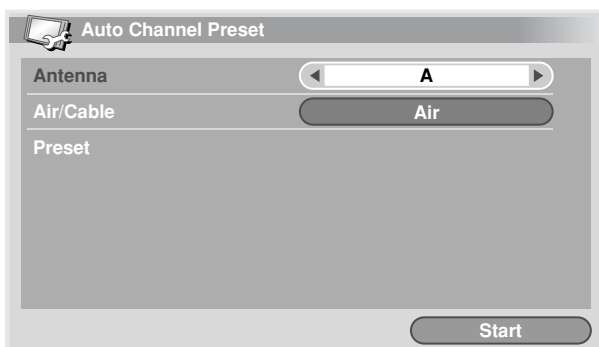

- 6 Press **↑/↓** to select "Air/Cable", and then press **←/→** to select "Air" or "Cable".

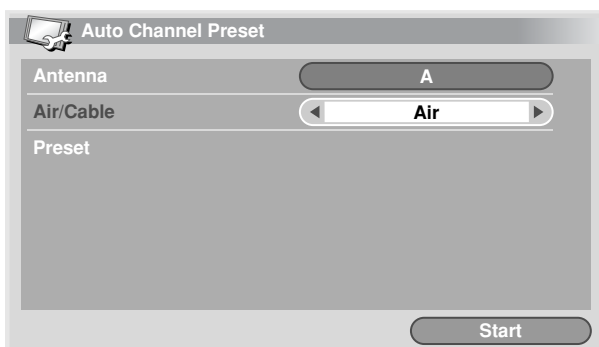

- 7 Press **↑/↓** to select "Preset:Start", and then press **ENTER**.

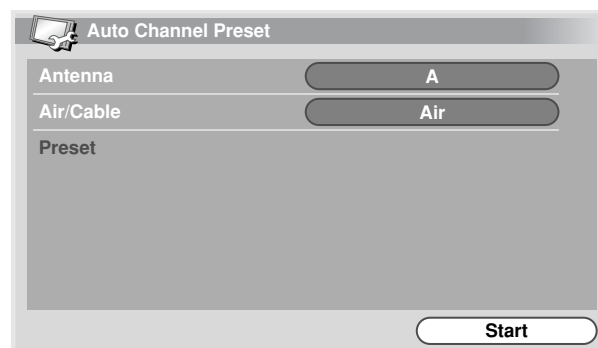

- Channel search automatically starts.

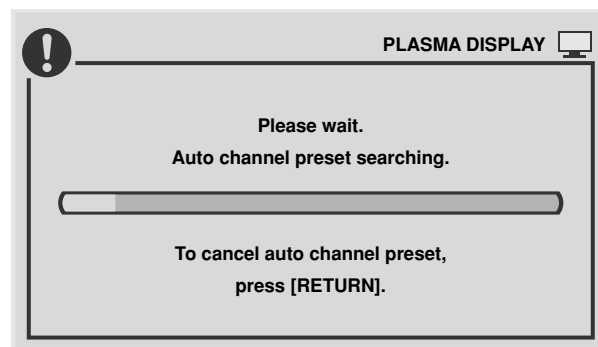

- To quit Auto Channel Preset halfway, press **RETURN**.
- 8 After Auto Channel Preset has been finished, press **HOME MENU** to exit the menu.

NOTE

- When using the Cable Converter, you may need to manually add Cable Converter output channels.

Setting for skipping unwanted channels

From among conventional TV channels searched and set up using Auto Channel Preset, you can select channels to be skipped when **CH +/-** are operated.

- 1 Press **HOME MENU**.
- 2 Press **▲/▼** to select "Setup", and then press **ENTER**.
- 3 Press **▲/▼** to select "Channel Setup", and then press **ENTER**.
- 4 Press **▲/▼** to select "Channel ADD/DEL", and then press **ENTER**.
- 5 Press **▲/▼** to select "Antenna", and then press **←/→** to select "A" or "B".

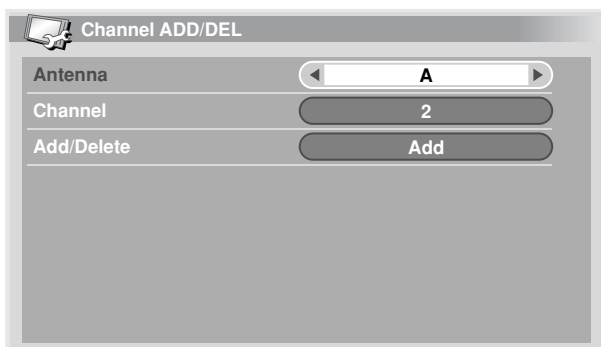

- 6 Press **▲/▼** to select "Channel", and then press **←/→** to select a channel to be skipped.

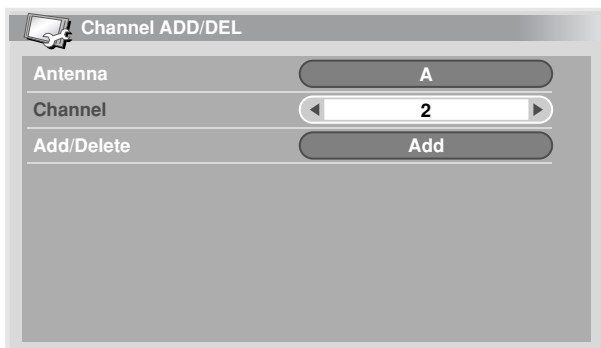

- 7 Press **▲/▼** to select "Add/Delete", and then press **←/→** to select "Delete".

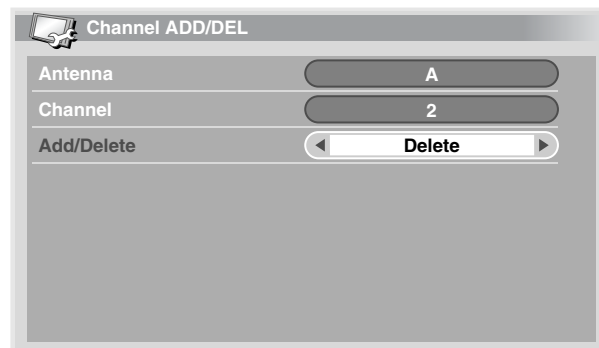

- 8 Press **HOME MENU** to exit the menu.

NOTE

- To restore skipped channels, use the above procedure except that you select "Add" in step 7.
- When using the Cable Converter, you may need to manually add Cable Converter output channels.

Setting your favorite channels

Set up to four TV channels to each of the four color buttons on the remote control unit (16 channels in total). You can then quickly select from only your favorite channels. You can program these buttons with conventional channels.

- 1 Select and tune to a TV channel to be registered.
- 2 Press **HOME MENU**.
- 3 Press **▲/▼** to select "Setup", and then press **ENTER**.
- 4 Press **▲/▼** to select "Favorite Channel", and then press **ENTER**.

Favorite Channel							
Current Channel A				69			
	●	●	○	○			
1	A	69	-	---	-	---	B 86
2	B	86	-	---	-	---	A 69
3	B	125	-	---	-	---	-
4	A	69	A	0	A	0	B 125

- 6 Press **ENTER** to execute the registration.
 - Before pressing **ENTER**, you can also change a TV channel to be registered. Press **▲/▼** to select ANT A or ANT B, and then press **◀/▶** to select a TV channel. To clear the channel registered at the current location, select "-" by pressing **▲/▼** and then press **ENTER**.
 - To register another TV channel at a different location, select a TV channel, and then repeat steps 5 and 6.
- 7 Press **HOME MENU** to exit the menu.

NOTE

- You cannot program the four color buttons with digital TV channels.

- 5 Press **▲/▼** and **◀/▶** to select a location where the TV channel is to be registered, and then press **ENTER**.

Favorite Channel							
Current Channel B				86			
	●	●	○	○			
1	A	69	-	---	-	---	B 86
2	B	86	B	86	-	---	A 69
3	B	125	-	---	-	---	-
4	A	69	A	0	A	0	B 125

Setting up digital TV channels

This section describes how to search and set up digital TV channels that you can watch under the current conditions. Unless you set up digital TV channels using Auto Channel Preset, you cannot tune in those channels.

Using Auto Channel Preset

Auto Channel Preset automatically searches and sets up digital TV channels.

- 1 Press **HOME MENU**.
- 2 Press **▲/▼** to select "DTV Setup", and then press **ENTER**.
- 3 Press **▲/▼** to select "DTV Channel Setup", and then press **ENTER**.
- 4 Press **▲/▼** to select "Auto Channel Preset", and then press **ENTER**.
- 5 Press **←/→** to select "Air" or "Cable".



- 6 Press **▲/▼** to select "Start", and then press **ENTER**.

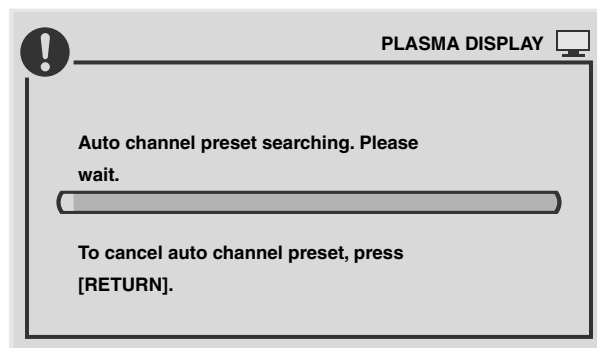

- Channel search automatically starts.

- 7 Press **HOME MENU** to exit the menu.

NOTE

- With "Cable" selected, this system can receive only digital TV signals (Standard Channel Plan) with the 8VSB modulation. This system does not support the QAM modulation.

Setting for skipping unwanted channels

From among digital TV channels searched and set up using Auto Channel Preset, you can select channels to be skipped when **CH +/-** are operated.

- 1 Press **HOME MENU**.
- 2 Press **▲/▼** to select "DTV Setup", and then press **ENTER**.
- 3 Press **▲/▼** to select "DTV Channel Setup", and then press **ENTER**.
- 4 Press **▲/▼** to select "Channel Add/Del", and then press **ENTER**.
- 5 Press **▲/▼** to select "Channel".
- 6 Press **←/→** to select a channel to be skipped.



- 7 Press **▲/▼** to select "Add/Delete".
- 8 Press **←/→** to select "Delete".

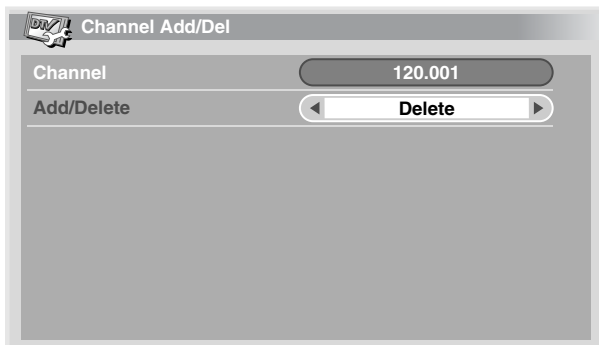

- 9 Press **HOME MENU** to exit the menu.

NOTE

- To restore skipped channels, use the above procedure except that you select "Add" in step 8.

Checking signal strength

When watching a digital TV program, you can check its current signal strength.

- 1 Press **HOME MENU**.
- 2 Press **▲/▼** to select "DTV Setup", and then press **ENTER**.
- 3 Press **▲/▼** to select "DTV Channel Setup", and then press **ENTER**.
- 4 Press **▲/▼** to select "Signal Strength", and then press **ENTER**.

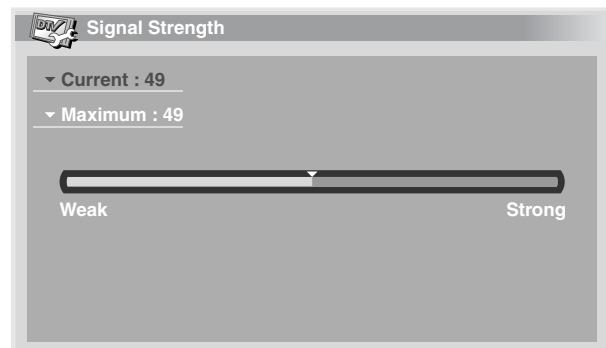

- Adjust the direction of the antenna so that the current signal strength reaches as close to the maximum signal strength as possible.

- 5 Press **HOME MENU** to exit the menu.

Language setting

You can select a language to be used for on-screen display such as menus from among three languages; English, French, and Spanish.

- 1 Press **HOME MENU**.
- 2 Press **▲/▼** to select "Setup", and then press **ENTER**.
- 3 Press **▲/▼** to select "Language", and then press **ENTER**.
- 4 Press **←/→** to select a language.



- 5 Press **HOME MENU** to exit the menu.

Clock setting

Use the following procedure to set the time correctly.

If you disconnect the power cord from the power outlet or power blackout occurs after setting the time, the set time is cleared. With "Auto" selected for Clock Setting, time information is then acquired and set automatically. With "Manual" selected, you then need to manually set the correct time again.

- 1 Press **HOME MENU**.
- 2 Press **▲/▼** to select "Setup", and then press **ENTER**.
- 3 Press **▲/▼** to select "Clock", and then press **ENTER**.
- 4 Press **▲/▼** to select "Clock Setting", and then press **←/→** to select "Auto" or "Manual".

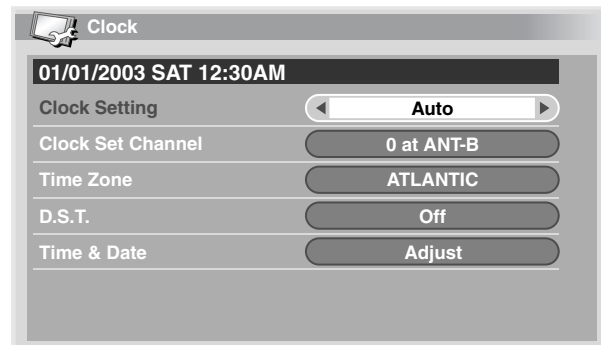

- If you select "Auto", the date and time will be automatically corrected.
- 5 Press **▲/▼** to select "Clock Set Channel", and then press **←/→** to select a TV channel to be used for auto clock setting.
 - 6 Press **▲/▼** to select "Time Zone", and then press **←/→** to select a time zone for your area.
 - 7 Press **▲/▼** to select "D.S.T.", and then press **←/→** to select "On" or "Off" depending on whether summer time is employed in your area.

NOTE

- When selecting "Auto" for "Clock Setting", be sure to connect the Antenna B input terminal to the output of the VHF/UHF antenna or Cable Converter. See page 26.

- 8 Press **▲/▼** to select "Time & Date", and then press **ENTER**.
- The date & time entry screen appears. Enter the current date and time using **▲/▼** and **◀/▶**, and then press **ENTER**.

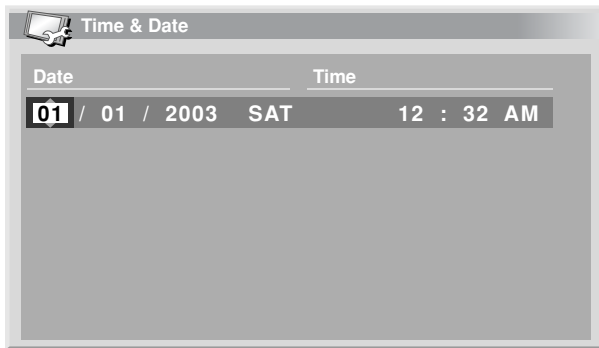

- 9 Press **HOME MENU** to exit the menu.

NOTE

- When the time has not yet been set, the REC TIMER indicator on the front of the Media Receiver blinks.
- When the time has not yet been set, you cannot view EPG information, use auto channel select, and preset TV programs for recording.

AV Selection

AV Selection gives you five viewing options to choose from to best match the Plasma Display System environment, which can vary due to factors like room brightness, type of program watched or the type of image input from external equipment.

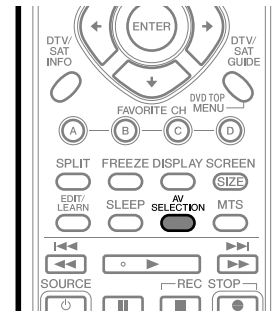

- Press **AV SELECTION**.
 - Present AV Selection mode appears.
- Press **AV SELECTION** again before the mode displayed on the screen disappears.
 - For AV source, the mode is switched in the order; STANDARD, DYNAMIC, MOVIE, GAME, then USER.
 - For PC source, the mode is switched between STANDARD and USER.

You can also use the menu to change the options.

- 1 Press **HOME MENU**.
- 2 Press **▲/▼** to select "Picture", and then press **ENTER**.
- 3 Press **▲/▼** to select "AV Selection", and then press **ENTER**.
- 4 Press **▲/▼** to select the desired option, and then press **ENTER**.

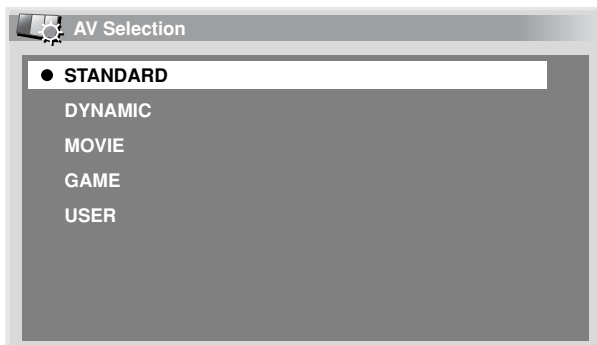

For AV source

Item	Description
STANDARD	For a highly defined image in a normally bright room
DYNAMIC	For a very sharp image with the maximum contrast This mode does not allow manual image quality adjustment.
MOVIE	For a movie
GAME	Lowers image brightness for easier viewing.
USER	Allows the user to customize settings as desired. You can set the mode for each input source.

For PC source

Item	Description
STANDARD	For a highly defined image in a normally bright room
USER	Allows the user to customize settings as desired. You can set the mode for each input source.

- 5 Press **HOME MENU** to exit the menu.

Picture adjustments

Adjust the picture to your preference for the chosen AV Selection option (except DYNAMIC).

- 1 Press **HOME MENU**.
- 2 Press **▲/▼** to select "Picture", and then press **ENTER**.
- 3 Press **▲/▼** to select an item to be adjusted, and then press **ENTER**.

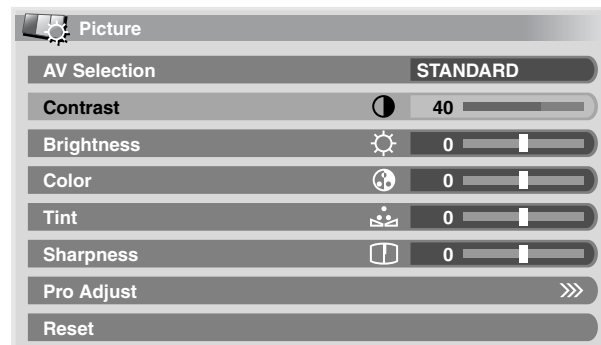

- 4 Press **←/→** to select the desired level, and then press **ENTER**.



- When an adjustment screen is in display, you can also change an item to be adjusted, by pressing **▲/▼**.

- 5 Press **HOME MENU** to exit the menu.

Basic Adjustment Settings

09

For AV source

Item	← button	→ button
Contrast	For less contrast	For more contrast
Brightness	For less brightness	For more brightness
Color	For less color intensity	For more color intensity
Tint	Skin tones become purplish	Skin tones become greenish
Sharpness	For less sharpness	For more sharpness

For PC source

Item	← button	→ button
Contrast	For less contrast	For more contrast
Brightness	For less brightness	For more brightness
Red	For weaker red	For stronger red
Green	For weaker green	For stronger green
Blue	For weaker blue	For stronger blue

For PC source, the following screen appears:

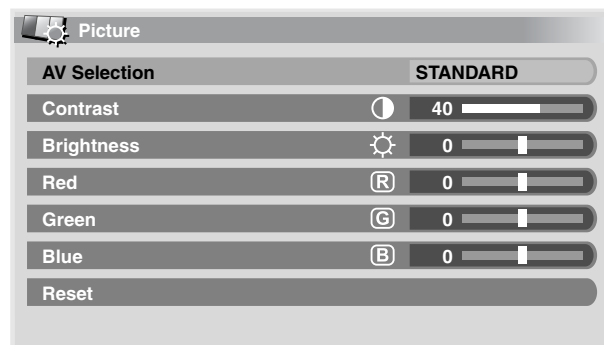

NOTE

- To make settings for "PureCinema", "Color Temp", "MPEG NR", "DNR", "CTI", "DRE", and "Color Management", select "Pro Adjust" in step 3, and then press **ENTER**. For the subsequent procedures, see pages 49 to 52.
- To restore the factory defaults for all the items, press **↑/↓** to select "Reset" in step 3, and then press **ENTER**. A confirmation screen appears. Press **↑/↓** to select "Yes", and then press **ENTER**.

PureCinema

Automatically detects a film-based source (originally encoded at 24 frames/second), analyzes it, then recreates each still film frame for high-definition picture quality.

- 1 Press **HOME MENU**.
- 2 Press **↑/↓** to select "Picture", and then press **ENTER**.
- 3 Press **↑/↓** to select "Pro Adjust", and then press **ENTER**.
- 4 Press **↑/↓** to select "PureCinema", and then press **ENTER**.
- 5 Press **↑/↓** to select the desired parameter, and then press **ENTER**.

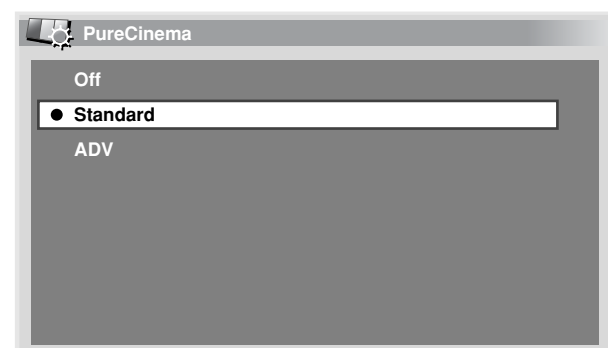

Item	Description
Off	Deactivates the PureCinema.
Standard	Produces smooth and vivid moving images (film specific) by automatically detecting recorded image information when displaying DVD or 1080i HDTV images (e.g., movies) having 24 frames per second.
ADV	Produces smooth and quality moving images (as shown on theater screens) by converting to 72 Hz when displaying DVD images (e.g., movies) having 24 frames per second.

- 6 Press **HOME MENU** to exit the menu.

NOTE

- You cannot select "Standard" when 480p or 720p signals are being input.

49

En

Color temperature

Adjust the color temperature to give a better white balance.

- 1 Press **HOME MENU**.
- 2 Press **▲/▼** to select "Picture", and then press **ENTER**.
- 3 Press **▲/▼** to select "Pro Adjust", and then press **ENTER**.
- 4 Press **▲/▼** to select "Color Temp", and then press **ENTER**.
- 5 Press **▲/▼** to select the desired level, and then press **ENTER**.

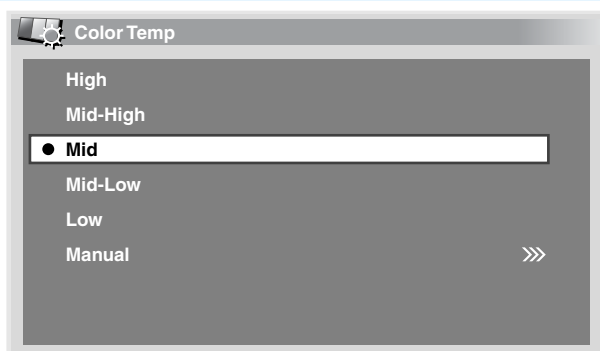

Item	Description
High	White with bluish tone
Mid-High	Intermediate tone between High and Mid
Mid	Natural tone
Mid-Low	Intermediate tone between Mid and Low
Low	White with reddish tone
Manual	Colour temperature adjusted to your preference

- 6 Press **HOME MENU** to exit the menu.

NOTE

You can manually adjust the color temperature, using the following procedure:

- ① Select "Manual" in step 5 above, and then press and hold **ENTER** for more than three seconds to display the manual adjustment screen.
- ② Press **▲/▼** to select an item to be adjusted, and then press **ENTER**.
- ③ Press **←/→** to select the desired level, and then press **ENTER**.

Item		← button	→ button
R High	Fine adjustment for bright portions	For weaker red	For stronger red
G High		For weaker green	For stronger green
B High		For weaker blue	For stronger blue
R Low	Fine adjustment for dark portions	For weaker red	For stronger red
G Low		For weaker green	For stronger green
B Low		For weaker blue	For stronger blue

- To perform adjustment for another item, press **RETURN**, and then repeat steps ② and ③.
 - You may press **▲/▼** to immediately change an item to be adjusted.
- ④ Press **HOME MENU** to exit the menu.

MPEG NR

This eliminates mosquito noise from video images when a DTV channel is watched or a DVD is played, resulting in noise-free images.

- 1 Press **HOME MENU**.
- 2 Press **▲/▼** to select "Picture", and then press **ENTER**.
- 3 Press **▲/▼** to select "Pro Adjust", and then press **ENTER**.
- 4 Press **▲/▼** to select "MPEG NR", and then press **ENTER**.
- 5 Press **▲/▼** to select the desired parameter, and then press **ENTER**.

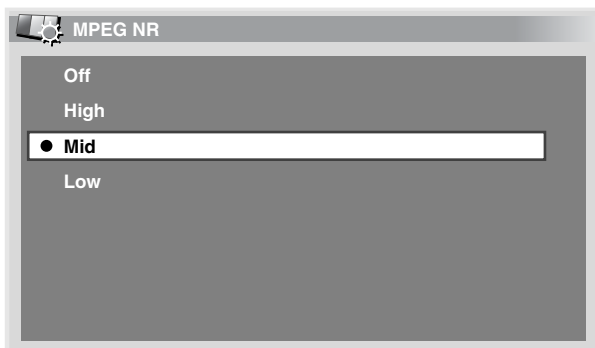

Item	Description
Off	Deactivates the MPEG NR.
High	Enhanced MPEG NR
Mid	Standard MPEG NR
Low	Moderate MPEG NR

- 6 Press **HOME MENU** to exit the menu.

DNR

Select the DNR (Digital Noise Reduction) level to eliminate video noise for a clean crisp image.

- 1 Press **HOME MENU**.
- 2 Press **▲/▼** to select "Picture", and then press **ENTER**.
- 3 Press **▲/▼** to select "Pro Adjust", and then press **ENTER**.
- 4 Press **▲/▼** to select "DNR", and then press **ENTER**.
- 5 Press **▲/▼** to select the desired level, and then press **ENTER**.

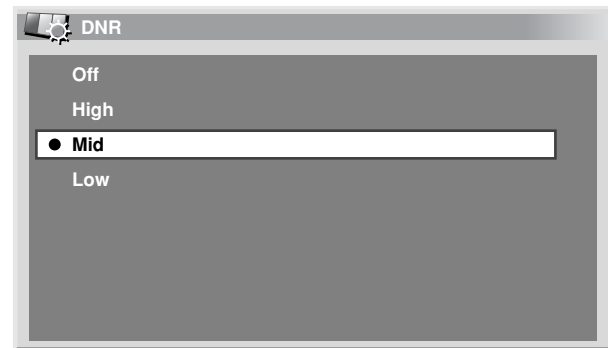

Item	Description
Off	Deactivates the DNR.
High	Enhanced DNR
Mid	Standard DNR
Low	Moderate DNR

- 6 Press **HOME MENU** to exit the menu.

CTI

Use the CTI (Color Transient Improvement) to make images have clearer color contours.

- 1 Press **HOME MENU**.
- 2 Press **▲/▼** to select "Picture", and then press **ENTER**.
- 3 Press **▲/▼** to select "Pro Adjust", and then press **ENTER**.
- 4 Press **▲/▼** to select "CTI", and then press **ENTER**.
- 5 Press **▲/▼** to select the desired parameter, and then press **ENTER**.

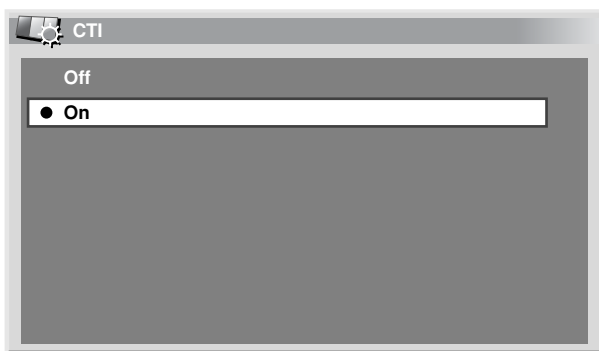

Item	Description
Off	Deactivates the CTI.
On	Activates the CTI.

- 6 Press **HOME MENU** to exit the menu.

DRE

Use the DRE (Dynamic Range Expander) to adjust dark and bright portions on images so that the contrast between brightness and darkness becomes clearer.

- 1 Press **HOME MENU**.
- 2 Press **▲/▼** to select "Picture", and then press **ENTER**.
- 3 Press **▲/▼** to select "Pro Adjust", and then press **ENTER**.
- 4 Press **▲/▼** to select "DRE", and then press **ENTER**.
- 5 Press **▲/▼** to select the desired parameter, and then press **ENTER**.

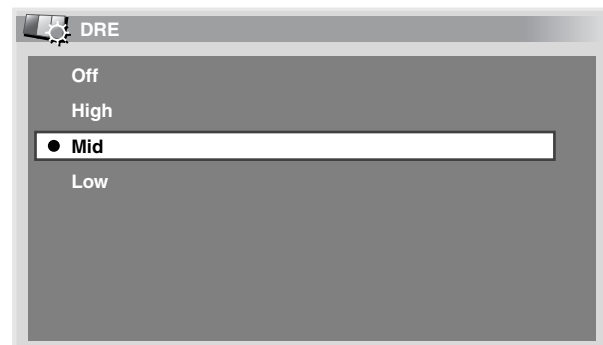

Item	Description
Off	Deactivates the DRE.
High	Enhanced DRE
Mid	Standard DRE
Low	Moderate DRE

- 6 Press **HOME MENU** to exit the menu.

Color Management

Perform fine hue adjustment for each basic color.

- 1 Press **HOME MENU**.
- 2 Press **▲/▼** to select "Picture", and then press **ENTER**.
- 3 Press **▲/▼** to select "Pro Adjust", and then press **ENTER**.
- 4 Press **▲/▼** to select "Color Management", and then press **ENTER**.
- 5 Press **▲/▼** to select an item to be adjusted, and then press **ENTER**.

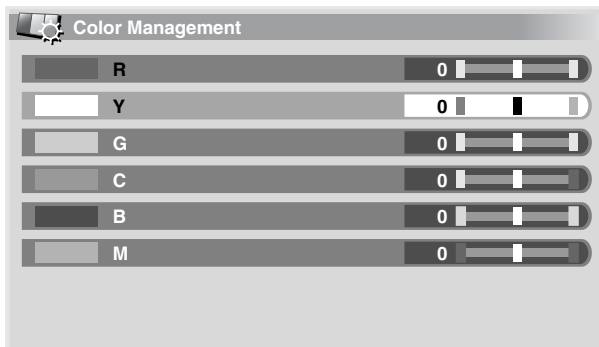

- 6 Press **←/→** to select the desired level.

Item	← button	→ button
Red	Closer to magenta	Closer to yellow
Yellow	Closer to red	Closer to green
Green	Closer to yellow	Closer to cyan
Cyan	Closer to green	Closer to blue
Blue	Closer to cyan	Closer to magenta
Magenta	Closer to blue	Closer to red

- To perform adjustment for another item, press **RETURN**, and then repeat steps 5 and 6.
- You may press **▲/▼** to immediately change an item to be adjusted.

- 7 Press **HOME MENU** to exit the menu.

Sound adjustments

Adjust the sound to your preference for the chosen AV Selection option. See page 47.

- 1 Press **HOME MENU**.
- 2 Press **▲/▼** to select "Sound", and then press **ENTER**.
- 3 Press **▲/▼** to select an item to be adjusted, and then press **←/→** to select the desired level.

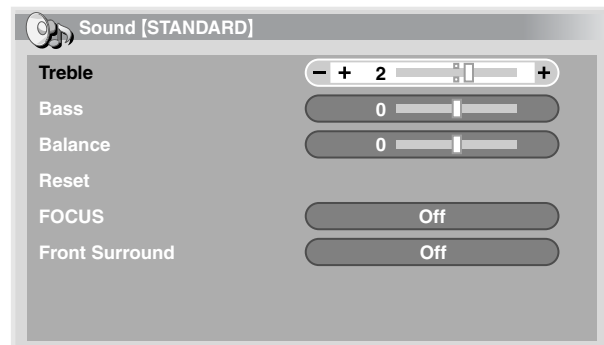

Item	← button	→ button
Treble	For weaker treble	For stronger treble
Bass	For weaker bass	For stronger bass
Balance	Decreases audio from the right speaker	Decreases audio from the left speaker

- 4 Press **HOME MENU** to exit the menu.

NOTE

- To restore the factory defaults for all the items, press **▲/▼** to select "Reset" in step 3, and then press **ENTER**. A confirmation screen appears. Press **▲/▼** to select "Yes", and then press **ENTER**.

FOCUS

This shifts the sound coming direction (sound images) upward and produces clear sound contours.

- 1 Press **HOME MENU**.
- 2 Press **▲/▼** to select "Sound", and then press **ENTER**.
- 3 Press **▲/▼** to select "FOCUS", and then press **←/→** to select the desired parameter.

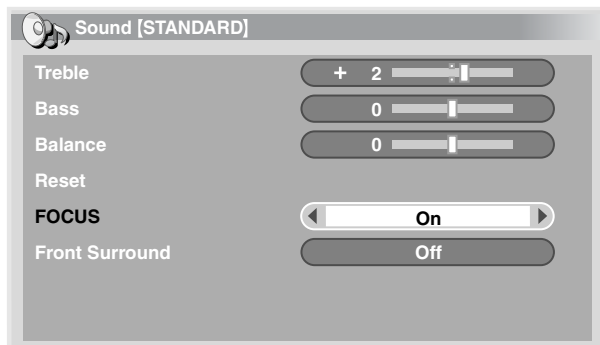

Item	Description
Off (factory default)	Deactivates the FOCUS.
On	Activates the FOCUS.

- 4 Press **HOME MENU** to exit the menu.

Front Surround

This provides three-dimensional sound effects and/or deep, rich bass.

- 1 Press **HOME MENU**.
- 2 Press **▲/▼** to select "Sound", and then press **ENTER**.
- 3 Press **▲/▼** to select "Front Surround", and then press **←/→** to select the desired parameter.

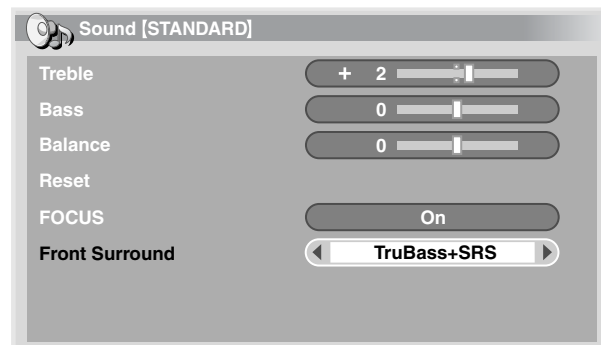

Item	Description
Off	Deactivates both the SRS and TruBass.
SRS	Reproduces highly effective three-dimensional sound.
TruBass (factory default)	Provides deep, rich bass using a new technology.
TruBass + SRS	Provides both TruBass and SRS effects.

- 4 Press **HOME MENU** to exit the menu.

NOTE

- **SRS WOW** (WOW) designates a status where the FOCUS is on and TruBass + SRS has been selected for Front Surround.
- **WOW**® is a trademark of SRS Labs, Inc.
- WOW technology is incorporated under license from SRS Labs, Inc.

Power Control

Power Control provides convenient functions for power saving.

Power Control for AV source

Energy Save

Power consumption is saved by decreasing picture brightness.

- 1 Press **HOME MENU**.
- 2 Press **▲/▼** to select "Power Control", and then press **ENTER**.
- 3 Press **▲/▼** to select "Energy Save", and then press **ENTER**.
- 4 Press **▲/▼** to select "Save", and then press **ENTER**.



Item	Description
Standard (factory default)	Does not decrease picture brightness.
Save	Decreases picture brightness to save power.

- 5 Press **HOME MENU** to exit the menu.

NOTE

- You can also select this function using the Home menu when the input source is a PC.

No Signal off

The system will be automatically placed into the standby mode if no signal is received for 15 minutes.

- 1 Press **HOME MENU**.
- 2 Press **▲/▼** to select "Power Control", and then press **ENTER**.
- 3 Press **▲/▼** to select "No Signal off", and then press **ENTER**.
- 4 Press **▲/▼** to select "Enable", and then press **ENTER**.

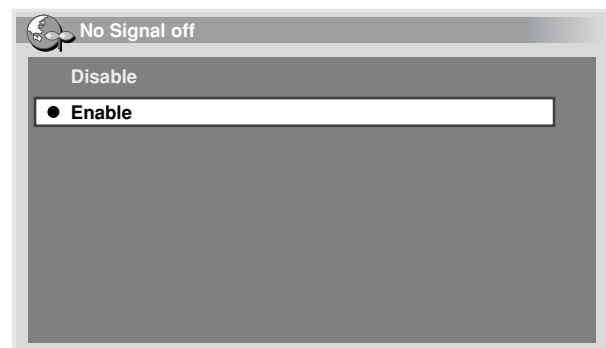

Item	Description
Disable (factory default)	Does not place the system into the standby mode.
Enable	Places the system into the standby mode if no signal is received for 15 minutes.

- 5 Press **HOME MENU** to exit the menu.

NOTE

- Five minutes before the system is placed into the standby mode, a message appears every minute.
- The system may not be placed into the standby mode when noise signals are present at the Media Receiver after a TV program finishes.

No Operation off

The system will be automatically placed into the standby mode when no operation is performed for three hours.

- 1 Press **HOME MENU**.
- 2 Press **▲/▼** to select "Power Control", and then press **ENTER**.
- 3 Press **▲/▼** to select "No Operation off", and then press **ENTER**.
- 4 Press **▲/▼** to select "Enable", and then press **ENTER**.



Item	Description
Disable (factory default)	Does not place the system into the standby mode.
Enable	Places the system into the standby mode if no operation is performed for three hours.

- 5 Press **HOME MENU** to exit the menu.

**NOTE**

- Five minutes before the system is placed into the standby mode, a message appears every minute.

Power Control for PC source**Power Management**

The system will be automatically placed into the standby mode when no signal is received from the personal computer.

- 1 Press **HOME MENU**.
- 2 Press **▲/▼** to select "Power Control", and then press **ENTER**.
- 3 Press **▲/▼** to select "Power Management", and then press **ENTER**.
- 4 Press **▲/▼** to select "Mode1" or "Mode2", and then press **ENTER**.

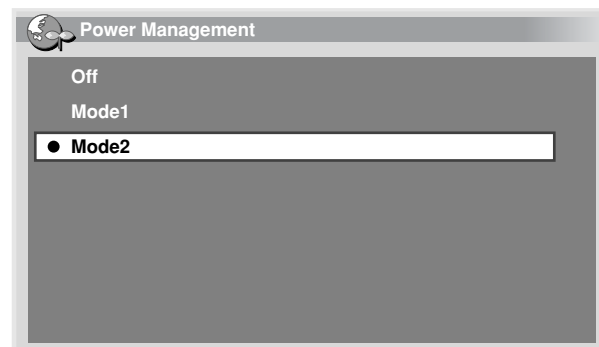

Item	Description
Off (factory default)	No power management
Mode1	<ul style="list-style-type: none"> • Places the system into the standby mode when no signal is received from the personal computer for eight minutes. • Even when you start using the computer and a signal is received again, the system stays off. • The system is switched on again by pressing STANDBY/ON on the Plasma Display or TV on the remote control unit.
Mode2	<ul style="list-style-type: none"> • Places the system into the standby mode when no signal is received for eight seconds. • When you start using the computer and a signal is received again, the system is switched on. • The system is switched on again by pressing STANDBY/ON on the Plasma Display or TV on the remote control unit.

- 5 Press **HOME MENU** to exit the menu.

EPG display format

The Electronic Program Guide (EPG) shows the table of scheduled digital TV programs and detailed information about individual programs. It also allows you to easily select and tune to a desired program.

The EPG Screen consists of the schedule window, information window, and picture window. This section describes information to be displayed on the schedule and information windows. The picture window shows moving images of a TV program watched when **DTV GUIDE** is pressed.

NOTE

- For digital TV programs that do not provide EPG information, you cannot watch the corresponding EPG information.
- If the current time has not been correctly set, there may be TV programs whose EPG information is not displayed.

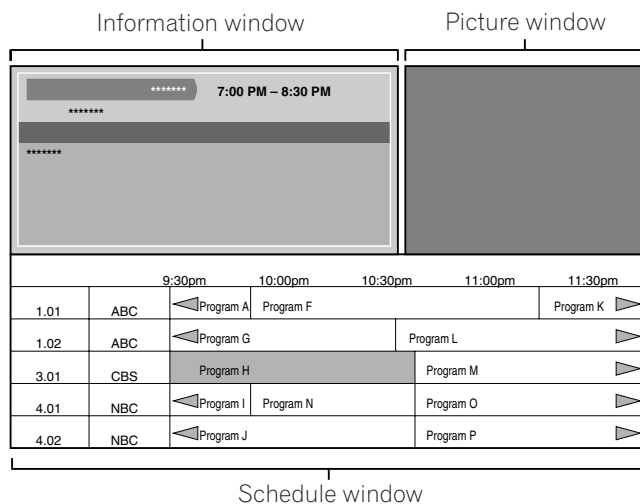

Schedule window

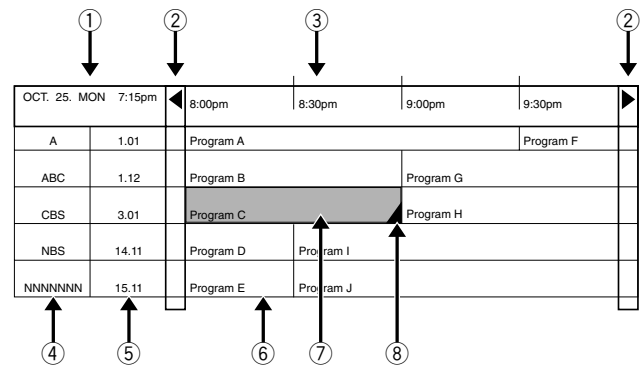

- ① Current date and time
- ② Appears when the schedule table can be scrolled forward or backward.
- ③ Time schedule
- ④ Station name
- ⑤ Channel number
- ⑥ Program title
- ⑦ Highlights the currently selected channel.
- ⑧ Appears when other programs (often short ones) have been scheduled for the period.

Information window

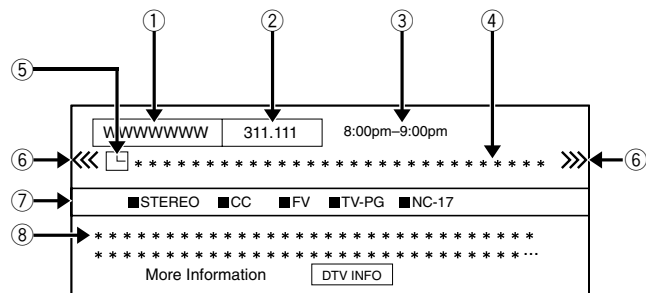

- ① Station name
- ② Channel number
- ③ Program time schedule
- ④ Program title
- ⑤ A blue icon appears when the program has been preset for auto channel select; and a red icon appears when it has been preset for recording.
- ⑥ Appears when other programs have been scheduled for the period. You will find this arrow only for programs with ▲ (⑧) shown on the schedule window.
- ⑦ Shows services available for the program and ratings for parent control.
- ⑧ Information about the program

NOTE

- The schedule window may show sections whose bottom right corners have been folded. This indicates that other programs (often short ones) have been scheduled for that period. To view the title of such a program and related information, highlight a folded section, and then press **←/→**.
- For programs whose title and/or time information have not been acquired, "No Title" appears.

Using the EPG

Use the following procedure to check the schedule of digital TV programs, view information about desired programs, and/or select programs to watch.

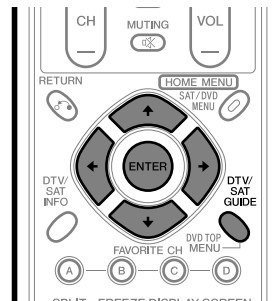

- 1 Press **DTV GUIDE**.
 - The EPG screen appears.
 - "Downloading EPG data now" appears on the picture window.
 - When EPG data acquisition is finished, the picture window shows moving images of a TV program watched when **DTV GUIDE** is pressed.
- 2 Press **↑/↓** and **←/→** to select a desired TV program.

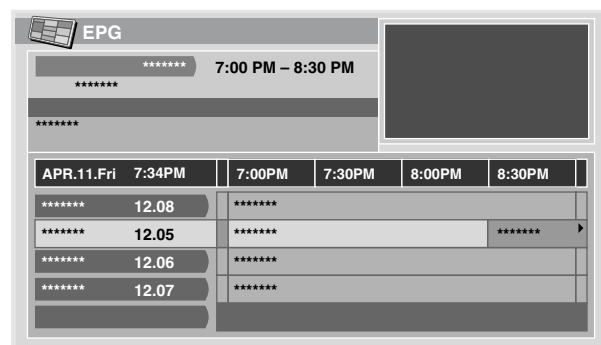

- Information about the selected program appears in the information window.
- To watch a program currently on air, select the program, and then press **ENTER**.
- You can check information about programs scheduled for up to 12 coming hours.
- Depending on conditions, it may take some time to acquire EPG data.

Electronic Program Guide (EPG) (for DTV Only)

10

- 3 To view more information (not current displayed) about the selected program, press **DTV INFO**.
- Detailed information appears on the schedule window.

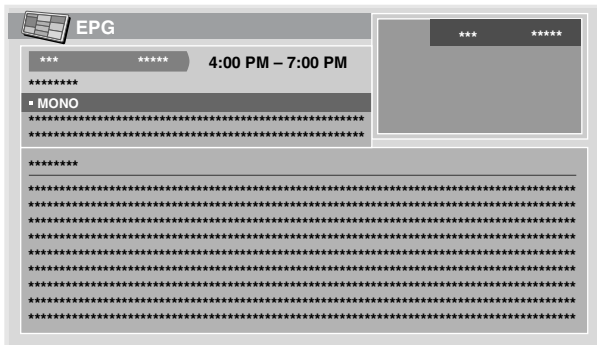

- With **▲/▼** shown in the schedule window, you can scroll the window by pressing **▲/▼**.
 - To quit display of detailed information, press **DTV INFO** again (or **RETURN**).
- 4 To quit the Program Guide, press **DTV GUIDE** again.

NOTE

- The schedule window does not show finished programs.
- When the power to the system is switched off, all acquired EPG data is cleared.

Presetting TV programs using the EPG

Using the EPG, you can easily preset digital TV programs for watching later (auto channel select), recording with a D-VHS recorder, or recording via a VCR controller.

Using auto channel select

With the power to the system left on, this function automatically selects the preset TV program when its on-air time comes. Then you will not miss watching an important TV program when you are enjoying another TV program.

- 1 Press **DTV GUIDE**.
 - The EPG screen appears.
- 2 Press **▲/▼** and **◀/▶** to select a program to be preset, and then press **ENTER**.
 - Select a program not yet started.
 - A setup menu appears.

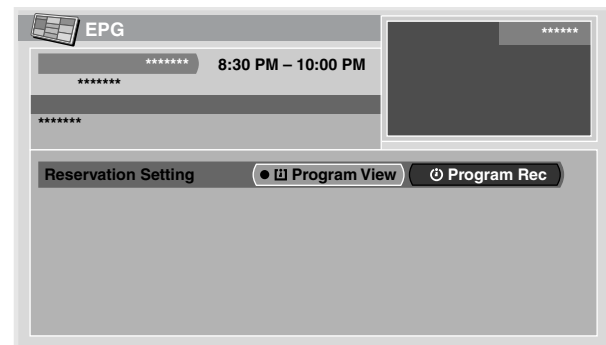

- 3 Press **◀/▶** to select "Program View", and then press **ENTER**.
 - A dialog box for confirmation appears.

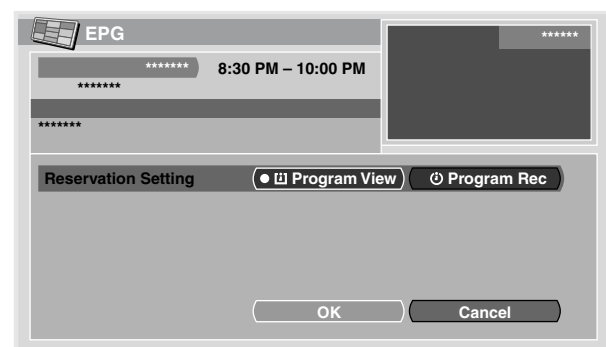

59

En

- 4 Press **←/→** to select "OK", and then press **ENTER**.
- The program is preset and the schedule table is restored.
 - A blue square icon appears for the preset program.
 - A black icon appears for overlapped presettings.

- 5 Press **DTV GUIDE** to exit the Program Guide.
- With the system switched on, a channel switch alarm message approximately 30 seconds before execution and the channel is switched a short time before the start of the program.

 **NOTE**

- Auto channel select is not executed when the system is in the standby mode.
- Finish presetting operations one minute before the start of the program; otherwise presettings may fail.
- For priorities about overlapped presettings, see "Priority rules for overlapped presettings" on page 63.

Recording TV programs using a D-VHS recorder

Use the following procedure to preset TV programs for recording with a connected D-VHS recorder.

- 1 Press **DTV GUIDE**.
 - The EPG screen appears.
- 2 Press **↑/↓** and **←/→** to select a program to be preset, and then press **ENTER**.
 - Select a program not yet started.
 - A setup menu appears.

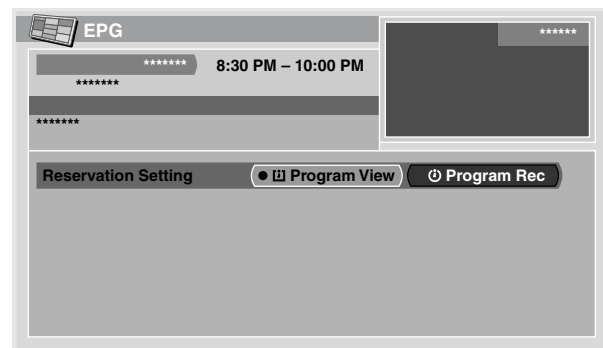

- 3 Press **←/→** to select "Program Rec", and then press **ENTER**.

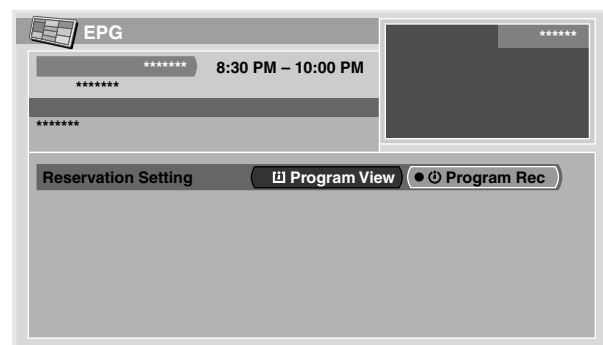

- A dialog box for mode selection appears.
- 4 Press **←/→** to select "i.LINK", and then press **ENTER**.

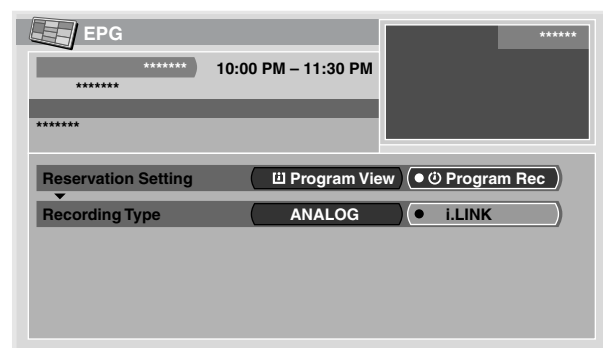

- A dialog box for model selection appears.

- 5 Press **←/→** to select the D-VHS recorder model, and then press **ENTER**.

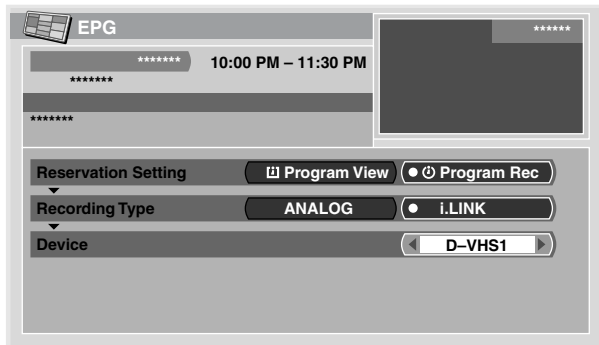

- A dialog box for confirmation appears.

- 6 Press **←/→** to select "OK", and then press **ENTER**.
- The program is preset and the schedule table is restored.
 - A red square icon appears for the preset program.
 - A black icon appears for overlapped presettings.

- 7 Press **DTV GUIDE** to exit the Program Guide.

NOTE

- Switch on the recording equipment at least 30 seconds before the start of the preset program; otherwise recording will not be executed.
- Recording is not executed if recordable D-VHS tape is not present in the D-VHS recorder when the preset program starts. This is also true when a D-VHS recorder specified for recording with a timer is not in connection.
- Finish presetting operations two minutes before the start of the program; otherwise presettings may fail.
- For priorities about overlapped presettings, see "Priority rules for overlapped presettings" on page 63.
- If you switch off the system using the **POWER** button, the program presetting will become ineffective. Be careful not to switch off the power.

Recording TV programs via a VCR controller

If you connect an appropriate VCR controller to the Media Receiver, you can preset digital TV programs for recording with a connected VCR. See page 78.

- 1 Press **DTV GUIDE**.
 - The EPG screen appears.
- 2 Press **↑/↓** and **←/→** to select a program to be preset, and then press **ENTER**.
 - A setup menu appears.

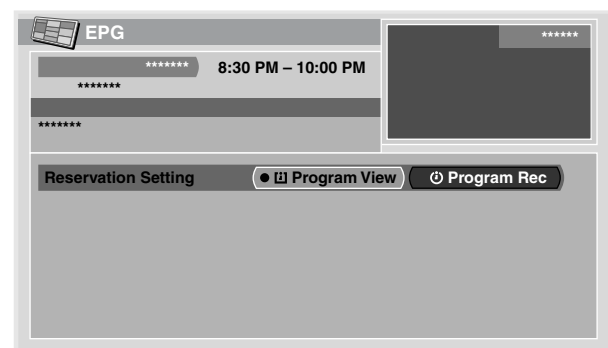

- 3 Press **←/→** to select "Program Rec", and then press **ENTER**.

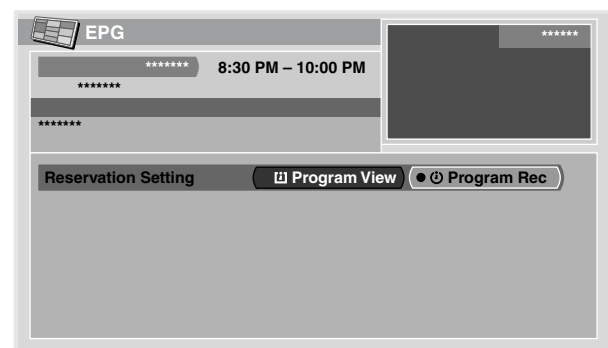

- A dialog box for mode selection appears.

- 4 Press \leftarrow/\rightarrow to select "ANALOG", and then press **ENTER**.

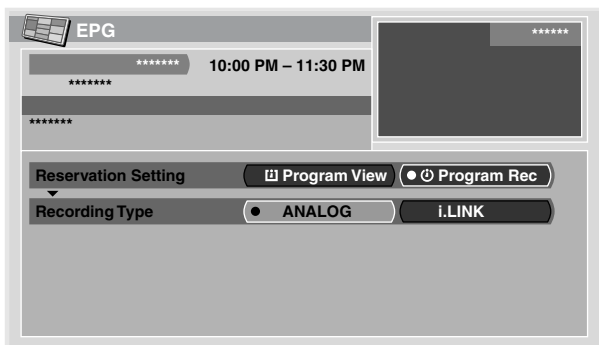

- A dialog box for confirmation appears.
- 5 Press \leftarrow/\rightarrow to select "OK", and then press **ENTER**.
- The program is preset and the schedule table is restored.
 - A red square icon appears for the preset program.
 - A black icon appears for overlapped presettings.
- 6 Press **DTV GUIDE** to exit the Program Guide.

NOTE

- Switch on the recording equipment at least 30 seconds before the start of the preset program; otherwise recording will not be executed.
- Finish presetting operations two minutes before the start of the program; otherwise presettings may fail.
- For priorities about overlapped presettings, see "Priority rules for overlapped presettings" on page 63.
- Confirm that the video output terminals on the Media Receiver have been connected to the signal input terminals on the VCR to be used for recording.
- If you switch off the system using the **POWER** button, the program presetting will become ineffective. Be careful not to switch off the power.

Setting the timer manually

Using the menu, you can also preset digital TV programs by specifying their scheduled date and time.

- 1 Press **HOME MENU**.
- 2 Press \uparrow/\downarrow to select "Rec/View Timer", and then press **ENTER**.
 - The schedule table appears.

The screenshot shows the Rec/View Timer menu with a table of 7 timer slots. The table has the following columns: Timer, Date, Start, Stop, Channel, Target, Information. The table is currently empty.

Timer	Date	Start	Stop	Channel	Target	Information
1	-/-	-:-	-:-	-:-	-:-	-:-
2	-/-	-:-	-:-	-:-	-:-	-:-
3	-/-	-:-	-:-	-:-	-:-	-:-
4	-/-	-:-	-:-	-:-	-:-	-:-
5	-/-	-:-	-:-	-:-	-:-	-:-
6	-/-	-:-	-:-	-:-	-:-	-:-
7	-/-	-:-	-:-	-:-	-:-	-:-

- 3 Press \uparrow/\downarrow to select a list number, then press \rightarrow .
 - You can select any desired list number.
- 4 Press \uparrow/\downarrow to specify a date, and then press \rightarrow .
- 5 Press \uparrow/\downarrow to specify the start hour, and then press \rightarrow .
- 6 Press \uparrow/\downarrow to specify the start minute, and then press \rightarrow .
- 7 Press \uparrow/\downarrow to specify the end hour, and then press \rightarrow .
- 8 Press \uparrow/\downarrow to specify the end minute, and then press \rightarrow .
- 9 Press \uparrow/\downarrow to specify a channel number, and then press \rightarrow .

- 10 Press **▲/▼** to select "VIEW", "ANALOG" or a D-VHS recorder, and then press **ENTER**.
- Select "VIEW" when presetting the program for auto channel select. Select "ANALOG" when presetting it for recording via a VCR controller. Select a D-VHS recorder when presetting it for recording with a D-VHS recorder.
 - In the Info field, "View OK" appears when presetting for auto channel select is accepted, and "Rec OK" appears when presetting for recording is accepted.

Timer	Date	Start	Stop	Channel	Target	Information
1	APR 11 FRI	9:30 PM	11:00 PM	E 12.05	VIEW	View OK
2	--/--	--:--	--:--	--:--	-----	-----
3	--/--	--:--	--:--	--:--	-----	-----
4	--/--	--:--	--:--	--:--	-----	-----
5	--/--	--:--	--:--	--:--	-----	-----
6	--/--	--:--	--:--	--:--	-----	-----
7	--/--	--:--	--:--	--:--	-----	-----

- 11 If presetting another program, press **▲/▼** to select another list number, and then repeat steps 4 to 6.
- You can preset up to 28 programs.

- 12 Press **HOME MENU** to exit the menu.

NOTE

- If the schedule of the selected program is overlapped with another presetting, "Overlap" appears in the Info field. Presettings with "Overlap" may not be partially or entirely executed.
- When entering into the schedule table, pressing **ENTER** causes the cursor to jump to an empty field.
- Presetting becomes ineffective if the start time and the end time are identical or if presetting operations are performed within two minutes before the start of the program.
- Presettings made using the EPG are automatically shown in the schedule table.
- For presetting made using the EPG, "E" appears beside the channel number in the schedule table. If you alter the presetting content, "E" disappears.
- For priorities about overlapped presettings, see "Priority rules for overlapped presettings" on page 63.
- If you switch off the system using the **POWER** button, the program presetting will become ineffective. Be careful not to switch off the power.

Priority rules for overlapped presettings

When preset TV programs are overlapped, the following three rules are used to determine a higher priority. If more than one of the three rules are met, the rules are applied in the order; 1, 2, then 3.

Rule 1: Presetting for recording is given a higher priority over presetting for auto channel select.

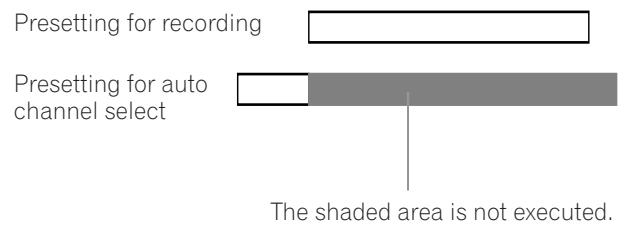

Rule 2: If two presettings are overlapped, presetting with earlier start time is given a higher priority. If two presettings are sequential, the last portion of the first program is not recorded for 15 seconds because recording of the second program is started at the exact start time.

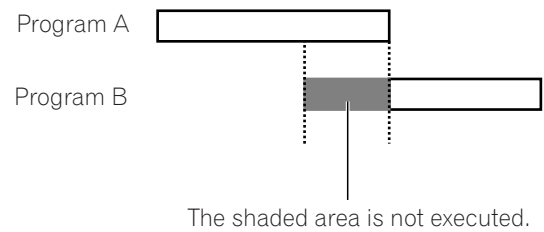

Rule 3: If presettings at the same start time are overlapped, presetting with a smaller list number is given a higher priority.

Changing/ canceling TV program presettings

Using the EPG

Use the following procedure to change or cancel program presettings using the EPG.

- 1 Press **DTV GUIDE**.
 - The EPG screen appears.
- 2 Press **▲/▼** and **◀/▶** to select the desired preset program, and then press **ENTER**.
 - A dialog box appears.
- 3 Press **◀/▶** to select "Edit" or "Delete", and then press **ENTER**.

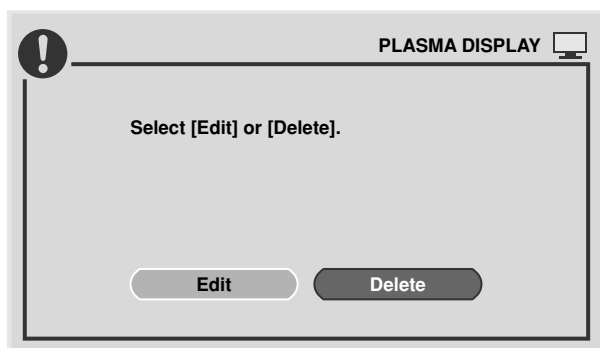

- If you select "Delete", the program presetting is canceled.
 - If you select "Edit", go to step 4.
- 4 Press **▲/▼** and **◀/▶** to make new selections, and then press **ENTER**.
 - A dialog box for confirmation appears.
 - 5 Press **◀/▶** to select "OK", and then press **ENTER**.

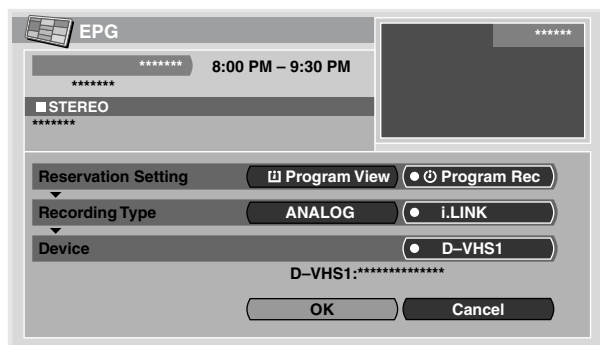

- The presetting is corrected and the schedule table is restored.

NOTE

- When you want to quit recording (in progress) started by program presetting, for example, to change the channel, cancel the program presetting using the menu. In this case, you cannot cancel the program presetting using the EPG.

Using the menu

Use the following procedure to change or cancel program presettings using the menu.

- 1 Press **HOME MENU**.
- 2 Press **▲/▼** to select "Rec/View Timer", and then press **ENTER**.
 - The schedule table appears.

Timer	Date	Start	Stop	Channel	Target	Information
1	--	--:--	--:--	--	-----	-----
2	--	--:--	--:--	--	-----	-----
3	--	--:--	--:--	--	-----	-----
4	--	--:--	--:--	--	-----	-----
5	--	--:--	--:--	--	-----	-----
6	--	--:--	--:--	--	-----	-----
7	--	--:--	--:--	--	-----	-----

- 3 Press **▲/▼** to select a list number to be changed.
- 4 Press **▶** to change the presetting or press **◀** (or **ENTER**) to cancel it.
 - If you press **◀** (or **ENTER**), the cursor moves to the Info field where "Delete" appears. Press **ENTER** to execute cancel.
 - If you press **◀**, go to step 5. Pressing **▶** with the cursor positioned at the Info field also allows you to go to step 5.
- 5 Press **◀/▶** to select a field to be corrected and press **▲/▼** to make a new entry.
- 6 Repeat step 4 to enter for all fields to be corrected.
- 7 Press **ENTER**.
 - "View OK" or "Rec OK" appears in the Info field.
- 8 Press **HOME MENU** to exit the menu.

Enjoying through External Equipment

11

You can connect many types of external equipment to your Plasma Display System, like a DVD player, VCR, personal computer, game console, and camcorder.

To view images coming from external equipment, select the input source using the **INPUT** buttons on the remote control (page 16) or the **INPUT** button on the Plasma Display.

CAUTION

- To protect all equipment, always turn off the system before connecting to a DVD player, VCR, personal computer, game console, camcorder, or other external equipment.

NOTE

- Refer to the relevant operation manual (DVD player, personal computer, etc.) carefully before making connections.

Watching a DVD image

Connecting a DVD player

Use the INPUT 1 terminals when connecting a DVD player and other audiovisual equipment.

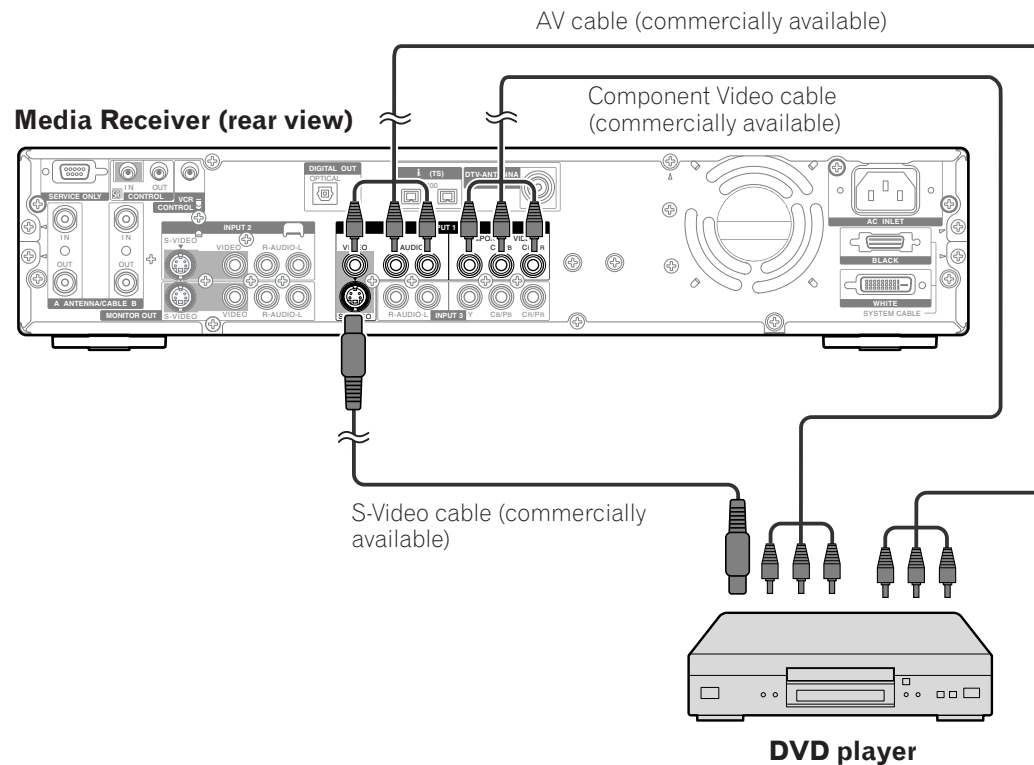

Displaying a DVD image

To watch a DVD image, press **INPUT 1** on the remote control unit or press **INPUT** on the Plasma Display to select INPUT1.

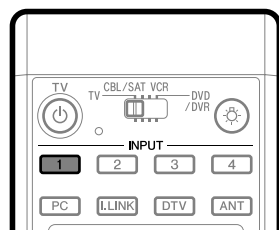

NOTE

- Refer to your DVD player operation manual for the signal type.
- The INPUT 1 terminals are checked for cable connections in the order where; 1) Component Video, 2) S-Video, 3) Video.
- Connect external equipment to only terminals that are to be actually used.
- You can also use the INPUT 3 terminals when connecting only with the Component Video output terminals on a DVD player.

65

En

Watching a VCR image

Connecting a VCR

Use the INPUT 2 terminals when connecting a VCR and other audiovisual equipment.

Media Receiver (rear view)

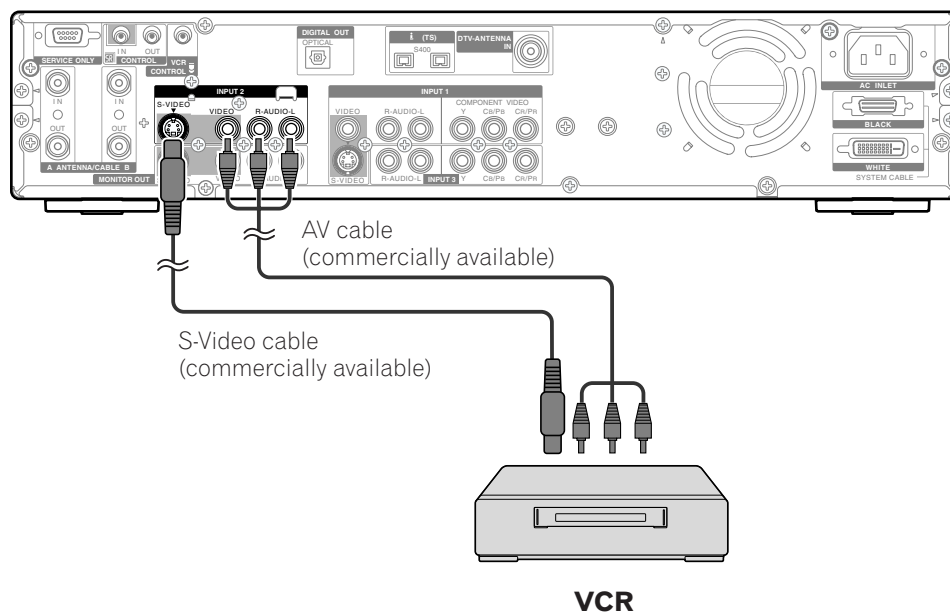

Displaying a VCR image

To watch a VCR image, press **INPUT 2** on the remote control unit or press **INPUT** on the Plasma Display to select INPUT2.

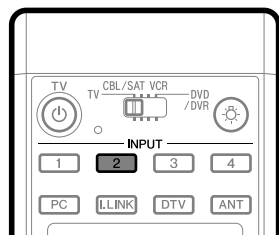

NOTE

- The INPUT 2 terminals are checked for cable connections in the order where; 1) S-Video, 2) Video.
- Connect external equipment to only terminals that are to be actually used.

Enjoying a game console or watching camcorder images

Connecting a game console or camcorder

Use the INPUT 4 terminals to connect a game console, camcorder and other audiovisual equipment.

Media Receiver (front view)

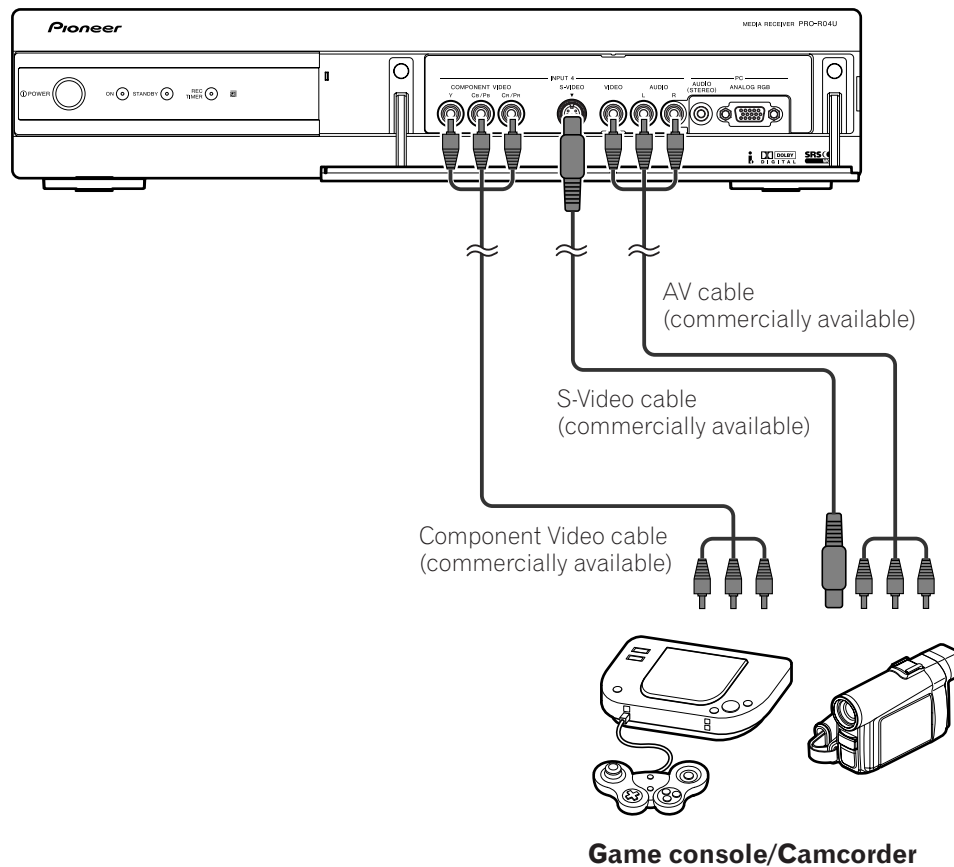

Game console/Camcorder

NOTE

- The INPUT 4 terminals are checked for cable connections in the order where; 1) Component Video, 2) S-Video, 3) Video.
- Connect external equipment to only terminals that are to be actually used.

Displaying an image of the game console or camcorder

To watch an image coming from the game console or camcorder, press **INPUT 4** on the remote control unit or press **INPUT** on the Plasma Display to select INPUT4.

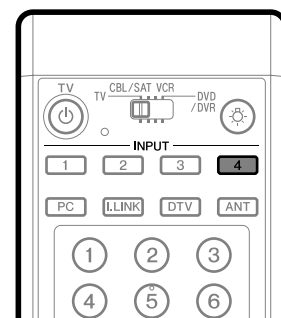

Recording digital TV programs using a VCR or DVD recorder

If you connect recording equipment such as a VCR or DVD recorder to the MONITOR OUT terminals on the rear of the Media Receiver, you can record, for example, digital TV programs using the recording equipment.

You can also record digital TV programs more easily by using the supplied VCR controller. Connect the VCR controller to the VCR control terminal on the rear of the Media Receiver and then position the controller so that its light emitting section faces the remote control sensor on the recording equipment. For more information, see page 78.

Connecting a recorder

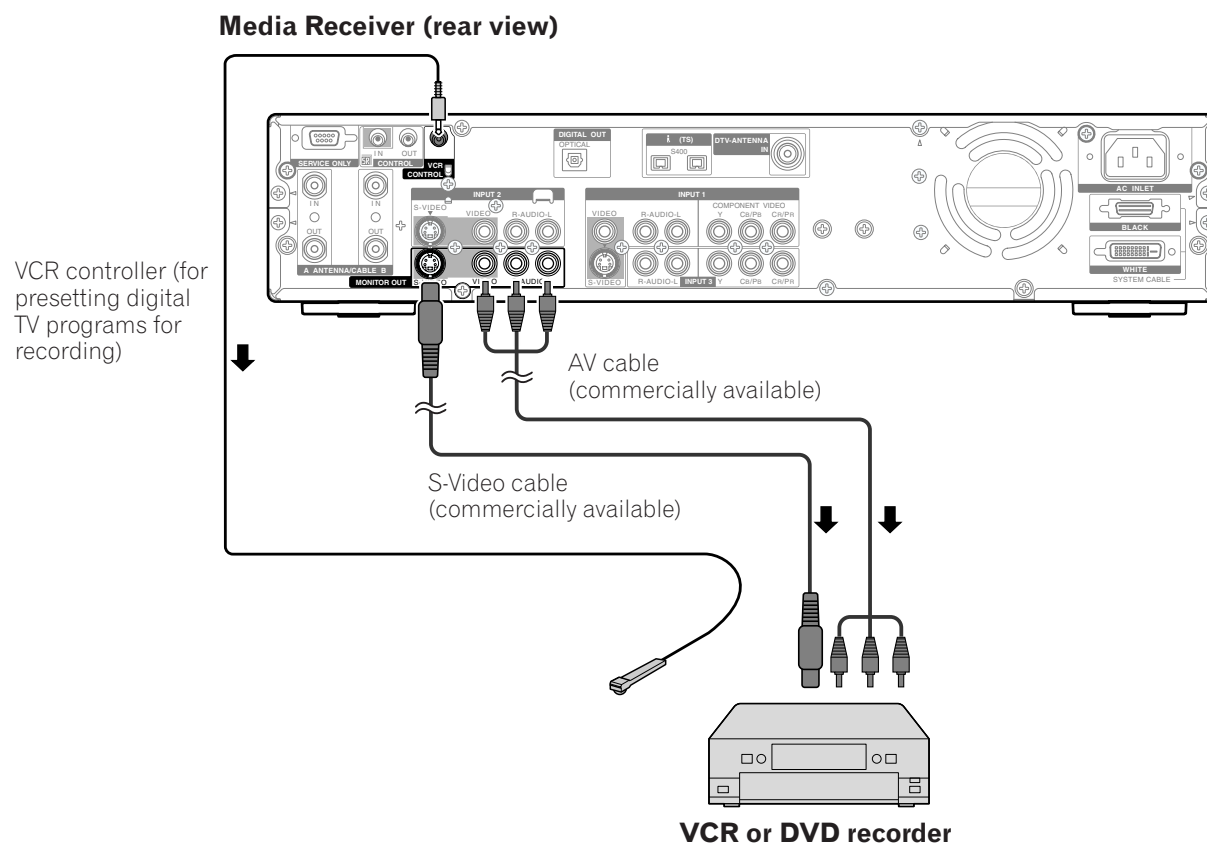

NOTE

- About the MONITOR OUT terminals

The MONITOR OUT terminals cannot output the following signals:

- ① Video signals input from the COMPONENT VIDEO terminal
- ② Video signals from a personal computer
- ③ S-Video signals when a conventional TV channel is being received
- ④ S-Video signals when Video signals (INPUT 1, 2, and 4) are being input

- When watching images played back on a VCR or DVD recorder connected to the MONITOR OUT terminals, select an input source (e.g., TV channel reception) on the recording equipment other than external input sources. Selecting an external input source may result in distorted images or noise.

Connecting other audio equipment

The digital audio output terminal (optical) on this system can output Dolby Digital signals. Using an optical digital cable, connect an AV receiver to the digital audio output terminal (optical) on the rear of the Media Receiver. This allows audio such as digital TV broadcasting to be played in high quality.

If your AV receiver does not have a digital audio input terminal (optical), connect the MONITOR OUT terminals (AUDIO) on the rear of the Media Receiver to the audio input terminals on the AV receiver.

NOTE

- When using the digital audio output terminal (optical), you need to make settings depending on your AV receiver. For more information, see the user's manual for the AV receiver.

Connecting an AV receiver

Media Receiver (rear view)

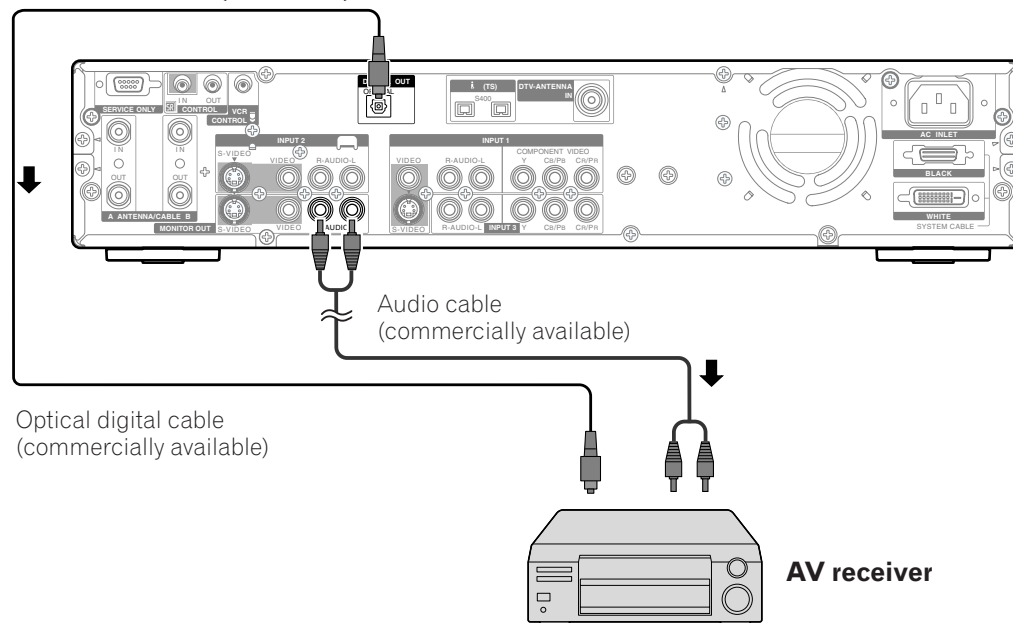

Switching the optical audio signal type

Set up for the DIGITAL AUDIO output terminal (OPTICAL), depending on your AV receiver.

- Press **HOME MENU**.
- Press **↑/↓** to select "DTV Setup", and then press **ENTER**.
- Press **↑/↓** to select "Digital Audio Out", and then press **ENTER**.

- Press **↑/↓** to select "Dolby Digital" or "PCM", and then press **ENTER**.



Item	Description
PCM (factory default)	Always outputs in the PCM format regardless of the types of signals.
Dolby Digital	For Dolby Digital encoded signals, outputs in the Dolby Digital format. For PCM encoded signals, outputs in the PCM format.

- Press **HOME MENU** to exit the menu.

Watching a D-VHS image

What is i.LINK?

i.LINK is a digital serial interface for handling digital video, digital audio, and other data in two directions. i.LINK is Sony's term for the IEEE 1394 data transport bus. Digital AV equipment compatible with i.LINK can be connected using a single i.LINK cable. The i.LINK interface allows this PDP system to control one of up to two i.LINK compatible devices (in connection) that can be identified.

Which i.LINK devices are connectable?

For i.LINK devices, this system supports only D-VHS recorders. The i.LINK terminals on this system cannot be connected with other equipment such as DVD recorders, digital video cameras, personal computers, and PC peripheral devices because of differences in the specifications.

What can be recorded through i.LINK?

With D-VHS recorders connected to this system through i.LINK, you can record only digital TV programs. You cannot record conventional TV channels nor contents coming from external input sources and personal computers.

Connecting D-VHS recorders

Use the i.LINK terminals when connecting D-VHS recorders.

When connecting a single D-VHS recorder

Media Receiver (rear view)

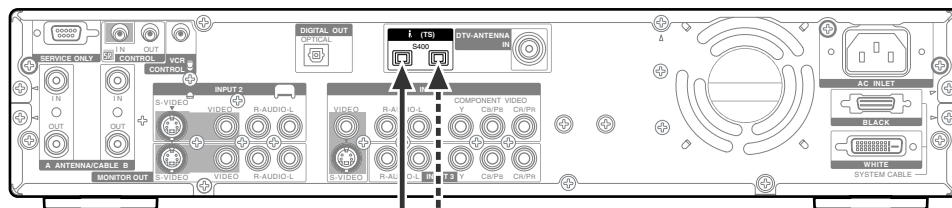

(The function and performance are the same for both terminals.)

i.LINK cable
(commercially available)



D-VHS recorder

To use i.LINK, you need to connect only an i.LINK cable; you need not connect cables to the video and audio terminals.

When connecting two D-VHS recorders

You can connect two D-VHS recorders directly to the i.LINK terminals on the rear of the Media Receiver.

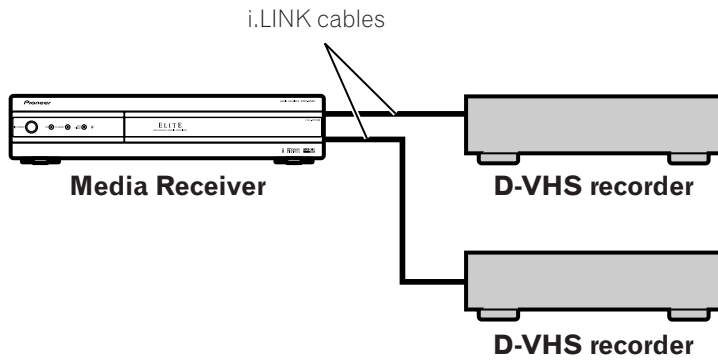

Using i.LINK cables you can also connect up to two D-VHS recorders in a daisy chain.

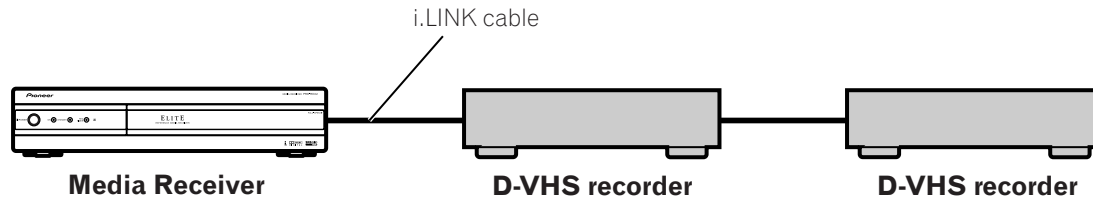

Precautions about i.LINK connections

- Use S400 i.LINK cables that have 4-pin plugs and are shorter than 3.5 m (11.48 feet).
- Some i.LINK devices cannot relay data when their power is off.
- Do not make the following loop connections:

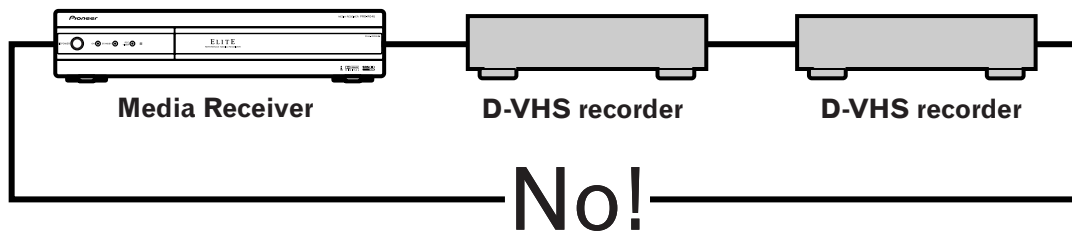

Displaying a D-VHS image

To watch a D-VHS image, press **i.LINK** on the remote control unit or press **INPUT** on the Plasma Display to select i.LINK.

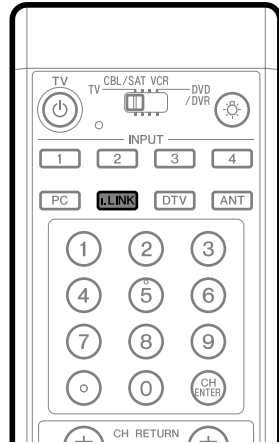

Useful and important notification

Useful information

- D-VHS recorders connected through i.LINK can play back digital TV programs recorded using this system.
- D-VHS recorders connected through i.LINK can record only digital TV programs. Using i.LINK, those recorders cannot record conventional TV channels nor contents coming from external input sources.
- This system can be simultaneously connected with up to two D-VHS recorders that support i.LINK. You can control one of these D-VHS recorders (basic functions only).
- Some D-VHS recorders connected through i.LINK may not allow this system to control through the control panel screen or to display images and output sound.
- To record digital TV programs using connected D-VHS recorders, use D-VHS tape. You cannot use VHS tape nor S-VHS tape.
- Some D-VHS recorders connected though i.LINK may not allow this system to play back images and sound recorded on VHS tape, S-VHS tape, or (if with analog signals) D-VHS tape. If this is the case, connect the analog output terminals on the D-VHS recorder to INPUT 1, 2, 3, or 4 terminals on this system. See pages 65 to 67.
- This system supports the Digital Transmission Content Protection (DTCP) technology. The DTCP is a copy protection technology that presents data coding and device authentication.
- i.LINK may not allow copy-restricted video, audio, and other data to be copied from one i.LINK device to another. It also may not allow video, audio, and other data to be transferred with equipment that does not support the DTCP.

Precautions

- While one D-VHS recorder connected through i.LINK is recording or playing back, do not switch on or off the other connected D-VHS recorder (not in use) or do not connect or disconnect the i.LINK cable from that D-VHS recorder. Doing so can result in image and sound interruption.
- Some D-VHS recorders that support i.LINK cannot relay data when their power is off. Check the user's manual for your D-VHS recorder. This system allows you to change the setting for data relay in the standby mode. See "Setting up for i.LINK standby" on page 76.

Setting up for controlling a D-VHS recorder

You can operate the connected D-VHS recorder from the Plasma Display that shows the control panel screen. After making the connections, use the menu to specify the model of the D-VHS recorder to be operated. You can operate only a single D-VHS recorder from the Plasma Display.

- 1 Press **HOME MENU**.
- 2 Press **▲/▼** to select "DTV Setup", and then press **ENTER**.
- 3 Press **▲/▼** to select "i.LINK Setup", and then press **ENTER**.
- 4 Press **▲/▼** to select "i.LINK List", and then press **ENTER**.
 - The list of the registered D-VHS recorders (i.LINK list) appears.

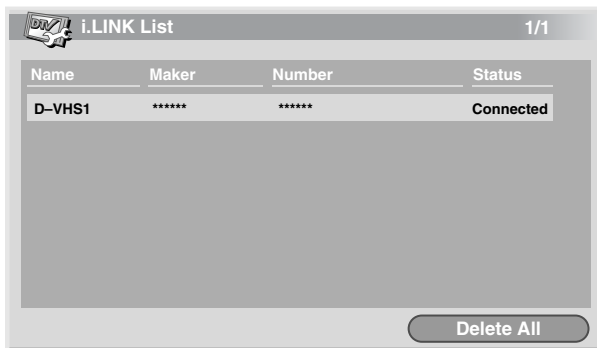

- 5 Press **▲/▼** to select the D-VHS recorder model to be operated, and then press **ENTER**.

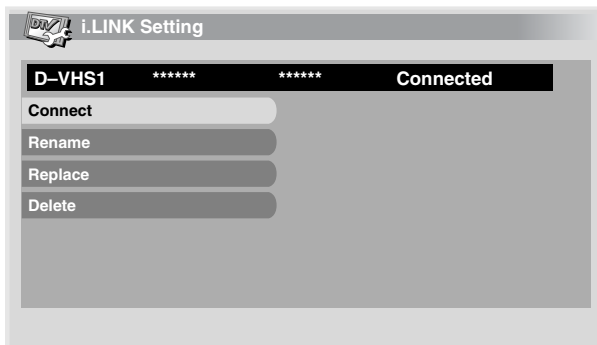

- 6 Press **▲/▼** to select "Connect", and then press **ENTER**.
- 7 Press **HOME MENU** to exit the menu.

NOTE

- The following information appears at the right end of the i.LINK list to indicate the connection status of the D-VHS recorders:

Control: Data connection with the D-VHS recorder has been established and the recorder is ready for control.

Connected: The D-VHS recorder has been physically connected, and can be controlled if it is selected for control.

Other: Equipment other than a D-VHS recorder has been physically connected and thus cannot be controlled.

—: Currently not physically connected

Operating the control panel screen

The control panel screen appears when you press **i.LINK**. It disappears when you press **i.LINK** again. To select a button on the control panel screen, press **▲/▼** or **◀/▶**, and then press **ENTER** on the remote control.

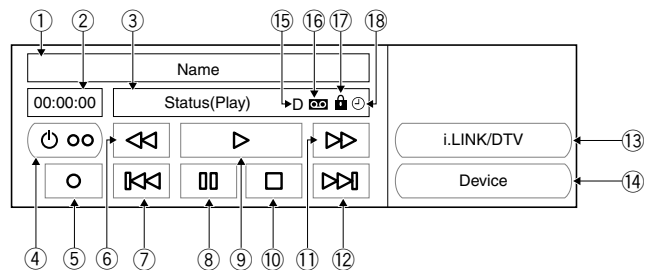

- ① Shows the model and manufacture name of the D-VHS recorder to be operated.
- ② Shows counter time output by the D-VHS recorder.
- ③ Shows the current status of the D-VHS recorder.
- ④ Switches on and off the D-VHS recorder.
- ⑤ Starts recording.
- ⑥ Rewinds the tape.
- ⑦ Rewinds to the start of the current program.
- ⑧ Pauses the tape.
- ⑨ Starts playing back.
- ⑩ Stops the current tape motion.
- ⑪ Forwards the tape.
- ⑫ Forwards to the start of the next program.
- ⑬ Switches the input source between i.LINK and DTV.
- ⑭ Allows you to change the D-VHS recorder to be operated. After pressing this button, press **▲/▼** to select the desired model from the list, and then press **ENTER**.
- ⑮ Shows the type of inserted video tape; D for D-VHS, S for S-VHS, and no display for VHS.
- ⑯ Appears when any tape has been inserted.
- ⑰ Appears when the inserted tape has been write protected. The inserted tape cannot be used for recording when this indicator appears.
- ⑱ Appears when the D-VHS recorder has been preset for recording and is in the standby mode.

NOTE

- If no i.LINK device has been connected, "No i.LINK devices are connected." appears. If this is the case, connect i.LINK devices.
- If none of the connected equipment has been supported for control, you cannot execute control.

Editing the i.LINK list

The i.LINK list shows all devices connected through i.LINK interfaces. In this list, you can change the name or order of devices or delete device information.

To change the name of a device:

- 1 Press **▲/▼** to select the desired device from the list, and then press **ENTER**.
- 2 Press **▲/▼** to select "Rename", and then press **ENTER**.

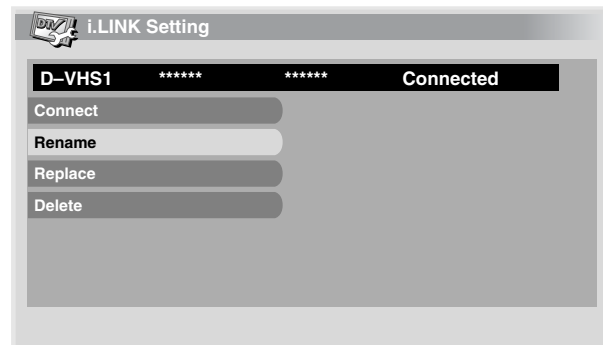

- 3 Press **▲/▼** to change the character for the first digit.



- You can select A to Z, 0 to 9, special codes, and space in the order.

- 4 Press **◀/▶** to move the cursor to the second digit.
- 5 Press **▲/▼** to change the character for the second digit.
- 6 Repeat steps 3 and 4 to enter up to eight digits, and then press **ENTER**.
- 7 Press **◀/▶** to select OK, and then press **ENTER**.

Enjoying through External Equipment

11

To change the order of devices:

- 1 Press **▲/▼** to select the desired device from the list, and then press **ENTER**.
- 2 Press **▲/▼** to select "Replace", and then press **ENTER**.

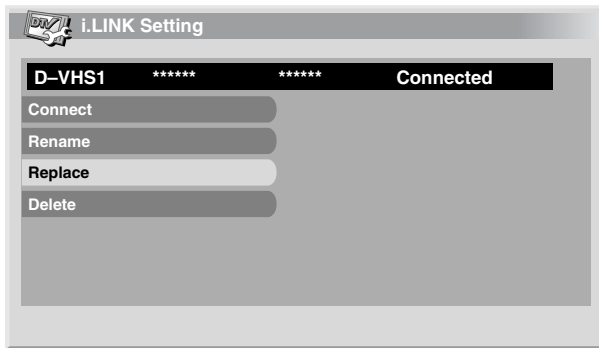

- 3 Press **▲/▼** to select the new desired position, and then press **ENTER**.

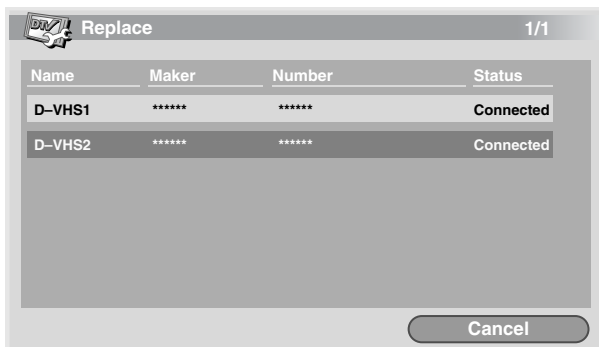

- The selected device is moved to the selected position.

To delete information about a single device:

- 1 Press **▲/▼** to select the desired device from the list, and then press **ENTER**.
- 2 Press **▲/▼** to select "Delete" and then press **ENTER**.

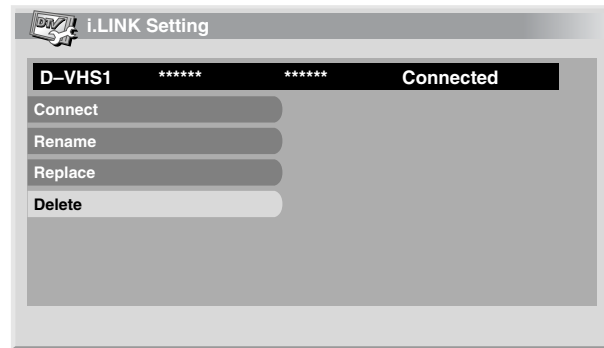

- A confirmation message appears.
- A warning message appears if the selected device has been preset for recording with the timer or if its power is on. If this is the case, you cannot delete the device that you have selected.

- 3 Press **←/→** to select "Delete", and then press **ENTER**.

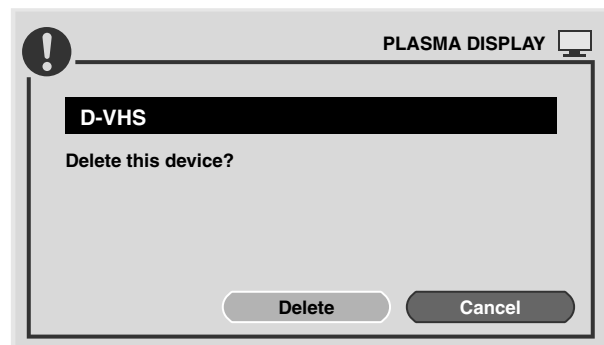

- A confirmation message appears.

- 4 Press **←/→** to select "Delete", and then press **ENTER**.

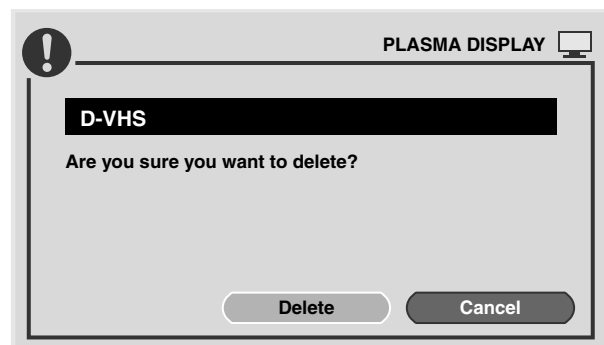

75

En

11 Enjoying through External Equipment

To delete information about all devices:

- 1 Press **→** to select "Delete All", and then press **ENTER**.
- 2 Press **←/→** to select "Yes" and then press **ENTER**.

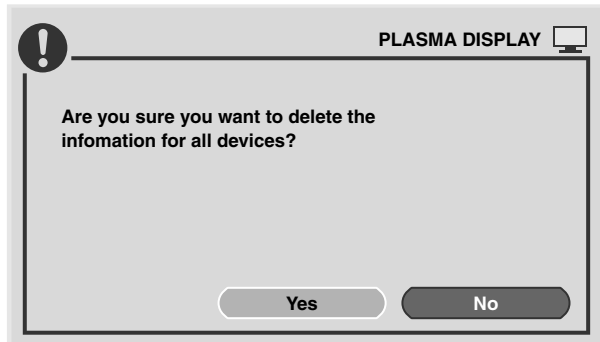

- A confirmation message appears.
- A warning message appears if the selected device has been preset for recording with the timer or if its power is on. If you delete a device that has been preset for recording, its all presettings are deleted.

- 3 Press **←/→** to select "Yes", and then press **ENTER**.

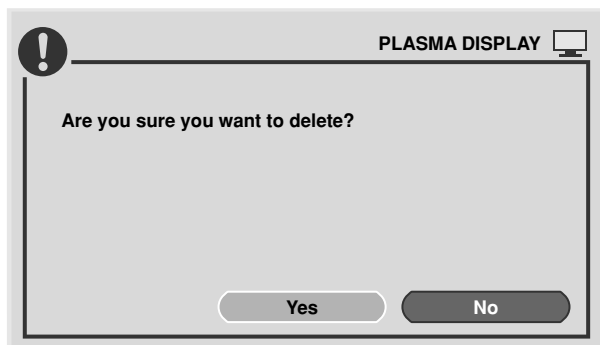

- A confirmation message appears.

- 4 Press **ENTER** to exit the menu.

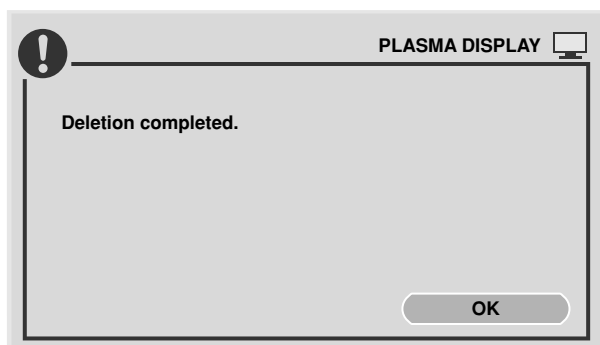

Setting up for i.LINK standby

Use the following procedure to enable data transfer between multiple i.LINK devices even when the system is in the standby mode.

- 1 Press **HOME MENU**.
- 2 Press **↑/↓** to select "DTV Setup", and then press **ENTER**.
- 3 Press **↑/↓** to select "i.LINK Setup", and then press **ENTER**.
- 4 Press **↑/↓** to select "i.LINK Standby", and then press **ENTER**.
- 5 Press **↑/↓** to select "Enable", and then press **ENTER**.

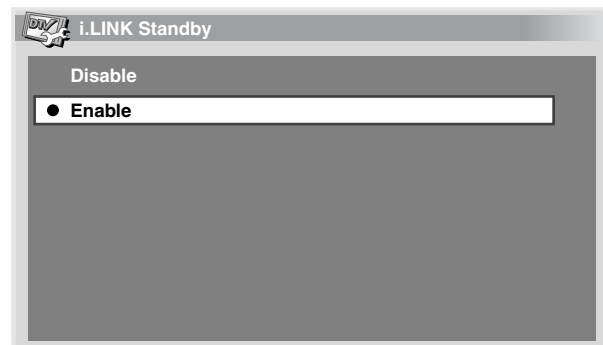

- 6 Press **HOME MENU** to exit the menu.

NOTE

- With "Enable" selected, the system relays data between multiple i.LINK devices even when in the standby mode; the i.LINK circuits are energized in that mode.
- With "Disable" (factory default) selected, less power is consumed when the system is in the standby mode; however the system does not relay data between multiple i.LINK devices. When i.LINK devices are not in connection, select "Disable", resulting in less power consumption.

In standby mode

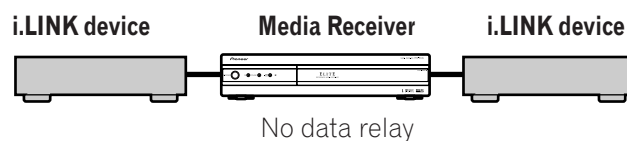

Watching an image from a personal computer

Connecting a personal computer

Use the PC terminals to connect a personal computer.

NOTE

- The PC input terminals are DDC1/2B-compatible.
- Refer to page 107 for a list of personal computer signals compatible with the Plasma Display System.

Media Receiver (front view)

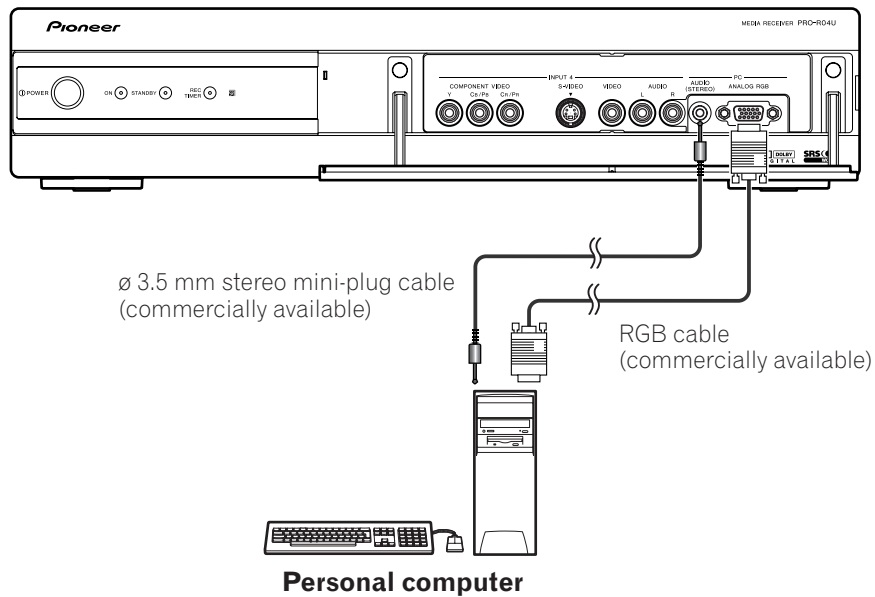

Displaying an image from a personal computer

When connecting to a personal computer, the input signal type is automatically identified. If the personal computer image does not come in clearly, you may need to use Auto Setup in the menu. See page 81.

To watch an image coming from the personal computer, press **PC** on the remote control unit or press **INPUT** on the Plasma Display to select "PC".



NOTE

- The PC terminals cannot be used for audiovisual equipment.

Signal names for 15-pin mini D-sub connector

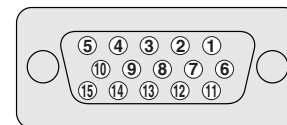

(front view)

Pin No.	Signal name
①	R
②	G
③	B
④	Not connected
⑤	Not connected
⑥	GND (ground)
⑦	GND (ground)
⑧	GND (ground)
⑨	+5V
⑩	GND (ground)
⑪	Not connected
⑫	SDA
⑬	HD
⑭	VD
⑮	SCL

NOTE

- A Macintosh adaptor may be required for use with some Macintosh computers.

11 Enjoying through External Equipment

Connecting a VCR controller

Connect the supplied VCR controller to the Media Receiver. This allows you to preset digital TV programs for recording, using the Electronic Program Guide. When the specified time comes, the system in the standby mode is automatically switched on and the specified TV program is recorded using the connected VCR or DVD recorder.

NOTE

- Make sure to leave the VCR power on when presetting TV programs for recording with the VCR controller.
- Be sure to firmly connect the VCR controller to the VCR control terminal on the rear of the Media Receiver. If you have mistakenly connected it to the CONTROL IN or CONTROL OUT terminal, remote control or other operations may be disabled.

Media Receiver (rear view)

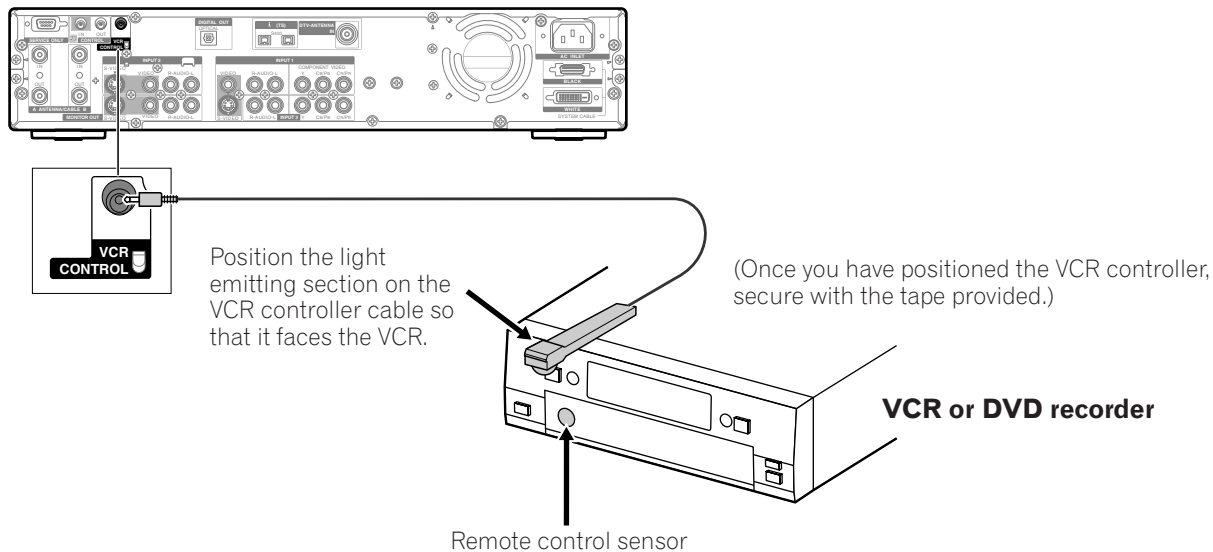

Use the following procedure to set the manufacture of the recording equipment:

- 1 Press **HOME MENU**.
- 2 Press **▲/▼** to select "DTV Setup", and then press **ENTER**.
- 3 Press **▲/▼** to select "VCR Control", and then press **ENTER**.
- 4 Press **▲/▼** to select the manufacture of the recording equipment, and then press **ENTER**.

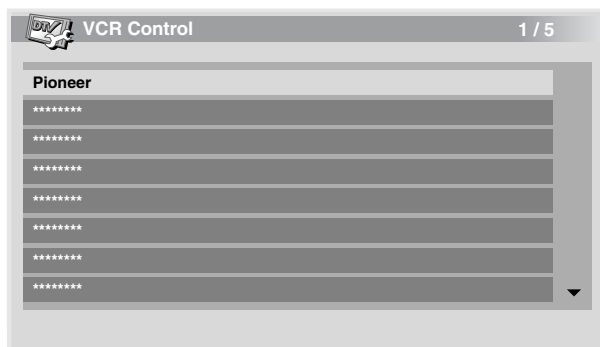

- The screen for recording test appears.

- 5 Check that the power to the recording equipment is on, and insert tape into the slot.
 - Insert tape you think it all right to erase its contents. The contents will be erased because Rec and Stop codes are output in the test.
 - Check that the light emitting section on the VCR controller cable faces the recording equipment.
- 6 Press **ENTER** to execute recording test.
 - If the recording equipment fails to start and stop recording, check and change the specified recording equipment manufacture.
- 7 Press **▲/▼** to select "YES", and then press **ENTER**.
- 8 Press **HOME MENU** to exit the menu.

NOTE

- Even if you correctly specify the manufacture of the recording equipment, control of some models may be disabled.
- Perform the recording test when the recording equipment is not in recording standby or is not recording.
- The recording test takes approximately 10 seconds.
- The PIONEER 1 (DVD recorder) has been set as the factory default.

The lists of controllable recording equipment manufactures

Manufacture	Remote control type
PIONEER	1-5
PANASONIC	1-7
PHILIPS	1-6
SHARP	1-5
TOSHIBA	1-4
SAMSUNG	1-6
FISHER	1-3
GOLDSTAR	1
HITACHI	1, 2
MAGNAVOX	1
MITSUBISHI	1-7
RCA	1-6
SANYO	1-3
SONY	1-3
JVC	1-4
ZENITH	1
GRANDIENTE	1
AKAI	1
MATSUI	1
AIWA	1
ALBA	1, 2
BUSH	1
THOMSON	1
BAIRD	1
TELEFUNKEN	1
Grundig	1-3
MARANTZ	1-2
GE	1-3
YAMAHA	1-4
CURTIS MATHIS	1-3
FUNAI	1
ADMIRAL	1
KENWOOD	1-3
NEC	1, 2
WARDS	1-4
MEMOREX	1, 2
JC PENNY	1-6

Some modes of the listed manufactures may not allow control through the VCR controller.

11 Enjoying through External Equipment

Connecting control cords

Connect control cords between the Media Receiver and other PIONEER equipment having the **SR** logo. You can then operate the connected equipment by sending commands from its remote control unit to the remote control sensor on the Media Receiver.

After the CONTROL IN terminals have been connected, the remote control sensors on the connected equipment do not accept commands from the remote control units. Face the remote control units to the remote control sensor on the Plasma Display when operating the connected equipment.

NOTE

- Make sure that the power is turned off when making connections.
- Complete all component connections before making control cord connections.

About SR+

The CONTROL OUT terminal on the rear of the Media Receiver supports **SR+** that allows linked operations with a PIONEER AV receiver. **SR+** presents functions such as the input switch linkage operation function and the DSP surround mode display function. For more information, see the user's manual for the PIONEER AV receiver supporting **SR+**.

NOTE

- While in connection through **SR+**, the volume on this system is temporarily minimized.

Media Receiver (rear view)

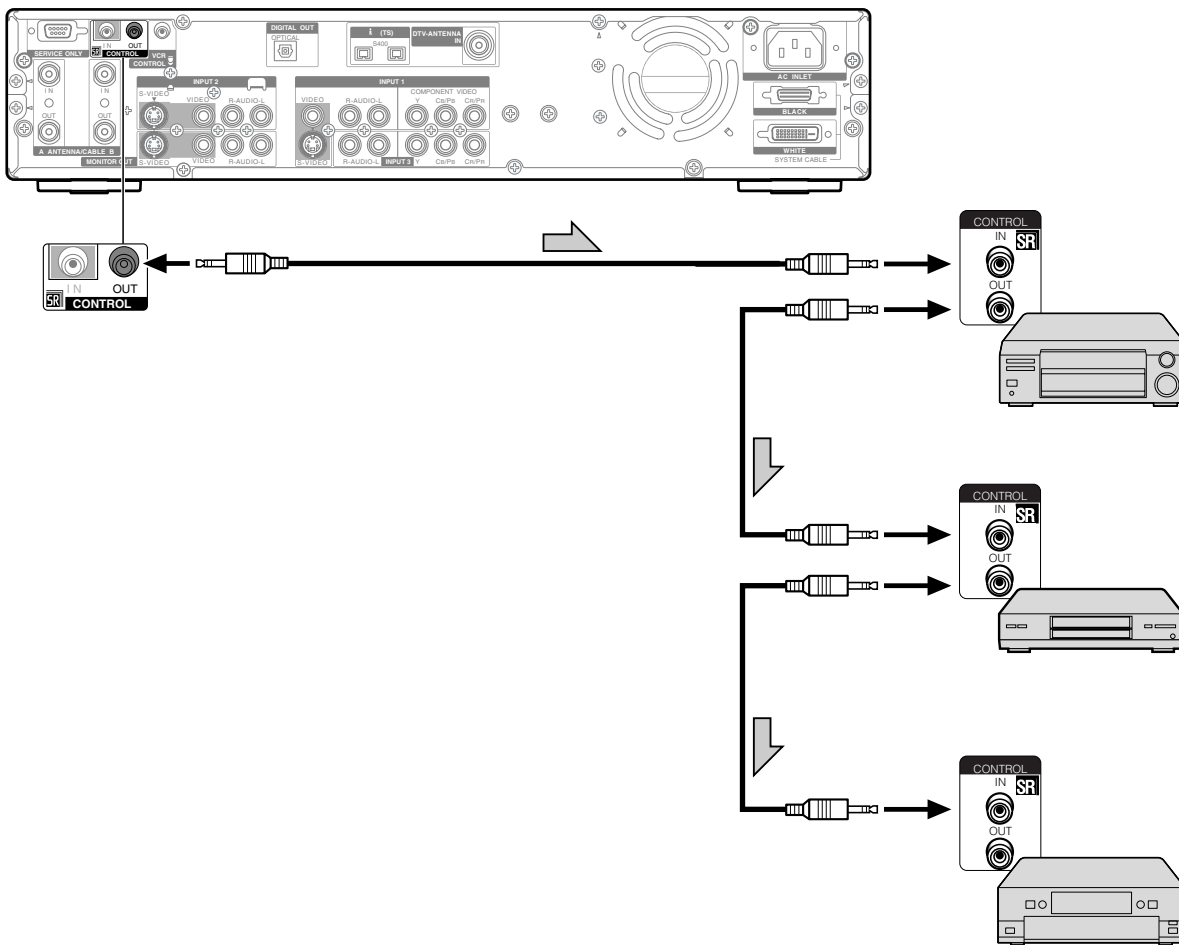

The control cables (commercially available) are mono sound cables with mini plugs (no resistance).

Adjusting image positions (AV mode only)

Adjust the horizontal and vertical positions of images on the Plasma Display.

- 1 Press **HOME MENU**.
- 2 Press **▲/▼** to select "Option", and then press **ENTER**.
- 3 Press **▲/▼** to select "Position", and then press **ENTER**.
- 4 Press **▲/▼** to select "H/V Position Adjust", and then press **ENTER**.

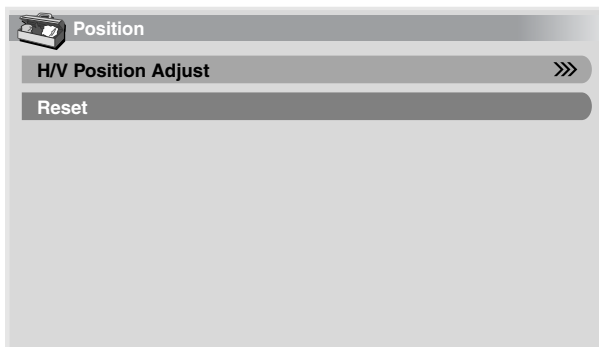

- 5 Press **▲/▼** to adjust the vertical position or press **◀/▶** to adjust the horizontal position.

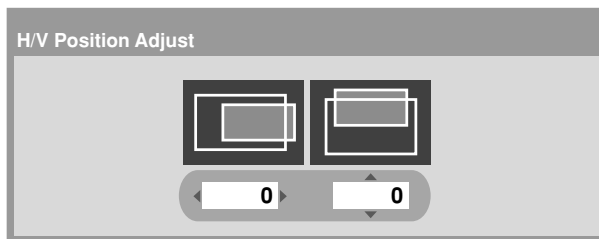

- 6 Press **HOME MENU** to exit the menu.

NOTE

- To restore the factory defaults for all the items, press **▲/▼** to select "Reset" in step 4, and then press **ENTER**. A confirmation screen appears. Press **▲/▼** to select "Yes", and then press **ENTER**.
- Adjustments are stored separately according to input source.

Adjusting image positions and clock automatically (PC mode only)

Use Auto Setup to automatically adjust positions and clock of images coming from a personal computer.

- 1 Press **HOME MENU**.
- 2 Press **▲/▼** to select "Option", and then press **ENTER**.
- 3 Press **▲/▼** to select "Auto Setup", and then press **ENTER**.

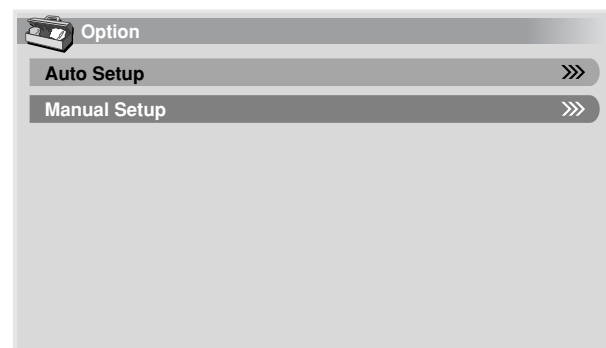

- Auto Setup starts.

- 4 Press **HOME MENU** to exit the menu.

NOTE

- When Auto Setup is finished, "Auto Setup completed." appears.
- Even when "Auto Setup completed." appears, Auto Setup may have failed, depending on conditions.
- Auto Setup may fail with a PC image composed of similar patterns or monochrome. If not successful, change the PC image and try again.
- Be sure to connect the computer to the Media Receiver and switch it on before starting Auto Setup.

Adjusting image positions and clock manually (PC mode only)

Usually you can easily adjust the positions and clock of images using Auto Setup. Use Manual Setup to optimize the positions and clock of images when necessary.

- 1 Press **HOME MENU**.
- 2 Press **▲/▼** to select "Option", and then press **ENTER**.
- 3 Press **▲/▼** to select "Manual Setup", and then press **ENTER**.
- 4 Press **▲/▼** to select the item to be adjusted, and then press **ENTER**.

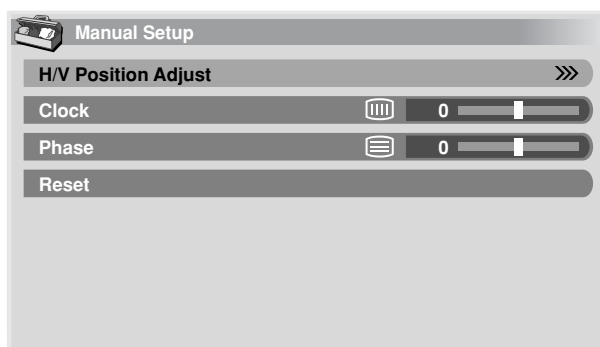

- 5 Press **←/→** (and **▲/▼**) to perform adjustment.
 - Use **▲/▼** only when you adjust the vertical position after selecting "H/V Position Adjust".
- 6 Press **HOME MENU** to exit the menu.

NOTE

- To restore the factory defaults for all the items, press **▲/▼** to select "Reset" in step 4, and then press **ENTER**. A confirmation screen appears. Press **▲/▼** to select "Yes", and then press **ENTER**.

AV mode

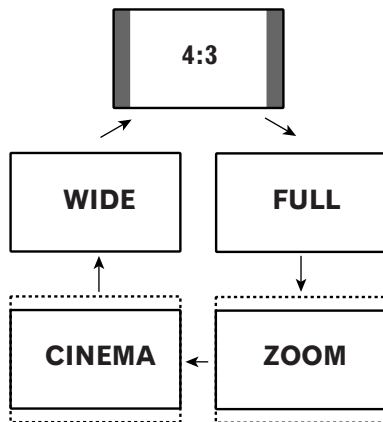

PC mode except for XGA signals

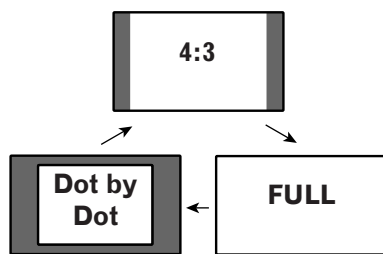

PC mode for XGA signals

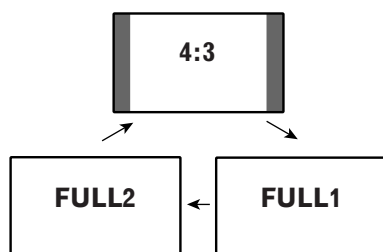

Selecting a screen size

Press **SCREEN SIZE** to switch among the screen size options selectable for the type of video signals currently received.

- Each time you press **SCREEN SIZE**, the selection is switched.
- The selectable screen sizes differ depending on the types of input signals.

AV mode

Item	Description
4:3	For 4:3 "standard" pictures. A side bar appears on each side.
FULL	For 16:9 squeeze pictures.
ZOOM	For 16:9 letterbox pictures. Bars may appear on the top and bottom with some programs.
CINEMA	For 14:9 letterbox pictures. Bars may appear on the top and bottom on some programs.
WIDE	In this mode pictures are progressively stretched toward each side of the screen.

PC mode except for XGA signals

Item	Description
4:3	Fills the screen without altering the input signal aspect ratio.
FULL	Full 16:9 screen display
Dot by Dot	Matches input signal with same number of screen pixels.

PC mode for XGA signals

(Ex. 1024 × 768 input at PRO-1110HD)

Item	Description
4:3	Matches input signal with the same number of screen pixels. Optimized for 1024 × 768 display
FULL1	Full 16:9 screen display Optimized for 1024 × 768 display
FULL2	For wide signal display Use when displaying 1280 × 768 signal resolution.

NOTE

- The PC mode above is for the PRO-1110HD. For the PRO-910HD the number of panel pixels is different, so signal processing and actual viewing conditions will vary slightly.

Changing the brightness at both sides of the screen (Side Mask)

With the 4:3 screen size selected for the AV mode, you can change the brightness of the gray side masks that appear at both sides of the screen.

- 1 Press **HOME MENU**.
- 2 Press **▲/▼** to select "Option", and then press **ENTER**.
- 3 Press **▲/▼** to select "Side Mask", and then press **ENTER**.
- 4 Press **▲/▼** to select the desired parameter, and then press **ENTER**.

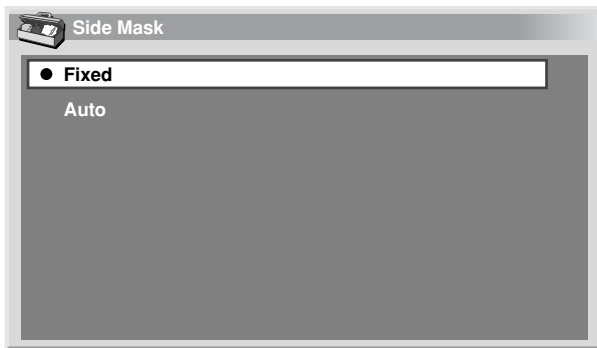

Item	Description
Fixed (factory default)	Always sets the same brightness for the gray side masks.
Auto	Adjusts the brightness of the gray side masks according to the brightness of images.

- 5 Press **HOME MENU** to exit the menu.

Sleep Timer

When the selected time elapses, the Sleep Timer automatically places the system into the standby mode. Press **SLEEP** to select the desired time.

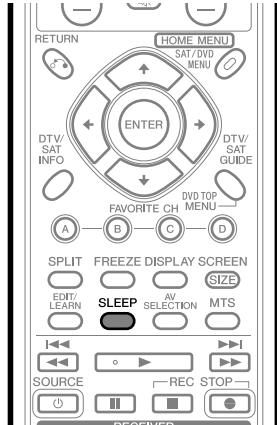

- The timer starts counting.
- Each time you press **SLEEP**, the selection is switched as below:

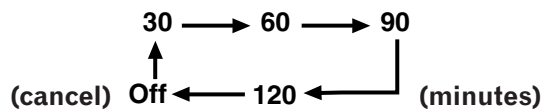

- The factory default is "Off".

NOTE

- To cancel the Sleep Timer, select "Off" by pressing **SLEEP**.
- Five minutes before the selected time elapses, the remaining time appears every minute.

You can also use the menu to set the Sleep Timer.

- 1 Press **HOME MENU**.
- 2 Press **▲/▼** to select "Sleep Timer", and then press **ENTER**.
- 3 Press **▲/▼** to select the desired time, and then press **ENTER**.

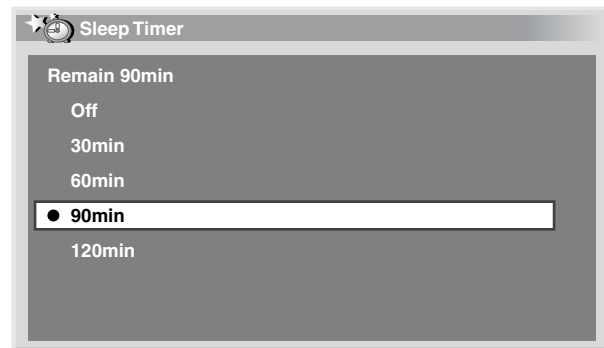

- 4 Press **HOME MENU** to exit the menu.

Closed caption for conventional TV channels

Your Plasma Display System is equipped with an internal closed caption decoder. Closed caption is a system which allows you to view conversations, narration, and sound effects in TV programs and home videos as subtitles on your Plasma Display screen.

- Not all programs and videos offer closed caption. Please look for the "CC" symbol to ensure that captions will be shown.

Activating the closed caption

- 1 Press **HOME MENU**.
- 2 Press **▲/▼** to select "Setup", and then press **ENTER**.
- 3 Press **▲/▼** to select "Closed Caption", and then press **ENTER**.
- 4 Press **▲/▼** to select "Setting", and then press **ENTER**.
- 5 Press **▲/▼** to select "On" or "On If Mute", and then press **ENTER**.

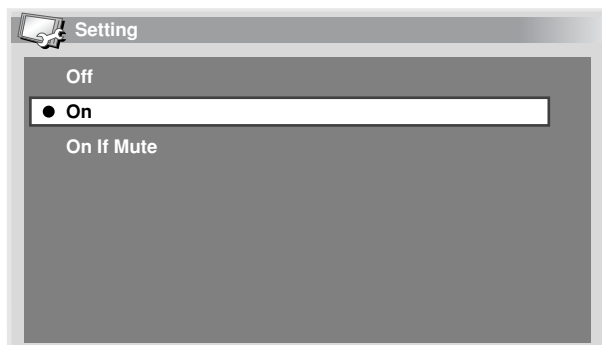

Item	Description
Off (factory default)	Does not show closed captions.
On	Always shows closed captions.
On If Mute	Shows closed captions only while sound is being muted.

- 6 Press **HOME MENU** to exit the menu.

Selecting the type of closed captions

- "CC-1" or "CC-2" displays subtitles of TV dramas and news programs while allowing a full view of the picture.
- "T1" or "T2" superimposes on the picture other information (e.g. TV guide, weather) that is independent of the TV in progress.

- 1 Press **HOME MENU**.
- 2 Press **▲/▼** to select "Setup", and then press **ENTER**.
- 3 Press **▲/▼** to select "Closed Caption", and then press **ENTER**.
- 4 Press **▲/▼** to select "Channel", and then press **ENTER**.
- 5 Press **▲/▼** to change the selection, and then press **ENTER**.



- The factory default is "CC-1".

- 6 Press **HOME MENU** to exit the menu.

Closed caption for digital TV channels

Your Plasma Display System is equipped with an internal closed caption decoder also for digital TV channels.

You can enjoy digital closed captions whenever their services are provided. Digital closed captions allow you to change parameters such as fonts and colors. However, some digital TV programs may provide you with only conventional closed captions. If this is the case, conventional closed captions are displayed.

Activating the closed caption

Use the following procedure to activate the closed caption.

- 1 Press **HOME MENU**.
- 2 Press **▲/▼** to select "DTV Setup", and then press **ENTER**.
- 3 Press **▲/▼** to select "DTV Closed Caption", and then press **ENTER**.
- 4 Press **▲/▼** to select "Setting", and then press **ENTER**.
- 5 Press **▲/▼** to select "On" or "On If Mute", and then press **ENTER**.

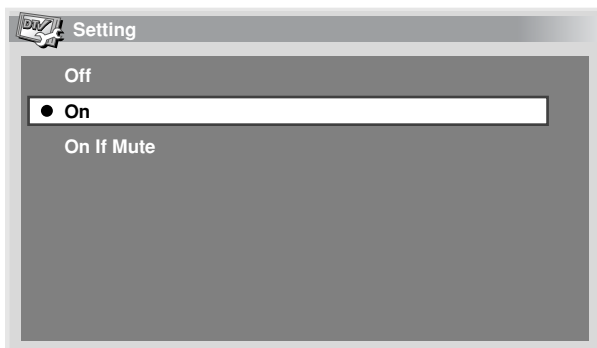

Item	Description
Off (factory default)	Does not show closed captions.
On	Always shows closed captions.
On If Mute	Shows closed captions only while sound is being muted.

- 6 Press **HOME MENU** to exit the menu.



NOTE

- For MONITOR OUT, only conventional closed caption signals are output; digital closed caption signals are not output.

Selecting the type of conventional closed captions (for digital TV channels)

Use the following procedure to select the type of conventional closed captions. You will watch the selected type of closed captions when the selected digital TV program provides only conventional closed captions.

- 1 Press **HOME MENU**.
- 2 Press **▲/▼** to select "DTV Setup", and then press **ENTER**.
- 3 Press **▲/▼** to select "DTV Closed Caption", and then press **ENTER**.
- 4 Press **▲/▼** to select "Analog Caption", and then press **ENTER**.
- 5 Press **▲/▼** to change the selection, and then press **ENTER**.

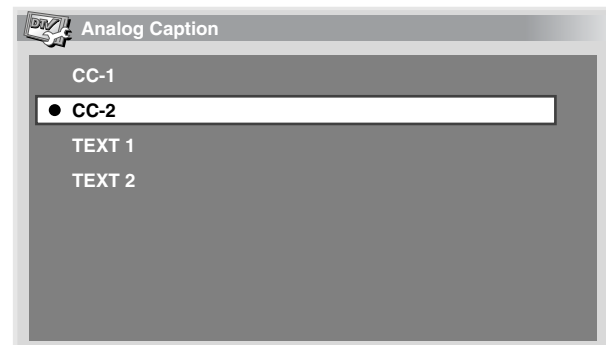

- The factory default is "CC-1".

- 6 Press **HOME MENU** to exit the menu.

Selecting digital closed captions

Use the following procedure to select digital closed captions.

- 1 Press **HOME MENU**.
- 2 Press **▲/▼** to select "DTV Setup", and then press **ENTER**.
- 3 Press **▲/▼** to select "DTV Closed Caption", and then press **ENTER**.
- 4 Press **▲/▼** to select "Digital Caption", and then press **ENTER**.
- 5 Press **▲/▼** to change the selection, and then press **ENTER**.

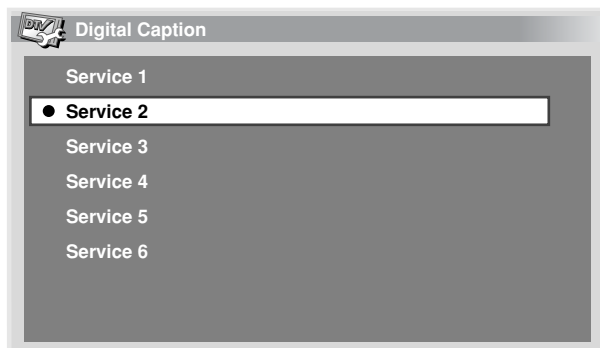

- The factory default is "Service 1".

- 6 Press **HOME MENU** to exit the menu.

NOTE

- The Primary Caption Service is usually offered for Service 1, and the Secondary Language Service is usually offered for Service 2 if these services are available.

Selecting digital closed caption parameters

Use the following procedure to change such parameters of digital closed captions as font size, font type, foreground and background colors.

- 1 Press **HOME MENU**.
- 2 Press **▲/▼** to select "DTV Setup", and then press **ENTER**.
- 3 Press **▲/▼** to select "DTV Closed Caption", and then press **ENTER**.
- 4 Press **▲/▼** to select "Digital Caption Setup", and then press **ENTER**.
- 5 Press **▲/▼** to select the item, and then press **←/→** to change the parameter.

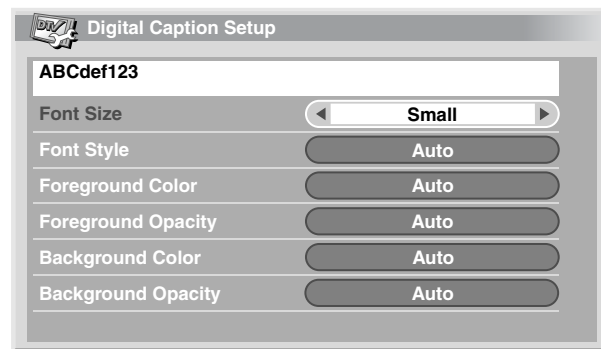

- The field at the bottom of the dialog box shows how closed captions will appear.

- 6 Repeat step 5 as necessary, and then press **ENTER**.
- 7 Press **HOME MENU** to exit the menu.

Useful Adjustment Settings

12

The following table shows the parameters selectable for each item.

Item	Selection
Font Size	Auto/ Small/ Standard / Large
Font Style ¹	Auto/ Font 1 / Font 2/ Font 3/ Font 4/ Font 5/ Font 6/ Font 7/ Font 8
Foreground Color	Auto/ Black/ White / Red/ Green/ Blue/ Yellow/ Magenta/ Cyan
Foreground Opacity	Auto/ Opaque / Translucent/ Transparent/ Flashing
Background Color	Auto/ Black / White/ Red/ Green/ Blue/ Yellow/ Magenta/ Cyan
Background Opacity	Auto/ Opaque / Translucent/ Transparent/ Flashing

¹ Font 1 (default font)/ Font 2 (monospaced with serifs)/ Font 3 (proportionally spaced with serifs)/ Font 4 (monospaced without serifs)/ Font 5 (proportionally spaced without serifs)/ Font 6 (casual font)/ Font 7 (cursive font)/ Font 8 (small capitals font)

With "Auto" selected, parameters specified by the provider are used; if not specified by the provider, the bolded default parameters are used. If you select parameters other than "Auto", the selected parameters are used regardless of provider's specifications.

89

En

Parental Control (setting the V-CHIP level)

The V-CHIP is an electronic filtering device built into your system. This tool gives parents a great degree of control over broadcasts accessed by their children. It allows parents to select programs judged suitable for child viewing while blocking ones judged not suitable. It does so automatically once you activate the V-CHIP feature in your Plasma Display.

This tool functions for both conventional and digital TV channels.

- The U.S. has two rating systems for viewing content: TV Parental Guidelines and movie ratings.
- The TV Parental Guidelines work in conjunction with the V-CHIP to help parents screen out inappropriate television shows from their children.
- Movie ratings are used for original movies rated by the Motion Picture Association of America (MPAA) as watched on cable TV and not edited for television. The V-CHIP can also be set to block MPAA-rated movies.

Voluntary movie rating system (MPAA)

Rating	Description
G	General audiences. All ages admitted.
PG	Parental guidance suggested. Some material may not be suitable for children.
PG-13	Parents strongly cautioned. Some material may be inappropriate for children under 13.
Age-Base R	Restricted. Under 17 requires accompanying parent or adult guardian (age varies in some jurisdictions).
NC-17	No one 17 and under admitted.
X	A rating that has now been superseded by NC-17.
NR	Not rated.

NOTE

- The voluntary movie rating system only uses an age-based rating.

TV Parental Guidelines

Rating	Content				
	FV (Fantasy violence)	D (Sexually suggestive dialog)	L (Adult language)	S (Sexual situation)	V (Violence)
TV-Y (All children)					
TV-Y7 (Directed to older children)	X				
Age-Base TV-G (General audience)					
TV-PG (Parental guidance suggested)		X	X	X	X
TV-14 (Parents strongly cautioned)		X	X	X	X
TV-MA (Mature audience only)			X	X	X

X: Content rating can be set.

Activating the Parental Control

- 1 Press **HOME MENU**.
- 2 Press **▲/▼** to select "Setup", and then press **ENTER**.
- 3 Press **▲/▼** to select "Parental Control", and then press **ENTER**.
 - If you have set a password (page 95), the password entry screen appears. Enter your 4-digit password using buttons **0 – 9**.
- 4 Press **▲/▼** to select "Status", and then press **ENTER**.
- 5 Press **▲/▼** to select "On", and then press **ENTER**.

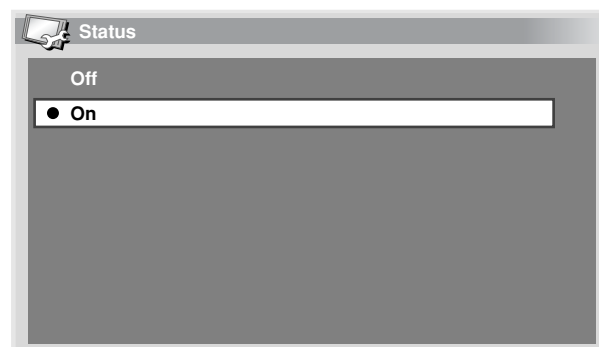

- The factory default is "Off".

- 6 Press **HOME MENU** to exit the menu.

Setting the voluntary moving rating system (MPAA)

- 1 Press **HOME MENU**.
- 2 Press **▲/▼** to select "Setup", and then press **ENTER**.
- 3 Press **▲/▼** to select "Parental Control", and then press **ENTER**.
 - If you have set a password (page 95), the password entry screen appears. Enter your 4-digit password using buttons **0 – 9**.
- 4 Press **▲/▼** to select "MPAA Ratings", and then press **ENTER**.
- 5 Press **▲/▼** to select the desired rating, and then press **←/→** to select "View" or "Block".

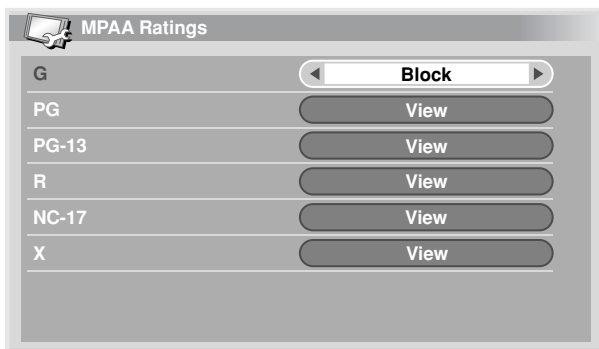

- The factory defaults for all the ratings are "View".

- 6 Press **HOME MENU** to exit the menu.

Example 1:

Changing "R" from "Block" to "View" causes "View" to be automatically selected also for "G", "PG", and "PG-13".

Example 2:

Changing "R" from "View" to "Block" causes "Block" to be automatically selected also for "NC-17" and "X".

Blocking Not Rated (NR) TV programs

Use the following procedure to block movies not rated by the MPAA.

- 1 Press **HOME MENU**.
- 2 Press **▲/▼** to select "Setup", and then press **ENTER**.
- 3 Press **▲/▼** to select "Parental Control", and then press **ENTER**.
 - If you have set a password (page 95), the password entry screen appears. Enter your 4-digit password using buttons **0 – 9**.
- 4 Press **▲/▼** to select "MPAA NR", and then press **ENTER**.
- 5 Press **▲/▼** to select "View" or "Block", and then press **ENTER**.

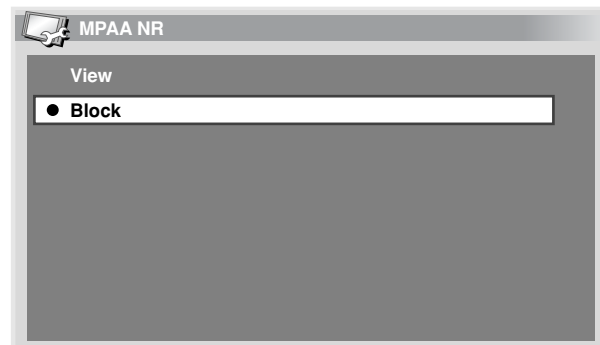

- The factory default is "View".

- 6 Press **HOME MENU** to exit the menu.

Setting the TV Parental Guidelines (TV Guidelines)

- 1 Press **HOME MENU**.
- 2 Press **▲/▼** to select "Setup", and then press **ENTER**.
- 3 Press **▲/▼** to select "Parental Control", and then press **ENTER**.
 - If you have set a password (page 95), the password entry screen appears. Enter your 4-digit password using buttons **0 – 9**.
- 4 Press **▲/▼** to select "TV Parental Guidelines", and then press **ENTER**.

TV Parental Guidelines						
		FV	D	L	S	V
TV-Y	V					
TV-Y7	V	V				
TV-G	V					
TV-PG	V		V	V	V	V
TV-14	V		V	V	V	V
TV-MA	V			V	V	V

- 5 Press **▲/▼** or **◀/▶** to select the desired cell (rating).
- 6 Press **ENTER** to select "V" (View) or "B" (Block).

TV Parental Guidelines						
		FV	D	L	S	V
TV-Y	V					
TV-Y7	B	B				
TV-G	V					
TV-PG	V		V	V	V	V
TV-14	V		V	V	V	V
TV-MA	V			V	V	V

- Each time you press **ENTER**, the selection is switched.
- The factory defaults for all the ratings are "V" (View).

- 7 Press **HOME MENU** to exit the menu.

NOTE

- Blocking a low rated program will cause all higher rated programs to be blocked.

Canadian rating systems

- The TV rating systems in Canada are based on the Canadian Radio-Television and Telecommunications Commission (CRTC) policy on violence in television programming.
- While violence is the most important content element to be rated, the structure developed takes into consideration other program content like language, nudity, sexuality and mature themes.
- When setting the V-CHIP on the Canadian system you can choose either the Canadian English ratings or the Canadian French ratings.

Canadian English ratings

Rating	Description
E	Exempt: Includes news, sports, documentaries and other information programming; talk shows, music videos, and variety programming.
C	Children: Intended for younger children under the age of 8 years. Pays careful attention to themes that could threaten their sense of security and well-being.
C8+	Children over 8 years old: Contains no portrayal of violence as the preferred, acceptable, or only way to resolve conflict; nor encourage children to imitate dangerous acts which they may see on the screen.
G	General: Considered acceptable for all age groups. Appropriate viewing for the entire family, contains very little violence, physical, verbal or emotional.
Age-Base PG	Parental Guidance: Intended for a general audience, but may not be suitable for younger children (under the age of 8) because it could contain controversial themes or issues.
14+	Over 14 Years: Could contain themes where violence is one of the dominant elements of the storyline, but it must be integral to the development of plot or character. Language usage could be profane and nudity present within the context of the theme.
18+	Adults: Intended for viewers 18 years and older and might contain depictions of violence, which while related to the development of plot, character or themes, are intended for adult viewing. Could contain graphic language and portrayals of sex and nudity.

Canadian French ratings

Rating	Description
E	Exempt programming.
G	General: All ages and children, contains minimal direct violence, but may be integrated into the plot in a humorous or unrealistic manner.
8ans+	General but inadvisable for young children: May be viewed by a wide public audience, but could contain scenes disturbing to children under eight who cannot distinguish between imaginary and real situations. Recommended for viewing with parent.
13ans+	Over 13 years: Could contain scenes of frequent violent scenes and therefore recommended for viewing with parent.
16ans+	Over 16 years: Could contain frequent violent scenes and intense violence.
18ans+	Over 18 years: Only for adult viewing. Could contain frequent violent scenes and extreme violence.

Age-Base

Setting Canadian French ratings

- 1 Press **HOME MENU**.
- 2 Press **▲/▼** to select "Setup", and then press **ENTER**.
- 3 Press **▲/▼** to select "Parental Control", and then press **ENTER**.
 - If you have set a password (page 95), the password entry screen appears. Enter your 4-digit password using buttons **0 – 9**.
- 4 Press **▲/▼** to select "Canadian French Ratings", and then press **ENTER**.
- 5 Press **▲/▼** to select the desired rating, and then press **←/→** to select "View" or "Block".

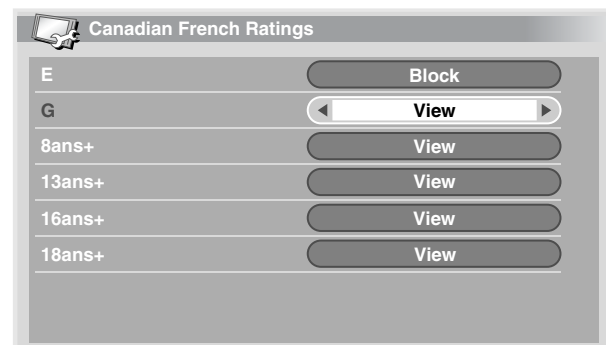

- The factory defaults for all the ratings are "View".

- 6 Press **HOME MENU** to exit the menu.

Setting Canadian English ratings

- 1 Press **HOME MENU**.
- 2 Press **▲/▼** to select "Setup", and then press **ENTER**.
- 3 Press **▲/▼** to select "Parental Control", and then press **ENTER**.
 - If you have set a password (page 95), the password entry screen appears. Enter your 4-digit password using buttons **0 – 9**.
- 4 Press **▲/▼** to select "Canadian English Ratings", and then press **ENTER**.
- 5 Press **▲/▼** to select the desired rating, and then press **←/→** to select "View" or "Block".

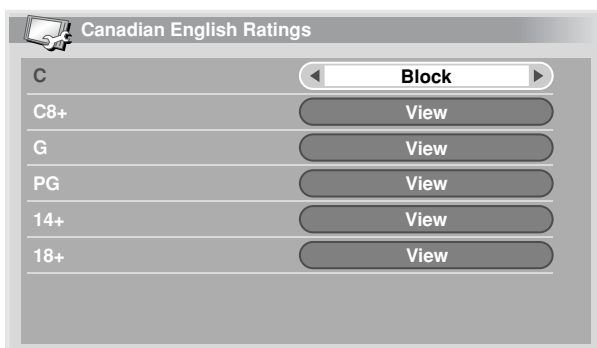

- The factory defaults for all the ratings are "View".

- 6 Press **HOME MENU** to exit the menu.

Temporarily deactivating the V-CHIP Block

You can temporarily deactivate the V-CHIP Block. When the V-CHIP Block is working and censors TV programs or VCR or DVD contents to be blocked, a password entry screen appears.

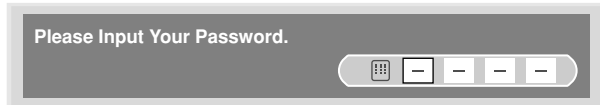

To temporarily deactivate the V-CHIP block, enter a 4-digit password that you have set using the Home menu. Image and sound muting is quitted.

If you press **ENTER** instead of entering the password, the password entry screen disappears.

Reactivating the V-CHIP Block

Executing one of the following procedures reactivates the V-CHIP Block.

Method 1:

Make a selection ("On" or "Off") for "Status" under "Parental Control" in the menu. See page 90.

Method 2:

Make a selection for "MPAA Ratings", "MPAA NR", "TV Parental Guidelines", "Canadian English Ratings" or "Canadian French Ratings" under "Parental Control" in the menu. See pages 91 to 93.

Method 3:

Switch off the power to the system.

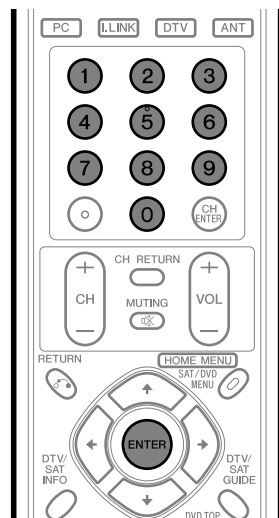

NOTE

- The password entry screen stays only for one minute. Pressing **ENTER** causes the password entry screen to appear again.

Programming a password (AV mode only)

You can program a password to prevent other persons from changing especially Parental Control settings.

Setting and changing the password

Use the following procedure to newly set or change the password:

- 1 Press **HOME MENU**.
- 2 Press **▲/▼** to select "Setup", and then press **ENTER**.
- 3 Press **▲/▼** to select "Password", and then press **ENTER**.
 - If you have set a password, the password entry screen appears. Enter your 4-digit password using buttons **0 – 9**.
 - The factory default is "1234".
- 4 Press **▲/▼** to select "Change Password", and then press **ENTER**.
- 5 Enter a 4-digit password to be newly set, using buttons **0 – 9**.

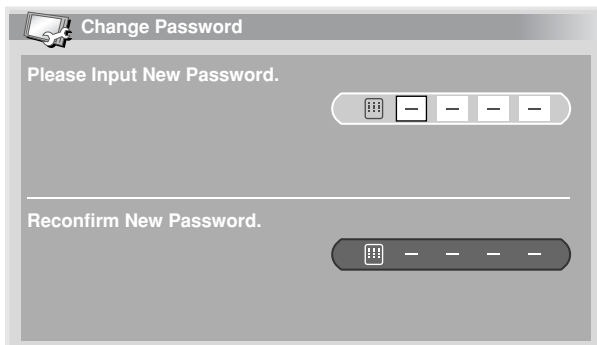

- 6 Enter the same password that you have entered in step 4, using buttons **0 – 9**.

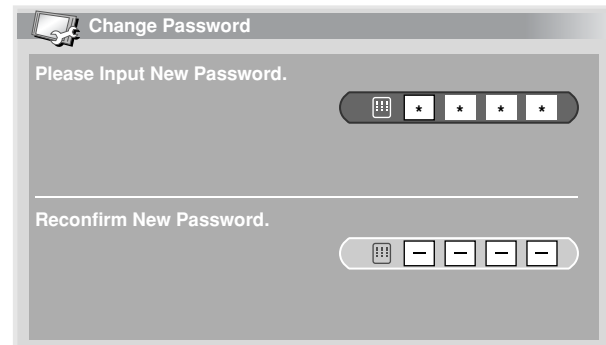

- 7 Press **HOME MENU** to exit the menu.

NOTE

- Take a note of the newly set password and keep it handy.

Resetting the password

- 1 Press **HOME MENU**.
- 2 Press **▲/▼** to select "Setup", and then press **ENTER**.
- 3 Press **▲/▼** to select "Password", and then press **ENTER**.
 - The password entry screen appears. Enter your 4-digit password using buttons **0 – 9**.
- 4 Press **▲/▼** to select "Reset", and then press **ENTER**.

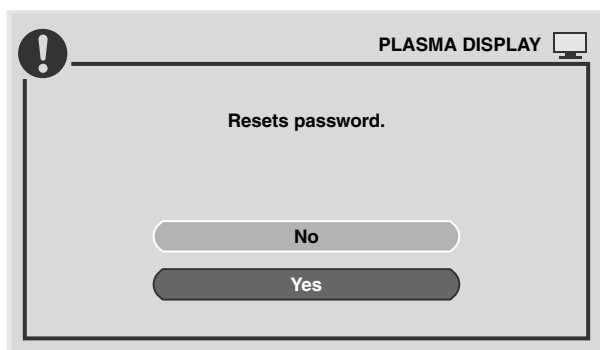

- 5 Press **▲/▼** to select "Yes", and then press **ENTER**.
- 6 Press **HOME MENU** to exit the menu.

NOTE

- The above procedure will reset the password to the factory default (1234).

Cut along the dotted line and file after reading and filling out.

We suggested you write down your password so you don't forget it.

PRO-1110HD/PRO-910HD			
Your password No.:			

If you forget the password

When the message "Please Input Your Password" is displayed in step 3 above, press the **ENTER** button on the remote control unit and hold it down for 3 seconds or longer.
The password reverts to "1234".

Learning function of the remote control unit

You can operate the connected AV products (AV Receiver, Cable Box, SAT tuner, VCR, DVD, DVD recorder, LD) using the learning function of your remote control unit. This remote control unit has a function that can memorize each remote control code.

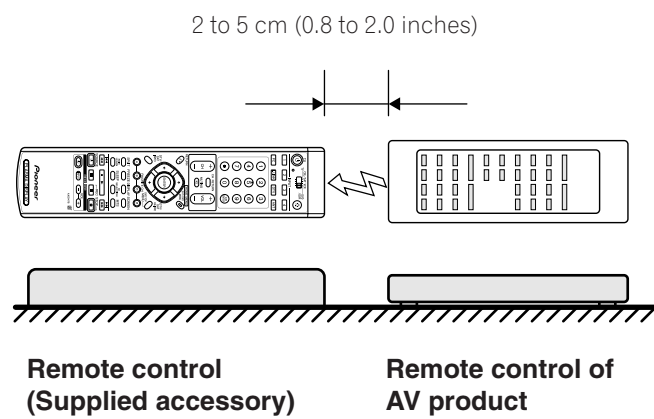

Using the learning function

- 1 Slide the **Mode switch** to match the device whose remote control signal you want to be learned.
- 2 Press **EDIT/LEARN** and **2** at the same time.
 - The LED flashes.
- 3 Press a button to be learned.
 - The LED lights up.
 - For the functions that can be learned, see pages 100 to 105.
 - When learning is finished, the LED starts flashing again.
- 4 Press **EDIT/LEARN** again to exit the Learn mode.

NOTE

- To exit the Learn mode halfway, press **EDIT/LEARN** again.
- If the **Mode switch** selection is changed when in the Learn mode, the Learn mode is cancelled.
- If no operation is performed for more than one minute, the Learn mode is cancelled.
- It takes about 2 seconds to finish code transmission. Do not interrupt it halfway. Wait until the LED flashes again.
- You can reset all learned codes to the factory defaults. When not in the Learn mode, press and hold **TV** and **+** at the same time.

Presetting manufacture codes

- 1 Slide the **Mode switch** to match the device to which you want to preset the remote control signal.
- 2 Press **EDIT/LEARN** and **1** at the same time.
 - The LED flashes.
- 3 Press **0 – 9** to enter the manufacture code. See page 99.
 - Preset mode is finished once the LED no longer lights up.

NOTE

- To exit the Edit mode halfway, press **EDIT/LEARN** again.
- If the **Mode switch** selection is changed when in the Edit mode, the Edit mode is cancelled.
- If no operation is performed for more than one minute, the Edit mode is cancelled.
- When you enter a code not listed, the LED flashes quickly.
- If the table on page 99 does not include your desired manufacturer or the remote control does not work, you can make the memory learn its signal by the Learn mode.
- The initial mode is "000" (PIONEER).

Manufacture codes

CABLE/SAT	VCR	DVD/DVR
000	PIONEER1(CABLE)	PIONEER
001	PIONEER2(CABLE)	FISHER
002	JERROLD1(CABLE)	FISHER2
003	JERROLD2(CABLE)	FISHER3
004	JERROLD3(CABLE)	GOLDSTAR
005	JERROLD4(CABLE)	HITACHI
006	JERROLD5(CABLE)	HITACHI2
007	JERROLD6(CABLE)	HITACHI3
008	JERROLD7(CABLE)	MAGNAVOX2
009	JERROLD8(CABLE)	mitsubishi
010	JERROLD9(CABLE)	mitsubishi2
011	JERROLD10(CABLE)	mitsubishi3
012	S.A.1(CABLE)	mitsubishi4
013	S.A.2(CABLE)	mitsubishi5
014	S.A.3(CABLE)	mitsubishi6
015	S.A.4(CABLE)	PANASONIC
016	ZENITH1(CABLE)	PANASONIC2
017	ZENITH2(CABLE)	PANASONIC3
018	ZENITH3(CABLE)	RCA
019		RCA2
020	PIONEER(SAT)	RCA3
021	RCA1(SAT)	SANYO
022	RCA2(SAT)	SANYO2
023	SONY(SAT)	SANYO3
024		SHARP
025		SHARP2
026		SHARP3
027		SONY(BETA)
028		SONY(VHS)
029		SONY(8mm)
030		TOSHIBA
031		JVC
032		JVC2
033		JVC3
034		JVC4
035		JVC5
036		ZENITH
037		mitsubishi(j-3)
038		SHARP(j-2)
039		PANASONIC(j-3)
040		TOSHIBA(j-3)
041		GRANDIENTE
042		AKAI
043		PIONEER2
044		SANYO4
045		MATSUI
046		AIWA
047		ALBA81
048		BUSH
049		THOMSON
050		BAIRD
051		TELEFUNKEN
052		ALBA

CABLE/SAT	VCR	DVD/DVR
053		Grundig1
054		Grundig2
055		Grundig3
056		SONY2
057		SONY3
058		SONY4
059		RCA4
060		PHILIPS
061		PHILIPS2
062		PHILIPS3
063		PHILIPS4
064		PHILIPS5
065		PHILIPS6
066		SAMSUNG
067		SAMSUNG2
068		SAMSUNG3
069		SAMSUNG4
070		SAMSUNG5
071		SAMSUNG6
072		MARANTZ
073		MARANTZ2
074		GE
075		GE2
076		GE3
077		YAMAHA
078		YAMAHA2
079		YAMAHA3
080		YAMAHA4
081		CURTIS_MATHIS
082		CURTIS_MATHIS2
083		CURTIS_MATHIS3
084		FUNAI
085		ADMIRAL
086		KENWOOD
087		KENWOOD2
088		KENWOOD3
089		NEC
090		NEC2
091		NEC3
092		NEC4
093		WARDS
094		WARDS2
095		WARDS3
096		WARDS4
097		MEMOREX
098		MEMOREX2
099		JC_PENNY
100		JC_PENNY2
101		JC_PENNY3
102		JC_PENNY4
103		JC_PENNY5
104		JC_PENNY6

Using the remote control unit to control other devices

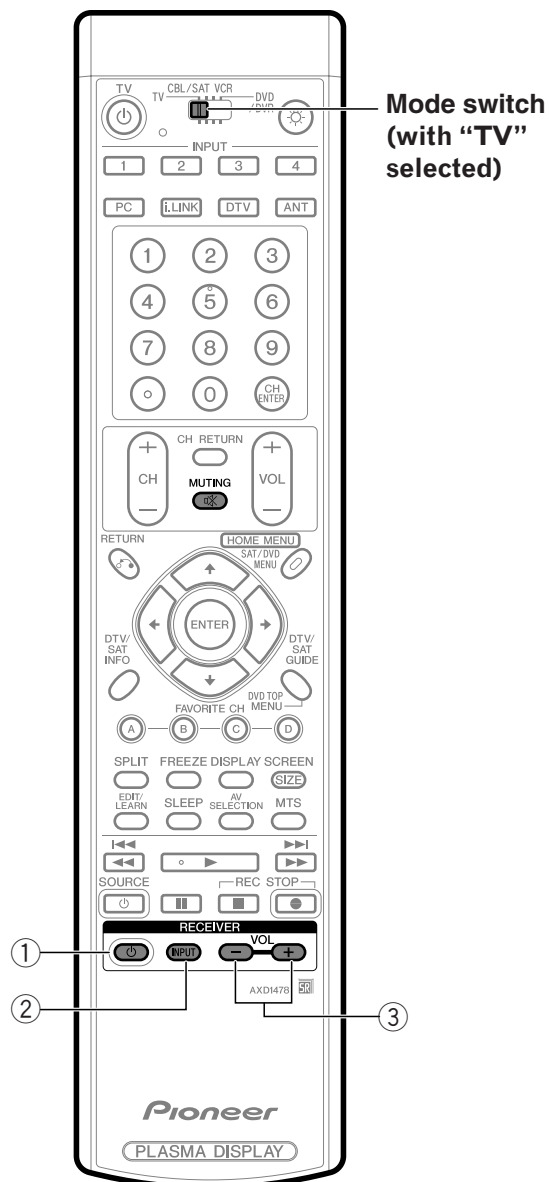

Receiver control buttons

When a Pioneer receiver is connected to the display, the receiver can be operated using buttons ① to ③.

When a non-Pioneer receiver is connected to the display, the signals for ① to ③ must first be learned before operating. See page 97.

- ① **RECEIVER** **(STANDBY/ON)**
Turns the receiver power on and off.
- ② **RECEIVER INPUT**
Selects the input source connected to the receiver.
- ③ **RECEIVER VOL +/-**
Adjusts the receiver volume level. Press **VOL +** to increase the volume and **VOL -** to decrease it.

NOTE

• (RECEIVER) MUTING

Allows the remote control unit to learn receiver's mute signal. Use this button when the mode switch is set to a position other than TV.

- The color-highlighted buttons on the remote control can learn the control signal from another device's remote control.

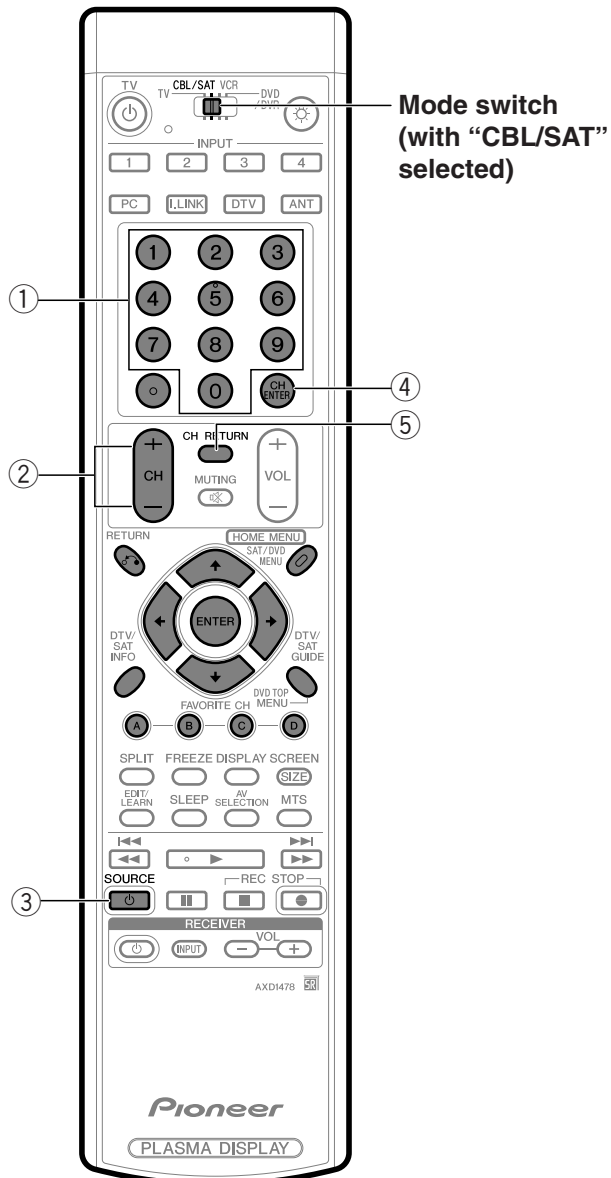

Cable control buttons

When the **Mode switch** is set to CBL/SAT the cable converter connected to the display can be operated using ① to ⑤.

Cable converters made by other manufacturers and not preset can also be operated using the remote control unit if ① to ⑤ have learned the functions. See page 97.

- ① **0 - 9**
Press a button (or buttons) that corresponds to the channel that you want to watch.
- ② **CH +/-**
Press **CH +** or **CH -** to tune in a higher or lower channel.
- ③ **SOURCE**
Turns the cable converter power on and off.
- ④ **CH ENTER ***
Fix the selected channel with the direct channel selection buttons.
- ⑤ **CH RETURN ***
Press to switch between the current channel and the channel you were watching immediately before.

* Some manufacturers do not preset **CH ENTER** and **CH RETURN**. Use these buttons to learn if necessary.

NOTE

- CABLE and SAT cannot be selected at the same time.
- The color-highlighted buttons on the remote control can learn the control signal from another device's remote control.

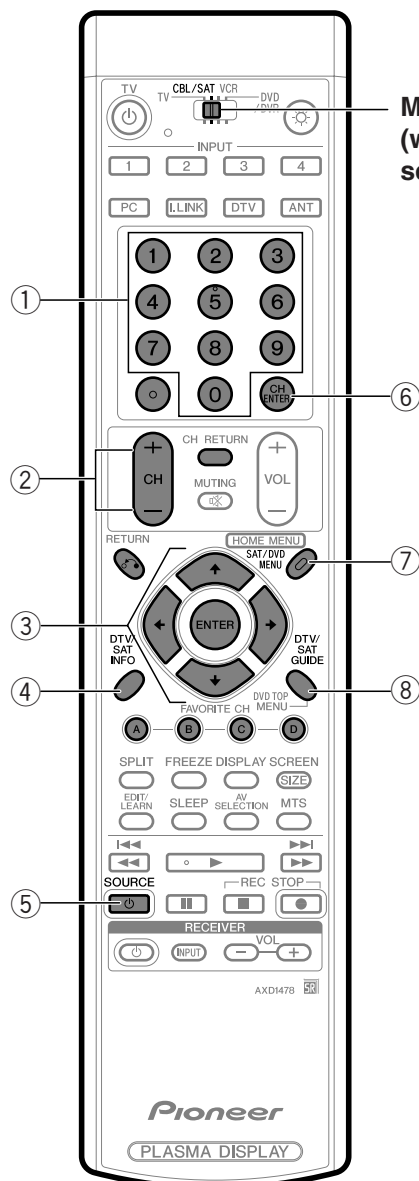

Mode switch
(with "CBL/SAT"
selected)

SAT control buttons

When the SAT is preset by the learning function of the remote control, the remote control unit buttons will function as shown below.

- When the **Mode switch** is set to CBL/SAT, satellite broadcast tuners made by other manufacturers and not preset can also be operated with the remote control unit if ① to ⑧ have learned the functions. See page 97.

① 0 - 9

Press a button (or buttons) that corresponds to the channel that you wish to watch.

② CH +/-

Press **CH +** or **CH -** to tune in a higher or lower channel.

③ ENTER, $\uparrow/\downarrow/\leftarrow/\rightarrow$

ENTER: Press to activate the selected function.

$\uparrow/\downarrow/\leftarrow/\rightarrow$: Press the button to select items on the SAT GUIDE screen or SAT MENU screen.

④ SAT INFO

When this button is pressed, information on satellite broadcasting will appear.

- Use this button to learn if necessary.

⑤ SOURCE $\text{\textcircled{P}}$

Turns the Satellite broadcast tuner power on and off.

⑥ CH ENTER

Fix the selected channel with the direct channel selection buttons.

- Use this button to learn if necessary.

⑦ SAT MENU

When this button is pressed, the satellite broadcasting menu screen will appear.

⑧ SAT GUIDE

When this button is pressed, the satellite broadcasting guide screen will appear.

NOTE

- CABLE and SAT cannot be selected at the same time.
- The color-highlighted buttons shown in the figure at left can learn the control signal from another device's remote control.

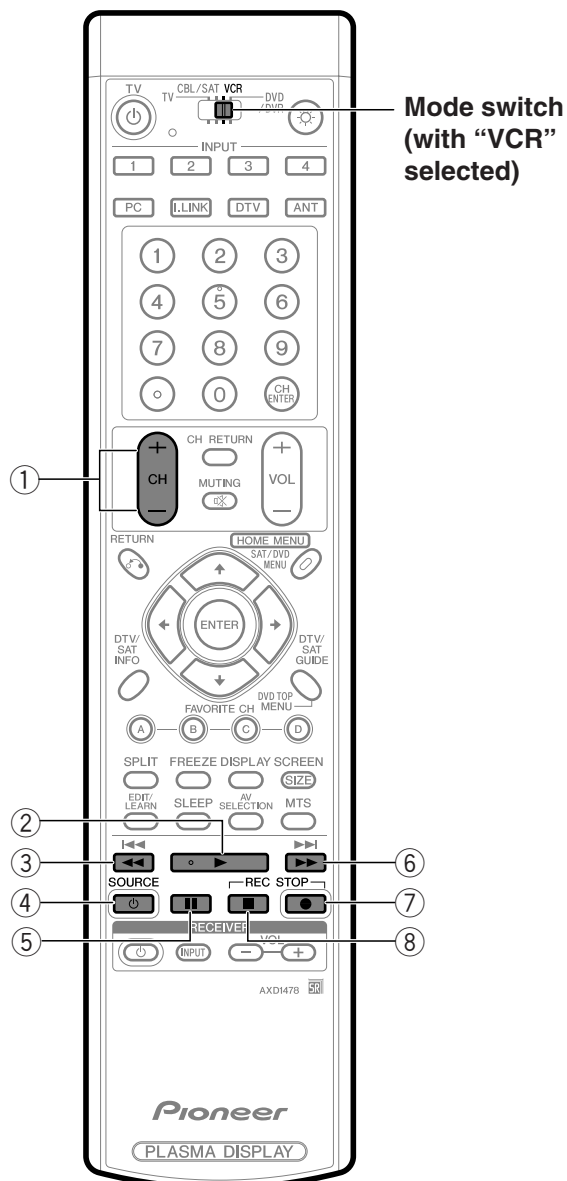

VCR control buttons

When the VCR is preset by the learning function of the remote control, the remote control unit buttons will function as follows when the **Mode switch** of the remote control unit is set to VCR.

- When the input selector button having the same number as the input terminal connecting the VCR is pressed, the VCR can be operated using ① to ⑧.
- VCR made by other manufacturers and not preset can also be operated using the remote control unit if ① to ⑧ have learned the functions. See page 97.

- CH +/-**
Press to select the channel of the TV tuner on the VCR.
- ▶ (PLAY)**
Selects playback.
- ◀◀ (REW)**
Rewinds the tape and allows picture search.
- SOURCE**
Turns the power of the VCR on and off.
- || (PAUSE/STILL)**
Sets pauses and still pictures.
- ▶▶ (FF)**
Rapidly advances the tape and allows picture search.
- (REC)**
Starts recording.
- (STOP)**
Stop tape transport.

NOTE

- The color-highlighted buttons on the remote control can learn the control signal from another device's remote control.

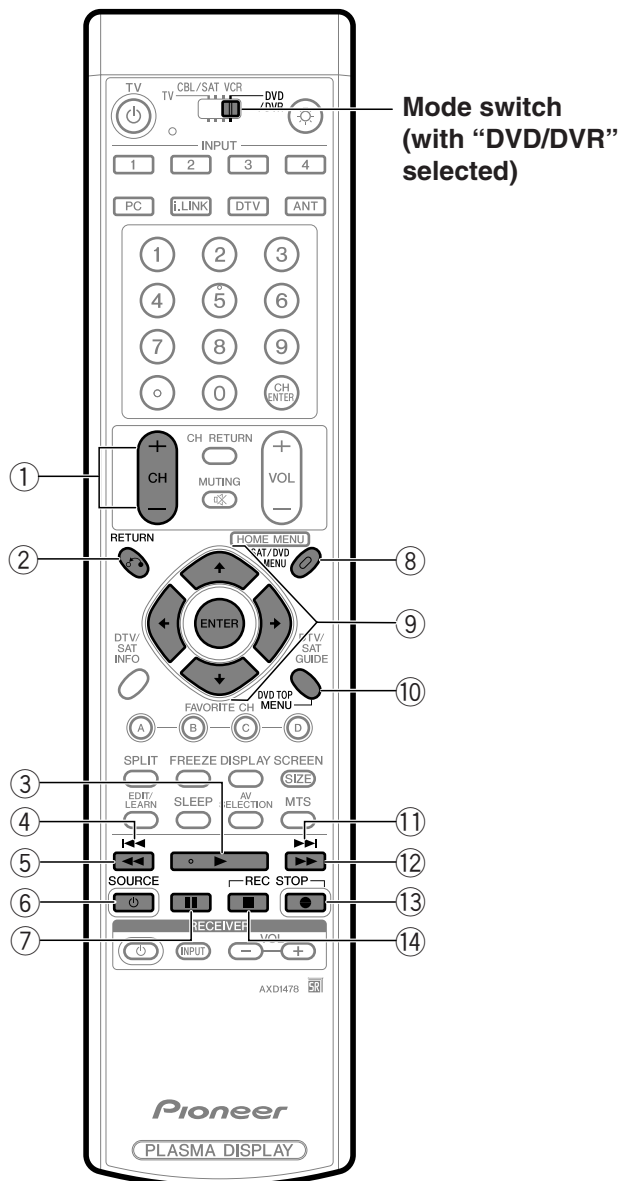







**Mode switch
(with “DVD/DVR”
selected)**

DVD/DVR control buttons

When the DVD/DVR is preset by the learning function of the remote control, the remote control unit buttons will function as follows when the **Mode switch** of the remote control unit is set to DVD/DVR.

- When the input selector button having the same number as the input terminal connecting a DVD player or DVD recorder is pressed, these players can be operated using ① to ⑭.
- DVD players or DVD recorders made by other manufacturers and not preset can also be operated using the remote control unit if ① to ⑭ have learned the functions. See page 97.

- ① **CH +/- (DVD recorder only)**
Press to change the channel of the tuner built in the DVD recorder.
- ② **RETURN**
When the DVD menu is in display, press to restore the immediately previous screen.
- ③ **▶ (PLAY)**
Selects playback.
- ④ **◀◀ (CHAPTER SEARCH)**
Pressing quickly once takes you to the start of the chapter currently playing. Each time you press it, you move back to the start of the previous chapter.
- ⑤ **◀◀ (SCAN)**
Continue pressing to go backward.
- ⑥ **SOURCE**
Turns the power of the DVD player or DVD recorder on and off.
- ⑦ **|| (PAUSE/STILL)**
Sets pauses and still pictures.
- ⑧ **SAT/DVD MENU (DVD, DVD recorder)**
When this button is pressed, the DVD menu will appear.
- ⑨ **ENTER, ↑/↓/←/→ (DVD, DVD recorder)**
ENTER: Press to activate the selected function.
↑/↓/←/→: Press the button to select items on the DVD MENU screen.
- ⑩ **DVD TOP MENU (DVD, DVD recorder)**
When this button is pressed, the DVD top menu will appear.

- ⑪  (CHAPTER SEARCH)
Pressing quickly once takes you to the start of the next chapter. Each time you press it, you move ahead to the start of the next chapter.
- ⑫  (SCAN)
Continue pressing for fast forward.
- ⑬  (REC)
Starts recording.
- ⑭  (STOP)
Playback stops when pressing once.
With some DVD players or DVD recorders, pressing the button twice may open the disc tray.
- ⑬ ⑭  (REC STOP)
Press and hold , and then press this button to stop recording. This operation is true of only Pioneer DVD recorders.

 **NOTE**

- The DVD player or DVD recorder cannot be selected at the same time.
- The color-highlighted buttons on the remote control can learn the control signal from another device's remote control.

Troubleshooting

Problem	Possible Solution
• No power.	<ul style="list-style-type: none"> • Make sure the Plasma Display and the Media Receiver are connected correctly. (See page 20.) • Is the power cord disconnected? (See page 27.) • Has the main power been turned on? (See page 28.) • Check if you pressed TV (⏻) on the remote control unit. (See page 28.) If the indicator on the system lights up red, press TV (⏻).
• Green and red rectangles appear on the screen alternately.	<ul style="list-style-type: none"> • Check if the system cable has been disconnected or almost disconnected? (See page 20.)
• The system cannot be operated.	<ul style="list-style-type: none"> • External influences such as lightning, static electricity, etc., may cause improper operation. In this case, operate the system after first turning the power of the Plasma Display and the Media Receiver, or unplugging the power cord and re-plugging it in after 1 or 2 minutes.
• Remote control unit does not operate.	<ul style="list-style-type: none"> • Is the Mode switch set correctly? Slide it to the TV setting position. (See page 16.) • Are batteries inserted with polarity (+, -) aligned? (See page 22.) • Are batteries worn out? (Replace with new batteries.) (See page 22.) • Operate the remote control unit while pointing it toward the remote control sensor on the Plasma Display. (See page 17.) • Are you using it under strong or fluorescent lighting? • Is a fluorescent light illuminated near the remote control sensor?
• No image and audio is presented.	<ul style="list-style-type: none"> • Check if the input source for video or PC has been unintentionally selected although you want to watch a TV channel. (See page 30.) • Check if you have activated the Parental Control function. (See page 90.) Enter a password to temporarily cancel the Parental Control function. (See page 94.)
• No picture.	<ul style="list-style-type: none"> • Is connection to other components correct? (See pages 65 to 77.) • Is a non-compatible PC signal being input? (See page 107.) • Is picture adjustment correct? (See pages 47 to 53.)
• Images are presented but no audio is output.	<ul style="list-style-type: none"> • Check if you have selected the minimum volume. (See page 31.) • Check if you have muted sound. (See page 31.) • When using a video or PC input source, check that the audio terminal is also in connection. (See pages 65 to 70 and 77.)
<ul style="list-style-type: none"> • Sound is reversed between the right and left. • Sound is output from only a single speaker. 	<ul style="list-style-type: none"> • Check if the speaker cable connections have been reversed between the right and left or if the speaker cable from either speaker has been disconnected. (See pages 13 and 20.) • Has the balance been correctly adjusted? (See page 53.)
• Picture is cut off.	<ul style="list-style-type: none"> • Is the image position correct? (See pages 81 and 82.) • Has the correct screen size been selected? (See page 83.)
• Strange colour, light colour, dark or colour misalignment.	<ul style="list-style-type: none"> • Adjust the picture tone. (See pages 47 to 53.) • Is the room too bright? The picture may look dark in a room that is too bright.
• Power is suddenly turned off.	<ul style="list-style-type: none"> • Is the sleep timer set? (See page 85.) • Check the power control setting. (See pages 55 and 56.) • The system's internal temperature has increased. Remove any objects blocking vent or clean. (See pages 18 to 19.)

Code	Message	Check
SD04	Powering off. Internal temperature too high. Check temperature around PDP.	Check if the ambient temperature of the Plasma Display is high.
SD05	Powering off. Internal protection circuits activated, Is there a short in speaker cable?	Check the speaker cable connections between the Plasma Display and the speakers.
SD11	Powering off. Internal temperature too high. Check temperature around media receiver.	Check if the ambient temperature of the Plasma Display and the Media Receiver is high.

Computer compatibility chart

Resolution	Frequency	Remarks
720 × 400	70 Hz	
640 × 480	60 Hz	
	65 Hz	Macintosh 13" (67 Hz)
	72 Hz	
	75 Hz	
800 × 600	56 Hz	
	60 Hz	
	72 Hz	
	75 Hz	
832 × 624	74.5 Hz	Macintosh 16"
1024 × 768	60 Hz	
	70 Hz	
	75 Hz	Macintosh 19"
1280 × 768	56 Hz	
	60 Hz	
	70 Hz	

Specifications

Item	50" Plasma Display, Model: PRO-504PU	43" Plasma Display, Model: PRO-434PU
Number of Pixels	1280 × 768 pixels	1024 × 768 pixels
Audio Amplifier	13 W + 13 W (1 kHz, 10 %, 8 Ω)	13 W + 13 W (1 kHz, 10 %, 8 Ω)
Surround System	SRS/FOCUS/TruBass	SRS/FOCUS/TruBass
Power Requirement	120 V AC, 60 Hz, 363 W (0.3 W Standby)	120 V AC, 60 Hz, 298 W (0.3 W Standby)
Dimensions	1270 (W) × 757 (H) × 98 (D) mm (50 (W) × 29 (H) × 3 7/8 (D) inches)	1120 (W) × 652 (H) × 98 (D) mm (44 1/8 (W) × 25 11/16 (H) × 3 7/8 (D) inches)
Weight	38 kg (83.8 lbs.)	30.5 kg (67.3 lbs.)

Item	Media Receiver, Model: PRO-R04U		
Reception System (Digital)	ATSC Digital TV system		
Circuit type	8VSB demodulation		
Tuner	VHF/UHF	VHF 2–13ch, UHF 14–69ch	
	CATV	2–125ch (Standard Channel Plan, 8VSB only)	
Audio format	Dolby Digital		
Reception System (Analog)	American TV standard NTSC system		
Circuit type	Video signal detection PLL full synchronous detection, PLL digital synthesizer system		
Tuner	VHF/UHF	VHF 2–13ch, UHF 14–69ch	
	CATV	1–125ch	
Audio multiplex	BTSC system		
Terminals	Rear	DTV Antenna	75 Ω UNBAL, F Type for DTV in
		Antenna A	75 Ω UNBAL, F Type for VHF/UHF/CATV in Loop out
		Antenna B	75 Ω UNBAL, F Type for VHF/UHF/CATV in Loop out
		i.LINK (TS)	S400 (2)
		INPUT 1	COMPONENT VIDEO in, S-VIDEO in, VIDEO in, AUDIO in
		INPUT 2	S-VIDEO in, VIDEO in, AUDIO in
		INPUT 3	COMPONENT VIDEO in, AUDIO in
		Monitor Out	S-VIDEO out, VIDEO out, AUDIO out
		Digital Audio Output	Optical (1)
		VCR Control Output	1
		CONTROL IN	1
		CONTROL OUT	1
	Front	INPUT 4	COMPONENT VIDEO in, S-VIDEO in, VIDEO in, AUDIO in,
		PC	Analog RGB in, AUDIO in
OSD			English/French/Spanish
Power Requirement			120 V AC, 60 Hz, 44.5 W (0.3 W Standby)
Dimensions			420 (W) × 90 (H) × 297 (D) mm (16 9/16 (W) × 3 9/16 (H) × 11 11/16 (D) inches)
Weight			5.7 kg (12.2 lbs.)

• Design and specifications are subject to change without notice.

Trademarks

- SRS and the (●)® symbol are trademarks of SRS Labs, Inc.
SRS technology is incorporated under license from SRS Labs, Inc.
- FOCUS and the (●)® symbol are trademarks of SRS Labs, Inc.
FOCUS technology is incorporated under license from SRS Labs, Inc.
- **SRS WOW**® is a trademark of SRS Labs, Inc.
WOW technology is incorporated under license from SRS Labs, Inc.
- DOLBY DIGITAL
Manufactured under license from Dolby Laboratories. "Dolby" and the double-D symbol are trademarks of Dolby Laboratories.
- This product includes FontAvenue® fonts licensed by NEC Corporation.
FontAvenue is a registered trademark of NEC Corporation.
- The i.LINK logo and i.LINK are registered trademarks of Sony Corporation.
- D-VHS is a registered trademark of Victor Company of Japan, Limited.
- Apple and Macintosh are registered trademarks of Apple Computer, Inc.
- Microsoft is a registered trademark of Microsoft Corporation.
- DDC is a registered trademark of Video Electronics Standards Association.
- Power Management is a registered trademark of Sun Microsystems, Inc.
- VGA and XGA are registered trademarks of International Business Machines Co., Inc.
- The names of the companies or institutions are trademarks or registered trademarks of the respective companies or institutions.

Published by Pioneer Corporation.
Copyright © 2003 Pioneer Corporation.
All rights reserved.







Should this product require service in the U.S.A. and you wish to locate the nearest Pioneer Authorized Independent Service Company, or if you wish to purchase replacement parts, operating instructions, service manuals, or accessories, please call the number shown below.

8 0 0 - 4 2 1 - 1 4 0 4

Please do not ship your product to Pioneer without first calling the Customer Support Division at the above listed number for assistance.

Pioneer Electronics (USA) Inc.
Customer Support Division
P.O. BOX 1760, Long Beach,
CA 90801-1760, U.S.A.

For warranty information please see the Limited Warranty sheet included with your product.

Should this product require service in Canada, please contact a Pioneer Canadian Authorized Dealer to locate the nearest Pioneer Authorized Service Company in Canada. Alternatively, please contact the Customer Satisfaction Department at the following address:

Pioneer Electronics of Canada, Inc.
Customer Satisfaction Department
300 Allstate Parkway, Markham, Ontario L3R OP2
(905)479-4411
1(877)283-5901

For warranty information please see the Limited Warranty sheet included with your product.

Si ce produit doit être réparé au Canada, veuillez vous adresser à un distributeur autorisé Pioneer du Canada pour obtenir le nom du Centre de Service Autorisé Pioneer le plus près de chez-vous. Vous pouvez aussi contacter le Service à la clientèle de Pioneer:

Pioneer Électroniques du Canada, Inc.
Service à la clientèle
300, Allstate Parkway, Markham, Ontario L3R OP2
(905)479-4411
1(877)283-5901

Pour obtenir des renseignements sur la garantie, veuillez vous reporter au feuillet sur la garantie restreinte qui accompagne le produit.

S018D_enfr

Published by Pioneer Corporation.
Copyright © 2003 Pioneer Corporation.
All rights reserved.

PIONEER CORPORATION

4-1, Meguro 1-Chome, Meguro-ku, Tokyo 153-8654, Japan

PIONEER ELECTRONICS [USA] INC.

P.O. BOX 1540, Long Beach, California 90801-1540, U.S.A.

PIONEER ELECTRONICS OF CANADA, INC.

300 Allstate Parkway, Markham, Ontario L3R OP2, Canada

PIONEER EUROPE NV

Haven 1087, Keetberglaan 1, B-9120 Melsele, Belgium TEL: 03/570.05.11

PIONEER ELECTRONICS AUSTRALIA PTY. LTD.

178-184 Boundary Road, Braeside, Victoria 3195, Australia, TEL: [03] 9586-6300

PIONEER ELECTRONICS DE MEXICO S.A. DE C.V.

Bldv. Manuel Avila Camacho 138, 10 piso Col. Lomas de Chapultepec, Mexico, D.F. 11000
TEL: 52-55-9178-4270 FAX: 52-55-5202-3714

<03I00001>

Printed in Japan <ARB1556-A>



About HDMI

Quelques mots sur HDMI

Acerca de HDMI



For the handling procedures and the other functions, refer to the dedicated operation manual.

Using HDMI Input

The INPUT 1 and INPUT 3 terminals include HDMI terminals to which digital video and audio signals can be input. To use the HDMI terminal, activate the terminal and specify the types of video and audio signals to be received from the connected equipment. For the types of these signals, see the operation manual that came with the connected equipment.

Before starting the menu, press **INPUT 1** (or **INPUT 3**) on the remote control unit or press **INPUT** on the Plasma Display to select INPUT 1 (or INPUT 3).

Input signal correlation table

1920*1080i@59.94/60Hz
720*480p@59.94/60Hz
1280*720p@59.94/60Hz
720(1440)*480i@59.94/60Hz

NOTE

- PC signals are out of correspondence.

Connecting HDMI equipment

Media Receiver (rear view)

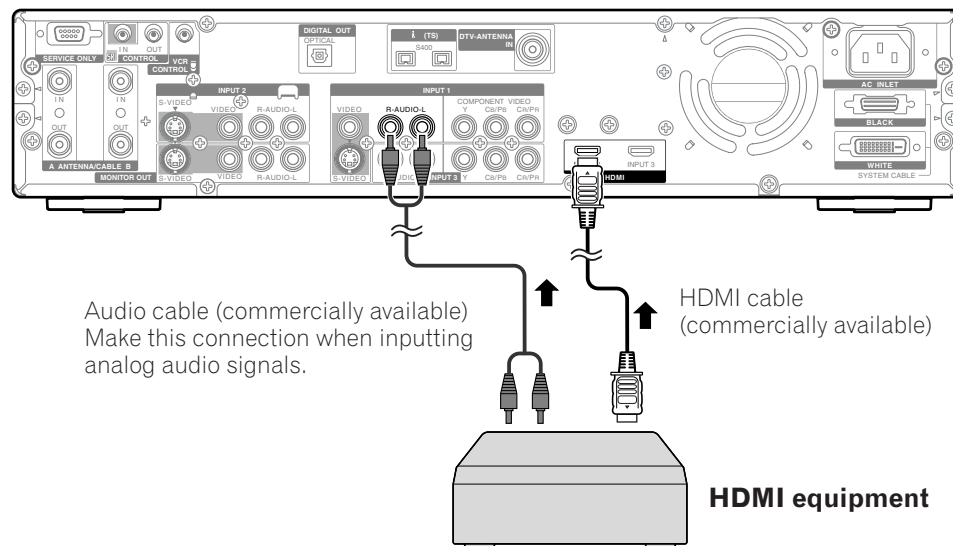

To activate the HDMI terminal:

- 1 Press **HOME MENU**.
- 2 Press **▲/▼** to select "Option", and then press **ENTER**.
- 3 Press **▲/▼** to select "HDMI Input", and then press **ENTER**.
- 4 Press **▲/▼** to select "Setting", and then press **ENTER**.
- 5 Press **▲/▼** to select "Enable", and then press **ENTER**.



Item	Description
Disable (factory default)	Deactivates the HDMI terminal.
Enable	Activates the HDMI terminal.

- 6 Press **HOME MENU** to exit the menu.



To specify the type of digital video signals:

- 1 Press **HOME MENU**.
- 2 Press **▲/▼** to select "Option", and then press **ENTER**.
- 3 Press **▲/▼** to select "HDMI Input", and then press **ENTER**.
- 4 Press **▲/▼** to select "Video", and then press **ENTER**.
- 5 Press **▲/▼** to select the type of digital video signals, and then press **ENTER**.

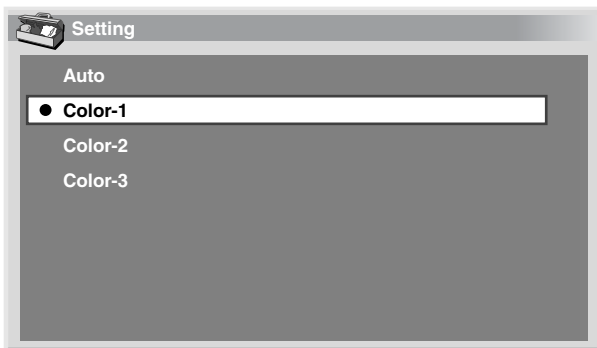

- If you select "Auto", an attempt will be made to identify the type of digital video signals when digital video signals are received.

Item	Description
Auto (factory default)	Automatically identifies input digital video signals.
Color-1	Digital Component Video signals (4:2:2) locked
Color-2	Digital Component Video signals (4:4:4) locked
Color-3	Digital RGB signals locked

- 6 Press **HOME MENU** to exit the menu.

NOTE

- If you select a parameter other than "Auto", make such a setting that results in natural color.
- If no image appears, specify another digital video signal type.
- For the digital video signal types to be specified, check the operation manual that came with the connected equipment.

To specify the type of audio signals:

- 1 Press **HOME MENU**.
- 2 Press **▲/▼** to select "Option", and then press **ENTER**.
- 3 Press **▲/▼** to select "HDMI Input", and then press **ENTER**.
- 4 Press **▲/▼** to select "Audio", and then press **ENTER**.
- 5 Press **▲/▼** to select the type of audio signals, and then press **ENTER**.

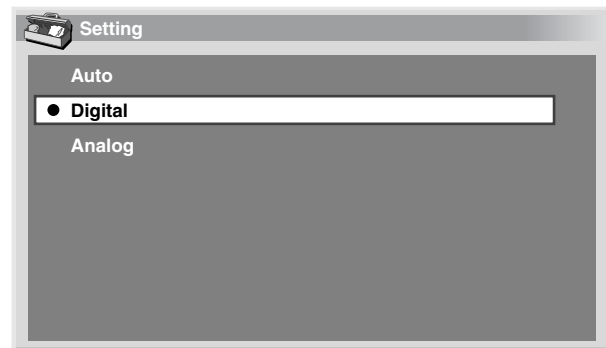

- If you select "Auto", an attempt will be made to identify the type of audio signals when audio signals are received.

Item	Description
Auto (factory default)	Automatically identifies input audio signals.
Digital	Accepts digital audio signals.
Analog	Accepts analog audio signals.

- 6 Press **HOME MENU** to exit the menu.

NOTE

- If no sound is output, specify another audio signal type.
- For the audio signal types to be specified, check the operation manual that came with the connected equipment.
- Depending on the equipment to be connected, you also need to connect analog audio cables.

• HDMI, the HDMI logo and High-Definition Multimedia Interface are trademarks or registered trademarks of HDMI Licensing LLC.

Pour tout ce qui concerne le mode opératoire et les autres fonctions, reportez-vous au mode d'emploi spécifique.

Utilisation de l'entrée HDMI

Les prises INPUT 1 et INPUT 3 assurent les liaisons HDMI et peuvent recevoir des signaux d'entrée audio et vidéo. Pour utiliser la prise HDMI, mettez cette prise en service et précisez le type des signaux audio et vidéo en provenance de l'appareil relié. Pour de plus amples détails concernant les signaux, reportez-vous au mode d'emploi qui accompagne l'appareil relié.

Avant d'ouvrir le menu, appuyez sur **INPUT 1**, (ou **INPUT 3**), sur le boîtier de télécommande, ou bien appuyez sur **INPUT**, sur l'écran à plasma, pour sélectionner INPUT 1 (ou INPUT 3).

Tableau de corrélation des signaux d'entrée

1920*1080i@59,94/60Hz
720*480p@59,94/60Hz
1280*720p@59,94/60Hz
720(1440)*480i@59,94/60Hz

REMARQUE

- Les signaux PC ne sont pas en correspondance.

Raccordement d'un appareil HDMI

Récepteur Média (vue de dos)

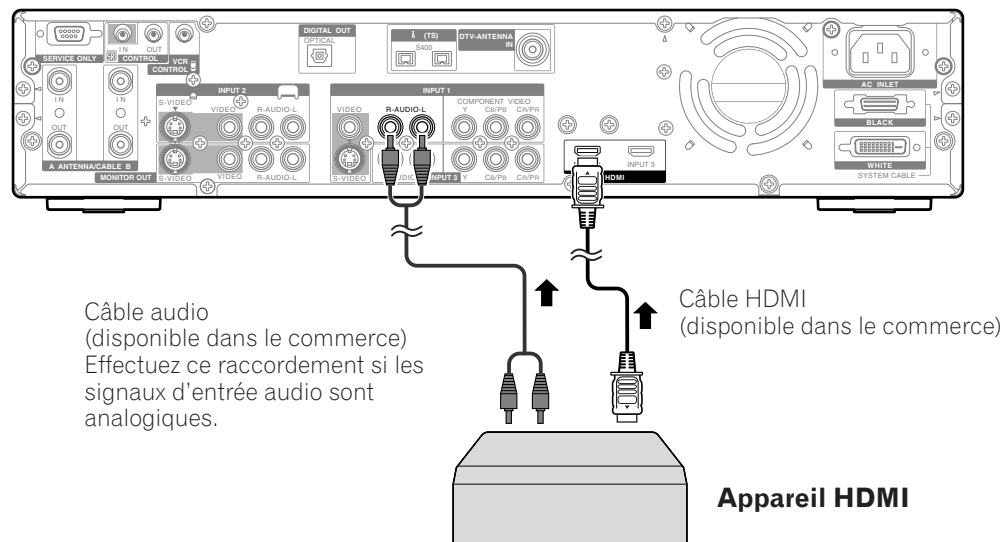

Pour mettre en service la prise HDMI:

- 1 Appuyez sur **HOME MENU**.
- 2 Utilisez **↑/↓** pour sélectionner "Options" puis appuyez sur **ENTER**.
- 3 Utilisez **↑/↓** pour sélectionner "Entrée HDMI" puis appuyez sur **ENTER**.
- 4 Utilisez **↑/↓** pour sélectionner "Réglage" puis appuyez sur **ENTER**.
- 5 Utilisez **↑/↓** pour sélectionner "Activer" puis appuyez sur **ENTER**.

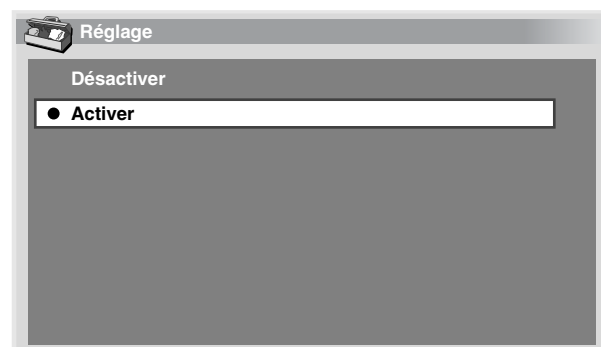

Paramètre	Description
Désactiver (valeur par défaut)	La prise HDMI n'est pas active.
Activer	La prise HDMI est active.

- 6 Appuyez sur **HOME MENU** pour quitter le menu.

**Pour préciser le type des signaux vidéo numériques:**

- 1 Appuyez sur **HOME MENU**.
- 2 Utilisez **↑/↓** pour sélectionner "Options" puis appuyez sur **ENTER**.
- 3 Utilisez **↑/↓** pour sélectionner "Entrée HDMI" puis appuyez sur **ENTER**.
- 4 Utilisez **↑/↓** pour sélectionner "Vidéo" puis appuyez sur **ENTER**.
- 5 Utilisez **↑/↓** pour sélectionner le type des signaux vidéo puis appuyez sur **ENTER**.

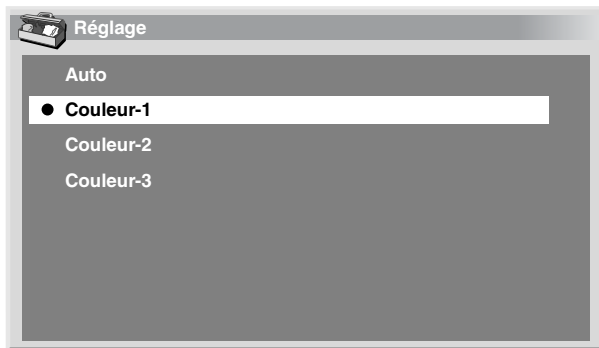

- Si vous sélectionnez "Auto", l'appareil tente d'identifier les signaux vidéonumériques lorsqu'ils sont reçus.

Paramètre	Description
Auto (valeur par défaut)	Le signal d'entrée vidéonumérique est automatiquement identifié.
Couleur-1	Signaux des composantes vidéo numériques (4:2:2) verrouillés
Couleur-2	Signaux des composantes vidéo numériques (4:4:4) verrouillés
Couleur-3	Signaux RVB numériques verrouillés

- 6 Appuyez sur **HOME MENU** pour quitter le menu.

REMARQUE

- Si vous sélectionnez une valeur autre que "Auto", effectuez le réglage de manière que les couleurs soient naturelles.
- Si aucune image n'apparaît, choisissez un autre type de signal vidéonumérique.
- Pour de plus amples détails concernant les types de signal vidéonumérique, reportez-vous au mode d'emploi qui accompagne l'appareil relié.

Pour préciser le type des signaux audionumériques:

- 1 Appuyez sur **HOME MENU**.
- 2 Utilisez **↑/↓** pour sélectionner "Options" puis appuyez sur **ENTER**.
- 3 Utilisez **↑/↓** pour sélectionner "Entrée HDMI" puis appuyez sur **ENTER**.
- 4 Utilisez **↑/↓** pour sélectionner "Audio" puis appuyez sur **ENTER**.
- 5 Utilisez **↑/↓** pour sélectionner le type des signaux audio puis appuyez sur **ENTER**.

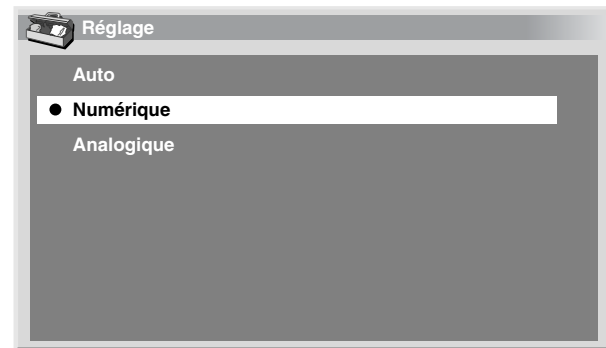

- Si vous sélectionnez "Auto", l'appareil tente d'identifier les signaux audio lorsqu'ils sont reçus.

Paramètre	Description
Auto (valeur par défaut)	Le type des signaux d'entrée audio est automatiquement identifié.
Numérique	Les signaux audionumériques sont acceptés.
Analogique	Les signaux audio analogiques sont acceptés.

- 6 Appuyez sur **HOME MENU** pour quitter le menu.

REMARQUE

- Si aucun son n'est produit, sélectionner un autre type pour les signaux audio.
- Pour de plus amples détails concernant les types de signal audio, reportez-vous au mode d'emploi qui accompagne l'appareil relié.
- Selon l'appareil relié, il vous faut également des câbles pour les signaux audio analogiques.

• HDMI, le logo HDMI et High-Definition Multimedia Interface sont des marques de fabrique ou des marques déposées de HDMI licensing LLC.

Para los procedimientos de manejo y otras funciones, consulte el manual de instrucciones dedicado.

Utilización de la entrada HDMI

Los terminales INPUT 1 e INPUT 3 incluyen terminales HDMI a los cuales pueden introducirse señales digitales de audio y vídeo. Para utilizar el terminal HDMI, active el terminal y especifique los tipos de señales de audio y vídeo que se van recibir desde el equipo conectado. Para el tipos de señales, consulte el manual de instrucciones que acompaña el equipo conectado.

Antes de iniciar el menú, pulse **INPUT 1** (o **INPUT 3**) del mando a distancia o pulse **INPUT** de la pantalla de plasma para seleccionar INPUT 1 (o INPUT 3).

Tabla de correlación de las señales de entrada

1920*1080i@59,94/60Hz
720*480p@59,94/60Hz
1280*720p@59,94/60Hz
720(1440)*480i@59,94/60Hz

NOTA

- Las señales de PC están fuera de correspondencia.

Conexión de un equipo HDMI

Media Receiver (vista trasera)

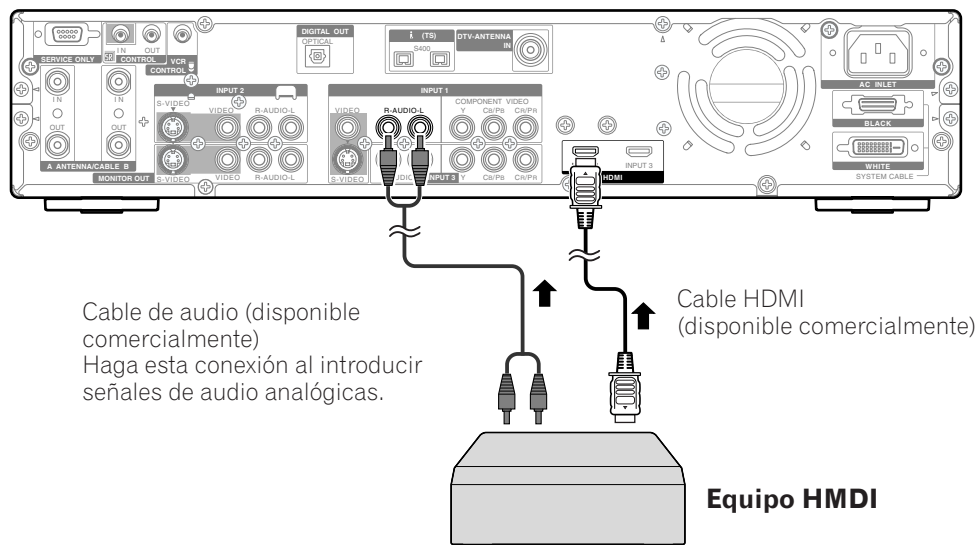

Para activar el terminal HDMI:

- 1 Pulse **HOME MENU**.
- 2 Pulse **▲/▼** para seleccionar "Opción" y, a continuación, pulse **ENTER**.
- 3 Pulse **▲/▼** para seleccionar "Entrada HDMI" y, a continuación, pulse **ENTER**.
- 4 Pulse **▲/▼** para seleccionar "Valor" y, a continuación, pulse **ENTER**.
- 5 Pulse **▲/▼** para seleccionar "Activar" y, a continuación, pulse **ENTER**.

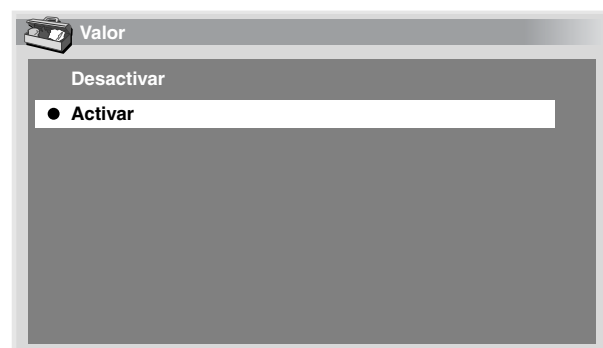

Ítem	Descripción
Desactivar (valor predeterminado)	Desactiva el terminal HDMI.
Activar	Activa el terminal HDMI.

- 6 Pulse **HOME MENU** para salir del menú.



Para especificar el tipo de señales de vídeo digitales:

- 1 Pulse **HOME MENU**.
- 2 Pulse **↑/↓** para seleccionar "Opción" y, a continuación, pulse **ENTER**.
- 3 Pulse **↑/↓** para seleccionar "Entrada HDMI" y, a continuación, pulse **ENTER**.
- 4 Pulse **↑/↓** para seleccionar "Vídeo" y, a continuación, pulse **ENTER**.
- 5 Pulse **↑/↓** para seleccionar el tipo de señales de vídeo digitales y, a continuación, pulse **ENTER**.

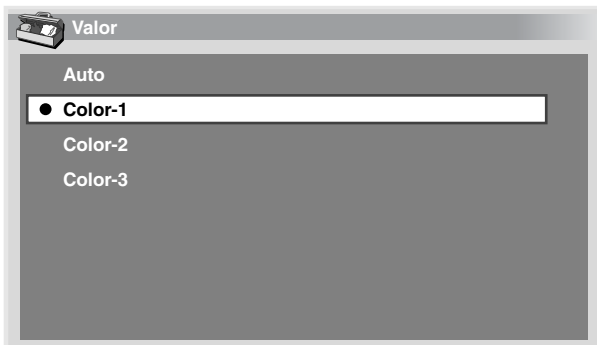

- Si se selecciona "Auto", se hará un intento para identificar el tipo de señales de vídeo digitales cuando se reciben las señales de vídeo digitales.

Ítem	Descripción
Auto (valor predeterminado)	Identifica automáticamente las señales de vídeo digitales.
Color-1	Señales de vídeo componente digitales (4:2:2) bloqueadas
Color-2	Señales de vídeo componente digitales (4:4:4) bloqueadas
Color-3	Señales RGB digitales bloqueadas

- 6 Pulse **HOME MENU** para salir del menú.

NOTA

- Si selecciona un parámetro diferente de "Auto", haga un ajuste que produzca un color natural.
- Si no aparece ninguna imagen, especifique otro tipo de señal de vídeo digital.
- Para el tipo de señales de vídeo digitales que se debe especificar, consulte el manual de instrucciones que acompaña el equipo conectado.

Para especificar el tipo de señales de audio:

- 1 Pulse **HOME MENU**.
- 2 Pulse **↑/↓** para seleccionar "Opción" y, a continuación, pulse **ENTER**.
- 3 Pulse **↑/↓** para seleccionar "Entrada HDMI" y, a continuación, pulse **ENTER**.
- 4 Pulse **↑/↓** para seleccionar "Audio" y, a continuación, pulse **ENTER**.
- 5 Pulse **↑/↓** para seleccionar el tipo de señales de audio y, a continuación, pulse **ENTER**.



- Si se selecciona "Auto", se hará un intento para identificar el tipo de señales de audio cuando se reciben las señales de audio.

Ítem	Descripción
Auto (valor predeterminado)	Identifica automáticamente las señales de audio introducidas.
Digital	Acepta las señales de audio digitales.
Analógico	Acepta las señales de audio analógicas.

- 6 Pulse **HOME MENU** para salir del menú.

NOTA

- Si no se genera ningún sonido, especifique otro tipo de señales de audio.
- Para el tipo de señales de audio que se debe especificar, consulte el manual de instrucciones que acompaña el equipo conectado.
- Dependiendo del equipo que se va a conectar, también necesita conectar cables de audio analógicos.

- HDMI, el logotipo de HDMI, y la interfaz High-Definition Multimedia Interface son marcas comerciales o marcas comerciales registradas de HDMI licensing LLC.



Published by Pioneer Corporation.
Copyright © 2003 Pioneer Corporation.
All rights reserved.

PIONEER CORPORATION 4-1, Meguro 1-Chome, Meguro-ku, Tokyo 153-8654, Japan
PIONEER ELECTRONICS [USA] INC. P.O. BOX 1540, Long Beach, California 90801-1540, U.S.A.
PIONEER ELECTRONICS OF CANADA, INC. 300 Allstate Parkway, Markham, Ontario L3R OP2, Canada
PIONEER EUROPE NV Haven 1087, Keetberglaan 1, B-9120 Melsele, Belgium TEL: 03/570.05.11
PIONEER ELECTRONICS AUSTRALIA PTY. LTD. 178-184 Boundary Road, Braeside, Victoria 3195, Australia, TEL: [03] 9586-6300
PIONEER ELECTRONICS DE MEXICO S.A. DE C.V. Blvd. Manuel Avila Camacho 138, 10 piso Col. Lomas de Chapultepec, Mexico, D.F. 11000
TEL: 52-55-9178-4270 FAX: 52-55-5202-3714

<03H00001>

Printed in Japan / Imprimé au Japon <ARE1373-A>



Free Manuals Download Website

<http://myh66.com>

<http://usermanuals.us>

<http://www.somanuals.com>

<http://www.4manuals.cc>

<http://www.manual-lib.com>

<http://www.404manual.com>

<http://www.luxmanual.com>

<http://aubethermostatmanual.com>

Golf course search by state

<http://golfingnear.com>

Email search by domain

<http://emailbydomain.com>

Auto manuals search

<http://auto.somanuals.com>

TV manuals search

<http://tv.somanuals.com>