

Multi-CD/MD control High power Minidisc player
with RDS tuner

ENGLISH



MEH-P5000R

Operation Manual

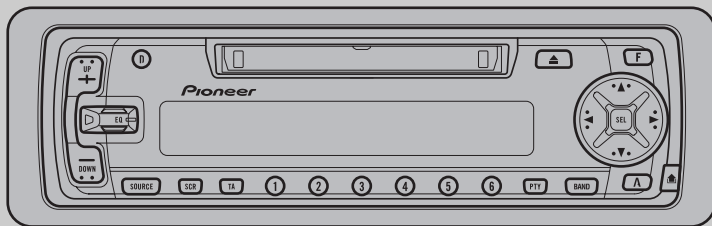

Pioneer

Connecting the Units	5	Entering the Detailed Setting Menu	27
		Detailed Setting Menu Functions	28
RFP Alert Installation	8	Tuner Operation	29
Description	8	● Local Seek Tuning (LOCAL)	
Door Switches	8	● Best Stations Memory (BSM)	
DOOR SWITCH (White/Yellow)	9	Using RDS Functions	30
● Grounding Type Switch:		What is RDS ?	30
● Positive (Non-grounding) Type Switch:		Program Service Name Display	30
● Installing New Pin Switches		AF Function (AF)	31
		● Activating/Deactivating the AF Function	
Installation	11	PI Seek Function	32
Installation with the rubber bush	12	● PI Seek	
Removing the Unit	13	● Auto PI Seek (for preset station)	
Key Finder	14	Regional Function (REG)	32
● Head Unit		● Activating REG	
● Remote Controller (CD-R66)		TA Function (TA)	33
		● Activating/Deactivating the TA Function	
Before Using This Product	15	● Canceling Traffic Announcements	
About This Product	15	● Adjusting the TA Volume	
About This Manual	15	● TP Alarm Function	
About Optional Remote Controller (CD-R66) ..	16	PTY Function	35
Resetting the Microprocessor	16	● Searching the PTY	
Precaution	17	● News Program Interruption Setting	
In Case of Trouble	17	● PTY Alarm	
		● Canceling Emergency Announcements	
Basic Operation	18	● PTY List	
To Listen to Music	18	Using the Built-in MD Player	39
Basic Operation of Tuner	20	● Repeat Play (REPEAT)	
● Manual and Seek Tuning		● Random Play (RANDOM)	
● Band		● Scan Play (T-SCAN)	
● Preset Tuning		● Pause (PAUSE)	
Basic Operation of Built-in MD Player	21	Using Multi-CD Players	41
● Switching the Display		● Repeat Modes (REPEAT)	
● Scrolling the Display		● Random Play (RANDOM)	
● Disc Loading Slot		● Scan Play (SCAN)	
● Eject		● Pause (PAUSE)	
● Track Search and Fast Forward/Reverse		● CD Sound Quality Adjustment (COMP)	
Basic Operation of Multi-CD Player	22	ITS (Instant Track Selection)	44
● Switching the Multi-CD Player		● ITS Programming (ITS)	
● Switching the Display		● ITS Play (ITS-P)	
● Disc Search		● Erase a Track Pprogram	
● Track Search and Fast Forward/Reverse		● Erase a Disc Program	
● Disc Number Search		Disc Title	46
(for 6-Disc, 12-Disc types)		● Disc Title Input (TITLE IN)	
● Disc Number Rough Search		● Disc Title List (TITLE LIST)	
(for 50-Disc type only)			
Corresponding Display Indications and			
Buttons	24		
Entering the Function Menu	24		
Function Menu Functions	25		

Audio Adjustment	48	Other Functions	61
Selecting the Equalizer Curve	48	Time Display	61
Entering the Audio Menu	48	● Displaying the Time	
Audio Menu Functions	49	Using the PGM Button (PGM-FUNC)	61
● Balance Adjustment (FADER)		● Setting the PGM Button	
● Equalizer Curve Adjustment (EQ-LOW/MID/HIGH)		● Using the PGM Button	
● Equalizer Curve Fine Adjustment		Using the AUX Source	63
● Loudness Adjustment (LOUD)		● Selecting the AUX Source	
● Front Image Enhancer Function (FIE)		● AUX Title Input	
● Source Level Adjustment (SLA)		Cellular Telephone Muting	63
Detaching and Replacing the Front Panel	52	MD Player and Care	64
Theft Protection	52	Precaution	64
● Detaching the Front Panel		Built-in MD Player's Error Message	65
● Replacing the Front Panel		Specifications	66
● Warning Tone			
Initial Setting	53		
Entering the Initial Setting Menu	53		
Initial Setting Menu Functions	54		
● Setting the Time			
● Changing the FM Tuning Step (FM STEP)			
● Switching the Auto PI Seek (A-PI)			
● Setting the Warning Tone (WARN)			
● Switching the AUX Mode (AUX)			
● Setting the Dimmer (DIMMER)			
● Selecting the Illumination Color (ILL. CLR)			
RFP Alert Function	57		
Activating the RFP Alert Feature	57		
Setting Entry Delay Time	57		
Activating Internal Speaker ON/OFF	58		
● Speaker Volume Output Adjustment			
Selecting Door Switching Systems	59		
● Door System Confirmation			
Operation of "RFP Alert"	60		
Arming Alert	60		
Disarming Alert	60		
Entry Detection	60		



Note:

- This unit is for vehicles with a 12-volt battery and negative grounding. Before installing it in a recreational vehicle, truck, or bus, check the battery voltage.
- To avoid shorts in the electrical system, be sure to disconnect the \ominus battery cable before beginning installation.
- Refer to the owner's manual for details on connecting the power amp and other units, then make connections correctly.
- Secure the wiring with cable clamps or adhesive tape. To protect the wiring, wrap adhesive tape around them where they lie against metal parts.
- Route and secure all wiring so it cannot touch any moving parts, such as the gear shift, handbrake, and seat rails. Do not route wiring in places that get hot, such as near the heater outlet. If the insulation of the wiring melts or gets torn, there is a danger of the wiring short-circuiting to the vehicle body.
- Don't pass the yellow lead through a hole into the engine compartment to connect to the battery. This will damage the lead insulation and cause a very dangerous short.
- Do not shorten any leads. If you do, the protection circuit may fail to work when it should.
- Never feed power to other equipment by cutting the insulation of the power supply lead of the unit and tapping into the lead. The current capacity of the lead will be exceeded, causing overheating.
- When replacing fuse, be sure to use only fuse of the rating prescribed on the fuse holder.
- Since a unique BPTL circuit is employed, never wire so the speaker leads are directly grounded or the left and right \ominus speaker leads are common.
- The black lead is ground. Please ground this lead separately from the ground of high-current products such as power amps.

If you ground the products together and the ground becomes detached, there is a risk of damage to the products or fire.

- Speakers connected to this unit must be high-power types possessing minimum rating of 40 W and impedance of 4 to 8 ohms. Connecting speakers with output and/or impedance values other than those noted here can damage the speakers.
- When an external power amp is being used with this system, be sure not to connect the blue/white lead to the amp's power terminal. Likewise, do not connect the blue/white lead to the power terminal of the auto-antenna. Such connection could cause excessive current drain and malfunction.
- To prevent incorrect connection, the input side of the IP-BUS connector is blue, and the output side is black. Connect the connectors of the same colors correctly.
- If this unit is installed in a vehicle that does not have an ACC (accessory) position on the ignition switch, the red lead of the unit should be connected to a terminal coupled with ignition switch ON/OFF operations. If this is not done, the vehicle battery may be drained when you are away from the vehicle for several hours.



ACC position

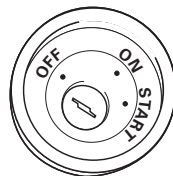

No ACC position

Connecting the Units

Note:

Depending on the kind of vehicle, the function of 3* and 5* may be different. If this is the case, be sure to connect 2* to 5* and 4* to 3*.

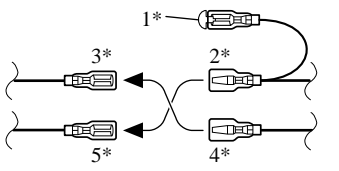

Connect leads of the same color to each other.

Cap (1*)

When not using this terminal, do not remove the cap.

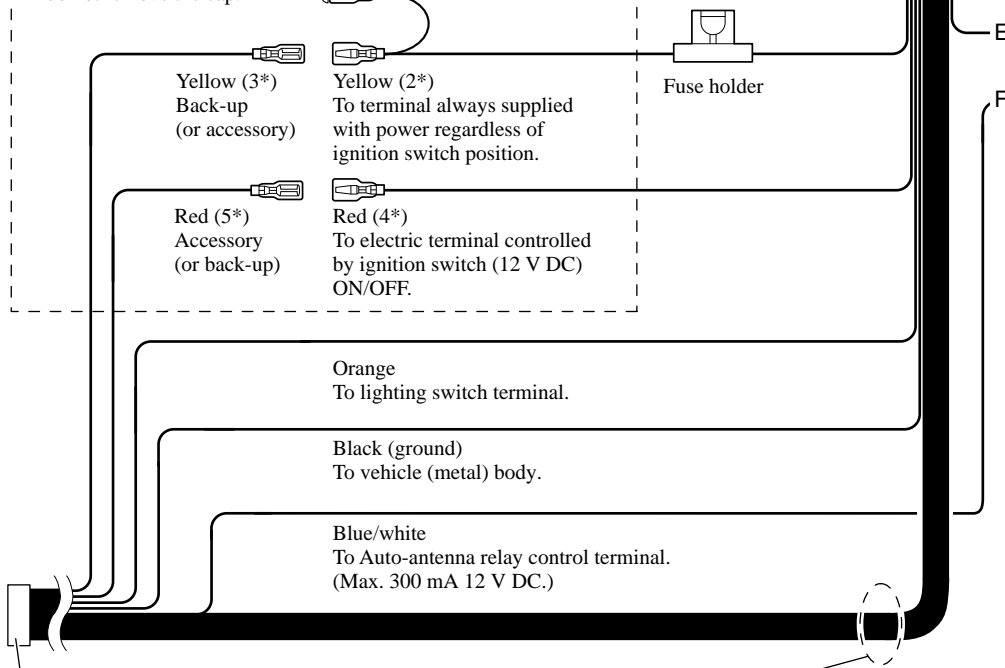

ISO connector

Note:

In some vehicles, the ISO connector may be divided into two. If this is the case, be sure to connect to both connectors.

See the section "RFP Alert Installation".

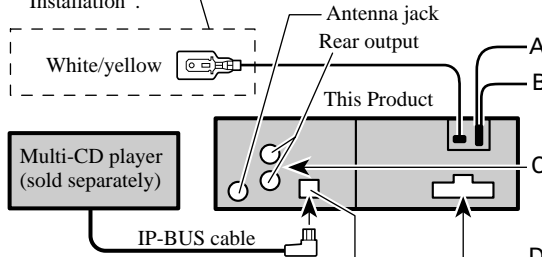

IP-BUS input (Blue)

Fuse holder

White	: Front left ⊕	Green	: Rear left ⊕
White/black	: Front left ⊖	Green/black	: Rear left ⊖
Gray	: Front right ⊕	Violet	: Rear right ⊕
Gray/black	: Front right ⊖	Violet/black	: Rear right ⊖

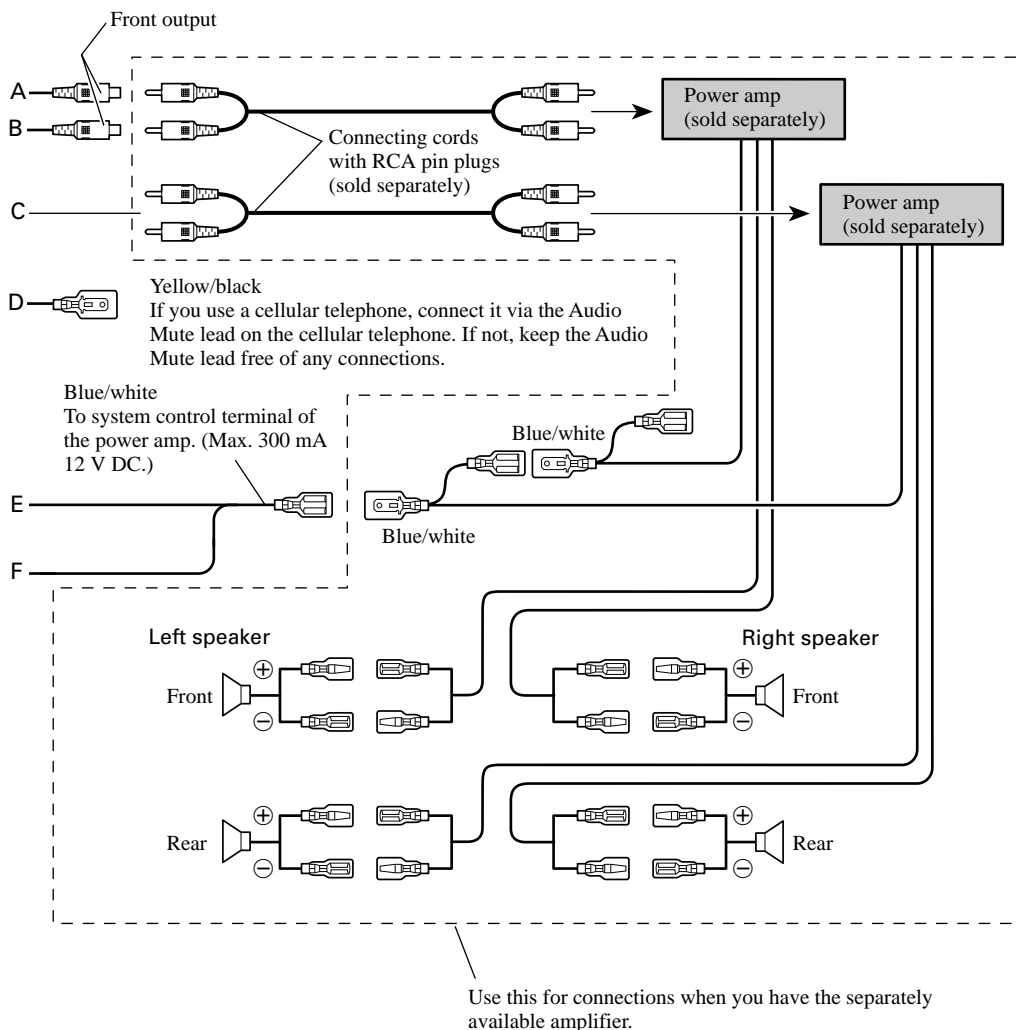

CAUTION

- Cords for this unit and those for other units may be different colors even if they have the same function. When connecting this unit to another unit, refer to the supplied Installation manuals of both units and connect cords that have the same function.

CAUTION

- Because of the complexity of today's technically advanced vehicle wiring systems, we recommend that your RFP Alert be installed **ONLY** by a professional Pioneer installer.

Affix the included deterrent stickers to the inside of the front door windows.

Description

■ **White/Yellow (DOOR SWITCH) (Fig. see next page)**

This lead is used to trigger RFP Alert when any door is opened and may be connected to either positive or negative (+/-) type door pin switches.

Door Switches

The RFP Alert's door trigger input is designed to work with either positive or negative door pin switches. After hookup, simply set door system type from RFP Alert Setting Menu.

Domelight Delay-RFP Alert will wait for last door to close and courtesy light to turn off before Exit Delay Timer Starts.

DOOR SWITCH (White/Yellow)

Grounding Type Switch:

Most European, Japanese, GM and Chrysler vehicles.

Note:

- Set RFP Alert to recognize ground trigger from RFP Alert Setting Menu. Set Door System to "DOOR-L :CLS".

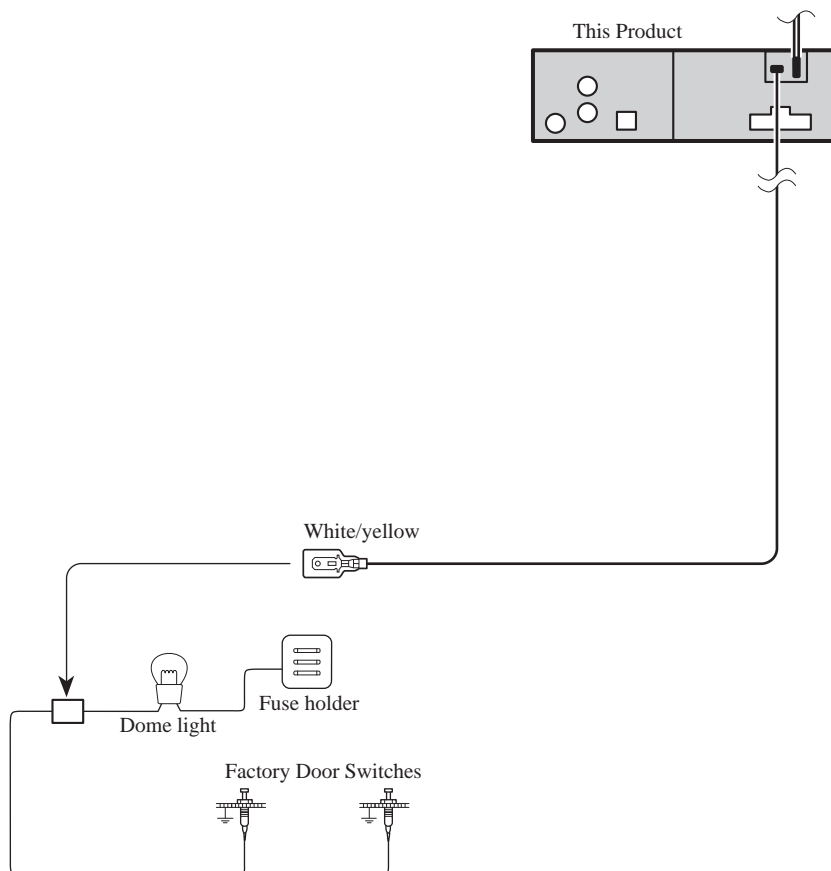

Positive (Non-grounding) Type Switch:

Jaguar, Mercedes, Ford

Note:

- Set RFP Alert to recognize positive trigger from RFP Alert Setting Menu. Set Door System to "DOOR-H :CLS".

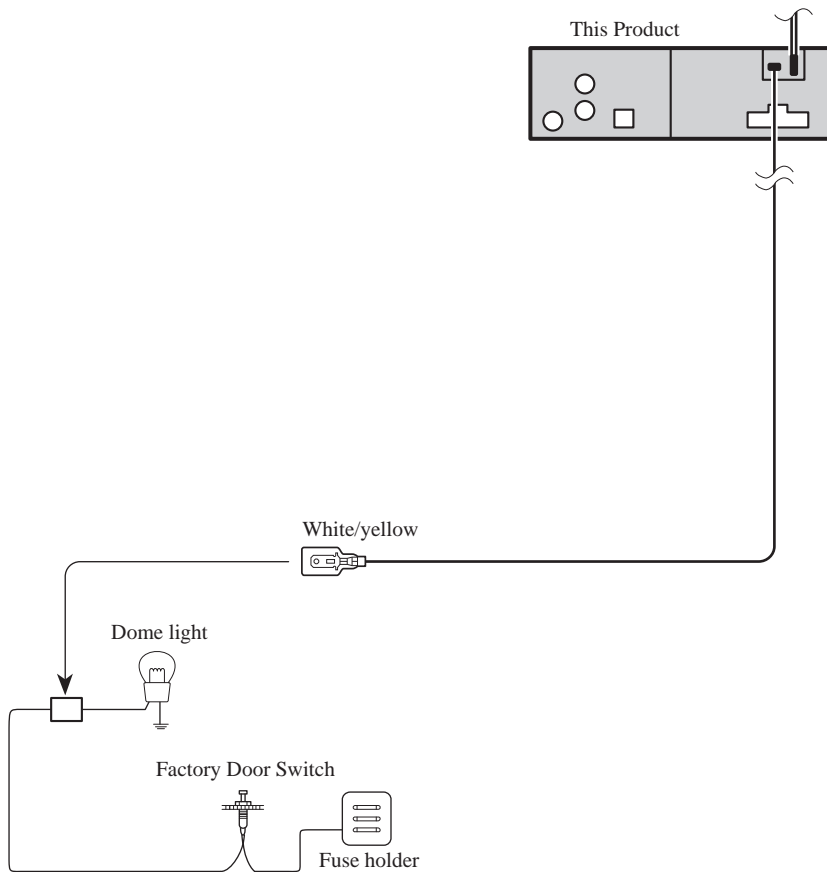

Installing New Pin Switches

Separately sold pin switches are available that can be used to protect your vehicle's trunk, hood etc. When you purchase these, make sure that you first confirm that they can be used with your vehicle's door system type.

Follow the makers instructions as to installation and wiring.

Note:

- Before finally installing the unit, connect the wiring temporarily, making sure it is all connected up properly, and the unit and the system work properly.
 - Use only the parts included with the unit to ensure proper installation. The use of unauthorized parts can cause malfunctions.
 - Consult with your nearest dealer if installation requires the drilling of holes or other modifications of the vehicle.
 - Install the unit where it does not get in the driver's way and cannot injure the passenger if there is a sudden stop, like an emergency stop.
 - The semiconductor laser will be damaged if it overheats, so don't install the unit anywhere hot — for instance, near a heater outlet.
- If installation angle exceeds 30° from horizontal, the unit might not give its optimum performance.

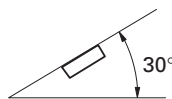

Installation with the rubber bush

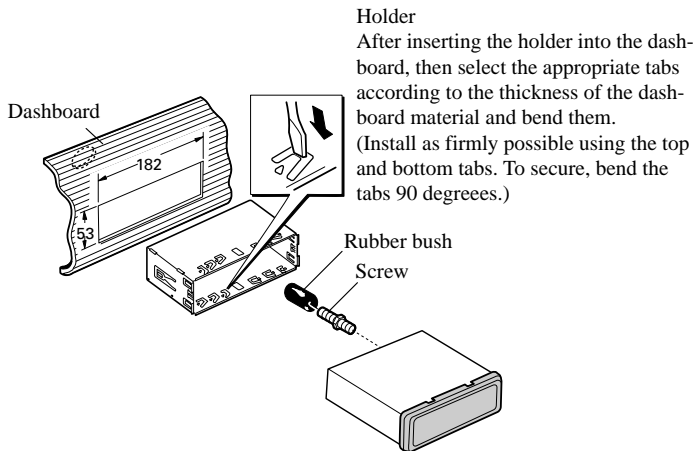

Removing the Unit

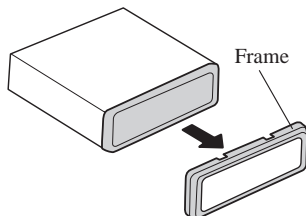

Insert the supplied extraction keys into the unit, as shown in the figure, until they click into place. Keeping the keys pressed against the sides of the unit, pull the unit out.

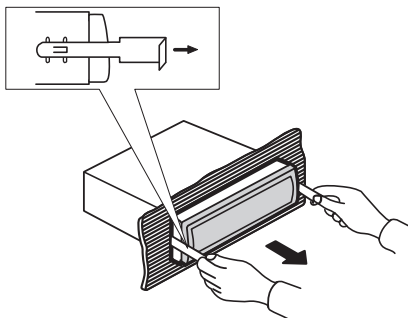

Head Unit

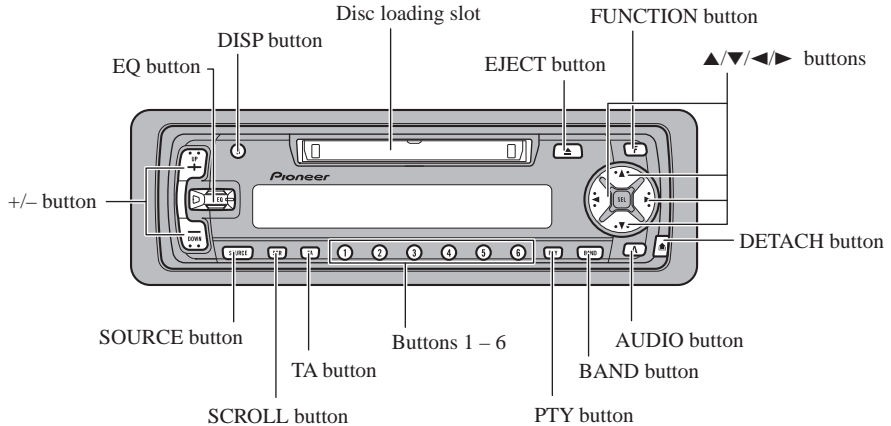

Remote Controller (CD-R66)

The remote controller (CD-R66) enabling remote control of the head unit is sold separately. Operation is the same as when using buttons on the head unit.

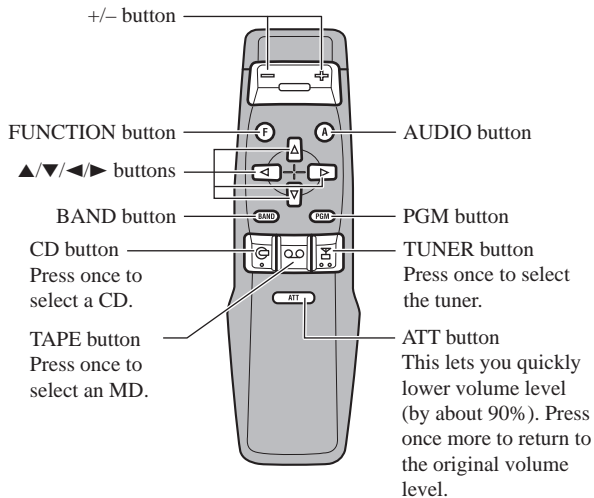

About This Product

- This product complies with the EMC Directives (89/336/EEC, 92/31/EEC) and CE Marking Directive (93/68/EEC).

The tuner frequencies on this product are allocated for use in Western Europe, Asia, the Middle East, Africa and Oceania. Use in other areas may result in improper reception. The RDS function operates only in areas with FM stations broadcasting RDS signals.

About This Manual

This product features a number of sophisticated functions ensuring superior reception and operation. All are designed for the easiest possible use, but many are not self-explanatory. This operation manual is intended to help you benefit fully from their potential and to maximize your listening enjoyment.

We recommend that you familiarize yourself with the functions and their operation by reading through the manual before you begin using this product. It is especially important that you read and observe the "Precaution" on page 17 and in other sections.

This manual explains head unit operation. You can perform the same operations with the remote controller (CD-R66). The remote controller enables one-touch source changing and pause operation, and offers the convenience of ATT, a function not provided on the head unit.

About Optional Remote Controller (CD-R66)

Open the cover on the rear of the optional remote controller (CD-R66), and you'll find a switch. Do not change this switch's position from the MAIN UNIT position. (Initially, the switch is set to the MAIN UNIT position.) If you change the switch setting, correct operation of this product will not be possible.

Resetting the Microprocessor

The microprocessor must be reset under the following conditions:

When using this product for the first time after installation.

When the product fails to operate properly.

When strange (incorrect) messages appear on the display.

- **To reset the microprocessor, remove the front panel as described on page 52 and press the RESET button on the head unit with a pen tip or other pointed instrument.**

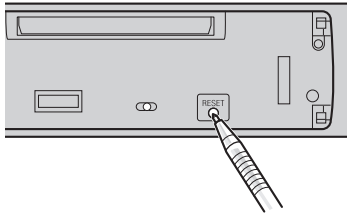

Precaution

- A “CLASS 1 LASER PRODUCT” label is affixed to the bottom of the player.



- The Pioneer CarStereo-Pass is for use only in Germany.
- Keep this manual handy as a reference for operating procedures and precautions.
- Always keep the volume low enough for outside sounds to be audible.
- Protect the product from moisture.
- If the battery is disconnected, the preset memory will be erased and must be reprogrammed.

In Case of Trouble

Should this product fail to operate properly, contact your dealer or nearest authorized Pioneer Service Station.

To Listen to Music

The following explains the initial operations required before you can listen to music.

Note:

- Loading a disc in this product. (Refer to page 21.)

1. Select the desired source (e.g. tuner).

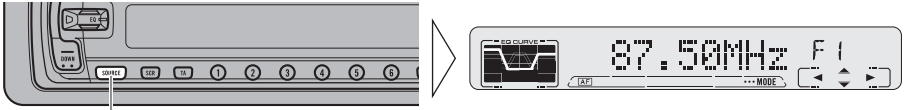

Each press changes the Source ...

■ Head Unit

Each press of the SOURCE button selects the desired source in the following order:
Tuner → Built-in MD player → Multi-MD player → Multi-CD player → AUX

■ Remote Controller

Each press of the button selects the desired source in the following order:

TUNER button : Tuner → Sources OFF

CD button : Multi-CD player → Sources OFF

TAPE button : Built-in MD player → Multi-MD player → AUX → Sources OFF

Note:

- In the following cases, the sound source will not change:
 - * No Multi-CD player is connected to this product.
 - * No Multi-MD player is connected to this product.
 - * No disc is set in this product.
 - * No magazine is set in the Multi-CD player.
 - * No disc is set in the Multi-MD player.
 - * AUX (external input) is set to OFF. (Refer to page 55.)

2. Raise or lower the volume.



3. Source OFF.

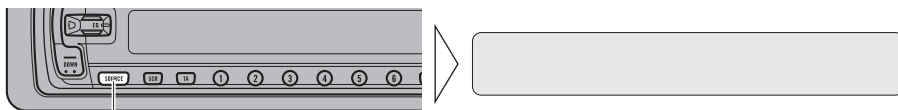

Hold for 1 second or more

Basic Operation of Tuner

This product's AF function can be switched ON and OFF. AF should be switched OFF for normal tuning operations.

Manual and Seek Tuning

- You can select the tuning method by changing the length of time you press the ◀▶ button.

Manual Tuning (step by step)	0.5 seconds or less
Seek Tuning (automatically)	Press for 0.5 seconds or more and then release.
Manual Tuning (continuously)	Continue pressing for 0.5 seconds or more without releasing. (When you release the button, Seek Tuning is selected.)

Note:

- “◉” stereo indicator lights when a stereo station is selected.

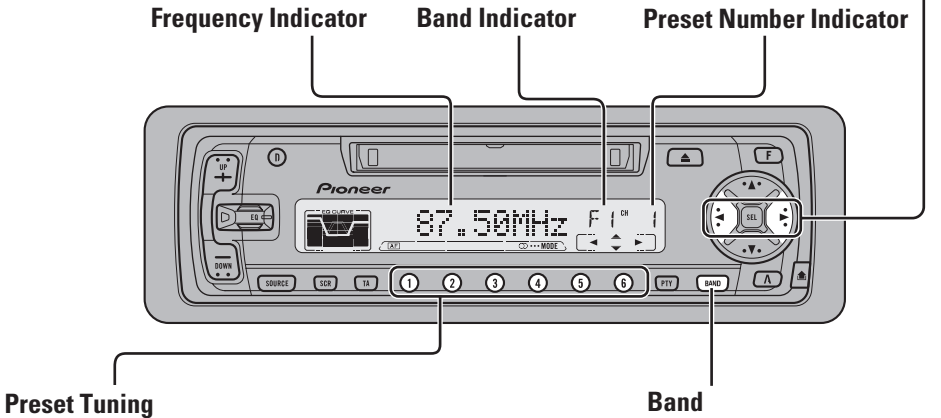

- You can memorize broadcast stations in buttons 1 through 6 for easy, one-touch station recall.

Preset station recall	2 seconds or less
Broadcast station preset memory	2 seconds or more

Note:

- Up to 18 FM stations (6 in F1 (FM1), F2 (FM2) and F3 (FM3)) and 6 MW/LW stations can be stored in memory.
- You can also use the ▲ or ▼ buttons to recall broadcast stations memorized in buttons 1 through 6.

F1 (FM1) → F2 (FM2)
→ F3 (FM3) → MW/LW

Basic Operation of Built-in MD Player

Switching the Display

Each press of the DISP button changes the display in the following order:

Playback mode (Elapsed play time)

→ Disc Title → Track Title

Eject

Note:

- The MD function can be turned ON/OFF with the disc remaining in this product. (Refer to page 18.)
- Discs left partially inserted after ejection may incur damage or fall out.

Disc Loading Slot

You can only load one MD at a time in the built-in MD player. Load the MD in the direction of the arrow, with the label side facing up.

Note:

- Load an MD after confirming the MD shutter (refer to page 64) is closed.

Scrolling the Display

Displayed disc and track names are only up to 10 letters long, but indications can be scrolled.

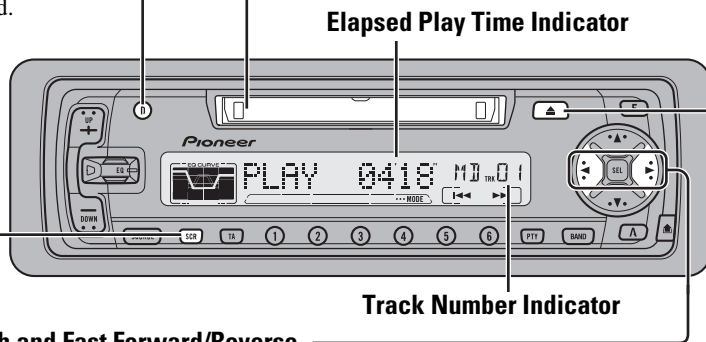

Track Search and Fast Forward/Reverse

- You can select between Track Search or Fast forward/Reverse by pressing the ◀▶ button for a different length of time.

Track Search	0.5 seconds or less
Fast forward/Reverse	Continue pressing

Note:

- When you load a disc, this unit reads information recorded on the disc such as the number of tracks. While the disc is being read, "TOC READ" is indicated in the display.
- If you load a disc with the arrow pointing in the wrong direction, it is automatically ejected.
- If the built-in MD player cannot operate properly, an error message (such as "ERROR-11") appears on the display. Refer to "Built-in MD Player's Error Message" on page 65.

Basic Operation of Multi-CD Player

This product can control one or more multi-CD players. (There are some types of Multi-CD players such as CDX-P630S which you cannot connect more than one.)

Track Search and Fast Forward/Reverse

- You can select between Track Search or Fast forward/Reverse by pressing the ◀/▶ button for a different length of time.

Track Search	0.5 seconds or less
Fast forward/Reverse	Continue pressing

Switching the Display

Each press of the DISP button changes the display in the following order:

Playback mode (Elapsed play time) → Disc Title

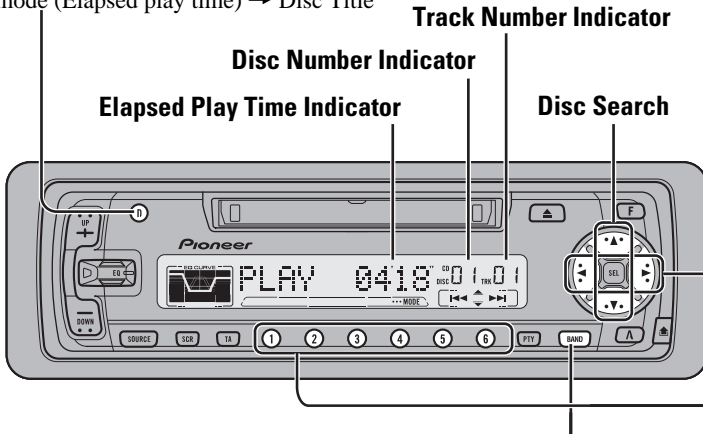

Switching the Multi-CD Player

Using a multiple connection adapter lets you connect up to three Multi-CD players.

M-CD 1 → M-CD 2 → M-CD 3
(Displayed about for 2 seconds.)

Disc Number Search (for 6-Disc, 12-Disc types)

- **You can select discs directly with the 1 to 6 buttons. Just press the number corresponding to the disc you want to listen to.**

Note:

- When a 12-Disc Multi-CD Player is connected and you want to select disc 7 to 12, press the 1 to 6 buttons for 2 seconds or longer.

Disc Number Rough Search (for 50-Disc type only)

This handy function lets you select discs loaded in a 50-Disc Multi-CD Player using the 1 to 5 buttons. The 50 discs are divided into five blocks, with each of the 1 to 5 buttons assigned to a block.

- **Select the desired block with the 1 to 5 buttons.**

Note:

- After completing a rough search, use the ▲ and ▼ buttons to select a desired disc.

Note:

- If you switch displays when disc titles have not been input, “NO TITLE” is displayed .
- The multi-CD player may perform a preparatory operation, such as verifying the presence of a disc or reading disc information, when the power is turned ON or a new disc is selected for playback. “READY” is displayed.
- When a magazine is loaded into a 50-Disc type Multi-CD Player, information on all the discs in the magazine is read.

If you start playing a disc on a 50-Disc type Multi-CD Player before reading of information on all discs has been completed, reading of information stops part way through. This will prevent you from using a number of functions. (If you try and use these functions, “NOT READY” is displayed.)

If this happens, reading of information begins again when you switch to a component other than the 50-Disc type Multi-CD Player.

- If the multi-CD player cannot operate properly, an error message such as “ERROR-14” is displayed. Refer to the multi-CD player owner’s manual.
- If there are no discs in the multi-CD player magazine, “NO DISC” is displayed.
- “LOAD” will be displayed in the following cases:
 - * If the disc in the extra tray is selected.
 - * If the disc in moved from the extra tray to the magazine.
(Refer to the 50-Disc type multi-CD player owner’s manual.)
- You cannot use the “Ejecting a Single Disc”, “Frequency Play”, “Music Group Play” or “ABC Disc Title Search” functions with this unit.

Corresponding Display Indications and Buttons

This product's display features Key Guidance Indicators. These light to indicate which of the ▲/▼/◀/▶, FUNCTION and AUDIO buttons you can use. When you're in the Function Menu (refer to next section), Detailed Setting Menu (refer to page 27), Initial Setting Menu (refer to page 53) or Audio Menu (refer to page 48), they also make it easy to see which ▲/▼/◀/▶ buttons you can use to switch functions ON/OFF, switch repeat selections and perform other operations.

Indicator and corresponding buttons are shown below.

■ Head Unit

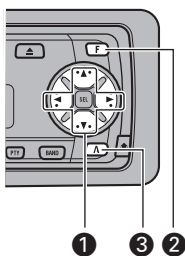

■ Remote Controller



■ Display

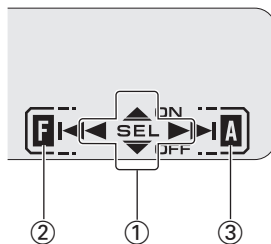

When ① is lit in the display, perform appropriate operations with the ① buttons.

When ② is lit in the display, it indicates that you are in the Function Menu, Detailed Setting Menu or Initial Setting Menu. You can switch between each of these menus and between different modes in the menus using button ② on the head unit or remote controller.

When ③ is lit in the display, it indicates you are in the Audio Menu. You can switch between modes in the Audio Menu using button ③ on the head unit or remote controller.

Entering the Function Menu

The Function Menu lets you operate simple functions for each source.

Note:

- After entering the Function Menu, if you do not perform an operation within about 30 seconds, the Function Menu is automatically canceled.

1. Select the desired mode in the Function Menu. (Refer to “Function Menu functions”.)

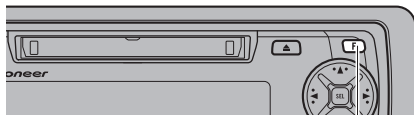

Each press changes the Mode ...



2. Operate a mode. (e.g. Repeat Play)

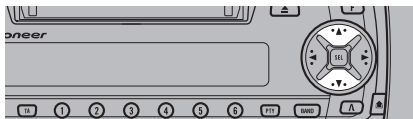

The button used and the operation it performs are indicated by the key guidance indicator. Press the ▲ button to switch the key guidance indicator ON, and the ▼ button to switch it OFF.

3. Cancel the Function Menu.

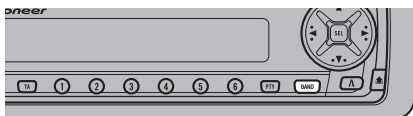

Function Menu Functions

The following chart shows functions for each source in the Function Menu. The chart also shows indications for each function, operations and buttons used to perform operations. For more details, or when you want to know about an operation, refer to the page number indicated in the chart.

■ Tuner

Function name (Display)	Button: Operation	Page
Best Stations Memory (BSM)	▲:ON ▼:OFF	29
Regional Function (REG)	▲:ON ▼:OFF	32
Local Seek Tuning (LOCAL)	1 ▲:ON ▼:OFF 2 ◀ or ▶:Select (Sensitivity)	29
TA Function (TA)	▲:ON ▼:OFF	33
AF Function (AF)	▲:ON ▼:OFF	31

■ Built-in MD Player

Function name (Display)	Button: Operation	Page
Repeat Play (REPEAT)	▲:ON ▼:OFF	39
Random Play (RANDOM)	▲:ON ▼:OFF	39
Scan Play (T-SCAN)	▲:ON ▼:OFF	40
Pause (PAUSE)	▲:ON ▼:OFF	40

■ Multi-CD Player

Function name (Display)	Button: Operation	Page
Repeat Modes (REPEAT)	◀ or ▶:Select (Play range)	41
Disc Title List (TITLE LIST)	1 ◀ or ▶:Select (Disc Title) 2 ▲:Play	47
Random Play (RANDOM)	▲:ON ▼:OFF	41
Scan Play (SCAN)	▲:ON ▼:OFF	42
ITS Play (ITS-P)	▲:ON ▼:OFF	44
Pause (PAUSE)	▲:ON ▼:OFF	43
CD Sound Quality Adjustment (COMP)	▲ or ▼:Select (Sound Quality Function)	43

Entering the Detailed Setting Menu

In the Detailed Setting Menu, you can operate convenient, complex functions for each source.

1. Enter the Detailed Setting Menu.

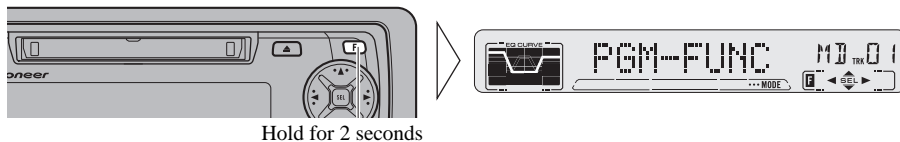

2. Select the desired mode. (Refer to “Detailed Setting Menu functions”).

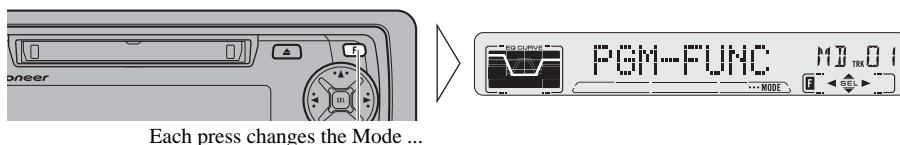

3. Operate a mode.

4. Cancel the Detailed Setting Menu.



Note:

- You can cancel the Detailed Setting Menu by pressing the FUNCTION button again for 2 seconds or more.

Detailed Setting Menu Functions

The following chart shows functions for each source in the Detailed Setting Menu. The chart also shows indications for each function, operations and buttons used to perform operations. For more details, or when you want to know about an operation, refer to the page number indicated in the chart.

■ Tuner

Function name (Display)	Button: Operation	Page
Programmable Function (PGM-FUNC)	1 ◀ or ▶:Select (Function) 2 ▲:Memory	61

■ Built-in MD Player

Function name (Display)	Button: Operation	Page
Programmable Function (PGM-FUNC)	1 ◀ or ▶:Select (Function) 2 ▲:Memory	61

■ Multi-CD Player

Function name (Display)	Button: Operation	Page
Disc Title Input (TITLE IN)	1 ▲ or ▼:Select (Letter) 2 ◀ or ▶:Select (Position) 3 ▶:Memory	46
ITS Programming (ITS)	▲:Memory	44
Programmable Function (PGM-FUNC)	1 ◀ or ▶:Select (Function) 2 ▲:Memory	61

Local Seek Tuning (LOCAL)

When Local mode is ON, you can only select broadcast stations providing strong reception.

1. Press the **FUNCTION** button and select the **Local mode (LOCAL)** in the **Function Menu**.
2. Switch the **Local ON/OFF** with the **▲/▼** buttons.

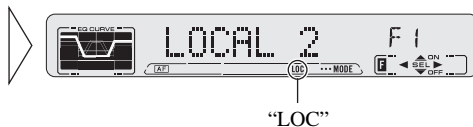

3. Select the desired **Local Seek sensitivity** with the **◀/▶** buttons.



FM : LOCAL 1 ↔ LOCAL 2 ↔ LOCAL 3 ↔ LOCAL 4
 MW/LW : LOCAL 1 ↔ LOCAL 2

Note:

- The LOCAL 4 setting allows reception of only the strongest stations, while lower settings let you receive progressively weaker stations.

Best Stations Memory (BSM)

The BSM (Best Stations Memory) function stores stations in memory automatically.

1. Press the **FUNCTION** button and select the **BSM mode (BSM)** in the **Function Menu**.
2. Switch the **BSM ON** with the **▲** button.

The stations with the strongest signals will be stored under buttons 1–6 and in order of their signal strength.



- To cancel the process, press the **▼** button in the **Function Menu** before memorization is complete.



What is RDS?

RDS (Radio Data System) is a system for transmitting data along with FM programs. This data, which is inaudible, provides a variety of features such as: program service name, program type display, traffic announcement standby, automatic tuning and program type tuning, intended to aid radio listeners in tuning to a desired station.

Note:

- RDS service may not be provided by all stations.
- RDS functions, like AF (Alternative Frequencies search) and TA (Traffic Announcement standby), are only active when your radio is tuned to RDS stations.

Program Service Name Display

With this function, the names of networks/stations providing RDS services replace the frequency on the display a few seconds after they are tuned in.

- **When you want to know PTY Information or the frequency of the current station, change the display.**



Each press changes the Display ...

Each press of the DISP button selects the display in the following order:
Program Service Name → PTY Information → Frequency

Note:

- After switching displays, if you do not perform an operation within 8 seconds, the Program Service Name is automatically displayed.

■ Displaying PTY Information

PTY (Program Type ID code) information for the currently tuned station appears on the display for 8 seconds. The information is correlated with the list in the section “PTY List” on page 38.

■ Frequency

The frequency of the current station appears on the display.

AF Function (AF)

The AF (Alternative Frequencies search) function is used to search for other frequencies in the same network as the currently tuned station. It automatically retunes the receiver to another frequency in the network which is broadcasting a stronger signal when there are problems with reception of the currently tuned station or better reception is possible on a different frequency.

Note:

- AF tunes the receiver only to RDS stations when you use Seek tuning or BSM Auto Memory with the “AF” indicator ON.
- When you recall a preset station, the tuner may update the preset station with a new frequency from the station’s AF list. (This is only available when using presets on the FM1 band.) No preset number appears on the display if the RDS data for the station received differs from that for the originally stored station.
- Sound may be temporarily interrupted by another program during an AF frequency search.
- When the tuner is tuned to a non-RDS station, the “AF” indicator flashes.
- AF can be switched ON or OFF independently for each FM band.

Activating/Deactivating the AF Function

AF is set to ON by default.

1. Press the **FUNCTION** button and select the **AF mode (AF)** in the **Function Menu**.
2. Activate or deactivate AF while in an FM band.

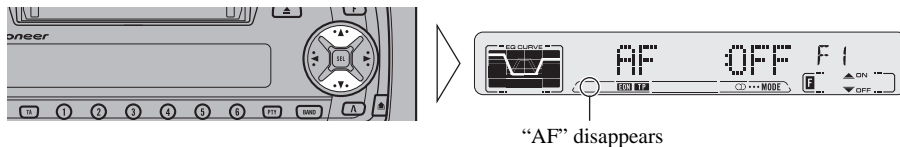

PI Seek Function

The tuner searches for another frequency broadcasting the same programming. “PI SEEK” appears on the display and the radio volume is muted during a PI Seek. The muting is discontinued after completion of the PI Seek, whether or not the PI seek has succeeded. If the PI Seek is unsuccessful, the tuner returns to the previous frequency.

PI Seek

If the tuner fails to locate a suitable alternative frequency or if the broadcasting signal is too weak for proper reception, the PI Seek will automatically start.

Auto PI Seek (for preset station)

When preset stations cannot be recalled, as when traveling long distances, the product can be set to perform PI Seek also during preset recall.

The default setting for Auto PI Seek is OFF.

Note:

- Refer to “Initial Setting Menu” for details on how to switch Auto PI Seek ON/OFF.

Regional Function (REG)

When AF is used to retune the tuner automatically, REG (Regional) limits the selection to stations broadcasting regional programs.

Note:

- Regional programming and regional networks are organized differently depending on the country (i.e., they may change according to the hour, state or broadcast area).
- The preset number may disappear on the display if the tuner tunes in a regional station which differs from the originally set station.

Activating REG

The REG function can be turned ON independently for each FM band.

1. Press the **FUNCTION** button and select the **REG** mode (**REG**) in the **Function Menu**.
2. Activate or deactivate **REG** while in an **FM** band.

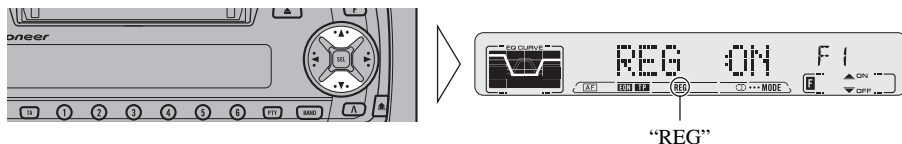

TA Function (TA)

The TA (Traffic Announcement standby) function lets you receive traffic announcements automatically, no matter what source (tuner, built-in MD player, multi-MD player or multi-CD player) you are listening to. The TA function can be activated for either a TP station (a station that broadcasts traffic information) or an EON TP station (a station carrying information which cross-references TP stations).

Activating/Deactivating the TA Function

1. Tune in a TP or EON TP station.

The “TP” indicator lights when the tuner is tuned to a TP station, and both the “EON” and “TP” indicators light when it is tuned to an EON TP station.

2. Activate the TA function.

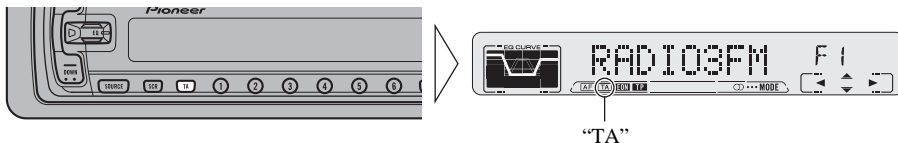

The “TA” indicator lights, indicating that the tuner is waiting for traffic announcements. Repeat the preceding operation when no traffic announcement is being received to deactivate the TA function.

Note:

- You can also switch the TA Function ON/OFF in the Function Menu.
- The system switches back to the original source following traffic announcement reception.
- The TA function can be activated from the built-in MD player, multi-MD player or multi-CD player mode if the tuner was last set to the FM band but not if it was last set to the MW/LW band.
- If the tuner was last set to FM, turning on the TA function lets you operate other tuning functions while listening to an MD or a CD.
- Only TP or EON-TP stations are tuned in during the Seek Tuning mode when the “TA” indicator is ON.
- Only TP or EON-TP stations are stored by BSM when the “TA” indicator is ON.

Canceling Traffic Announcements

- Press the TA button while a traffic announcement is being received to cancel the announcement and return to the original source.

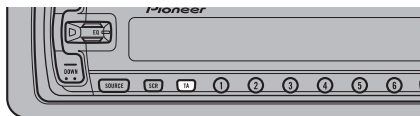

The announcement is canceled but the tuner remains in the TA mode until the TA button is pressed again.

Adjusting the TA Volume

When a traffic announcement begins, the volume adjusts automatically to a preset level to enable you to hear the announcement clearly.

- Set the volume by adjusting it during reception of a traffic announcement.

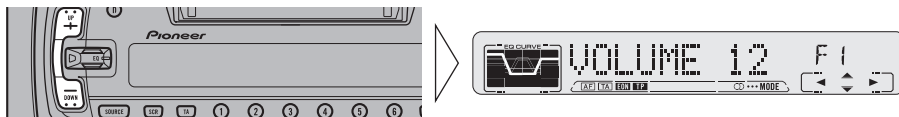

The newly set volume is stored in memory and recalled for subsequent traffic announcements.

TP Alarm Function

About 30 seconds after the "TP" or "EON" indicator is extinguished due to a weak signal, a 5 second beep sounds to remind you to select another TP or EON-TP station.

- If you are listening to the tuner, tune in another TP station or EON-TP station.

In the built-in MD player, multi-MD player or multi-CD player mode, the tuner automatically seeks out the TP station with the strongest signal in the current area 10 (or 30)* seconds after "TP" disappears from the display.

* Time taken before Seek begins.

TA function ON	10 seconds
TA, AF functions ON	30 seconds

PTY Function

With Wide and Narrow classification of program type, the PTY function provides two ways to select stations by the type of program being broadcast (PTY Search). It also provides automatic tuning to emergency broadcasts (PTY Alarm).

Note:

- There's no need to perform PTY Search settings again if they have previously been set. After switching to the PTY Search Setting mode in Step 1, just perform PTY Search in Step 4.

Searching the PTY

1. Select the PTY Search Setting mode.



2. Select the PTY Search method (Wide, Narrow).

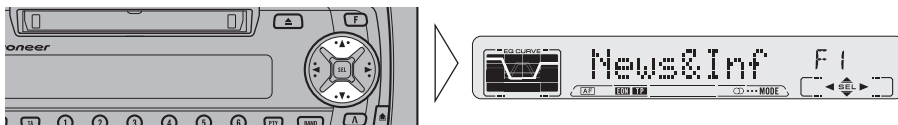

3. Select one from among the PTY.

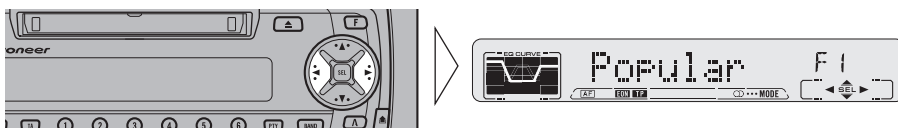

4. Start PTY Search.

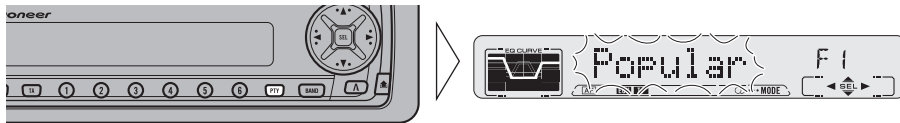

The tuner searches for a station broadcasting the desired PTY.

To cancel the PTY Search Setting mode, hold down the PTY button for 2 seconds or more.

Note:

- If a PTY code of zero is received from a station, "NONE" will be displayed. This indicates that the station has not defined its program contents.
- If the signal is too weak for this product to pick up the PTY code, "NO PTY" will be displayed.
- The program of some stations may differ from that indicated by the transmitted PTY.
- If no station broadcasting the selected programming type is found, "NOT FOUND" is displayed for about 2 seconds, and the tuner returns to the original station.

News Program Interruption Setting

You can switch automatic reception of PTY code news programs ON/OFF. When a received news program ends, reception of the previous program resumes.

- **Set interruption to ON or OFF.**

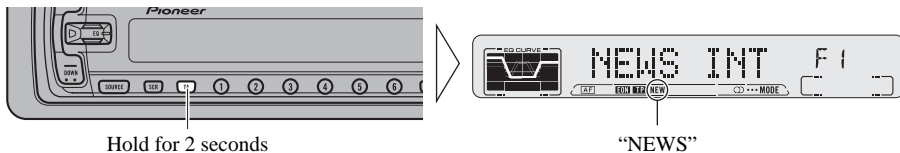

PTY Alarm

PTY Alarm is a special PTY code for announcements regarding emergencies such as natural disasters. When the tuner receives the radio alarm code, “ALARM” appears on the display and the volume adjusts to the TA volume. When the station stops broadcasting the emergency announcement, the system returns to the previous source.

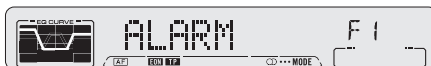

Note:

- The system switches back to the original source following emergency announcement reception.

Canceling Emergency Announcements

- Press the TA button during emergency announcement reception to cancel the announcement and return to the previous source.

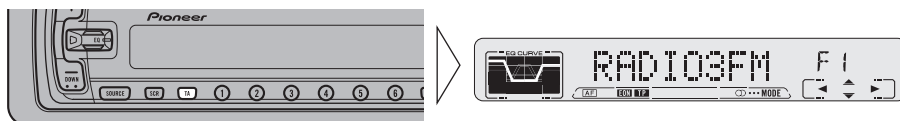

PTY List

Wide	Narrow	Details
News&Inf	News	News.
	Affairs	Current affairs.
	Info	General information and advice.
	Sport	Sports programs.
	Weather	Weather reports/Meteorological information.
	Finance	Stock market reports, commerce, trading etc.
Popular	Pop Mus	Popular music.
	Rock Mus	Contemporary modern music.
	Easy Mus	Easy listening music.
	Oth Mus	Other types of music, which can't be categorized.
	Jazz	Jazz music based programs.
	Country	Country music based programs.
	Nat Mus	National music based programs.
	Oldies	Oldies music, 'Golden age' based programs.
	Folk Mus	Folk music based programs.
Classics	L. Class	Light classical music.
	Classic	Serious classical music.
Others	Educate	Educational programs.
	Drama	All radio plays and serials.
	Culture	Programs concerned with any aspect of national or regional culture.
	Science	Programs about nature, science and technology.
	Varied	Light entertainment programs.
	Children	Children's programs.
	Social	Social affairs programs.
	Religion	Religion affairs programs or services.
	Phone In	Phone in based programs.
	Touring	Travel programs, not for announcements about traffic problem.
	Leisure	Programs about hobbies and recreational activities.
Document	Documentary programs.	

Repeat Play (REPEAT)

Repeat Play plays the same track repeatedly.

1. Press the **FUNCTION** button and select the Repeat mode (**REPEAT**) in the Function Menu.
2. Switch Repeat Play **ON/OFF** with the **▲/▼** buttons.



Note:

- If you perform Track Search or Fast forward/Reverse, Repeat Play is automatically canceled.

Random Play (RANDOM)

Random Play plays the tracks on an MD in random order for variety.

1. Press the **FUNCTION** button and select the Random mode (**RANDOM**) in the Function Menu.
2. Switch Random Play **ON/OFF** with the **▲/▼** buttons.



Scan Play (T-SCAN)

Scan Play plays the first 10 seconds or so of each track on an MD in succession.

1. Press the **FUNCTION** button and select the Scan mode (T-SCAN) in the Function Menu.
2. Switch the Scan mode **ON** with the **▲** button.



3. When you find the desired track, cancel scan play with the **▼** button.



If the Function Menu is automatically canceled at this time, select the Scan mode in the Function Menu once more.

Note:

- Scan Play is canceled automatically after all the tracks on a disc have been scanned.

Pause (PAUSE)

Let's you pause play of the track currently playing.

1. Press the **FUNCTION** button and select the Pause mode (PAUSE) in the Function Menu.
2. Switch the Pause **ON/OFF** with the **▲/▼** buttons.



Repeat Modes (REPEAT)

There are four repeat modes (play range): One-track Repeat, Disc Repeat, Multi-CD player Repeat (the selected Multi-CD player) and All Repeat (all Multi-CD players). (Default mode is Multi-CD player Repeat.)

1. Press the **FUNCTION** button and select the Repeat Selecting mode (REPEAT) in the Function Menu.
2. Select the desired Repeat Mode with the ◀/▶ buttons.

Multi-CD player Repeat (“MCD” is displayed) → All Repeat (“ALL” is displayed) → One-track Repeat (“TRK” is displayed and “RPT” indicator lights) → Disc Repeat (“DSC” is displayed and “DISC” indicator lights)



Note:

- All Repeat is available only when two or more multi-CD players are installed.
- If you go beyond the play range of the selected repeat mode by performing Track Search, Fast forward/Reverse or selecting another disc or Multi-CD player, the mode changes to an applicable Repeat mode.

Random Play (RANDOM)

Tracks are played at random within the selected repeat mode play range as explained in “Repeat Modes” above.

1. Press the **FUNCTION** button and select the Random mode (RANDOM) in the Function Menu.
2. Switch the Random Play ON/OFF with the ▲/▼ buttons.



After selecting the desired repeat mode play range from those referred to in “Repeat Modes” above, switch Multi-CD Player Random Play ON.

Scan Play (SCAN)

In the Disc Repeat Mode, the beginning of each track on a single disc is scanned for about 10 seconds. In the Multi-CD player Repeat and All Repeat modes, the beginning of the first track on each disc is scanned for about 10 seconds.

1. Press the FUNCTION button and select the Scan mode (SCAN) in the Function Menu.

2. Switch the Scan Play ON with the ▲ button.

After selecting the desired repeat mode play range from those referred to in “Repeat Modes” on page 41, switch Multi-CD Player Scan Play ON.



3. When you find the desired track (or disc), cancel scan play with the ▼ button.

If the Function Menu is automatically canceled at this time, select the Scan mode in the Function Menu once more.



Display	Play range
TRACK SCAN	Disc Repeat
DISC SCAN	Multi-CD player Repeat
SCAN	All Repeat

Note:

- Scan Play is canceled automatically after all the tracks or discs have been scanned.

Pause (PAUSE)

Let's you pause play of the track currently playing.

1. Press the **FUNCTION** button and select the **Pause mode (PAUSE)** in the **Function Menu**.
2. Switch the **Pause ON/OFF** with the **▲/▼** buttons.



CD Sound Quality Adjustment (COMP)

Using the COMP (Compression) and DBE (Dynamic Bass Emphasis) functions enables Multi-CD player sound quality adjustment. Both of the functions enable adjustment on two levels.

■ COMP

The COMP (Compression) function eliminates distortions caused by imbalances between loud and subdued sounds at higher volumes.

■ DBE

DBE (Dynamic Bass Emphasis) boosts bass levels to give a fuller sound.

1. Press the **FUNCTION** button and select the **COMP/DBE Switching mode (COMP)** in the **Function Menu**.
2. Select the desired mode with the **▲/▼** buttons.

COMP OFF → COMP 1 → COMP 2
→ COMP OFF → DBE 1 → DBE 2



Note:

- You can use these functions with Multi-CD players that have them. If the player does not feature the COMP/DBE functions, "NO COMP" is displayed if you try to use them.

ITS (Instant Track Selection)

The ITS function allows you to search for the track you wish to play when one or more multi-CD players are installed. You can use ITS to program automatic playback of up to 24 tracks per disc from up to 100 discs. (You can store ITS program and Disc Title data for up to 100 discs in memory.)

ITS Programming (ITS)

ITS programming can be conducted in any multi-CD player playback mode except ITS play.

1. **Play the track you wish to program.**
2. **Select the ITS Programming mode (ITS) in the Detailed Setting Menu.** (Refer to page 27.)
3. **Program the desired track with the ▲ button.**



Note:

- After 100 discs have been programmed, data for a new disc will overwrite the data for the disc that has not been played back for the longest time.

ITS Play (ITS-P)

ITS play of tracks is performed within the play range explained in the “Repeat Modes” section.

1. **Press the FUNCTION button and select the ITS Play mode (ITS-P) in the Function Menu.**
2. **Switch ITS play ON/OFF with the ▲/▼ buttons.**



After selecting the desired repeat mode play range from those referred to in “Repeat Modes” on page 41, switch ITS play ON.

Note:

- If no track in the current range is programmed for ITS play “ITS EMPTY” is displayed.

Erase a Track Program

1. Select the track you wish to erase, during ITS play.
2. Select the ITS Programming mode (ITS) in the Detailed Setting Menu. (Refer to page 27.)
3. Erase with the ▼ button.

ITS is canceled and playback of the next ITS-programmed track begins. If there are no more programmed tracks in the current range, "ITS EMPTY" is displayed and normal play resumes.



Erase a Disc Program

1. Select the disc you wish to erase, while the disc is playing.
2. Select the ITS Programming mode (ITS) in the Detailed Setting Menu. (Refer to page 27.)
3. Erase with the ▼ button.



Disc Title

Disc Title Input (TITLE IN)

You can input Titles up to 10 letters long for up to 100 discs. Using this function lets you easily search for and select a desired disc for play. (You can store ITS program and Disc Title data for up to 100 discs in memory.)

1. Play the disc you wish to input the disc title.
2. Select the Disc Title Input mode (TITLE IN) in the Detailed Setting Menu. (Refer to page 27.)
3. Switch the Alphabet modes.

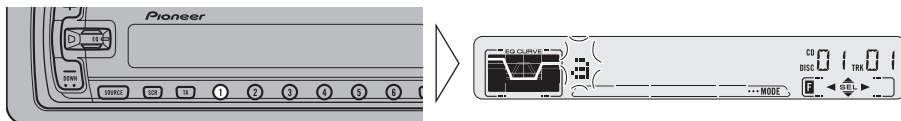

Each press of button 1 changes the mode in the following order:

Alphabet (Upper case), Numbers and Symbols → Alphabet (Lower case)
→ European letters, such as those with accents (e.g. á, à, ä, ç)

Note:

- You can switch to the Numbers and Symbol mode by pressing button 2.

4. Select letters, numbers and symbols with the ▲/▼ buttons.

To insert a space, select the flashing cursor “_”.



5. Move the box left and right with the ◀/▶ buttons.

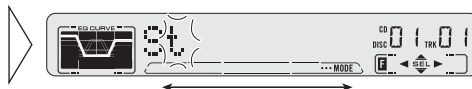

6. When you have completed title input, make the 10th letter flash, then memorize by pressing the ► button.



Note:

- Titles remain in memory, even after the disc has been removed from the magazine, and are recalled when the disc is reinserted.
- After the titles for 100 discs have been entered, data for a new disc will overwrite the data for the disc that has not been played back for the longest time. If a Multi-CD player is installed, the data is stored in the Multi-CD player's memory.
- You can display the disc title of the disc currently playing. For details, refer to "Switching the Display" on page 22.

Disc Title List (TITLE LIST)

Follow the procedures below to play a disc for which you have input the title in a multi-CD player:

1. Press the **FUNCTION** button and select the **Disc Title List mode (TITLE LIST)** in the Function Menu.

2. Each time you press the ◀/▶ buttons, titles in the current disc magazine are displayed in the order of their disc numbers.



Nothing is displayed for disc whose titles have not been input.

3. Select the desired disc for playback by pressing ▲ button when its title is displayed.



Selecting the Equalizer Curve

You can switch between Equalizer curves.

- Move the EQ button up or down to select the desired Equalizer curve.

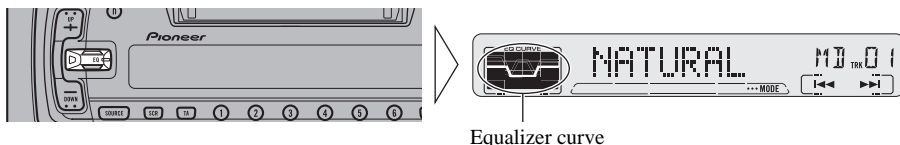

POWERFUL ↔ NATURAL ↔ VOCAL ↔ CUSTOM ↔ EQ FLAT
↔ SUPER BASS

Note:

- “CUSTOM” stores an equalizer curve you have made adjustments to. (Refer to “Equalizer Curve Adjustment” on page 49.)
- If you make adjustments when a curve other than “CUSTOM” is selected, the adjusted curve is stored in memory as a “CUSTOM” curve. Also, the displayed curve switches to that selected before adjustments were made.
- You can create different “CUSTOM” curves for different sources. (The built-in MD player and multi-MD player are set to the same Equalizer Curve Adjustment setting automatically.)

Entering the Audio Menu

With this Menu, you can adjust the sound quality.

Note:

- After entering the Audio Menu, if you do not perform an operation within about 30 seconds, the Audio Menu is automatically canceled.

1. Select the desired mode in the Audio Menu.

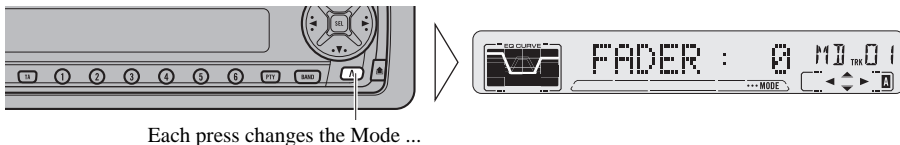

2. Operate a mode.

3. Cancel the Audio Menu.



Audio Menu Functions

The Audio Menu features the following functions.

Balance Adjustment (FADER)

This function allows you to select a Fader/Balance setting that provides ideal listening conditions in all occupied seats.

1. Press the **AUDIO** button and select **Fader/Balance mode (FADER)** in the **Audio Menu**.

2. Adjust front/rear speaker balance with the **▲/▼** buttons.

“FADER F15” – “FADER R15” is displayed as it moves from front to rear.



3. Adjust left/right speaker balance with the **◀/▶** buttons.

“BAL L 9” – “BAL R 9” is displayed as it moves from left to right.



Note:

- “FADER 0” is the proper setting when 2 speakers are in use.

Equalizer Curve Adjustment (EQ-LOW/MID/HIGH)

You can adjust equalizer curve settings as desired. Adjusted equalizer curve settings are memorized in “CUSTOM”.

1. Press the **AUDIO** button and select the **Equalizer mode (EQ-LOW/MID/HIGH)** in the **Audio Menu**.

2. Select the band you want to adjust with the **◀/▶** buttons.

EQ-LOW ↔ EQ-MID ↔ EQ-HIGH



3. Boost or attenuate the selected band with the **▲/▼** buttons.

The display shows “+6” – “-6”.



Equalizer Curve Fine Adjustment

You can adjust the center frequency of each equalizer curve band (LOW/MID/HIGH) and the Q factor (curve characteristics).

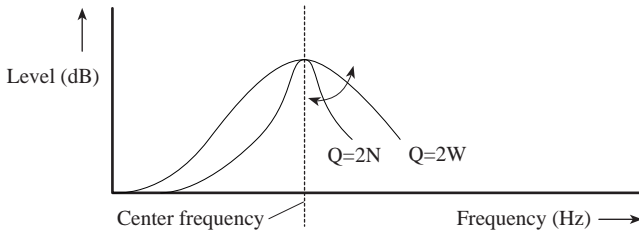

1. When in the Audio Menu, press the **AUDIO** button for 2 or more seconds to select Equalizer Curve Fine Adjustment.

2. Press the **AUDIO** button to select the desired band for adjustment.



3. Select the desired frequency with the **◀/▶** buttons.

LOW: 40 ↔ 80 ↔ 100 ↔ 160 (Hz)

MID: 200 ↔ 500 ↔ 1K ↔ 2K (Hz)

HIGH: 3K ↔ 8K ↔ 10K ↔ 12K (Hz)



4. Select the desired Q factor with the **▲/▼** buttons.

2N ↔ 1N ↔ 1W ↔ 2W



Loudness Adjustment (LOUD)

The Loudness function compensates for deficiencies in the low and high sound ranges at low volume. You can select a desired Loudness level.

1. Press the **AUDIO** button and select the Loudness mode (LOUD) in the Audio Menu.

2. Switch the Loudness function ON/OFF with the **▲/▼** buttons.



3. Select the desired level with the **◀/▶** buttons.

LOW ↔ MID ↔ HI



Front Image Enhancer Function (FIE)

The F.I.E. (Front Image Enhancer) function is a simple method of enhancing front imaging by cutting mid- and high-range frequency output from the rear speakers, limiting their output to low-range frequencies. You can select the frequency you want to cut.

Precaution:

- When the F.I.E. function is deactivated, the rear speakers output sound in all frequencies, not only bass sounds. Reduce the volume before disengaging F.I.E. to prevent a sudden increase in volume.

1. Press the **AUDIO** button and select the **F.I.E. mode (FIE)** in the Audio Menu.

2. Switch the **F.I.E. function ON/OFF** with the **▲/▼** buttons.



3. Select the desired frequency with the **◀/▶** buttons.

100 ↔ 160 ↔ 250 (Hz)



Note:

- After switching the F.I.E. function ON, select the Fader/Balance mode in the Audio Menu, and adjust front and rear speaker volume levels until they are balanced.
- Switch the F.I.E. function OFF when using a 2-speaker system.

Source Level Adjustment (SLA)

The SLA (Source Level Adjustment) function prevents radical leaps in volume when switching between sources. Settings are based on the FM volume, which remains unchanged. (Since the FM volume is the control, SLA is not possible in the FM modes.) The MW/LW, MD, CD and AUX levels can all be adjusted.

The built-in MD player and multi-MD player are set to the same volume adjustment setting automatically.

1. Compare the **FM volume with the volume of the other source**.
(e.g. **Built-in MD player**)

2. Press the **AUDIO** button, and select the **SLA mode (SLA)** in the Audio Menu.

3. Increase or decrease the level with the **▲/▼** buttons.

The display shows “+4” – “-4”.



Detaching and Replacing the Front Panel

Theft Protection

The front panel of the head unit is detachable to discourage theft.

Detaching the Front Panel

1. Eject the front panel.



2. To remove the front panel, pull its right-hand side toward you.

Take care not to grip it tightly or drop it.

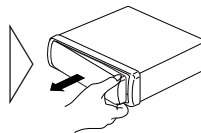

3. Use the protective case provided to store/carry the detached front panel.

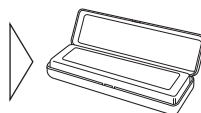

Replacing the Front Panel

- Replace the front panel by clipping it into place.

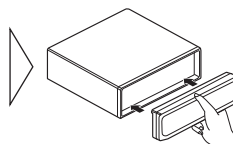

Precaution:

- Never use force or grip the display tightly when removing or replacing the front panel.
- Avoid subjecting the front panel to excessive shocks.
- Keep the front panel out of direct sunlight and high temperatures.

Warning Tone

If the front panel is not detached within 5 seconds after the ignition is turned off, a warning tone will sound.

Note:

- You can cancel the warning tone function. (Refer to page 55.)

Entering the Initial Setting Menu

With this Menu, you can perform initial settings for the product.

1. Switch the sources OFF.
2. Enter the Initial Setting Menu with the sources OFF.

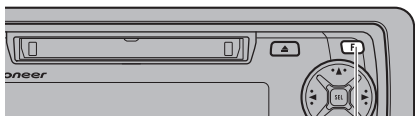

Hold for 2 seconds



3. Select the desired mode.

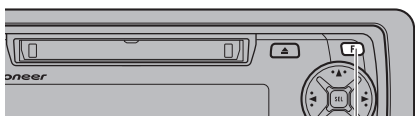

Each press changes the Mode ...



4. Operate a mode.
5. Cancel the Initial Setting Menu.

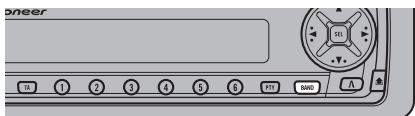

Note:

- ALARM is a new feature of the “Removable Front Panel Alert”. Refer to “RFP Alert Function” for details and instructions on how to use this function.
- Holding down the FUNCTION button for 2 seconds also cancels the Initial Setting Menu.

Initial Setting Menu Functions

The Initial Setting Menu features the following functions.

Setting the Time

This is the mode for setting the time on the unit's clock display. (Refer to page 61 for details concerning the clock display.)

1. Select the time setting mode in the Initial Setting Menu.
2. Select "Hour" or "Minute" with the ◀/▶ buttons.



3. Set as desired time with the ▲/▼ buttons.

As soon as you switch to "Minute", the seconds start counting from 00.



Changing the FM Tuning Step (FM STEP)

Normally set at 50 kHz during Seek tuning in the FM mode, the tuning step changes to 100 kHz when the AF or TA mode is activated.

It may be preferable to set tuning step to 50 kHz in the AF mode.

1. Press the FUNCTION button and select the FM Tuning Step mode (FM STEP) in the Initial Setting Menu.
2. Select the desired tuning step with the ◀/▶ buttons.



Note:

- The tuning step remains set at 50 kHz during Manual tuning.
- The tuning step returns to 100 kHz if the battery is temporarily disconnected.

Switching the Auto PI Seek (A-PI)

During Preset Station PI Seek operation, you can switch the Auto PI Seek function ON/OFF. (Refer to “PI Seek Function” on page 32.)

1. Press the **FUNCTION** button and select the Auto PI Seek mode (A-PI) in the Initial Setting Menu.
2. Switch the Auto PI Seek ON/OFF with the **▲/▼** buttons.



Setting the Warning Tone (WARN)

You can switch the Warning Tone function ON/OFF. (Refer to “Warning Tone” on page 52.)

1. Press the **FUNCTION** button and select the Warning mode (WARN) in the Initial Setting Menu.
2. Switch the Warning tone ON/OFF with the **▲/▼** buttons.



Switching the AUX Mode (AUX)

It is possible to use auxiliary (AUX) equipment with this product. Activate the AUX mode when using external equipment with this product.

1. Press the **FUNCTION** button and select the AUX Setting mode (AUX) in the Initial Setting Menu.
2. Switch the AUX ON/OFF with the **▲/▼** buttons.



Setting the Dimmer (DIMMER)

To enable this product's display from being too bright at night, when the vehicle's head lights are turned ON the display is dimmed. You can switch this function ON/OFF.

1. Press the **FUNCTION** button and select the **Dimmer mode (DIMMER)** in the **Initial Setting Menu**.
2. Switch the **Dimmer ON/OFF** with the **▲/▼** buttons.



Selecting the Illumination Color (ILL. CLR)

This product is equipped with two illumination colors, green and red. You can select the desired illumination color.

1. Press the **FUNCTION** button and select the **Illumination Color mode (ILL. CLR)** in the **Initial Setting Menu**.
2. Select the desired illumination color with the **◀/▶** buttons.



In addition to the Removable Front Panel, Pioneer has incorporated a new feature “**Removable Front Panel Alert**”. This feature is designed to protect your new Pioneer car stereo as well as your vehicle contents.

Activating the RFP Alert Feature

Pioneer has developed a menu display that allows you to set-up your RFP Alert to meet your personal needs. By scrolling through this menu it is possible to select your own “Entry Delay Time”, “Speaker Output Volume” and “Door System Type”. Initially from the factory the RFP Alert feature is not activated.

1. **Select the RFP Alert Feature ON/OFF mode (ALARM) in the Initial Setting Menu. (Refer to page 53.)**



2. **Press the ▲ button to switch the RFP Alert Feature ON.**

Press the ▼ button to deactivate the RFP Alert Feature.



3. **Press the FUNCTION button for 2 seconds to set the RFP Alert Setting menu.**



Setting Entry Delay Time

Initially the “Entry Delay Time” is set to 15 seconds. The “Entry Delay Time” can be adjusted to be 0, 5, 15, 30, 45 or 60 seconds.

1. **Decrease or increase the “Entry Delay Time” with the ◀/▶ buttons.**



2. **Press the FUNCTION button to move to the next selection.**



Activating Internal Speaker ON/ OFF

This feature allows you to select whether or not the speaker output is sounded when the “RFP Alert” is triggered. Initially from the factory the speaker output is activated. Toggling between ▲, ▼ buttons allows you to deactivate or activate the “Internal Speaker”. If you switch the speaker output OFF, you can not change the “TEST MODE”.

Speaker Volume Output Adjustment

If the “Internal Speaker Output” has been selected then it is possible to adjust the volume of the speaker output for when the Alert is triggered. To adjust the volume you must engage the “TEST MODE”.

Note:

- If the “Internal Speaker Output” is turned OFF, then this menu will not appear.

1. Select the “TEST MODE” with the ► button.



2. Press the ▲ button to switch the “TEST MODE” ON.

In this mode the speakers will sound.



3. Decrease or increase the volume with the volume buttons.

Display shows 10 – 30.



4. After setting volume with the ▼ button, cancel the “TEST MODE”, then move to the next selection.



5. Cancel the “TEST MODE” with the ◀ button.



6. Press the FUNCTION button to move to the next selection.



Selecting Door Switching Systems

It is necessary to select the correct “Door System Type” (Negative or Positive switching) for that of your vehicle. Initially, the system is set for vehicles with the grounding type (Negative switching).

Select the correct “Door system type” of your vehicle from below.

■ Vehicles to select “DOOR-L :CLS”

EUROPEAN, JAPANESE, GM,
CHRYSLER

■ Vehicles to select “DOOR-H :CLS”

JAGUAR, MERCEDES*, FORD, etc.

* Some Models Only.

- Select “DOOR-L :CLS” or “DOOR-H :CLS” with the ◀/▶ buttons.



Door System Confirmation

The door system confirmation feature was incorporated to ensure that the correct door system type has been selected. (e.g. Set to “DOOR-H :CLS” for JAGUAR vehicles.)

1. **First, close all the vehicle’s doors. If the correct door system type has been selected then the Display will show “DOOR-H :CLS”.**

If not, select the alternative door system type by pressing the ◀ or ▶ button. Lastly, confirm each door triggers the Alert by opening and closing each vehicle’s door.



2. **As the vehicle’s door is opened the display should change accordingly (“DOOR-H :CLS” – “DOOR-H :OPN”).**



3. **Press the BAND button and cancel the RFP Alert Setting Menu.**

Setting of the “RFP Alert” is now complete.



Note:

- In case that the battery is disconnected or the RESET button is pressed, it may be necessary to reprogram the RFP Alert Menu; otherwise this setting needs to be done only once.

Operation of "RFP Alert"

Providing the installation and setting of the "RFP Alert Setting Menu" has been performed correctly, operation of the "RFP Alert" is very simple.

Arming Alert

To arm your Alert simply turn off the ignition and detach the front panel, as described on page 52. After detaching the front panel the "RFP Alert" will automatically arm itself after 30 seconds, providing all of the doors are closed. If after 30 seconds, a door still remains open the RFP Alert will not arm until the last door has been closed. After closing all of the doors, ensure that they are securely locked. The LED indicator on the head unit will flash as a visual deterrent. Your vehicle is now protected by your "RFP Alert".

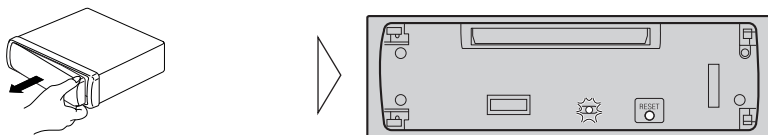

Disarming Alert

Upon entering your vehicle, and within the "Entry Delay Time" set within the "RFP Alert Menu", attach your Pioneer Front Panel as described on page 52.

If you have forgotten your removable front panel, simply insert the ignition key in the ignition and turn the key from "OFF" to "ON" within the "Entry Delay Time".

Entry Detection

If the "RFP Alert" was not disarmed in accordance with "Disarming Alert", the "RFP Alert" will be triggered. The "RFP Alert" will sound for 60 seconds and will repeat 5 times if any door is left open or reopened. After the fifth time the "RFP Alert" will reset to prevent continuous sounding and prevent your battery from discharging.

Precaution:

- Upon returning to your vehicle and before opening any doors, check to see if the LED indicator is still flashing. If the LED is no longer flashing, it indicates that the Alert has sounded. Disarming, as described above, is still necessary.

Time Display

Displaying the Time

- To turn the time display ON with the source ON.

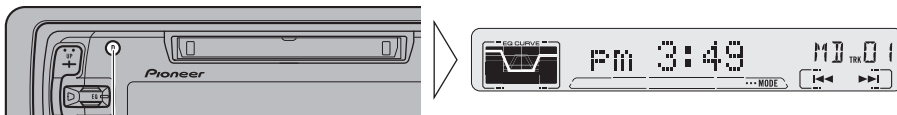

Hold for 2 seconds

The time display disappears temporarily when you perform another operation, but the time indication returns to the display after 25 seconds.

Using the PGM Button (PGM-FUNC)

The PGM (Programmable) button can memorize one of the functions in the Function Menu.

It is possible to memorize a different function for each source.

Setting the PGM Button

1. Select the PGM button's setting mode (PGM-FUNC) in the Detailed Setting Menu. (Refer to page 27.)

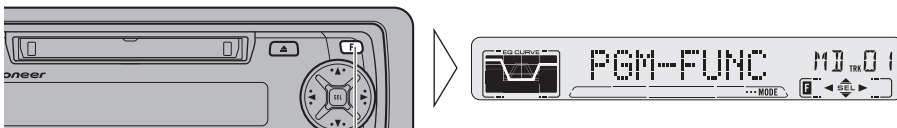

Hold for 2 seconds

2. Select the function you want to memorize in the PGM button.



3. Memorize the function in PGM button.

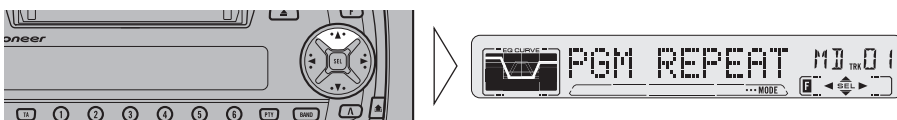

Pressing the BAND button cancels the Detailed Setting Menu.

Using the PGM Button

The PGM button operates in a different way depending on the function programmed (memorized).

- **Use the PGM button.**

PGM button operations are only possible with the remote control.



■ Tuner

Function Name (Display)	Press	Hold for 2 seconds
Best Stations Memory (BSM)	OFF	ON
Regional Function (REG)	ON/OFF	—
Local Seek Tuning (LOCAL)	ON/OFF	Entering the Local Seek Sensitivity mode

■ Built-in MD Player

Function Name (Display)	Press	Hold for 2 seconds
Pause (PAUSE)	ON/OFF	—
Repeat Play (REPEAT)	ON/OFF	—
Random Play (RANDOM)	ON/OFF	—

■ Multi-CD Player

Function Name (Display)	Press	Hold for 2 seconds
Pause (PAUSE)	ON/OFF	—
Repeat Modes (REPEAT)	Selecting the mode	—
Random Play (RANDOM)	ON/OFF	—
Disc Title Input (LIST)	Enter the LIST mode	—
ITS (ITS)	ITS Programming	ON/OFF

Using the AUX Source

It is possible to use auxiliary (AUX) equipment with this product.

To listen to auxiliary equipment, switch the AUX Mode in the Initial Setting Menu ON, and then select the desired source.

Selecting the AUX Source

- Select **AUX**. (Refer to page 18.)

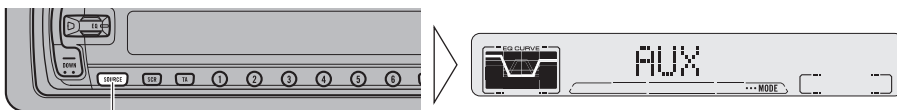

Each press changes the Source ...

AUX Title Input

The display title for AUX Source can be changed.

1. Select the **Aux Title Input mode (TITLE IN)** in the Detailed Setting Menu.

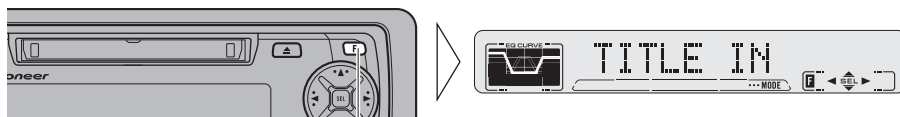

Hold for 2 seconds

2. **Input the Aux Title.**

Refer to “Disc Title Input” on page 46, and perform procedures 3 to 6 in the same way.

Cellular Telephone Muting

Sound from this system is muted automatically when a call is made or received using a cellular telephone connected to this product.

- The sound is turned off, “MUTE” is displayed and no audio adjustment except volume control is possible. Operation returns to normal when the phone connection is ended.



Precaution

- Do not open the MD shutter by hand. Forcing it open may result in damage.



- Be sure to stick labels supplied with MDs in the specified location. Failing to do this, or sticking one label on top of another may make it impossible for the MD to be removed.

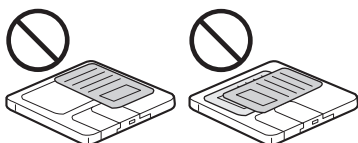

- Do not use MDs with labels that are not affixed correctly. Labels like this may catch on something, preventing removal of the MD. Before using an MD, remove the label if it is not correctly affixed, and replace it with a new label.

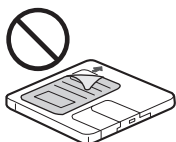

- Keep MDs out of direct sunlight and high temperatures.
- If the surface of an MD cartridge is dirty, wipe it gently with a clean, soft cloth.
- Do not apply benzene, thinner or other volatile liquids to MDs.
- When it's cold, if you start playing an MD immediately after switching the heater in a room on, condensation on the optical lens inside the player or on the MD may prevent normal play. If this happens, turn off the player for about an hour to allow the condensation to evaporate, and wipe damp MD cartridge surfaces with a soft cloth.

Built-in MD Player's Error Message

When problems occur with MD playback, an error message appears on the display. Refer to the table below to identify the problem, then take the suggested corrective action. If the error persists, contact your dealer or your nearest PIONEER Service Center.

Message	Possible cause	Recommended action
NO D-DATA	Disc name has not been input.	Switch to a display other than Disc Name indications.
NO TR-DATA	Track name has not been input.	Switch to a display other than Track Name indications.
HEAT	MD player overheating.	Discontinue play until the machine temperature drops.
ERROR- 11, 12, 17, 30	Dirty disc.	Clean the disc.
ERROR- 11, 12, 17, 30	Scratched disc.	Replace the disc.
ERROR- 01, 11, 12, 17, 30, A0	Electrical or mechanical problem.	Turn the ignition ON and OFF, or switch to a different source, then back to the MD player.
ERROR- 20, 21	Track information cannot be read.	Reload the MD.
ERROR- 20, 21, 22, 24	There is something wrong with the MD.	Replace the disc.
ERROR- 23	The MD contains recorded information other than music.	Replace the disc.
ERROR- A1	Electrical or mechanical problem.	Press the Reset button.
ERROR-	MD play not possible.	Replace the MD with another disc, or press the Reset button.

General

Power source 14.4 V DC (10.8 – 15.1 V allowable)
 Grounding system Negative type
 Max. current consumption 10.0 A
 Dimensions
 (mounting size) 178 (W) × 50 (H) × 150 (D) mm
 (front face) 188 (W) × 58 (H) × 18 (D) mm
 Weight 1.3 kg

Amplifier

Maximum power output 40 W × 4
 Continuous power output 25 W × 4
 (DIN45324, +B = 14.4 V)
 Load impedance 4 Ω (4 – 8 Ω allowable)
 Preout output level/output impedance 500 mV/1 kΩ
 Equalizer (3-Band Parametric Equalizer)
 (Low) Frequency: 40/80/100/160 Hz
 Q Factor: 0.35/0.59/0.95/1.15
 (+6 dB when boosted)
 Level: ±12 dB
 (Mid) Frequency: 200/500/1k/2k Hz
 Q Factor: 0.35/0.59/0.95/1.15
 (+6 dB when boosted)
 Level: ±12 dB
 (High) Frequency: 3.15k/8k/10k/12.5k Hz
 Q Factor: 0.35/0.59/0.95/1.15
 (+6 dB when boosted)
 Level: ±12 dB
 Loudness contour
 (Low) +3.5 dB (100 Hz), +3 dB (10 kHz)
 (volume: –30 dB)
 (Mid) +10 dB (100 Hz), +6.5 dB (10 kHz)
 (volume: –30 dB)
 (High) +11 dB (100 Hz), +11 dB (10 kHz)
 (volume: –30 dB)

MD player

System Mini disc digital audio system
 Usable discs Mini disc
 Signal format Sampling frequency: 44.1 kHz
 Number of quantization bits: 16; linear
 Frequency characteristics 20 – 20,000 Hz (±1 dB)
 Signal-to-noise ratio 94 dB (1 kHz) (IEC-A network)
 Dynamic range 93 dB (1 kHz)
 Number of channels 2 (stereo)

FM tuner

Frequency range 87.5 – 108 MHz
 Usable sensitivity
 11 dBf (1.0 μV/75 Ω, mono, S/N: 30 dB)
 50 dB quieting sensitivity 16 dBf (1.7 μV/75 Ω, mono)
 Signal-to-noise ratio 70 dB (IEC-A network)
 Distortion 0.3% (at 65 dBf, 1 kHz, stereo)
 Frequency response 30 – 15,000 Hz (±3 dB)
 Stereo separation 40 dB (at 65 dBf, 1 kHz)

MW tuner

Frequency range 531 – 1,602 kHz
 Usable sensitivity 18 μV (S/N: 20 dB)
 Selectivity 50 dB (±9 kHz)

LW tuner

Frequency range 153 – 281 kHz
 Usable sensitivity 30 μV (S/N: 20 dB)
 Selectivity 50 dB (±9 kHz)

Note:

- US and foreign patents licensed from Dolby Laboratories Licensing Corporation.
- Specifications and the design are subject to possible modification without notice due to improvements.

PIONEER ELECTRONIC CORPORATION

4-1, Meguro 1 chome, Meguro-ku, TOKYO, 153-8654, JAPAN

PIONEER ELECTRONICS (USA) INC.

P.O. Box 1760, Long Beach, California 90801, U.S.A.

TEL: (800) 421-1404

PIONEER ELECTRONIC (EUROPE) N.V.

Haven 1087 Keetberglaan 1, 9120 Melsele, Belgium

TEL: (0) 3/570.05.11

PIONEER ELECTRONICS AUSTRALIA PTY. LTD.

178-184 Boundary Road, Braeside, Victoria 3195, Australia

TEL: (03) 580-9911

PIONEER ELECTRONICS OF CANADA, INC.

300 Allstate Parkway Markham, Ontario L3R 0P2, Canada

TEL: (905) 479-4411

PIONEER ELECTRONICS DE MEXICO, S.A. de C.V.

San Lorenzo Num 1009 3er piso Desp. 302

Col. Del Valle, Mexico D.F. C.P. 03100

TEL: 5-688-52-90

Published by Pioneer Electronic Corporation.
Copyright © 1998 by Pioneer Electronic Corporation. All rights reserved.

Publicado por Pioneer Electronic Corporation.
Copyright © 1998 Pioneer Electronic Corporation.
Todos los derechos reservados.

Printed in Japan
Impreso en Japón

Free Manuals Download Website

<http://myh66.com>

<http://usermanuals.us>

<http://www.somanuals.com>

<http://www.4manuals.cc>

<http://www.manual-lib.com>

<http://www.404manual.com>

<http://www.luxmanual.com>

<http://aubethermostatmanual.com>

Golf course search by state

<http://golfingnear.com>

Email search by domain

<http://emailbydomain.com>

Auto manuals search

<http://auto.somanuals.com>

TV manuals search

<http://tv.somanuals.com>