

# Operation Manual Mode d'emploi

Multi-CD control High power CD/MP3/WMA/AAC  
player with FM/AM tuner

Syntoniseur FM/AM et lecteur de CD/MP3/WMA/  
AAC, "Puissance élevée", avec contrôleur pour lec-  
teur de CD à chargeur

# DEH-P6800MP

**SUPER TUNER III D**

## Thank you for buying this Pioneer product.

Please read through these operating instructions so you will know how to operate your model properly. *After you have finished reading the instructions, keep this manual in a safe place for future reference.*

### 01 Before You Start

- Information to User 5
- For Canadian model 5
- About this unit 5
- About this manual 5
- After-sales service for Pioneer products 6
- Product registration 6
- Features 6
  - About WMA 7
  - About AAC 7
  - About the SAT RADIO READY mark 7
- Resetting the microprocessor 8
- Protecting your unit from theft 8
  - Removing the front panel 8
  - Attaching the front panel 9
- About the demo mode 9
  - Reverse mode 9
  - Feature demo mode 9
- Use and care of the remote control 9
  - Installing the battery 9<sup>1</sup>
  - Using the remote control 10
  - FUNCTION button and AUDIO button 10

### 02 What's What

- Head unit 11
- Remote control 11

### 03 Basic Operations

- Turning the unit on 13
- Selecting a source 13
- Loading a disc 13
- Adjusting the volume 14
- Turning the unit off 14

### 04 Tuner

- Listening to the radio 15
- Introduction of advanced tuner operation 16
- Storing and recalling broadcast frequencies 16

- Storing the strongest broadcast frequencies 16
- Selecting stations from the preset channel list 17
- Tuning in strong signals 17

### 05 Built-in CD Player

- Playing a CD 18
- Selecting a track directly 18
- Introduction of advanced built-in CD player operation 19
- Repeating play 19
- Playing tracks in random order 19
- Scanning tracks of a CD 20
- Pausing CD playback 20
- Using compression and BMX 20
- Selecting the search method 20
- Searching every 10 tracks in the current disc 21
- Using disc title functions 21
  - Entering disc titles 21
  - Displaying disc titles 22
- Using CD TEXT functions 22
  - Displaying text information on CD TEXT discs 22
  - Scrolling text information in the display 22
  - Selecting tracks from the track title list 23

### 06 MP3/WMA/AAC/WAV Player

- Playing MP3/WMA/AAC/WAV files 24
- Selecting a track directly in the current folder 25
- Introduction of advanced built-in CD player (MP3/WMA/AAC/WAV) operation 25
- Repeating play 26
- Playing tracks in random order 26
- Scanning folders and tracks 26
- Pausing MP3/WMA/AAC/WAV playback 27
- Using compression and BMX 27

- Selecting the search method **27**
- Searching every 10 tracks in the current folder **27**
- Displaying text information on MP3/WMA/AAC/WAV disc **28**
  - When playing back an MP3/WMA/AAC disc **28**
  - When playing back a WAV disc **28**
- Scrolling text information in the display **28**
- Selecting tracks from the file name list **29**

## 07 Multi-CD Player

- Playing a CD **30**
- Selecting a track directly **30**
- 50-disc multi-CD player **31**
- Introduction of advanced multi-CD player operation **31**
- Repeating play **32**
- Playing tracks in random order **32**
- Scanning CDs and tracks **32**
- Pausing CD playback **33**
- Using ITS playlists **33**
  - Creating a playlist with ITS programming **33**
  - Playback from your ITS playlist **33**
  - Erasing a track from your ITS playlist **34**
  - Erasing a CD from your ITS playlist **34**
- Using disc title functions **34**
  - Entering disc titles **34**
  - Displaying disc titles **35**
  - Selecting discs from the disc title list **35**
- Using CD TEXT functions **36**
  - Displaying text information on CD TEXT discs **36**
  - Scrolling text information in the display **36**
  - Selecting tracks from the track title list **36**

- Using compression and bass emphasis **37**

## 08 Playing songs on iPod

- Listening to songs on your iPod **38**
- Browsing for a song **38**
  - Searching for a song **38**
  - Selecting a playlist **39**
- Displaying text information on iPod **39**
- Introduction of advanced iPod adapter operation **40**
- Repeating play **40**
- Playing songs in a random order (shuffle) **40**
- Pausing a song **41**

## 09 XM tuner

- Listening to XM Satellite Radio **42**
- Selecting an XM channel directly **42**
- Introduction of advanced XM tuner operation **43**
- Switching the XM display **43**
- Storing and recalling broadcast stations **43**
- Switching the XM channel select setting **43**
  - Selecting a channel in the channel category **44**
- Displaying the Radio ID **44**
  - Channel number select setting **44**
  - Channel category select setting **44**
- Selecting stations from the preset channel list **44**

## 10 SIRIUS Satellite Radio tuner

- Listening to SIRIUS Satellite Radio **45**
- Selecting a SIRIUS channel directly **45**
- Introduction of advanced SIRIUS tuner operation **46**
- Switching the SIRIUS display **46**
- Switching the scroll setting **46**
- Storing and recalling broadcast stations **46**
- Selecting the SIRIUS channel select setting **46**

- Selecting a channel in the channel category 47

Displaying the Radio ID 47

## 11 TV tuner

- Watching the television 48
- Introduction of advanced TV tuner operation 49
- Storing and recalling broadcast stations 49
- Storing the strongest broadcast stations sequentially 49
- Selecting stations from the preset channel list 50

## 12 DVD Player

- Playing a disc 51
- Selecting a disc 51
- Selecting a folder 51
- Introduction of advanced DVD player operation 52
- Repeating play 52
- Pausing disc playback 53
- Playing tracks in random order 53
- Scanning tracks of a CD/MP3/WMA 53
- Using ITS playlist and disc title functions 53
- Using disc title functions 53
  - Entering disc titles 54

## 13 Audio Adjustments

- Introduction of audio adjustments 55
- Using balance adjustment 55
- Using the equalizer 56
  - Recalling equalizer curves 56
  - Adjusting equalizer curves 56
  - Adjusting 7-band graphic equalizer 56
- Adjusting loudness 57
- Using subwoofer output 57
  - Adjusting subwoofer settings 57
- Boosting the bass 58
- Using the high pass filter 58

Adjusting source levels 58

## 14 Initial Settings

- Adjusting initial settings 60
- Selecting the display language 60
- Setting the clock 60
- Switching the warning tone 61
- Switching the face auto open 61
- Switching the auxiliary setting 61
- Switching the dimmer setting 61
- Adjusting the brightness 62
- Setting the rear output and subwoofer controller 62
- Switching the sound muting/attenuation 62
- Switching the feature demo 63
- Switching the reverse mode 63
- Switching the Ever Scroll 63

## 15 Other Functions

- Turning the clock display on or off 64
- Using the AUX source 64
  - About AUX1 and AUX2 64
  - Selecting AUX as the source 64
  - Setting the AUX title 64
- Using different entertainment displays 65
- Using the PGM button 66

## Additional Information

- Understanding built-in CD player error messages 67
- CD player and care 67
- CD-R/CD-RW discs 68
- MP3, WMA, AAC and WAV files 68
  - MP3 additional information 69
  - WMA additional information 69
  - AAC additional information 69
  - WAV additional information 70
- About folders and MP3/WMA/AAC/WAV files 70
- Terms 72
- Specifications 74

## Before You Start

### Information to User

Alteration or modifications carried out without appropriate authorization may invalidate the user's right to operate the equipment.



### For Canadian model

This Class B digital apparatus complies with Canadian ICES-003.



### About this unit

The tuner frequencies on this unit are allocated for use in North America. Use in other areas may result in poor reception.



#### WARNING:

Handling the cord on this product or cords associated with accessories sold with the product may expose you to chemicals listed on proposition 65 known to the State of California and other governmental entities to cause cancer and birth defects or other reproductive harm. **Wash hands after handling.**

**CAUTION:**  
**USE OF CONTROL OR ADJUSTMENT OR PERFORMANCE OF PROCEDURES OTHER THAN THOSE SPECIFIED HEREIN MAY RESULT IN HAZARDOUS RADIATION EXPOSURE.**

**CAUTION:**  
**THE USE OF OPTICAL INSTRUMENTS WITH THIS PRODUCT WILL INCREASE EYE HAZARD.**



#### CAUTION

- Do not allow this unit to come into contact with liquids. Electrical shock could result. Also, this unit damage, smoke, and overheat could result from contact with liquids.
- Keep this manual handy as a reference for operating procedures and precautions.
- Always keep the volume low enough so that you can hear sounds from outside the vehicle.
- Protect this unit from moisture.
- If the battery is disconnected or discharged, the preset memory will be erased and must be reprogrammed.



#### Important (Serial number)

The serial number is located on the bottom of this unit. For your own security and convenience, be sure to record this number on the enclosed warranty card. 

### About this manual

This unit features a number of sophisticated functions ensuring superior reception and operation. All the functions have been designed for the easiest possible use, but many are not self-explanatory. This operation manual will help you benefit fully from this unit's potential and to maximize your listening enjoyment. We recommend that you familiarize yourself with the functions and their operation by reading through the manual before you begin using this unit. It is especially important that you read and observe **WARNINGS** and **CAUTIONS** in this manual. 

## Before You Start

### After-sales service for Pioneer products

Please contact the dealer or distributor from where you purchased this unit for after-sales service (including warranty conditions) or any other information. In case the necessary information is not available, please contact the companies listed below:

Please do not ship your unit to the companies at the addresses listed below for repair without advance contact.

#### U.S.A.

Pioneer Electronics (USA) Inc.  
CUSTOMER SUPPORT DIVISION  
P.O. Box 1760  
Long Beach, CA 90801-1760  
800-421-1404

#### CANADA

Pioneer Electronics of Canada, Inc.  
CUSTOMER SATISFACTION DEPARTMENT  
300 Allstate Parkway  
Markham, Ontario L3R 0P2  
1-877-283-5901

For warranty information please see the Limited Warranty sheet included with this unit. 

### Product registration

Visit us at the following site:

<http://www.pioneerelectronics.com>

- 1 Register your product. We will keep the details of your purchase on file to help you refer to this information in the event of an insurance claim such as loss or theft.
- 2 Receive updates on the latest products and technologies.

- 3 Download owner's manuals, order product catalogues, research new products, and much more. 

### Features

#### CD playback

Music CD/CD-R/CD-RW playback is possible.

#### MP3 file playback

You can play back MP3 files recorded on CD-ROM/CD-R/CD-RW (ISO9660 Level 1/Level 2 standard recordings).

- Supply of this product only conveys a license for private, non-commercial use and does not convey a license nor imply any right to use this product in any commercial (i.e. revenue-generating) real time broadcasting (terrestrial, satellite, cable and/or any other media), broadcasting/streaming via internet, intranets and/or other networks or in other electronic content distribution systems, such as pay-audio or audio-on-demand applications. An independent license for such use is required. For details, please visit <http://www.mp3licensing.com>.

#### WMA file playback

You can play back WMA files recorded on CD-ROM/CD-R/CD-RW (ISO9660 Level 1/Level 2 standard recordings).

#### AAC file playback

You can play back AAC files recorded on CD-ROM/CD-R/CD-RW (ISO9660 Level 1/Level 2 standard recordings).

#### WAV file playback

You can play back WAV files recorded on CD-ROM/CD-R/CD-RW (Linear PCM (LPCM)/MS ADPCM recordings).

## Before You Start

### iPod compatibility

When you use this unit with a Pioneer iPod adapter (CD-IB100), you can control an iPod, iPod mini, iPod Photo.

- iPod® is a trademark of Apple Computer, Inc., registered in the U.S. and other countries. 

### About WMA



The Windows Media™ logo printed on the box indicates that this unit can play back WMA data.

WMA is short for Windows Media Audio and refers to an audio compression technology that is developed by Microsoft Corporation. WMA data can be encoded by using Windows Media Player version 7 or later.

Windows Media and the Windows logo are trademarks or registered trademarks of Microsoft Corporation in the United States and/or other countries.

#### Notes

- This unit may not operate correctly depending on the application used to encode WMA files.
- Depending on the version of Windows Media Player used to encode WMA files, album names and other text information may not be correctly displayed. 

### About AAC

AAC is short for Advanced Audio Coding and refers to an audio compression technology standard used with MPEG 2 and MPEG 4.

Several applications can be used to encode AAC files, but file formats and extensions differ depending on the application which is used to encode.

This unit plays back AAC files encoded by iTunes® version 4.8 and earlier.

iTunes® is a trademark of Apple Computer, Inc., registered in the U.S. and other countries. 

### About the SAT RADIO READY mark



The SAT RADIO READY mark printed on the front panel indicates that the Satellite Radio Tuner for Pioneer (i.e., XM tuner and Sirius satellite tuner which are sold separately) can be controlled by this unit. Please inquire to your dealer or nearest authorized Pioneer service station regarding the satellite radio tuner that can be connected to this unit. For satellite radio tuner operation, please refer to the satellite radio tuner owner's manual.

#### Notes

- The system will use direct satellite-to-receiver broadcasting technology to provide listeners in their cars and at home with crystal-clear sound seamlessly from coast to coast. Satellite radio will create and package over 100 channels of digital-quality music, news, sports, talk and children's programming.
- "SAT Radio", the SAT Radio logo and all related marks are trademarks of Sirius Satellite Radio inc., and XM Satellite Radio Inc. 

## Resetting the microprocessor

The microprocessor must be reset under the following conditions:

- Prior to using this unit for the first time after installation
- If the unit fails to operate properly
- When strange or incorrect messages appear on the display

- **Press RESET with a pen tip or other pointed instrument.**

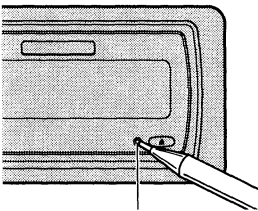

RESET button



## Protecting your unit from theft

The front panel can be detached from the head unit and stored in the provided protective case to prevent theft.

- If the front panel is not detached from the head unit within five seconds of turning off the ignition, a warning tone will sound and the front panel will open.
- You can turn off the warning tone. See *Switching the warning tone* on page 61.
- You can turn off the face auto open. See *Switching the face auto open* on page 61.

### Important

- Never use force or grip the display and the buttons too tightly when removing or attaching.

- Avoid subjecting the front panel to excessive shocks.
- Keep the front panel out of direct sunlight and high temperatures.
- A few seconds after turning the ignition switch to on or off, the front panel automatically moves. When this happens, your fingers may become jammed in the panel, so keep your hands away from it.
- When removing the front panel, be sure to hold the corrugated release button on the rear of the front panel while pulling.

## Removing the front panel

- 1 Press and hold EJECT to open the front panel.**

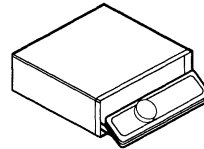

- 2 Press the release button, slide and remove the front panel toward you.**

Take care not to grip it too tightly or to drop the front panel and protect it from contact with water or other fluids to prevent permanent damage.

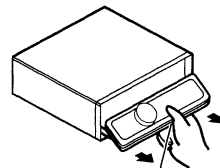

Release button

- 3 Put the front panel into provided protective case for safe keeping.**



## Before You Start

### Attaching the front panel

- 1 Make sure the inner cover is closed.
- 2 Replace the front panel by clipping it into place.

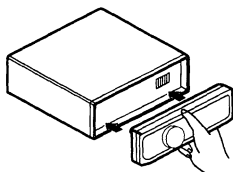

### About the demo mode

This unit features two demonstration modes. One is the reverse mode, the other is the feature demo mode.

#### Important

The red lead (ACC) of this unit should be connected to a terminal coupled with ignition switch on/off operations. If this is not done, the vehicle battery may be drained.

### Reverse mode

If you do not perform an operation within about 30 seconds, screen indications start to reverse, and then continue reversing every 10 seconds. Pressing **BAND** when power to this unit is turned off while the ignition switch is set to ACC or ON cancels the reverse mode. Press **BAND** again to start the reverse mode.

### Feature demo mode

The feature demo automatically starts when power to this unit is turned off while the ignition switch is set to ACC or ON. Pressing **DISPLAY** during feature demo operation can-

cells the feature demo mode. Press **DISPLAY** again to start the feature demo mode. Remember that if the feature demo continues operating when the car engine is turned off, it may drain battery power. 

## Use and care of the remote control

### Installing the battery

Slide the tray out on the back of the remote control and insert the battery with the plus (+) and minus (-) poles pointing in the proper direction.

- When using for the first time, pull out the film protruding from the tray.

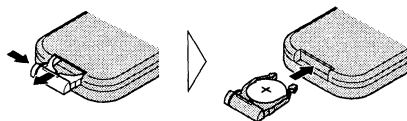

#### WARNING

Keep the battery out of the reach of children. Should the battery be swallowed, immediately consult a doctor.

#### CAUTION

- Use only one **CR2025 (3 V)** lithium battery.
- Remove the battery if the remote control is not used for a month or longer.
- Do not recharge, disassemble, heat or dispose of the battery in fire.
- Do not handle the battery with metallic tools.
- Do not store the battery with metallic materials.
- In the event of battery leakage, wipe the remote control completely clean and install a new battery.

## Before You Start

- When disposing of used batteries, please comply with governmental regulations or environmental public institutions' rules that apply in your country/area.

### Using the remote control

Point the remote control in the direction of the front panel to operate.

- The remote control may not function properly in direct sunlight.



#### Important

- Do not store the remote control in high temperatures or direct sunlight.
- Do not let the remote control fall onto the floor, where it may become jammed under the brake or accelerator pedal.

### FUNCTION button and AUDIO button

You can also select the desired mode by **FUNCTION** button and **AUDIO** button on the remote control. But operation of **FUNCTION** button and **AUDIO** button on the remote control differs from the operation of **MULTI-CONTROL** on the head unit. When operating the remote control, switch through the modes as described below to select the mode.

#### FUNCTION button operation

- **Press FUNCTION to select the desired mode (e.g., built-in CD player).**

Press **FUNCTION** repeatedly to switch between the following modes:

**Play mode** (repeat play)—**Random mode** (random play)—**Scan mode** (scan play)—**Pause** (pause)—**Compression** (compression and BMX)—**Search mode** (search method)—**TitleInput "A"** (disc title input)



#### Note

Refer to *Introduction of advanced built-in CD player operation* on page 19.

#### AUDIO button operation

- **Press AUDIO to select the desired mode.**

Press **AUDIO** repeatedly to switch between the following modes:

**Fader** (balance adjustment)—**Powerful** (graphic equalizer adjustment)—**50Hz** (7-band graphic equalizer adjustment)—**LOUD** (loudness)—**Sub W.1** (subwoofer on/off setting)—**Sub W.2** (subwoofer setting)—**Bass** (bass boost)—**HPF** (high pass filter)—**SLA** (source level adjustment)



#### Note

Refer to *Introduction of audio adjustments* on page 55. 

## What's What

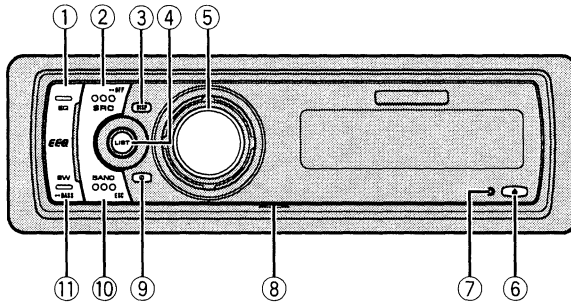

### Head unit

#### ① EQ button

Press to select various equalizer curves.

#### ② SOURCE button

This unit is turned on by selecting a source. Press to cycle through all the available sources.

#### ③ DISPLAY button

Press to select different displays.

#### ④ LIST button

Press to display the disc title list, track title list, folder list, file list or preset channel list depending on the source.

#### ⑤ MULTI-CONTROL

Move to perform manual seek tuning, fast forward, reverse and track search controls. Also used for controlling functions. Turn to increase or decrease the volume.

#### ⑥ EJECT button

Press to eject a CD from your built-in CD player. Press and hold to open or close the front panel.

#### ⑦ RESET button

Press to reset the microprocessor.

#### ⑧ AUX1 input jack (2.5 mm stereo jack)

Use to connect an auxiliary equipment.

#### ⑨ CLOCK button

Press to change to the clock display.

#### ⑩ BAND button

Press to select among three FM bands and one AM band and to cancel the control mode of functions.

#### ⑪ SW button

Press to select the subwoofer setting menu. Press and hold to select the bass boost setting menu.

### Remote control

Operation is the same as when using the buttons on the head unit.

#### ⑫ VOLUME buttons

Press to increase or decrease the volume.

#### ⑬ FUNCTION button

Press to select functions.

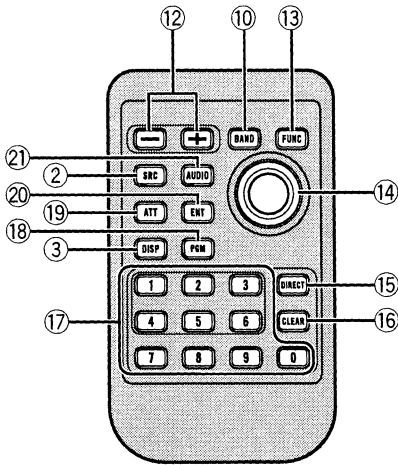

⑭ **Joystick**

Move to perform manual seek tuning, fast forward, reverse and track search controls. Also used for controlling functions. Functions are the same as **MULTI-CONTROL** except for volume control.

⑮ **DIRECT button**

Press to directly select the desired track.

⑯ **CLEAR button**

Press to cancel the input number when **0-9** are used.

⑰ **0-9 buttons**

Press to directly select the desired track, preset tuning or disc. Buttons **1-6** can operate the preset tuning for the tuner or disc number search for the multi-CD player.

⑱ **PGM button**

Press to operate the preprogrammed functions for each source. (Refer to *Using the PGM button* on page 66.)

⑲ **ATT button**

Press to quickly lower the volume level, by about 90%. Press once more to return to the original volume level.

⑳ **ENTERTAINMENT button**

Press to change to the entertainment display.

㉑ **AUDIO button**

Press to select various sound quality controls. 

## Basic Operations

### Turning the unit on

- **Press SOURCE to turn the unit on.**

When you select a source, the unit is turned on. 

### Selecting a source

You can select a source you want to listen to. To switch to the built-in CD player, load a disc in the unit (refer to page 18).

- **Press SOURCE to select a source.**

Press **SOURCE** repeatedly to switch between the following sources:

**XM tuner—SIRIUS tuner—Tuner—Television—DVD player/Multi-DVD player—Built-in CD player—Multi-CD player—iPod—External unit 1—External unit 2—AUX1—AUX2**



#### Notes

- In the following cases, the sound source will not change:
  - When there is no unit corresponding to the selected source connected to this unit.
  - When there is no disc in the unit.
  - When there is no disc in the DVD player.
  - When there is no magazine in the multi-CD player.
  - When there is no magazine in the multi-DVD player.
  - When the AUX (auxiliary input) is set to off (refer to page 61).
- External unit refers to a Pioneer product (such as one available in the future) that, although incompatible as a source, enables control of basic functions by this unit. Two external units can be controlled by this unit. When two external units are connected, the allocation of them to external unit 1 or external unit 2 is automatically set by this unit.

- When this unit's blue/white lead is connected to the vehicle's auto-antenna relay control terminal, the vehicle's antenna extends when this unit's source is turned on. To retract the antenna, turn the source off. 

### Loading a disc

- 1 Press EJECT to open the front panel.**

CD loading slot appears.

- After a CD has been inserted, press **SOURCE** to select the built-in CD player.

- 2 Insert a CD into the CD loading slot.**

Front panel is closed automatically, and playback will start.

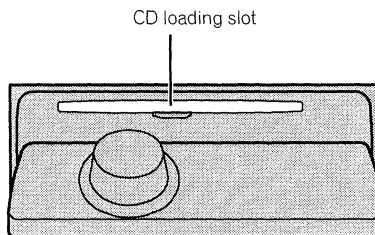

- You can eject a CD by pressing **EJECT**.



#### Notes

- The built-in CD player plays one standard, 12-cm or 8-cm CD at a time. Do not use an adapter when playing 8-cm CDs.
- Do not insert anything other than a CD into the CD loading slot.
- There is sometimes a delay between starting up CD playback and the sound being issued. When being read, **Format read** is displayed.
- If you cannot insert a disc completely or if after you insert a disc the disc does not play, check that the label side of the disc is up. Press **EJECT** to eject the disc, and check the disc for damage before inserting it again.

- When the CD loading or ejecting function does not operate properly, you can eject the CD by pressing and holding **EJECT** while opening the front panel.
- If an error message such as **ERROR-11** is displayed, refer to *Understanding built-in CD player error messages* on page 67. 

## Adjusting the volume

- Use **MULTI-CONTROL** to adjust the sound level.

With the head unit, rotate **MULTI-CONTROL** to increase or decrease the volume.

With the remote control, press **VOLUME** to increase or decrease the volume. 

## Turning the unit off

- Press **SOURCE** and hold until the unit turns off. 

## Tuner

### Listening to the radio

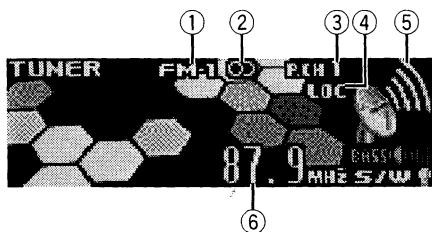

These are the basic steps necessary to operate the radio. More advanced tuner operation is explained starting on the next page.

- ① **Band indicator**  
Shows which band the radio is tuned to, AM or FM.
- ② **Stereo (Ⓞ) indicator**  
Shows when the selected frequency is being broadcast in stereo.
- ③ **Preset number indicator**  
Shows which preset has been selected.
- ④ **LOC indicator**  
Shows when local seek tuning is on.
- ⑤ **Signal level indicator**  
Shows the radio wave strength.
- ⑥ **Frequency indicator**  
Shows the frequency to which the tuner is tuned.

#### 1 Press SOURCE to select the tuner.

Press **SOURCE** until you see **Tuner** displayed.

#### 2 Press BAND to select a band.

Press **BAND** until the desired band (**FM-1**, **FM-2**, **FM-3** for FM or **AM**) is displayed.

#### 3 To perform manual tuning, push **MULTI-CONTROL** left or right.

The frequencies move up or down step by step.

#### 4 To perform seek tuning, push and hold **MULTI-CONTROL** left or right for about one second and release.

The tuner will scan the frequencies until a broadcast strong enough for good reception is found.

- You can cancel seek tuning by pushing **MULTI-CONTROL** left or right.
- If you push and hold **MULTI-CONTROL** left or right you can skip stations. Seek tuning starts as soon as you release **MULTI-CONTROL**. ▣

## Introduction of advanced tuner operation



①

### ① Function display

Shows the function status.

### 1 Press MULTI-CONTROL to display the main menu.

**FUNCTION**, **AUDIO** and **ENTERTAINMENT** appear on the display.

### 2 Use MULTI-CONTROL to select FUNCTION.

Turn to change the menu option; press to select.

The function name appears on the display.

### 3 Turn MULTI-CONTROL to select the function.

Turn **MULTI-CONTROL** clockwise to switch between the functions in the following order:

**BSM** (best stations memory)—**Local** (local seek tuning)

- You can also switch between the functions in reverse order by turning **MULTI-CONTROL** counterclockwise.

- To return to the frequency display, press **BAND**.



#### Note

If you do not operate the function within about 30 seconds, the display is automatically returned to the frequency display. □

## Storing and recalling broadcast frequencies

You can easily store up to six broadcast frequencies for later recall.

**1 When you find a frequency that you want to store in memory press LIST to switch to the preset channel list mode.**

**2 Use MULTI-CONTROL to store the selected frequency in memory.**

Turn to change the preset number; press and hold to store.

The preset number you have selected will flash and then remain lit. The selected radio station frequency has been stored in memory.

- If you do not operate the list within about 8 seconds, the preset channel list mode is canceled automatically.



#### Notes

- Up to 18 FM stations, six for each of the three FM bands, and six AM stations can be stored in memory.
- You can also store radio station frequencies assigned to preset tuning numbers by pressing and holding one of the preset tuning buttons **1-6** on the remote control. □

## Storing the strongest broadcast frequencies

**BSM** (best stations memory) lets you automatically store the six strongest broadcast frequencies under preset tuning buttons **1-6**. Once stored you can tune in to those frequencies with the touch of button.

**1 Use MULTI-CONTROL to select BSM. BSM** appears in the display.



## Tuner

**2 Press MULTI-CONTROL to turn BSM on.** **Searching** is displayed. While **Searching** is displayed, the six strongest broadcast frequencies will be stored under preset tuning numbers **1–6** in the order of their signal strength. When finished, the preset channel list appears.

- To cancel the storage process, press **MULTI-CONTROL**.

**3 Use MULTI-CONTROL to select the desired station.**

Turn to change the station; press to select.

- You can also change the station by pushing **MULTI-CONTROL** up or down.



### Note

Storing broadcast frequencies with BSM may replace broadcast frequencies you have saved using buttons **1–6**. 

## Selecting stations from the preset channel list

The preset channel list lets you see the list of preset stations and select one of them to receive.

**1 Press LIST to switch to the preset channel list mode during the frequency display.**

**2 Use MULTI-CONTROL to select the desired station.**

Turn to change the station; press to select.

- You can also change the station by pushing **MULTI-CONTROL** up or down.
- If you do not operate the list within about 8 seconds, the preset channel list mode is canceled automatically.



### Notes

- You can also recall radio station frequencies assigned to preset tuning numbers by pushing **MULTI-CONTROL** up or down during the frequency display.
- You can also recall radio station frequencies assigned to preset tuning numbers by pressing one of the preset tuning buttons **1–6** on the remote control. 

## Tuning in strong signals

Local seek tuning lets you tune in only those radio stations with sufficiently strong signals for good reception.

**1 Use MULTI-CONTROL to select Local.**

**Local** appears in the display.

**2 Press MULTI-CONTROL to turn local seek tuning on.**

Local seek sensitivity (e.g., **Level 2**) appears in the display.

- To turn local seek tuning off, press **MULTI-CONTROL** again.

**3 Push MULTI-CONTROL left or right to set the sensitivity.**

There are four levels of sensitivity for FM and two levels for AM:

FM: **Level 1—Level 2—Level 3—Level 4**

AM: **Level 1—Level 2**

The **Level 4** setting allows reception of only the strongest stations, while lower settings let you receive progressively weaker stations. 

## Playing a CD

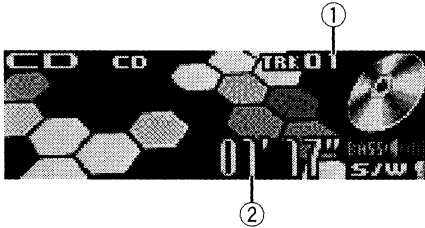

These are the basic steps necessary to play a CD with your built-in CD player. More advanced CD operation is explained starting on the next page.

### ① Track number indicator

Shows the track currently playing.

### ② Play time indicator

Shows the elapsed playing time of the current track.

### 1 Press SOURCE to select the built-in CD player.

Press **SOURCE** until you see **Compact Disc** displayed.

- If no disc is loaded in the unit, you cannot select **Compact Disc** (built-in CD player). Insert a disc in the unit. (Refer to page 13.)

### 2 To perform fast forward or reverse, push and hold MULTI-CONTROL left or right.

- If you select **Rough search**, pushing and holding **MULTI-CONTROL** left or right enables you to search every 10 tracks in the current disc. (Refer to *Selecting the search method* on page 20.)

### 3 To skip back or forward to another track, push MULTI-CONTROL left or right.

Pushing **MULTI-CONTROL** right skips to the start of the next track. Pushing **MULTI-CONTROL** left once skips to the start

of the current track. Pushing again will skip to the previous track.

### Note

When a CD TEXT disc is inserted, the disc title automatically begins to scroll in the display. When Ever Scroll is set to ON at the initial setting, the disc title scrolls continuously. Refer to *Switching the Ever Scroll* on page 63. □

## Selecting a track directly

When using the remote control, you can select a track directly by entering the desired track number.

### 1 Press DIRECT.

Track number input display appears.

### 2 Press 0–9 buttons to enter the desired track number.

- You can cancel the input number by pressing **CLEAR**.

### 3 Press DIRECT.

The track of entered number will play.

### Note

After entering the number input mode, if you do not perform an operation within about eight seconds, the mode is automatically canceled. □

## Built-in CD Player

### Introduction of advanced built-in CD player operation



#### ① Function display

Shows the function status.

#### 1 Press MULTI-CONTROL to display the main menu.

**FUNCTION**, **AUDIO** and **ENTERTAINMENT** appear on the display.

#### 2 Use MULTI-CONTROL to select FUNCTION.

Turn to change the menu option; press to select.

The function name appears on the display.

#### 3 Turn MULTI-CONTROL to select the function.

Turn **MULTI-CONTROL** clockwise to switch between the functions in the following order:

**Play mode** (repeat play)—**Random mode** (random play)—**Scan mode** (scan play)—**Pause** (pause)—**Compression** (compression and BMX)—**Search mode** (search method)—**TitleInput "A"** (disc title input)

- You can also switch between the functions in reverse order by turning **MULTI-CONTROL** counterclockwise.
- To return to the playback display, press **BAND**.

#### Note

If you do not operate the function within about 30 seconds, the display is automatically returned to the playback display. 

### Repeating play

There are two repeat play ranges for the built-in CD player: **Disc repeat** (disc repeat) and **Track repeat** (one-track repeat).

#### 1 Use MULTI-CONTROL to select Play mode.

**Play mode** appears in the display.

#### 2 Press MULTI-CONTROL to select the repeat range.

Press **MULTI-CONTROL** repeatedly until the desired repeat range appears in the display.

- **Disc repeat** – Repeat the current disc
- **Track repeat** – Repeat just the current track



#### Note

If you perform track search or fast forward/reverse during **Track repeat**, the repeat play range changes to **Disc repeat**. 

### Playing tracks in random order

Random play lets you play back tracks on the CD in a random order.

#### 1 Use MULTI-CONTROL to select Random mode.

**Random mode** appears in the display.

#### 2 Press MULTI-CONTROL to turn random play on.

Tracks will play in a random order.

- To turn random play off, press **MULTI-CONTROL** again. 

## Built-in CD Player

### Scanning tracks of a CD

Scan play lets you hear the first 10 seconds of each track on the CD.

**1 Use MULTI-CONTROL to select Scan mode.**

**Scan mode** appears in the display.

**2 Press MULTI-CONTROL to turn scan play on.**

The first 10 seconds of each track is played.

**3 When you find the desired track press MULTI-CONTROL to turn scan play off.**

The track will continue to play.

- If the display has automatically returned to the playback display, select **Scan mode** again by using **MULTI-CONTROL**.



#### Note

After scanning of a CD is finished, normal playback of the tracks will begin again.

### Pausing CD playback

Pause lets you temporarily stop playback of the CD.

**1 Use MULTI-CONTROL to select Pause.**  
**Pause** appears in the display.

**2 Press MULTI-CONTROL to turn pause on.**

Playback of the current track pauses.

- To turn pause off, press **MULTI-CONTROL** again.

### Using compression and BMX

Using the COMP (compression) and BMX functions let you adjust the sound playback quality of this player. Each of the functions has a two-step adjustment. The COMP function balances the output of louder and softer sounds at higher volumes. BMX controls sound reverberations to give playback a fuller sound. Listen to each of the effects as you select through them and use the one that best enhances the playback of the track or CD that you are listening to.

**1 Use MULTI-CONTROL to select Compression.**

**Compression** appears in the display.

**2 Press MULTI-CONTROL to select your favorite setting.**

Press **MULTI-CONTROL** repeatedly to switch between the following settings:

**COMP/BMX OFF—COMP 1—COMP 2—  
COMP/BMX OFF—BMX 1—BMX 2**

### Selecting the search method

You can switch the search method between fast forward/reverse and searching every 10 tracks.

**1 Use MULTI-CONTROL to select Search mode.**

**Search mode** appears in the display.

**2 Press MULTI-CONTROL to select the search method.**

Press **MULTI-CONTROL** until the desired search method appears in the display.

- **FF/REV** – Fast forward and reverse
- **Rough search** – Searching every 10 tracks

## Built-in CD Player

### Searching every 10 tracks in the current disc

If a disc contains over 10 tracks, you can search every 10 tracks. When a disc contains many tracks, you can roughly search for the track you want to play.

#### 1 Select the search method **Rough search**.

Refer to *Selecting the search method* on the previous page.

#### 2 Push and hold **MULTI-CONTROL** left or right to search every 10 tracks on a disc.

- If a disc contains less than 10 tracks, pushing and holding **MULTI-CONTROL** right recalls the last track of the disc. Also, if the remaining number of tracks after searching every 10 tracks is less than 10, pushing and holding

**MULTI-CONTROL** right recalls the last track of the disc.

- If a disc contains less than 10 tracks, pushing and holding **MULTI-CONTROL** left recalls the first track of the disc. Also, if the remaining number of tracks after searching every 10 tracks is less than 10, pushing and holding **MULTI-CONTROL** left recalls the first track of the disc. □

### Using disc title functions

You can input CD titles and display the title. The next time you insert a CD for which you have entered a title, the title of that CD will be displayed.

Use the disc title input feature to store up to 48 CD titles in the unit. Each title can be up to 10 characters long.

- When playing a CD TEXT disc, you cannot switch to disc title input display. The disc title will have already been recorded on a CD TEXT disc.

### Entering disc titles

You can display the text information of any disc that has had a disc title entered.

#### 1 Play the CD that you want to enter a title for.

#### 2 Use **MULTI-CONTROL** to select **TitleInput "A"**.

**TitleInput "A"** appears in the display.

#### 3 Press **DISPLAY** to select the desired character type.

Press **DISPLAY** repeatedly to switch between the following character types:

Alphabet (upper case), numbers and symbols  
—Alphabet (lower case)—European letters, such as those with accents (e.g. **á, à, ä, ç**)—  
Numbers and symbols

#### 4 Push **MULTI-CONTROL** up or down to select a letter of the alphabet.

Each time **MULTI-CONTROL** is pushed up, letters of the alphabet are displayed in **A B C ... X Y Z** order, numbers and symbols in **1 2 3 ... @ # <** order. Each time **MULTI-CONTROL** is pushed down, letters are displayed in **Z Y X ... C B A** order.



#### 5 Push **MULTI-CONTROL** right to move the cursor to the next character position.

When the letter you want is displayed, push **MULTI-CONTROL** right to move the cursor to the next position and then select the next letter. Push **MULTI-CONTROL** left to move backwards in the display.

## 6 Move the cursor to the last position by pushing MULTI-CONTROL right after entering the title.

When you push **MULTI-CONTROL** right one more time, the entered title is stored in memory.

## 7 Press BAND to return to the playback display.



### Notes

- Titles remain in memory, even after the disc has been removed from the unit, and are recalled when the disc is reinserted.
- After data for 48 discs has been stored in memory, data for a new disc will overwrite the oldest one.
- If you connect a multi-CD player, you can input disc titles for up to 100 discs.
- When a multi-CD player that does not support disc title functions is connected, you cannot enter disc titles in this unit.

## Displaying disc titles

You can display the text information of any disc that has had a disc title entered.

### ● Press DISPLAY.

Press **DISPLAY** repeatedly to switch between the following settings:

Play time—: disc title and play time—

## Using CD TEXT functions

Some discs have certain information encoded on the disc during manufacture. These discs may contain such information as the CD title, track title, artist's name and playback time and are called CD TEXT discs. Only these specially encoded CD TEXT discs support the functions listed below.

## Displaying text information on CD TEXT discs

You can display the text information of any disc that has had a disc title entered.

### ● Press DISPLAY.

Press **DISPLAY** repeatedly to switch between the following settings:

Play time—: disc title and play time—:  
disc artist name and play time—: track title  
and play time—: track artist name and play  
time—: disc title and : disc artist name  
—: track title and : track artist name

- If specific information has not been recorded on a CD TEXT disc, title or name is not displayed.

## Scrolling text information in the display

This unit can display the first 14 letters of disc title, disc artist name, track title and track artist name. When the text information is longer than 14 letters, you can scroll the text information as follows.

### ● Press DISPLAY and hold until the text information begins to scroll through the display.

The titles scroll.



### Note

When Ever Scroll is set to ON at the initial setting, CD text information scrolls continuously in the display. If you want to display the first 14 characters of text information temporarily and scroll from the beginning, press and hold **DISPLAY**. Refer to *Switching the Ever Scroll* on page 63.

## Built-in CD Player

### Selecting tracks from the track title list

Track title list lets you see the list of track titles on a CD TEXT disc and select one of them to play back.

**1 Press LIST to switch to the track title list mode.**

**2 Use MULTI-CONTROL to select the desired track title.**

Turn to change the track title; press to play.

- You can also change the track title by pushing **MULTI-CONTROL** up or down.
- If you do not operate the list within about 8 seconds, the track title list mode is canceled automatically. 

## Playing MP3/WMA/AAC/WAV files

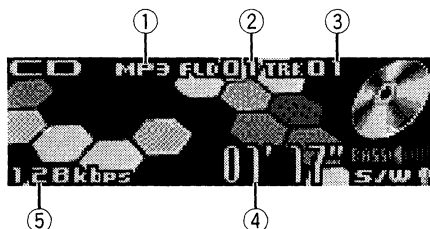

These are the basic steps necessary to play an MP3/WMA/AAC/WAV files with your built-in CD player. More advanced MP3/WMA/AAC/WAV operation is explained starting on the next page.

- ① **MP3/WMA/AAC/WAV indicator**  
Shows the type of file currently playing.
- ② **Folder number indicator**  
Shows the number of folder currently playing.
- ③ **Track number indicator**  
Shows the track (file) currently playing.
- ④ **Play time indicator**  
Shows the elapsed playing time of the current track (file).
- ⑤ **Bit rate/sampling frequency indicator**  
Shows the bit rate or sampling frequency of the current track (file).

### 1 Press SOURCE to select the built-in CD player.

Press **SOURCE** until you see **Compact Disc** displayed.

- If no disc is loaded in the unit, you cannot select **Compact Disc** (built-in CD player). Insert a disc in the unit. (Refer to page 13.)

### 2 Push MULTI-CONTROL up or down to select a folder.

- You cannot select a folder that does not have an MP3/WMA/AAC/WAV file recorded in it.
- To return to folder 01 (ROOT), press and hold **BAND**. However, if folder 01 (ROOT) contains no files, playback commences with folder 02.

### 3 To perform fast forward or reverse, push and hold MULTI-CONTROL left or right.

- If you select **Rough search**, pushing and holding **MULTI-CONTROL** left or right enables you to search every 10 tracks in the current folder. (Refer to *Selecting the search method* on page 27.)

### 4 To skip back or forward to another track, push MULTI-CONTROL left or right.

Pushing **MULTI-CONTROL** right skips to the start of the next track. Pushing **MULTI-CONTROL** left once skips to the start of the current track. Pushing again will skip to the previous track.



#### Notes

- When playing discs with MP3/WMA/AAC/WAV files and audio data (CD-DA) such as CD-EXTRA and MIXED-MODE CDs, both types can be played only by switching mode between MP3/WMA/AAC/WAV and CD-DA with **BAND**.
- If you have switched between playback of MP3/WMA/AAC/WAV files and audio data (CD-DA), playback starts at the first track on the disc.
- The built-in CD player can play back an MP3/WMA/AAC/WAV file recorded on CD-ROM. (Refer to page 68 for files that can be played back.)
- Playback is carried out in order of file number. Folders are skipped if they contain no files. (If folder 01 (ROOT) contains no files, playback commences with folder 02.)



## MP3/WMA/AAC/WAV Player

- When playing back files recorded as VBR (variable bit rate) files, the play time will not be correctly displayed if fast forward or reverse operations are used.
- There is no sound on fast forward or reverse.
- When the display setting is switched to the text information by pressing **DISPLAY**, folder name and file name automatically begin to scroll in the display. When Ever Scroll is set to ON at the initial setting, folder and file name scroll continuously. About Ever Scroll, refer to *Switching the Ever Scroll* on page 63. 

### Selecting a track directly in the current folder

When using the remote control, you can select a track directly by entering the desired track number.

#### 1 Press **DIRECT**.

Track number input display appears.

#### 2 Press 0–9 buttons to enter the desired track number.

- You can cancel the input number by pressing **CLEAR**.

#### 3 Press **DIRECT**.

The track of entered number will play.



#### Note

After entering the number input mode, if you do not perform an operation within about eight seconds, the mode is automatically canceled. 

### Introduction of advanced built-in CD player (MP3/WMA/AAC/WAV) operation

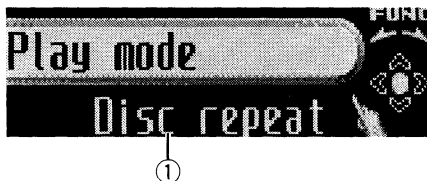

#### ① Function display

Shows the function status.

#### 1 Press **MULTI-CONTROL** to display the main menu.

**FUNCTION**, **AUDIO** and **ENTERTAINMENT** appear on the display.

#### 2 Use **MULTI-CONTROL** to select **FUNCTION**.

Turn to change the menu option; press to select.

The function name appears on the display.

#### 3 Turn **MULTI-CONTROL** to select the function.

Turn **MULTI-CONTROL** clockwise to switch between the functions in the following order:

**Play mode** (repeat play)—**Random mode** (random play)—**Scan mode** (scan play)—**Pause** (pause)—**Compression** (compression and BMX)—**Search mode** (search method)

- You can also switch between the functions in reverse order by turning **MULTI-CONTROL** counterclockwise.
- To return to the playback display, press **BAND**.

**Note**

If you do not operate the function within about 30 seconds, the display is automatically returned to the playback display.

## Repeating play

For MP3/WMA/AAC/WAV playback, there are three repeat play ranges: **Folder repeat** (folder repeat), **Track repeat** (one-track repeat) and **Disc repeat** (repeat all tracks).

**1 Use MULTI-CONTROL to select Play mode.**  
**Play mode** appears in the display.

**2 Press MULTI-CONTROL to select the repeat range.**

Press **MULTI-CONTROL** repeatedly until the desired repeat range appears in the display.

- **Folder repeat** – Repeat the current folder
- **Track repeat** – Repeat just the current track
- **Disc repeat** – Repeat all tracks

**Notes**

- If you select another folder during repeat play, the repeat play range changes to **Disc repeat**.
- If you perform track search or fast forward/reverse during **Track repeat**, the repeat play range changes to **Folder repeat**.
- When **Folder repeat** is selected, it is not possible to play back a subfolder of that folder.

## Playing tracks in random order

Random play lets you play back tracks in a random order within the repeat range, **Folder repeat** and **Disc repeat**.

**1 Select the repeat range.**

Refer to *Repeating play* on this page.

**2 Use MULTI-CONTROL to select Random mode.**

**Random mode** appears in the display.

**3 Press MULTI-CONTROL to turn random play on.**

Tracks will play in a random order within the previously selected **Folder repeat** or **Disc repeat** ranges.

- To turn random play off, press **MULTI-CONTROL** again.

## Scanning folders and tracks

While you are using **Folder repeat**, the beginning of each track in the selected folder plays for about 10 seconds. When you are using **Disc repeat**, the beginning of the first track of each folder is played for about 10 seconds.

**1 Select the repeat range.**

Refer to *Repeating play* on this page.

**2 Use MULTI-CONTROL to select Scan mode.**

**Scan mode** appears in the display.

**3 Press MULTI-CONTROL to turn scan play on.**

The first 10 seconds of each track of the current folder (or the first track of each folder) is played.

**4 When you find the desired track (or folder) press MULTI-CONTROL to turn scan play off.**

The track (or folder) will continue to play.

- If the display has automatically returned to the playback display, select **Scan mode** again by using **MULTI-CONTROL**.

## MP3/WMA/AAC/WAV Player



### Note

After track or folder scanning is finished, normal playback of the tracks will begin again.

## Pausing MP3/WMA/AAC/WAV playback

Pause lets you temporarily stop playback of the MP3/WMA/AAC/WAV.

### 1 Use MULTI-CONTROL to select Pause.

**Pause** appears in the display.

### 2 Press MULTI-CONTROL to turn pause on.

Playback of the current track pauses.

▪ To turn pause off, press **MULTI-CONTROL** again.

## Using compression and BMX

Using the COMP (compression) and BMX functions let you adjust the sound playback quality of this player. Each of the functions has a two-step adjustment. The COMP function balances the output of louder and softer sounds at higher volumes. BMX controls sound reverberations to give playback a fuller sound. Listen to each of the effects as you select through them and use the one that best enhances the playback of the track or CD that you are listening to.

### 1 Use MULTI-CONTROL to select Compression.

**Compression** appears in the display.

### 2 Press MULTI-CONTROL to select your favorite setting.

Press **MULTI-CONTROL** repeatedly to switch between the following settings:

**COMP/BMX OFF—COMP 1—COMP 2—COMP/BMX OFF—BMX 1—BMX 2**

## Selecting the search method

You can switch the search method between fast forward/reverse and searching every 10 tracks.

### 1 Use MULTI-CONTROL to select Search mode.

**Search mode** appears in the display.

### 2 Press MULTI-CONTROL to select the search method.

Press **MULTI-CONTROL** until the desired search method appears in the display.

- **FF/REV** – Fast forward and reverse
- **Rough search** – Searching every 10 tracks

## Searching every 10 tracks in the current folder

If the current folder contains over 10 tracks, you can search every 10 tracks. When one folder contains a lot of tracks, you can roughly search for the track you want to play.

### 1 Select the search method Rough search.

Refer to *Selecting the search method* on this page.

## 2 Push and hold **MULTI-CONTROL** left or right to search every 10 tracks in the current folder.

- If the current folder contains less than 10 tracks, pushing and holding **MULTI-CONTROL** right recalls the last track of the folder. Also, if the remaining number of tracks after searching every 10 tracks is less than 10, pushing and holding **MULTI-CONTROL** right recalls the last track of the folder.
- If the current folder contains less than 10 tracks, pushing and holding **MULTI-CONTROL** left recalls the first track of the folder. Also, if the remaining number of tracks after searching every 10 tracks is less than 10, pushing and holding **MULTI-CONTROL** left recalls the first track of the folder.







## Displaying text information on MP3/WMA/AAC/WAV disc

Text information recorded on an MP3/WMA/AAC/WAV disc can be displayed.

### When playing back an MP3/WMA/AAC disc

#### ● Press **DISPLAY**.

Press **DISPLAY** repeatedly to switch between the following settings:

Play time—: folder name and play time—  
: file name and play time—: folder name and : file name—: artist name and : album title—: artist name and : track title—: comment and play time



- When playing back MP3 files recorded as VBR (variable bit rate) files, the bit rate value is not displayed even after switching to bit rate. (VBR will be displayed.)
- When playing back WMA files recorded as VBR (variable bit rate) files, the average bit rate value is displayed.

- If specific information has not been recorded on an MP3/WMA/AAC disc, title or name is not displayed.
- Depending on the version of iTunes® used to write MP3 files onto a disc, comment information may not be correctly displayed.
- Depending on the version of Windows Media Player used to encode WMA files, album names and other text information may not be correctly displayed.

### When playing back a WAV disc

#### ● Press **DISPLAY**.

Press **DISPLAY** repeatedly to switch between the following settings:

Play time—: folder name and play time—  
: file name and play time—: folder name and : file name

- If specific information has not been recorded on a WAV disc, name is not displayed.
- You can only play back WAV files in the frequencies 16, 22.05, 24, 32, 44.1 and 48 kHz (LPCM), or 22.05 and 44.1 kHz (MS ADPCM). The sampling frequency shown in the display may be rounded.

### Scrolling text information in the display

This unit can display the first 14 letters only of folder name, file name, track title, artist name, album title and comment. When the recorded information is longer than 14 letters, you can scroll the text to the left so that the rest of the text information can be seen.

#### ● Press **DISPLAY** and hold until the text information begins to scroll through the display.

The text information scrolls.

## MP3/WMA/AAC/WAV Player



### Notes

- Unlike MP3, WMA and AAC file format, WAV files display only the folder name and the file name.
- When Ever Scroll is set to ON at the initial setting, CD text information scrolls continuously in the display. If you want to display the first 14 characters of text information temporarily and scroll from the beginning, press and hold **DISPLAY**. Refer to *Switching the Ever Scroll* on page 63.

## Selecting tracks from the file name list

File name list lets you see the list of file names (or folder names) and select one of them to playback.

### 1 Press LIST to switch to the file name list mode.

Names of files and folders appear in the display.

### 2 Use MULTI-CONTROL to select the desired file name (or folder name).

Turn to change the name of file or folder; press to play; push right to see a list of the files (or folders) in the selected folder.

- You can also change the name of file or folder by pushing **MULTI-CONTROL** up or down.
- To return to the previous list (the folder one level higher), push **MULTI-CONTROL** left.
- If the folder/file number is more than 100, last 2-digit of the folder/file number is displayed.
- Number of the folders/files in the currently selected folder will be indicated on the right side of the display.
- If you do not operate the list within about 8 seconds, the file name list mode is canceled automatically.

## Playing a CD

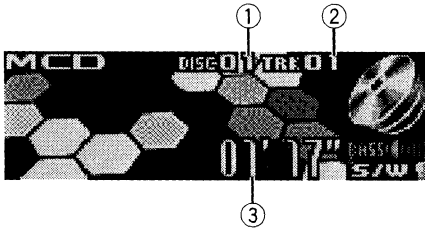

You can use this unit to control a multi-CD player, which is sold separately.

These are the basic steps necessary to play a CD with your multi-CD player. More advanced CD operation is explained starting on the next page.

- ① **Disc number indicator**  
Shows the disc currently playing.
- ② **Track number indicator**  
Shows the track currently playing.
- ③ **Play time indicator**  
Shows the elapsed playing time of the current track.

### 1 Press SOURCE to select the multi-CD player.

Press **SOURCE** until you see **Multi-CD** displayed.

### 2 Push MULTI-CONTROL up or down to select a disc you want to listen to.

- You can also select a disc by using **1-6** buttons on the remote control.
  - For discs 1 to 6, press the corresponding button number.
  - For discs 7 to 12, press and hold the corresponding numbers, such as **1** for disc 7, until the disc number appears in the display.

**3 To perform fast forward or reverse, push and hold MULTI-CONTROL left or right.**

**4 To skip back or forward to another track, push MULTI-CONTROL left or right.** Pushing **MULTI-CONTROL** right skips to the start of the next track. Pushing **MULTI-CONTROL** left once skips to the start of the current track. Pushing again will skip to the previous track.

### Notes

- When the multi-CD player performs the preparatory operations, **Ready** is displayed.
- If an error message such as **ERROR-11** is displayed, refer to the multi-CD player owner's manual.
- If there are no discs in the multi-CD player magazine, **No Disc** is displayed.
- When you select a CD TEXT disc on a CD TEXT compatible multi-CD player, the disc and track titles automatically begin to scroll in the display. Ever Scroll function is ON at the initial setting, the disc and track titles scroll continuously. About Ever Scroll, refer to *Switching the Ever Scroll* on page 63.

## Selecting a track directly

When using the remote control, you can select a track directly by entering the desired track number.

### 1 Press DIRECT.

Track number input display appears.

### 2 Press 0-9 buttons to enter the desired track number.

- You can cancel the input number by pressing **CLEAR**.

## Multi-CD Player

### 3 Press DIRECT.

The track of entered number will play.



#### Note

After entering the number input mode, if you do not perform an operation within about eight seconds, the mode is automatically canceled. □

## 50-disc multi-CD player

Only those functions described in this manual are supported by 50-disc multi-CD players. This unit is not designed to operate disc title list functions with a 50-disc multi-CD player. About the disc title list functions, please refer to *Selecting discs from the disc title list* on page 35. □

## Introduction of advanced multi-CD player operation

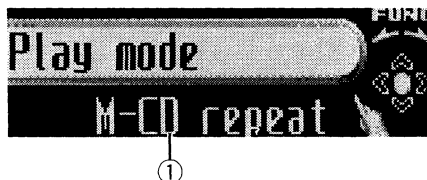

### ① Function display

Shows the function status.

### 1 Press MULTI-CONTROL to display the main menu.

**FUNCTION, AUDIO** and **ENTERTAINMENT** appear on the display.

### 2 Use MULTI-CONTROL to select FUNCTION.

Turn to change the menu option; press to select.

The function name appears on the display.

### 3 Turn MULTI-CONTROL to select the function.

Turn **MULTI-CONTROL** clockwise to switch between the functions in the following order:

**Play mode** (repeat play)—**Random mode**

(random play)—**Scan mode** (scan play)

—**Pause** (pause)—**Compression** (compression and DBE)—**ITS play mode** (ITS play)

—**ITS memo** (ITS programming)

—**TitleInput "A"** (disc title input)

- You can also switch between the functions in reverse order by turning **MULTI-CONTROL** counterclockwise.

- To return to the playback display, press **BAND**.

**Notes**

- When playing a CD TEXT disc on a CD TEXT compatible multi-CD player, you cannot switch to disc title input. The disc title will have already been recorded on a CD TEXT disc.
- If you do not operate the function within about 30 seconds, the display is automatically returned to the playback display.

## Repeating play

There are three repeat play ranges for the multi-CD player: **M-CD repeat** (multi-CD player repeat), **Track repeat** (one-track repeat) and **Disc repeat** (disc repeat).

### 1 Use MULTI-CONTROL to select Play mode.

**Play mode** appears in the display.

### 2 Press MULTI-CONTROL to select the repeat range.

Press **MULTI-CONTROL** repeatedly until the desired repeat range appears in the display.

- **M-CD repeat** – Repeat all discs in the multi-CD player
- **Track repeat** – Repeat just the current track
- **Disc repeat** – Repeat the current disc

**Notes**

- If you select other discs during repeat play, the repeat play range changes to **M-CD repeat**.
- If you perform track search or fast forward/reverse during **Track repeat**, the repeat play range changes to **Disc repeat**.

## Playing tracks in random order

Random play lets you play back tracks in random order within the repeat range, **M-CD repeat** and **Disc repeat**.

### 1 Select the repeat range.

Refer to *Repeating play* on this page.

### 2 Use MULTI-CONTROL to select Random mode.

**Random mode** appears in the display.

### 3 Press MULTI-CONTROL to turn random play on.

Tracks will play in a random order within the previously selected **M-CD repeat** or **Disc repeat** ranges.

- To turn random play off, press **MULTI-CONTROL** again.

## Scanning CDs and tracks

While you are using **Disc repeat**, the beginning of each track on the selected disc plays for about 10 seconds. When you are using **M-CD repeat**, the beginning of the first track of each disc is played for about 10 seconds.

### 1 Select the repeat range.

Refer to *Repeating play* on this page.

### 2 Use MULTI-CONTROL to select Scan mode.

**Scan mode** appears in the display.

### 3 Press MULTI-CONTROL to turn scan play on.

The first 10 seconds of each track of the current disc (or the first track of each disc) is played.



## Multi-CD Player

### 4 When you find the desired track (or disc) press MULTI-CONTROL to turn scan play off.

The track (or disc) will continue to play.

- If the display has automatically returned to the playback display, select **Scan mode** again by using **MULTI-CONTROL**.



#### Note

After track or disc scanning is finished, normal playback of the tracks will begin again. 

## Pausing CD playback

Pause lets you temporarily stop playback of the CD.

### 1 Use MULTI-CONTROL to select Pause. Pause appears in the display.

### 2 Press MULTI-CONTROL to turn pause on.

Playback of the current track pauses.

- To turn pause off, press **MULTI-CONTROL** again. 

## Using ITS playlists

ITS (instant track selection) lets you make a playlist of favorite tracks from those in the multi-CD player magazine. After you have added your favorite tracks to the playlist you can turn on ITS play and play just those selections.

## Creating a playlist with ITS programming

You can use ITS to enter and play back up to 99 tracks per disc from up to 100 discs (with

the disc titles). (With multi-CD players sold before the CDX-P1250 and CDX-P650, up to 24 tracks can be stored in the playlist.)

### 1 Play a CD that you want to program.

Push **MULTI-CONTROL** up or down to select the CD.

### 2 Use MULTI-CONTROL to select ITS memo.

**ITS memo** appears in the display.

### 3 Select the desired track by pushing MULTI-CONTROL left or right.

### 4 Push MULTI-CONTROL up to store the currently playing track in the playlist.

**Memory complete** is displayed and the currently playing selection is added to your playlist.

### 5 Press BAND to return to the playback display.



#### Note

After data for 100 discs has been stored in memory, data for a new disc will overwrite the oldest one.

## Playback from your ITS playlist

ITS play lets you listen to the tracks that you have entered into your ITS playlist. When you turn on ITS play, tracks from your ITS playlist in the multi-CD player will begin to play.

### 1 Select the repeat range.

Refer to *Repeating play* on the previous page.

### 2 Use MULTI-CONTROL to select ITS play mode.

**ITS play mode** appears in the display.

## Multi-CD Player

### 3 Press **MULTI-CONTROL** to turn ITS play on.

**ITS play mode** appears in the display. Playback begins of those tracks from your playlist within the previously selected **M-CD repeat** or **Disc repeat** ranges.

- If no tracks in the current range are programmed for ITS play, then **ITS empty** is displayed.
- To turn ITS play off, press **MULTI-CONTROL** again.

### Erasing a track from your ITS playlist

You can delete a track from your ITS playlist if ITS play is on.

If ITS play is already on, skip to step 2. If ITS play is not already on, use **MULTI-CONTROL**.

#### 1 Play the CD with the track you want to delete from your ITS playlist, and turn ITS play on.

Refer to *Playback from your ITS playlist* on the previous page.

#### 2 Use **MULTI-CONTROL** to select ITS memo.

**ITS memo** appears in the display.

#### 3 Select the desired track by pushing **MULTI-CONTROL** left or right.

#### 4 Push **MULTI-CONTROL** down to erase the track from your ITS playlist.

The currently playing selection is erased from your ITS playlist and playback of the next track from your ITS playlist begins.

- If there are no tracks from your playlist in the current range, **ITS empty** is displayed and normal play resumes.

#### 5 Press **BAND** to return to the playback display.

### Erasing a CD from your ITS playlist

You can delete all tracks of a CD from your ITS playlist if ITS play is off.

#### 1 Play the CD that you want to delete.

Push **MULTI-CONTROL** up or down to select the CD.

#### 2 Use **MULTI-CONTROL** to select ITS memo.

**ITS memo** appears in the display.

#### 3 Push **MULTI-CONTROL** down to erase all tracks on the currently playing CD from your ITS playlist.

All tracks on the currently playing CD are erased from your playlist and

**Memory deleted** is displayed.

#### 4 Press **BAND** to return to the playback display.

### Using disc title functions

You can input CD titles and display the titles. Then you can easily search for and play a desired disc.

### Entering disc titles

Use the disc title input feature to store up to 100 CD titles (with ITS playlist) into the multi-CD player. Each title can be up to 10 characters long.

#### 1 Play the CD that you want to enter a title for.

Push **MULTI-CONTROL** up or down to select the CD.

## Multi-CD Player

### 2 Use MULTI-CONTROL to select TitleInput "A".

TitleInput "A" appears in the display.

### 3 Press DISPLAY to select the desired character type.

Press **DISPLAY** repeatedly to switch between the following character types:

Alphabet (upper case), numbers and symbols  
—Alphabet (lower case)—European letters, such as those with accents (e.g. á, à, ä, ç)—  
Numbers and symbols

### 4 Push MULTI-CONTROL up or down to select a letter of the alphabet.

Each time **MULTI-CONTROL** is pushed up, letters of the alphabet are displayed in **A B C ... X Y Z** order, numbers and symbols in **1 2 3 ... @ # <** order. Each time **MULTI-CONTROL** is pushed down, letters are displayed in **Z Y X ... C B A** order.



### 5 Push MULTI-CONTROL right to move the cursor to the next character position.

When the letter you want is displayed, push **MULTI-CONTROL** right to move the cursor to the next position and then select the next letter. Push **MULTI-CONTROL** left to move backwards in the display.

### 6 Move the cursor to the last position by pushing MULTI-CONTROL right after entering the title.

When you push **MULTI-CONTROL** right one more time, the entered title is stored in memory.

### 7 Press BAND to return to the playback display.

### Notes

- Titles remain in memory, even after the disc has been removed from the magazine, and are recalled when the disc is reinserted.
- After data for 100 discs has been stored in memory, data for a new disc will overwrite the oldest one.

## Displaying disc titles

You can display the text information of any disc that has had a disc title entered.

### ● Press DISPLAY.

Press **DISPLAY** repeatedly to switch between the following settings:

Play time—: disc title and play time

## Selecting discs from the disc title list

Disc title list lets you see the list of disc titles that have been entered into the multi-CD player and select one of them to play back.

### 1 Press LIST to switch to the disc title list mode during the playback display.

### 2 Use MULTI-CONTROL to select the desired disc title.

Turn to change the disc title; press to play.

- You can also change the disc title by pushing **MULTI-CONTROL** up or down.
- If no title has been entered for a disc,

**No D.Title** will be displayed.

- **No Disc** is displayed next to the disc number when there is no disc in the magazine. 

## Using CD TEXT functions

*You can use these functions only with a CD TEXT compatible multi-CD player.*

Some discs have certain information encoded on the disc during manufacture. These discs may contain such information as the CD title, track title, artist's name and playback time and are called CD TEXT discs. Only these specially encoded CD TEXT discs support the functions listed below.

### Displaying text information on CD TEXT discs

- **Press DISPLAY.**

Press **DISPLAY** repeatedly to switch between the following settings:

Play time—: disc title and play time—; disc artist name and play time—; track title and play time—; track artist name and play time—: disc title and : disc artist name —: track title and : track artist name

- If specific information has not been recorded on a CD TEXT disc, title or name is not displayed.

### Scrolling text information in the display

This unit can display the first 14 letters of disc title, disc artist name, track title and track artist name. When the text information is longer than 14 letters, you can scroll the text information as follows.

- **Press DISPLAY and hold until the text information begins to scroll through the display.**

The titles scroll.



#### Note

When Ever Scroll is set to ON at the initial setting, CD text information scrolls continuously in the

display. If you want to display the first 14 characters of text information temporarily and scroll from the beginning, press and hold **DISPLAY**. Refer to *Switching the Ever Scroll* on page 63.

### Selecting tracks from the track title list

Track title list lets you see the list of track titles on a CD TEXT disc and select one of them to play back.

- 1 Press LIST to switch to the disc title list mode during the playback display.**

- If you want to display the track title list of the currently playing disc, push **MULTI-CONTROL** right.

- 2 Use MULTI-CONTROL to select the desired disc title of CD TEXT.**

Turn to change the disc title; press to play.

- You can also change the disc title by pushing **MULTI-CONTROL** up or down.
- If no title has been entered for a disc, **No D.Title** will be displayed.

- **No Disc** is displayed next to the disc number when there is no disc in the magazine.

- 3 Push MULTI-CONTROL right to switch to the track title list.**

- Push **MULTI-CONTROL** left to return to the disc title list.

- 4 Use MULTI-CONTROL to select the desired track title.**

Turn to change the track title; press to play.

- You can also change the track title by pushing **MULTI-CONTROL** up or down.

## Multi-CD Player

### Using compression and bass emphasis

*You can use these functions only with a multi-CD player that supports them.*

Using COMP (compression) and DBE (dynamic bass emphasis) functions lets you adjust the sound playback quality of the multi-CD player. Each of the functions has a two-step adjustment. The COMP function balances the output of louder and softer sounds at higher volumes. DBE boosts bass levels to give playback a fuller sound. Listen to each of the effects as you select them and use the one that best enhances the playback of the track or CD that you are listening to.

#### 1 Use **MULTI-CONTROL** to select **Compression**.

**Compression** appears in the display.

- If the multi-CD player does not support COMP/DBE, **No COMP** is displayed when you attempt to select it.

#### 2 Press **MULTI-CONTROL** to select your favorite setting.

Press **MULTI-CONTROL** repeatedly to switch between the following settings:

**COMP OFF—COMP 1—COMP 2—  
COMP OFF—DBE 1—DBE 2** 

## Playing songs on iPod

### Listening to songs on your iPod

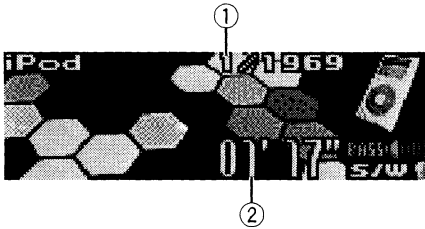

You can use this unit to control an iPod adapter, which is sold separately.

These are the basic steps necessary to operate an iPod adapter. More advanced iPod adapter operation is explained starting on *Introduction of advanced iPod adapter operation* on page 40.

#### ① Song number indicator

Shows the number of song played in the selected list.

#### ② Play time indicator

Shows the elapsed playing time of the current song.

#### 1 Press SOURCE to select the iPod.

Press **SOURCE** until you see **iPod** displayed.

#### 2 To perform fast forward or reverse, push and hold MULTI-CONTROL left or right.

#### 3 To skip back or forward to another song, push MULTI-CONTROL left or right.

Pushing **MULTI-CONTROL** right skips to the start of the next song. Pushing **MULTI-CONTROL** left once skips to the start of the current song. Pushing again will skip to the previous song. ▣

### Browsing for a song

The operation of this unit to control iPod is designed to be as close to the operation of the iPod as possible for easy operation and song search.

#### 1 Press LIST to switch to the top menu of the list search.

#### 2 Use MULTI-CONTROL to select a category.

Turn to change the category; press to select.

**PLAYLIST** (playlists)—**ARTIST** (artists)

—**ALBUM** (albums)—**SONG** (songs)—**GENRE** (genres)

List from the selected category is displayed.

- You can start playback throughout the selected category by pressing and holding

#### **MULTI-CONTROL**.

- You can also change the category by pushing **MULTI-CONTROL** up or down.

- You can also select the category by pushing **MULTI-CONTROL** right.

- To return to the previous list, push **MULTI-CONTROL** left.

- To go to the top menu of the list search, push and hold **MULTI-CONTROL** left.

- If you do not operate the list within about eight seconds, the list search is cancelled automatically.

### Searching for a song

#### 1 Press LIST to switch to the top menu of the list search.

#### 2 Use MULTI-CONTROL to select a GENRE, ARTIST, ALBUM or SONG from among the categories.

Turn to change the category; press to select.

List from the selected category is displayed.

## Playing songs on iPod

### 3 Use MULTI-CONTROL to select a song, album, artist or genre.

Turn to change the item; press to select.

List from the selected item is displayed.

- If you select **SONG** (songs), playback starts instantly from the selected one.

### 4 Repeat step 3 to find a song you want to listen to.

## Selecting a playlist

You can select a playlist from your iPod playlist.

### 1 Press LIST to switch to the top menu of the list search.

### 2 Use MULTI-CONTROL to select a PLAYLIST from among the categories.

Turn to change the category; press to select.

List from **PLAYLIST** (playlists) is displayed.

### 3 Use MULTI-CONTROL to select a playlist.

Turn to change the playlist; press to select.

Song list from the selected playlist is displayed.

- You can start playback throughout the selected playlist by pressing and holding

**MULTI-CONTROL**.

### 4 Use MULTI-CONTROL to select a song from the selected playlist.

Turn to change the song; press to play.



- If no songs have been stored in playlist, **STOP** is displayed and playback stops. 

## Displaying text information on iPod

Text information recorded on the iPod can be displayed.



### ● Press DISPLAY.

Press **DISPLAY** repeatedly to switch between the following settings:

Play time—: album title and play time—:

song title and play time—: artist name and

play time—: artist name and : album title

—: song title and : album title

- If the characters recorded on the iPod are not compatible with this unit, those characters will not be displayed.



### Notes

- You can scroll to the left the text information by pressing and holding **DISPLAY**.
- When Ever Scroll is set to ON at the initial setting, text information scrolls continuously in the display. If you want to display the first 14 characters of text information temporarily and scroll from the beginning, press and hold **DISPLAY**. Refer to *Switching the Ever Scroll* on page 63. 

## Introduction of advanced iPod adapter operation

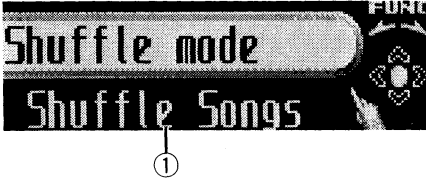

### ① Function display

Shows the function status.

#### 1 Press MULTI-CONTROL to display the main menu.

**FUNCTION**, **AUDIO** and **ENTERTAINMENT** appear on the display.

#### 2 Use MULTI-CONTROL to select **FUNCTION**.

Turn to change the menu option; press to select.

The function name appears on the display.

#### 3 Turn MULTI-CONTROL to select the function.

Turn **MULTI-CONTROL** clockwise to switch between the functions in the following order:

**Play mode** (repeat play)—**Shuffle mode** (random play)—**Pause** (pause)

- You can also switch between the functions in reverse order by turning **MULTI-CONTROL** counterclockwise.
- To return to the playback display, press **BAND**.



#### Note

If you do not operate the function within about 30 seconds, the display is automatically returned to the playback display. □

## Repeating play

For playback of the songs on the iPod, there are two repeat play ranges: **Repeat One** (repeat one song) and **Repeat All** (repeat all songs in the list).

- While **Play mode** is set to **Repeat One**, you cannot select the other songs.

#### 1 Use **MULTI-CONTROL** to select **Play mode**.

**Play mode** appears in the display.

#### 2 Press **MULTI-CONTROL** to select the repeat range.

Press **MULTI-CONTROL** repeatedly until the desired repeat range appears in the display.

- **Repeat One** – Repeat just the current song.
- **Repeat All** – Repeat all songs in the selected list □

## Playing songs in a random order (shuffle)

For playback of the songs on the iPod, there are two random play methods: **Shuffle Songs** (play back songs in a random order) and **Shuffle Albums** (play back albums in a random order).

#### 1 Use **MULTI-CONTROL** to select **Shuffle mode**.

**Shuffle mode** appears in the display.

#### 2 Press **MULTI-CONTROL** to select your favorite setting.

Press **MULTI-CONTROL** repeatedly until the desired setting appears in the display.

- **Shuffle Songs** – Play back songs in a random order within the selected list
- **Shuffle Albums** – Select an album randomly, and then play back all the songs in it in order
- **Shuffle OFF** – Cancel the random play □



## Playing songs on iPod

### Pausing a song

Pause lets you temporarily stop playback of a song.

**1 Use MULTI-CONTROL to select Pause.**

**Pause** appears in the display.

**2 Press MULTI-CONTROL to turn pause on.**

Playback of the current song pauses.

- To turn pause off, press **MULTI-CONTROL** again. 

## Listening to XM Satellite Radio

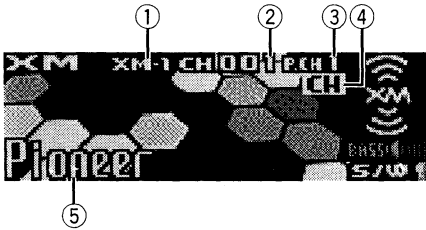

You can use this unit to control an XM satellite digital tuner (GEX-P920XM), which is sold separately.

For details concerning operation, refer to the XM tuner's operation manuals. This section provides information on XM operations with this unit which differs from that described in the XM tuner's operation manual.

- With this unit, you can operate two additional functions: XM channel direct selection and preset channel list.

- ① **XM band indicator**  
Shows the XM band which has been selected.
- ② **XM channel number indicator**  
Shows to which XM channel number the tuner is tuned.
- ③ **XM preset number indicator**  
Shows what XM preset has been selected.
- ④ **XM channel select setting indicator**  
Shows what channel select setting has been selected. **CH** is displayed when **Channel number** is selected, and **CAT** is displayed when **Category** is selected.
- ⑤ **XM text information**  
Shows the text information of broadcast channel.

### 1 Press SOURCE to select the XM.

Press **SOURCE** until you see **XM** displayed.

### 2 Press BAND to select a XM band.

Press **BAND** repeatedly until the desired XM band is displayed, **XM-1**, **XM-2** or **XM-3**.

### 3 To perform tuning, push MULTI-CONTROL left or right.

The channels move up or down step by step. Channels that cannot currently be selected are skipped, and the next channel is selected.

- If you push and hold **MULTI-CONTROL** left or right, you can increase or decrease channel number continuously.
- You can also perform tuning from a desired channel category. (Refer to *Selecting a channel in the channel category* on page 44.)

## Selecting an XM channel directly

You can select an XM channel directly by entering the desired channel number.

### 1 Press DIRECT on the remote control.

**CHANNEL INPUT** appears in the display.

### 2 Use 0–9 on the remote control to input the desired channel number.

- To cancel the input numbers, press **CLEAR** on the remote control.

### 3 While the input number is displayed, press DIRECT on the remote control.

The entered XM channel is selected.

## XM tuner

### Introduction of advanced XM tuner operation

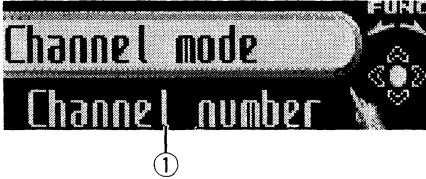

#### ① Function display

Shows the function names.

#### 1 Press **MULTI-CONTROL** to display the main menu.

**FUNCTION**, **AUDIO** and **ENTERTAINMENT** appear on the display.

#### 2 Use **MULTI-CONTROL** to select **FUNCTION**.

**Channel mode** appears on the display.

- To return to the channel display, press **BAND**.



#### Note

If you do not operate the function within about 30 seconds, the display is automatically returned to the channel display.

### Switching the XM display

#### ● Press **DISPLAY** to switch the XM display.

Each press of **DISPLAY** changes the XM display in the following order:

Text information—Category name and text information—Artist name and text information—Song title and text information

### Storing and recalling broadcast stations

You can easily store up to six broadcast stations for later recall.

#### 1 When you find a station that you want to store in memory press **LIST** to switch to the preset channel list mode.

#### 2 Use **MULTI-CONTROL** to store the selected station in memory.

Turn to change the preset number; press and hold to store.

The XM preset number you have selected will flash and then remain lit. The selected station has been stored in memory.

- If you do not operate the list within about 8 seconds, the preset channel list mode is canceled automatically.



#### Notes

- Up to 18 stations, six for each of three XM bands can be stored in memory.
- You can also store stations assigned to preset tuning numbers by pressing and holding one of the preset tuning buttons **1-6** on the remote control.

### Switching the XM channel select setting

You can switch the channel select mode to either selecting with channel number or with category.

#### 1 Use **MULTI-CONTROL** to select **FUNCTION**.

**Channel mode** appears on the display.

## 2 Press MULTI-CONTROL to select the desired channel select setting.

Press **MULTI-CONTROL** repeatedly to switch between the following channel select settings: **Channel number** (channel number select setting)—**Category** (channel category select setting)

- You can also select the XM channel select setting by pressing and holding **CLOCK**.

## Selecting a channel in the channel category

### 1 Select the channel select settings to Category.

Refer to *Switching the XM channel select setting* on the previous page.

### 2 Push MULTI-CONTROL up or down to select the desired channel category.

### 3 Push MULTI-CONTROL left or right to select the desired channel in the selected channel category.

## Displaying the Radio ID

### Channel number select setting

If you select **CH : 000**, the ID code is displayed.

- Push **MULTI-CONTROL** left or right to select **CH : 000**.

### Channel category select setting

**RADIO ID** is provided as a channel category for displaying the ID code.

## ● Push MULTI-CONTROL up or down to select RADIO ID from channel category.

- If you select another channel, display of the ID code is canceled.
- Display of the ID code repeats displaying **RADIO ID** and the ID code one after the other. 

## Selecting stations from the preset channel list

The preset channel list lets you see the list of preset stations and select one of them to receive.

### 1 Press LIST to switch to the preset channel list mode during the channel display.

### 2 Use MULTI-CONTROL to select the desired station.

Turn to change the station; press to select.

- You can also change the station by pushing **MULTI-CONTROL** up or down.
- If you do not operate the list within about 8 seconds, the preset channel list mode is canceled automatically.



### Notes

- You can also recall stations assigned to preset tuning numbers by pushing **MULTI-CONTROL** up or down during the channel display.
- You can also recall stations assigned to preset tuning numbers by pressing one of the preset tuning buttons **1-6** on the remote control. 

## SIRIUS Satellite Radio tuner

### Listening to SIRIUS Satellite Radio

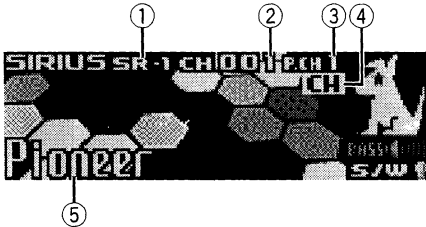

This unit can control a SIRIUS Satellite Radio tuner (sold separately).

When the SIRIUS tuner is used together with this unit, some operations differ slightly from those described in the SIRIUS operation manual. This manual provides information on these points. For all other information on using the SIRIUS tuner, please refer to the SIRIUS operation manual.

- With this unit, you can operate one additional function: SIRIUS channel direct selection. Refer to *Selecting a SIRIUS channel directly* on this page.

- ① SIRIUS band indicator**  
Shows the SIRIUS band which has been selected.
- ② SIRIUS channel number indicator**  
Shows to which SIRIUS channel number the tuner is tuned.
- ③ SIRIUS preset number indicator**  
Shows what SIRIUS preset has been selected.
- ④ SIRIUS channel select setting indicator**  
Shows what channel select setting has been selected. **CH** is displayed when **Channel number** is selected, and **CAT** is displayed when **Category** is selected.

- ⑤ SIRIUS channel name**  
Shows the channel name of broadcast channel.

#### 1 Press **SOURCE** to select SIRIUS.

Press **SOURCE** until you see **SIRIUS** displayed.

#### 2 Press **BAND** to select a SIRIUS band.

Press **BAND** repeatedly until the desired SIRIUS band is displayed, **SR-1**, **SR-2** or **SR-3**.

#### 3 To perform tuning, push **MULTI-CONTROL** left or right.

The channels move up or down step by step. Channels that cannot currently be selected are skipped, and the next channel is selected.

- If you push and hold **MULTI-CONTROL** left or right, you can increase or decrease channel number continuously.
- You can also perform tuning from a desired channel category. (Refer to *Selecting a channel in the channel category* on page 47.)



#### Note

It may take a few seconds before you can hear anything while this unit acquires and processes the satellite signal when you change the source to SIRIUS tuner or select a channel. □

### Selecting a SIRIUS channel directly

You can select a SIRIUS channel directly by entering the desired channel number.

#### 1 Press **DIRECT** on the remote control.

**CHANNEL INPUT** appears in the display.

#### 2 Use **0–9** on the remote control to input the desired channel number.

- To cancel the input numbers, press **CLEAR** on the remote control.

#### 3 While the input number is displayed, press **DIRECT** on the remote control.

The entered SIRIUS channel is selected. □

## Introduction of advanced SIRIUS tuner operation

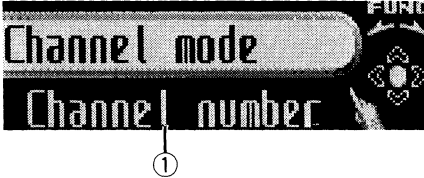

### ① Function display

Shows the function names.

#### 1 Press MULTI-CONTROL to display the main menu.

**FUNCTION**, **AUDIO** and **ENTERTAINMENT** appear on the display.

#### 2 Use MULTI-CONTROL to select **FUNCTION**.

**Channel mode** appears on the display.

- To return to the channel display, press **BAND**.



#### Note

If you do not operate the function within about 30 seconds, the display is automatically returned to the channel display. ▣

## Switching the SIRIUS display

### ● Press **DISPLAY** to switch the SIRIUS display.

Each press of **DISPLAY** changes the SIRIUS display in the following order:

Channel name—Category name—Artist name—Song title/program title—Composer name



## Switching the scroll setting

You can select the scroll setting, one is the continuous scroll, the other is one-time scroll.

### ● Press and hold **DISPLAY** to select the scroll setting.

Press and hold **DISPLAY** selects scroll setting in the following order:

Continuous scroll setting—One-time scroll setting ▣

## Storing and recalling broadcast stations

If you press any of the preset tuning buttons **1–6** you can easily store up to six broadcast stations for later recall with the touch of a button.

- Only the remote control can operate this function.

### ● When you find a station that you want to store in memory press one of preset tuning buttons **1–6** and hold until the SIRIUS preset number stops flashing.

The number you have pressed will flash in the SIRIUS preset number indicator and then remain lit. The selected station has been stored in memory.

The next time you press the same preset tuning button the station is recalled from memory.



#### Notes

- Up to 18 stations, six for each of three SIRIUS bands can be stored in memory.
- You can also recall stations assigned to preset tuning buttons **1–6** by pushing **MULTI-CONTROL** up or down. ▣

## Selecting the SIRIUS channel select setting

You can switch the channel select mode to either selecting with channel number or with category.

## SIRIUS Satellite Radio tuner

### 1 Use MULTI-CONTROL to select FUNCTION.

**Channel mode** appears on the display.

### 2 Press MULTI-CONTROL to select the desired channel select setting.

Press **MULTI-CONTROL** repeatedly to switch between the following channel select settings: **Channel number** (channel number select setting)—**Category** (channel category select setting)

- You can also select the SIRIUS channel select setting by pressing and holding **CLOCK**.

## Selecting a channel in the channel category

### 1 Select the channel select settings to Category.

Refer to *Selecting a channel in the channel category* on this page.

### 2 Push MULTI-CONTROL up or down to select the desired channel category.

### 3 Push MULTI-CONTROL left or right to select the desired channel in the selected channel category.

## Displaying the Radio ID

If you select **CH : 000**, the ID code is displayed.

- Push **MULTI-CONTROL** left or right to select **CH : 000**.



### Note

To select **CH : 000**, set the channel select setting to **Channel number**. About the channel select setting, refer to *Selecting the SIRIUS channel select setting* on the previous page 

## Watching the television

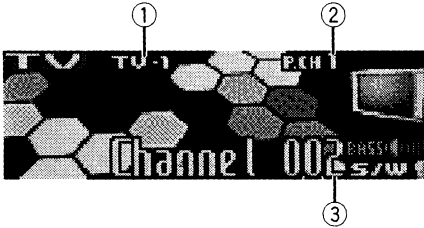

You can use this unit to control a TV tuner, which is sold separately.

For details concerning operation, refer to the TV tuner's operation manual. This section provides information on TV operations with this unit which differs from that described in the TV tuner's operation manual.

### ① Band indicator

Shows which band the TV tuner is tuned to.

### ② Preset number indicator

Shows which preset has been selected.

### ③ Channel indicator

Shows which channel the TV tuner is tuned to.

### 1 Press SOURCE to select the TV.

Press **SOURCE** until you see **Television** displayed.

### 2 Press BAND to select a band.

Press **BAND** until the desired band is displayed, **TV-1** or **TV-2**.

### 3 To perform manual tuning, push MULTI-CONTROL left or right.

The channels move up or down step by step.

### 4 To perform seek tuning, push and hold MULTI-CONTROL left or right for about one second and release.

The tuner will scan the channels until a broadcast strong enough for good reception is found.

- You can cancel seek tuning by pushing **MULTI-CONTROL** left or right.
- If you push and hold **MULTI-CONTROL** left or right, you can skip broadcasting channels. Seek tuning starts as soon as you release **MULTI-CONTROL**.



## TV tuner

### Introduction of advanced TV tuner operation

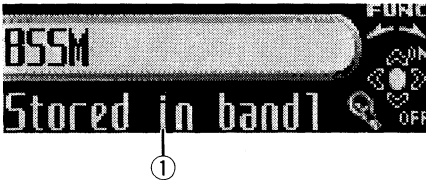

#### ① Function display

Shows the function names.

#### 1 Press MULTI-CONTROL to display the main menu.

**FUNCTION**, **AUDIO** and **ENTERTAINMENT** appear on the display.

#### 2 Use MULTI-CONTROL to select FUNCTION.

**BSSM** appears on the display.

- To return to the channel display, press **BAND**.



#### Note

If you do not operate the function within about 30 seconds, the display is automatically returned to the channel display. 

### Storing and recalling broadcast stations

You can easily store up to 12 broadcast stations for later recall.

#### 1 When you find a station that you want to store in memory press LIST to switch to the preset channel list mode.

#### 2 Use MULTI-CONTROL to store the selected station in memory.

Turn to change the preset number; press and hold to store.

The preset number you have selected will flash and then remain lit. The selected station has been stored in memory.

- If you do not operate the list within about 8 seconds, the preset channel list mode is canceled automatically.



#### Notes

- Up to 24 stations, 12 for each of two TV bands, can be stored in memory.
- You can also store stations assigned to preset tuning numbers **1-6** by pressing and holding one of the preset tuning buttons **1-6** on the remote control. 

### Storing the strongest broadcast stations sequentially

#### 1 Use MULTI-CONTROL and select FUNCTION to display BSSM.

#### 2 Press MULTI-CONTROL to turn BSSM on.

**Searching** is displayed. While **Searching** is displayed, the 12 strongest broadcast stations will be stored in order from the lowest channel up. When finished, the preset channel list appears.

- To cancel the storage process, press **MULTI-CONTROL**.

#### 3 Use MULTI-CONTROL to select the desired station.

Turn to change the station; press to select.

- You can also change the station by pushing **MULTI-CONTROL** up or down.

- If you do not operate the list within about 8 seconds, the preset channel list mode is canceled automatically.

**Note**

Storing broadcast stations with BSSM may replace broadcast stations you have saved using **P01—P12**. 

## Selecting stations from the preset channel list

The preset channel list lets you see the list of preset stations and select one of them to receive.

### 1 Press LIST to switch to the preset channel list mode during the channel display.

### 2 Use MULTI-CONTROL to select the desired station.

Turn to change the station; press to select.

- You can also change the station by pushing **MULTI-CONTROL** up or down.
- If you do not operate the list within about 8 seconds, the preset channel list mode is canceled automatically.

**Notes**

- You can also recall stations assigned to preset tuning numbers by pushing **MULTI-CONTROL** up or down during the channel display.
- You can also recall stations assigned to preset tuning numbers **1–6** by pressing one of the preset tuning buttons **1–6** on the remote control. 

## DVD Player

### Playing a disc

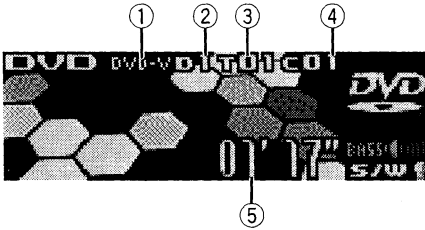

You can use this unit to control a DVD player or multi-DVD player, which is sold separately.

For details concerning operation, refer to the DVD player's or multi-DVD player's operation manual. This section provides information on DVD operations with this unit which differs from that described in the DVD player's or multi-DVD player's operation manual. These are the basic steps necessary to play a DVD video with your DVD player. More advanced DVD video operation is explained starting on the next page.

- ① **DVD-V/CD/CD/MP3/WMA indicator**  
Shows the type of disc currently playing.
- ② **Disc number indicator**  
Shows the disc currently playing when using a multi-DVD player.
- ③ **Title/Folder number indicator**  
Shows the title (when playing DVD video) or folder (when playing MP3 or WMA) of the selection currently playing.
- ④ **Chapter/track number indicator**  
Shows the chapter (when playing DVD video) or track (when playing video CD, CD, MP3 or WMA) currently playing.
- ⑤ **Play time indicator**  
Shows the elapsed playing time of the current track.

**1 Press SOURCE to select the DVD player/ multi-DVD player.**

Press **SOURCE** until you see **DVD** displayed.

**2 To perform fast forward or reverse, push and hold MULTI-CONTROL left or right.**

**3 To skip back or forward to another chapter/track, push MULTI-CONTROL left or right.**

### Selecting a disc

- You can operate this function only when a multi-DVD player is connected to this unit.
- **Push MULTI-CONTROL up or down to select the desired disc.**

### Selecting a folder

- You can operate this function only when a DVD player which is corresponding to MP3/WMA playback is connected to this unit.
- **Push MULTI-CONTROL up or down to select a folder.**

## Introduction of advanced DVD player operation

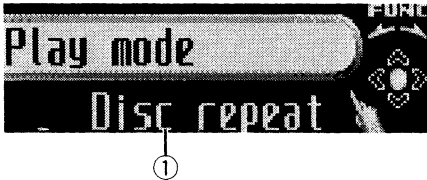

### ① Function display

Shows the function names.

**1 Press MULTI-CONTROL to display the main menu.**

**FUNCTION, AUDIO and ENTERTAINMENT** appear on the display.

**2 Use MULTI-CONTROL to select FUNCTION.**

Turn to change the menu option; press to select.

The function name appears on the display.

**3 Turn MULTI-CONTROL to select the function.**

Turn **MULTI-CONTROL** clockwise to switch between the functions in the following order:

**During DVD video or Video CD playback**

**Play mode** (repeat play)—**Pause** (pause)

**During CD playback**

**Play mode** (repeat play)—**Random mode**

(random play)—**Scan mode** (scan play)

—**Pause** (pause)—**ITS play mode** (ITS play)

—**ITS memo** (ITS input)—**TitleInput "A"** (disc title input)

**During MP3/WMA playback**

**Play mode** (repeat play)—**Random mode**

(random play)—**Scan mode** (scan play)

—**Pause** (pause)

▪ You can also switch between the functions in reverse order by turning **MULTI-CONTROL** counterclockwise.

- To return to the playback display, press **BAND**.

### Note

When using this unit with multi-DVD player, you can switch to **ITS play mode**, **ITS memo** and disc title input. □

## Repeating play

- During PBC playback of Video CDs, this function cannot be operated.

**1 Use MULTI-CONTROL to select Play mode.**

**Play mode** appears in the display.

**2 Press MULTI-CONTROL to select the repeat range.**

**During DVD video playback**

Press **MULTI-CONTROL** repeatedly until the desired repeat range appears in the display.

- **Disc repeat** – Repeat the current disc
- **Chapter repeat** – Repeat just the current chapter
- **Title repeat** – Repeat just the current title

**During Video CD or CD playback**

Press **MULTI-CONTROL** repeatedly until the desired repeat range appears in the display.

- **Disc repeat** – Repeat the current disc
- **Track repeat** – Repeat just the current track

**During MP3/WMA playback**

Press **MULTI-CONTROL** repeatedly until the desired repeat range appears in the display.

- **Disc repeat** – Repeat the current disc
- **Folder repeat** – Repeat the current folder
- **Track repeat** – Repeat just the current track

### Notes

- If you select other discs during repeat play, the repeat play range changes to **Disc repeat**.

## DVD Player

- During video CD or CD playback, if you perform track search or fast forward/reverse during **Track repeat**, the repeat play range changes to **Disc repeat**.
- During MP3/WMA playback, if you select another folder during repeat play, the repeat play range changes to **Disc repeat**.
- During MP3/WMA playback, if you perform track search or fast forward/reverse during **Track repeat**, the repeat play range changes to **Folder repeat**.

### Pausing disc playback

**1 Use MULTI-CONTROL to select Pause.**  
**Pause** appears in the display.

**2 Press MULTI-CONTROL to turn pause on.**

Playback of the current track pauses.

- To turn pause off, press **MULTI-CONTROL** again.

### Playing tracks in random order

- You can operate this function during CD/MP3/WMA playback.

**1 Use MULTI-CONTROL to select Random mode.**

**Random mode** appears in the display.

**2 Press MULTI-CONTROL to turn random play on.**

Tracks will play in a random order.

- To turn random play off, press **MULTI-CONTROL** again.

### Scanning tracks of a CD/MP3/WMA

- You can operate this function during CD/MP3/WMA playback.

**1 Use MULTI-CONTROL to select Scan mode.**

**Scan mode** appears in the display.

**2 Press MULTI-CONTROL to turn scan play on.**

The first 10 seconds of each track is played.

**3 When you find the desired track press MULTI-CONTROL to turn scan play off.**

The track will continue to play.

- If the display has automatically returned to the playback display, select **Scan mode** again by using **MULTI-CONTROL**.

### Using ITS playlist and disc title functions

- You can operate these functions only when a multi-DVD player is connected to this unit.
- This function differs slightly from ITS playback with a multi-CD player. With multi-DVD player, ITS playback applies only to the CD playing. For details, refer to *Using ITS playlists* on page 33.

### Using disc title functions

You can input CD titles and display the titles. Then you can easily search for and play a desired disc.

- You can operate this function during CD playback.

### Entering disc titles

Disc title input lets you input CD titles up to 10 letters long into the DVD player. For details concerning operation, refer to *Entering disc titles* on page 34.

- You can operate this function only when a DVD player is connected to this unit.
- When playing a CD TEXT disc on a CD TEXT compatible DVD player, you cannot switch to disc title input. The disc title will have already been recorded on a CD TEXT disc. 

## Audio Adjustments

### Introduction of audio adjustments

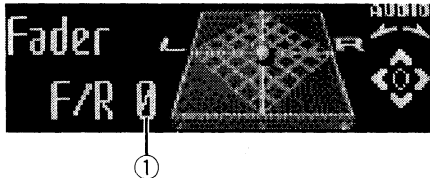

#### ① Audio display

Shows the audio adjustment status.

#### 1 Press MULTI-CONTROL to display the main menu.

**FUNCTION**, **AUDIO** and **ENTERTAINMENT** appear on the display.

#### 2 Use MULTI-CONTROL to select AUDIO.

Turn to change the menu option; press to select.

The audio function name appears on the display.

#### 3 Turn MULTI-CONTROL to select the audio function.

Turn **MULTI-CONTROL** clockwise to switch between the audio functions in the following order:

**Fader** (balance adjustment)—**Powerful** (graphic equalizer adjustment)—**50Hz** (7-band graphic equalizer adjustment)—**LOUD** (loudness)—**Sub W.1** (subwoofer on/off setting)—**Sub W.2** (subwoofer setting)—**Bass** (bass boost)—**HPF** (high pass filter)—**SLA** (source level adjustment)

- You can also switch between the audio functions in reverse order by turning **MULTI-CONTROL** counterclockwise.

- You can select the **Sub W.2** only when subwoofer output is turned on in **Sub W.1**.

- When selecting the FM tuner as the source, you cannot switch to **SLA**.

- To return to the display of each source, press **BAND**.

#### Note

If you do not operate the audio function within about 30 seconds, the display is automatically returned to the source display.

### Using balance adjustment

You can select a fader/balance setting that provides an ideal listening environment in all occupied seats.

#### 1 Use MULTI-CONTROL to select Fader.

**Fader** appears in the display.

- If the balance setting has been previously adjusted, **Balance** will be displayed.

#### 2 Push MULTI-CONTROL up or down to adjust front/rear speaker balance.

Each time **MULTI-CONTROL** is pushed up or down, the front/rear speaker balance moves towards the front or rear.

**F 15 – R 15** is displayed as the front/rear speaker balance moves from front to rear.

- F/R 0** is the proper setting when only two speakers are used.

- When the rear output setting is **Rear SP:S/W**, you cannot adjust front/rear speaker balance. Refer to *Setting the rear output and subwoofer controller* on page 62.

#### 3 Push MULTI-CONTROL left or right to adjust left/right speaker balance.

Each time **MULTI-CONTROL** is pushed left or right, the left/right speaker balance moves towards the left or right.

**L 15 – R 15** is displayed as the left/right speaker balance moves from left to right.

## Using the equalizer

The equalizer lets you adjust the equalization to match car interior acoustic characteristics as desired.

## Recalling equalizer curves

There are seven stored equalizer curves which you can easily recall at any time. Here is a list of the equalizer curves:

Display	Equalizer curve
<b>Powerful</b>	Powerful
<b>Natural</b>	Natural
<b>Vocal</b>	Vocal
<b>Custom1</b>	Custom 1
<b>Custom2</b>	Custom 2
<b>Flat</b>	Flat
<b>Super Bass</b>	Super bass

- **Custom1** and **Custom2** are adjusted equalizer curves that you create. Adjustments can be made with a 7-band graphic equalizer.
- When **Flat** is selected no supplement or correction is made to the sound. This is useful to check the effect of the equalizer curves by switching alternatively between **Flat** and a set equalizer curve.

### ● Press EQ to select the equalizer.

Press **EQ** repeatedly to switch between the following equalizers:

**Powerful—Natural—Vocal—Custom1—Custom2—Flat—Super Bass**

## Adjusting equalizer curves

The factory supplied equalizer curves, with the exception of **Flat**, can be adjusted to a fine degree (nuance control).

### 1 Use MULTI-CONTROL to select the graphic equalizer adjustment.

**Powerful** appears in the display.

If the equalizer curve has been previously selected, the curve of that previously selected will be displayed instead of **Powerful**.

### 2 Push MULTI-CONTROL left or right to select an equalizer curve.

Each pushing **MULTI-CONTROL** left or right selects equalizer curves in the following order: **Powerful—Natural—Vocal—Custom1—Custom2—Flat—Super Bass**

### 3 Push MULTI-CONTROL up or down to adjust the equalizer curve.

Each pushing **MULTI-CONTROL** up or down increases or decreases the equalizer curve respectively.

**+6 – –5** (or **–6**) is displayed as the equalizer curve is increased or decreased.

- The actual range of the adjustments are different depending on which equalizer curve is selected.
- The equalizer curve with all frequencies set to **0** cannot be adjusted.

## Adjusting 7-band graphic equalizer

For **Custom1** and **Custom2** equalizer curves, you can adjust the level of each band.

- A separate **Custom1** curve can be created for each source. (The built-in CD player and the multi-CD player are set to the same equalizer adjustment setting automatically.) If you make adjustments when a curve other than **Custom2** is selected, the equalizer curve settings will be memorized in **Custom1**.
- A **Custom2** curve can be created common to all sources. If you make adjustments when the **Custom2** curve is selected, the **Custom2** curve will be updated.



## Audio Adjustments

### 1 Recall the equalizer curve you want to adjust.

See *Recalling equalizer curves* on the previous page.

### 2 Use MULTI-CONTROL to select 7-band graphic equalizer adjustment.

Frequency and the level (e.g., **50Hz +4**) appears in the display.

### 3 Push MULTI-CONTROL left or right to select the equalizer band to adjust.

Each pushing **MULTI-CONTROL** left or right selects equalizer bands in the following order: **50—125—315—800—2k—5k—12.5k** (Hz)

### 4 Push MULTI-CONTROL up or down to adjust the level of the equalizer band.

Each pushing **MULTI-CONTROL** up or down increases or decreases the level of the equalization band.

**+6—-6** is displayed as the level is increased or decreased.

- You can then select another band and adjust the level.

### 5 Press BAND to cancel the 7-band graphic equalizer adjustment.

## Adjusting loudness

Loudness compensates for deficiencies in the low- and high-sound ranges at low volume.

### 1 Use MULTI-CONTROL to select LOUD. LOUD appears in the display.

### 2 Press MULTI-CONTROL to turn loudness on.

Loudness level (e.g., **Mid**) appears in the display.

- To turn loudness off, press **MULTI-CONTROL** again.

### 3 Push MULTI-CONTROL left or right to select a desired level.

Each time **MULTI-CONTROL** is pushed left or right, level is selected in the following order:

**Low** (low)—**Mid** (mid)—**High** (high)

## Using subwoofer output

This unit is equipped with a subwoofer output which can be turned on or off.

### 1 Use MULTI-CONTROL to select Sub W.1. Sub W.1 appears in the display.

- You can also select the subwoofer setting menu by pressing **SW** on the unit.

### 2 Press MULTI-CONTROL to turn subwoofer output on.

**Normal** appears in the display. Subwoofer output is now on.

- To turn subwoofer output off, press **MULTI-CONTROL** again.

### 3 Push MULTI-CONTROL left or right to select the phase of subwoofer output.

Push **MULTI-CONTROL** left to select reverse phase and **Reverse** appears in the display.

Push **MULTI-CONTROL** right to select normal phase and **Normal** appears in the display.

## Adjusting subwoofer settings

When the subwoofer output is on, you can adjust the cut-off frequency and the output level of the subwoofer.

### 1 Use MULTI-CONTROL to select Sub W.2. Sub W.2 appears in the display.

- You can also select the subwoofer setting menu by pressing **SW** on the unit.
- When the subwoofer output is on, you can select **Sub W.2**.

## Audio Adjustments

### 2 Push MULTI-CONTROL left or right to select cut-off frequency.

Each time **MULTI-CONTROL** is pushed left or right, cut-off frequencies are selected in the following order:

**50Hz—63Hz—80Hz—100Hz—125Hz**

Only frequencies lower than those in the selected range are outputted from the subwoofer.

### 3 Push MULTI-CONTROL up or down to adjust the output level of the subwoofer.

Each time **MULTI-CONTROL** is pushed up or down, subwoofer level increases or decreases. **+6 – -24** is displayed as the level is increased or decreased. 

## Boosting the bass

Bass boost function boosts the bass level of sound lower than 100 Hz. The more the bass level is increased, the more the bass sound is emphasized and the entire sound becomes powerful. When using this function with the subwoofer, the sound under the cut-off frequency is boosted.

#### 1 Use MULTI-CONTROL to select Bass.

**Bass** appears in the display.

- You can also select the bass boost setting by pressing and holding **SW**.

#### 2 Push MULTI-CONTROL up or down to select a desired level.

**0 – 6** is displayed as the level is increased or decreased. 

## Using the high pass filter

When you do not want low sounds from the subwoofer output frequency range to play

from the front or rear speakers, turn on the HPF (high pass filter). Only frequencies higher than those in the selected range are outputted from the front or rear speakers.

#### 1 Use MULTI-CONTROL to select HPF.

**HPF** appears in the display.

#### 2 Press MULTI-CONTROL to turn high pass filter on.

**80Hz** appears in the display. High pass filter is now on.

- If the high pass filter has been previously adjusted, the frequency of that previously selected will be displayed instead of **80Hz**.
- To turn high pass filter off, press **MULTI-CONTROL** again.

#### 3 Push MULTI-CONTROL left or right to select cut-off frequency.

Each time **MULTI-CONTROL** is pushed left or right, cut-off frequencies are selected in the following order:

**50Hz—63Hz—80Hz—100Hz—125Hz**

Only frequencies higher than those in the selected range are outputted from the front or rear speakers. 

## Adjusting source levels

SLA (source level adjustment) lets you adjust the volume level of each source to prevent radical changes in volume when switching between sources.

- Settings are based on the FM tuner volume level, which remains unchanged.

#### 1 Compare the FM tuner volume level with the level of the source you wish to adjust.

#### 2 Use MULTI-CONTROL to select SLA.

**SLA** appears in the display.

## Audio Adjustments

### 3 Push MULTI-CONTROL up or down to adjust the source volume.

Each time **MULTI-CONTROL** is pushed up or down, source volume increases or decreases. **SLA +4 – SLA -4** is displayed as the source volume is increased or decreased.



#### Notes

- The AM tuner volume level can also be adjusted with source level adjustments.
- The built-in CD player and the multi-CD player are set to the same source level adjustment volume automatically.
- XM tuner and SIRIUS tuner are set to the same source level adjustment volume automatically.
- External unit 1 and external unit 2 are set to the same source level adjustment volume automatically. 

## Adjusting initial settings

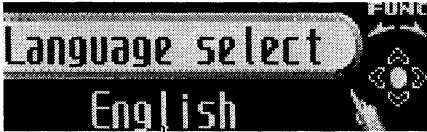

Using the initial settings, you can customize various system settings to achieve optimal performance from this unit.

### ① Function display

Shows the function status.

**1 Press SOURCE and hold until the unit turns off.**

**2 Press MULTI-CONTROL and hold until Language select appears in the display.**

**3 Turn MULTI-CONTROL to select one of the initial settings.**

Turn **MULTI-CONTROL** clockwise to switch between the functions in the following order:

**Language select** (language selection)—**Clock** (clock)—**Warning tone** (warning tone)—**Face auto open** (face auto open)—**AUX1** (auxiliary input 1)—**AUX2** (auxiliary input 2)—**Dimmer** (dimmer)—**Brightness** (brightness)—**Sub/W control** (rear output and sub-walker controller)—**Mute** (sound muting/attenuation)—**Demonstration** (feature demo)—**Reverse mode** (reverse mode)—**Ever-scroll** (ever scroll)

Use the following instructions to operate each particular setting.

- You can also switch between the functions in reverse order by turning **MULTI-CONTROL** counterclockwise.
- To cancel initial settings, press **BAND**. 

## Selecting the display language

For your convenience, this unit equips multiple language display. You can select the language best suited to your first language.

**1 Use MULTI-CONTROL to select Language select.**

**Language select** appears in the display.

**2 Press MULTI-CONTROL to select the language.**

Each press of **MULTI-CONTROL** selects languages in the following order:

**English—Français—Español** 

## Setting the clock

Use these instructions to set the clock.

**1 Use MULTI-CONTROL to select Clock.**

**Clock** appears in the display.

**2 Push MULTI-CONTROL left or right to select the segment of the clock display you wish to set.**

Pushing **MULTI-CONTROL** left or right will select one segment of the clock display:

Hour—Minute

As you select segments of the clock display the segment selected will blink.



## Initial Settings

### 3 Push MULTI-CONTROL up or down to set the clock.

Pushing **MULTI-CONTROL** up will increase the selected hour or minute. Pushing **MULTI-CONTROL** down will decrease the selected hour or minute.



#### Notes

- You can match the clock to a time signal by pressing **MULTI-CONTROL**.
  - If the minute is **00—29**, the minutes are rounded down. (e.g., **10:18** becomes **10:00**.)
  - If the minute is **30—59**, the minutes are rounded up. (e.g., **10:36** becomes **11:00**.)
- Even when the sources are off, the clock display appears on the display. Pressing **CLOCK** when the sources and feature demo are off, turns the clock display on or off.

## Switching the warning tone

If the front panel is not detached from the head unit within four seconds of turning off the ignition, a warning tone will sound. You can turn off the warning tone.

### 1 Use MULTI-CONTROL to select Warning tone.

**Warning tone** appears in the display.

### 2 Press MULTI-CONTROL to turn warning tone on.

**ON** appears in the display.

- To turn warning tone off, press **MULTI-CONTROL** again.

## Switching the face auto open

For theft protection, the front panel opens automatically and easily detaches. Face auto open is on as a default.

### 1 Use MULTI-CONTROL to select Face auto open.

**Face auto open** appears in the display.

### 2 Press MULTI-CONTROL to turn the face auto open on.

**ON** appears in the display.

- To turn the face auto open off, press **MULTI-CONTROL** again.

## Switching the auxiliary setting

Auxiliary equipments connected to this unit can be activated individually. Set each AUX source to ON when using. About connecting or using auxiliary equipments, refer to *Using the AUX source* on page 64.

### 1 Use MULTI-CONTROL to select AUX1/AUX2.

**AUX1/AUX2** appears in the display.

### 2 Press MULTI-CONTROL to turn AUX1/AUX2 on.

**ON** appears in the display.

- To turn AUX off, press **MULTI-CONTROL** again.

## Switching the dimmer setting

To prevent the display from being too bright at night, the display is automatically dimmed when the car's headlights are turned on. You can turn the dimmer on or off.

## Initial Settings

**1 Use MULTI-CONTROL to select Dimmer.**  
Dimmer appears in the display.

**2 Press MULTI-CONTROL to turn dimmer on.**

ON appears in the display.

▪ To turn dimmer off, press **MULTI-CONTROL** again. 

## Adjusting the brightness

You can adjust the display brightness. Initially this mode is set to 12.

**1 Use MULTI-CONTROL to select Brightness.**  
Brightness appears in the display.

**2 Push MULTI-CONTROL left or right to adjust the brightness level.**

Each time **MULTI-CONTROL** is pushed left or right, brightness level increases or decreases. **0 – 15** is displayed as the level is increased or decreased.

▪ When dimmer is set to ON, the brightness level can be adjusted **0 – 10**. 

## Setting the rear output and subwoofer controller

This unit's rear output (rear speaker leads output and RCA rear output) can be used for full-range speaker (**Rear SP:F.Range**) or subwoofer (**Rear SP:S/W**) connection. If you switch the rear output setting to **Rear SP:S/W**, you can connect a rear speaker lead directly to a subwoofer without using an auxiliary amp. Initially, the unit is set for rear full-range speaker connection (**Rear SP:F.Range**).

**1 Use MULTI-CONTROL to select Sub/W control.**  
Sub/W control appears in the display.

**2 Press MULTI-CONTROL to switch the rear output setting.**

Pressing **MULTI-CONTROL** will switch between **Rear SP:F.Range** (full-range speaker) and **Rear SP:S/W** (subwoofer) and that status will be displayed.

▪ When no subwoofer is connected to the rear output, select **Rear SP:F.Range**.

▪ When a subwoofer is connected to the rear output, set for subwoofer **Rear SP:S/W**.



### Notes

- Even if you change this setting, there is no output unless you turn the subwoofer output on (refer to *Using subwoofer output* on page 57).
- If you change this setting, subwoofer output in the audio menu return to the factory settings.
- Both rear speaker leads outputs and RCA rear output are switched simultaneously in this setting. 

## Switching the sound muting/attenuation

Sound from this system is muted or attenuated automatically when the signal from the equipment with mute function is received.

- The sound is muted or attenuated. **MUTE** or **ATT** are displayed and no audio adjustment is possible.
- Sound from this system returns to normal when the muting or attenuation is canceled.

**1 Use MULTI-CONTROL to select Mute.**  
Mute appears in the display.

## Initial Settings

### 2 Press **MULTI-CONTROL** to switch the telephone muting/attenuation.

Pressing **MULTI-CONTROL** will switch between **TEL ATT** (attenuation) and **TEL mute** (muting) and that status will be displayed. 

## Switching the feature demo

The feature demo automatically starts when power to this unit is turned off while the ignition switch is set to ACC or ON.

### 1 Use **MULTI-CONTROL** to select **Demonstration**.

**Demonstration** appears in the display.

### 2 Press **MULTI-CONTROL** to turn the feature demo on.

**ON** appears in the display.

- To turn the feature demo off, press **MULTI-CONTROL** again.



#### Notes

- Remember that if the feature demo continues operating when the car engine is turned off, it may drain battery power.
- You can also turn on or off feature demo by pressing **DISPLAY** while this unit is turned off. For more details, see *Feature demo mode* on page 9. 

## Switching the reverse mode

If you do not perform an operation within about 30 seconds, screen indications start to reverse, and then continue reversing every 10 seconds.

### 1 Use **MULTI-CONTROL** to select **Reverse mode**.

**Reverse mode** appears in the display.

### 2 Press **MULTI-CONTROL** to turn the reverse mode on.

**ON** appears in the display.

- To turn the reverse mode off, press **MULTI-CONTROL** again.



#### Note

You can also turn on or off reverse mode by pressing **BAND** while this unit is turned off. For more details, see *Reverse mode* on page 9. 

## Switching the Ever Scroll

When Ever Scroll is set to ON, text information recorded on CD or iPod scrolls continuously in the display. Set to OFF if you prefer the information to scroll just once.

### 1 Use **MULTI-CONTROL** to select **Ever-scroll**.

**Ever-scroll** appears in the display.

### 2 Press **MULTI-CONTROL** to turn the Ever Scroll on.

**ON** appears in the display.

- To turn the Ever Scroll off, press **MULTI-CONTROL** again. 

## Turning the clock display on or off

You can turn the clock display on or off.

- Press **CLOCK** to turn the clock display on or off.

Each press of **CLOCK** turns the clock display on or off.



### Note

Even when the sources are off, the clock display appears on the display. Pressing **CLOCK** when the sources and feature demo are off, turns the clock display on or off. 

## Using the AUX source

This unit can control up to two auxiliary equipments such as VCR or portable devices (sold separately). When connected, auxiliary equipments are automatically read in as AUX sources and assigned to **AUX1** or **AUX2**. The relationship between **AUX1** and **AUX2** sources is explained below.

### About AUX1 and AUX2

You have two methods to connect auxiliary equipments to this unit.

#### AUX1 source:

*When connecting auxiliary equipment using a 2.5 mm stereo plug cable*

- 1 Press and hold **EJECT** to open the front panel.

AUX1 input jack appears.

- 2 Insert the 2.5 mm stereo plug into the **AUX1** input jack on this unit.

The allocation of this auxiliary equipment is automatically set to **AUX1**.

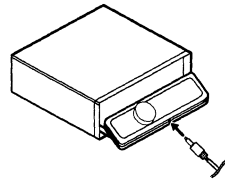

#### AUX2 source:

*When connecting auxiliary equipment using an IP-BUS-RCA Interconnector (sold separately)*

- Use an **IP-BUS-RCA Interconnector** such as the **CD-RB20/CD-RB10** (sold separately) to connect this unit to auxiliary equipment featuring **RCA output**.

For more details, refer to the IP-BUS-RCA Interconnector owner's manual.

The allocation of this auxiliary equipment is automatically set to **AUX2**.

- You can only make this type of connection if the auxiliary equipment has RCA outputs.

### Selecting AUX as the source

- Press **SOURCE** to select **AUX** as the source.

Press **SOURCE** until **AUX** appears in the display.

- If the auxiliary setting is not turned on, **AUX** cannot be selected. For more details, see *Switching the auxiliary setting* on page 61.

### Setting the AUX title

The title displayed for each **AUX1** or **AUX2** source can be changed.



## Other Functions

**1** After you have selected **AUX** as the source, use **MULTI-CONTROL** and select **FUNCTION** to display TitleInput "A".

**2** Press **DISPLAY** to select the desired character type.

Press **DISPLAY** repeatedly to switch between the following character types:

Alphabet (upper case), numbers and symbols  
—Alphabet (lower case)—European letters, such as those with accents (e.g. **á, â, ã, ç**)—  
Numbers and symbols

**3** Push **MULTI-CONTROL** up or down to select a letter of the alphabet.

Each time **MULTI-CONTROL** is pushed up, letters of the alphabet are displayed in **A B C ... X Y Z** order, numbers and symbols in **1 2 3 ... @ # <** order. Each time **MULTI-CONTROL** is pushed down, letters are displayed in **Z Y X ... C B A** order.

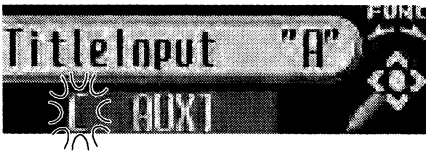

**4** Push **MULTI-CONTROL** right to move the cursor to the next character position.

When the letter you want is displayed, push **MULTI-CONTROL** right to move the cursor to the next position and then select the next letter. Push **MULTI-CONTROL** left to move backwards in the display.

**5** Move the cursor to the last position by pushing **MULTI-CONTROL** right after entering the title.

When you push **MULTI-CONTROL** right one more time, the entered title is stored in memory.

**6** Press **BAND** to return to the playback display. 

## Using different entertainment displays

You can enjoy entertainment displays while listening to each sound source.

**1** Press **MULTI-CONTROL** to display the main menu.

**FUNCTION**, **AUDIO** and **ENTERTAINMENT** appear on the display.

**2** Use **MULTI-CONTROL** to select **ENTERTAINMENT**.

Turn to change the menu option; press to select.

**3** Use **MULTI-CONTROL** to change the display.

Turn to change the menu option; press to select.

- BGV-1** (background visual 1)—**BGV-2** (background visual 2)—**BGP-1** (background picture 1)—**BGP-2** (background picture 2)—**BGP-3** (background picture 3)—**BGP-4** (background picture 4)—**BGP-5** (background picture 5)
- ENT. OFF** (simple display)
- SPECTRUM ANALYZER** (spectrum analyzer)
- LEVEL METER** (level meter)
- LEVEL INDICATOR** (level indicator)
- SOUND PULSE METER** (sound pulse meter)
- BATTERY VOLTAGE** (voltage indicator)
- ENT CLOCK** (entertainment clock)
- MOVIE-1** (movie screen 1)—**MOVIE-2** (movie screen 2)
  - Voltage indicator may differ from the actual voltage level.
  - You can also switch between the displays in reverse order by turning **MULTI-CONTROL** counterclockwise.
  - You can also switch between the display by pressing **ENTERTAINMENT**.
  - To return to the playback display, press **BAND**. 

## Using the PGM button

You can operate the preprogrammed functions for each source by using **PGM** on the remote control.

- **Press PGM to turn pause on when selecting the following sources:**

- **CD** – Built-in CD player
- **Multi-CD** – Multi-CD player
- **iPod** – iPod
- **DVD** – DVD player/multi-DVD player
- To turn pause off, press **PGM** again.

- **Press PGM and hold to turn BSM on when selecting tuner as the source.**

Press **PGM** and hold until the BSM turns on.

- To cancel the storage process, press **PGM** again.

- **Press PGM and hold to turn BSSM on when selecting television as the source.**

Press **PGM** and hold until the BSSM turns on.

- To cancel the storage process, press **PGM** again.

- **Press PGM to select the desired channel select setting when selecting XM or SIRIUS as the source.**

Press **PGM** repeatedly to switch between the following channel select settings:

**Channel number** (channel number select setting)—**Category** (channel category select setting)

## Additional Information

### Understanding built-in CD player error messages

When you contact your dealer or your nearest Pioneer Service Center, be sure to record the error message.

Message	Cause	Action
<b>ERROR-11, 12, 17, 30</b>	Dirty disc	Clean disc.
<b>ERROR-11, 12, 17, 30</b>	Scratched disc	Replace disc.
<b>ERROR-10, 11, 12, 15, 17, 30, A0</b>	Electrical or mechanical	Turn the ignition ON and OFF, or switch to a different source, then back to the CD player.
<b>ERROR-15</b>	The inserted disc does not contain any data	Replace disc.
<b>ERROR-23</b>	The CD format cannot be played back	Replace disc.
<b>No audio</b>	The inserted disc does not contain any files that can be played back	Replace disc.
<b>TRK SKIPPED</b>	The inserted disc contains WMA files that are protected by DRM	Replace disc.
<b>PROTECT</b>	All the files on the inserted disc are secured by DRM	Replace disc.



### CD player and care

- Use only CDs that have either of the two Compact Disc Digital Audio marks as shown below.



- Use only normal, round CDs. If you insert irregular, non-round, shaped CDs they may jam in the CD player or not play properly.

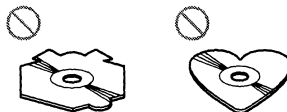

- Check all CDs for cracks, scratches or warping before playing. CDs that have cracks, scratches or are warped may not play properly. Do not use such discs.
- Avoid touching the recorded (non-printed) surface when handling the disc.
- Store discs in their cases when not in use.
- Keep discs out of direct sunlight and do not expose the discs to high temperatures.
- Do not attach labels, write on or apply chemicals to the surface of the discs.
- To clean a CD, wipe the disc with a soft cloth outward from the center.



## Additional Information

- If the heater is used in cold weather, moisture may form on components inside the CD player. Condensation may cause the CD player to malfunction. If you think that condensation is a problem turn off the CD player for an hour or so to allow it to dry out and wipe any damp discs with a soft cloth to remove the moisture.
- Road shocks may interrupt CD playback. 

### CD-R/CD-RW discs

- When CD-R/CD-RW discs are used, playback is possible only for discs which have been finalized.
  - It may not be possible to play back CD-R/CD-RW discs recorded on a music CD recorder or a personal computer because of disc characteristics, scratches or dirt on the disc, or dirt, condensation, etc., on the lens of this unit.
  - Playback of discs recorded on a personal computer may not be possible, depending on the application settings and the environment. Please record with the correct format. (For details, contact the manufacturer of the application.)
  - Playback of CD-R/CD-RW discs may become impossible in case of direct exposure to sunlight, high temperatures, or the storage conditions in the vehicle.
  - Titles and other text information recorded on a CD-R/CD-RW disc may not be displayed by this unit (in the case of audio data (CD-DA)).
  - Read the precautions with CD-R/CD-RW discs before using them. 
- ### MP3, WMA, AAC and WAV files
- MP3 is short for MPEG Audio Layer 3 and refers to an audio compression technology standard.
  - WMA is short for Windows Media™ Audio and refers to an audio compression technology that is developed by Microsoft Corporation. WMA data can be encoded by using Windows Media Player version 7 or later.
  - AAC is short for Advanced Audio Coding and refers to an audio compression technology standard.
  - WAV is short for waveform. It is a standard audio file format for Windows®.
  - This unit may not operate correctly depending on the application used to encode WMA files.
  - Depending on the version of Windows Media Player used to encode WMA files, album names and other text information may not be correctly displayed.
  - There may be a slight delay when starting playback of WMA/AAC files encoded with image data.
  - This unit allows playback of MP3/WMA/AAC/WAV files on CD-ROM, CD-R and CD-RW discs. Disc recordings compatible with level 1 and level 2 of ISO9660 and with the Romeo and Joliet file system can be played back.
  - It is possible to play back multi-session compatible recorded discs.
  - MP3/WMA/AAC/WAV files are not compatible with packet write data transfer.
  - The maximum number of characters which can be displayed for a file name, including the extension (.mp3, .wma, .m4a or .wav), is 64, from the first character.
  - The maximum number of characters which can be displayed for a folder name is 64.
  - In case of files recorded according to the Romeo file system, only the first 64 characters can be displayed.

## Additional Information

- When playing discs with MP3/WMA/AAC/WAV files and audio data (CD-DA) such as CD-EXTRA and MIXED-MODE CDs, both types can be played only by switching mode between MP3/WMA/AAC/WAV and CD-DA.
- The folder selection sequence for playback and other operations becomes the writing sequence used by the writing software. For this reason, the expected sequence at the time of playback may not coincide with the actual playback sequence. However, there also is some writing software which permits setting of the playback order.
- Some audio CDs contain tracks that merge into one another without a pause. When these discs are converted to MP3/WMA/AAC/WAV files and burned to a CD-R/CD-RW/CD-ROM, the files will be played back on this player with a short pause between each one, regardless of the length of the pause between tracks on the original audio CD.

### Important

- When naming an MP3/WMA/AAC/WAV file, add the corresponding filename extension (.mp3, .wma, .m4a or .wav).
- This unit plays back files with the filename extension (.mp3, .wma, m4a or .wav) as an MP3/WMA/AAC/WAV file. To prevent noise and malfunctions, do not use these extensions for files other than MP3/WMA/AAC/WAV files.

### MP3 additional information

- Files are compatible with the ID3 Tag Ver. 1.0, 1.1, 2.2, 2.3 and 2.4 formats for display of album (disc title), track (track title), artist (track artist) and comments. Ver. 2.x of ID3 Tag is given priority when both Ver. 1.x and Ver. 2.x exist.

- The emphasis function is valid only when MP3 files of 32, 44.1 and 48 kHz frequencies are played back. (16, 22.05, 24, 32, 44.1, 48 kHz sampling frequencies can be played back.)
- There is no m3u playlist compatibility.
- There is no compatibility with the MP3i (MP3 interactive) or mp3 PRO formats.
- The sound quality of MP3 files generally becomes better with an increased bit rate. This unit can play recordings with bit rates from 8 kbps to 320 kbps, but in order to be able to enjoy sound of a certain quality, we recommend using only discs recorded with a bit rate of at least 128 kbps.

### WMA additional information

- This unit plays back WMA files encoded by Windows Media Player version 7, 7.1, 8, 9 and 10.
- You can only play back WMA files in the frequencies 32, 44.1 and 48 kHz.
- The sound quality of WMA files generally becomes better with an increased bit rate. This unit can play recordings with bit rates from 48 kbps to 320 kbps (CBR) or from 48 kbps to 384 kbps (VBR), but in order to be able to enjoy sound of a certain quality, we recommend using discs recorded with a higher bit rate.
- This unit doesn't support the following formats.
  - Windows Media Audio 9 Professional (5.1ch)
  - Windows Media Audio 9 Lossless
  - Windows Media Audio 9 Voice

### AAC additional information

- This unit plays back AAC files encoded by iTunes® version 4.8 and earlier.

## Additional Information

- This unit plays back AAC files in the sampling frequencies 11.025, 16, 22.05, 24, 32, 44.1 and 48 kHz.
- The sound quality of AAC files generally becomes better with an increased transmission rate. This unit can play recordings with transmission rates from 16 kbps to 320 kbps, but in order to be able to enjoy sound of a certain quality, we recommend using discs recorded with a higher transmission rate.
- This unit doesn't support the following formats.
  - Apple Lossless

### WAV additional information

- This unit plays back WAV files encoded in Linear PCM (LPCM) format or MS ADPCM format.
- You can only play back WAV files in the frequencies 16, 22.05, 24, 32, 44.1 and 48 kHz (LPCM), or 22.05 and 44.1 kHz (MS ADPCM). The sampling frequency shown in the display may be rounded.
- The sound quality of WAV files generally becomes better with a larger number of quantization bits. This unit can play recordings with 8 and 16 (LPCM) or 4 (MS ADPCM) quantization bits, but in order to be able to enjoy sound of a certain quality, we recommend using discs recorded with the larger number of quantization bits. 

### About folders and MP3/WMA/AAC/WAV files

- An outline of a CD-ROM with MP3/WMA/AAC/WAV files on it is shown below. Sub-folders are shown as folders in the folder currently selected.

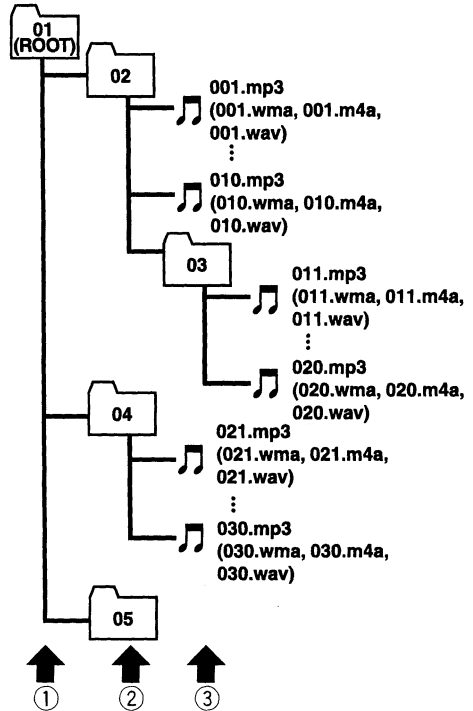

- ① First level
- ② Second level
- ③ Third level

### Notes

- This unit assigns folder numbers. The user cannot assign folder numbers.
- It is not possible to check folders that do not include MP3/WMA/AAC/WAV files. (These folders will be skipped without displaying the folder number.)

## Additional Information

- MP3/WMA/AAC/WAV files in up to 8 tiers of folders can be played back. However, there is a delay in the start of playback on discs with numerous tiers. For this reason we recommend creating discs with no more than 2 tiers.
- It is possible to play back up to 99 folders on one disc.

## Additional Information

### Terms

#### AAC

AAC is short for Advanced Audio Coding and refers to an audio compression technology standard used with MPEG 2 and MPEG 4.

#### Bit rate

This expresses data volume per second, or bps (bits per second) units. The higher the rate, the more information is available to reproduce the sound. Using the same encoding method (such as MP3), the higher the rate, the better the sound.

#### ID3 tag

This is a method of embedding track-related information in an MP3 file. This embedded information can include the track title, the artist's name, the album title, the music genre, the year of production, comments and other data. The contents can be freely edited using software with ID3 Tag editing functions. Although the tags are restricted as to the number of characters, the information can be viewed when the track is played back.

#### ISO9660 format

This is the international standard for the format logic of CD-ROM folders and files. For the ISO9660 format, there are regulations for the following two levels.

##### Level 1:

The file name is in 8.3 format (the name consists of up to 8 characters, half-byte English capital letters and half-byte numerals and the "\_" sign, with a file-extension of three characters).

##### Level 2:

The file name can have up to 31 characters (including the separation mark "." and a file extension). Each folder contains less than 8 hierarchies.

### Extended formats

Joliet:

File names can have up to 64 characters.

Romeo:

File names can have up to 128 characters.

### Linear PCM (LPCM)/Pulse code modulation

This stands for linear pulse code modulation, which is the signal recording system used for music CDs and DVDs.

### m3u

Playlists created using the "WINAMP" software have a playlist file extension (.m3u).

### MP3

MP3 is short for MPEG Audio Layer 3. It is an audio compression standard set by a working group (MPEG) of the ISO (International Standards Organization). MP3 is able to compress audio data to about 1/10th the level of a conventional disc.

### MS ADPCM

This stands for Microsoft adaptive differential pulse code modulation, which is the signal recording system used for the multimedia software of Microsoft Corporation.

### Multi-session

Multi-session is a recording method that allows additional data to be recorded later. When recording data on a CD-ROM, CD-R or CD-RW, etc., all data from beginning to end is treated as a single unit or session. Multi-session is a method of recording more than 2 sessions on one disc.



## Additional Information

### Number of quantization bits

The number of quantization bits is one factor in the overall sound quality; the higher the "bit-depth", the better the sound quality. However, increasing the bit-depth also increases the amount of data and therefore storage space required.

### Packet write

This is a general term for a method of writing on CD-R, etc., at the time required for a file, just as is done with files on floppy or hard discs.

### VBR

VBR is short for variable bit rate. Generally speaking CBR (constant bit rate) is more widely used. But by flexibly adjusting the bit rate according to the needs of audio compression, it is possible to achieve compression-priority sound quality.

### WAV

WAV is short for waveform. It is a standard audio file format for Windows®.

### WMA

WMA is short for Windows Media™ Audio and refers to an audio compression technology that is developed by Microsoft Corporation. WMA data can be encoded by using Windows Media Player version 7 or later. Windows Media and the Windows logo are trademarks or registered trademarks of Microsoft Corporation in the United States and/or other countries. □

# Additional Information

## Specifications

### General

Power source .....	14.4 V DC (10.8 – 15.1 V allowable)
Grounding system .....	Negative type
Max. current consumption .....	10.0 A
Dimensions (W × H × D):	
DIN	
Chassis .....	178 × 50 × 159 mm (7 × 2 × 6-1/4 in.)
Nose .....	188 × 58 × 28 mm (7-3/8 × 2-1/4 × 1-1/8 in.)
D	
Chassis .....	178 × 50 × 164 mm (7 × 2 × 6-1/2 in.)
Nose .....	170 × 46 × 23 mm (6-3/4 × 1-3/4 × 7/8 in.)
Weight .....	1.6 kg (3.5 lbs)

### Audio

Maximum power output .....	50 W × 4 50 W × 2/4 Ω + 70 W × 1/2 Ω (for subwoofer)
Continuous power output .....	22 W × 4 (50 – 15 000 Hz, 5% THD, 4 Ω load, both channels driven)
Load impedance .....	4 – 8 Ω × 4 4 – 8 Ω × 2 + 2 Ω × 1
Preout max output level/output impedance .....	2.2 V/1 kΩ
Equalizer (7-Band Graphic Equalizer):	
Frequency .....	50/125/315/800/2k/5k/12.5k Hz
Gain .....	±12dB
Loudness contour:	
Low .....	+3.5 dB (100 Hz), +3 dB (10 kHz)
Mid .....	+10 dB (100 Hz), +6.5 dB (10 kHz)
High .....	+11 dB (100 Hz), +11 dB (10 kHz) (volume: –30 dB)
HPF:	
Frequency .....	50/63/80/100/125 Hz
Slope .....	–12 dB/oct
Subwoofer (mono):	
Frequency .....	50/63/80/100/125 Hz
Slope .....	–18 dB/oct
Gain .....	+6 – –24 dB
Phase .....	Normal/Reverse

Bass boost:

Gain ..... +12 – 0 dB

### CD player

System .....	Compact disc audio system
Usable discs .....	Compact disc
Signal format:	
Sampling frequency .....	44.1 kHz
Number of quantization bits .....	16; linear
Frequency characteristics .....	5 – 20 000 Hz (±1 dB)
Signal-to-noise ratio .....	94 dB (1 kHz) (IHF-A network)
Dynamic range .....	92 dB (1 kHz)
Number of channels .....	2 (stereo)
MP3 decoding format .....	MPEG-1 & 2 Audio Layer 3
WMA decoding format .....	Ver. 7, 7.1, 8, 9, 10 (2ch audio) (Windows Media Player)
AAC decoding format .....	MPEG-4 AAC (iTunes® encoded only)
WAV signal format .....	Linear PCM & MS ADPCM

### FM tuner

Frequency range .....	87.9 – 107.9 MHz
Usable sensitivity .....	8 dBf (0.7 μV/75 Ω mono, S/N: 30 dB)
50 dB quieting sensitivity .....	10 dBf (0.9 μV/75 Ω mono)
Signal-to-noise ratio .....	75 dB (IHF-A network)
Distortion .....	0.3 % (at 65 dBf, 1 kHz, stereo) 0.1 % (at 65 dBf, 1 kHz, mono)
Frequency response .....	30 – 15 000 Hz (±3 dB)
Stereo separation .....	45 dB (at 65 dBf, 1 kHz)
Selectivity .....	80 dB (±200 kHz)
Three-signal intermodulation (desired signal level) .....	30 dBf (two undesired signal level: 100 dBf)

### AM tuner

Frequency range .....	530 – 1 710 kHz (10 kHz)
Usable sensitivity .....	18 μV (S/N: 20 dB)
Signal-to-noise ratio .....	65 dB (IHF-A network)



### Note

Specifications and the design are subject to possible modifications without notice due to improvements. □

*Register your product at  
Enregistrez votre produit au*

***<http://www.pioneerelectronics.com>***

*See "Product registration" page  
Voir la page "Enregistrement du produit"*

**PIONEER CORPORATION**

4-1, MEGURO 1-CHOME, MEGURO-KU, TOKYO 153-8654, JAPAN

**PIONEER ELECTRONICS (USA) INC.**

P.O. Box 1540, Long Beach, California 90801-1540, U.S.A.  
TEL: (800) 421-1404

**PIONEER EUROPE NV**

Haven 1087, Keetberglaan 1, B-9120 Melsele, Belgium  
TEL: (0) 3/570.05.11

**PIONEER ELECTRONICS ASIACENTRE PTE. LTD.**

253 Alexandra Road, #04-01, Singapore 159936  
TEL: 65-6472-7555

**PIONEER ELECTRONICS AUSTRALIA PTY. LTD.**

178-184 Boundary Road, Braeside, Victoria 3195, Australia  
TEL: (03) 9586-6300

**PIONEER ELECTRONICS OF CANADA, INC.**

300 Allstate Parkway, Markham, Ontario L3R 0P2, Canada  
TEL: 1-877-283-5901

**PIONEER ELECTRONICS DE MEXICO, S.A. de C.V.**

Bvd.Manuel Avila Camacho 138 10 piso  
Col.Lomas de Chapultepec, Mexico, D.F. 11000  
TEL: 55-9178-4270

**先鋒股份有限公司**

總公司：台北市中山北路二段44號13樓  
電話：(02) 2521-3588

**先鋒電子（香港）有限公司**

香港九龍尖沙咀海港城世界商業中心  
9樓901-6室  
電話：(0852) 2848-6488

Published by Pioneer Corporation.  
Copyright © 2005 by Pioneer Corporation.  
All rights reserved.

Publié par Pioneer Corporation. Copyright  
© 2005 par Pioneer Corporation. Tous  
droits réservés.

Printed in Thailand  
Imprimé en Thaïlande

<XRD7111-A/N> UC

<KMMZX> <05H00000>

# **DEH-P6800MP**

This product conforms to CEMA cord colors.  
Le code de couleur des câbles utilisé pour ce produit est conforme à CEMA.

Printed in Thailand  
Imprimé en Thaïlande

<XRD7112-A/N> UC <KMMZX> <05H00000>

# Connecting the Units

## Note:

- This unit is for vehicles with a 12-volt battery and negative grounding. Before installing it in a recreational vehicle, truck, or bus, check the battery voltage.
- To avoid shorts in the electrical system, be sure to disconnect the  $\ominus$  battery cable before beginning installation.
- Refer to the owner's manual for details on connecting the power amp and other units, then make connections correctly.
- Secure the wiring with cable clamps or adhesive tape. To protect the wiring, wrap adhesive tape around them where they lie against metal parts.
- Route and secure all wiring so it cannot touch any moving parts, such as the gear shift, handbrake and seat rails. Do not route wiring in places that get hot, such as near the heater outlet. If the insulation of the wiring melts or gets torn, there is a danger of the wiring short-circuiting to the vehicle body.
- Don't pass the yellow lead through a hole into the engine compartment to connect to the battery. This will damage the lead insulation and cause a very dangerous short.
- Do not shorten any leads. If you do, the protection circuit may fail to work when it should.
- Never feed power to other equipment by cutting the insulation of the power supply lead of the unit and tapping into the lead. The current capacity of the lead will be exceeded, causing overheating.
- When replacing the fuse, be sure to only use a fuse of the rating prescribed on this unit.
- Since a unique BPTL circuit is employed, never wire so the speaker leads are directly grounded or the left and right  $\ominus$  speaker leads are common.
- Speakers connected to this unit must be high-power with minimum rating of 50 W and impedance of 4 to 8 ohms. Connecting speakers with other than those noted here may result in the speakers catching fire, emitting smoke or becoming damaged.
- When this product's source is switched ON, a control signal is output through the blue/white lead. Connect to an external power amp's system remote control or the car's Auto-antenna relay control terminal (max. 300 mA 12 V DC). If the car features a glass antenna, connect to the antenna booster power supply terminal.

- When an external power amp is being used with this system, be sure not to connect the blue/white lead to the amp's power terminal. Likewise, do not connect the blue/white lead to the power terminal of the auto-antenna. Such connection could cause excessive current drain and malfunction.
- To avoid a short-circuit, cover the disconnected lead with insulating tape. Insulate the unused speaker leads without fail. There is a possibility of a short-circuit if the leads are not insulated.
- To prevent incorrect connection, the input side of the IP-BUS connector is blue, and the output side is black. Connect the connectors of the same colors correctly.
- If this unit is installed in a vehicle that does not have an ACC (accessory) position on the ignition switch, the red lead of the unit should be connected to a terminal coupled with ignition switch ON/OFF operations. If this is not done, the vehicle battery may be drained when you are away from the vehicle for several hours. (Fig. 1)

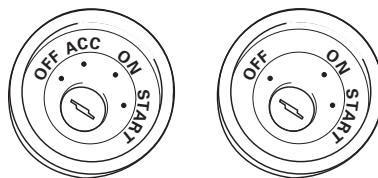

ACC position

No ACC position

Fig. 1

- The black lead is ground. Please ground this lead separately from the ground of high-current products such as power amps. If you ground the products together and the ground becomes detached, there is a risk of damage to the products or fire.
- Cords for this product and those for other products may be different colors even if they have the same function. When connecting this product to another product, refer to the supplied manuals of both products and connect cords that have the same function.

■ When not connecting a rear speaker lead to a Subwoofer

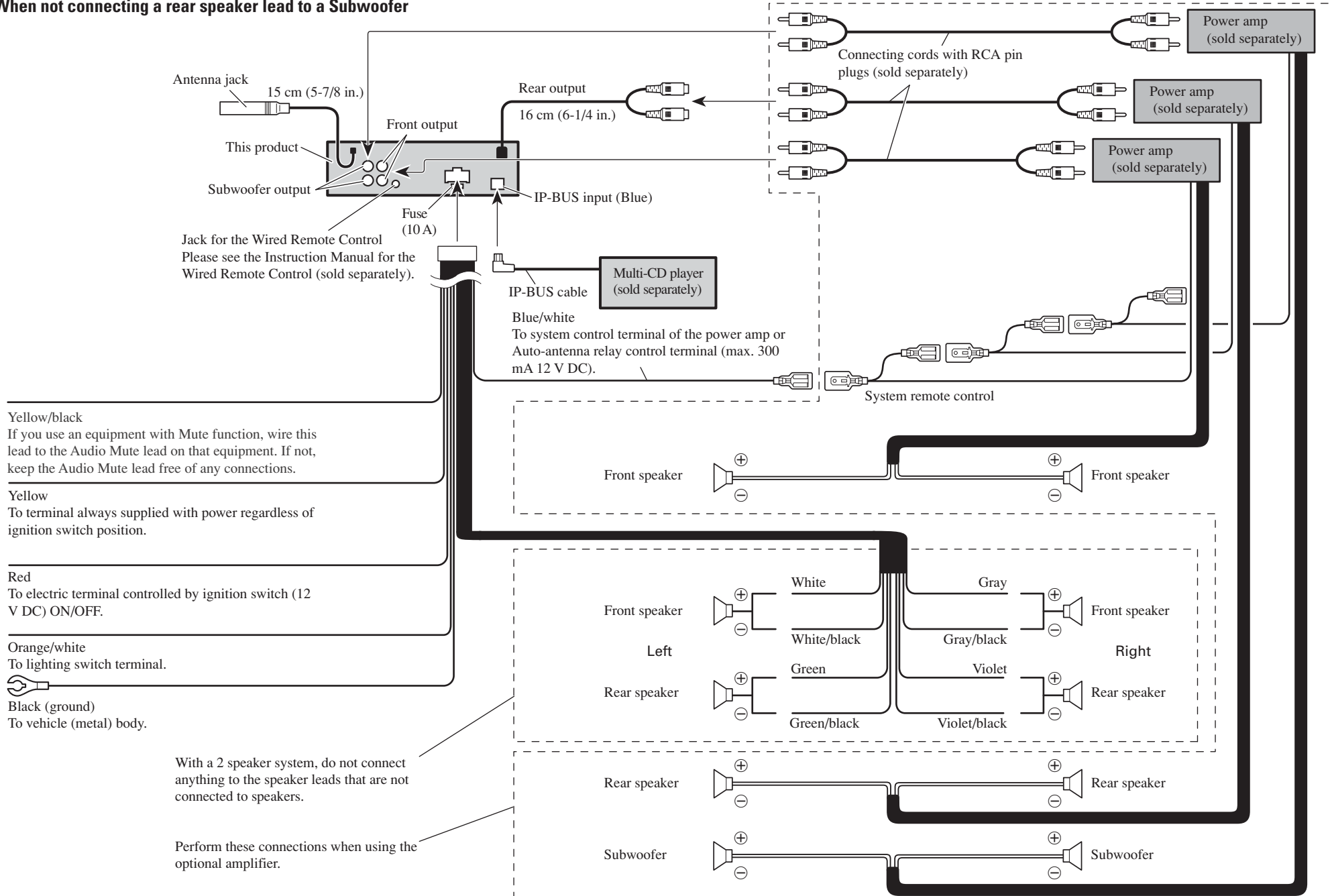
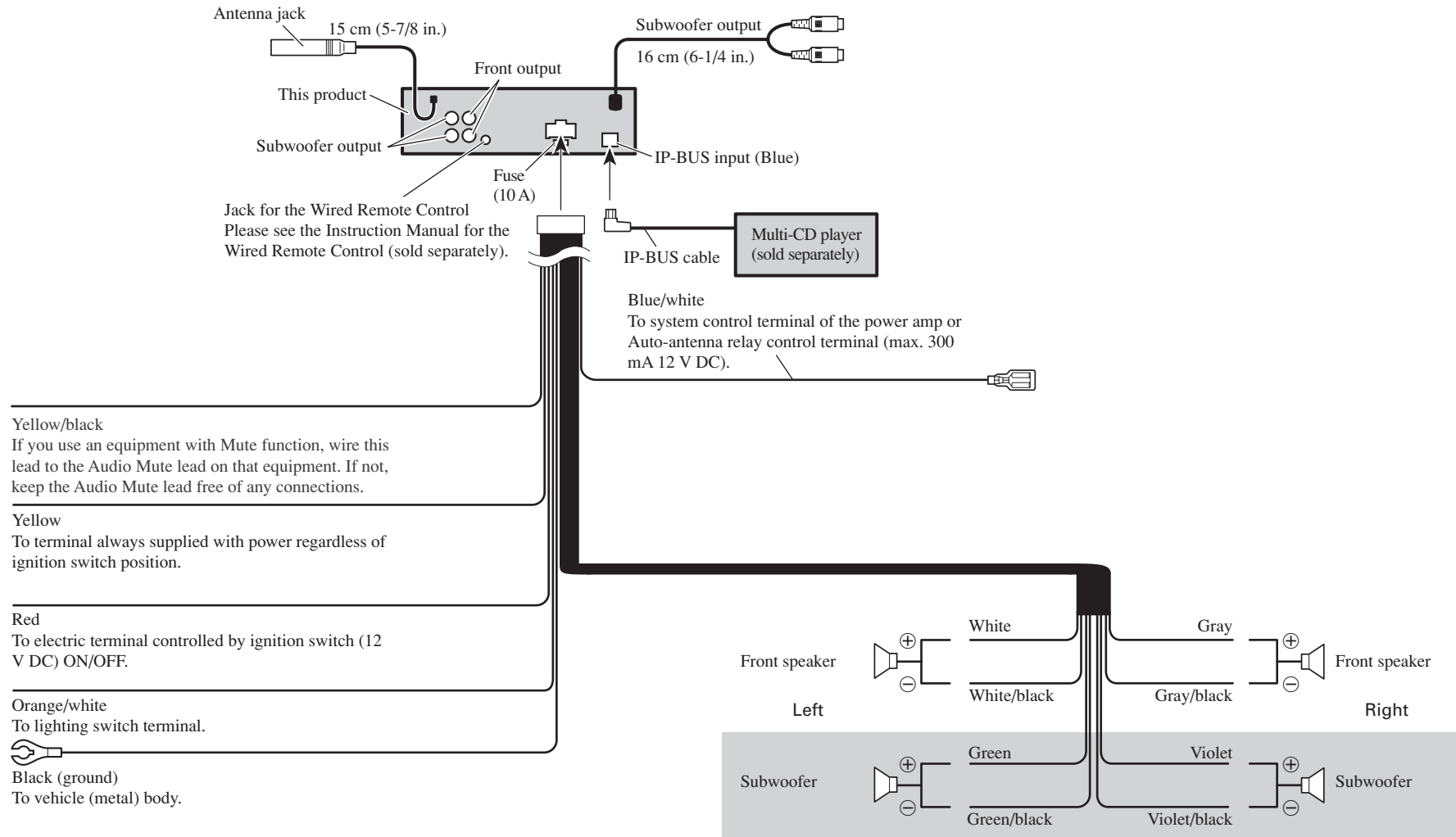

Fig. 2

■ When using a Subwoofer without using the optional amplifier



**Note:**  
Change the initial setting of this unit (refer to the Operation Manual). The subwoofer output of this unit is monaural.

Fig. 3

# Installation

## Note:

- Before making a final installation of the unit, temporarily connect the wiring to confirm that the connections are correct and the system works properly.
  - Use only the parts included with the unit to ensure proper installation. The use of unauthorized parts can cause malfunctions.
  - Consult with your nearest dealer if installation requires the drilling of holes or other modifications of the vehicle.
  - Install the unit where it does not get in the driver's way and cannot injure the passenger if there is a sudden stop, like an emergency stop.
  - The semiconductor laser will be damaged if it overheats, so don't install the unit anywhere hot — for instance, near a heater outlet.
- If installation angle exceeds  $60^\circ$  from horizontal, the unit might not give its optimum performance. (Fig. 4)

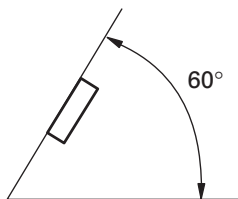

Fig. 4

## DIN Front/Rear-mount

This unit can be properly installed either from “Front” (conventional DIN Front-mount) or “Rear” (DIN Rear-mount installation, utilizing threaded screw holes at the sides of unit chassis). For details, refer to the following illustrated installation methods.

## DIN Front-mount

### Installation with the rubber bush (Fig. 5)

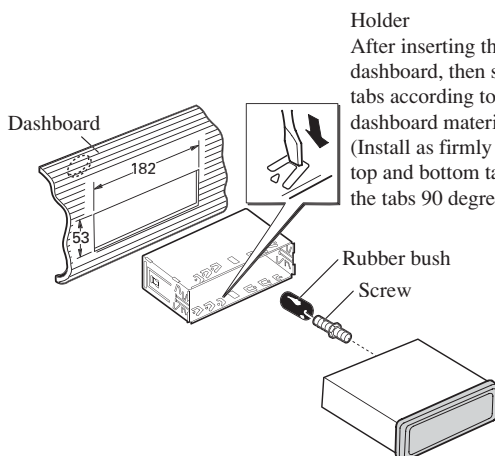

Holder  
After inserting the holder into the dashboard, then select the appropriate tabs according to the thickness of the dashboard material and bend them. (Install as firmly as possible using the top and bottom tabs. To secure, bend the tabs 90 degrees.)

Fig. 5



## Removing the unit (Fig. 6) (Fig. 7)

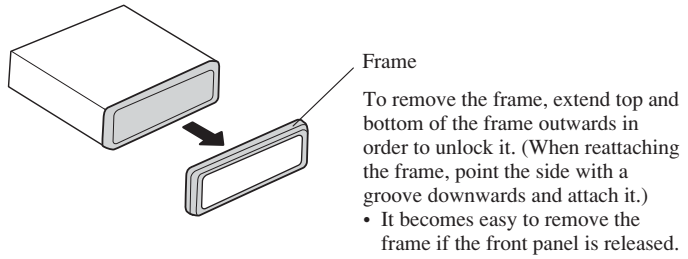

**Fig. 6**

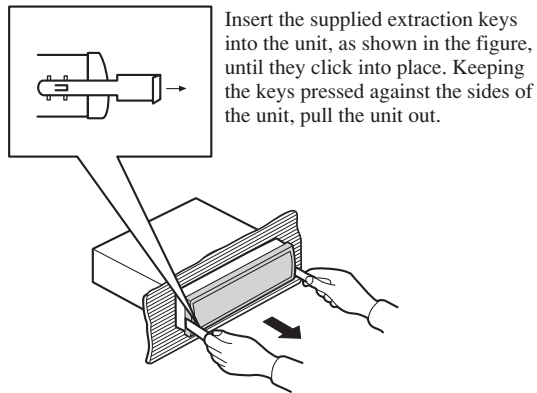

**Fig. 7**

## DIN Rear-mount

### Installation using the screw holes on the side of the unit

#### 1. Remove the frame. (Fig. 8)

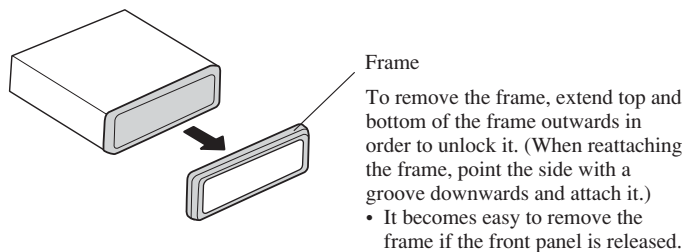

Fig. 8

#### 2. Fastening the unit to the factory radio mounting bracket. (Fig. 9) (Fig. 10)

Select a position where the screw holes of the bracket and the screw holes of the head unit become aligned (are fitted), and tighten the screws at 2 places on each side. Use either truss screws (5 × 8 mm) or flush surface screws (5 × 9 mm), depending on the shape of the screw holes in the bracket.

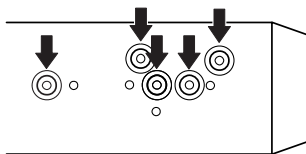

Fig. 9

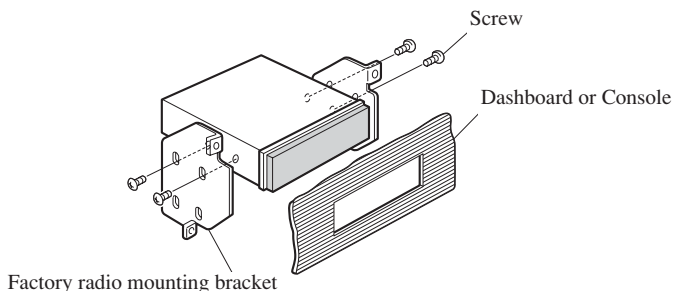

Fig. 10

## Fixing the front panel

If you do not operate the removing and attaching the front panel function, use the supplied fixing screw to fix the front panel to this unit.

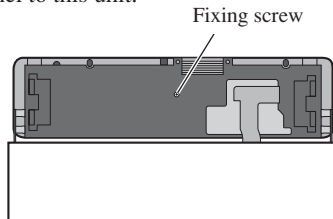

Fig. 11

**Note:**

Before installing this unit in your vehicle, refer to the illustration below and remove the tag.  
Do not use the parts you have removed (screws etc.) when installing the unit in your vehicle.

**Remarque:**

Avant d'installer cet appareil dans votre voiture, reportez-vous à l'illustration ci-dessous et retirez cette cosse.  
N'utilisez pas les pièces que vous avez retirées (vis, etc.) lors de l'installation de l'appareil dans votre voiture.

**Nota:**

Antes de instalar esta unidad en su vehículo, refiérase a la ilustración abajo y quite la pieza.  
No utilice las partes retiradas (tornillos, etc.) al instalar la unidad en su vehículo.

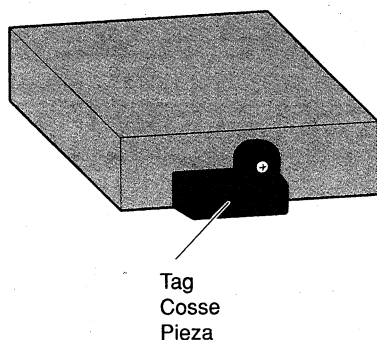

## About the Demo Mode

This product features two demonstration modes. One is the Reverse Demo mode, the other is the Feature Demo mode.

### Reverse Demo

If you do not perform an operation within about 30 seconds, screen indications start to reverse, and then continue reversing every 10 seconds. Pressing button BAND when power to this product is switched OFF while the ignition switch is set to ACC or ON cancels the Reverse Demo mode. Pressing button BAND again to start the Reverse Mode.

### Feature Demo

The Feature Demo automatically starts when power to this product is switched OFF while the ignition switch is set to ACC or ON. Pressing button DISPLAY during Feature Demo operation cancels the Feature Demo mode. Pressing button DISPLAY again to start the Feature Mode. Remember that if the Feature Demo continues operating when the car engine is switched OFF, it may drain battery power.

#### Note:

- The red lead (ACC) of this product should be connected to a terminal coupled with ignition switch ON/OFF operations. If this is not done, the vehicle battery may be drained.

## Quelques mots sur la démonstration

Cet appareil possède deux modes de démonstration: démonstration inverse et démonstration des possibilités.

### Démonstration inverse

Si vous n'effectuez aucune opération pendant environ 30 secondes, les indications s'affichent sur l'écran dans l'ordre inverse et cela à intervalle de 10 secondes. Vous pouvez annuler le mode de démonstration inverse en appuyant sur la touche BAND alors que l'appareil n'est pas sous tension et que le contacteur d'allumage est sur la position ACC, ou ON. Appuyez de nouveau sur la touche BAND pour commencer la démonstration inverse.

### Démonstration des possibilités

La démonstration des possibilités commence aussitôt que l'appareil est mis hors tension alors que le contacteur d'allumage est sur la position ACC, ou ON. Vous pouvez annuler le mode de démonstration des possibilités en appuyant sur la touche DISPLAY tandis que cette démonstration est en cours. Appuyez de nouveau sur la touche DISPLAY pour commencer la démonstration des possibilités. Sachez que si la démonstration des possibilités se poursuit alors que le moteur du véhicule est arrêté, la batterie peut être complètement déchargée.

#### Remarque:

- Le fil rouge (ACC) de cet appareil doit être relié à une borne couplée avec le fonctionnement de l'interrupteur d'allumage. Sinon, la batterie risque de se décharger.

## Acerca del modo de demostración

Este producto presenta dos modos de demostraciones. Uno es el modo de demostración de retroceso, el otro es el modo de demostración de característica.

### Demostración de retroceso

Si no realiza ninguna operación dentro de 30 segundos, las indicaciones de la pantalla comienzan a retroceder, y luego continúan retrocediendo cada 10 segundos. Al presionar el botón BAND cuando se desactiva este producto, mientras el interruptor de encendido se ajusta a ACC y ON cancela el modo de demostración de retroceso. Presione el botón BAND nuevamente para iniciar la demostración de retroceso.

### Demostración de característica

La demostración de característica se inicia cuando la alimentación de este producto se desactiva mientras el interruptor de encendido se ajusta a ACC u ON. La presión del botón DISPLAY durante la operación de demostración de característica cancela el modo de demostración de característica. Presione el botón DISPLAY nuevamente para iniciar la demostración de característica.

Tenga en cuenta que si la demostración de característica continúa funcionando cuando se apaga el motor del coche, la batería puede agotarse.

#### Nota:

- El cable rojo (ACC) de este producto se debe conectar al terminal acoplado con las operaciones de activación/desactivación del encendido. Caso contrario, la batería del vehículo puede drenarse.

## Sobre o modo de demonstração

Este produto vem com dois modos de demonstração. Um é o modo de demonstração inversa e o outro é o modo de demonstração de funções.

### Demonstração inversa

Se você não realizar nenhuma operação dentro de 30 segundos, as indicações no mostrador começam a inverter-se, continuando a inverter-se cada 10 segundos. Pressionar o botão BAND com o produto desligado e com a chave de ignição em ACC ou ON cancela o modo de demonstração inversa. Pressione o botão BAND de novo para iniciar a demonstração inversa.

### Demonstração das funções

A demonstração das funções começa automaticamente quando o produto é desligado com a chave de ignição na posição ACC ou ON. Pressionar o botão DISPLAY durante a demonstração das funções cancela o modo de demonstração das funções. Pressione o botão DISPLAY de novo para iniciar a demonstração das funções. Lembre-se de que se a demonstração das funções continuar funcionando com o motor do automóvel desligado, ela pode esgotar a bateria.

#### Nota:

- O cabo vermelho (ACC) deste produto deve ser conectado ao terminal acoplado com as operações de ligar/desligar da chave de ignição. Caso contrário, a bateria do veículo pode drenar-se.

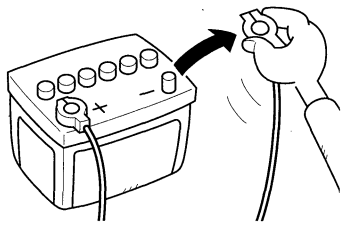

Fig.1

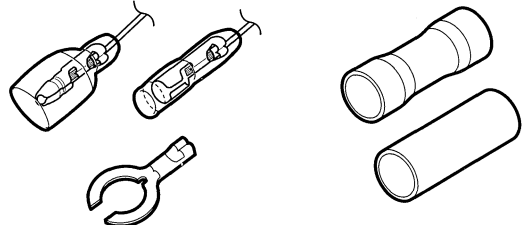

Fig.2

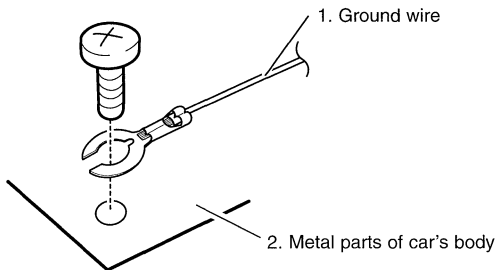

Fig.3

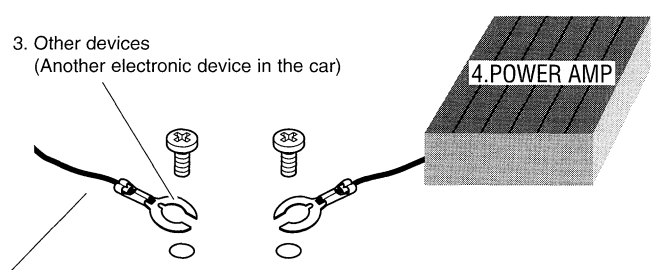

Fig.4

## WARNING

Always follow the instructions below when connecting or installing parts. Not following the instructions below may result in the malfunction of this unit. Additionally, if the parts to this unit malfunction the unit may emit smoke or catch fire.

- Always remove a connector from the  $\ominus$  battery terminal before beginning any connection or installing work. (Fig.1)
- Ensure that the power cord, the ground wire and the speaker are all properly connected. We recommend that you use a plug and a receptacle, solderless contact and a Y connector. (Fig.2)
- When installing this unit, always connect the ground wire first. Ensure that the ground wire is properly connected to metal parts of the car's body. (Fig.3)
  1. Ground wire
  2. Metal parts of car's body
- Connect to this unit only high-powered speakers of over 50W and with impedance between 4 and 8 ohms. Though there are speaker systems with low impedance between 1 and 3 ohms, you must not connect these to this unit.
- When connecting the power amp (sold separately) to this unit ensure that the ground wire for the power amp is properly connected to metal parts of the car's body. Connect the ground wire of the power amp with a different screw from the one you used to connect the ground wire for this unit or any other device. Should the screw for the power amp's ground wire loosen or fall out, it may result in this unit emitting smoke or malfunctioning. (Fig.4)
  3. Other devices (Another electronic device in the car)
  4. POWER AMP
- Cover any terminals not connected with insulation tape so they do not make contact with metal.
- Do not change the speaker connections while this unit is in operation.

If you have any questions regarding the connection or installation or parts, consult your local dealer.

## ADVERTENCIA

Siga siempre estas instrucciones antes de conectar o instalar piezas. De lo contrario, puede que esta unidad no funcione correctamente. Además, si las piezas de esta unidad no funcionan correctamente, la unidad puede expulsar humo o fuego.

- Extraiga siempre un conector del terminal de batería  $\ominus$  antes de realizar cualquier conexión o instalación. (Fig.1)
- Asegúrese de que el cable de corriente, el cable de conexión a tierra y el altavoz están correctamente conectados. Le recomendamos que utilice un enchufe y un receptáculo, un contacto sin soldadura y un conector en Y. (Fig.2)
- Cuando instale esta unidad, conecte siempre el cable de conexión a tierra en primer lugar. Asegúrese de que el cable de conexión a tierra está correctamente conectado a las partes metálicas de la carrocería del automóvil. (Fig.3)
  1. Cable de conexión a tierra
  2. Partes metálicas de la carrocería del automóvil
- Conecte a esta unidad únicamente altavoces de alta potencia, de más de 50 W y con una impedancia de entre 4 y 8 ohmios. Aunque existen sistemas de altavoces con baja impedancia entre 1 y 3 ohmios, no debe conectarlos a esta unidad.
- Cuando conecte el amplificador de potencia (vendido por separado) a esta unidad, asegúrese de que el cable de conexión a tierra del amplificador de potencia está conectado correctamente a las partes metálicas de la carrocería del automóvil. Conecte el cable de conexión a tierra del amplificador de potencia con un tornillo distinto del utilizado para conectar el cable de conexión a tierra de esta unidad o cualquier otro dispositivo. En caso de que el tornillo del cable de conexión a tierra del amplificador de potencia se afloje o se suelte, la unidad puede expulsar humo o dejar de funcionar correctamente. (Fig.4)
  3. Otros dispositivos (otro dispositivo electrónico del automóvil)
  4. AMPLIFICADOR DE POTENCIA
- Cubra cualquier terminal no conectado con cinta aislante para que no haga contacto con el metal.
- No cambie las conexiones del altavoz mientras esta unidad esté en funcionamiento.

Si tiene alguna pregunta en relación con la conexión o la instalación de piezas, consulte a su distribuidor local.

## AVERTISSEMENT

Veillez toujours suivre les instructions indiquées ci-dessous lors du branchement ou de l'installation des pièces. Ne pas suivre les instructions indiquées ci-dessous peut entraîner un mauvais fonctionnement de l'unité. En outre, si les pièces de cette unité fonctionnent mal, de la fumée pourra sortir de l'unité ou cette dernière pourra prendre feu.

- Assurez-vous de toujours enlever un connecteur de la prise  $\ominus$  de la batterie avant de effectuer un branchement ou un travail d'installation. (Fig.1)
- Assurez-vous que le cordon d'alimentation, le fil de terre et l'enceinte sont branchés correctement. Nous vous recommandons d'utiliser une fiche et une prise de courant (femelle), un contact sans soudure et un raccord en Y. (Fig.2)
- Quand vous installez l'unité, veuillez toujours brancher le fil de terre en premier. Assurez-vous que le fil de terre est branché correctement aux pièces métalliques de la carrosserie de la voiture. (Fig.3)
  1. Fil de terre
  2. Pièces métalliques de la carrosserie de la voiture
- Assurez-vous de ne brancher à cette unité que des enceintes à haute puissance de plus de 50 W et d'une impedância entre 4 et 8 ohms. Même s'il existe des systèmes d'enceintes avec une impedância basse entre 1 et 3 ohms, vous ne devez pas brancher ce type d'enceintes à l'unité.
- Quand vous branchez l'amplificateur de puissance (vendu séparément) à cette unité, assurez-vous que le fil de terre de l'amplificateur de puissance est branché correctement aux pièces métalliques de la carrosserie de la voiture. Branchez le fil de terre de l'amplificateur de puissance avec un tournevis différent de celui que vous avez utilisé pour brancher le fil de terre à l'unité ou un autre dispositif. Si la vis du fil de terre de l'amplificateur de puissance se desserre ou tombe, de la fumée pourra sortir de l'unité ou elle fonctionnera mal. (Fig.4)
  3. Autres dispositifs (Un autre dispositif électronique dans la voiture)
  4. AMPLIFICATEUR DE PUISSANCE
- Couvrez toutes les prises qui ne sont pas branchées avec du ruban isolant pour qu'elles ne soient pas en contact avec du métal.
- Ne changez pas les branchements de l'enceinte quand l'unité est en marche.

Si vous avez des questions sur le branchement ou l'installation des pièces, veuillez consulter votre revendeur local.

## ADVERTÊNCIA

Siga sempre as seguintes instruções quando realizar a ligação ou instalação de peças. O não cumprimento das seguintes instruções pode resultar no funcionamento incorrecto desta unidade. Para além disso, se as peças desta unidade não funcionarem correctamente, a unidade pode produzir fumo e incendiar.

- Retire sempre um ligador do terminal da bateria  $\ominus$  antes de realizar qualquer trabalho de ligação ou instalação. (Fig.1)
- Certifique-se de que o cabo de alimentação, o fio terra e a coluna estão devidamente ligados. Recomendamos a utilização de uma ficha e de uma tomada, de um contacto sem solda e de um conector em Y. (Fig.2)
- Quando instalar esta unidade, ligue sempre em primeiro lugar o fio terra. Certifique-se de que o fio terra está devidamente ligado a partes metálicas da carroçaria do automóvel. (Fig.3)
  1. Fio terra
  2. Peças metálicas da carroçaria do automóvel
- Ligue a esta unidade apenas a colunas de elevado desempenho com potência superior a 50W e com impedância entre 4 e 8 ohms. Embora existam colunas com baixa impedância, entre 1 e 3 ohms, não deve ligá-las a esta unidade.
- Quando ligar o amplificador (vendido em separado) a esta unidade, certifique-se de que o fio terra para o amplificador está devidamente ligado a peças metálicas da carroçaria do automóvel. Ligue o fio terra do amplificador com um parafuso diferente do utilizado para ligar o fio terra a esta unidade ou a qualquer outro dispositivo. Se o parafuso do amplificador se soltar ou cair, poderá fazer com que a unidade comece a deitar fumo ou a funcionar mal. (Fig.4)
  3. Outros dispositivos (Outra unidade electrónica no automóvel)
  4. AMPLIFICADOR
- Tape todos os terminais não ligados com fita isoladora de forma a que não fiquem em contacto com o metal.
- Não mude as ligações das colunas enquanto a unidade estiver a funcionar.

Em caso de dúvidas relacionadas com a ligação ou instalação de peças, consulte o seu distribuidor local.

<KMMNF> <CRP1310-A/N>



PIONEER ELECTRONICS (USA) INC.

PIONEER ELECTRONICS OF CANADA, INC.

LIMITED WARRANTY
WARRANTY VALID ONLY IN COUNTRY OF PRODUCT PURCHASE

WARRANTY

Pioneer Electronics (USA) Inc. (PUSA), and Pioneer Electronics Of Canada, Inc. (POC), warrant that products distributed by PUSA in the U.S.A., and by POC in Canada that fail to function properly under normal use due to a manufacturing defect when installed and operated according to the owner's manual enclosed with the unit will be repaired or replaced with a unit of comparable value, at the option of PUSA or POC, without charge to you for parts or actual repair work.

THIS LIMITED WARRANTY APPLIES TO THE ORIGINAL OR ANY SUBSEQUENT OWNER OF THIS PIONEER PRODUCT DURING THE WARRANTY PERIOD PROVIDED THE PRODUCT WAS PURCHASED FROM AN AUTHORIZED PIONEER DISTRIBUTOR/DEALER IN THE U.S.A. OR CANADA. YOU WILL BE REQUIRED TO PROVIDE A SALES RECEIPT OR OTHER VALID PROOF OF PURCHASE SHOWING THE DATE OF ORIGINAL PURCHASE OR, IF RENTED, YOUR RENTAL CONTRACT SHOWING THE PLACE AND DATE OF FIRST RENTAL.

PRODUCT WARRANTY PERIOD

Table with 2 columns: Product Type, Parts, Labor. Row: Car Stereo Products, 1 Year, 1 Year

The warranty period for retail customers who rent the product commences upon the date product is first put into use (a) during the rental period or (b) retail sale, whichever occurs first.

WHAT IS NOT COVERED

IF THIS PRODUCT WAS PURCHASED FROM AN UNAUTHORIZED DISTRIBUTOR, THERE ARE NO WARRANTIES, EXPRESS OR IMPLIED, INCLUDING THE IMPLIED WARRANTY OF MERCHANTABILITY AND THE IMPLIED WARRANTY OF FITNESS FOR A PARTICULAR PURPOSE AND THIS PRODUCT IS SOLD STRICTLY "AS IS" AND "WITH ALL FAULTS".

PIONEER DOES NOT WARRANT ANY PRODUCT LISTED ABOVE WHEN IT IS USED IN A TRADE OR BUSINESS OR IN ANY INDUSTRIAL OR COMMERCIAL APPLICATION.

THIS WARRANTY DOES NOT APPLY IF THE PRODUCT HAS BEEN SUBJECTED TO POWER IN EXCESS OF ITS PUBLISHED POWER RATING.

THIS WARRANTY DOES NOT COVER DISPLAY SCREENS DAMAGED BY STATIC, NON-MOVING, IMAGES APPLIED FOR LENGTHY PERIODS (BURN-IN).

THIS WARRANTY DOES NOT COVER THE CABINET OR ANY APPEARANCE ITEM, USER ATTACHED ANTENNA, ANY DAMAGE TO RECORDS OR RECORDING TAPES OR DISCS, ANY DAMAGE TO THE PRODUCT RESULTING FROM ALTERATIONS, MODIFICATIONS NOT AUTHORIZED IN WRITING BY PIONEER, ACCIDENT, MISUSE OR ABUSE, DAMAGE DUE TO LIGHTNING OR TO POWER SURGES, SUBSEQUENT DAMAGE FROM LEAKING, DAMAGE FROM INOPERATIVE BATTERIES, OR THE USE OF BATTERIES NOT CONFORMING TO THOSE SPECIFIED IN THE OWNER'S MANUAL.

THIS WARRANTY DOES NOT COVER THE COST OF PARTS OR LABOR WHICH WOULD BE OTHERWISE PROVIDED WITHOUT CHARGE UNDER THIS WARRANTY OBTAINED FROM ANY SOURCE OTHER THAN A PIONEER AUTHORIZED SERVICE COMPANY OR OTHER DESIGNATED LOCATION. THIS WARRANTY DOES NOT COVER DEFECTS OR DAMAGE CAUSED BY THE USE OF UNAUTHORIZED PARTS OR LABOR OR FROM IMPROPER MAINTENANCE.

ALTERED, DEFACED, OR REMOVED SERIAL NUMBERS VOID THIS ENTIRE WARRANTY

NO OTHER WARRANTIES

IN THE U.S.A. - PIONEER LIMITS ITS OBLIGATIONS UNDER ANY IMPLIED WARRANTIES INCLUDING, BUT NOT LIMITED TO, THE IMPLIED WARRANTIES OF MERCHANTABILITY AND FITNESS FOR A PARTICULAR PURPOSE, TO A PERIOD NOT TO EXCEED THE WARRANTY PERIOD. NO WARRANTIES SHALL APPLY AFTER THE WARRANTY PERIOD.

IN CANADA - EXCEPT AS EXPRESSLY PROVIDED HEREIN, THERE ARE NO REPRESENTATIONS, WARRANTIES, OBLIGATIONS OR CONDITIONS, IMPLIED, STATUTORY OR OTHERWISE, APPLICABLE TO THIS PRODUCT.

TO OBTAIN SERVICE

In the U.S.A. or Canada to receive warranty service you need to present your sales receipt or your rental contract showing place and date of original owner's transaction.

USA - Please contact one of the following Pioneer partners to obtain service:

Your Authorized Pioneer Dealer - Your Pioneer Dealer may repair or replace your unit, or refer you to an Authorized Pioneer Service Company. Your sales receipt should list the contact information (phone number, fax, email, etc.) for your Dealer.

Your Authorized Pioneer Service Company - Can perform repairs for most Car Electronics products and can advise other options as applicable. Please access the Pioneer website at www.pioneerelectronics.com and click on Service and Support and select Authorized Service Locator to find the nearest Pioneer servicer.

Pioneer Electronics Service - Can advise the optimal service option for your model and geographic location. Please reference the information listed below and phone, email or access the Pioneer website to contact Pioneer.

CANADA - POC has a number of Authorized Service Companies should your product require service. Contact Pioneer of Canada as listed below to obtain a local service location.

Shipping Your Unit for Service - Please package it carefully and send it, transportation prepaid by a traceable, insured method, to an Authorized Service Company or Pioneer. Use adequate padding material to prevent damage in transit. Include your name, address and telephone number where you can be reached during business hours.

On all complaints and concerns in the U.S.A. call Customer Support at 1-800-421-1404, or, in Canada, call Customer Satisfaction at (905) 479-4411.

IN THE U.S.A.

For hook-up and operation of your unit or to locate an Authorized Service Company, please call or write:

PIONEERELECTRONICSSERVICE, INC.
P.O. BOX 1760
LONG BEACH, CALIFORNIA 90801
1-800-421-1404
http://www.pioneerelectronics.com

IN CANADA

For additional information on this warranty, please call or write:

CUSTOMERSATISFACTIONGROUP
PIONEERELECTRONICS OF CANADA, INC.
300 ALLSTATE PARKWAY
MARKHAM, ON L3R 0P2
(905) 479-4411 1-877-283-5901
http://www.pioneerelectronics.com

DISPUTE RESOLUTION

IN THE U.S.A. - Following our response to any initial request to Customer Support, should a dispute arise between you and Pioneer, Pioneer makes available its Complaint Resolution Program to resolve the dispute. The Complaint Resolution Program is available to you without charge. You are required to use the Complaint Resolution Program before you exercise any rights under, or seek any remedies, created by Title I of the Magnuson-Moss Warranty-Federal Trade Commission Improvement Act, 15 U.S.C. 2301 et seq.

To use the Complaint Resolution Program call 1-800-421-1404 and explain to the customer service representative the problem you are experiencing, steps you have taken to have the product repaired during the warranty period and the name of the authorized Distributor/Dealer from whom the Pioneer product was purchased. After the complaint has been explained to the representative, a resolution number will be issued. Within 40 days of receiving your complaint, Pioneer will investigate the dispute and will either: (1) respond to your complaint in writing informing you what action Pioneer will take, and in what time period, to resolve the dispute; or (2) respond to your complaint in writing informing you why it will not take any action.

IN CANADA - Call the Customer Satisfaction Manager at (905) 946-7446 to discuss your complaint and to obtain a prompt resolution.

RECORD THE PLACE AND DATE OF PURCHASE FOR FUTURE REFERENCE

Model No. Serial No. Purchase Date

Purchased From

KEEP THIS INFORMATION AND YOUR SALES RECEIPT IN A SAFE PLACE
Download from Www.Somanuals.com. All Manuals Search And Download.

< CRY1246-A/U >
Printed in China

## Free Manuals Download Website

<http://myh66.com>

<http://usermanuals.us>

<http://www.somanuals.com>

<http://www.4manuals.cc>

<http://www.manual-lib.com>

<http://www.404manual.com>

<http://www.luxmanual.com>

<http://aubethermostatmanual.com>

Golf course search by state

<http://golfingnear.com>

Email search by domain

<http://emailbydomain.com>

Auto manuals search

<http://auto.somanuals.com>

TV manuals search

<http://tv.somanuals.com>