

**Pioneer** *sound.vision.soul*

**VSX-1017AV-S**  
**VSX-1017AV-K**

AUDIO/VIDEO MULTI-CHANNEL RECEIVER

Discover the benefits of registering your product online at <http://www.pioneer.co.uk>  
(or <http://www.pioneer.eu>).

Operating Instructions

# IMPORTANT



The lightning flash with arrowhead symbol, within an equilateral triangle, is intended to alert the user to the presence of uninsulated "dangerous voltage" within the product's enclosure that may be of sufficient magnitude to constitute a risk of electric shock to persons.

## CAUTION

**RISK OF ELECTRIC SHOCK  
DO NOT OPEN**

### CAUTION:

TO PREVENT THE RISK OF ELECTRIC SHOCK, DO NOT REMOVE COVER (OR BACK). NO USER-SERVICEABLE PARTS INSIDE. REFER SERVICING TO QUALIFIED SERVICE PERSONNEL.



The exclamation point within an equilateral triangle is intended to alert the user to the presence of important operating and maintenance (servicing) instructions in the literature accompanying the appliance.

D3-4-2-1-1\_En-A

Replacement and mounting of an AC plug on the power supply cord of this unit should be performed only by qualified service personnel.

### IMPORTANT: THE MOULDED PLUG

This appliance is supplied with a moulded three pin mains plug for your safety and convenience. A 5 amp fuse is fitted in this plug. Should the fuse need to be replaced, please ensure that the replacement fuse has a rating of 5 amps and that it is approved by ASTA or BSI to BS1362.

Check for the ASTA mark  or the BSI mark  on the body of the fuse.

If the plug contains a removable fuse cover, you must ensure that it is refitted when the fuse is replaced. If you lose the fuse cover the plug must not be used until a replacement cover is obtained. A replacement fuse cover can be obtained from your local dealer.

**If the fitted moulded plug is unsuitable for your socket outlet, then the fuse shall be removed and the plug cut off and disposed of safely. There is a danger of severe electrical shock if the cut off plug is inserted into any 13 amp socket.**

If a new plug is to be fitted, please observe the wiring code as shown below. If in any doubt, please consult a qualified electrician.

IMPORTANT: The wires in this mains lead are coloured in accordance with the following code:

Blue : Neutral Brown : Live

As the colours of the wires in the mains lead of this appliance may not correspond with the coloured markings identifying the terminals in your plug, proceed as follows :

The wire which is coloured BLUE must be connected to the terminal which is marked with the letter **N** or coloured BLACK.  
The wire which is coloured BROWN must be connected to the terminal which is marked with the letter **L** or coloured RED.

**How to replace the fuse:** Open the fuse compartment with a screwdriver and replace the fuse.

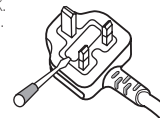

D3-4-2-1-2-2\_B\_En

## WARNING

*Before plugging in for the first time, read the following section carefully.*

**The voltage of the available power supply differs according to country or region. Be sure that the power supply voltage of the area where this unit will be used meets the required voltage (e.g., 230 V or 120 V) written on the rear panel.**

D3-4-2-1-4\_A\_En

## WARNING

**To prevent a fire hazard, do not place any naked flame sources (such as a lighted candle) on the equipment.**

D3-4-2-1-7a\_A\_En

This product complies with the Low Voltage Directive (73/23/EEC, amended by 93/68/EEC), EMC Directives (89/336/EEC, amended by 92/31/EEC and 93/68/EEC).

D3-4-2-1-9a\_En

## WARNING

**This equipment is not waterproof. To prevent a fire or shock hazard, do not place any container filled with liquid near this equipment (such as a vase or flower pot) or expose it to dripping, splashing, rain or moisture.**

D3-4-2-1-3\_A\_En

## VENTILATION CAUTION

**When installing this unit, make sure to leave space around the unit for ventilation to improve heat radiation (at least 60 cm at top, 10 cm at rear, and 30 cm at each side).**

## WARNING

**Slots and openings in the cabinet are provided for ventilation to ensure reliable operation of the product, and to protect it from overheating. To prevent fire hazard, the openings should never be blocked or covered with items (such as newspapers, table-cloths, curtains) or by operating the equipment on thick carpet or a bed.**

D3-4-2-1-7b\_A\_En

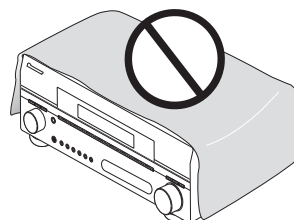

If the AC plug of this unit does not match the AC outlet you want to use, the plug must be removed and appropriate one fitted. Replacement and mounting of an AC plug on the power supply cord of this unit should be performed only by qualified service personnel. If connected to an AC outlet, the cut-off plug can cause severe electrical shock. Make sure it is properly disposed of after removal. The equipment should be disconnected by removing the mains plug from the wall socket when left unused for a long period of time (for example, when on vacation).

D3-4-2-2-1a\_A\_En

#### CAUTION

The **⏻STANDBY/ON** switch on this unit will not completely shut off all power from the AC outlet. Since the power cord serves as the main disconnect device for the unit, you will need to unplug it from the AC outlet to shut down all power. Therefore, make sure the unit has been installed so that the power cord can be easily unplugged from the AC outlet in case of an accident. To avoid fire hazard, the power cord should also be unplugged from the AC outlet when left unused for a long period of time (for example, when on vacation).

D3-4-2-2-2a\_A\_En

### Operating Environment

Operating environment temperature and humidity: +5 °C to +35 °C (+41 °F to +95 °F); less than 85 %RH (cooling vents not blocked)

Do not install this unit in a poorly ventilated area, or in locations exposed to high humidity or direct sunlight (or strong artificial light)

D3-4-2-1-7c\_A\_En

This product is for general household purposes. Any failure due to use for other than household purposes (such as long-term use for business purposes in a restaurant or use in a car or ship) and which requires repair will be charged for even during the warranty period.

K041\_En



If you want to dispose this product, do not mix it with general household waste. There is a separate collection system for used electronic products in accordance with legislation that requires proper treatment, recovery and recycling.

Private households in the member states of the EU, in Switzerland and Norway may return their used electronic products free of charge to designated collection facilities or to a retailer (if you purchase a similar new one).

For countries not mentioned above, please contact your local authorities for the correct method of disposal.

By doing so you will ensure that your disposed product undergoes the necessary treatment, recovery and recycling and thus prevent potential negative effects on the environment and human health.

K058\_A\_En

Thank you for buying this Pioneer product. Please read through these operating instructions so you will know how to operate your model properly. After you have finished reading the instructions, put them away in a safe place for future reference.

# Contents

## 01 Before you start

Features	6
Checking what's in the box	7
Installing the receiver	7
Loading the batteries	7

## 02 5 minute guide

Introduction to home theater	8
Listening to Surround Sound	8
Automatically setting up for surround sound (Auto MCACC)	8
Problems when using the Auto MCACC Setup	10
Playing a source	10
Better sound using Phase Control	10

## 03 Connecting your equipment

Rear panel	11
When making cable connections	12
About the video converter	12
Connecting your TV and DVD player	13
Connecting a satellite/cable receiver or other set-top box	13
Connecting a DVD/HDD recorder, VCR and other video sources	14
Using the component video jacks	14
Connecting using HDMI	15
About HDMI	16
Connecting digital audio sources	16
About the WMA9 Pro decoder	17
Connecting analog audio sources	17
Connecting a component to the front panel inputs	17
Installing your speaker system	18
Connecting the speakers	18
Placing the speakers	19
THX speaker system setup	20
Connecting antennas	20
Connecting external antennas	21
Plugging in the receiver	21

## 04 Controls and displays

Front panel	22
Operating range of remote control unit	23
Display	24
Remote control	25

## 05 Listening to your system

Auto playback	27
Listening in surround sound	27
Standard surround sound	27
Using the Home THX modes	28
Using the Advanced surround effects	28
Setting the effect options	29
Listening in stereo	29
Using Front Stage Surround Advance	29
Using Stream Direct	30
Listening with Acoustic Calibration EQ	30
Choosing the input signal	30
Using surround back channel processing	30
Using the Virtual Surround Back mode	31
Using Midnight and Loudness	32
Using the Sound Retriever	32
Enhancing dialog	32
Using the tone controls	32

## 06 USB playback

Using the USB interface	33
Basic playback controls	33
Selecting a file from the folder/file list for playback	33
Compressed audio compatibility	34

## 07 Using the tuner

Listening to the radio	35
Improving FM stereo sound	35
Tuning directly to a station	35
Saving station presets	35
Naming station presets	36
Listening to station presets	36
An introduction to RDS	36
Searching for RDS programs	36
Using EON	37

## 08 The System Setup menu

Making receiver settings from the System Setup menu.....	38
Surround back speaker setting .....	38
Manual MCACC setup.....	39
Fine Channel Level .....	39
Fine Speaker Distance .....	40
Professional Acoustic Calibration EQ.....	40
Manual speaker setup.....	43
Speaker Setting .....	43
Crossover Network .....	44
Channel Level .....	44
Speaker Distance .....	45
THX Audio Setting.....	45
THX Speaker Setup .....	45

## 09 Other connections

Connecting an iPod.....	46
Connecting your iPod to the receiver .....	46
iPod playback .....	46
Connecting the multichannel analog inputs.....	47
Selecting the multichannel analog inputs .....	47
Speaker B setup .....	48
Switching the speaker system .....	48
Bi-amping your front speakers .....	48
Bi-wiring your speakers.....	49
Connecting additional amplifiers.....	49
Using this receiver with a Pioneer plasma display.....	50
Using the SR+ mode with a Pioneer plasma display.....	51

## 10 Other Settings

The Input Assign menu.....	52
The Other Setup menu .....	53
Dynamic Range Control Setup .....	53
Dual Mono Setup .....	54
LFE Attenuator Setup .....	54
SR+ Setup for Pioneer plasma displays.....	54
Video Converter Setup .....	54

## 11 Using other functions

Making an audio or a video recording.....	55
Reducing the level of an analog signal.....	55
Using the sleep timer .....	55
Dimming the display.....	56
Switching the speaker impedance .....	56
Resetting the system .....	56

## 12 Controlling the rest of your system

Setting the remote to control other components.....	57
Selecting preset codes directly .....	57
Resetting the remote control presets .....	57
Confirming preset codes .....	57
Direct function.....	57
Multi Operation and System Off .....	58
Programming a multi-operation or a shutdown sequence.....	58
Using multi operations .....	59
Using System off.....	59
Controls for TVs.....	59
Controls for other components .....	60
Operating other Pioneer components with this unit's sensor .....	61

## 13 Additional information

Troubleshooting .....	62
Power.....	62
No sound .....	62
Other audio problems .....	63
Video .....	64
Settings.....	64
Display.....	65
Remote control .....	65
USB interface .....	66
HDMI .....	66
iPod messages .....	66
Surround sound formats .....	67
Dolby .....	67
DTS .....	67
Windows Media™ Audio 9 Professional .....	68
About THX .....	68
Listening modes with different input signal formats.....	69
Specifications .....	71
Cleaning the unit.....	71

## Chapter 1:

# Before you start

### Features

- **Advanced Direct Energy design**

This receiver offers a new advancement in discrete design unique to Pioneer for high-power drivability, low distortion and stable imaging. Through symmetrical placement of power amplification units, this receiver generates equal amplifier power to all channels, eliminating the possibility of one channel dominating a particular sound field.

- **Easy setup using Multichannel Acoustic Calibration (Auto MCACC)**

Setting up for home theater sound is as easy as connecting speakers, components like a DVD player, and a TV. The Auto MCACC Setup, which includes the advanced features of Professional Acoustic Calibration EQ, provides a quick yet accurate surround sound setup. This innovative technology measures the reverb characteristics of your listening area, allowing you to customize your system calibration. Moreover, you have access to the full range of surround sound settings.

- **THX Select2 certified design**

This receiver bears the THX Select2 logo, which means it has passed a rigorous series of quality and performance tests covering every aspect of the product. This includes testing of pre-amplifier and power amplifier performance and operation, and hundreds of other parameters in both the digital and analog domain, making your home theater experience as faithful as possible to what the director intended.

- **Dolby Digital and DTS decoding, including Dolby Digital EX, Dolby Pro Logic IIx, DTS 96/24 and DTS-ES**

Dolby Digital and DTS decoding brings theater sound right into your home with up to six channels of surround sound, including a special LFE (Low Frequency Effects) channel for deep, realistic sound effects.

The built-in Dolby Pro Logic IIx and DTS Neo:6 decoders not only provide full surround sound decoding for Dolby Surround sources, but will also generate convincing surround sound for any stereo source.

Also, with the addition of a surround back speaker, you can take advantage of the built-in Dolby Digital EX and DTS-ES decoders for six-channel surround sound.

- **Phase correction**

Based on Pioneer's unique Phase Control Technology, the Phase Control feature incorporated into this receiver's design provides coherent sound reproduction through the use of phase matching for an optimal sound image at your listening position.

- **Sound Retriever**

The Sound Retriever feature employs new DSP technology that helps bring CD quality sound back to WMA, MP3 and MPEG-4 AAC audio files by restoring sound pressure and smoothing jagged artifacts left over after compression.

- **Front Stage Surround Advance**

With the Front Stage Surround Advance feature, you can enjoy seamless, natural surround sound effects using only the front speakers, without deteriorating the quality of the original sound.

- **HDMI compatibility**

This receiver is compatible with the HDMI digital video format, providing you high-definition digital video and digital audio via a single cable.

- **Built-in video converter**

The built-in video converter provides output of all analog video signals to your TV or monitor (regardless of the type of connection), allowing you to connect components using component, S-video, and composite video connections as you like.

- **iPod Ready**

With the new iPod terminal, you'll be up and running in no time, now that this receiver's enhanced compatibility makes on-screen control of your iPod an added possibility.

- **USB interface**

The USB allows you to listen to two-channel audio from a USB mass storage device connected to this receiver.

- **Easy-to-use LCD remote control**

The remote control gives you not only complete control over every function of this receiver, but also over the main functions for other components in your home theater system. Using a system of preset codes, you can program the remote to operate a wide range of other equipment.

## Checking what's in the box

Please check that you've received the following supplied accessories:

- Setup microphone (cable: 5 m)
- Remote control unit
- AA/IEC R6P dry cell batteries x2
- AM loop antenna
- FM wire antenna
- Warranty card
- These operating instructions

## Installing the receiver

- When installing this unit, make sure to put it on a level and stable surface.

Don't install it on the following places:

- on a color TV (the screen may distort)
- near a cassette deck (or close to a device that gives off a magnetic field). This may interfere with the sound.
- in direct sunlight
- in damp or wet areas
- in extremely hot or cold areas
- in places where there is vibration or other movement
- in places that are very dusty
- in places that have hot fumes or oils (such as a kitchen)

## Loading the batteries

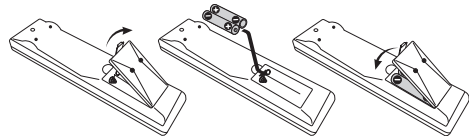

### Caution

Incorrect use of batteries may result in such hazards as leakage and bursting. Observe the following precautions:

- Never use new and old batteries together.
- Insert the plus and minus sides of the batteries properly according to the marks in the battery case.
- Batteries with the same shape may have different voltages. Do not use different batteries together.
- When disposing of used batteries, please comply with governmental regulations or environmental public instruction's rules that apply in your country or area.
- Do not use or store batteries in direct sunlight or other excessively hot place, such as inside a car or near a heater. This can cause batteries to leak, overheat, explode or catch fire. It can also reduce the life or performance of batteries.

## Chapter 2: 5 minute guide

### Introduction to home theater

Home theater refers to the use of multiple audio tracks to create a surround sound effect, making you feel like you're in the middle of the action or concert. The surround sound you get from a home theater system depends not only on your speaker setup, but also on the source and the sound settings of the receiver.

This receiver will automatically decode multichannel Dolby Digital, DTS, or Dolby Surround sources according to your speaker setup. In most cases, you won't have to make changes for realistic surround sound, but other possibilities (like listening to a CD with multichannel surround sound) are explained in *Listening to your system* on page 27.

### Listening to Surround Sound

This receiver was designed with the easiest possible setup in mind, so with the following quick setup guide, you should have your system hooked up for surround sound in no time at all. In most cases, you can simply leave the receiver in the default settings.

- Be sure to complete all connections before connecting this unit to an AC power source.

#### 1 Connect your TV and DVD player.

See *Connecting your TV and DVD player* on page 13 to do this. For surround sound, you'll want to hook up using a digital connection from the DVD player to the receiver.

#### 2 Connect your speakers and place them for optimal surround sound.

Connect your speakers as shown in *Installing your speaker system* on page 18.

Where you place the speakers will have a big effect on the sound. Place your speakers as shown below for the best surround sound effect. Also see *Placing the speakers* on page 19 for more on this.

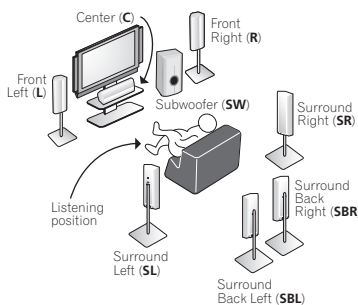

#### 3 Plug in the receiver and switch it on, followed by your DVD player, your subwoofer and the TV.

Make sure you've set the video input on your TV to this receiver. Check the manual that came with the TV if you don't know how to do this.

- Set the subwoofer volume to a comfortable level.

#### 4 Use the on-screen automatic MCACC setup to set up your system.

See *Automatically setting up for surround sound (Auto MCACC)* below for more on this.

#### 5 Play a DVD, and adjust the volume to your liking.

Make sure that **DVD/LD** is showing in the receiver's display, indicating that the DVD input is selected. If it isn't, press **DVD** on the remote control to set the receiver to the DVD input.

In addition to the basic playback explained in *Playing a source* on page 10, there are several other sound options you can select. See *Listening to your system* on page 27 for more on this.

See also *Making receiver settings from the System Setup menu* on page 38 for more setup options.

### Automatically setting up for surround sound (Auto MCACC)

The Auto MCACC Setup measures the acoustic characteristics of your listening area, taking into account ambient noise, speaker size and distance, and tests for both channel delay and channel level. After you have set up the microphone provided with your system, the receiver uses the information from a series of test tones to optimize the speaker settings and equalization for your particular room.

Make sure you do this before moving on to *Playing a source* on page 10.

#### Important

- Make sure the microphone and speakers are not moved during the Auto MCACC Setup.
- Before using the Auto MCACC Setup, make sure that the headphones are disconnected from this receiver and the iPod or USB is not selected as the input source.

#### Caution

- The test tones used in the Auto MCACC Setup are output at high volume.

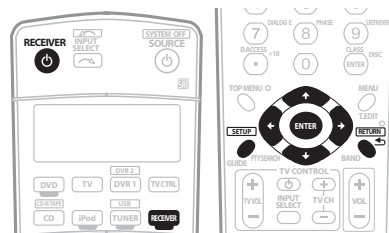



### 1 Switch on the receiver and your TV.

### 2 Connect the microphone to the MCACC SETUP MIC jack on the front panel.

Place the microphone so that it's about ear level at your normal listening position (use a tripod if possible). Make sure there are no obstacles between the speakers and the microphone.

- Push down on the **PUSH OPEN** tab to access the **MCACC SETUP MIC** jack:



The Auto MCACC display appears once the microphone is connected.<sup>1</sup>

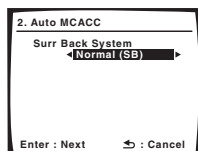

### 3 Make sure 'Normal (SB)' is selected then press ENTER.<sup>2</sup>

### 4 Make sure 'TYPE1' is selected then press ENTER.<sup>3</sup>

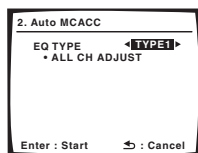

### 5 Follow the instructions on-screen.

Make sure the microphone is connected, and if you're using a subwoofer, make sure it is switched on and set to a comfortable volume level.

### 6 Wait for the test tones to finish then confirm the speaker configuration in the OSD.

A progress report is displayed on-screen while the receiver outputs test tones to determine the speakers present in your setup. Try to be as quiet as possible while it's doing this.<sup>4</sup>

If no operations are performed for 10 seconds while the speaker configuration check screen is being displayed, the Auto MCACC Setup will resume automatically. In this case, you don't need to select '**OK**' and press **ENTER** in step 7.

- With error messages (such as **Ambient Noise** or **Microphone Check**) select **RETRY** after checking for ambient noise (see *Problems when using the Auto MCACC Setup* below) and verifying the mic connection. If there doesn't seem to be a problem, you can simply select **OK** and continue.

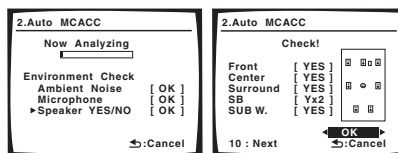

The configuration shown on-screen should reflect the actual speakers you have.<sup>5</sup>

If you see an error message (**ERR**) in the right side column (or the speaker configuration displayed isn't correct), there may be a problem with the speaker connection. If selecting **RETRY** doesn't work, turn off the power and check the speaker connections. If there doesn't seem to be a problem, you can simply use **↑/↓** to select the speaker and **←/→** to change the setting (and number for surround back) and continue.

### 7 Make sure 'OK' is selected, then press ENTER.

A progress report is displayed on-screen while the receiver outputs more test tones to determine the optimum receiver settings for channel level, speaker distance, and Acoustic Calibration EQ.

Again, try to be as quiet as possible while this is happening. It may take 2 to 6 minutes.

### 8 The Auto MCACC Setup has finished! Select 'SKIP' to go back to the System Setup menu.

Be sure to disconnect the microphone from this receiver upon completion of the Auto MCACC setup.

The settings made in the Auto MCACC Setup should give you excellent surround sound from your system, but it is also possible to adjust these settings manually using the System Setup menu (starting on page 38).<sup>6</sup>

#### Note

- If you cancel the Auto MCACC Setup, or leave an error message for over three minutes, the screen saver will appear.
  - The OSD will not appear if you have connected using the HDMI output to your TV. Use component, S-video, or composite connections for system setup.
- If you are planning on bi-amping your front speakers, or setting up a separate speaker system in another room, read through *Surround back speaker setting* on page 38 and make sure to connect your speakers as necessary before continuing to step 5.
  - If you have THX-certified speakers, make sure **YES** is selected in *THX Speaker Setup* on page 45.
- When **TYPE1** is selected, the calibration is set for **ALL CH ADJUST**; when **TYPE2** is selected, the calibration is set for both **ALL CH ADJUST** and **FRONT ALIGN**. For details on the correction of each setting, see *Professional Acoustic Calibration EQ* on page 40.
- Do not adjust the volume during the test tones. This may result in incorrect speaker settings.
- If you're using the front panel display, the diagram in *Listening to Surround Sound* above indicates (in bold) how each speaker is displayed.
- Depending on the characteristics of your room, sometimes identical speakers with cone sizes of around 12 cm will end up with different size settings. You can correct the setting manually using the *Manual speaker setup* on page 43.
  - The subwoofer distance setting may be farther than the actual distance from the listening position. This setting should be accurate (taking delay and room characteristics into account) and generally does not need to be changed.

## Problems when using the Auto MCACC Setup

If the room environment is not optimal for the Auto MCACC Setup (too much background noise, echo off the walls, obstacles blocking the speakers from the microphone) the final settings may be incorrect. Check for household appliances (air conditioner, fridge, fan, etc.), that may be affecting the environment and switch them off if necessary. If there are any instructions showing in the front panel display, please follow them.

- Some older TVs may interfere with the operation of the microphone. If this seems to be happening, switch off the TV when doing the Auto MCACC Setup.

## Playing a source

Here are the basic instructions for playing a source (such as a DVD disc) with your home theater system.

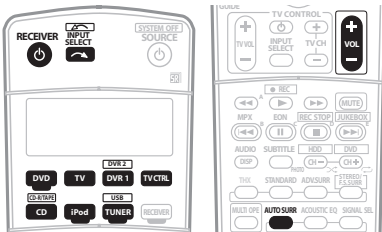

### 1 Switch on your system components and receiver.

Start by switching on the playback component (for example a DVD player), your TV<sup>1</sup> and subwoofer (if you have one), then the receiver (press **RECEIVER**).

- Make sure the setup mic is disconnected.

### 2 Select the input source you want to play.

You can use the input source buttons on the remote control, **INPUT SELECT**, or the front panel controls.<sup>2</sup>

### 3 Press **AUTO SURR** to select 'AUTO SURROUND' and start playback of the source.<sup>3</sup>

If you're playing a Dolby Digital or DTS surround sound DVD disc, you should hear surround sound. If you are playing a stereo source, you will only hear sound from the front left/right speakers in the default listening mode.

- See also *Listening to your system* on page 27 for information on different ways of listening to sources.

### 4 Use the volume control to adjust the volume level.

Turn down the volume of your TV so that all sound is coming from the speakers connected to this receiver.

#### Note

<sup>1</sup> Make sure that the TV's video input is set to this receiver. (For example, if you connected this receiver to the **VIDEO 1** jacks on your TV, make sure that the **VIDEO 1** input is now selected.)

<sup>2</sup> If you need to manually switch the input signal type press **SIGNAL SEL** (page 30).

<sup>3</sup> • You may need to check the digital audio output settings on your DVD player or digital satellite receiver. It should be set to output Dolby Digital, DTS and 88.2 kHz / 96 kHz PCM (2 channel) audio, and if there is an MPEG audio option, set this to convert the MPEG audio to PCM.

• Depending on your DVD player or source discs, you may only get digital 2 channel stereo and analog sound. In this case, the receiver must be set to a multichannel listening mode (see *Listening in surround sound* on page 27 if you need to do this) if you want multichannel surround sound.

<sup>4</sup> Phase matching is a very important factor in achieving proper sound reproduction. If two waveforms are 'in phase', they crest and trough together, resulting in increased amplitude, clarity and presence of the sound signal. If a crest of a wave meets a trough (as shown in the upper section of the diagram above) then the sound will be 'out of phase' and an unreliable sound image will be produced.

## Better sound using Phase Control

This receiver's Phase Control feature uses phase correction measures to make sure your sound source arrives at the listening position in phase, preventing unwanted distortion and/or coloring of the sound (see illustration below).

### PHASE CONTROL OFF

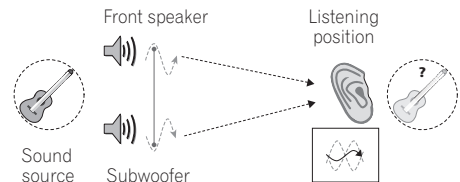

### PHASE CONTROL ON

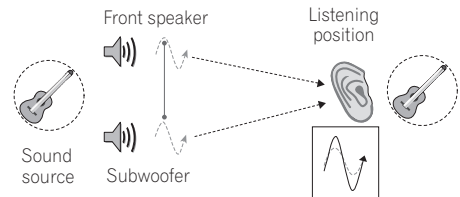

Phase Control technology provides coherent sound reproduction through the use of phase matching<sup>4</sup> for an optimal sound image at your listening position. The default setting is on and we recommend leaving Phase Control switched on for all sound sources.

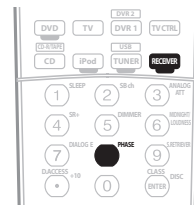

- Press **RECEIVER** then **PHASE (PHASE CONTROL)** to switch on phase correction.

The **PHASE CONTROL** indicator on the front panel lights.

Chapter 3:

# Connecting your equipment

This receiver provides you with many connection possibilities, but it doesn't have to be difficult. This page explains the kinds of components you can connect to make up your home theater system.

## Rear panel

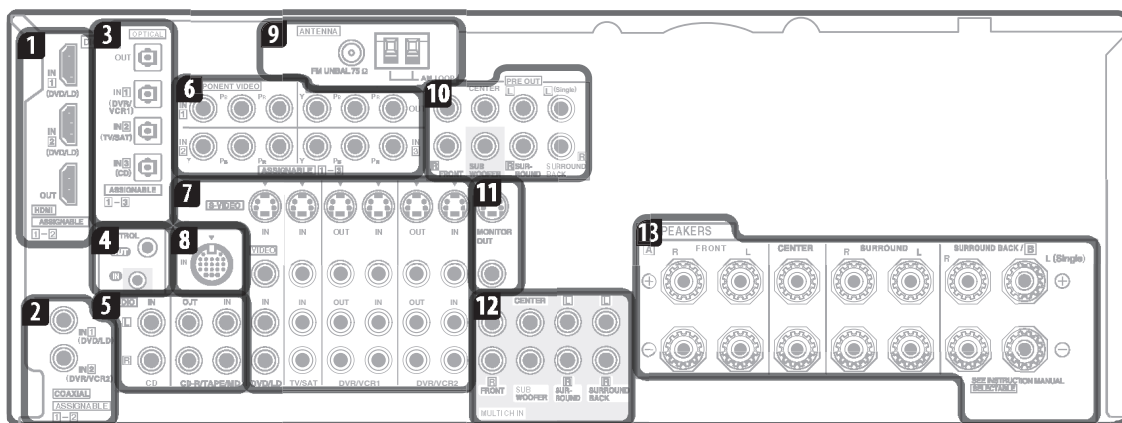

**Caution**

- Before making or changing the connections, switch off the power and disconnect the power cord from the power outlet. Plugging in should be the final step.

**1 HDMI connectors (x3)**

Two inputs and one output for high-quality audio/video connection to compatible HDMI devices.

→ *Connecting the multichannel analog inputs on page 47.*

**2 Coaxial digital audio inputs (x2)**

Use for digital audio sources, including DVD players/recorders, digital satellite receivers, CD players, etc.

→ See also *The Input Assign menu* on page 52 to assign the inputs.

**3 Optical digital audio output/input(s) (4)**

Use the **OUT** jack for recording to a CD or MiniDisc recorder.

→ *Connecting digital audio sources on page 16.*

Use the **IN** jacks for digital audio sources, including DVD players/recorders, digital satellite receivers, CD players, etc.

→ See also *The Input Assign menu* on page 52 to assign the inputs.

**4 Control input/output**

Use to connect other Pioneer components so that you can control all your equipment from a single IR remote sensor.

→ *Operating other Pioneer components with this unit's sensor on page 61.*

**5 Stereo analog audio source inputs/outputs (x3)**

Use for connection to audio sources such as CD players, tape decks, turntables, etc.

→ *Connecting analog audio sources on page 17.*

**6 Component video connections (x4)**

Use the inputs to connect any video source that has component video output, such as a DVD recorder. Use the output for connection to a monitor or TV.

→ *Using the component video jacks on page 14.*

**7 Audio/video source inputs/outputs (x6)**

Use for connection to audio/visual sources, such as DVD players/recorders, VCRs, etc. Each set of inputs has jacks for composite video, S-video and stereo analog audio.

→ *Connecting a DVD/HDD recorder, VCR and other video sources on page 14.*

**8 iPod input terminal**

Use to connect your Apple iPod as an audio source.

→ *Connecting an iPod on page 46.*

**9 AM and FM antenna terminals**

Use to connect indoor or outdoor antennas for radio broadcasts.

→ *Connecting antennas on page 20.*

### 10 Multichannel pre-amplifier outputs

Use to connect separate amplifiers for front, center, surround, surround back and subwoofer channels.

→ *Connecting additional amplifiers* on page 49 (see also *Installing your speaker system* on page 18 for powered subwoofer connection).

### 11 Composite and S-video monitor outputs

Use to connect monitors and TVs.

→ *Connecting your TV and DVD player* on page 13.

### 12 Multichannel analog audio inputs

7.1 channel inputs for connection to a DVD player with multichannel analog outputs.

→ *Connecting the multichannel analog inputs* on page 47.

### 13 Speaker terminals

Use for connection to the main front, center, surround and surround back speakers.

→ *Installing your speaker system* on page 18.

## When making cable connections

- To avoid hum, do not lay connected cables over the top of the receiver.

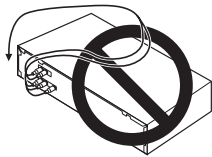

- When connecting optical cables, be careful when inserting the plug not to damage the shutter protecting the optical socket.

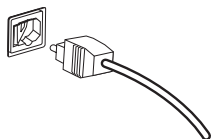

- When storing optical cable, coil loosely. The cable may be damaged if bent around sharp corners.

## About the video converter

When the video converter is enabled, all analog video sources are output through all of the **MONITOR VIDEO OUT** jacks (HDMI and component video cannot be converted).<sup>1</sup> See *Video Converter Setup* on page 54 to switch the video converter on or off.

If several video components are assigned to the same input function (see *The Input Assign menu* on page 52), the converter gives priority to component, S-video, then composite (in that order).

- For optimal video performance, THX recommends switching video conversion (in *Video Converter Setup* on page 54) **OFF**.

*This product incorporates copyright protection technology that is protected by U.S. patents and other intellectual property rights. Use of this copyright protection technology must be authorized by Macrovision Corporation, and is intended for home and other limited consumer uses only unless otherwise authorized by Macrovision. Reverse engineering or disassembly is prohibited.*

### Note

<sup>1</sup> You must connect your monitor/TV to the receiver's HDMI/component video outputs when connecting these video sources. If the video signal does not appear on your TV or plasma display, try adjusting the resolution settings on your component or display. Note that some components (such as video game units) have resolutions that may not be converted. In this case, use an (analog) S-video or composite connection.

## Connecting your TV and DVD player

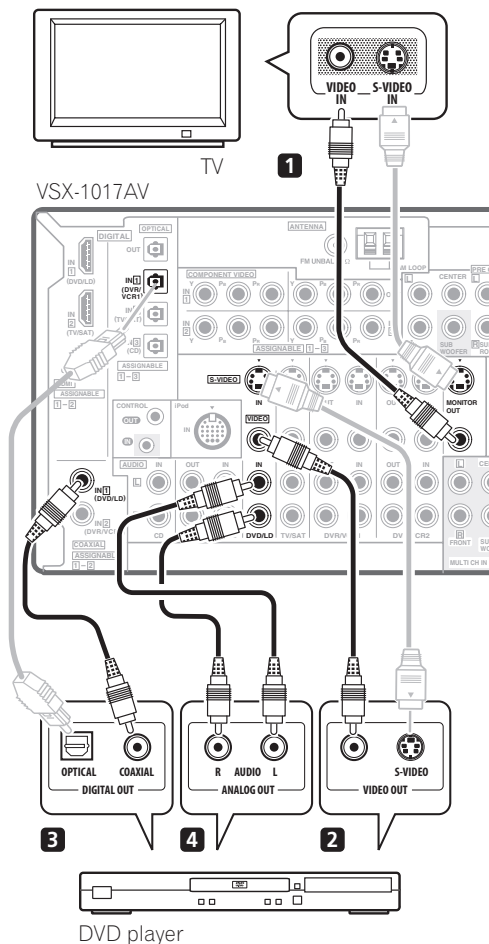

The diagram shows a basic setup of this receiver together with a TV and DVD player, with S-video or composite video connections. Different TVs and DVD players may offer alternative connections. See also *Using the component video jacks* on page 14 if your TV and/or DVD player has component video inputs/outputs. If your DVD player offers multichannel analog audio outputs, see *Connecting the multichannel analog inputs* on page 47.

### 1 Connect the MONITOR OUT video jack to a video input on your TV.

Use a standard RCA/phono jack video cable to connect to the composite video jack, or for higher quality video, use an S-video cable to connect to the S-video jack.

### 2 Connect a composite or S-video output on your DVD player to the DVD/LD VIDEO or DVD/LD S-VIDEO input.

Connect using a standard video cable or an S-video cable.

### 3 Connect a coaxial-type<sup>1</sup> digital audio output on your DVD player to the COAXIAL 1 (DVD/LD) input. Use a coaxial cable designed for digital audio.

### 4 Connect the stereo audio outputs on your DVD player to the DVD/LD AUDIO inputs.

Connect using a stereo RCA/phono jack cable.

- If your DVD player has multichannel analog outputs, you can connect these instead. See also *Connecting the multichannel analog inputs* on page 47.

## Connecting a satellite/cable receiver or other set-top box

Satellite and cable receivers, and terrestrial digital TV tuners are all examples of so-called 'set-top boxes'.

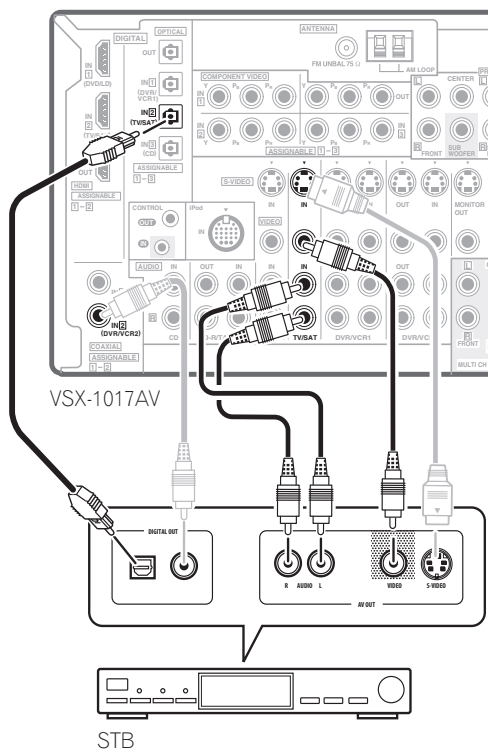

### Note

<sup>1</sup> If your DVD player only has an optical digital output, you can connect it to one of the optical inputs on this receiver using an optical cable. When you set up the receiver you'll need to tell the receiver which input you connected the player to (see *The Input Assign menu* on page 52).

**1 Connect the audio/video outputs on the set-top box to the TV/SAT AUDIO and VIDEO inputs.**

Connect using a stereo RCA/phono jack cable and a video or S-video cable.

**2 Connect an optical-type<sup>1</sup> digital audio output from your set-top box to the OPTICAL 2 (TV/SAT) input.<sup>2</sup>**

Use an optical cable for the connection.

## Connecting a DVD/HDD recorder, VCR and other video sources

This receiver has two sets of audio/video inputs and outputs suitable for connecting analog or digital video devices, including DVD/HDD recorders and VCRs.

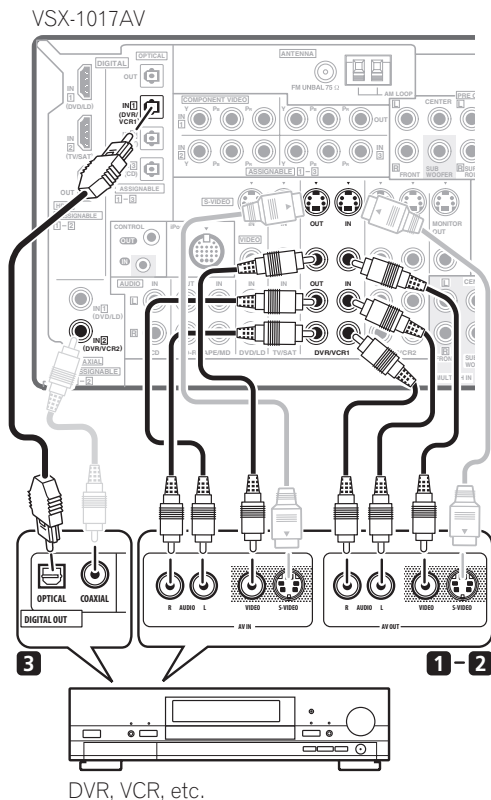

DVR, VCR, etc.

**1 Connect the audio/video outputs of the video player/recorder to the DVR/VCR1 AUDIO and VIDEO inputs.**

Use a stereo RCA/phono jack audio cable for the audio connection and a video or S-video cable for the video connection.

- For a second recorder, use the **DVR/VCR2 IN** inputs.

**2 If the device can record, connect the DVR/VCR1 AUDIO and VIDEO outputs to the recorder's audio/video inputs.**

Use a stereo RCA/phono jack audio cable for the audio connection and a video or S-video cable for the video connection.

- For a second recorder, use the **DVR/VCR2** outputs.

**3 If the device can output digital audio, connect an optical-type<sup>3</sup> digital audio output from the recorder to the OPTICAL 1 (DVR/VCR1) input.**

Use an optical cable for the connection.<sup>4</sup>

- For a second recorder, use the **COAXIAL 2 (DVR/VCR2)** inputs.

## Using the component video jacks

Component video should give superior picture quality when compared to composite or S-video. You can also take advantage of progressive scan video (if your source and TV are both compatible), which delivers a very stable, flicker-free picture. See the manuals that came with your TV and source component to check whether they are compatible with progressive-scan video.

### Note

1 If your set-top box only has a coaxial digital output, you can connect it to one of the coaxial inputs on this receiver using a coaxial digital audio cable. When you set up the receiver you'll need to tell the receiver which input you connected the set-top box to (see *The Input Assign menu* on page 52).

2 If your satellite/cable receiver doesn't have a digital audio output, you can skip this step.

3 • In order to record, you must connect the analog audio cables (the digital connection is for playback only).

- If your video component doesn't have a digital audio output, you can skip this step.

4 If your recorder only has a coaxial digital output, you can connect it to one of the coaxial inputs on this receiver using a coaxial digital audio cable. When you set up the receiver you'll need to tell the receiver which input you connected the recorder to (see also *The Input Assign menu* on page 52).



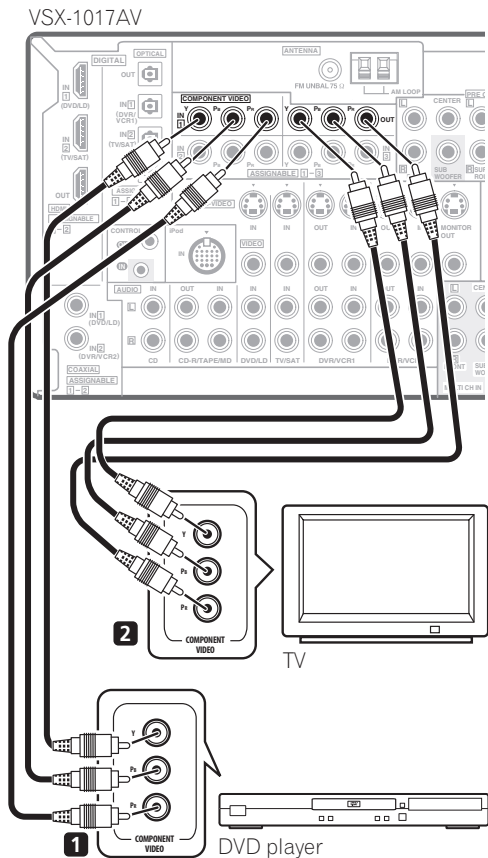

**1 Connect the component video outputs of your source to a set of ASSIGNABLE COMPONENT VIDEO inputs.**

Connect using a three-way component video cable.

- Since they are assignable, it doesn't matter which component video inputs you use for which source. After connecting everything, you'll need to assign the component video inputs—see *The Input Assign menu* on page 52.

**2 Connect the COMPONENT VIDEO OUT jacks to the component video inputs on your TV or monitor.**

Use a three-way component video cable.

The HDMI connection transfers uncompressed digital video, as well as almost every kind of digital audio that the connected component is compatible with, including DVD-Video, DVD-Audio (see below for limitations), Video CD/Super VCD, CD and MP3.

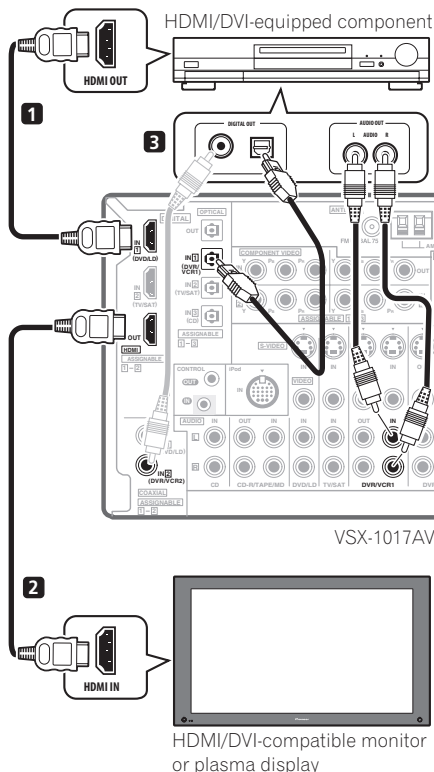

**1 Use an HDMI cable to connect the HDMI IN 1/2 interconnect on this receiver to an HDMI output on your HDMI component.**

**2 Use an HDMI cable to connect the HDMI OUT interconnect on this receiver to an HDMI interconnect on an HDMI-compatible monitor.<sup>1</sup>**

- The arrow on the cable connector body should be facing right for correct alignment with the connector on the player.

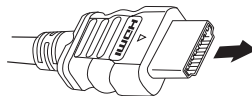

## Connecting using HDMI

If you have an HDMI or DVI (with HDCP) equipped component, you can connect it to this receiver using a commercially available HDMI cable.

**Note**

- To see the on-screen display, you must also connect your TV to this receiver with a composite video, component video or S-video cable.
- For optimum performance, the output settings for an HDMI component (screen resolution, the DeepColor feature, etc.) should be coincided with the ones that an HDMI-compatible monitor connected adopts.

### 3 To hear audio from your HDMI component through this system, make analog and/or digital connections as necessary.

On the rear panel, you must connect to the audio jacks from a set of audio/video inputs (for example, **DVR/VCR1** or **DVR/VCR2** as shown in the illustration).

- Without this connection, HDMI audio will still be output from your TV or plasma display (though no sound will be heard from this receiver).

### 4 Assign the HDMI input(s) you connected to the corresponding input source.

If the connected HDMI component is different from the default settings for the HDMI input terminals of this receiver, you need to change the settings specified in *Assigning the HDMI inputs* on page 53.

### 5 Use the input source buttons to select the input source you assigned in the previous step, then press **SIGNAL SEL** to select the audio input signal.

You can also use the front panel controls to do this (see *Choosing the input signal* on page 30).

- If the video signal does not appear on your TV or plasma display, try adjusting the resolution settings on your component or display. Note that some components (such as video game units) have resolutions that may not be displayed. In this case, use an (analog) S-video or composite connection.

## About HDMI

HDMI (High Definition Multimedia Interface) supports both video and audio on a single digital connection for use with DVD players, DTV, set-top boxes, and other AV devices. HDMI was developed to provide the technologies of High Bandwidth Digital Content Protection (HDCP) as well as Digital Visual Interface (DVI) in one specification. HDCP is used to protect digital content transmitted and received by DVI-compliant displays.

HDMI has the capability to support standard, enhanced, or high-definition video plus standard to multi-channel surround-sound audio. HDMI features include uncompressed digital video, a bandwidth of up to 2.2 gigabytes per second (with HDTV signals), one connector (instead of several cables and connectors), and communication between the AV source and AV devices such as DTVs.

*HDMI, the **HDMI** logo and High-Definition Multimedia Interface are trademarks or registered trademarks of HDMI licensing LLC.*

#### Note

- If your digital component only has a coaxial digital output, you can connect it to one of the coaxial inputs on this receiver using a coaxial cable. When you set up the receiver you'll need to tell the receiver which input you connected the component to (see also *The Input Assign menu* on page 52).
  - The digital outputs from other components can be connected to any spare digital audio inputs on this receiver. You can assign them when setting up the receiver (see also *The Input Assign menu* on page 52).
- 2 In order to record some digital sources, you must make analog connections as explained in *Connecting analog audio sources* below.

## Connecting digital audio sources

This receiver has both digital inputs and outputs, allowing you to connect digital audio components for playback and for making digital recordings.

Most digital components also have analog connections. See *Connecting analog audio sources* on the following page if you want to connect these too.

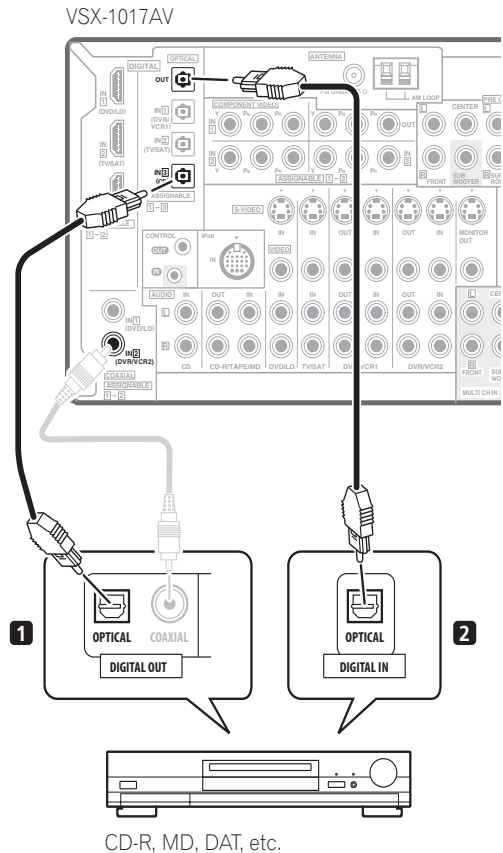

**1** Connect an optical-type<sup>1</sup> digital audio output on your digital component to the **DIGITAL 3 (CD)** input. Use an optical cable for the connection.

**2** For recording equipment, connect the optical-type **DIGITAL** output to a digital input on the recorder. Use an optical cable to connect to the **DIGITAL OUT**.<sup>2</sup>



## About the WMA9 Pro decoder

This unit has an on-board Windows Media™ Audio 9 Professional<sup>1</sup> (WMA9 Pro) decoder, so it is possible to playback WMA9 Pro-encoded audio using a coaxial or optical digital connection when connected to a WMA9 Pro-compatible player. However, the connected PC, DVD player, set-top box, etc. must be able to output WMA9 Pro format audio signals through a coaxial or optical digital output.

## Connecting analog audio sources

This receiver features two stereo audio-only inputs. One of these inputs (**CD-R/TAPE/MD**) has corresponding outputs for use with audio recorders.

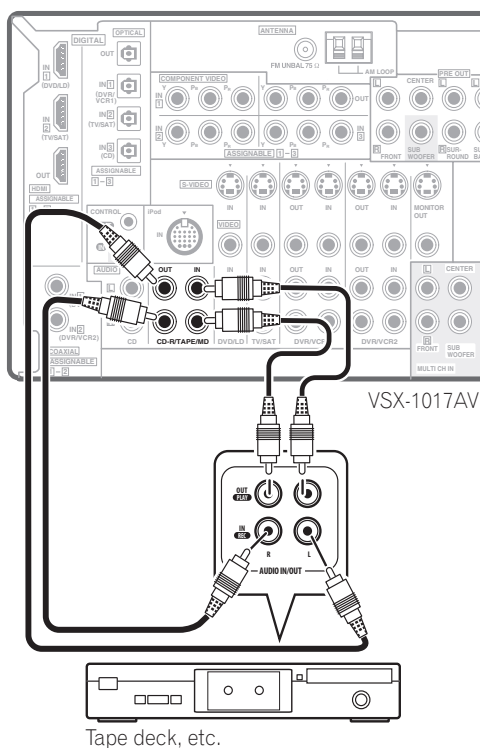

Tape deck, etc.

- **Connect the analog audio outputs of the source component to one of the AUDIO inputs.**

Connect using a stereo RCA/phono jack audio cable.

- If you're connecting a tape deck, MD recorder, etc., connect the analog audio outputs (**OUT**) to the analog audio inputs on the recorder.

## Connecting a component to the front panel inputs

The front panel inputs comprise a composite video jack (**VIDEO**), an S-video jack (**S-VIDEO**), stereo analog audio inputs (**AUDIO L/R**) and an optical digital audio input (**DIGITAL**). You can use these connections for any kind of audio/video component, but they are especially convenient for portable equipment such as camcorders, video games and portable audio/video equipment.

- Push down on the **PUSH OPEN** tab to access the front video connections.

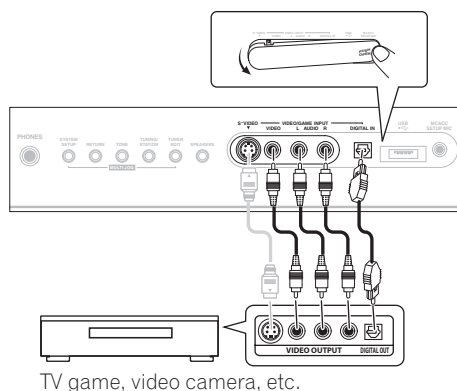

TV game, video camera, etc.

- Select these inputs by pressing **VIDEO/GAME** or using **INPUT SELECT** (remote) to select **VIDEO/GAME**.

### Note

- Windows Media™ and the Windows logo are trademarks, or registered trademarks of Microsoft Corporation in the United States and/or other countries.
- With WMA9 Pro, sound problems may occur depending on your computer system. Note that WMA9 Pro 96 kHz sources will be downsampled to 48 kHz.

## Installing your speaker system

To take full advantage of the receiver's surround sound capabilities connect front, center, surround and surround back speakers, as well as a subwoofer. Although this is ideal, other configurations with fewer speakers—no subwoofer or no center speaker, or even no surround speakers—will work. At the very least, front left and right speakers only are necessary. Note that your

main surround speakers should always be connected as a pair, but you can connect just one surround back speaker if you like (it must be connected to the left surround back terminal). You can use speakers with a nominal impedance between  $6\ \Omega$  to  $16\ \Omega$  (please see *Switching the speaker impedance* on page 56 if you plan to use speakers with an impedance of less than  $8\ \Omega$ ).

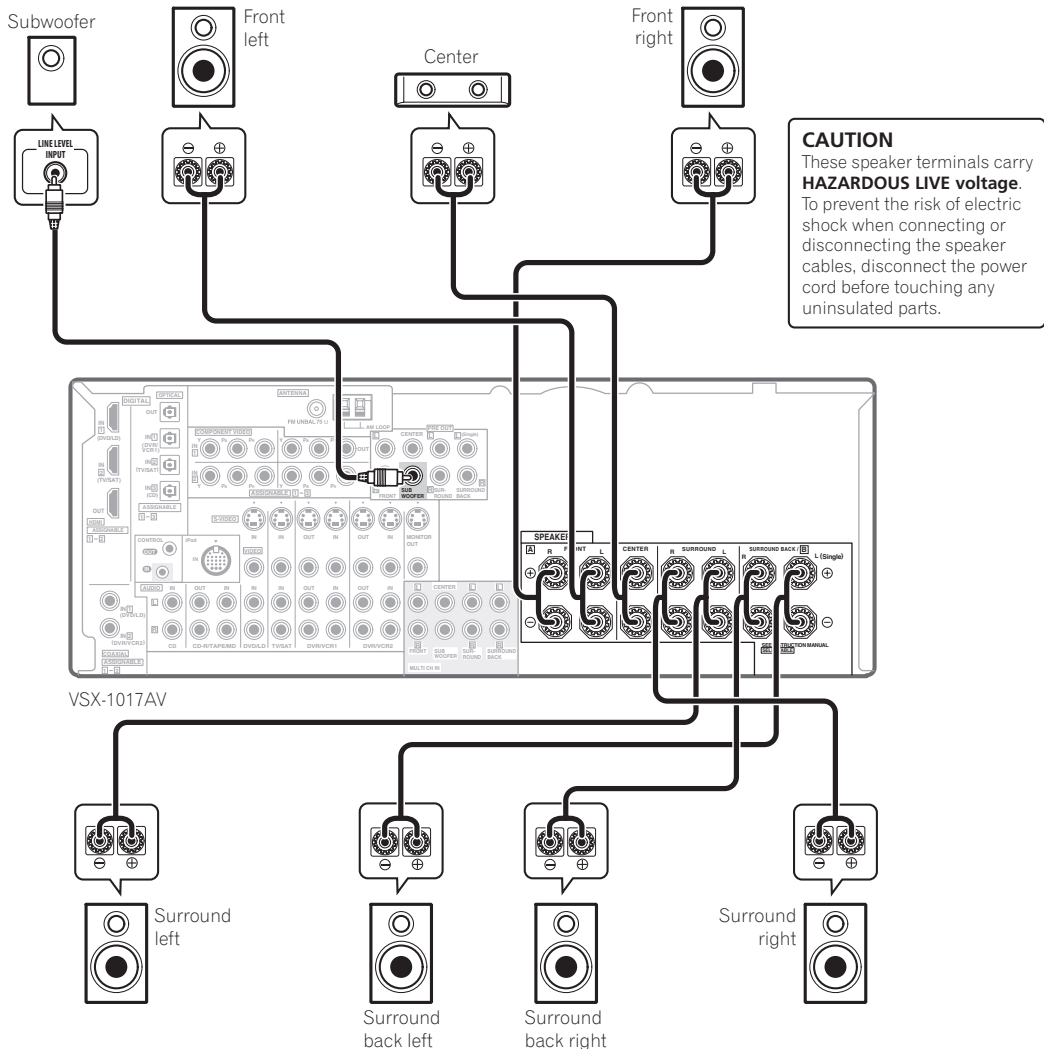

## Connecting the speakers

Each speaker connection on the receiver comprises a positive (+) and negative (–) terminal. Make sure to match these up with the terminals on the speakers themselves.

### Caution

- Make sure that all the bare speaker wire is twisted together and inserted fully into the speaker terminal. If any of the bare speaker wire touches the back panel it may cause the power to cut off as a safety measure.

## Bare wire connections

Make sure that the speaker cable you're going to use is properly prepared with about 10 mm of insulator stripped from each wire, and the exposed wire strands twisted together (fig. A).

To connect a terminal, unscrew the terminal a few turns until there is enough space to insert the exposed wire (fig. B). Once the wire is in position, tighten the terminal until the wire is firmly clamped (fig. C).

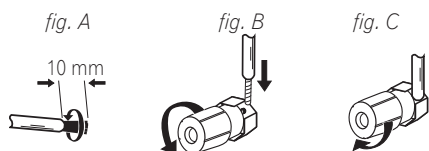

### Important

- Please refer to the manual that came with your speakers for details on how to connect the other end of the speaker cables to your speakers.
- *Other connections* on page 46 provides greater detail on alternate speaker setups, such as using speaker system B (page 48), bi-amping (page 48) and bi-wiring (page 49).
- If you are using a THX certified subwoofer use the **THX INPUT** jack on the subwoofer (if your subwoofer has one) or switch the filter position to **THX** on your subwoofer.

## Placing the speakers

Where you put your speakers in the room has a big effect on the quality of the sound. The following guidelines should help you to get the best sound from your system.

- The subwoofer can be placed on the floor. Ideally, the other speakers should be at about ear-level when you're listening to them. Putting the speakers on the floor (except the subwoofer), or mounting them very high on a wall is not recommended.
- For the best stereo effect, place the front speakers 2 m to 3 m apart, at equal distance from the TV.
- When placing speakers near the TV, we recommend using magnetically shielded speakers to prevent possible interference, such as discoloration of the picture when the TV is switched on. If you do not have magnetically shielded speakers and notice discoloration of the TV picture, move the speakers farther away from the TV.
- If you're using a center speaker, place the front speakers at a wider angle. If not, place them at a narrower angle.

- Place the center speaker above or below the TV so that the sound of the center channel is localized at the TV screen. Also, make sure the center speaker does not cross the line formed by the leading edge of the front left and right speakers.
- It is best to angle the speakers towards the listening position. The angle depends on the size of the room. Use less of an angle for bigger rooms.
- Surround and surround back speakers should be positioned 60 cm to 90 cm higher than your ears and titled slight downward. Make sure the speakers don't face each other. For DVD-Audio, the speakers should be more directly behind the listener than for home theater playback.
- Try not to place the surround speakers farther away from the listening position than the front and center speakers. Doing so can weaken the surround sound effect.
- To achieve the best possible surround sound, install your speakers as shown below. Be sure all speakers are installed securely to prevent accidents and improve sound quality.

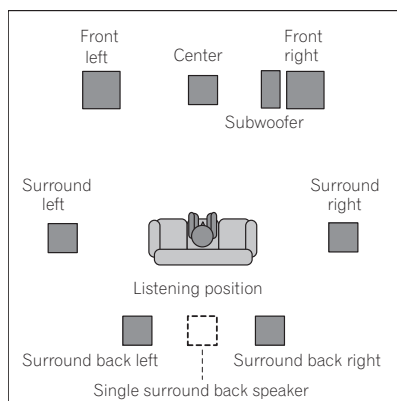

### Caution

- Make sure that all speakers are securely installed. This not only improves sound quality, but also reduces the risk of damage or injury resulting from speakers being knocked over or falling in the event of external shocks such as earthquakes.

The diagrams below show suggested surround and surround back speaker orientation. The first diagram (*fig. A*) shows orientation with one surround back speaker (or none) connected. The second (*fig. B*) shows orientation with two surround back speakers connected.

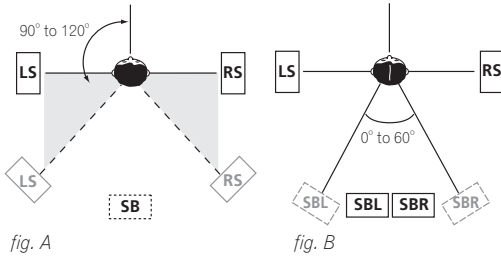

- If you have two surround back speakers THX recommends placing them together and the same distance from your listening position (see below).

### THX speaker system setup

If you have a complete THX speaker system, follow the diagram below to place your speakers. Note that the surround speakers (⊠ indicates bi-polar radiating speakers) should output at an angle parallel to the listener.

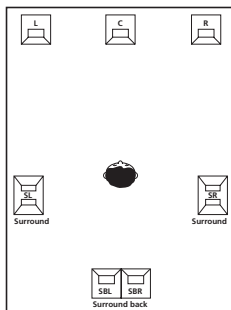

- If you have two surround back speakers THX recommends placing them together and the same distance from your listening position for the following THX modes: **THX Select2 CINEMA**, **THX MUSICMODE** and **THX GAMES MODE**.

See also *THX Audio Setting* on page 45 to make the settings that will give you the best sound experience when using the Home THX modes (page 28).

## Connecting antennas

Connect the AM loop antenna and the FM wire antenna as shown below. To improve reception and sound quality, connect external antennas (see *Connecting external antennas* below).

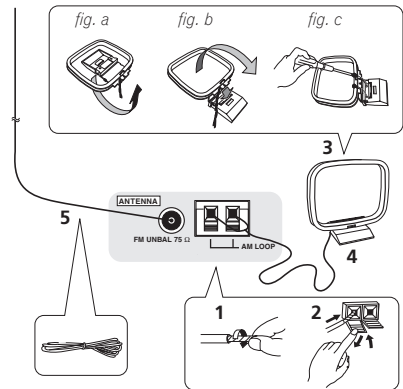

- 1 Pull off the protective shields of both AM antenna wires.**
- 2 Push open the tabs, then insert one wire fully into each terminal, then release the tabs to secure the AM antenna wires.**
- 3 Fix the AM loop antenna to the attached stand.**  
To fix the stand to the antenna, bend in the direction indicated by the arrow (*fig. a*) then clip the loop onto the stand (*fig. b*).
- 4 Place the AM antenna on a flat surface and in a direction giving the best reception.**
- 5 Connect the FM wire antenna in the same way as the AM loop antenna.**

For best results, extend the FM antenna fully and fix to a wall or door frame. Don't drape loosely or leave coiled up.

## Connecting external antennas

To improve FM reception connect an external FM antenna to the **FM UNBAL 75 Ω** terminal.

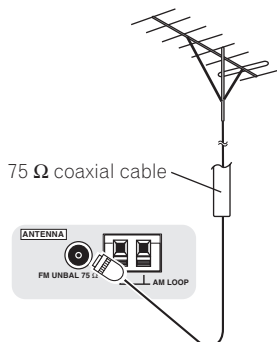

To improve AM reception, connect a 5 m to 6 m length of vinyl-coated wire to the **AM LOOP** terminals without disconnecting the supplied AM loop antenna.

For the best possible reception, suspend horizontally outdoors.

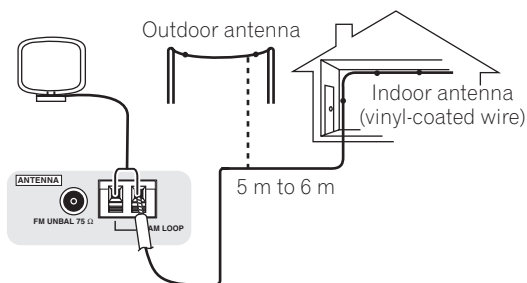

## Plugging in the receiver

Only plug in after you have connected all your components to this receiver, including the speakers.

### ⚠ Caution

- Handle the power cord by the plug part. Do not pull out the plug by tugging the cord, and never touch the power cord when your hands are wet, as this could cause a short circuit or electric shock. Do not place the unit, a piece of furniture, or other object on the power cord or pinch the cord in any other way. Never make a knot in the cord or tie it with other cables. The power cords should be routed so that they are not likely to be stepped on. A damaged power cord can cause a fire or give you an electric shock. Check the power cord once in a while. If you find it damaged, ask your nearest Pioneer authorized independent service company for a replacement.
- The receiver should be disconnected by removing the mains plug from the wall socket when not in regular use, e.g., when on vacation.
- Make sure the blue **⏻ STANDBY/ON** light has gone out before unplugging.
- **Plug the power cord into a power outlet.**

## Chapter 4: Controls and displays

### Front panel

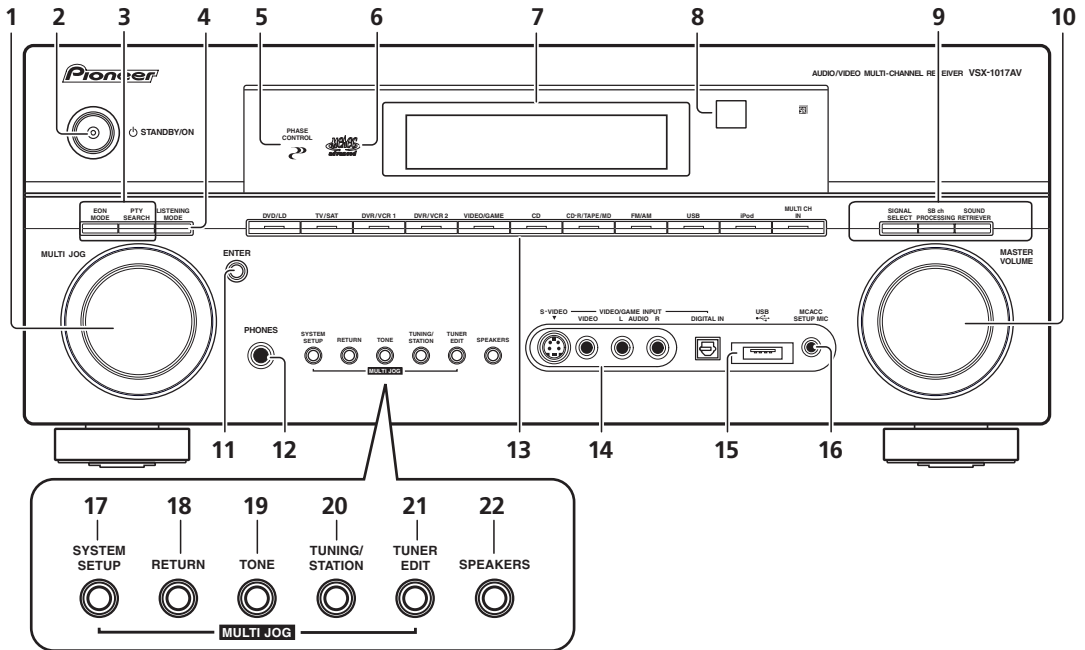

#### 1 MULTI JOG dial

Use the **MULTI JOG** dial to select various settings and menu options.

#### 2 **⏻** STANDBY/ON

Switches the receiver between on and standby. Power indicator lights when the receiver is on.

#### 3 EON MODE

Use to search for programs that are broadcasting traffic or news information (page 37).

#### PTY SEARCH

Use this button to search for RDS program types (page 36).

#### 4 LISTENING MODE

Use with the **MULTI JOG** dial to select the various listening modes (page 27).

#### 5 PHASE CONTROL indicator

Lights when Phase Control is switched on (page 10).

#### 6 MCACC indicator

Lights when Acoustic Calibration EQ (page 40) is on (Acoustic Calibration EQ is automatically set to on after the Auto MCACC Setup (page 8) or Advanced EQ Setup (page 40)).

#### 7 Character display

See *Display* on page 24.

#### 8 Remote sensor

Receives the signals from the remote control (see *Operating range of remote control unit* on page 23).

#### 9 SIGNAL SELECT

Use to select an input signal (page 30).

**SB ch PROCESSING** – Selects the surround back channel mode (page 30) or virtual surround back mode (page 31).

**SOUND RETRIEVER** – Press to restore CD quality sound to compressed audio sources (page 32).

#### 10 MASTER VOLUME dial

#### 11 ENTER

17

SYSTEM  
SETUP

18

RETURN

19

TONE

20

TUNING/  
STATION

21

TUNER  
EDIT

22

SPEAKERS

MULTI JOG

### 12 PHONES jack

Use to connect headphones. When the headphones are connected, there is no sound output from the speakers.

### 13 Input source buttons

Press to select an input source.

### 14 VIDEO/GAME INPUT

See *Connecting a component to the front panel inputs* on page 17.

### 15 USB interface

Connect a USB audio device for playback (see *Using the USB interface* on page 33).

### 16 MCACC SETUP MIC jack

Use to connect the supplied microphone.

### 17 SYSTEM SETUP

Press to access the System Setup menu (see page 38).

### 18 RETURN

Press to confirm and exit the current menu screen.

### 19 TONE

Press this button to access the bass and treble controls, which you can then adjust with the **MULTI JOG** dial (page 32).

### 20 TUNING/STATION

Use to find radio frequencies and to select preset stations (page 35).

### 21 TUNER EDIT

Use with the **MULTI JOG** dial to memorize and name stations for recall (page 35).

### 22 SPEAKERS

Use to change the speaker system (page 48).

### Operating range of remote control unit

The remote control may not work properly if:

- There are obstacles between the remote control and the receiver's remote sensor.
- Direct sunlight or fluorescent light is shining onto the remote sensor.
- The receiver is located near a device that is emitting infrared rays.
- The receiver is operated simultaneously with another infrared remote control unit.

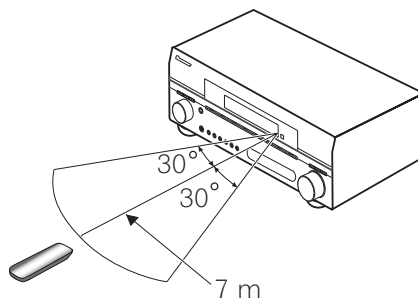

## Display

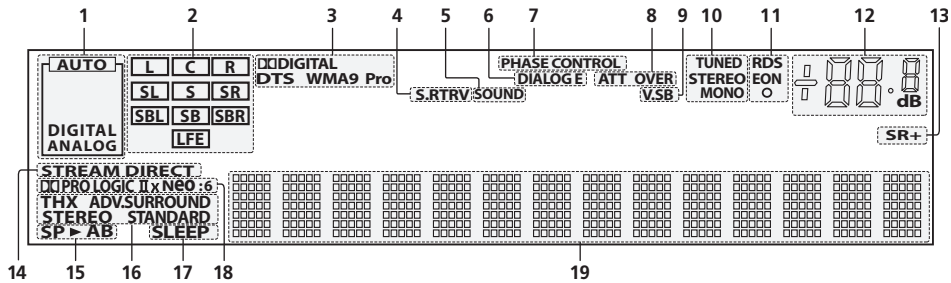

### 1 SIGNAL indicators

Light to indicate the currently selected input signal.

**AUTO** lights when the receiver is set to select the input signal automatically (page 30).

### 2 Program format indicators

These change according to which channels are active in digital sources.

- L** – Left front channel
- C** – Center channel
- R** – Right front channel
- SL** – Left surround channel
- S** – Surround channel (mono)
- SR** – Right surround channel
- SBL** – Left surround back channel
- SB** – Surround back channel (mono)
- SBR** – Right surround back channel
- LFE** – Low frequency effects channel

### 3 Digital format indicators

Light when a signal encoded in the corresponding format is detected.

### 4 S.RTRV

Lights when the Sound Retriever is switched on (page 32).

### 5 SOUND

Lights when any of the Midnight, Loudness or tone controls feature is selected (page 32).

### 6 DIALOG E

Lights when the Dialog Enhancement feature is switched on.

### 7 PHASE CONTROL

Lights when the Phase Control is switched on (page 10).

### 8 OVER / ATT

**OVER** lights to indicate that the level of an analog source is too high. **ATT** lights when you use the attenuator (**ANALOG ATT**) to reduce it.

### 9 V.SB

Lights during Virtual surround back processing (page 31).

### 10 TUNER indicators

**TUNED** – Lights when a broadcast is being received.

**STEREO** – Lights when a stereo FM broadcast is being received in auto stereo mode.

**MONO** – Lights when the mono mode is set using the **MPX** button.

### 11 EON / RDS indicators

**EON** – Lights when the EON mode is set (flashes during EON reception). The **O** indicator lights when the current station carries the EON service (page 37).

**RDS** – Lights when an RDS broadcast is received (page 36).

### 12 Master volume level

### 13 SR+

Lights when the SR+ mode is switched on (page 51).

### 14 STREAM DIRECT

Lights when the Stream Direct mode is selected (page 30).

### 15 Speaker indicators

Indicate the current speaker system, **A** and/or **B** (page 48).

### 16 Listening mode indicators

**THX** – Lights when a Home THX mode is selected.

**ADV.SURROUND** – Lights when an Advanced Surround mode has been selected (page 28).

**STEREO** – Lights when the stereo mode is selected (page 29).

**STANDARD** – Lights when a Standard Surround mode is switched on (see *Listening in surround sound* on page 27).

### 17 SLEEP

Lights when the receiver is in sleep mode (page 55).

### 18 Matrix decoding format indicators

**PRO LOGIC IIx** – This lights to indicate **PRO** Pro Logic II / **IIx** Pro Logic IIx decoding (page 27).

**Neo:6** – When one of the Neo:6 modes of the receiver is on, this lights to indicate Neo:6 processing (page 27).

### 19 Character display

Displays various system information.





## 7 TV CONTROL buttons

These buttons are dedicated to control the TV assigned to the **TV CTRL** button. Thus if you only have one TV to hook up to this system assign it to the **TV CTRL** input source button. If you have two TVs, assign the main TV to the **TV CTRL** button (see page 57 for more on this).



**TV**  – Use to turn on/off the power of the TV.

**TV VOL +/-** – Use to adjust the volume on your TV.

**INPUT SELECT** – Use to select the TV input signal.

**TV CH +/-** – Use to select channels.

## 8 Component control buttons

The main buttons (, , etc.) are used to control a component after you have selected it using the input source buttons.

The controls above these buttons can be accessed after you have selected the corresponding input source button (for example **DVD**, **DVR1** or **TV**). The following controls can be accessed when listening to the built-in tuner:

**MPX** – Switches between stereo and mono reception of FM broadcasts. If the signal is weak then switching to mono will improve the sound quality (page 35).

**DISP** – Switches between named station presets and radio frequencies (page 36). Also used to display RDS information (page 36).

**EON** – Use to search for programs that are broadcasting traffic or news information (page 37).

## 9 Receiver controls

**THX** – Press to select a Home THX listening mode (page 28).

**STANDARD** – Press for Standard decoding and to switch between the various  Pro Logic IIx and Neo:6 options (page 27).

**ADV.SURR** – Use to switch between the various surround modes (page 28).

**STEREO/F.S.SURR** – Switches between the stereo playback mode (page 29) and the Front Stage Surround Advance mode (page 29).

**AUTO SURR** – Press to select the Auto Surround mode (page 27) or the Stream Direct mode (page 30). Stream Direct playback bypasses the tone controls and any other signal processing for the most accurate reproduction of a source (page 30).

**ACOUSTIC EQ** – Press to select an Acoustic Calibration EQ setting (page 30).

**SIGNAL SEL** – Use to select an input signal (page 30).

## 10 MULTI OPE

Use this button to perform multi operations (page 58).

## 11 SHIFT

Press to access the controls outlined in white boxes (for example, **INPUT SELECT** ) or to display the currently selected input source in the remote control LCD.

## 12 SOURCE

Press to turn on/off other components connected to the receiver (see page 57 for more on this).

## 13 Character display (LCD)

This display shows information when transmitting control signals.

The following commands are shown when you're setting the remote to control other components (see *Controlling the rest of your system* on page 57):

**SETUP** – Indicates the setup mode, from which you choose the options below.

**PRESET** – See *Selecting preset codes directly* on page 57.

**MULTI OP** – See *Multi Operation and System Off* on page 58.

**SYS OFF** – See *Multi Operation and System Off* on page 58.

**DIRECT F** – See *Direct function* on page 57.

**RESET** – See *Resetting the remote control presets* on page 57.

**READ ID** – See *Confirming preset codes* on page 57.

## 14 RECEIVER

Switches the remote to control the receiver (used to select the green commands above the number buttons (**ANALOG ATT**, etc.)). Also use this button to set up surround sound (page 8, page 38).

## 15 VOL +/-

Use to set the listening volume.

## 16 MUTE

Mutes the sound or restores the sound if it has been muted (adjusting the volume also restores the sound).

## 17 EFFECT/CH SEL and LEVEL +/-

Press repeatedly to select a channel, then use **+/-** to adjust the level (see *Tip* on page 44). Also adjusts the level of the Advanced Surround effects, the Dolby Pro Logic IIx Music and Neo:6 Music parameters and the sound delay setting (page 29). You can then use the **+/-** buttons to make these adjustments.

## Chapter 5:

## Listening to your system

 Important

- The listening modes and many features described in this section may not be available depending on the current source (for example, PCM 88.2 kHz/96 kHz, DTS 96 kHz (24 bit) or WMA9 Pro), settings and status of the receiver. See *Listening modes with different input signal formats* on page 69 for more on this.

 Tip

- The listening modes described below can also be selected using the front panel controls. Simply press **LISTENING MODE** repeatedly to access the modes you want, then use the **MULTI JOG** to select a particular listening mode (after five seconds the mode is automatically set).

## Auto playback

There are many ways to listen back to sources using this receiver, but for the simplest, most direct listening option is the Auto Surround feature. The receiver automatically detects what kind of source you're playing and selects multichannel or stereo playback as necessary.<sup>1</sup>

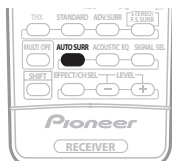

- While listening to a source, press **AUTO SURR** for auto playback of a source.<sup>2</sup>

**AUTO SURROUND** shows briefly in the display before showing the decoding or playback format. Check the digital format indicators in the front panel display to see how the source is being processed.

 Note

1 • Stereo surround (matrix) formats are decoded accordingly using **Neo:6 CINEMA** or **Pro Logic IIx MOVIE** (see *Listening in surround sound* above for more on these decoding formats).

• The Auto Surround feature is canceled if you connect headphones or select the multichannel analog inputs.

2 For more options using this button, see *Using Stream Direct* on page 30.

3 In modes that give 6.1 channel sound, the same signal is heard from both surround back speakers.

4 If surround back channel processing (page 30) is switched **OFF**, or the surround back speakers are set to **NO** (this happens automatically if the *Surround back speaker setting* on page 38 is set to anything but **Normal (SB)**), **Pro Logic IIx** becomes **Pro Logic II** (5.1 channel sound).

5 When listening to 2-channel sources in Dolby Pro Logic IIx Music mode, there are three further parameters you can adjust: Center Width, Dimension, and Panorama. See *Setting the effect options* on page 29 to adjust them.

6 When listening to 2-channel sources in Neo:6 Music mode, you can also adjust the center image effect (see *Setting the effect options* on page 29).

## Listening in surround sound

Using this receiver, you can listen to any source in surround sound. However, the options available will depend on your speaker setup and the type of source you're listening to.

If you connected surround back speakers, see also *Using surround back channel processing* on page 30.

## Standard surround sound

The following modes provide basic surround sound for stereo and multichannel sources.<sup>3</sup>

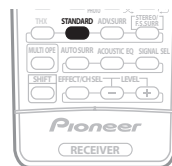

- While listening to a source, press **STANDARD**. If necessary, press repeatedly to select a listening mode.
  - If the source is Dolby Digital, DTS, or Dolby Surround encoded, the proper decoding format will automatically be selected and shows in the display.<sup>4</sup>

With two channel sources, you can select from:

- Pro Logic IIx MOVIE** – Up to 7.1 channel sound, especially suited to movie sources
- Pro Logic IIx MUSIC** – Up to 7.1 channel sound, especially suited to music sources<sup>5</sup>
- Pro Logic IIx GAME** – Up to 7.1 channel sound, especially suited to video games
- PRO LOGIC** – 4.1 channel surround sound (sound from the surround speakers is mono)
- Neo:6 CINEMA** – 6.1 channel sound, especially suited to movie sources
- Neo:6 MUSIC** – 6.1 channel sound, especially suited to music sources<sup>6</sup>

With multichannel sources, if you have connected surround back speaker(s) and have selected **SBch ON**, you can select (according to format):

- **Pro Logic IIx MOVIE** – See above (only available when you're using two surround back speakers)
- **Pro Logic IIx MUSIC** – See above
- **Dolby Digital EX** – Creates surround back channel sound for 5.1 channel sources and provides pure decoding for 6.1 channel sources (like Dolby Digital Surround EX)
- **DTS-ES** – Allows you to hear 6.1 channel playback with DTS-ES encoded sources
- **DTS Neo:6** – Allows you to hear 6.1 channel playback with DTS encoded sources

### Using the Home THX modes

THX and Home THX are technical standards created by THX Ltd. for cinema and home theater sound. Home THX is designed to make home theater audio sound more like what you hear in a cinema.

Different THX options will be available depending on the source and the setting for surround back channel processing (see *Using surround back channel processing* on page 30 for more on this).

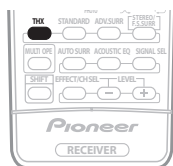

- **Press THX (HOME THX) to select a listening mode.**<sup>1</sup> With two channel sources, press **THX** repeatedly to select a matrix-decoding process for the **THX CINEMA** mode (see *Listening in surround sound* above for an explanation of each process):

- **Pro Logic IIx MOVIE+THX**
- **PRO LOGIC+THX**
- **Neo:6 CINEMA+THX**
- **THX GAMES MODE**

With multichannel sources, press **THX (HOME THX)** repeatedly to select from:<sup>2</sup>

- **THX CINEMA** – Gives you cinema-quality sound from your home theatre system using all the speakers in your setup
- **Pro Logic IIx MOVIE+THX** – Especially suited to movie sources, this allows you to hear 7.1 channel playback with 5.1 channel sources

- **THX Surround EX** – Allows you to hear 6.1 or 7.1 channel playback with 5.1 channel sources
- **THX Select2 CINEMA** – Allows you to hear 7.1 channel playback with 5.1 channel sources
- **THX MUSICMODE** – Allows you to hear 7.1 channel playback with 5.1 channel sources
- **THX GAMES MODE** – Allows you to hear 7.1 channel playback from the output of a video game console

### Using the Advanced surround effects

The Advanced surround effects can be used for a variety of additional surround sound effects. Most Advanced Surround modes are designed to be used with film soundtracks, but some modes are also suited for music sources. Try different settings with various soundtracks to see which you like.

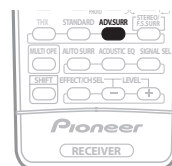

- **Press ADV.SURR repeatedly to select a listening mode.**<sup>3</sup>
- **ACTION** – Designed for action movies with dynamic soundtracks
- **DRAMA** – Designed for movies with lots of dialog
- **MONOFILM** – Creates surround sound from mono soundtracks
- **ENT. SHOW** – Suitable for musical sources
- **EXPANDED** – Creates an extra wide stereo field<sup>4</sup>
- **TV SURROUND** – Provides surround sound for both mono and stereo TV sources
- **ADVANCED GAME** – Suitable for video games
- **SPORTS** – Suitable for sports programs
- **ROCK/POP** – Creates a live concert sound for rock and/or pop music
- **UNPLUGGED** – Suitable for acoustic music sources
- **ExtendedSTEREO** – Gives multichannel sound to a stereo source, using all of your speakers
- **PhonesSurround** – Creates the effect of overall surround with headphones.

#### Note

<sup>1</sup> You can't use the THX modes when headphones are connected.

<sup>2</sup> If you only have one surround back speaker connected, **Pro Logic IIx MOVIE+THX**, **THX Select2 CINEMA**, **THX MUSICMODE** and **THX GAMES MODE** are not available.

<sup>3</sup> Depending on the source and the sound mode you have selected, you may not get sound from the surround back speakers in your setup. For more on this, refer to *Using surround back channel processing* on page 30.

• If you press **ADV.SURR** when the headphones are connected, the **PhonesSurround** mode will automatically be selected.

<sup>4</sup> Use with Dolby Pro Logic for a stereo surround effect (stereo field is wider than Standard modes with Dolby Digital sources).

## Setting the effect options

When using surround effects, there are a number of settings you can adjust.

### 1 Press EFFECT/CH SEL repeatedly to select the setting you want to adjust.

Depending on the current status / mode of the receiver, certain options may not appear. Check the table below for notes on this.

### 2 Use the LEVEL +/- buttons to set it as necessary.

See the table below for the options available for each setting. The defaults, if not stated, are listed in bold.

### 3 Press EFFECT/CH SEL again to adjust other settings.

Setting	What it does	Options
<b>Center Width<sup>a</sup></b> (Applicable only when using a center speaker)	Spreads the center channel between the front right and left speakers, making it sound wider (higher settings) or narrower (lower settings).	0 to 7 Default: <b>3</b>
<b>Dimension<sup>a</sup></b>	Adjusts the surround sound balance from front to back, making the sound more distant (minus settings), or more forward (positive settings).	-3 to +3 Default: <b>0</b>
<b>Panorama<sup>a</sup></b>	Extends the front stereo image to include surround speakers for a 'wraparound' effect.	<b>OFF</b>  ON
<b>Center Image<sup>b</sup></b> (Applicable only when using a center speaker)	Adjusts the center image to create a wider stereo effect with vocals. Adjust the effect from <b>0</b> (all center channel sent to front right and left speakers) to <b>10</b> (center channel sent to the center speaker only).	0 to 10 Default: <b>3</b>
<b>Effect</b>	Sets the effect level for the currently selected Advanced Surround mode (each mode can be set separately).	10 to 90
<b>Sound Delay</b>	Some monitors have a slight delay when showing video, so the soundtrack will be slightly out of sync with the picture. By adding a bit of delay, you can adjust the sound to match the presentation of the video.	<b>0.0</b> to 6.0 (frames) 1 second = 25 frames (PAL)

a. Only available with 2 ch sources in Dolby Pro Logic IIx Music/Dolby Pro Logic II Music mode.

b. Only available with 2 ch sources in Neo:6 Music mode.

## Listening in stereo

When you select **STEREO**, you will hear the source through just the front left and right speakers (and possibly your subwoofer depending on your speaker settings). Dolby Digital, DTS and WMA9 Pro multichannel sources are downmixed to stereo.

### Note

<sup>1</sup> When using **F.S.SURR WIDE**, a better effect can be obtained if Auto MCACC Setup is performed. For more on this, refer to *Automatically setting up for surround sound (Auto MCACC)* on page 8.

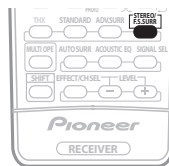

### • While listening to a source, press STEREO/F.S.SURR for stereo playback.

Press repeatedly to switch between:

- **STEREO** – The audio is heard with your surround settings and you can still use the Midnight, Loudness, and Tone functions.
- **F.S.SURR FOCUS** – See *Using Front Stage Surround Advance* below for more on this.
- **F.S.SURR WIDE** – See *Using Front Stage Surround Advance* below for more on this.

## Using Front Stage Surround Advance

The Front Stage Surround Advance function allows you to create natural surround sound effects using just the front speakers and the subwoofer.

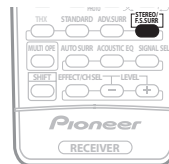

### • While listening to a source, press STEREO/F.S.SURR to select Front Stage Surround Advance modes.

- **STEREO** – See *Listening in stereo* above for more on this.
- **F.S.SURR FOCUS** – Use to provide a rich surround sound effect directed to the center of where the front left and right speakers sound projection area converges.
- **F.S.SURR WIDE** – Use to provide a surround sound effect to a wider area than **FOCUS** mode.<sup>1</sup>

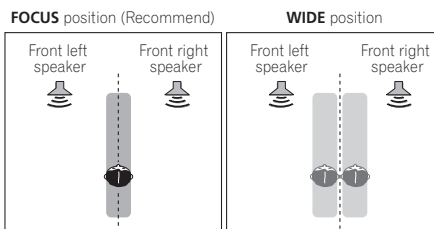

## Using Stream Direct

Use the Stream Direct modes when you want to hear the truest possible reproduction of a source. All unnecessary signal processing is bypassed.

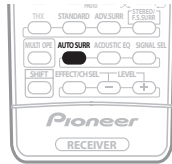

- While listening to a source, press **AUTO SURR** to select the Stream Direct mode.
- **AUTO SURROUND** – See *Auto playback* on page 27.
- **STREAM DIRECT** – Sources are heard according to the settings made in the Surround Setup (Speaker Setting, Channel Level, Speaker Distance), as well as with dual mono, Center Width, Dimension and Panorama settings. You will hear sources according to the number of channels in the signal. For analog sources, only Channel Level can be set. All other digital processing can not be set.

## Listening with Acoustic Calibration EQ

- Default setting: **OFF / ALL CH ADJUST** (after the Auto MCACC Setup or Advanced EQ Setup)

You can listen to sources using the Acoustic Calibration Equalization set in *Automatically setting up for surround sound (Auto MCACC)* on page 8 or *Professional Acoustic Calibration EQ* on page 40. Refer to these pages for more on Acoustic Calibration Equalization.

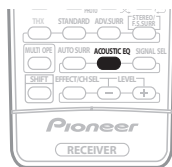

- While listening to a source, press **ACOUSTIC EQ**. Press repeatedly to select between:
  - **ALL CH ADJUST** – A 'flat' setting where all the speakers are heard individually.
  - **FRONT ALIGN** – All speakers are heard in accordance with the front speaker settings.<sup>1</sup>
  - **CUSTOM 1/2** – Custom settings

### Note

<sup>1</sup> When **TYPE2** is not selected in the Auto MCACC setup or the Advanced EQ setup in the Manual MCACC setup, the EQ value cannot be set for **FRONT ALIGN**.

<sup>2</sup> You can't use Acoustic Calibration EQ with **MULTI CH IN**, Stream Direct mode or WMA9 Pro, and it has no effect with headphones.

<sup>3</sup> This receiver can only play back Dolby Digital, PCM (32 kHz to 96 kHz), DTS (including DTS 96 kHz/24 bit) and WMA9 Pro digital signal formats. With other digital signal formats, set to **ANALOG** (the **MULTI CH IN**, **TUNER** and **USB** input functions are all fixed to **ANALOG**).

• You may get digital noise when a LD or CD player compatible with DTS is playing an analog signal. To prevent noise, make the proper digital connections (page 16) and set the signal input to **DIGITAL**.

• Some DVD players don't output DTS signals. For more details, refer to the instruction manual supplied with your DVD player.

- **EQ OFF** – Switches Acoustic Calibration EQ off.

The MCACC indicator on the front panel lights when Acoustic Calibration EQ is active.<sup>2</sup>

## Choosing the input signal

You need to hook up a component to both analog and digital inputs on the receiver to select between input signals.<sup>3</sup>

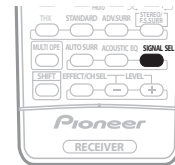

- Press **SIGNAL SEL (SIGNAL SELECT)** to select the input signal corresponding to the source component. Each press cycles through the options as follows:
  - **AUTO** – This is the default setting. The receiver selects the first available signal in the following order: **DIGITAL; ANALOG**.
  - **ANALOG** – Selects an analog signal.
  - **DIGITAL** – Selects an optical or coaxial digital signal.

When set to **DIGITAL** or **AUTO**, **DIGITAL** lights with Dolby Digital decoding, **DTS** lights with DTS decoding, and **WMA9 Pro** lights to indicate decoding of a WMA9 Pro signal.

## Using surround back channel processing

- Default setting: **SBCh ON**

You can have the receiver automatically use 6.1 or 7.1 decoding for 6.1 encoded sources (for example, Dolby Digital EX or DTS-ES), or you can choose to always use 6.1 or 7.1 decoding (for example, with 5.1 encoded material). With 5.1 encoded sources, a surround back channel will be generated, but the material may sound better in the 5.1 format for which it was originally encoded (in which case, you can simply switch surround back channel processing off).

The table below indicates when you will hear the surround back channel when playing various kinds of sources (●=Sound plays through surround back speaker(s)).



- Press **RECEIVER** then press **SB ch (SB ch PROCESSING)** repeatedly to cycle the surround back channel options.

Each press cycles through the options as follows:

- **SBch ON** – 6.1 or 7.1 decoding is always used (for example, a surround back channel will be generated for 5.1 encoded material)
- **SBch AUTO** – Automatically switches to 6.1 or 7.1 decoding for 6.1 encoded sources (for example, Dolby Digital EX or DTS-ES)
- **SBch OFF** – Maximum 5.1 playback

## Using the Virtual Surround Back mode

When you're not using surround back speakers, selecting this mode allows you to hear a virtual surround back channel through your surround speakers. You can choose to listen to sources with no surround back channel information, or if the material sounds better in the format (for example, 5.1) for which it was originally encoded, you can have the receiver only apply this effect to 6.1 encoded sources like Dolby Digital EX or DTS-ES.<sup>1</sup>

The table indicates when you will hear the virtual surround back channel (●=Virtual surround back channel is active).

- Press **RECEIVER** then press **SB ch (SB ch PROCESSING)** repeatedly to cycle the virtual surround back channel options.

Each press cycles through the options as follows:

- **VirtualSB ON** – Virtual Surround Back is always used (for example, on 5.1 encoded material)
- **VirtualSB AUTO** – Virtual Surround Back is automatically applied to 6.1 encoded sources (for example, Dolby Digital EX or DTS-ES)
- **VirtualSB OFF** – Virtual Surround Back mode is switched off

Type of source	SBch Processing / Virtual SB mode	Standard / THX			Advanced surround	
		Multichannel sources	Stereo sources			
			Dolby Pro Logic IIx	Dolby Pro Logic		Neo:6
Dolby Digital EX/DTS-ES/WMA9 Pro encoded multichannel sources with 6.1 ch surround	ON	●			● <sup>b</sup>	
	AUTO	●			● <sup>b</sup>	
Dolby Digital/DTS/WMA9 Pro encoded multichannel sources	ON	●			● <sup>b</sup>	
	AUTO				● <sup>b</sup>	
Dolby Digital/DTS/PCM/WMA9 Pro encoded stereo sources	ON		●	● <sup>a,b</sup>	● <sup>b</sup>	
	AUTO		● <sup>c</sup>	●	● <sup>b</sup>	
Analog 2-channel (stereo) sources	ON		●	● <sup>a</sup>	●	
	AUTO		● <sup>c</sup>	●	●	

a. Only applicable when using the Virtual Surround Back mode.

b. Excluding the WMA9 Pro format.

c. Not applicable when using the Virtual Surround Back mode.

### Note

<sup>1</sup> • You can't use the Virtual Surround Back mode when the headphones are connected to this receiver or when any of the **THX**, stereo, Front Stage Surround Advance or Stream Direct mode is selected.

• You can only use the Virtual Surround Back mode if the surround speakers are on and the **Surr Back** setting is set to **NO** in the *Speaker Setting* on page 43.

• Depending on the input signal and the listening mode, the Virtual Surround Back mode may not be effective.



---

## Using Midnight and Loudness

The Midnight listening feature allows you to hear effective surround sound of movies at low volume levels. The effect automatically adjusts according to the volume at which you're listening. The Loudness listening feature can be used to get good bass and treble from music sources at low volume levels.

- Press **RECEIVER** then press **MIDNIGHT/LOUDNESS** to switch between **MIDNIGHT**, **LOUDNESS**, and **OFF**.

---

## Using the Sound Retriever

When audio data is removed during the WMA/MP3/MPEG-4 AAC compression process, sound quality often suffers from an uneven sound image. The Sound Retriever feature employs new DSP technology that helps bring CD quality sound back to compressed 2-channel audio by restoring sound pressure and smoothing jagged artifacts left over after compression.

- Press **RECEIVER** then press **S.RETRIEVER (SOUND RETRIEVER)** to switch the sound retriever on or off.

---

## Enhancing dialog

- Default setting: **OFF**

The Dialog Enhancement feature localizes dialog in the center channel to make it stand out from other background sounds in a TV or movie soundtrack.

- Press **RECEIVER** then press **DIALOG E** to switch dialog enhancement on or off.

---

## Using the tone controls

Depending on what you are listening to, you may want to adjust the bass or treble using the front panel tone control.<sup>1</sup>

- 1 Press **TONE** to select the frequency you want to adjust.

Press to switch between **BASS** and **TREBLE**.

- 2 Use the **MULTI JOG** dial to change the amount of bass or treble as necessary.

The bass and treble can be adjusted from **-6** to **+6** (dB).

- Wait about five seconds for your changes to be input automatically.

---

### Note

<sup>1</sup> The tone controls are only available when the stereo mode or the Front Stage Surround Advance mode is selected (except when **STEREO** is selected using **AUTO SURROUND**).



# Chapter 6: USB playback

## Using the USB interface

It is possible to listen to two-channel audio<sup>1</sup> using the USB interface on the front of this receiver. Connect a USB mass storage device<sup>2</sup> as shown below.

- 1 **Switch on the receiver and your TV.**
- 2 **Press USB (SHIFT+TUNER) to switch to the USB input.**  
No USB appears in the OSD.

- 3 **Connect your USB device.**<sup>3</sup>  
The USB terminal is located on the front panel.

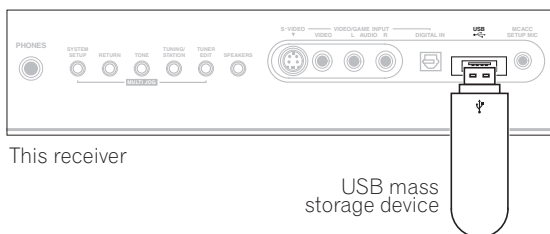

**Loading** appears in the OSD as this receiver starts recognizing the USB device connected. After the recognition, a playback screen appears in the OSD and playback starts automatically.<sup>4</sup>

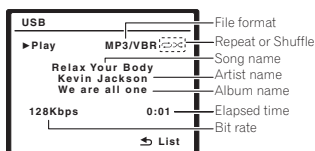

You can also select and play back your favorite file from the folder/file list displayed in the OSD. For details, see *Selecting a file from the folder/file list for playback* below.

### Note

- 1 This includes playback of WMA/MP3/MPEG-4 AAC files (except files with copy-protection or restricted playback).
- 2 • Compatible USB devices include external magnetic hard drives, portable flash memory (particularly keydrives) and digital audio players (MP3 players) of format FAT16/32. It is not possible to connect this unit to a personal computer for USB playback.
  - Pioneer cannot guarantee compatibility (operation and/or bus power) with all USB mass storage devices and assumes no responsibility for any loss of data that may occur when connected to this receiver.
  - With large amounts of data, it may take longer for the receiver to read the contents of a USB device.
- 3 Make sure the receiver is in standby when disconnecting the USB device.
- 4 • If the file selected cannot be played back, this receiver automatically skips to the next file playable.
  - When the file currently being played back has no title assigned to it, the file name is displayed in the OSD instead; when neither the album name nor the artist name is present, the row is displayed as a blank space.
  - Note that non-roman characters in the playlist are displayed as #.

## Basic playback controls

The following table shows the basic controls on the remote for USB playback.

Button	What it does
▶	Starts normal playback.
	Pauses/unpauses playback.
◀◀/▶▶	Press and hold during playback to start scanning.
◀◀/▶▶	Press to skip to previous/next track.
↺	Press repeatedly to switch between <b>Repeat Folder</b> , <b>Repeat One</b> and <b>Repeat All</b> .
↻	Press repeatedly to switch between <b>Shuffle On</b> and <b>Shuffle Off</b> .
DISP	Press repeatedly to change the song playback information displayed in the front panel display.
◀/▶	During playback, press to skip to previous/next track; when browsing, press to move to previous/next levels.
RETURN	Press to switch the playback screen to the folder/file list; when browsing a folder/file list, press to return to the previous level.

## Selecting a file from the folder/file list for playback

The folder/file list displays folders and files stored on your USB device hierarchically. You can select and play back a file of your choice by using ↑/↓/◀/▶ and **ENTER**.

### 1 Press RETURN to display the folder/file list for the USB device connected.

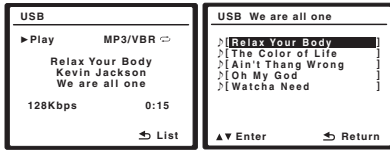

### 2 Press ↑/↓ to select the file you want to play back, and then press ENTER to confirm your selection.

- Press **RETURN** to switch to the upper hierarchy of the current folder or file.
- To switch to the previous/next folder or file within the current hierarchy, press **←/→**.

#### Important

If a **USB ERR** message lights in the display, try following the points below:

Error	What it means
<b>USB ERR1</b>	The power requirements of the USB device are too high for this receiver.
<b>USB ERR2</b>	The USB device is incompatible.
<b>USB ERR3</b>	See <i>USB interface</i> on page 66 for more on this error message.

- Switch the receiver off, then on again.
- Reconnect the USB device with the receiver switched off.
- Select another input source (like **DVD/CD**), then switch back to **USB**.
- Use a dedicated AC adapter (supplied with the device) for USB power.

If this doesn't remedy the problem, it is likely your USB device is incompatible.

### Compressed audio compatibility

Note that although most standard bit/sampling rate combinations for compressed audio are compatible, some irregularly encoded files may not play back. The list below shows compatible formats for compressed audio files:

- **MP3** (MPEG-1/2/2.5 Audio Layer 3) – Sampling rates: 8 kHz to 48 kHz; Bit rates: 8 kbps to 320 kbps (128 kbps or higher recommended); File extension: **.mp3**
- **WMA** (Windows Media Audio) – Sampling rates: 8 kHz / 48 kHz; Bit rates: 5 kbps to 384 kbps (128 kbps or higher recommended); File extension: **.wma**; WMA9 Pro and WMA lossless encoding: No

- **AAC** (MPEG-4 Advanced Audio Coding) – Sampling rates: 8 kHz to 48 kHz; Bit rates: 16 kbps to 384 kbps (128 kbps or higher recommended); File extension: **.m4a**; Apple lossless encoding: No

### Other compatibility information

- VBR (variable bit rate) MP3/WMA/MPEG-4 AAC playback: Yes<sup>1</sup>
- DRM (Digital Rights Management) protection compatible: Yes (DRM-protected audio files will not play in this receiver).

### About MPEG-4 AAC

Advanced Audio Coding (AAC) is at the core of the MPEG-4 AAC standard, which incorporates MPEG-2 AAC, forming the basis of the MPEG-4 audio compression technology. The file format and extension used depend on the application used to encode the AAC file. This unit plays back AAC files encoded by iTunes® bearing the extension '**.m4a**'. DRM-protected files will not play, and files encoded with some versions of iTunes® may not play.

*Apple and iTunes are trademarks of Apple Inc., registered in the U.S. and other countries.*

### About WMA



The Windows Media™ logo printed on the box indicates that this receiver can playback Windows Media Audio content.

WMA is an acronym for Windows Media Audio and refers to an audio compression technology developed by Microsoft Corporation. This unit plays back WMA files encoded using Windows Media™ Player bearing the extension '**.wma**'. Note that DRM-protected files will not play, and files encoded with some versions of Windows Media™ Player may not play.

*Windows Media and the Windows logo are trademarks, or registered trademarks of Microsoft Corporation in the United States and/or other countries.*

### About DRM

DRM (digital rights management) copy protection is a technology designed to prevent unauthorized copying by restricting playback, etc. of compressed audio files on devices other than the PC (or other recording equipment) used to record it. For detailed information, please see the instruction manuals or help files that came with your PC and/or software.

#### Note

<sup>1</sup> Note that in some cases playback time will not be displayed correctly.

## Chapter 7: Using the tuner

### Listening to the radio

The following steps show you how to tune in to FM and AM radio broadcasts using the automatic (search) and manual (step) tuning functions. If you already know the frequency of the station you want, see *Tuning directly to a station* below. Once you are tuned to a station you can memorize the frequency for recall later—see *Saving station presets* on page 35 for more on how to do this.

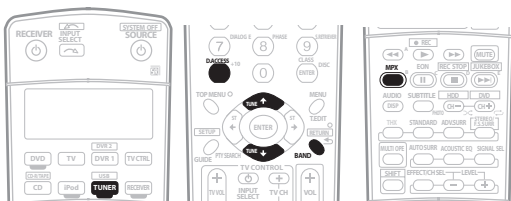

- 1 Press the **TUNER** button to select the tuner.
- 2 Use the **BAND** button to change the band (FM or AM), if necessary.  
Each press switches the band between FM and AM.

#### 3 Tune to a station.

There are three ways to do this:

##### Automatic tuning

To search for stations in the currently selected band, press and hold **TUNE**  $\uparrow/\downarrow$  for about a second. The receiver will start searching for the next station, stopping when it has found one. Repeat to search for other stations.

##### Manual tuning

To change the frequency one step at a time, press **TUNE**  $\uparrow/\downarrow$ .

##### High speed tuning

Press and hold **TUNE**  $\uparrow/\downarrow$  for high speed tuning. Release the button at the frequency you want.

### Improving FM stereo sound

If the **TUNED** or **STEREO** indicators don't light when tuning to an FM station because the signal is weak, press the **MPX** button to switch the receiver into mono reception mode. This should improve the sound quality and allow you to enjoy the broadcast.

### Tuning directly to a station

Sometimes, you'll already know the frequency of the station you want to listen to. In this case, you can simply enter the frequency directly using the number buttons on the remote control.

- 1 Press the **TUNER** button to select the tuner.
- 2 Use the **BAND** button to change the band (FM or AM), if necessary.  
Each press switches the band between FM and AM.
- 3 Press **D.ACCESS** (Direct Access).
- 4 Use the number buttons to enter the frequency of the radio station.

For example, to tune to **106.00** (FM), press **1, 0, 6, 0, 0**.

If you make a mistake halfway through, press **D.ACCESS** twice to cancel the frequency and start over.

### Saving station presets

If you often listen to a particular radio station, it's convenient to have the receiver store the frequency for easy recall whenever you want to listen to that station. This saves the effort of manually tuning in each time. This receiver can memorize up to 30 stations, stored in three banks, or classes (A, B and C) of 10 stations each. When saving an FM frequency, the **MPX** setting (see page 35) is also stored.

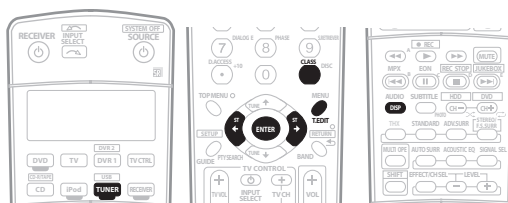

- 1 Tune to a station you want to memorize.  
See *Listening to the radio* on page 35 for more on this.
- 2 Press **T.EDIT** (TUNER EDIT).  
The display shows **STATION MEMORY**, then a blinking memory class.
- 3 Press **CLASS** to select one of the three classes then press **ST**  $\leftarrow/\rightarrow$  to select the station preset you want.  
You can also use the number buttons to select a station preset.
- 4 Press **ENTER**.  
After pressing **ENTER**, the preset class and number stop blinking and the receiver stores the station.

## Naming station presets

For easier identification, you can name your station presets.

- 1 Choose the station preset you want to name.**  
See *Listening to station presets* below for how to do this.
- 2 Press T.EDIT (TUNER EDIT).**  
The display shows **STATION NAME**, then a blinking cursor at the first character position.
- 3 Input the name you want.**  
Choose from the following characters for a name up to four characters long.

ABCDEFGHIJKLMNPOQRSTUVWXYZ

abcdefghijklmnopqrstuvwxyz

0123456789

!"#\$%&'()\*+,-./:;<=>?@[ \ ]^\_`{|}~ [space]

- Use the **ST**  $\leftarrow/\rightarrow$  buttons (remote) to select characters.
- Press **ENTER** to confirm a character. If no character is input, a space is input.
- The name is stored when **ENTER** is pressed after choosing the fourth character.

### Tip

- To erase a station name, simply repeat steps 1 to 3 and input four spaces instead of a name.
- Once you have named a station preset, you can press **DISP** when listening to a station to switch the display between name and frequency.

## Listening to station presets

You will need to have some presets stored to do this. See *Saving station presets* above if you haven't done this already.

- 1 Press TUNER to select the tuner.**
- 2 Press CLASS to select the class in which the station is stored.**  
Press repeatedly to cycle through classes A, B and C.
- 3 Press ST  $\leftarrow/\rightarrow$  to select the station preset you want.**
  - You can also use the number buttons on the remote control to recall the station preset.

## An introduction to RDS

Radio Data System (RDS) is a system used by most FM radio stations to provide listeners with various kinds of information—the name of the station and the kind of show they're broadcasting, for example.

One feature of RDS is that you can search by type of program. For example, you can search for a station that's broadcasting a show with the program type, **JAZZ**.

You can search the following program types:<sup>1</sup>

<b>NEWS</b> – News	<b>FINANCE</b> – Stock market reports, commerce, trading, etc.
<b>AFFAIRS</b> – Current Affairs	<b>CHILDREN</b> – Programs for children
<b>INFO</b> – General Information	<b>EDUCATE</b> – Educational
<b>SPORT</b> – Sport	<b>DRAMA</b> – Radio plays, etc.
<b>EDUCATE</b> – Educational	<b>CULTURE</b> – National or regional culture, theater, etc.
<b>DRAMA</b> – Radio plays, etc.	<b>SCIENCE</b> – Science and technology
<b>CULTURE</b> – National or regional culture, theater, etc.	<b>VARIED</b> – Usually talk-based material, such as quiz shows or interviews.
<b>SCIENCE</b> – Science and technology	<b>POP M</b> – Pop music
<b>VARIED</b> – Usually talk-based material, such as quiz shows or interviews.	<b>ROCK M</b> – Rock music
<b>POP M</b> – Pop music	<b>EASY M</b> – Easy listening
<b>ROCK M</b> – Rock music	<b>LIGHT M</b> – 'Light' classical music
<b>EASY M</b> – Easy listening	<b>CLASSICS</b> – 'Serious' classical music
<b>LIGHT M</b> – 'Light' classical music	<b>OTHER M</b> – Music not fitting above categories
<b>CLASSICS</b> – 'Serious' classical music	<b>WEATHER</b> – Weather reports
<b>OTHER M</b> – Music not fitting above categories	
<b>WEATHER</b> – Weather reports	

## Searching for RDS programs

One of the most useful features of RDS is the ability to search for a particular kind of radio program. You can search for any of the program types listed on the previous page.

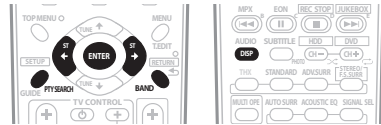

- 1 Press the BAND button to select the FM band.<sup>2</sup>**
- 2 Press the PTY SEARCH button.**  
**SEARCH** shows in the display.
- 3 Press ST  $\leftarrow/\rightarrow$  to select the program type you want to hear.**

### Note

<sup>1</sup> In addition, there are three other program types, **ALARM**, **NO DATA** and **NO TYPE**. **ALARM** is used for emergency announcements. You can't search for these, but the tuner will switch automatically to this RDS broadcast signal. **NO DATA** and **NO TYPE** appears when a program type cannot be found.

<sup>2</sup> RDS is only possible in the FM band.

#### 4 Press ENTER to search for the program type.

The system starts searching through the station presets for a match. When it finds one, the search stops and the station plays for five seconds.

#### 5 If you want to keep listening to the station, press ENTER within the five seconds.

If you don't press **ENTER**, searching resumes.

If **NO PTY** is displayed it means the tuner couldn't find that program type at the time of the search.<sup>1</sup>

### Displaying RDS information

Use the **DISP** button to display the different types of RDS information available.<sup>2</sup>

- **Press DISP for RDS information.**

Each press changes the display as follows:

- **Radio Text (RT)** – Messages sent by the radio station. For example, a talk radio station may provide a phone number as RT.
- **Program Service Name (PS)** – The name of the radio station.
- **Program Type (PTY)** – This indicates the kind of program currently being broadcast.
- **Current tuner frequency (FREQ)**

### Using EON

When EON (Enhanced Other Network information) is turned on, the receiver jumps to an EON-linked broadcast when it begins, even if a receiver function other than the tuner is being used. It can't be used in areas that EON information isn't transmitted and when FM broadcast stations don't transmit PTY data. When the broadcast ends, the tuner returns to the original frequency or function.

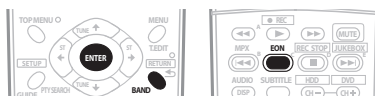

- 1 **Press the BAND button to select the FM band.<sup>3</sup>**

- 2 **Press EON to select one of the possible modes.**

Press repeatedly to switch between:

- **EON TA** (Traffic Announcement) – Sets the tuner to pick up traffic information when it is broadcast.
- **EON NEWS** – Sets the tuner to pick up news when it is broadcast.
- **OFF** – Switches off the EON feature.

When set to **TA** or **NEWS**, the **EON** indicator in the display lights (it flashes when receiving an EON broadcast).<sup>4</sup> The **O** indicator in the display lights when the current station carries the EON service.<sup>5</sup>

#### Note

<sup>1</sup> RDS searches station presets only. If no stations have been preset, or if the program type could not be found among the station presets **NO PTY** is displayed. **FINISH** means the search is complete.

<sup>2</sup> If any noise is picked up while displaying the RT scroll, some characters may be displayed incorrectly.

If you see **NO RADIO TEXT DATA** in the RT display, it means no RT data is sent from the broadcast station. The display will automatically switch to the PS data display (if no PS data, the frequency is displayed).

- In the PTY display, **NO DATA** or **NONE** may be shown. In this case, the PS display is shown after a few seconds.

<sup>3</sup> EON is only possible in the FM band.

<sup>4</sup> You can't search for traffic announcements and news at the same time.

<sup>5</sup> You cannot operate the **TUNER EDIT** and **PTY SEARCH** buttons while the **EON** indicator in the display is lit.

- If you want to change to a function other than the tuner when the **EON** indicator is flashing, press **EON MODE** to turn EON off.

## Chapter 8:

## The System Setup menu

## Making receiver settings from the System Setup menu

The following section shows you how to make detailed settings to specify how you're using the receiver (for example, if you want to set up two speaker systems in separate rooms), and also explains how to fine-tune individual speaker system settings to your liking.

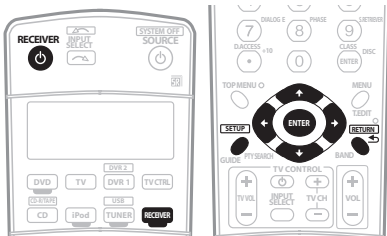

### 1 Switch on the receiver and your TV.

Use the **RECEIVER** button to switch on.<sup>1</sup>

- If headphones are connected to the receiver, disconnect them.

### 2 Press RECEIVER on the remote control, then press the SETUP button.<sup>2</sup>

An on-screen display (OSD) appears on your TV. Use **↑/↓/←/→** and **ENTER** to navigate through the screens and select menu items. Press **RETURN** to confirm and exit the current menu.

- Press **SETUP** at any time to exit the System Setup menu.

### 3 Select the setting you want to adjust.

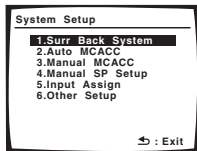

- **Surr Back System** – Specify how you are using your surround back speakers (see *Surround back speaker setting* below).
- **Auto MCACC** – This is a quick and effective automatic surround setup (see *Automatically setting up for surround sound (Auto MCACC)* on page 8).

- **Manual MCACC** – Fine tune your speaker settings and customize the Acoustic Calibration EQ (see *Manual MCACC setup* on page 39).
- **Manual SP Setup** – Specify the size, number, distance and overall balance of the speakers you've connected (see *Manual speaker setup* on page 43).
- **Input Assign** – Specify what you've connected to the digital, component video and HDMI inputs (see *The Input Assign menu* on page 52).
- **Other Setup** – Make customized settings to reflect how you are using the receiver (see *The Other Setup menu* on page 53).

## Surround back speaker setting

- Default setting: **Normal (SB)**

There are several ways you can use the surround back speaker channels with this system. In addition to a normal home theater setup where they are used for the surround back speakers, they can be used for bi-amping the front speakers or as a separate speaker system in another room.

### 1 Select 'Surr Back System' from the System Setup menu.

See *Making receiver settings from the System Setup menu* above if you're not already at this screen.

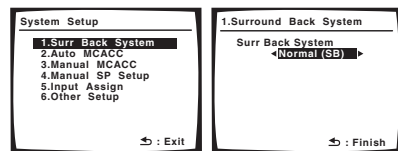

### 2 Select the surround back speaker setting.

- **Normal (SB)** – Select for normal home theater use with surround back speakers in your main (speaker system A) setup.
- **Speaker B** – Select to use the (surround back) B speaker terminals to listen to stereo playback in another room (see *Speaker B setup* on page 48).
- **Front Bi-Amp** – Select this setting if you're bi-amping your front speakers (see *Bi-amping your front speakers* on page 48).

### 3 When you're finished, press RETURN.

You return to the System Setup menu.

#### Note

<sup>1</sup> Make sure not to switch off the power when using the System Setup menu.

- <sup>2</sup> • The OSD will not appear if you have connected using the HDMI output to your TV. Use component, S-video, or composite connections for system setup.
- You can't use the System Setup menu when the iPod or USB is selected as the input source.

## Manual MCACC setup

You can use the settings in the Manual MCACC setup menu to make detailed adjustments when you're more familiar with the system. Before making these settings, you should have already completed *Automatically setting up for surround sound (Auto MCACC)* on page 8.

You only need to make these settings once (unless you change the placement of your current speaker system or add new speakers).

### Important

- For some of the settings below, you'll have to connect the setup microphone to the front panel and place it about ear level at your normal listening position. Press **SETUP** to display the System Setup menu before you connect the microphone to this receiver. If the microphone is connected while the System Setup menu is not being displayed, the display will change to the Auto MCACC setup menu. See *Problems when using the Auto MCACC Setup* on page 10 for notes regarding background noise and other possible interference.
- If you're using a subwoofer, switch it on and turn up the volume as necessary.

### Caution

- The test tones used in the MCACC setup are output at high volume.

## 1 Select 'Manual MCACC' from the System Setup menu.

See *Making receiver settings from the System Setup menu* above if you're not already at this screen.

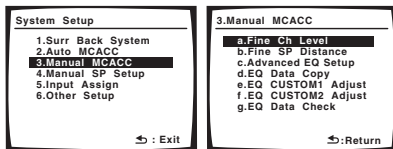

## 2 Select the setting you want to adjust.

If you're doing this for the first time, you might want to make these settings in order.

- Fine Ch Level** – Make fine adjustments to the overall balance of your speaker system (see *Fine Channel Level* below).
- Fine SP Distance** – Make precise delay settings for your speaker system (see *Fine Speaker Distance* on page 40).

- Advanced EQ Setup** – Calibrate your system based on the direct sound coming from the speakers and make detailed settings according to your room's reverb characteristics (see *Setting the Acoustic Calibration EQ automatically* on page 41).
- EQ Data Copy** – Copy Acoustic Calibration EQ settings for manual adjustment (see *Copying your Acoustic Calibration EQ settings* on page 41).
- EQ CUSTOM1/2 Adjust** – Make detailed manual adjustments to your custom Acoustic Calibration EQ settings (see *Setting the Acoustic Calibration EQ manually* on page 42).
- EQ Data Check** – Check the **ALL CH ADJUST**, **FRONT ALIGN** and custom settings using the on-screen display (see *Checking your Acoustic Calibration EQ settings* on page 42).

## Fine Channel Level

- Default setting: **0.0dB** (all channels)

You can achieve better surround sound by properly adjusting the overall balance of your speaker system. The following setting can help you make detailed adjustments that you may not achieve using the *Manual speaker setup* on page 43.

## 1 Select 'Fine Ch Level' from the Manual MCACC setup menu.

After the volume increases to the reference level, test tones will be output.

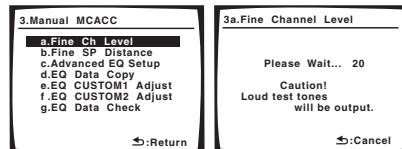

## 2 Adjust the level of the left channel, press ENTER.

This will be the reference speaker level, so you may want to keep the level around **0dB** so that you'll have plenty of room to adjust the other speaker levels.

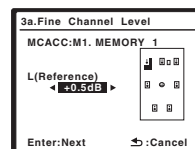

## 3 Select each channel in turn and adjust the levels (+/-10dB) as necessary.

Use **←/→** to adjust the volume of the speaker you selected to match the reference speaker.

When it sounds like both tones are the same volume, press **↓** to confirm and continue to the next channel.



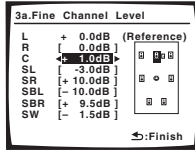

- For comparison purposes, the reference speaker will change depending on which speaker you select.
- If you want to go back and adjust a channel, simply use  $\uparrow/\downarrow$  to select it.

#### 4 When you're finished, press RETURN.

You return to the Manual MCACC setup menu.

### Fine Speaker Distance

- Default setting: **3.0 m** (all channels)

For proper sound depth and separation with your system, it is necessary to add a slight bit of delay to some speakers so that all sounds will arrive at the listening position at the same time. The following setting can help you make detailed adjustments that you may not achieve using the *Manual speaker setup* below.

#### 1 Select 'Fine SP Distance' from the Manual MCACC setup menu.

The volume increases to the reference level.

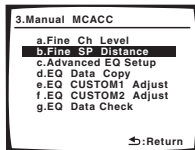

#### 2 Adjust the distance of the left channel from the listening position.

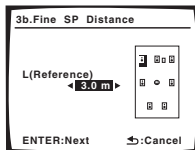

After pressing **ENTER**, test tones will be output.

#### 3 Select each channel in turn and adjust the distance as necessary.

Use  $\leftarrow/\rightarrow$  to adjust the delay of the speaker you selected to match the reference speaker. The delay is measured in terms of speaker distance from **0.1** to **9.0** meters.

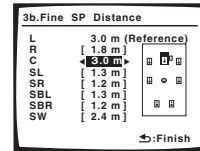

Listen to the reference speaker and use it to measure the target channel. From the listening position, face the two speakers with your arms outstretched pointing at each speaker. Try to make the two tones sound as if they are arriving simultaneously at a position slightly in front of you and between your arm span.<sup>1</sup>

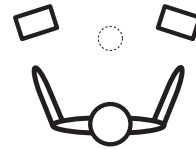

When it sounds like the delay settings are matched up, press **ENTER** to confirm and continue to the next channel.

- For comparison purposes, the reference speaker will change depending on which speaker you select.
- If you want to go back and adjust a channel, simply use  $\uparrow/\downarrow$  to select it.

#### 4 When you're finished, press RETURN.

You return to the Manual MCACC setup menu.

### Professional Acoustic Calibration EQ

Acoustic Calibration Equalization is a kind of speaker equalizer. It works by measuring the acoustic characteristics of your listening room and turning the ambient environment into a natural state to reproduce the source sound as it was originally recorded. This is an equalizer that enables a 'flat' setting.

This setting minimizes the undesirable reverberation of your listening room based on the sound directly coming from the speakers. You can select a correction time period during the automatic calibration.

If you're not satisfied with the automatic adjustment provided in *Automatically setting up for surround sound (Auto MCACC)* on page 8, you can also adjust these settings manually to get a frequency balance that suits your tastes.

#### Note

<sup>1</sup> If you can't seem to achieve this by adjusting the distance setting, you may need to change the angle of your speakers very slightly.



## Setting the Acoustic Calibration EQ automatically

When you perform the Auto MCACC setup as specified in *Automatically setting up for surround sound (Auto MCACC)* on page 8, the correction is automatically done with the time period already selected (when **TYPE1** is selected for **EQ TYPE**, the calibration is set only for **ALL CH ADJUST**). In this setup, you can select any of the time periods for EQ correction.

### 1 Select 'Advanced EQ Setup' from the Manual MCACC setup menu.

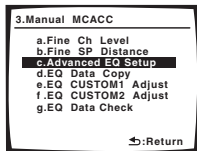

- The Advanced EQ setup overwrites the settings already set for **ALL CH ADJUST** and/or **FRONT ALIGN**. To keep these settings intact, save the data in **CUSTOM1/CUSTOM2** as specified in *Copying your Acoustic Calibration EQ settings* below.
- Make sure the supplied microphone is connected.
- See *Problems when using the Auto MCACC Setup* on page 10 for notes regarding high background noise levels and other possible interference.

### 2 Select 'TYPE1' or 'TYPE2'.

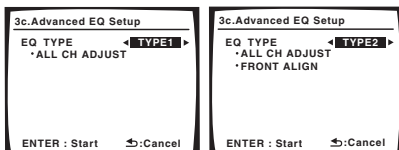

Use **←/→** to select the setting.

When **TYPE1** is selected, the calibration is set for **ALL CH ADJUST**; when **TYPE2** is selected, the calibration is set for both **ALL CH ADJUST** and **FRONT ALIGN**.

### 3 Select the time setting you want to use for calibration.<sup>1</sup>

You can choose the time period that will be used for the calibration. Use **←/→** to select the time setting.

Select the setting from the following time periods (in milliseconds): **0~20ms**, **10~30ms**, **20~40ms**, **30~50ms**, **40~60ms**, **50~70ms** and **60~80ms**. This setting will be applied to all channels during calibration.

For an optimal system calibration based on the direct sound coming from the speakers, we recommend using the **30~50ms** setting.

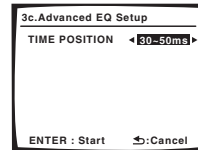

### 4 Press ENTER, then the calibration starts automatically.

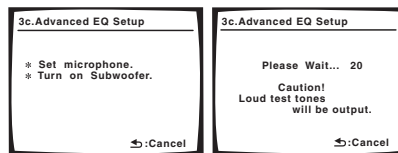

### 5 Wait for the Advanced EQ Setup to finish.

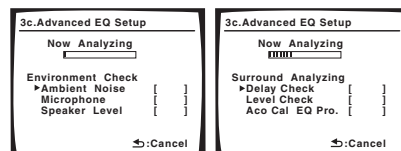

As the receiver outputs test tones, the frequency balance is adjusted automatically for the following settings:

- **ALL CH ADJUST** – A 'flat' setting where all the speakers are set individually so no special weighting is given to any one channel.
- **FRONT ALIGN** – All speakers are set in accordance with the front speaker settings (no equalization is applied to the front left and right channels).

It will take about 1 to 3 minutes for the calibration to finish.

The display returns to the Manual MCACC setup menu automatically after the Acoustic Calibration Equalization is set.

## Copying your Acoustic Calibration EQ settings

If you want to manually adjust the Acoustic Calibration EQ (see *Setting the Acoustic Calibration EQ manually* below), we recommend copying the **ALL CH ADJUST** or the **FRONT ALIGN** settings from the Advanced EQ Setup above (or from *Automatically setting up for surround sound (Auto MCACC)* on page 8) to one of the custom settings. Instead of just a flat EQ curve, this will give you a reference point from which to start.

### Note

<sup>1</sup> For multi-channel audio sources, the localization of the reproduced sound image and the sound linkage of the speakers depend on the direct sound including the early-reflected sound. In this setup, the earlier time settings (**0~20ms**, **10~30ms**, etc.) implement calibration closer to the direct sound with less consideration of the reverb characteristics; the later time settings (**60~80ms**, **50~70ms**, etc.) incorporate the reverberant sound. Select your favorite setting for the optimum results.

1 Select 'EQ Data Copy' from the Manual MCACC setup menu.

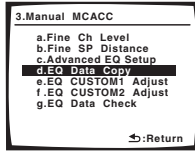

2 Select CUSTOM1 or CUSTOM2 then use  $\leftarrow/\rightarrow$  to select the setting you want to copy.

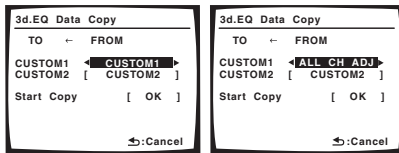

- You can also copy from one custom setting to another. For more on the **ALL CH ADJUST** and **FRONT ALIGN** settings, see *Setting the Acoustic Calibration EQ automatically* above.

3 Select 'OK' to copy and confirm.

### Setting the Acoustic Calibration EQ manually

Before manually adjusting the Acoustic Calibration EQ, we recommend copying the **ALL CH ADJUST** or the **FRONT ALIGN** settings from the auto setup above (or from *Automatically setting up for surround sound (Auto MCACC)* on page 8) to one of the custom settings. Instead of just a flat EQ curve, this will give you a reference point from which to start (see *Copying your Acoustic Calibration EQ settings* above for how to do this).

1 Select 'EQ CUSTOM1 Adjust' or 'EQ CUSTOM2 Adjust' from the Manual MCACC setup menu.

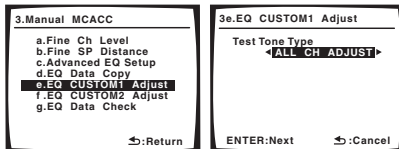

2 Select which method you would like to use to adjust the overall frequency balance.

It is best to choose whichever one you copied to the custom setting in *Copying your Acoustic Calibration EQ settings* above.

- ALL CH ADJUST** – All the speakers can be set independently so no special weighting is given to any one channel. When adjusting, test tones will sound for each individual channel.
- FRONT ALIGN** – Speakers are set in accordance with the front speaker settings. The sound of the test tone will alternate between the left front (reference) speaker and the target speaker.

3 Select the channel(s) you want and adjust to your liking.

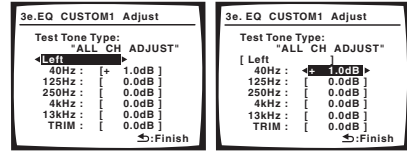

Use  $\leftarrow/\rightarrow$  to select the channel.

Use  $\uparrow/\downarrow$  to select the frequency and  $\leftarrow/\rightarrow$  to boost or cut the EQ. When you're finished, go back to the top of the screen and use  $\leftarrow/\rightarrow$  to select the next channel.

- The front speakers can't be adjusted if you selected **FRONT ALIGN**.
- The **OVER!** indicator shows in the display if the frequency adjustment is too drastic and might distort. If this happens, bring the level down until **OVER!** disappears from the display.

### Tip

- Changing the frequency curve of one channel too drastically will affect the overall balance. If the speaker balance seems uneven, you can raise or lower channel levels using test tones with the **TRIM** feature. Use  $\uparrow/\downarrow$  to select **TRIM** then use  $\leftarrow/\rightarrow$  to raise or lower the channel level for the current speaker.

4 When you're finished, press RETURN.

You return to the Manual MCACC setup menu.

### Checking your Acoustic Calibration EQ settings

After you have completed an automatic or manual Acoustic Calibration EQ adjustment, you can check the **ALL CH ADJUST**, **FRONT ALIGN** and custom settings using the on-screen display.

1 Select 'EQ Data Check' from the Manual MCACC setup menu.

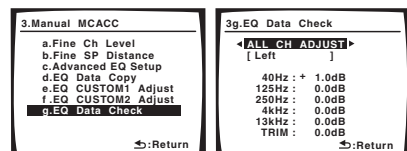

2 Select the setting you want to check.

- It is useful to do this while a source is playing so you can compare the different settings.

3 Select the channels you want, pressing ENTER when you're finished checking each one.

4 When you're finished, press RETURN.

You return to the Manual MCACC setup menu.

## Manual speaker setup

This receiver allows you to make detailed settings to optimize the surround sound performance. You only need to make these settings once (unless you change the placement of your current speaker system or add new speakers).

These settings are designed to fine-tune your system, but if you're satisfied with the settings made in *Automatically setting up for surround sound (Auto MCACC)* on page 8, it isn't necessary to make all of these settings.

### Caution

- The test tones used in the System Setup are output at high volume.

### 1 Select 'Manual SP Setup' then press ENTER.

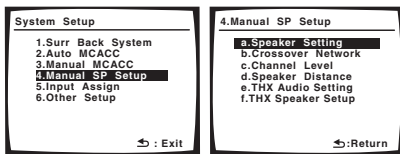

### 2 Select the setting you want to adjust.

If you are doing this for the first time, you may want to adjust these settings in order:

- Speaker Setting** – Specify the size and number of speakers you've connected (page 43).
- Crossover Network** – Specify which frequencies will be sent to the subwoofer (page 44).
- Channel Level** – Adjust the overall balance of your speaker system (page 44).
- Speaker Distance** – Specify the distance of your speakers from the listening position (page 45).
- THX Audio Setting** – Specify the distance of your surround back speakers from each other (page 45).
- THX Speaker Setup** – Specify whether or not you have a THX speaker system (page 45).

### 3 Make the adjustments necessary for each setting, pressing RETURN to confirm after each screen.

## Speaker Setting

Use this setting to specify your speaker configuration (size, number of speakers). It is a good idea to make sure that the settings made in *Automatically setting up for surround sound (Auto MCACC)* on page 8 are correct.

### Note

- If you select **SMALL** for the front speakers the subwoofer will automatically be fixed to **YES**. Also, the center, surround, and surround back speakers can't be set to **LARGE** if the front speakers are set to **SMALL**. In this case, all bass frequencies are sent to the subwoofer.
- If the surround speakers are set to **NO**, the surround back speakers will automatically be set to **NO**.
  - If you selected **Speaker B** or **Front Bi-Amp** (in *Surround back speaker setting* on page 38) you can't adjust the surround back settings.
  - If you select one surround back speaker only, make sure that speaker is hooked up to the left surround back terminal.

### 1 Select 'Speaker Setting' from the Manual SP Setup menu.

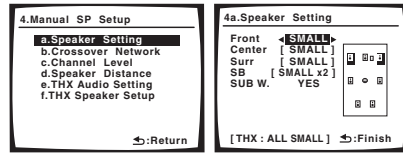

### 2 Choose the set of speakers that you want to set then select a speaker size.

Use **←/→** to select the size (and number) of each of the following speakers:

- Front** – Select **LARGE** if your front speakers reproduce bass frequencies effectively, or if you didn't connect a subwoofer. Select **SMALL** to send the bass frequencies to the subwoofer.<sup>1</sup>
- Center** – Select **LARGE** if your center speaker reproduces bass frequencies effectively, or select **SMALL** to send bass frequencies to the other speakers or subwoofer. If you didn't connect a center speaker, choose **NO** (the center channel is sent to the other speakers).
- Surr** – Select **LARGE** if your surround speakers reproduce bass frequencies effectively. Select **SMALL** to send bass frequencies to the other speakers or subwoofer. If you didn't connect surround speakers choose **NO** (the sound of the surround channels is sent to the other speakers).
- SB** – Select the number of surround back speakers you have (one, two or none). Select **LARGE** if your surround back speakers reproduce bass frequencies effectively. Select **SMALL** to send bass frequencies to the other speakers or subwoofer. If you didn't connect surround back speakers choose **NO**.<sup>2</sup>
- SUB W.** – LFE signals and bass frequencies of channels set to **SMALL** are output from the subwoofer when **YES** is selected (see notes below). Choose the **PLUS** setting if you want the subwoofer to output bass sound continuously or you want deeper bass (the bass frequencies that would normally come out the front and center speakers are also routed to the subwoofer). If you did not connect a subwoofer choose **NO** (the bass frequencies are output from other speakers).

### 3 When you're finished, press RETURN.

You return to the Manual SP Setup menu.

### Tip

- If you have a subwoofer and like lots of bass, it may seem logical to select **LARGE** for your front speakers and **PLUS** for the subwoofer. This may not, however, yield the best bass results. Depending on the speaker placement of your room you may actually experience a decrease in the amount of bass due to low frequency cancellations. In this case, try changing the position or direction of speakers. If you can't get good results, listen to the bass response with it set to **PLUS** and **YES** or the front speakers set to **LARGE** and **SMALL** alternatively and let your ears judge which sounds best. If you're having problems, the easiest option is to route all the bass sounds to the subwoofer by selecting **SMALL** for the front speakers.

## Crossover Network

- Default setting: **80Hz**

This setting decides the cutoff between bass sounds playing back from the speakers selected as **LARGE**, or the subwoofer, and bass sounds playing back from those selected as **SMALL**. It also decides where the cutoff will be for bass sounds in the LFE channel.<sup>1</sup>

### 1 Select 'Crossover Network' from the Manual SP Setup menu.

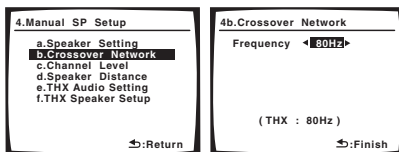

### 2 Choose the frequency cutoff point.

Frequencies below the cutoff point will be sent to the subwoofer (or **LARGE** speakers).

### 3 When you're finished, press RETURN.

You return to the Manual SP Setup menu.

## Channel Level

Using the channel level settings, you can adjust the overall balance of your speaker system, an important factor when setting up a home theater system.

### 1 Select 'Channel Level' from the Manual SP Setup menu.

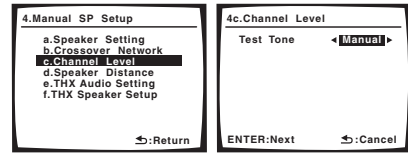

### 2 Select a setup option.

- Manual** – Move the test tone manually from speaker to speaker and adjust individual channel levels.
- Auto** – Adjust channel levels as the test tone moves from speaker to speaker automatically.

### 3 Confirm your selected setup option.

The test tones will start after you press **ENTER**.

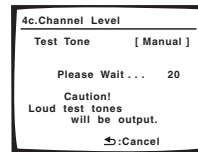

### 4 Adjust the level of each channel using ←/→.

If you selected **Manual**, use **↑/↓** to switch speakers. The **Auto** setup will output test tones in the order shown on-screen:

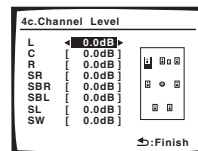

Adjust the level of each speaker as the test tone is emitted.<sup>2</sup>

### 5 When you're finished, press RETURN.

You return to the Manual SP Setup menu.

### Tip

- You can change the channel levels at any time by using **EFFECT/CH SEL** and **+/-** on the remote control. You can set two channel levels: one for **MULTI CH IN** and one for the listening modes.

### Note

- For more on selecting the speaker sizes, see *Speaker Setting* above.
- If you're using a THX speaker setup, confirm that the crossover frequency is set to **80Hz**.
- If you are using a Sound Pressure Level (SPL) meter, take the readings from your main listening position and adjust the level of each speaker to 75 dB SPL (C-weighting/slow reading).
  - The subwoofer test tone is output at low volumes. You may need to adjust the level after testing with an actual soundtrack.

## Speaker Distance

For good sound depth and separation from your system, you need to specify the distance of your speakers from the listening position. The receiver can then add the proper delay needed for effective surround sound.

### 1 Select 'Speaker Distance' from the Manual SP Setup menu.

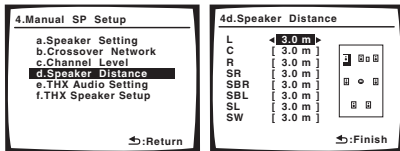

### 2 Adjust the distance of each speaker using ←/→.

You can adjust the distance of each speaker in 0.1 meter increments.

### 3 When you're finished, press RETURN.

You return to the Manual SP Setup menu.



#### Tip

- For best surround sound, make sure the surround back speakers are the same distance from the listening position.

## THX Audio Setting

For the most effective results when using the THX Select2 Cinema and THX MusicMode listening modes (see *Using the Home THX modes* on page 28) with the Advanced Speaker Array (ASA) system (see *About THX* on page 68), it is required that you make the setting. See *THX speaker system setup* on page 20 for more on THX speaker placement.<sup>1</sup>

### 1 Select 'THX Audio Setting' from the Manual SP Setup menu.

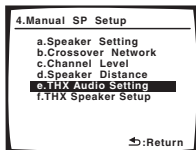

### 2 Specify the distance of your surround back speakers from each other.

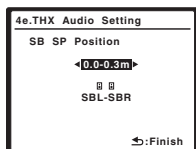

- 0.0 – 0.3m** – Surround speakers within 30 cm apart (best for THX surround sound).
- > 0.3 – 1.2m** – Surround speakers between 30 cm and 1.2 m apart.
- 1.2m <** – Surround speakers more than 1.2 m apart.

### 3 When you're finished, press RETURN.

You will return to the Manual SP Setup menu.

## THX Speaker Setup

If you have a complete THX speaker system, you should make this setting for the most effective results when using surround sound. See *THX speaker system setup* on page 20 for more on using a THX speaker system.

### 1 Select 'THX Speaker Setup' from the Manual SP Setup menu.

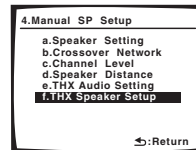

### 2 Specify whether or not you are using a THX speaker system.



- YES** – All speaker settings are fixed to **SMALL** (see *Speaker Setting* on page 43) during the Auto MCACC setup.
- NO** – Individual speaker sizes are determined according to the Auto MCACC setup.

### 3 When you're finished, press RETURN.

You will return to the Manual SP Setup menu.

#### Note

<sup>1</sup> If you don't have surround back speakers, or just have one, you won't be able to select this setting (Cannot select shows in the display).

## Chapter 9: Other connections

### ⚠ Caution

- Make sure the power is switched off before making or changing the connections.

### Connecting an iPod

This receiver has a dedicated iPod terminal that will allow you to control playback of audio content from your iPod using the controls of this receiver.<sup>1</sup>

### Connecting your iPod to the receiver

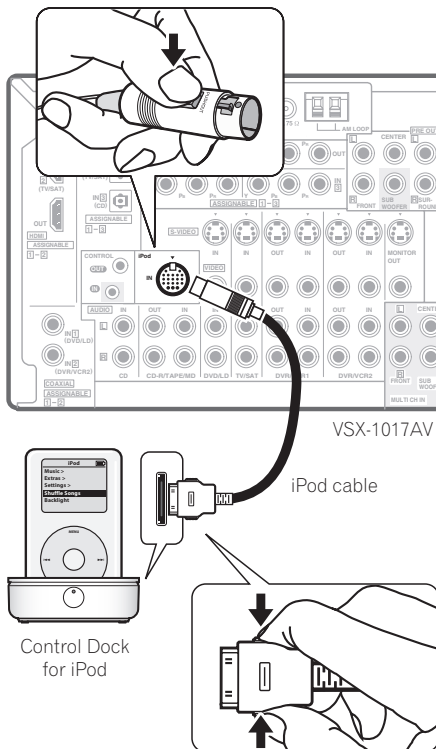

- 1 Set this receiver to the standby mode, and then use the Control Dock for iPod supplied with an iPod control cable<sup>2</sup> to connect your iPod to the iPod terminal on the rear panel of this receiver.

Push the connector in until you hear it click home. To disconnect, squeeze the connector (as shown) to release the catch, then pull out.

- 2 Switch the receiver on and press the iPod input source button to switch the receiver to the iPod. The front panel display shows **Loading** while the receiver verifies the connection and retrieves data from the iPod.

- 3 Use the TOP MENU button to display iPod Top menu.

When the display shows **Top Menu** you're ready to play music from the iPod.<sup>3</sup>

- If after pressing **iPod** the display shows **No Connection**, try switching off the receiver and reconnecting the iPod to the receiver.

### iPod playback

To navigate songs on your iPod, you can take advantage of the OSD of your TV connected to this receiver.<sup>4</sup> You can also control all operations for music in the front panel display of this receiver.

### Finding what you want to play

When your iPod is connected to this receiver, you can browse songs stored on your iPod by playlist, artist, album name, song name, genre or composer, similar to using your iPod directly.

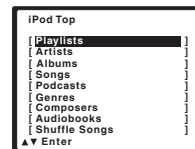

- 1 Use the ↑/↓ buttons to select a category then press ENTER to browse that category.

- To return to the previous level any time, press RETURN.

### Note

1 This system is compatible with an iPod, iPod mini, iPod nano and iPod Photo portable device (third generation and above), however, compatibility may vary depending on the software version of your iPod. This receiver does not support software versions prior to iPod update 2004-10-20. For supported versions, consult your local Pioneer dealer.

2 • This product is the Pioneer Control Dock for iPod (IDK-90C) for use with an iPod® (third generation and above), iPod mini, iPod nano or iPod Photo.  
• For detailed instructions on using the iPod, please refer to the manual supplied with the iPod.

• The connected iPod should be updated with iPod updater software higher than version 2004-10-20.

3 The controls of your iPod will be inoperable when connected to this receiver (Pioneer shows in the iPod display). Features such as the equalizer cannot be controlled using this receiver, and we recommend switching the equalizer off before connecting.

4 • Note that non-roman characters in the playlist are displayed as #.  
• This feature is not available for photos or video clips on your iPod.

## 2 Use the ↑/↓ buttons to browse the selected category (e.g., albums).

- Use ←/→ to move to previous/next levels.

## 3 Continue browsing until you arrive at what you want to play, then press ► to start playback.<sup>1</sup>

Navigation through categories on your iPod looks like this:

```

Playlists → Songs
Artists → Albums → Songs
Albums → Songs
Songs
Podcasts
Genres → Artists → Albums → Songs
Composers → Albums → Songs
Audiobooks
Shuffle Songs
  
```



### Tip

- You can play all of the songs in a particular category by selecting the **All** item at the top of each category list. For example, you can play all the songs by a particular artist.

## Basic playback controls

The following table shows the basic playback controls for your iPod:

Button	What it does
►	Press to start playback. If you start playback when something other than a song is selected, all the songs that fall into that category will play.
■	Press to stop playback.
⏸	Pauses playback, or restarts playback when paused.
⏮/⏭	Press and hold during playback to start scanning.
⏮/⏭	Press to skip to previous/next track.
↺	Press repeatedly to switch between <b>Repeat One</b> , <b>Repeat All</b> and <b>Repeat Off</b> .
↻	Press repeatedly to switch between <b>Shuffle Songs</b> , <b>Shuffle Albums</b> and <b>Shuffle Off</b> .
DISP	Press repeatedly to change the song playback information displayed.
←/→	During playback, press to skip to previous/next playlist; when browsing, press to move to previous/next levels.
↑/↓	During Audiobook playback, press to switch the playback speed: Faster ↔ Normal ↔ Slower

### Note

<sup>1</sup> If you're in the song category, you can also press **ENTER** to start playback.

<sup>2</sup> Your iPod nano currently restricts viewing of photo images stored.

<sup>3</sup> To listen to multichannel analog audio you'll need to select **MULTI CH IN** (see *Selecting the multichannel analog inputs* above for more on this).

<sup>4</sup> • When playback from the multichannel inputs is selected, you can't use the sound processing features, **SIGNAL SELECT**, or any of the listening modes (including **STEREO** and the surround back channel processing).

- When playback from the multichannel inputs is selected, only the volume and channel levels can be set.

- You can't listen to your speaker B system during playback from the multichannel inputs.

Button	What it does
TOP MENU	Press to return to the <b>iPod Top</b> menu screen.
RETURN	Press to return to the previous level.

## Watching photos and video content

To view photos or video on your iPod, since video control is not possible using this receiver, you must use the main controls of your iPod instead.<sup>2</sup>

### 1 Press PHOTO to switch the iPod controls for photo and video playback.

The receiver controls will be unavailable while you are watching iPod videos or browsing photos.

### 2 Press PHOTO again to switch back to the receiver controls when you're done.

*iPod® is a trademark of Apple Inc., registered in the U.S. and other countries.*

## Connecting the multichannel analog inputs

For DVD Audio and SACD playback, your DVD player may have 5.1, 6.1 or 7.1 channel analog outputs (depending on whether your player supports surround back channels).<sup>3</sup> Make sure that the player is set to output multichannel analog audio.

### 1 Connect the front, surround, center and subwoofer outputs on your DVD player to the corresponding MULTI CH input jack on this receiver.

- Use standard RCA/phono jack cables for the connections.

### 2 If your DVD player also has outputs for surround back channels, connect these to the corresponding MULTI CH input jacks on this receiver.

- Use standard RCA/phono jack cables for the connections.
- If there is a single surround back output, connect it to the **SURROUND BACK L (Single)** jack on this receiver.

## Selecting the multichannel analog inputs

If you have connected a decoder or a DVD player as above, you must select the analog multichannel inputs for surround sound playback.<sup>4</sup>



### 1 Make sure you have set the playback source to the proper output setting.

For example, you might need to set your DVD player to output multichannel analog audio.

### 2 Press MULTI CH IN (front panel).

- Depending on the DVD player you're using, the analog output level of the subwoofer channel may be too low. In this case switch the receiver into standby, then press  $\odot$  **STANDBY/ON** while holding down **SBch PROCESSING** on the front panel. This switches between **SW IN +10dB** (increase of 10 decibels) and **SW IN 0dB** (default) in the subwoofer channel.

## Speaker B setup



### Caution

- Before making or changing the connections, switch off the power and disconnect the power cord from the power outlet. Plugging in components should be the last connection you make with your system.
- Be careful not to allow any contact between speaker wires from different terminals.
- You can use speakers with a nominal impedance between  $6\ \Omega$  to  $16\ \Omega$  (please see *Switching the speaker impedance* on page 56 if you plan to use speakers with an impedance of less than  $8\ \Omega$ ).

After selecting **Speaker B** in *Surround back speaker setting* on page 38, you can use the speakers connected to the (surround back) B speaker terminals on the rear panel to listen to stereo playback in another room. See *Switching the speaker system* below for the listening options with this setup.

### 1 Connect a pair of speakers to the surround back speaker terminals on the rear panel.

Connect them the same way you connected your speakers in *Installing your speaker system* on page 18. Make sure to review *Placing the speakers* on page 19 when placing the speakers in another room.

### 2 Select 'Speaker B' from the 'Surr Back System' menu.

See *Surround back speaker setting* on page 38 to do this.

## Switching the speaker system

If you selected **Speaker B** in *Surround back speaker setting* on page 38, three speaker system settings are possible using the **SPEAKERS** button. If you selected **Normal (SB)** or **Front Bi-Amp**, the button will simply switch your main speaker system on or off. The options below are for the **Speaker B** setting only.<sup>1</sup>

- Use the **SPEAKERS** button on the front panel to select a speaker system setting.

As mentioned above, if you have selected **Normal (SB)**, the button will simply switch your main speaker system (A) on or off.

Press repeatedly to choose a speaker system option:

- SP▶A** – Sound is output from speaker system A and the same signal is output from the pre-out terminals.
- SP▶B** – Sound is output from the two speakers connected to speaker system B. Multichannel sources will not be heard. The same signal is output from the surround back channel pre-out terminals.
- SP▶AB** – Sound is output from speaker system A (up to 5 channels, depending on the source), the two speakers in speaker system B, and the subwoofer. The sound from speaker system B will be the same as the sound from speaker system A (multichannel sources will be downmixed to 2 channels).
- SP▶** (off) – No sound is output from the speakers. The same sound is output from the pre-out terminals (including from your subwoofer, if connected) as when selecting speaker system A (above).

## Bi-amping your front speakers

Bi-amping is when you connect the high frequency driver and low frequency driver of your speakers to different amplifiers (in this case, to both front and surround back terminals) for better crossover performance. Your speakers must be bi-ampable to do this (having separate terminals for high and low) and the sound improvement will depend on the kind of speakers you're using.

### Note

<sup>1</sup> • The subwoofer output depends on the settings you made in *Manual speaker setup* on page 43. However, if **SP▶B** is selected above, no sound is heard from the subwoofer (the LFE channel is not downmixed).

- Depending on the settings in *Surround back speaker setting* on page 38 output from the surround back pre-out terminals may change.
- All speaker systems (except **Speaker B** connections) are switched off when headphones are connected.



**1 Connect your speakers as shown below.**

This illustration below shows the connections for bi-amping your front left speaker. Hook up your front right speaker in the same way.

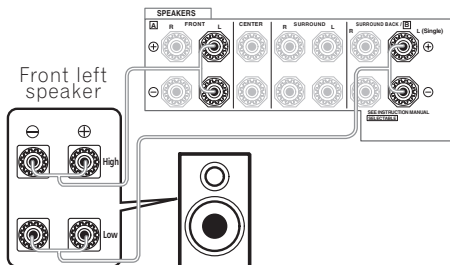

Since both front and surround back speaker terminals output the same audio, it doesn't matter which set (front or surround back) is powering which part (**High** or **Low**) of the speaker.

- Make sure that the + / - connections are properly inserted.

**2 Select the 'Front Bi-Amp' setting from the 'Surr Back System' menu.**

See *Surround back speaker setting* on page 38 to specify how you're using the surround back speaker terminals.

**Caution**

- Most speakers with both **High** and **Low** terminals have two metal plates that connect the **High** to the **Low** terminals. These must be removed when you are bi-amping the speakers or you could severely damage the amplifier. See your speaker manual for more information.
- If your speakers have a removable crossover network, make sure you do not remove it for bi-amping. Doing so may damage your speakers.

**Bi-wiring your speakers**

The reasons for bi-wiring are basically the same as bi-amping, but additionally, interference effects within the wire could be reduced, producing better sound. Again, to do this your speakers must be bi-wireable (that is they must have separate terminals for the high and low frequencies). When bi-wiring, make sure you've selected **Normal (SB)** or **Speaker B** in *Surround back speaker setting* on page 38.

- **To bi-wire a speaker, connect two speaker cords to the speaker terminal on the receiver.**

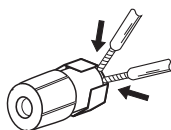

**Caution**

- Make sure you use a parallel (not series, which are fairly uncommon) connection when bi-wiring your speakers.
- Don't connect different speakers from the same terminal in this way.

**Connecting additional amplifiers**

This receiver has more than enough power for any home use, but it's possible to add additional amplifiers to every channel of your system using the pre-outs. Make the connections shown below to add amplifiers to power your speakers.

- Before making or changing the connections, switch off the power and disconnect the power cord from the AC outlet.

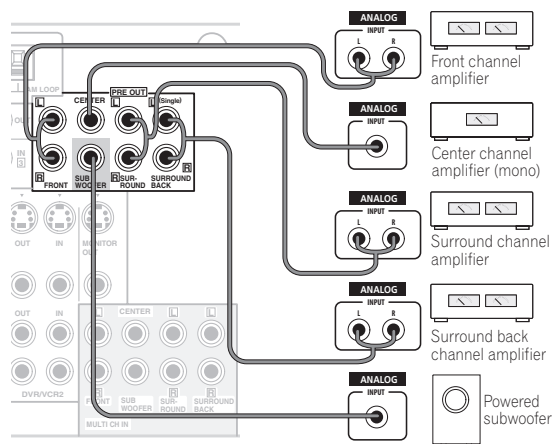

VSX-1017AV

- You can use the additional amplifier on the surround back channel pre-outs for a single speaker as well. In this case plug the amplifier into the left (**L (Single)**) terminal only.
- The sound from the surround back terminals will depend on how you have configured the *Surround back speaker setting* on page 38.
- To hear sound only from the pre-outs, switch the speaker system to **OFF**, or simply disconnect any speakers that are connected directly to the receiver.
- If you're not using a subwoofer, change the front speaker setting (see *Speaker Setting* on page 43) to **LARGE**.

## Using this receiver with a Pioneer plasma display

If you have a Pioneer plasma display, you can use an SR+ cable<sup>1</sup> to connect it to this unit and take advantage of various convenient features, such as automatic video input switching of the plasma display when the input is changed.<sup>2</sup>

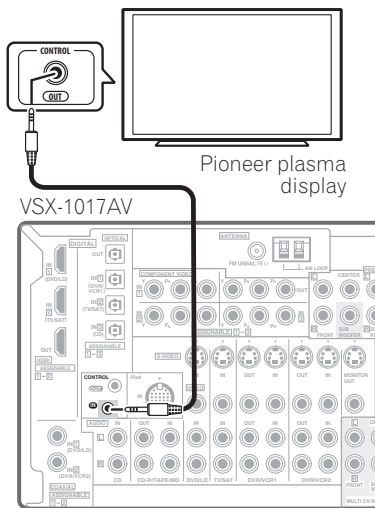

### Important

- If you connect to a Pioneer plasma display using an SR+ cable, you will need to point the remote control at the plasma display remote sensor to control the receiver. In this case, you won't be able to control the receiver using the remote control if you switch the plasma display off.
- Before you can use the extra SR+ features, you need to make a few settings in the receiver. See *The Input Assign menu* on page 52 and *SR+ Setup for Pioneer plasma displays* on page 54 for detailed instructions.

- Use a 3-ringed miniplug SR+ cable to connect the CONTROL IN jack of this receiver with the CONTROL OUT jack of your plasma display.

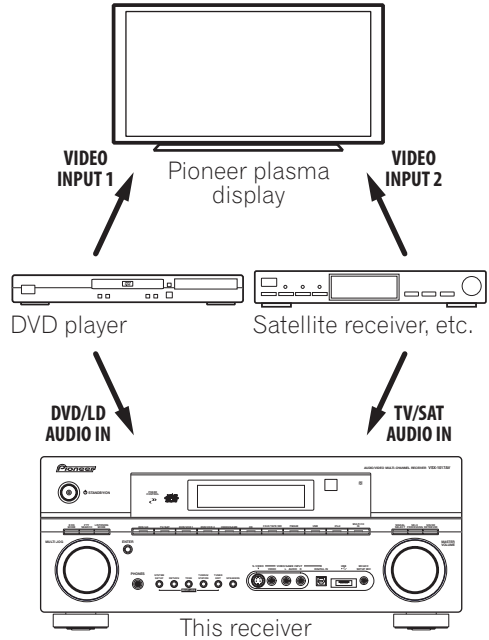

To make the most of the SR+ features, you should connect your source components (DVD player, etc.) in a slightly different way to that described in this chapter. For each component, connect the video output directly to the plasma display, and just connect the audio (analog and/or digital) to this receiver.

### Note

- 1 The 3-ringed SR+ cable from Pioneer is commercially available under the part number ADE7095. Contact the Pioneer Customer Support division for more information on obtaining an SR+ cable (you can also use a commercially available 3-ringed mini phone plug for the connection).
- 2 This receiver is compatible with all SR+ equipped Pioneer plasma displays from 2003 onward.

## Using the SR+ mode with a Pioneer plasma display

When connected using an SR+ cable, a number of features become available to make using this receiver with your Pioneer plasma display even easier. These features include:

- On-screen displays when making receiver settings, such as speaker setup, MCACC setup, and so on.
- On-screen volume display.
- On-screen display of listening mode.
- Automatic video input switching on the plasma display.
- Automatic volume muting on the plasma display.

See also *SR+ Setup for Pioneer plasma displays* on page 54 for more on setting up the receiver.

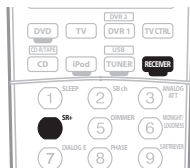

### 1 Make sure that the plasma display and this receiver are switched on and that they are connected with the SR+ cable.

See *Using this receiver with a Pioneer plasma display* above for more on connecting these components.

- Make sure you have also selected the display input to which you've connected the receiver in *The Input Assign menu* on page 52.

### 2 To switch SR+ mode on/off, press RECEIVER, then the SR+ button.

The front panel display shows **SR+ ON** or **SR+ OFF**.

- The automatic volume muting feature is enabled separately; see *SR+ Setup for Pioneer plasma displays* on page 54.

## Chapter 10: Other Settings

### The Input Assign menu

You only need to make settings in the Input Assign menu if you didn't hook up your digital equipment according to the default settings for the digital inputs, or if you have connected equipment using component video cables.

- 1 Press **RECEIVER** on the remote control, then press the **SETUP** button.

An on-screen display (OSD) appears on your TV. Use **↑/↓/←/→** and **ENTER** to navigate through the screens and select menu items. Press **RETURN** to confirm and exit the current menu.

- 2 Select 'Input Assign' from the System Setup menu.

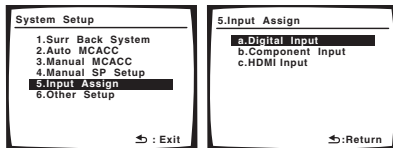

### Assigning the digital inputs

- Default settings:

**Coaxial - 1 – DVD/LD**  
**Coaxial - 2 – DVR 2**  
**Optical - 1 – DVR 1**  
**Optical - 2 – TV/SAT**  
**Optical - 3 – CD**

You only need to do this if you didn't hook up your digital equipment according to the default settings for the digital inputs (see above). This setting tells the receiver what digital equipment is hooked up to which terminal so the buttons on the remote correspond to what you have hooked up.

- 1 Select 'Digital Input' from the Input Assign menu.

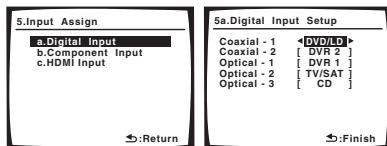

- 2 Select the number of the digital input to which you've connected the digital component.

The numbers correspond with the numbers beside the inputs on the back of the receiver.

- 3 Select the component that corresponds with the one you connected to that input.

Select between **DVD/LD**, **TV/SAT**, **CD**, **CD-R**, **DVR 1**, **DVR 2** or **OFF**.

- Use **←/→** and **ENTER** to do this.
- If you assign a digital input to a certain function (for example, **DVD/LD**) then any digital inputs previously assigned to that function will automatically be switched off.

- 4 When you're finished, press **RETURN**.

You return to the Input Assign menu.

### Assigning the component video inputs

- Default settings:

**Component 1 – OFF**

**Component 2 – OFF**

**Component 3 – OFF**

If you used component video cords to connect your video equipment you must tell the receiver which device it is, or else you may see the S-video or composite video input instead of the component video signal. For more on this, see *Using the component video jacks* on page 14.

- 1 Select 'Component Input' from the Input Assign menu.

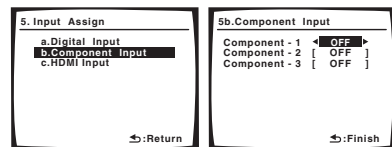

- 2 Select the number of the component video input to which you've connected your video component.

The numbers correspond with the numbers beside the inputs on the back of the receiver.

- 3 Select the component that corresponds with the one you connected to that input.

Select between **DVD/LD**, **TV/SAT**, **DVR 1**, **DVR 2** or **OFF**.

- Use **←/→** and **ENTER** to do this.

- Make sure you have made audio connections from the component to the corresponding inputs on the rear of the receiver.
- If you connect any source component to the receiver using a component video input, you should also have your TV connected to this receiver's component video **MONITOR** output (downconverting component video is not possible after assigning an input).

- 4 When you're finished, press **RETURN**.

You return to the Input Assign menu.

## Assigning the HDMI inputs

- Default settings:

**HDMI - 1 – DVD/LD**

**HDMI - 2 – TV/SAT**

You only need to change this setting when you didn't connect your HDMI component according to the default settings for the HDMI input terminals (see above). By specifying the type of the connected component and to which input terminal it is connected, video signals can be delivered properly when you select an HDMI component as the input source.

### 1 Select 'HDMI Input' from the Input Assign menu.

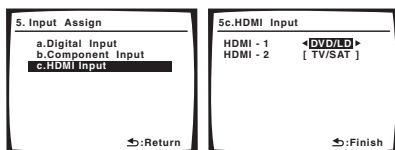

### 2 Select the number of the HDMI input to which you've connected your video component.

The numbers correspond with the numbers beside the inputs on the back of the receiver.

### 3 Select the component that corresponds with the one you connected to that input.

Select between **DVD/LD**, **TV/SAT**, **DVR 1**, **DVR 2** or **OFF**.

- Use **←/→** and **ENTER** to do this.
- To hear audio from your HDMI component (through this system), you must also make separate audio connections to the corresponding inputs on the rear of the receiver. For more on this, see *Connecting the multichannel analog inputs* on page 47.
- If you connect any video component to the receiver using HDMI, you should also have your TV connected to this receiver's HDMI output.

### 4 When you're finished, press RETURN.

You return to the Input Assign menu.

## The Other Setup menu

The Other Setup menu is where you can make customized settings to reflect how you are using the receiver.

### 1 Press RECEIVER on the remote control, then press the SETUP button.

An on-screen display (OSD) appears on your TV. Use **↑/↓/←/→** and **ENTER** to navigate through the screens and select menu items. Press **RETURN** to confirm and exit the current menu.

### 2 Select 'Other Setup' then press ENTER.

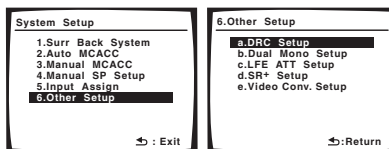

### 3 Select the setting you want to adjust.

If you are doing this for the first time, you may want to adjust these settings in order:

- **DRC Setup** – Specify the amount of dynamic range adjustment to Dolby Digital or DTS soundtracks (see *Dynamic Range Control Setup* below).
- **Dual Mono Setup** – Isolate one channel when listening to discs with dual mono encoding (see *Dual Mono Setup* below).
- **LFE ATT Setup** – Choose the attenuator level for the LFE channel (*LFE Attenuator Setup* on page 54).
- **SR+ Setup** – Specify how you want to control your Pioneer plasma display (*SR+ Setup for Pioneer plasma displays* on page 54).
- **Video Conv. Setup** – Specify if you want analog video signals converted for output to your TV (*Video Converter Setup* on page 54).

### 4 Make the adjustments necessary for each setting, pressing RETURN to confirm after each screen.

## Dynamic Range Control Setup

- Default setting: **OFF**

This setting specifies the amount of dynamic range adjustment to Dolby Digital and DTS movie soundtracks. You may want to use this when listening to surround sound at low volumes.

### 1 Select 'DRC Setup' from the Other Setup menu.

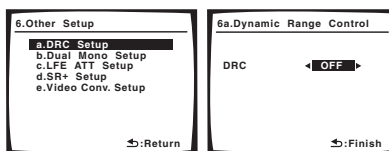

### 2 Choose the setting that you want.

- **OFF** – No dynamic range adjustment (use when listening at higher volume).
- **MID** – Mid setting.
- **MAX** – Dynamic range is reduced (loud sounds are reduced in volume while quieter sounds are increased).

### 3 When you're finished, press RETURN.

You return to the Other Setup menu.

## Dual Mono Setup

- Default setting: **CH1**

You can specify how dual mono encoded Dolby Digital and DTS soundtracks should be played. Dual mono is not widely used, but is sometimes necessary when two languages need to be sent to separate channels.

- 1 Select 'Dual Mono Setup' from the Other Setup menu.

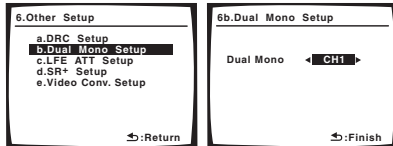

- 2 Choose the setting that you want.
  - **CH1** – Only channel 1 is played
  - **CH2** – Only channel 2 is played
  - **CH1 CH2** – Both channels are played through the front speakers

- 3 When you're finished, press RETURN.

You return to the Other Setup menu.

## LFE Attenuator Setup

- Default setting: **ATT 0dB**

Some Dolby Digital and DTS audio sources include ultra-low bass tones. Set the LFE attenuator as necessary to prevent the ultra-low bass tones from distorting the sound from the speakers.

- 1 Select 'LFE ATT Setup' from the Other Setup menu.

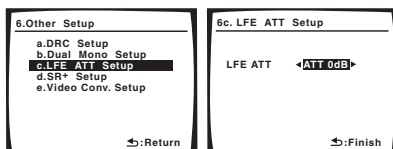

- 2 Choose the setting that you want.
  - **ATT 0dB** – No limiting (recommended)
  - **ATT 10dB** – 10 dB of limiting
  - **LFE OFF** – No sound from LFE channel

- 3 When you're finished, press RETURN.

You return to the Other Setup menu.

## SR+ Setup for Pioneer plasma displays

- Default setting: **OFF** (all settings)

Make the following settings if you have connected a Pioneer plasma display to this receiver using an SR+ cable. Note that the number of settings available will depend on the plasma display you've connected.

See also *Using this receiver with a Pioneer plasma display* on page 50.

- 1 Select 'SR+ Setup' from the Other Setup menu.

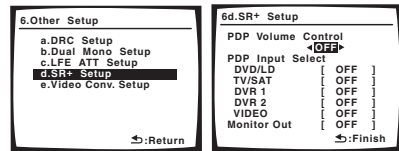

- 2 Select the 'PDP Volume Control' setting you want.

- **OFF** – The receiver does not control the volume of the plasma display.
- **ON** – When the receiver is switched to one of the inputs that use the plasma display (DVD/LD, or another function below), the volume on the plasma display is muted so only sound from the receiver is heard.

- 3 Assign any input source connected to the plasma display to the corresponding input number.

This matches the receiver's input source with a numbered video input on the plasma display. For example, assign **DVD/LD** to **input-2** if you have connected your DVD video output to video input 2 on the plasma display.

- The **Monitor Out** should be set to the input that you've used to connect this receiver to your plasma display.

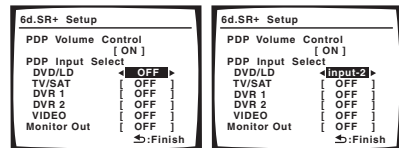

- 4 When you're finished, press RETURN.

You return to the Other Setup menu.

## Video Converter Setup

- Default setting: **ON**

The video converter allows you to see analog video sources through all of this receiver's **MONITOR VIDEO OUT** jacks. Note that the converter gives priority to component, S-video, then composite (in that order). See *About the video converter* on page 12 for more on this.

- 1 Select 'Video Conv. Setup' from the Other Setup menu.

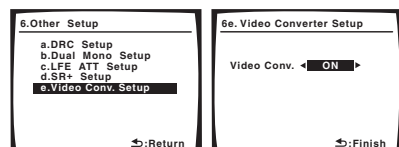

- 2 Choose the setting that you want.

- **ON** – All analog video signals are output from the **MONITOR VIDEO OUT** jacks.
- **OFF** – No conversion between video formats.

- 3 When you're finished, press RETURN.

You return to the Other Setup menu.

## Chapter 11: Using other functions

### Making an audio or a video recording

You can make an audio or a video recording from the built-in tuner, or from an audio or video source

connected to the receiver (such as a CD player or TV).<sup>1</sup>

Keep in mind you can't make a digital recording from an analog source or vice-versa, so make sure the components you are recording to/from are hooked up in the same way (see *Connecting your equipment* on page 11 for more on connections).

Since the video converter is not available when making recordings (from the video **OUT** jacks) make sure to use the same type of video cable for connecting your recorder as you used to connect your video source (the one you want to record) to this receiver. For example, you must connect your recorder using S-video if your source has also been connected using S-video.

For more information about video connections, see *Connecting a DVD/HDD recorder, VCR and other video sources* on page 14.

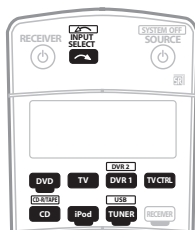

#### 1 Select the source you want to record.

Use the input source buttons (or **INPUT SELECT**).

- If necessary, press **SIGNAL SEL (SIGNAL SELECT)** to select the input signal corresponding to the source component (see *Choosing the input signal* on page 30 for more on this).

#### 2 Prepare the source you want to record.

Tune to the radio station, load the CD, video, DVD etc.

#### 3 Prepare the recorder.

Insert a blank tape, MD, video etc. into the recording device and set the recording levels.

Refer to the instructions that came with the recorder if you are unsure how to do this. Most video recorders set the audio recording level automatically—check the component's instruction manual if you're unsure.

#### 4 Start recording, then start playback of the source component.

### Reducing the level of an analog signal

The input attenuator lowers the input level of an analog signal when it's too strong. You can use this if you find the that the **OVER** indicator is lights often, or you can hear distortion in the sound.<sup>2</sup>

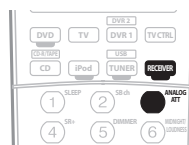

- Press **RECEIVER** then press **ANALOG ATT** to switch the input attenuator on or off.

### Using the sleep timer

The sleep timer switches the receiver into standby after a specified amount of time so you can fall asleep without worrying about the receiver being left on all night. Use the remote control to set the sleep timer.

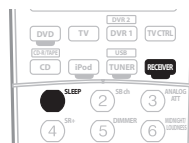

- Press **RECEIVER** then press **SLEEP** repeatedly to set the sleep time.

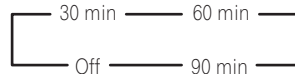

- You can check the remaining sleep time at any time by pressing **SLEEP** once. Pressing repeatedly will cycle through the sleep options again.<sup>3</sup>

#### Note

- The receiver's volume, DSP (the tone controls, for example), and surround effects have no effect on the recorded signal.
  - Some digital sources are copy-protected, and can only be recorded in analog.
  - Some video sources are copy-protected. These cannot be recorded.
- The attenuator isn't available with digital sources.
- You can also switch off the sleep timer simply by switching off the receiver.

## Dimming the display

You can choose between four brightness levels for the front panel display. Note that when selecting sources, the display automatically brightens for a few seconds.

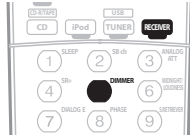

- Press RECEIVER then press DIMMER repeatedly to change the brightness of the front panel display.

## Switching the speaker impedance

We recommend using speakers of 8  $\Omega$  with this system, but it is possible to switch the impedance setting if you plan to use speakers with a 6  $\Omega$  impedance rating. Use the front panel controls to do this.

- With the receiver in standby, press  $\odot$  STANDBY/ON while holding down the SPEAKERS button.

Each time you do this, you switch between the impedance settings:

- **SP 6 OHM** – Use this setting if your speakers are rated at 6  $\Omega$ .
- **SP 8 OHM** – Use this setting if your speakers are rated at 8  $\Omega$  or more.

## Resetting the system

Use this procedure to reset all the receiver's settings to the factory default. Use the front panel controls to do this.

- 1 Switch the receiver into standby.
- 2 While holding down the front panel TONE button, press and hold  $\odot$  STANDBY/ON for about three seconds.

The display shows **RESET?**.

- 3 Press the front panel ENTER button.

The display shows **RESET OK?**.

- 4 Press SYSTEM SETUP to confirm.

**OK** appears in the display to indicate that the receiver has been reset to the factory default settings.

- Note that all settings will be saved, even if the receiver is unplugged.



## Chapter 12:

# Controlling the rest of your system

## Setting the remote to control other components

Most components can be assigned to one of the input source buttons (such as **DVD/LD** or **CD**) using the component's manufacturer preset code stored in the remote.

However, there are cases where only certain functions may be controllable after assigning the proper preset code, or the codes for the manufacturer in the remote control will not work for the model that you are using.

### Note

- You can cancel or exit any of the steps by pressing **RECEIVER**. To go back a step, press **RETURN**.
- After one minute of inactivity, the remote automatically exits the operation.

## Selecting preset codes directly



**1 While pressing the RECEIVER button, press SETUP.**  
The remote LCD display shows **SETUP**.

**2 Use ↑/↓ to select PRESET then press ENTER.**

**3 Press the input source button for the component you want to control then press ENTER.**

The LCD on the remote displays the component you want to control (for example **DVD** or **DVR**).<sup>1</sup>

**4 Use ↑/↓ to select the first letter of the brand name of your component then press ENTER.**

This should be the manufacturer's name (for example, **P** for Pioneer).

**5 Use ↑/↓ to select the manufacturer's name from the list then press ENTER.**

**6 Use ↑/↓ to select the proper code from the list, then try using this remote with your component.**

The code should start with the component type (for example, **DVD 020**). If there is more than one, start with the first one.<sup>2</sup>

### Note

<sup>1</sup> You can't assign the **RECEIVER**, **TUNER** or **USB** buttons.

<sup>2</sup> • When using a Pioneer HDD recorder, please select **PIONEER DVR 487, 488, 489 or 493**.

• When using a Pioneer plasma display released prior to summer 2005, please select preset codes **600** or **231**.

To try out the remote control, switch the component on or off (into standby) by pressing **SOURCE**  $\phi$ . If it doesn't seem to work, select the next code from the list (if there is one).

**7 If your component is controlled successfully, press ENTER to confirm.**

The remote LCD display shows **OK**.

## Resetting the remote control presets

This will erase all preset remote control preset codes and programmed buttons.

**1 While pressing the RECEIVER button, press SETUP.**  
The remote LCD display shows **SETUP**.

**2 Use ↑/↓ to select RESET then press ENTER.**  
**RESET** flashes in the LCD display.

**3 Press and hold ENTER for about two seconds.**  
The LCD shows **OK** to confirm the remote presets have been erased.

## Confirming preset codes

Use this feature to check which preset code is assigned to an input source button.

**1 While pressing the RECEIVER button, press SETUP.**  
The remote LCD display shows **SETUP**.

**2 Use ↑/↓ to select READ ID then press ENTER.**  
The LCD on the remote prompts you for the input source button you want to check.

**3 Press the button of the component for which you want to check the preset code, then press ENTER.**  
The brand name and preset code appears in the display for three seconds.

## Direct function

- Default setting: **ON**

You can use the direct function feature to control one component using the remote control while at the same time, using your receiver to playback a different component. This could let you, for example, use the remote control to set up and listen to a CD on the receiver and then use the remote control to rewind a tape in your VCR while you continue to listen to your CD player.

When direct function is on, any component you select (using the input source buttons) will be selected by both the receiver and the remote control. When you turn direct function off, you can operate the remote control without affecting the receiver.<sup>1</sup>

**1 While pressing the RECEIVER button, press SETUP.**  
The remote LCD display shows **SETUP**.

**2 Use ↑/↓ to select DIRECT F then press ENTER.**  
The LCD on the remote prompts you for the button of the input source you want to control.

**3 Press the input source button for the component you want to control then press ENTER.**

**4 Use ↑/↓ to switch direct function ON or OFF then press ENTER.**

The LCD shows **OK** to confirm the setting.

**4 Use ↑/↓ to select CODE EDT then press ENTER.**

To erase any previously stored multi-operations (or shutdown sequences) select **CODE ERS** above.

**5 Use ↑/↓ to select a command in the sequence then press ENTER.**

If this is the first command in the sequence, select **1ST CODE**. Otherwise, simply choose the next command in the sequence. **PRES KEY** flashes after you press **ENTER**.

**6 If necessary, press the input source button for the component whose command you want to input.**

This is only necessary if the command is for a new component (input source).

**7 Select the button for the command you want to input.**

The following remote control commands can be selected:

## Multi Operation and System Off

The Multi Operation feature allows you to program a series of up to five commands for the components in your system. For example, you could turn on your TV, turn on your DVD player and start playing the loaded DVD using only two buttons on the remote control.

Similar to multi operations, System Off allows you to use one button to stop and switch off a series of components in your system at the same time.<sup>2</sup>

## Programming a multi-operation or a shutdown sequence



**1 While pressing the RECEIVER button, press SETUP.**  
The remote LCD display shows **SETUP**.

**2 Use ↑/↓ to select MULTI OP or SYS OFF from the menu and press ENTER.**

If you selected **Multi Operation (MULTI OP)**, the LCD on the remote prompts you for an input source button.

If you selected **System Off (SYSOFF)**, go to step 4.

**3 Press the input source button for the component that will start the multi-operation then press ENTER.**

For example, if you want to start the sequence by switching on your DVD player, press **DVD**.

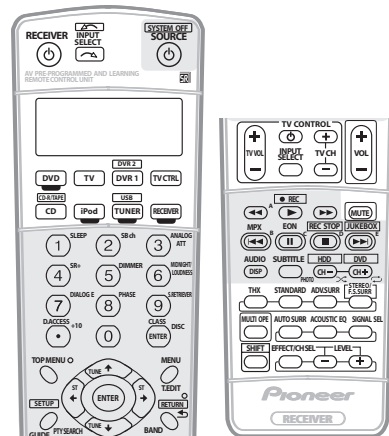

- You don't need to program the receiver to switch on or off. This is done automatically.

With Pioneer components, you don't need to:

- program the power to switch off in a shutdown sequence (except DVD recorders);
- program the power to switch on if it's the source component selected in step 3;
- program a Pioneer TV or monitor to switch on if the input function (selected in step 2) has video input terminals;

These take priority in multi operations (not shutdown).

### Note

<sup>1</sup> You can't use direct function with the **TV CTRL** function.

<sup>2</sup> Before Multi Operation and System Off will work correctly, you must setup the remote to work with your TV and other components (see *Setting the remote to control other components* on page 57 for more on this).

- Some units may take some time to power up, in which case multiple operations may not be possible.
- Power on and off commands only work with components that have a standby mode.

**8 Repeat steps 5–7 to program a sequence of up to five commands.**

**9 When you're finished, use  $\uparrow/\downarrow$  to select EDITEXIT from the menu and press ENTER.**

You will return to the remote control **SETUP** menu. Select \* **EXIT** \* again to exit.

### Using multi operations

You can start multi operations with the receiver switched on, or in standby.

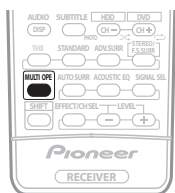

**1 Press MULTI OPE.**

**MULTI OP** flashes in the display.

**2 Press an input source button that has been set up with a multi operation.**

The receiver switches on (if it was in standby) and the programmed multi operation is performed automatically.

### Using System off

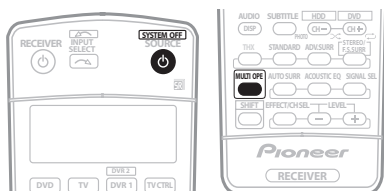

**1 Press MULTI OPE.**

**MULTI OP** flashes in the display.

**2 Press  $\odot$  SOURCE.**

The command sequence you programmed will run, then all Pioneer components will switch off<sup>1</sup>, followed by this receiver.

### Controls for TVs

This remote control can control components after entering the proper codes or teaching the receiver the commands (see *Setting the remote to control other components* on page 57 for more on this). Use the input source buttons to select the component.

- The **TV CONTROL** buttons on the remote control are dedicated to control the TV assigned to the **TV CTRL** button. If you have two TVs, assign the main TV to the **TV CTRL** button.

Button(s)	Function	Components
<b>TV <math>\odot</math></b>	Press to switch the component assigned to the <b>TV CTRL</b> button on or off.	Cable TV/ Satellite TV/TV
<b>INPUT SELECT</b>	Switches the TV input. (Not possible with all models.)	TV
<b>TV CH +/-</b>	Selects channels.	Cable TV/ Satellite TV/TV
<b>TV VOL +/-</b>	Adjust the TV volume.	Cable TV/ Satellite TV/TV
<b>SOURCE <math>\odot</math></b>	Switches the TV or CATV between standby and on.	Cable TV/ Satellite TV/TV
<b>◀◀</b>	Use to choose the 'A' commands on a Satellite TV menu.	Satellite TV
<b>◀◀◀</b>	Use to choose the RED/B commands on a Satellite TV/TV menu.	Satellite TV/TV
<b>▶▶▶</b>	Use to choose the CYAN/E commands on a Satellite TV/TV menu.	Satellite TV/TV
<b>  </b>	Use to choose the GREEN/C commands on a Satellite TV/TV menu.	Satellite TV/TV
<b>■</b>	Use to choose the YELLOW/D commands on a Satellite TV/TV menu.	Satellite TV/TV
<b>AUDIO / DISP</b>	Use to switch audio tracks.	Satellite TV/TV
<b>SUBTITLE</b>	Use to return to the previously selected channel.	Cable TV/ Satellite TV/TV
<b>GUIDE</b>	Use as the <b>GUIDE</b> button for navigating.	Cable TV/ Satellite TV/TV
<b>RETURN</b>	Use to select <b>RETURN</b> or <b>EXIT</b> .	Satellite TV/TV
<b>Number buttons</b>	Use to select a specific TV channel.	Cable TV/ Satellite TV/TV
<b>+10 button</b>	Use to add a decimal point when selecting a TV channel.	Satellite TV/TV
<b>ENTER/ DISC</b>	Use to enter a channel.	Cable TV/ Satellite TV/TV
<b>MENU</b>	Select the menu screen.	Cable TV/ Satellite TV/TV
<b><math>\uparrow/\downarrow/\leftarrow/\rightarrow</math> &amp; ENTER</b>	Select, adjust and navigate items on the menu screen.	Cable TV/ Satellite TV/TV
<b>TOP MENU</b>	Switches <b>TEXT ON/OFF</b> for TVs. TV	TV

#### Note

<sup>1</sup> In order to avoid accidentally switching off a DVD recorder that is currently recording, no DVD recorder power off codes are sent.

## Controls for other components

This remote control can control these components after entering the proper codes or teaching the receiver the commands (see *Setting the remote to control other components* on page 57 for more on this). Use the input source buttons to select the component.

Button(s)	Function	Components
<b>SOURCE</b>	Press to switch the component between standby and on.	CD/MD/CD-R/DVD/LD/DVR player/VCR/Cassette deck
<b>◀◀</b>	Press to return to the start of the current track or chapter. Repeated presses skips to the start of previous tracks or chapters.	CD/MD/CD-R/DVD/LD player
<b>▶▶</b>	Press to advance to the start of the next track or chapter. Repeated presses skips to the start of following tracks or chapters.	CD/MD/CD-R/DVD/LD player
<b>⏸</b>	Pause playback or recording.	CD/MD/CD-R/DVD/LD/DVR player/VCR/Cassette deck
<b>▶</b>	Start playback.	CD/MD/CD-R/DVD/LD/DVR player/VCR/Cassette deck
<b>▶▶▶</b>	Hold down for fast forward playback.	CD/MD/CD-R/DVD/LD/DVR player/VCR/Cassette deck
<b>◀◀◀</b>	Hold down for fast reverse playback.	CD/MD/CD-R/DVD/LD/DVR player/VCR/Cassette deck
<b>■</b>	Stops playback.	CD/MD/CD-R/DVD/LD/DVR player/VCR/Cassette deck
<b>● REC (SHIFT+▶)</b>	Starts recording.	MD/CD-R/DVR player/VCR/Cassette deck
<b>REC STOP (SHIFT+■)</b>	Stops recording.	DVR player
<b>JUKEBOX (SHIFT+▶▶▶)</b>	Switches to the Jukebox feature.	DVR player
Number buttons	Directly access tracks on a program source. Use the number buttons to navigate the on-screen display.	CD/MD/CD-R/LD player/VCR DVD/DVR player
<b>+10</b> button	Selects tracks higher than 10. (For example, press <b>+10</b> then <b>3</b> to select track 13.)	CD/MD/CD-R/LD player/VCR

Button(s)	Function	Components
<b>ENTER/DISC</b>	Chooses the disc. Use as the <b>ENTER</b> button. Displays the setup screen for DVR players. Changes sides of the LD.	Multiple CD player VCR/DVD player DVR player LD player
<b>TOP MENU</b>	Displays the disc 'top' menu of a DVD player.	DVD/DVR player
<b>MENU</b>	Displays menus concerning the current DVD or DVR you are using.	DVD/DVR player
<b>↑</b>	Pauses the tape.	Cassette deck
<b>↓</b>	Stops the tape.	Cassette deck
<b>ENTER</b>	Starts playback.	Cassette deck
<b>◀/▶</b>	Fast rewinds/fast forwards the tape.	Cassette deck
<b>↑/↓/◀/▶ &amp; ENTER</b>	Navigates DVD menu/options.	DVD/DVR player
<b>GUIDE</b>	Press to access the DVD player setup screen.	DVD/DVR player
<b>CH +/-</b>	Selects channels.	VCR/DVD/DVR player
<b>AUDIO</b>	Changes the audio language or channel.	DVD/DVR player
<b>SUBTITLE</b>	Displays/changes the subtitles on multilingual DVDs.	DVD/DVR player
<b>SHIFT +SUBTITLE</b>	Switches to the VCR controls when using a VCR/DVD/HDD recorder.	VCR/DVD/DVR player
<b>HDD (SHIFT + CH-)</b>	Switches to the hard disk controls when using a DVD/HDD recorder.	DVR player
<b>DVD (SHIFT + CH+)</b>	Switches to the DVD controls when using a DVD/HDD recorder.	DVR player

## Operating other Pioneer components with this unit's sensor

Many Pioneer components have SR **CONTROL** jacks which can be used to link components together so that you can use just the remote sensor of one component. When you use a remote control, the control signal is passed along the chain to the appropriate component.<sup>1</sup>

### Important

- Note that if you use this feature, *make sure that you also have at least one set of analog audio, video or HDMI jacks connected* to another component for grounding purposes.

#### 1 Decide which component you want to use the remote sensor of.

When you want to control any component in the chain, this is the remote sensor at which you'll point the corresponding remote control.

#### 2 Connect the **CONTROL OUT** jack of that component to the **CONTROL IN** jack of another Pioneer component.

Use a cable with a mono mini-plug on each end for the connection.

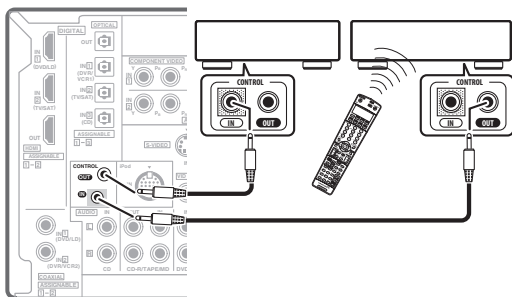

#### 3 Continue the chain in the same way for as many components as you have.

### Note

- If you want to control all your components using this receiver's remote control, refer to *Setting the remote to control other components* on page 57. If you have connected a remote control to the **CONTROL IN** jack (using a mini-plug cable), you won't be able to control this unit using the remote sensor.
  - See *Using this receiver with a Pioneer plasma display* on page 50 if you are connecting a Pioneer plasma display.

## Chapter 13:

## Additional information

## Troubleshooting

Incorrect operations are often mistaken for trouble and malfunctions. If you think that there is something wrong with this component, check the points below. Sometimes the trouble may lie in another component. Investigate the other components and electrical appliances being used. If the trouble cannot be rectified even after exercising the checks listed below, ask your nearest Pioneer authorized independent service company to carry out repair work.

## Power

Symptom	Remedy
The power does not turn on.	<ul style="list-style-type: none"> <li>• Make sure that the power cable is plugged in to an active power outlet.</li> <li>• Try disconnecting from the power outlet, then plugging back in.</li> </ul>
The receiver suddenly switches off or the Phase Control indicator blinks.	<ul style="list-style-type: none"> <li>• Check that there are no loose strands of speaker wire touching the rear panel or another set of wires. If so, re-attach the speaker wires, making sure there are no stray strands.</li> <li>• The receiver may have a serious problem. Disconnect from the power and call a Pioneer authorized independent service company.</li> </ul>
During loud playback the power suddenly switches off.	<ul style="list-style-type: none"> <li>• Turn down the volume.</li> <li>• Lower the 40 Hz and 125 Hz equalizer levels in the <i>Manual MCACC setup</i> on page 39.</li> <li>• Try switching on the digital safety feature (put the receiver into standby, hold down the <b>SYSTEM SETUP</b> button on the front panel and press <b>STANDBY/ON</b> to switch between <b>SAFETY ON</b> and <b>SAFETY OFF</b>). If the power switches off even with <b>SAFETY ON</b> selected, turn down the volume.</li> </ul>
The unit does not respond when the buttons are pressed.	<ul style="list-style-type: none"> <li>• Try switching the receiver off then back on again.</li> <li>• Try disconnecting the power cable, then connect again.</li> </ul>
<b>AMP ERR</b> blinks in the display, then the power automatically switches off. The <b>MCACC</b> blinks and the power does not turn on.	<ul style="list-style-type: none"> <li>• The receiver may have a serious problem. Do not try switching the receiver on. Contact a Pioneer authorized independent service company for help.</li> </ul>
<b>FAN STOP</b> blinks in the display, then the power automatically switches off.	<ul style="list-style-type: none"> <li>• Something is obstructing the fan. Remove the obstruction and try switching the receiver back on. If the fan is still not working, or you can't remove the object, unplug the receiver from the wall and call a Pioneer authorized independent service company.</li> <li>• The fan is malfunctioning. Unplug the receiver from the wall and call a Pioneer authorized independent service company.</li> </ul>
<b>OVERHEAT</b> blinks in the display then the power automatically switches off.	<ul style="list-style-type: none"> <li>• Allow the unit to cool down in a well-ventilated place before switching back on. Check the safety precautions on pages 2 and 3 for information on improving heat dispersal.</li> </ul>

## No sound

Symptom	Remedy
No sound is output when an input source is selected. No sound output from the front speakers.	<ul style="list-style-type: none"> <li>• Check the volume, mute setting (press <b>MUTE</b>) and speaker setting (press <b>SPEAKERS</b>).</li> <li>• Make sure the correct input source is selected.</li> <li>• Check that the MCACC setup microphone is disconnected.</li> <li>• Make sure the correct input signal is selected (press <b>SIGNAL SELECT</b>).</li> <li>• Check that the source component is connected properly (see <i>Connecting your equipment</i> on page 11).</li> <li>• Check that the speakers are connected properly (see <i>Connecting the speakers</i> on page 18).</li> </ul>
No sound from the surround or center speakers.	<ul style="list-style-type: none"> <li>• Check that the stereo mode or the Front Stage Surround Advance mode isn't selected; select one of the surround listening modes (see <i>Listening in surround sound</i> on page 27).</li> <li>• Check that the surround/center speakers are not set to <b>NO</b> (see <i>Speaker Setting</i> on page 43).</li> <li>• Check the channel level settings (see <i>Channel Level</i> on page 44).</li> <li>• Check the speaker connections (see <i>Connecting the speakers</i> on page 18).</li> </ul>

Symptom	Remedy
No sound from surround back speakers.	<ul style="list-style-type: none"> <li>• Check that the surround back speakers are set to <b>LARGE</b> or <b>SMALL</b> (see <i>Speaker Setting</i> on page 43).</li> <li>• Make sure surround back processing is set to <b>SBch ON</b> (see <i>Using surround back channel processing</i> on page 30).</li> <li>• If the source is Dolby Surround EX or DTS-ES with no flag to indicate 6.1 compatibility, then with surround back processing set to <b>SBch Auto</b>, there will be no sound from the surround back speakers. In this case, set to <b>SBch ON</b> (see <i>Using surround back channel processing</i> on page 30).</li> <li>• If the source does not have 6.1 playback channels, make sure that surround back processing is set to <b>SBch ON</b> and a surround mode is selected (see <i>Listening in surround sound</i> on page 27).</li> <li>• Check the speaker connections (see <i>Connecting the speakers</i> on page 18). If only one surround back speaker is connected, make sure it's connected to the left channel speaker terminal.</li> </ul>
No sound from subwoofer.	<ul style="list-style-type: none"> <li>• Check that the subwoofer is connected properly, switched on and the volume turned up.</li> <li>• If your subwoofer has a sleep function, make sure it is switched off.</li> <li>• Make sure that the Subwoofer setting is <b>YES</b> or <b>PLUS</b> (see <i>Speaker Setting</i> on page 43).</li> <li>• The crossover frequency may be set too low; try setting it higher to match the characteristics of your other speakers (see <i>Speaker Setting</i> on page 43).</li> <li>• If there is very little low frequency information in the source material, change your speaker settings to Front: <b>SMALL</b> / Subwoofer: <b>YES</b>, or Front: <b>LARGE</b> / Subwoofer: <b>PLUS</b> (see <i>Speaker Setting</i> on page 43).</li> <li>• Check the speaker level settings (see <i>Channel Level</i> on page 44).</li> </ul>
No sound from one speaker.	<ul style="list-style-type: none"> <li>• Check the speaker connection (see <i>Connecting the speakers</i> on page 18).</li> <li>• Check the speaker level settings (see <i>Channel Level</i> on page 44).</li> <li>• Check that the speaker hasn't been set to <b>NO</b> (see <i>Speaker Setting</i> on page 43).</li> <li>• The channel may not be recorded in the source. By using one of the advanced effect listening mode, you may be able to create the missing channel (see <i>Listening in surround sound</i> on page 27).</li> </ul>
Sound is produced from analog components, but not from digital ones (DVD, LD, CD-ROM etc.).	<ul style="list-style-type: none"> <li>• Check that the input signal type is set to <b>DIGITAL</b> (see <i>Choosing the input signal</i> on page 30).</li> <li>• Make sure that the digital input is assigned correctly for the input jack the component is connected to (see <i>The Input Assign menu</i> on page 52).</li> <li>• Check the digital output settings on the source component.</li> <li>• If the source component has a digital volume control, make sure this is not turned down.</li> <li>• Make sure that the multichannel analog inputs are not selected. Select any other input source.</li> </ul>
No sound is output or a noise is output when Dolby Digital/DTS software is played back.	<ul style="list-style-type: none"> <li>• Check that your DVD player is compatible with Dolby Digital/DTS discs.</li> <li>• Check the digital output settings of your DVD player. Make sure that the DTS signal output is set to On.</li> <li>• If the source component has a digital volume control, make sure this is not turned down.</li> </ul>

## Other audio problems

Symptom	Remedy
Broadcast stations cannot be selected automatically, or there is considerable noise in radio broadcasts.	<p><i>For FM broadcasts</i></p> <ul style="list-style-type: none"> <li>• Fully extend the FM wire antenna, adjust the position for best reception and secure to a wall, etc.</li> <li>• Use an outdoor antenna for better reception (see page 21).</li> </ul> <p><i>For AM broadcasts</i></p> <ul style="list-style-type: none"> <li>• Adjust the position and direction of the AM antenna.</li> <li>• Use an outdoor antenna for better reception (see page 21).</li> <li>• Noise may be caused by interference from other equipment, such as a fluorescent light, motor, etc. Switch off or move the other equipment, or move the AM antenna.</li> </ul>
A multichannel DVD source appears to be downmixed to 2 channels during playback.	<ul style="list-style-type: none"> <li>• Make sure that the multichannel analog inputs are selected (see <i>Selecting the multichannel analog inputs</i> on page 47).</li> </ul>
Noise is output when scanning a DTS CD.	<ul style="list-style-type: none"> <li>• This is not a malfunction of the receiver. The scan function of your player alters the digital information, making it unreadable, resulting in noise being output. Lower the volume when scanning.</li> </ul>
When playing a DTS format LD there is audible noise on the soundtrack.	<ul style="list-style-type: none"> <li>• Make sure that the input signal type is set to <b>DIGITAL</b> (see <i>Choosing the input signal</i> on page 30).</li> </ul>
Can't record audio.	<ul style="list-style-type: none"> <li>• You can only make a digital recording from a digital source, and an analog recording from an analog source.</li> <li>• For digital sources, make sure that what you're recording isn't copy protected.</li> <li>• Check that the <b>OUT</b> jacks are properly connected to the recorders input jacks (see <i>Connecting analog audio sources</i> on page 17).</li> </ul>

Symptom	Remedy
Subwoofer output is very low.	<ul style="list-style-type: none"> <li>To route more signal to the subwoofer, set it to <b>PLUS</b> or set the front speakers to <b>SMALL</b> (see <i>Speaker Setting</i> on page 43).</li> </ul>
Everything seems to be set up correctly, but the playback sound is odd.	<ul style="list-style-type: none"> <li>The speakers may be out of phase. Check that the positive/negative speaker terminals on the receiver are matched with the corresponding terminals on the speakers (see <i>Connecting the speakers</i> on page 18).</li> </ul>
The <b>PHASE CONTROL</b> feature doesn't seem to have an audible effect.	<ul style="list-style-type: none"> <li>If applicable, check that the lowpass filter switch on your subwoofer is off, or the lowpass cutoff is set to the highest frequency setting. If there is a <b>PHASE</b> setting on your subwoofer, set it to 0° (or depending on the subwoofer, the setting where you think it has the best overall effect on the sound).</li> <li>Make sure the speaker distance setting is correct for all speakers (see <i>Speaker Distance</i> on page 45).</li> </ul>
Noise or hum can be heard even when there is no sound being input.	<ul style="list-style-type: none"> <li>Check that personal computers or other digital components connected to the same power source are not causing interference.</li> </ul>
There seems to be a time lag between the speakers and the output of the subwoofer.	<ul style="list-style-type: none"> <li>See <i>Automatically setting up for surround sound (Auto MCACC)</i> on page 8 to set up your system again using MCACC (this will automatically compensate for a delay in the subwoofer output).</li> </ul>
The maximum volume available (shown in the front panel display) is lower than the <b>+12dB</b> maximum.	<ul style="list-style-type: none"> <li>This is not a malfunction. If the levels in <i>Channel Level</i> on page 44 have been adjusted, the maximum volume will change accordingly.</li> </ul>

## Video

Symptom	Remedy
No image is output when an input is selected.	<ul style="list-style-type: none"> <li>Check the video connections of the source component (see page 14).</li> <li>Make sure the input assignment is correct for components connected using component cables (see <i>The Input Assign menu</i> on page 52).</li> <li>Check the video output settings of the source component.</li> <li>Check that the video input you selected on your TV is correct.</li> <li>When the source component is connected to this receiver with a component video cable, you must also connect your TV to this receiver with a component video cable.</li> </ul>
Can't record video.	<ul style="list-style-type: none"> <li>Check that the source is not copy-protected.</li> <li>The video converter is not available when making recordings. Check that the same type of video cable is used for connecting both the recorder and the video source (the one you want to record) to this receiver.</li> </ul>
Noisy, intermittent, or distorted picture.	<ul style="list-style-type: none"> <li>Sometimes a video deck may output a noisy video signal (during scanning, for example), or the video quality may just be poor (with some video game units, for example). The picture quality may also depend on the settings, etc. of your display device. Switch off the video converter and reconnect the source and display device using the same type of connection (component, S-video or composite), then start playback again.</li> </ul>

## Settings

Symptom	Remedy
The Auto MCACC Setup continually shows an error.	<ul style="list-style-type: none"> <li>The ambient noise level may be too high. Keep the noise level in the room as low as possible (see also <i>Problems when using the Auto MCACC Setup</i> on page 10). If the noise level cannot be kept low enough, you will have to set up the surround sound manually (page 39).</li> </ul>
After using the Auto MCACC Setup, the speaker size setting is incorrect.	<ul style="list-style-type: none"> <li>There may have been some low frequency noise in the room from an air-conditioner, motor, etc. Switch off all other appliances in the room and use Auto MCACC Setup again.</li> <li>Depending on a number of factors (room size, speaker placement, etc.) this may occur in some cases. You can change the speaker setting manually in <i>Speaker Setting</i> on page 43 if this is a recurring problem.</li> </ul>
Can't adjust the Fine Speaker Distance setting (page 40) properly.	<ul style="list-style-type: none"> <li>Check that the speakers are all in phase (make sure the positive (+) and negative (-) terminals are matched up properly).</li> </ul>
Most recent settings have been erased.	<ul style="list-style-type: none"> <li>The power cord was disconnected from the wall while adjusting this setting.</li> </ul>



## Display

Symptom	Remedy
The display is dark or off.	<ul style="list-style-type: none"> <li>Press <b>DIMMER</b> on the remote control repeatedly to select a different brightness.</li> </ul>
After making an adjustment the display goes off.	<ul style="list-style-type: none"> <li>Press <b>DIMMER</b> on the remote control repeatedly to select a different brightness.</li> </ul>
You can't get <b>DIGITAL</b> to display when using the <b>SIGNAL SELECT</b> button.	<ul style="list-style-type: none"> <li>Check the digital connections and make sure that the digital inputs are assigned correctly (see <i>The Input Assign menu</i> on page 52).</li> <li>If the multichannel analog inputs are selected, select a different input source.</li> </ul>
The Dolby/DTS indicator doesn't light when playing Dolby/DTS software.	<ul style="list-style-type: none"> <li>These indicators do not light if playback is paused.</li> <li>Check the playback (especially the digital output) settings of the source component.</li> </ul>
When playing a DVD-Audio disc, the DVD player display shows <b>96 kHz</b> . However, the receiver's display does not.	<ul style="list-style-type: none"> <li>This is not a malfunction. 96 kHz audio from DVD-Audio discs is only output from the analog outputs of the DVD player. This receiver cannot show the playback sample rate when using the analog inputs.</li> </ul>
During playback of a DTS 96/24 source, the display doesn't show <b>96 kHz</b> .	<ul style="list-style-type: none"> <li>Make sure that the receiver is set to <b>AUTO</b> or <b>DIGITAL</b> (see <i>Choosing the input signal</i> on page 30).</li> </ul>
When playing Dolby Digital or DTS sources, the receiver's format indicators do not light.	<ul style="list-style-type: none"> <li>Check that the player is connected using a digital connection.</li> <li>Make sure that the receiver is set to <b>AUTO</b> or <b>DIGITAL</b> (see <i>Choosing the input signal</i> on page 30).</li> <li>Check that the player isn't set up so that Dolby Digital and DTS sources are converted to PCM.</li> <li>Ensure that if there are several audio tracks on the disc, the Dolby Digital or DTS is selected.</li> </ul>
When playing certain discs, none of the receiver's format indicators light.	<ul style="list-style-type: none"> <li>The disc may not contain 5.1/6.1 channel material. Check the disc packaging for more on what audio tracks are recorded on the disc.</li> </ul>
When playing a disc, the <b>PL II</b> or <b>Neo:6</b> indicator lights on the receiver.	<ul style="list-style-type: none"> <li>Make sure that the receiver is set to <b>AUTO</b> or <b>DIGITAL</b> (see <i>Choosing the input signal</i> on page 30).</li> <li>If a two channel soundtrack is currently playing (including Dolby Surround encoded), then this is not a malfunction. Check the disc packaging for details about the audio tracks available.</li> </ul>
During playback of a Surround EX or DTS-ES source on the <b>SBch</b> <b>AUTO</b> setting, the <b>EX</b> and <b>ES</b> indicators don't light, or the signal is not properly processed.	<ul style="list-style-type: none"> <li>The source may be Dolby Surround EX / DTS-ES software, but it has no flag to indicate it is 6.1 compatible. Set to <b>SBch ON</b> (see <i>Using surround back channel processing</i> on page 30) then switch to the THX Surround EX or Standard EX listening mode (see <i>Listening in surround sound</i> on page 27).</li> </ul>

## Remote control

Symptom	Remedy
Cannot be remote controlled.	<ul style="list-style-type: none"> <li>Try replacing the batteries in the remote control (see <i>Loading the batteries</i> on page 7).</li> <li>Be sure to operate within 7 meters and a 30° angle of the remote sensor on the front panel (see <i>Operating range of remote control unit</i> on page 23).</li> <li>Check that there are no obstacles between the receiver and the remote control.</li> <li>Make sure that there is no fluorescent or other strong light shining on to the remote sensor.</li> <li>Check the connections of the <b>CONTROL IN</b> jack (see <i>Operating other Pioneer components with this unit's sensor</i> on page 61).</li> </ul>
Other components can't be operated with the system remote.	<ul style="list-style-type: none"> <li>If the battery ran down, the preset codes may have been cleared. Re-enter the preset codes.</li> <li>The preset code may be incorrect. Redo the procedure for entering preset codes.</li> </ul>
The SR cable is connected, but the connected components can't be operated with the remote.	<ul style="list-style-type: none"> <li>Reinsert the SR cable, making sure it's connected to the right jack (see <i>Using this receiver with a Pioneer plasma display</i> on page 50).</li> <li>Make sure that there is an analog or HDMI connection between the units. This is necessary for the SR feature to work.</li> <li>Check that the other component is made by Pioneer. The SR feature only works with Pioneer equipment.</li> </ul>

## USB interface

Symptom	Remedy
USB mass storage device is not recognized by the receiver.	<ul style="list-style-type: none"> <li>• Try switching the receiver off, then on again.</li> <li>• Make sure you have completely inserted the USB connector to this receiver.</li> <li>• Check that the memory format is FAT16 or FAT32 (FAT12, NTFS and HFS are not supported).</li> <li>• USB devices with an internal USB hub are not supported.</li> </ul>
<b>USB ERR3</b> shows in the display when connecting a USB device.	<ul style="list-style-type: none"> <li>• If this message continues to appear after going through all the checks in <i>Important</i> on page 34 of <i>USB playback</i>, take the unit to your nearest Pioneer authorized service center or your dealer for servicing.</li> </ul>
Can't play audio files.	<ul style="list-style-type: none"> <li>• The WMA or MPEG-4 AAC files were recorded using DRM (digital rights management), or the bit rate/sampling rate is not compatible (see <i>Compressed audio compatibility</i> on page 34). This is not a malfunction.</li> </ul>

## HDMI

Symptom	Remedy
No picture or sound.	<ul style="list-style-type: none"> <li>• If the problem still persists when connecting your HDMI component directly to your monitor, please consult the component or monitor manual or contact the manufacturer for support.</li> </ul>
No picture.	<ul style="list-style-type: none"> <li>• Depending in the output settings of the source component, it may be outputting a video format that can't be displayed. Change the output settings of the source, or connect using the component, S-video or composite jacks.</li> </ul>
OSD does not appear.	<ul style="list-style-type: none"> <li>• The OSD will not appear if you have connected using the HDMI output to your TV. Use component, S-video, or composite connections when setting up the system.</li> </ul>
No sound, or sound suddenly ceases.	<ul style="list-style-type: none"> <li>• Since the HDMI audio signal is sent through this receiver to your TV, you need to make separate connections for audio if you want to hear your HDMI component through this system. See <i>Connecting the multichannel analog inputs</i> on page 47 for more on this.</li> <li>• If you've made separate connections for audio, make sure you have assigned the analog/digital jack(s) to the corresponding HDMI input for the component. See <i>Assigning the HDMI inputs</i> on page 53 to do this.</li> <li>• Check the audio output settings of the source component.</li> </ul>

## iPod messages

Symptom	Cause	Action
<b>Error I1</b>	There is a problem with the signal path from the iPod to the receiver.	Switch off the receiver and reconnect the iPod to the receiver. If this doesn't seem to work, try resetting your iPod.
<b>Error I2</b>	The software version being used with the iPod needs to be updated.	Update the software being used with the iPod (software versions prior to iPod update 2004-10-20 are not supported).
<b>No Music Track</b>	There are no playable songs currently stored in the iPod.	Input some music files compatible with iPod playback.



### Note

- If the unit does not operate normally due to external effects such as static electricity disconnect the power plug from the outlet and insert again to return to normal operating conditions.

## Surround sound formats

Below is a brief description of the main surround sound formats you'll find on DVDs, satellite, cable and terrestrial broadcasts, and video cassettes.

### Dolby

The Dolby technologies are explained below. See [www.dolby.com](http://www.dolby.com) for more detailed information.



### Dolby Digital

Dolby Digital is a multichannel digital audio coding system widely used in cinemas, and in the home for DVD and digital broadcast soundtracks. It can deliver up to six discrete audio channels, comprising five full range channels and a special LFE (low frequency effects) channel used mainly for deep, rumbling sound effects; hence the term "5.1-channel" Dolby Digital.

In addition to the format features above, Dolby Digital decoders offer downmixing for compatibility with mono, stereo and Dolby Pro Logic audio from a number of bit rates and channels. Another feature, called Dialog Normalization, attenuates programs based on the average level of dialog in a program relative to its peak level (also known as Dialnorm) in order to achieve uniform playback level.

### Dolby Digital Surround EX

Dolby Digital Surround EX (the EX stands for EXtended) is an extension of Dolby Digital encoding whereby a surround back channel is matrixed into the surround left/right channels for 6.1 channel playback. This allows for compatibility with Dolby Digital 5.1 channel decoding, as well as for decoding using Dolby Digital EX.

### Dolby Pro Logic IIx and Dolby Surround

Dolby Pro Logic IIx is an improved version of the Dolby Pro Logic II (and Dolby Pro Logic) *decoding* system. Using the innovative "steering logic" circuit, this system extracts surround sound from sources as follows:

- **Dolby Pro Logic** – 4.1 channel sound (mono surround) from any stereo source
- **Dolby Pro Logic II** – 5.1 channel sound (stereo surround) from any stereo source
- **Dolby Pro Logic IIx** – 6.1 or 7.1 channel sound (stereo surround and surround back) from two channel or 5.1 (and 6.1) channel sources

*With two channel sources, the ".1" subwoofer channel is generated by bass management in the receiver.*

Dolby Surround is an *encoding* system which embeds surround sound information within a stereo soundtrack, which a Dolby Pro Logic decoder can then use for enhanced surround listening with greater sound detail.

*Manufactured under license from Dolby Laboratories. "Dolby", "Pro Logic", "Surround EX", and the double-D symbol are trademarks of Dolby Laboratories.*

### DTS

The DTS technologies are explained below. See [www.dtstech.com](http://www.dtstech.com) for more detailed information.



### DTS Digital Surround

DTS Digital Surround is a 5.1-channel audio coding system from DTS Inc. now widely used for DVD-Video, DVD-Audio, 5.1 music discs, digital broadcasts, and video games. It can deliver up to six discrete audio channels, comprising five full range channels, including an LFE channel. Higher sound quality is achieved through the use of a low compression rate, and high rates of transmittance during playback.

### DTS-ES

DTS-ES (the ES stands for Extended Surround) is a decoder that is capable of decoding both DTS-ES Discrete 6.1 and DTS-ES Matrix 6.1 encoded sources. DTS-ES Discrete 6.1 gives 'true' 6.1 channel sound, with a completely separate (discrete) surround back channel. DTS-ES Matrix 6.1 has a surround back channel matrixed into the surround left/right channels. Both sources are also compatible with a conventional DTS 5.1 channel decoder.

### DTS Neo:6

DTS Neo:6 can generate 6.1 channel surround sound from any matrixed stereo source (such as video or TV) and from 5.1 channel sources. It uses both the channel information already encoded into the source, as well as its own processing to determine channel localization (with two channel sources, the ".1" subwoofer channel is generated by bass management in the receiver). Two modes (Cinema and Music) are available using DTS Neo:6 with two channel sources.

### DTS 96/24

DTS 96/24 is an extension of the original DTS Digital Surround which offers high quality 96 kHz/24-bit audio using a DTS 96/24 decoder. This format is also fully backward compatible with all existing decoders. This means that DVD players can play this software using a conventional DTS 5.1 channel decoder.

*"DTS" and "DTS-ES | Neo:6" are registered trademarks of DTS, Inc. "96/24" is a trademark of DTS, Inc.*

## Windows Media™ Audio 9 Professional

Windows Media™ Audio 9 Professional (WMA9 Pro) is a discrete surround format developed by Microsoft Corporation.



WMA9 Pro can support up to 5.1/7.1 channel playback with sampling rates up to 24-bit/96 kHz. Using the unique WMA compression techniques, WMA9 Pro can deliver multichannel music and soundtracks over high-speed internet networks at low bit rates with minimal audio degradation. Playback may be enjoyed with the Windows Media™ Player 9 Series (or above) and other third-party media players on a personal computer, or with an AV amplifier with on-board WMA9 Pro decoding.

*Windows Media™ and the Windows logo are trademarks or registered trademarks of Microsoft Corporation in the United States and/or other countries.*

## About THX

The THX technologies are explained below. See [www.thx.com](http://www.thx.com) for more detailed information.



- **THX Cinema processing**

THX is an exclusive set of standards and technologies established by THX Ltd. THX grew from George Lucas' personal desire to make your experience of the film soundtrack, in both movie theatres and in your home theatre, as faithful as possible to what the director intended. Movie soundtracks are mixed in special movie theatres called dubbing stages and are designed to be played back in movie theatres with similar equipment and conditions. This same soundtrack is then transferred directly onto Laserdisc, VHS tape, DVD, etc., and is not changed for playback in a small home theatre environment. THX engineers developed patented technologies to accurately translate the sound from the movie theatre environment into the home, correcting the tonal and spatial errors that occur. On this product, when the THX indicator is on, THX features are automatically added in Cinema modes (e.g. THX Cinema, THX Surround EX).

- **Re-Equalization**

The tonal balance of a film soundtrack will be excessively bright and harsh when played back over audio equipment in the home because film soundtracks were designed to be played back in large movie theaters using very different professional equipment. Re-Equalization restores the correct tonal balance for watching a movie soundtrack in a small home environment.

- **Timbre Matching**

The human ear changes our perception of a sound depending on the direction from which the sound is coming. In a movie theatre, there is an array of surround speakers so that the surround information is all around you. In a home theatre, you use only two speakers located to the side of your head. The Timbre Matching feature filters the information going to the surround speakers so that they more closely match the tonal characteristics of the sound coming from the front speakers. This ensures seamless panning between the front and surround speakers.

- **Adaptive Decorrelation**

In a movie theatre, a large number of surround speakers help create an enveloping surround sound experience, but in a home theatre there are usually only two speakers. This can make the surround speakers sound like headphones that lack spaciousness and envelopment. The surround sounds will also collapse into the closest speaker as you move away from the middle seating position. Adaptive Decorrelation slightly changes one surround channel's time and phase relationship with respect to the other surround channel. This expands the listening position and creates—with only two speakers—the same spacious surround experience as in a movie theatre.

- **THX Select2**

Before any home theatre component can be THX Select2 certified, it must incorporate all the features above and also pass a rigorous series of quality and performance tests. Only then can a product feature the THX Select2 logo, which is your guarantee that the Home Theatre products you purchase will give you superb performance for many years to come. THX Select2 requirements cover every aspect of the product including pre-amplifier and power amplifier performance and operation, and hundreds of other parameters in both the digital and analog domain.

- **THX Surround EX**

THX Surround EX - Dolby Digital Surround EX is a joint development of Dolby Laboratories and the THX Ltd. In a movie theater, film soundtracks that have been encoded with Dolby Digital Surround EX technology are able to reproduce an extra channel which has been added during the mixing of the program. This channel, called Surround Back, places sounds behind the listener in addition to the currently available front left, front center, front right, surround right, surround left and subwoofer channels. This additional channel provides the opportunity for more detailed imaging behind the listener and brings more depth, spacious ambience and sound localization than ever before. Movies that were created using the Dolby Digital Surround EX technology, when released into the home consumer market may exhibit wording to that effect on the packaging. A list of movies created using this technology can be found on the Dolby web site at [www.dolby.com](http://www.dolby.com).

Only receiver and controller products bearing the THX Surround EX logo, when in the THX Surround EX mode, faithfully reproduce this new technology in the home.

This product may also engage the "THX Surround EX" mode during the playback of 5.1 channel material that is not Dolby Digital Surround EX encoded. In such case the information delivered to the Surround Back channel will be program dependent and may or may not be very pleasing depending on the particular soundtrack and the tastes of the individual listener.

**Advanced Speaker Array (ASA)**

ASA is a proprietary THX technology which processes the sound fed to 2 side and 2 back surround speakers to provide the optimal surround sound experience. When you set up your home theater system using all eight speaker outputs (Left, Center, Right, Surround Right, Surround Back Right, Surround Back Left, Surround Left and Subwoofer) placing the two Surround Back speakers close together facing the front of the room as shown in the diagram will provide the largest sweet spot. If for practical reasons you have to place the Surround Back speakers apart, you will need to go to the THX Audio Set-up screen and choose the setting that most closely corresponds to the speaker spacing, which will re-optimize the surround sound-field.

ASA is used in three new modes; THX Select2 Cinema, THX MusicMode and THX Games Mode.

**THX Select2 Cinema mode**

THX Select2 Cinema mode plays 5.1 movies using all eight speakers giving you the best possible movie watching experience. In this mode, ASA processing blends the side surround speakers and back surround speakers providing the optimal mix of ambient and directional surround sounds.

DTS-ES (Matrix and 6.1 Discrete) and Dolby Digital Surround EX encoded soundtracks will be automatically detected in Select2 Cinema mode if the appropriate flag has been encoded.

Some Dolby Digital Surround EX soundtracks are missing the digital flag that allows automatic switching. If you know that the movie that you are watching is encoded in Surround EX, you can manually select the THX Surround EX playback mode, otherwise THX Select2 Cinema mode will apply ASA processing to provide optimum replay.

**THX MusicMode**

For the replay of multi-channel music the THX MusicMode should be selected. In this mode THX ASA processing is applied to the surround channels of all 5.1 encoded music sources such as DTS, Dolby Digital and DVD-Audio to provide a wide stable rear soundstage.

**THX Games Mode**

For the replay of stereo and multi-channel game audio the THX Games Mode should be selected. In this mode THX ASA processing is applied to the surround channels of all 5.1 and 2.0 encoded game sources such as analog, PCM, DTS and Dolby Digital. This accurately places all game audio surround information, providing a full 360 degree playback environment. THX Games Mode is unique as it gives you a smooth transition of audio in all points of the surround field.

*The THX logo is a trademark of THX Ltd, which may be registered in some jurisdictions. All rights reserved.*

**Listening modes with different input signal formats**

The following charts outline the listening modes available with different input signal formats, depending on the surround back channel processing and decoding method you have selected.

**Stereo (2 channel) signal formats**

SBCh Processing	Input signal format	Standard	THX	Auto Surround
<b>SBCh Processing ON/AUTO</b> (Automatically selects 6.1/7.1 channel decoding)	Dolby Digital Surround	□□ Pro Logic IIx MOVIE □□ Pro Logic IIx MUSIC □□ Pro Logic IIx GAME □□ PRO LOGIC <sup>a</sup> Neo:6 CINEMA Neo:6 MUSIC	□□ Pro Logic IIx MOVIE+THX □□ PRO LOGIC+THX <sup>a</sup> Neo:6 CINEMA+THX THX GAMES MODE <sup>b</sup>	□□ Pro Logic IIx MOVIE
	DTS Surround	As above	As above	Neo:6 CINEMA
	Other stereo sources	As above	As above	Stereo playback
	PCM 88.2 kHz / 96 kHz	□□ Pro Logic II MOVIE □□ Pro Logic II MUSIC □□ Pro Logic II GAME □□ PRO LOGIC <sup>a</sup>	–	Stereo playback
<b>SBCh Processing OFF<sup>c</sup></b> (Maximum 5.1 channel playback)	Dolby Digital Surround	□□ Pro Logic II MOVIE □□ Pro Logic II MUSIC □□ Pro Logic II GAME □□ PRO LOGIC <sup>a</sup> Neo:6 CINEMA Neo:6 MUSIC	□□ Pro Logic II MOVIE+THX □□ PRO LOGIC+THX <sup>a</sup> Neo:6 CINEMA+THX	□□ Pro Logic II MOVIE
	DTS Surround	As above	As above	Neo:6 CINEMA
	Other stereo sources	As above	As above	Stereo playback
	PCM 88.2 kHz / 96 kHz	□□ Pro Logic II MOVIE □□ Pro Logic II MUSIC □□ Pro Logic II GAME □□ PRO LOGIC <sup>a</sup>	–	Stereo playback

a. □□ PRO LOGIC has a maximum of 5.1 channel playback.  
 b. Unavailable with only one surround back speaker connected.  
 c. Automatically selected if no surround back speakers are connected.

## Multichannel signal formats

SBch Processing	Input signal format	Standard	THX	Auto Surround
<b>SBch Processing ON</b> (7.1 channel decoding used for all sources)	WMA9 Pro (6.1/7.1 channel)	Straight decoding	<b>WMA+THX CINEMA</b>	Straight decoding
	Dolby Digital EX (6.1 channel flagged)	<b>Dolby Digital EX</b> □□ Pro Logic IIx MOVIE <sup>a</sup> □□ Pro Logic IIx MUSIC	<b>THX SURROUND EX</b> □□ Pro Logic IIx MOVIE+THX <sup>a</sup> THX Select2 CINEMA <sup>a</sup> THX MUSICMODE <sup>a</sup> THX GAMES MODE <sup>a</sup>	<b>Dolby Digital EX</b> □□ Pro Logic IIx MOVIE <sup>a</sup>
	DTS-ES (6.1 channel sources/6.1 channel flagged)	<b>DTS-ES</b> (Matrix/Discrete) <b>DTS+□□ Pro Logic IIx MOVIE<sup>a</sup></b> <b>DTS+□□ Pro Logic IIx MUSIC</b>	<b>DTS-ES+THX</b> (Matrix/Discrete) <b>DTS+□□ Pro Logic IIx MOVIE+THX<sup>a</sup></b> THX Select2 CINEMA <sup>a</sup> THX MUSICMODE <sup>a</sup> THX GAMES MODE <sup>a</sup>	<b>DTS-ES</b> (Matrix/Discrete)
	DTS (5.1 channel encoding)	<b>DTS+Neo:6</b> <b>DTS+□□ Pro Logic IIx MOVIE<sup>a</sup></b> <b>DTS+□□ Pro Logic IIx MUSIC</b>	<b>DTS+Neo:6+THX</b> <b>DTS+□□ Pro Logic IIx MOVIE+THX<sup>a</sup></b> THX Select2 CINEMA <sup>a</sup> THX MUSICMODE <sup>a</sup> THX GAMES MODE <sup>a</sup>	<b>DTS+Neo:6</b>
	Dolby Digital WMA9 Pro (5.1 channel encoding)	<b>Dolby Digital EX</b> □□ Pro Logic IIx MOVIE <sup>a</sup> □□ Pro Logic IIx MUSIC	<b>THX SURROUND EX</b> □□ Pro Logic IIx MOVIE+THX <sup>a</sup> THX Select2 CINEMA <sup>a</sup> THX MUSICMODE <sup>a</sup> THX GAMES MODE <sup>a</sup>	<b>Dolby Digital EX</b> □□ Pro Logic IIx MOVIE <sup>a</sup>
	DTS 96/24	Straight decoding (Maximum 5.1 channel playback)	–	Straight decoding (Maximum 5.1 channel playback)
<b>SBch Processing AUTO</b> (Automatically selects 6.1/7.1 channel decoding)	WMA9 Pro (6.1/7.1 channel)	Straight decoding	<b>WMA+THX CINEMA</b>	Straight decoding
	Dolby Digital EX (6.1 channel flagged)	<b>Dolby Digital EX</b> □□ Pro Logic IIx MOVIE <sup>a</sup>	<b>THX SURROUND EX</b>	<b>Dolby Digital EX</b> □□ Pro Logic IIx MOVIE <sup>a</sup>
	DTS-ES (6.1 channel sources/6.1 channel flagged)	<b>DTS-ES</b> (Matrix/Discrete)	<b>DTS-ES+THX</b> (Matrix/Discrete)	<b>DTS-ES</b> (Matrix/Discrete)
	Dolby Digital DTS WMA9 Pro (5.1 channel encoding)	Straight decoding (Maximum 5.1 channel playback)	<b>THX Select2 CINEMA</b> (Maximum 5.1 channel <b>THX CINEMA</b> playback with only one surround back speaker)	Straight decoding (Maximum 5.1 channel playback)
	DTS 96/24	Straight decoding (Maximum 5.1 channel playback)	–	Straight decoding (Maximum 5.1 channel playback)
<b>SBch Processing OFF<sup>b</sup></b> (Maximum 5.1 channel playback)	WMA9 Pro (6.1/7.1 channel)	Straight decoding (Maximum 5.1 channel playback)	<b>THX CINEMA</b>	Straight decoding (Maximum 5.1 channel playback)
	Dolby Digital EX (6.1 channel flagged) DTS-ES (6.1 channel sources/6.1 channel flagged)	Straight decoding	<b>THX CINEMA</b>	Straight decoding
	Dolby Digital DTS WMA9 Pro (5.1 channel encoding)			
	DTS 96/24	Straight decoding	–	Straight decoding

a.Unavailable with only one surround back speaker connected.

b.Automatically selected if no surround back speakers are connected.

## Specifications

### Amplifier section

#### Continuous Power Output (Stereo)

Front. . . . . 150 W + 150 W (DIN 1 kHz, THD 1 %, 6 Ω)  
 120 W + 120 W (DIN 1 kHz, THD 1 %, 8 Ω)

#### Continuous Power Output (Multichannel)

Front. . . . . 150 W + 150 W (DIN 1 kHz, THD 1 %, 6 Ω)  
 120 W + 120 W (DIN 1 kHz, THD 1 %, 8 Ω)

Center . . . . . 150 W (DIN 1 kHz, THD 1 %, 6 Ω)  
 120 W (DIN 1 kHz, THD 1 %, 8 Ω)

Surround . . . . . 150 W + 150 W (DIN 1 kHz, THD 1 %, 6 Ω)  
 120 W + 120 W (DIN 1 kHz, THD 1 %, 8 Ω)

#### Surround back

. . . . . 150 W + 150 W (DIN 1 kHz, THD 1 %, 6 Ω)  
 120 W + 120 W (DIN 1 kHz, THD 1 %, 8 Ω)

Rated Power Output . . . . . 130 W + 130 W  
 (20 Hz to 20 kHz, 0.09 %, 6 Ω)

Rated Power Output . . . . . 110 W + 110 W  
 (20 Hz to 20 kHz, 0.09 %, 8 Ω)

- The above specifications are applicable when the power supply is 230 V.

### Audio Section

#### Input (Sensitivity/Impedance)

LINE . . . . . 335 mV/47 kΩ

Frequency Response (LINE). . . . . 5 Hz to 100 000 Hz ±0.5 dB

#### Output (Level/Impedance)

REC . . . . . 335 mV/2.2 kΩ

#### Tone Control

BASS . . . . . ± 6 dB (100 Hz)

TREBLE . . . . . ± 6 dB (10 kHz)

LOUDNESS. . . . . +4 dB / +2 dB (100 Hz/10 kHz)  
 (at volume position -40 dB)

#### Signal-to-Noise Ratio (IHF, short circuited, A network)

LINE. . . . . 103 dB

#### Signal-to-Noise Ratio

[DIN (continuous rated power output/50 mW)]

LINE. . . . . 92 dB / 65 dB

### Composite Video / S-Video Section

Input (Sensitivity/Impedance) . . . . . 1 Vp-p/75 Ω

Output (Level/Impedance) . . . . . 1 Vp-p/75 Ω

Signal-to-Noise Ratio . . . . . 65 dB

Frequency Response . . . . . 5 Hz to 10 MHz

### Component Video Section

Input (Sensitivity/Impedance) . . . . . 1 Vp-p/75 Ω

Output (Level/Impedance) . . . . . 1 Vp-p/75 Ω

Signal-to-Noise Ratio . . . . . 65 dB

Frequency Response . . . . . 5 Hz to 100 MHz

### FM Tuner Section

Frequency Range . . . . . 87.5 MHz to 108 MHz

Usable Sensitivity . . . . . Mono: 15.2 dBf, IHF (1.6 μV/75 Ω)

50 dB Quieting Sensitivity . . . . . Mono: 20.2 dBf

Stereo: 41.2 dBf

Sensitivity (DIN) . . . . . Mono: 1.1 μV (S/N 26 dB)

Stereo: 50 μV (S/N 46 dB)

Signal-to-Noise Ratio . . . . . Mono: 76 dB (at 85 dBf)

Stereo: 72 dB (at 85 dBf)

Signal-to-Noise Ratio (DIN). . . . . Mono: 62 dB

Stereo: 58 dB

Distortion . . . . . Stereo: 0.6 % (1 kHz)

Alternate Channel Selectivity . . . . . 70 dB (400 kHz)

Stereo Separation . . . . . 40 dB (1 kHz)

Frequency Response . . . . . 30 Hz to 15 kHz ± 1 dB

Antenna Input . . . . . 75 Ω unbalanced

### AM Tuner Section

Frequency Range . . . . . 531 kHz to 1602 kHz (9 kHz step)

Sensitivity (IHF, Loop antenna) . . . . . 350 μV/m

Selectivity . . . . . 30 dB

Signal-to-Noise Ratio . . . . . 50 dB

Antenna . . . . . Loop antenna

### Miscellaneous

Power Requirements. . . . . AC 220 V to 230 V, 50 Hz / 60 Hz

Power Consumption . . . . . 450 W

In standby . . . . . 0.5 W

Dimensions . . . . . 420 (W) mm x 173 (H) mm x 465 (D) mm

Weight (without package). . . . . 15.0 kg

### Furnished Parts

Setup microphone (for Auto MCACC setup). . . . . 1

AA/IEC R6P dry cell batteries . . . . . 2

Remote control unit. . . . . 1

AM loop antenna . . . . . 1

FM wire antenna . . . . . 1

Warranty card . . . . . 1

These operating instructions



#### Note

- Specifications and the design are subject to possible modifications without notice, due to improvements.

## Cleaning the unit

- Use a polishing cloth or dry cloth to wipe off dust and dirt.
- When the surface is dirty, wipe with a soft cloth dipped in some neutral cleanser diluted five or six times with water, and wrung out well, and then wipe again with a dry cloth. Do not use furniture wax or cleansers.
- Never use thinners, benzine, insecticide sprays or other chemicals on or near this unit, since these will corrode the surface.

<http://www.pioneer.co.uk>

<http://www.pioneer.eu>

Published by Pioneer Corporation.  
Copyright © 2007 Pioneer Corporation.  
All rights reserved.

---

**PIONEER CORPORATION**

4-1, Meguro 1-Chome, Meguro-ku, Tokyo 153-8654, Japan

**PIONEER ELECTRONICS (USA) INC.**

P.O. BOX 1540, Long Beach, California 90801-1540, U.S.A. TEL: (800) 421-1404

**PIONEER ELECTRONICS OF CANADA, INC.**

300 Allstate Parkway, Markham, Ontario L3R 0P2, Canada TEL: 1-877-283-5901, 905-479-4411

**PIONEER EUROPE NV**

Haven 1087, Keetberglaan 1, B-9120 Melsele, Belgium TEL: 03/570.05.11

**PIONEER ELECTRONICS ASIACENTRE PTE. LTD.**

253 Alexandra Road, #04-01, Singapore 159936 TEL: 65-6472-7555

**PIONEER ELECTRONICS AUSTRALIA PTY. LTD.**

178-184 Boundary Road, Braeside, Victoria 3195, Australia, TEL: (03) 9586-6300

**PIONEER ELECTRONICS DE MEXICO S.A. DE C.V.**

Blvd.Manuel Avila Camacho 138 10 piso Col.Lomas de Chapultepec, Mexico,D.F. 11000 TEL: 55-9178-4270

K002\_B\_En



## Free Manuals Download Website

<http://myh66.com>

<http://usermanuals.us>

<http://www.somanuals.com>

<http://www.4manuals.cc>

<http://www.manual-lib.com>

<http://www.404manual.com>

<http://www.luxmanual.com>

<http://aubethermostatmanual.com>

Golf course search by state

<http://golfingnear.com>

Email search by domain

<http://emailbydomain.com>

Auto manuals search

<http://auto.somanuals.com>

TV manuals search

<http://tv.somanuals.com>