

Pioneer *sound.vision.soul*

**AUDIO/VIDEO MULTI-CHANNEL
RECEIVER**

VSX-43TX

ELITE

Operating Instructions

Thank you for buying this Pioneer product. Please read through these operating instructions so you will know how to operate your model properly. After you have finished reading the instructions, put them away in a safe place for future reference.

IMPORTANT NOTICE

H006AEn

The serial number for this equipment is located in the rear panel. Please write this serial number on your enclosed warranty card and keep it in a secure area. This is for your security.

Information to User

Alteration or modifications carried out without appropriate authorization may invalidate the user's right to operate the equipment.

H011Een

POWER-CORD CAUTION

S002 En

Handle the power cord by the plug. Do not pull out the plug by tugging the cord and never touch the power cord when your hands are wet as this could cause a short circuit or electric shock. Do not place the unit, a piece of furniture, etc., on the power cord, or pinch the cord. Never make a knot in the cord or tie it with other cords. The power cords should be routed such that they are not likely to be stepped on. A damaged power cord can cause a fire or give you an electrical shock. Check the power cord once in a while. When you find it damaged, ask your nearest PIONEER authorized service center or your dealer for a replacement.

WARNING: THE APPARATUS IS NOT WATERPROOFS, TO PREVENT FIRE OR SHOCK HAZARD, DO NOT EXPOSE THIS APPLIANCE TO RAIN OR MOISTURE AND DO NOT PUT ANY WATER SOURCE NEAR THIS APPARATUS, SUCH AS VASE, FLOWER POT, COSMETICS CONTAINER AND MEDICINE BOTTLE ETC.

H001AEn

[For U.S. model]



ENERGY STAR® and the ENERGY STAR certification mark are registered US marks.

K001A_En

This product is for general household purposes. Any failure due to use for other than household purposes (such as long-term use for business purposes in a restaurant or use in a car or ship) and which requires repair will be charged for even during the warranty period.

K041_En

If the socket outlets on the associated equipment are not suitable for the plug supplied with the product, the plug must be removed and an appropriate one fitted. Replacement and mounting of an AC plug on the power supply cord of this unit should be performed only by qualified service personnel. The cut-off plug must be disposed of as an electrical shock hazard could exist if connected to a socket outlet.

H022AEn

NOTE: This equipment has been tested and found to comply with the limits for a Class B digital device, pursuant to Part 15 of the FCC Rules. These limits are designed to provide reasonable protection against harmful interference in a residential installation. This equipment generates, uses, and can radiate radio frequency energy and, if not installed and used in accordance with the instructions, may cause harmful interference to radio communications. However, there is no guarantee that interference will not occur in a particular installation. If this equipment does cause harmful interference to radio or television reception, which can be determined by turning the equipment off and on, the user is encouraged to try to correct the interference by one or more of the following measures:

- Reorient or relocate the receiving antenna.
- Increase the separation between the equipment and receiver.
- Connect the equipment into an outlet on a circuit different from that to which the receiver is connected.
- Consult the dealer or an experienced radio/TV technician for help.

H010 En

[For Canadian model]

CAUTION: TO PREVENT ELECTRIC SHOCK, DO NOT USE THIS (POLARIZED) PLUG WITH AN EXTENSION CORD, RECEPTACLE OR OTHER OUTLET UNLESS THE BLADES CAN BE FULLY INSERTED TO PREVENT BLADE EXPOSURE.

ATTENTION: POUR PREVENIR LES CHOCS ELECTRIQUES NE PAS UTILISER CETTE FICHE POLARISEE AVEC UN PROLONGATEUR UNE PRISE DE COURANT OU UNE AUTRE SORTIE DE COURANT, SAUF SI LES LAMES PEUVENT ETRE INSEREES A FOND SANS EN LAISSER AUCUNE PARTIE A DECOUVERT.

H007AZL

[For Canadian model]

This Class B digital apparatus complies with Canadian ICES-003.

[Pour le modèle Canadien]

Cet appareil numérique de la classe B est conforme à la norme NMB-003 du Canada.

H009 2L

CAUTION:

This product satisfies FCC regulations when shielded cables and connectors are used to connect the unit to other equipment. To prevent electromagnetic interference with electric appliances such as radios and televisions, use shielded cables and connectors for connections.

H012 En

IMPORTANT



The lightning flash with arrowhead symbol, within an equilateral triangle, is intended to alert the user to the presence of uninsulated "dangerous voltage" within the product's enclosure that may be of sufficient magnitude to constitute a risk of electric shock to persons.

CAUTION

**RISK OF ELECTRIC SHOCK
DO NOT OPEN**

CAUTION:
TO PREVENT THE RISK OF ELECTRIC SHOCK, DO NOT REMOVE COVER (OR BACK). NO USER-SERVICEABLE PARTS INSIDE. REFER SERVICING TO QUALIFIED SERVICE PERSONNEL.



The exclamation point within an equilateral triangle is intended to alert the user to the presence of important operating and maintenance (servicing) instructions in the literature accompanying the appliance.

IMPORTANT SAFETY INSTRUCTIONS

H003 En

READ INSTRUCTIONS — All the safety and operating instructions should be read before the product is operated.

RETAIN INSTRUCTIONS — The safety and operating instructions should be retained for future reference.

HEED WARNINGS — All warnings on the product and in the operating instructions should be adhered to.

FOLLOW INSTRUCTIONS — All operating and use instructions should be followed.

CLEANING — Unplug this product from the wall outlet before cleaning. The product should be cleaned only with a polishing cloth or a soft dry cloth. Never clean with furniture wax, benzene, insecticides or other volatile liquids since they may corrode the cabinet.

ATTACHMENTS — Do not use attachments not recommended by the product manufacturer as they may cause hazards.

WATER AND MOISTURE — Do not use this product near water — for example, near a bathtub, wash bowl, kitchen sink, or laundry tub; in a wet basement; or near a swimming pool; and the like.

ACCESSORIES — Do not place this product on an unstable cart, stand, tripod, bracket, or table. The product may fall, causing serious injury to a child or adult, and serious damage to the product. Use only with a cart, stand, tripod, bracket, or table recommended by the manufacturer, or sold with the product. Any mounting of the product should follow the manufacturer's instructions, and should use a mounting accessory recommended by the manufacturer.

CART — A product and cart combination should be moved with care. Quick stops, excessive force, and uneven surfaces may cause the product and cart combination to overturn.



VENTILATION — Slots and openings in the cabinet are provided for ventilation and to ensure reliable operation of the product and to protect it from overheating, and these openings must not be blocked or covered. The openings should never be blocked by placing the product on a bed, sofa, rug, or other similar surface. This product should not be placed in a built-in installation such as a bookcase or rack unless proper ventilation is provided or the manufacturer's instructions have been adhered to.

POWER SOURCES — This product should be operated only from the type of power source indicated on the marking label. If you are not sure of the type of power supply to your home, consult your product dealer or local power company.

LOCATION — The appliance should be installed in a stable location.

NONUSE PERIODS — The power cord of the appliance should be unplugged from the outlet when left unused for a long period of time.

GROUNDING OR POLARIZATION

• If this product is equipped with a polarized alternating current line plug (a plug having one blade wider than the other), it will fit into the outlet only one way. This is a safety feature. If you are unable to insert the plug fully into the outlet, try reversing the plug. If the plug should still fail to fit, contact your electrician to replace your obsolete outlet. Do not defeat the safety purpose of the polarized plug.

• If this product is equipped with a three-wire grounding type plug, a plug having a third (grounding) pin, it will only fit into a grounding type power outlet. This is a safety feature. If you are unable to insert the plug into the outlet, contact your electrician to replace your obsolete outlet. Do not defeat the safety purpose of the grounding type plug.

POWER-CORD PROTECTION — Power-supply cords should be routed so that they are not likely to be walked on or pinched by items placed upon or against them, paying particular attention to cords at plugs, convenience receptacles, and the point where they exit from the product.

OUTDOOR ANTENNA GROUNDING — If an outside antenna or cable system is connected to the product, be sure the antenna or cable system is grounded so as to provide some protection against voltage surges and built-up static charges. Article 810 of the National Electrical Code, ANSI/NFPA 70, provides information with regard to proper grounding of the mast and supporting structure, grounding of the lead-in wire to an antenna discharge unit, size of grounding conductors, location of antenna-discharge unit, connection to grounding electrodes, and requirements for the grounding electrode. See Figure A.

LIGHTNING — For added protection for this product during a lightning storm, or when it is left unattended and unused for long periods of time, unplug it from the wall outlet and disconnect the antenna or cable system. This will prevent damage to the product due to lightning and power-line surges.

POWER LINES — An outside antenna system should not be located in the vicinity of overhead power lines or other electric light or power circuits, or where it can fall into such power lines or circuits. When installing an outside antenna system, extreme care should be taken to keep from touching such power lines or circuits as contact with them might be fatal.

OVERLOADING — Do not overload wall outlets, extension cords, or integral convenience receptacles as this can result in a risk of fire or electric shock.

OBJECT AND LIQUID ENTRY — Never push objects of any kind into this product through openings as they may touch dangerous voltage points or short-out parts that could result in a fire or electric shock. Never spill liquid of any kind on the product.

SERVICING — Do not attempt to service this product yourself as opening or removing covers may expose you to dangerous voltage or other hazards. Refer all servicing to qualified service personnel.

DAMAGE REQUIRING SERVICE — Unplug this product from the wall outlet and refer servicing to qualified service personnel under the following conditions:

- When the power-supply cord or plug is damaged.
- If liquid has been spilled, or objects have fallen into the product.
- If the product has been exposed to rain or water.
- If the product does not operate normally by following the operating instructions. Adjust only those controls that are covered by the operating instructions as an improper adjustment of other controls may result in damage and will often require extensive work by a qualified technician to restore the product to its normal operation.
- If the product has been dropped or damaged in any way.
- When the product exhibits a distinct change in performance — this indicates a need for service.

REPLACEMENT PARTS — When replacement parts are required, be sure the service technician has used replacement parts specified by the manufacturer or have the same characteristics as the original part. Unauthorized substitutions may result in fire, electric shock, or other hazards.

SAFETY CHECK — Upon completion of any service or repairs to this product, ask the service technician to perform safety checks to determine that the product is in proper operating condition.

WALL OR CEILING MOUNTING — The product should not be mounted to a wall or ceiling.

HEAT — The product should be situated away from heat sources such as radiators, heat registers, stoves, or other products (including amplifiers) that produce heat.

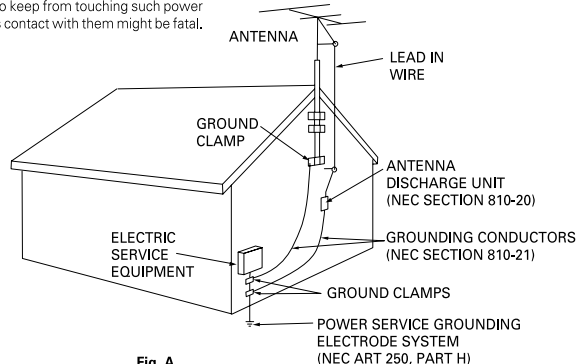

Fig. A

NEC — NATIONAL ELECTRICAL CODE

Table of Contents

| | |
|------------------------------------------------------------------------------------------------------------|-----------|
| Features | 6 |
| Before You Start | 7 |
| Checking the Supplied Accessories | 7 |
| Preparing the Remote Control | 7 |
| Loading the batteries | 7 |
| Operating range of remote control unit | 8 |
| Installing the Receiver | 8 |
| Opening the Front Panel | 8 |
| Easy Setup Guide Part 1 | 9 |
| Home Theater: The Basics | 9 |
| 1) Your Home System | 9 |
| 2) The Source Material | 9 |
| 3) The Listening Modes | 9 |
| Conclusion | 9 |
| 1) Hooking Up Your DVD Player & TV | 10 |
| Digital Connections | 10 |
| 2) Speaker Connections | 11 |
| 3) Setting up the Main Unit | 12 |
| 4) Assigning the Digital Inputs | 12 |
| Easy Setup Guide Part 2 | 13 |
| 1) QUICK Setup | 13 |
| 2) Playing a DVD with Surround Sound | 14 |
| Connecting Your Equipment | 15 |
| Connecting your TV | 15 |
| Component Video Input Default Settings | 15 |
| Connecting Video Components | 16 |
| Connecting a DVD player | 16 |
| Connecting VCRs or DVRs | 17 |
| Connecting a Video Component to the Front Panel | 17 |
| Connecting Satellite TV (SAT) Components | 18 |
| Connecting Analog Audio Components | 19 |
| Connecting to the Multi Channel Analog Inputs (DVD-Audio or Super Audio CD (SACD) compatible player) | 20 |
| Connecting Digital Audio Components | 21 |
| Digital Input Default Settings | 22 |
| Connecting the Radio Antennas | 23 |
| Using outdoor antennas | 23 |
| Connecting Speakers | 24 |
| Speaker impedance | 25 |
| Bi-wiring your speakers | 25 |
| Placing Your Speakers | 26 |
| Speaker placement | 26 |
| AC Power Cord | 26 |
| AC Outlet [switched 100W max] | 26 |
| Displays & Controls | 27 |
| Display | 27 |
| Front Panel | 28 |
| Remote Control | 30 |
| Back Panel | 32 |
| Setting Up for Surround Sound | 34 |
| SURRBACK SYSTEM (Surround Back System) | 35 |
| NORMAL setup | 36 |
| SPEAKER SETTING | 37 |
| CHANNEL LEVEL (channel balance) | 39 |
| CHANNEL DELAY | 40 |
| Basic Operation | 41 |
| Stereo and Multichannel Playback | 41 |
| Switching ANALOG/DIGITAL Signal Input | 42 |
| Listening Modes | 43 |
| STEREO modes | 43 |
| MOVIE modes (SURROUND mode) | 44 |
| MUSIC modes (SURROUND mode) | 45 |
| Adjusting the Effect of a Listening Mode | 46 |
| Adding/Adjusting the Effect in | 46 |
| Dolby Pro Logic II Music Mode | 46 |
| Listening with Acoustic Calibration EQ | 47 |
| Reducing Noise During Playback (DIGITAL NR Function) | 47 |
| Listening in MIDNIGHT Mode | 48 |
| Listening in LOUDNESS Mode | 48 |
| Adjusting Bass and Treble (TONE CONTROL) | 49 |
| Listening in HI-BIT/SAMPLING Mode | 50 |
| DVD-Audio/MULTI CHANNEL IN Playback | 50 |
| SB CH MODE button | 51 |
| SB CH MODE | 51 |
| VIRTUAL SURROUND BACK Mode | 51 |
| DUAL MONO setting and Playback | 52 |
| Using Headphones | 52 |
| Video Select | 53 |
| Adjusting the Brightness of the Display (DIMMER) | 53 |
| Using the Tuner | 54 |
| Automatic and Manual Tuning | 54 |
| MPX Mode | 54 |
| Direct Access Tuning | 55 |
| Memorizing Frequently Used Stations | 56 |
| Naming Memorized Stations | 57 |
| Recalling Memorized Stations | 58 |

Table of Contents

| | |
|----------------------------------------------------------------------|-----------|
| Remote Control of Other Components | 59 |
| Setting Up the Remote Control to Control Other Components | 59 |
| Recalling Settings Stored in the Remote Control | 59 |
| Programming Signals from Other Remote Controls (LEARNING Mode) | 60 |
| Using Remote Control with Other Components | 61 |
| CD/MD/CD-R/VCR/DVD/LD/DVD Recorder/ Cassette Deck operations | 61 |
| Cable TV/ Satellite TV/ Digital TV/ TV operations | 62 |
| Setting up the DIRECT FUNCTION | 63 |
| Using Other Functions | 64 |
| Recording from Audio/Video Components | 64 |
| SECOND ZONE (Speaker System B)/FRONT BI-AMP Setup | 65 |
| Stereo playback in another room (SECOND ZONE) | 65 |
| Bi-amping the front speakers (FRONT BI-AMP) | 65 |
| A/B Speaker Button | 66 |
| Connecting Additional Amplifiers | 67 |
| Multi Operations | 68 |
| Performing Multi Operations | 69 |
| SYSTEM OFF | 70 |
| Using SYSTEM OFF | 71 |
| The PIONEER SR System: Operating other PIONEER components | 71 |
| Resetting the Remote Control | 72 |
| Erasing Multi Operations | 72 |
| Erasing Learned Remote Control Commands | 72 |
| Erasing All Remote Control settings | 72 |
| Resetting the Main Unit | 73 |
| Fine Tuning Your System | 74 |
| Other System Settings | 74 |
| THX CINEMA Setup | 75 |
| Assigning the Digital Inputs | 76 |
| Assigning the Component Video Inputs | 77 |
| FUNCTION RENAME | 78 |
| Expert Setup | 79 |
| CROSSOVER NETWORK | 80 |
| FINE CHANNEL LEVEL | 81 |
| FINE CHANNEL DELAY | 82 |
| ACOUSTIC CAL EQ | 84 |
| BASS PEAK LEVEL | 86 |
| DYNAMIC RANGE CONTROL | 87 |
| Techno Tidbits & Problem-solving | 88 |
| Dolby | 88 |
| Dolby Digital | 88 |
| Dolby Pro Logic II | 88 |
| Dolby Digital Surround EX | 89 |
| DTS | 89 |
| DTS | 89 |
| DTS-ES | 89 |
| DTS Neo:6 | 89 |
| DTS 96/24 | 89 |
| THX | 90 |
| Speaker Placement Information | 91 |
| Preset Code List | 93 |
| Troubleshooting | 95 |
| Schemata of Setup | 100 |
| Specifications | 102 |

Table of Contents

| | |
|------------------------------------------------------------------------------------------------------------|-----------|
| Features | 6 |
| Before You Start | 7 |
| Checking the Supplied Accessories | 7 |
| Preparing the Remote Control | 7 |
| Loading the batteries | 7 |
| Operating range of remote control unit | 8 |
| Installing the Receiver | 8 |
| Opening the Front Panel | 8 |
| Easy Setup Guide Part 1 | 9 |
| Home Theater: The Basics | 9 |
| 1) Your Home System | 9 |
| 2) The Source Material | 9 |
| 3) The Listening Modes | 9 |
| Conclusion | 9 |
| 1] Hooking Up Your DVD Player & TV | 10 |
| Digital Connections | 10 |
| 2] Speaker Connections | 11 |
| 3] Setting up the Main Unit | 12 |
| 4] Assigning the Digital Inputs | 12 |
| Easy Setup Guide Part 2 | 13 |
| 1] QUICK Setup | 13 |
| 2] Playing a DVD with Surround Sound | 14 |
| Connecting Your Equipment | 15 |
| Connecting your TV | 15 |
| Component Video Input Default Settings | 15 |
| Connecting Video Components | 16 |
| Connecting a DVD player | 16 |
| Connecting VCRs or DVRs | 17 |
| Connecting a Video Component to the Front Panel | 17 |
| Connecting Satellite TV (SAT) Components | 18 |
| Connecting Analog Audio Components | 19 |
| Connecting to the Multi Channel Analog Inputs (DVD-Audio or Super Audio CD (SACD) compatible player) | 20 |
| Connecting Digital Audio Components | 21 |
| Digital Input Default Settings | 22 |
| Connecting the Radio Antennas | 23 |
| Using outdoor antennas | 23 |
| Connecting Speakers | 24 |
| Speaker impedance | 25 |
| Bi-wiring your speakers | 25 |
| Placing Your Speakers | 26 |
| Speaker placement | 26 |
| AC Power Cord | 26 |
| AC Outlet [switched 100W max] | 26 |
| Displays & Controls | 27 |
| Display | 27 |
| Front Panel | 28 |
| Remote Control | 30 |
| Back Panel | 32 |
| Setting Up for Surround Sound | 34 |
| SURRBACK SYSTEM (Surround Back System) | 35 |
| NORMAL setup | 36 |
| SPEAKER SETTING | 37 |
| CHANNEL LEVEL (channel balance) | 39 |
| CHANNEL DELAY | 40 |
| Basic Operation | 41 |
| Stereo and Multichannel Playback | 41 |
| Switching ANALOG/DIGITAL Signal Input | 42 |
| Listening Modes | 43 |
| STEREO modes | 43 |
| MOVIE modes (SURROUND mode) | 44 |
| MUSIC modes (SURROUND mode) | 45 |
| Adjusting the Effect of a Listening Mode | 46 |
| Adding/Adjusting the Effect in Dolby Pro Logic II Music Mode | 46 |
| Listening with Acoustic Calibration EQ | 47 |
| Reducing Noise During Playback (DIGITAL NR Function) | 47 |
| Listening in MIDNIGHT Mode | 48 |
| Listening in LOUDNESS Mode | 48 |
| Adjusting Bass and Treble (TONE CONTROL) | 49 |
| Listening in HI-BIT/SAMPLING Mode | 50 |
| DVD-Audio/MULTI CHANNEL IN Playback | 50 |
| SB CH MODE button | 51 |
| SB CH MODE | 51 |
| VIRTUAL SURROUND BACK Mode | 51 |
| DUAL MONO setting and Playback | 52 |
| Using Headphones | 52 |
| Video Select | 53 |
| Adjusting the Brightness of the Display (DIMMER) | 53 |
| Using the Tuner | 54 |
| Automatic and Manual Tuning | 54 |
| MPX Mode | 54 |
| Direct Access Tuning | 55 |
| Memorizing Frequently Used Stations | 56 |
| Naming Memorized Stations | 57 |
| Recalling Memorized Stations | 58 |

Table of Contents

| | |
|----------------------------------------------------------------------|-----------|
| Remote Control of Other Components | 59 |
| Setting Up the Remote Control to Control Other Components | 59 |
| Recalling Settings Stored in the Remote Control | 59 |
| Programming Signals from Other Remote Controls (LEARNING Mode) | 60 |
| Using Remote Control with Other Components | 61 |
| CD/MD/CD-R/VCR/DVD/LD/DVD Recorder/Cassette Deck operations | 61 |
| Cable TV/ Satellite TV/ Digital TV/ TV operations | 62 |
| Setting up the DIRECT FUNCTION | 63 |
| Using Other Functions | 64 |
| Recording from Audio/Video Components | 64 |
| SECOND ZONE (Speaker System B)/FRONT BI-AMP Setup | 65 |
| Stereo playback in another room (SECOND ZONE) | 65 |
| Bi-amping the front speakers (FRONT BI-AMP) | 65 |
| A/B Speaker Button | 66 |
| Connecting Additional Amplifiers | 67 |
| Multi Operations | 68 |
| Performing Multi Operations | 69 |
| SYSTEM OFF | 70 |
| Using SYSTEM OFF | 71 |
| The PIONEER SR System: Operating other PIONEER components | 71 |
| Resetting the Remote Control | 72 |
| Erasing Multi Operations | 72 |
| Erasing Learned Remote Control Commands | 72 |
| Erasing All Remote Control settings | 72 |
| Resetting the Main Unit | 73 |
| Fine Tuning Your System | 74 |
| Other System Settings | 74 |
| THX CINEMA Setup | 75 |
| Assigning the Digital Inputs | 76 |
| Assigning the Component Video Inputs | 77 |
| FUNCTION RENAME | 78 |
| Expert Setup | 79 |
| CROSSOVER NETWORK | 80 |
| FINE CHANNEL LEVEL | 81 |
| FINE CHANNEL DELAY | 82 |
| ACOUSTIC CAL EQ | 84 |
| BASS PEAK LEVEL | 86 |
| DYNAMIC RANGE CONTROL | 87 |
| Techno Tidbits & Problem-solving | 88 |
| Dolby | 88 |
| Dolby Digital | 88 |
| Dolby Pro Logic II | 88 |
| Dolby Digital Surround EX | 89 |
| DTS | 89 |
| DTS | 89 |
| DTS-ES | 89 |
| DTS Neo:6 | 89 |
| DTS 96/24 | 89 |
| THX | 90 |
| Speaker Placement Information | 91 |
| Preset Code List | 93 |
| Troubleshooting | 95 |
| Schemata of Setup | 100 |
| Specifications | 102 |

Features

High Quality, Balanced Multichannel Design

The VSX-43TX receiver is constructed with Pioneer's industry-leading advanced and well balanced multichannel concept. This means it is designed to reproduce music and movie soundtracks as close as possible to the intentions of the producer during mastering. The receiver uses a revolutionary 3-D Frame Construction technique and a Symmetrical Power Train Design, with high-performance Advanced Direct Energy MOS-FET output devices, generating 100 watts of power for 7 independent channels.

Multichannel Acoustic Calibration EQ System (MCACC)

In order to make setting up as easy as possible for users we have created the MCACC system. This unique and convenient way of getting good surround sound from the receiver makes trouble-free set up a snap. The MCACC system creates a monitoring environment to establish the parameters of the sound in regards to each speaker for the specific room you are using. The Acoustic Calibration EQ feature makes sure each speaker is used to maximum effect in conjunction with the overall sound. The resulting settings finely attune the overall surround sound for the space used.

Dolby Digital EX, DTS-ES, DTS 96/24 and the Latest Audio and Video Formats

The VSX-43TX is equipped with Dolby Digital EX decoding, the very latest Dolby Digital contribution to home theater with surround back speakers in addition to surround speakers. These additional speakers make home theater even more realistic and powerful. Naturally, you can also play all existing audio formats, including the recently developed Dolby Pro Logic II and DTS-ES Extended Surround formats on the VSX-43TX as well. On the video side, the component video output is fully compatible with high definition, progressive-scan digital video (720p).

Lucasfilm and THX are trademarks or registered trademarks of Lucasfilm, Ltd. & TM. Surround EX is a jointly developed technology of THX and Dolby Laboratories, and is a trademark of Dolby Laboratories. All rights reserved. Used under authorization.

Manufactured under license from Dolby Laboratories. "Dolby", "Pro Logic", "Surround EX" and double-D symbol are trademarks of Dolby Laboratories.

"DTS", "DTS-ES Extended Surround" and "Neo:6" are trademarks of Digital Theater Systems, Inc.

Universal Player Compatibility (DVD Audio/Super Audio CD [SACD])

This receiver incorporates the latest technology and is able to handle cutting edge audio formats, like DVD Audio and Super Audio CD (SACD) which are just hitting the market. Its high compatibility offers a variety of inputs to decode all types of sources at the highest possible quality. The receiver's multichannel input connections lets you hook up eight discrete channels of audio.

Audio Scaler (HI BIT/HI SAMPLING)

This new technology enables the user to hear CD and DVD, as well as other soundtracks at a wider dynamic range, allowing for finer audio reproduction. This Audio Scaler approximates the audio of high end formats just becoming available now.

Easy-to-use Remote Control and Urushi Lacquer Aluminum Panel

This new remote control is extremely convenient to use. One button is dedicated to one task in the control of the receiver, eliminating confusing buttons whose purpose are unclear. In addition, this remote can be used to operate a variety of other components simply by recalling the appropriate setup codes. The smooth finish and left-right symmetry of the stylish urushi lacquer aluminum panel is emblematic of the high quality of the equipment.

The Energy-saving Design

This unit is designed to use 0.6 W of energy when the receiver is in standby mode.

Before You Start

Checking the Supplied Accessories

Please check that you have received all of the following supplied accessories.

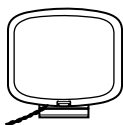

AM Loop Antenna



FM Wire Antenna

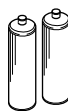

"AA" IEC LR6
batteries x 2

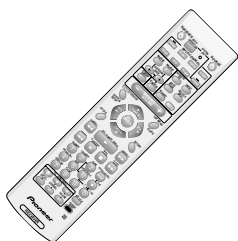

Remote Control Unit



Operating
Instructions

Preparing the Remote Control

Loading the batteries

Load the batteries into the remote control as shown below. Please use alkaline batteries. When you notice a decrease in the operating range, replace all batteries with new ones.

1

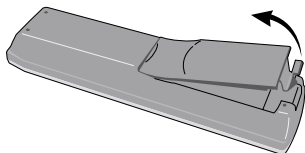

2

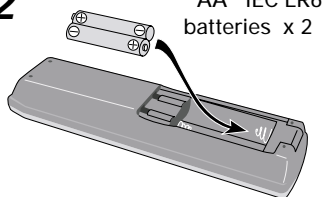

3

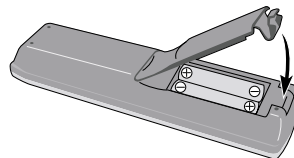

CAUTION!

Incorrect use of batteries may result in such hazards as leakage and bursting. Observe the following precautions.

- Never use new and old batteries together.
- Insert the plus and minus sides of the batteries properly according to the marks in the battery case.
- Batteries with the same shape may have different voltages. Do not use different batteries together.
- When disposing of used batteries, please comply with governmental regulations or environmental public institution's rules that apply in your country or area.

Before You Start

Operating range of remote control unit

The area in which you can use the remote control to operate the VSX-43TX is fairly large. To use, point the remote control toward the remote sensor on the front panel of this unit while within the range shown below.

Remote control may not function properly if:

- There are obstacles between the remote control and the remote sensor.
- Direct sunlight or fluorescent light is shining onto the remote sensor.
- The receiver located near a device emitting infrared rays.
- Operated simultaneously with another remote control which uses infrared rays.

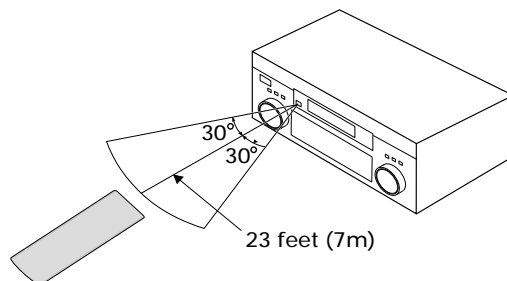

Installing the Receiver

CAUTION!

- Do not cover this unit in any way, for example with a sheet or piece of cloth. This would prevent proper heat dispersal.
- Do not place any object directly on top of this unit. This also would prevent proper heat dispersal.
- Be sure to leave adequate ventilation space around the amp! When installing in a rack, shelf, etc., be sure to leave more than 8 inches of space above the receiver.

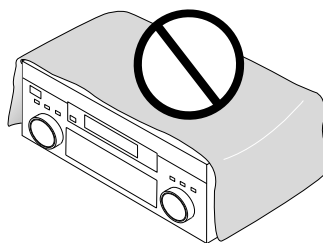

8 inches (20 cm)

Receiver

Opening the Front Panel

To open the front panel push gently on the lower third of the panel with your finger.

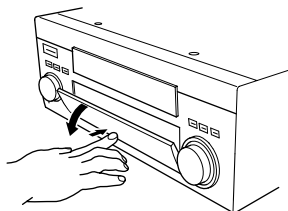

Home Theater: The Basics

Most consumers are used to using stereo equipment to listen to music but many people are not used to home theater systems that give you many more options when listening to soundtracks. In fact, home theater is not really complicated and this little guide should give you an understanding of the basics. Home theater refers to the use of multiple audio tracks combined with multiple speakers to create a surround sound effect.

There are three different factors involved in getting surround sound. Each contribute to what kind of sound you get.

These factors are:

- 1) The equipment you are using for your home theater setup. Particularly important is the number of speakers you are using. We call this your speaker configuration.
- 2) The 'source' material you are using. This is the actual product (like a DVD) or broadcast (like cable TV) you are listening to/watching. We call this the source.
- 3) The last factor is the listening mode you choose on the VSX-43TX receiver. These are explained below and in subsequent chapters but most likely the PRO LOGIC II MOVIE for movies and the PRO LOGIC II MUSIC for music will be fine.

Let's start with the home theater setup you have in your home.

1) Your Home System

The heart of your system is the VSX-43TX receiver and it is very flexible in getting you theater-like surround sound. You can use this receiver with anywhere from two to seven speakers (front left, front right, center, surround left and right, and surround back left and right) and a subwoofer to get home theater surround sound. We recommend you use seven speakers and a subwoofer. If this is not possible follow the instructions in "QUICK Setup" in the "Easy Setup Guide Part 2" and you will still be able to get good surround sound. Also, a DVD player is essential for home theater and you can also hook up satellite or cable TV tuner to this receiver and get a more home theater-like sound from these sources.

2) The Source Material

DVDs have become the basic source material for home theater because they are convenient to use and offer excellent sound and picture quality as well as allow users to enjoy home theater soundtracks with more than two channels of audio. For example, Dolby Pro Logic plays back four channels (front left, front right, center and a single channel for both surround speakers), Dolby Digital and DTS sources usually have six discrete channels (front left, front right, center, surround left and right and a channel that powers the subwoofer) of sound. Since the subwoofer channel is only for bass sounds it is expressed as .1 of a channel and this multichannel setup has been named 5.1 channel sound.

It is important you consult the manual that came with your DVD player as well to make sure the player is outputting a surround soundtrack and all the other settings are appropriate for your home theater.

3) The Listening Modes

This receiver has many different listening modes and they are designed to cover all the speaker configurations and types of sources you might be using. In general, the PRO LOGIC II MOVIE listening mode is the easiest way to get realistic surround sound for movies. For music the basic listening mode for music is PRO LOGIC II MUSIC.

To listen to music in stereo simply choose the STEREO listening mode. Other possibilities (like listening to a stereo CD with all seven speakers or taking a stereo source and getting multichannel home theater-like sound) are explained in listening modes (pages 43-45).

Conclusion

These are the three basic factors that contribute to your home theater sound. The easiest thing is to hook up seven speakers and a subwoofer and simply play your DVDs with PRO LOGIC II MOVIE listening mode. This will give you realistic and enjoyable home theater sound. First hook up your equipment, like your DVD player, TV and speakers. Then follow the Easy Setup Guide instructions to set up your system for surround sound. It is very important you do one of the surround sound setups to get optimal sound from your receiver.

For more details on any of the information presented here check the main section of the manual.

Before making or changing the connections, switch off the power and disconnect the power cord from the AC outlet.

1 Hooking Up Your DVD Player & TV

In order to use Dolby Digital/DTS soundtracks, which are at the heart of home theater, you need to hook up your DVD player with digital audio connections. You can do this by either a coaxial or an optical connection, **you don't need to do both**. The quality of these two types of connections is the same but since some DVD players only have one type of digital terminal you need to figure out which yours has and hook it up to the appropriate terminal on the receiver. In order to do this you will need the proper cable. For coaxial connections you can use a regular RCA video cord or the specially-made coaxial cords, they have the same type of plugs. For optical connections you will need a special optical cable which you can buy at your local stereo store. For more information on cords and cables see page 21. You should also hook up your DVD player with analog audio connections. Use regular RCA stereo cords for these connections. Also hook up the video connection on your DVD player, and your TV to this receiver. For your TV it's easiest to use a regular composite (RCA) video cord, as shown below. S Video and Component video cords are of higher quality than RCA video cords and may also be used with this unit.

Digital Connections

Some DVD players have both coaxial and optical terminals, but there is no need to connect both. If your DVD player has a coaxial terminal (not a PCM-only output) for the audio out hook it up using this terminal. Follow the diagram below. This is the best scenario, as you will be able to follow the default settings of this receiver and won't need to assign the digital inputs (you should use DIGITAL IN 3).

If your DVD player only has an optical terminal for the audio output you can hook it up using one of the DIGITAL IN terminals between 1-2 (for example, DIGITAL IN 2). In this case, you will need to assign the digital input (which means tell the receiver which input you used for your DVD digital audio). See page 12 for this.

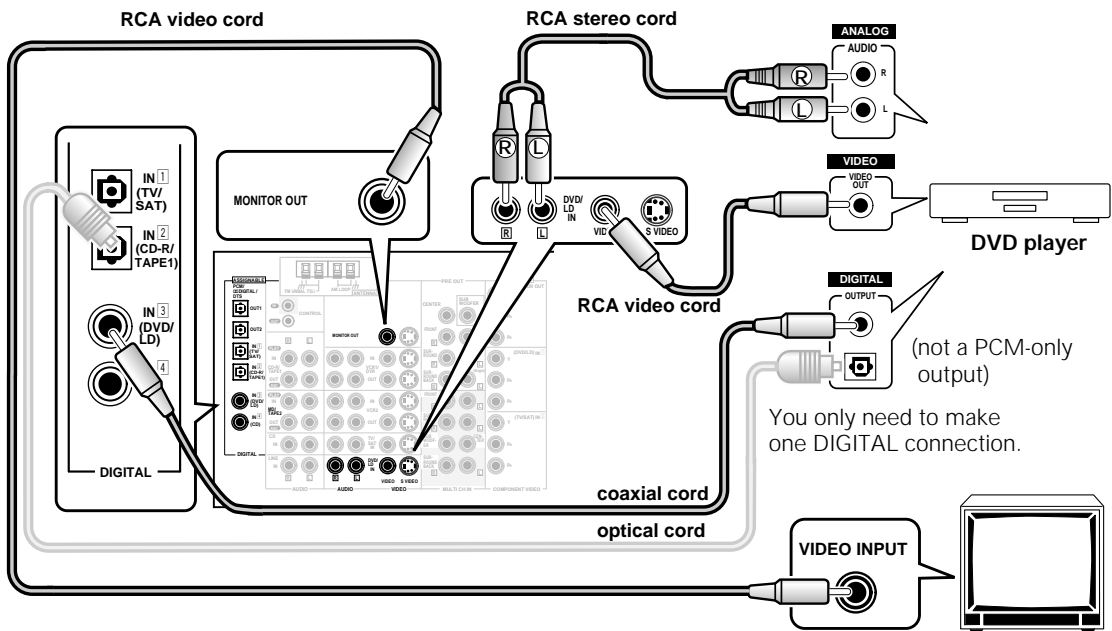

2 Speaker Connections

Home theater is designed to be setup with five, or seven speakers (front left & right; center; surround left & right; and, optimally, surround back left & right) and a subwoofer, but you can use this receiver with fewer speakers. Hook up the speakers you have to the A speaker terminals on the back of the receiver. If you only have two speakers hook them up as FRONT. If you have three hook up the single speaker as CENTER. Follow the diagram below in order to hook up all your speakers. A center speaker is very important for watching films because in digital soundtracks the dialog comes from the center speaker. If you do not have a center speaker you must tell the receiver the center channel is off or when you listen to digital soundtracks you won't hear any dialog. This can be easily accomplished by following the steps in the Surround Sound QUICK setup instructions from page 13 of the Easy Setup Guide.

If possible, use surround back speakers. These speakers are important to take full advantage of all the sound channels on new, eight channel home theater DVDs. The diagram below also explains how to hook up a subwoofer which provides realistic bass sounds. For the subwoofer use a mono (single plug) RCA cord and for the other speakers use regular speaker cords. **See pages 91–92 for advice on speaker placement.** Make sure you connect the speaker on the right to the R terminal and the speaker on the left to the L terminal. Also make sure the positive and negative (+/-) terminals on the receiver match those on the speakers.

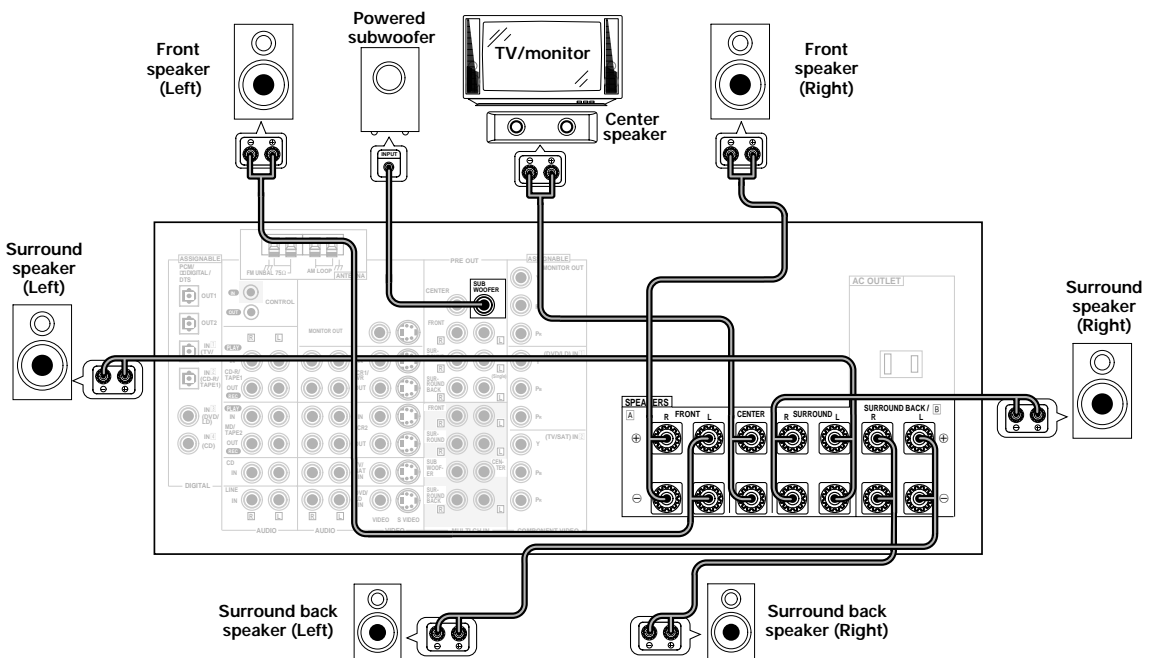

- We recommend speakers with a nominal impedance rated $8\ \Omega$ - $16\ \Omega$, but you can change the speaker impedance setting of the receiver (see page 25).
- If you only have one surround back speaker hook it up to the left surround back terminal.
- If you use a THX certified subwoofer use the THX INPUT jack on the subwoofer (if your subwoofer has one) or switch the filter position to THX on your subwoofer.
- When you attached your speaker wire to the speaker terminal make sure that not even one strand of wire touches the back of the receiver. If this happens it could short out the receiver.

■ Speaker terminals

① Twist exposed wire strands together tightly.

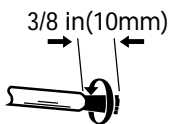

② Loosen speaker terminal and insert exposed wire.

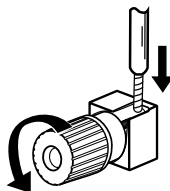

③ Tighten terminal.

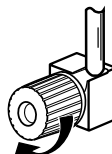



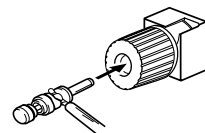

The speaker terminals also accept single banana plugs. (Refer to speaker manual for details.)



3 Setting up the Main Unit

- 1 Plug the AC power cord into a wall outlet.
- 2 Press the  STANDBY/ON button to switch the receiver ON.

4 Assigning the Digital Inputs

This is only necessary if you did not hook up your DVD player to DIGITAL IN  using a coaxial cable but rather connected it to one of the optical digital inputs. The following example shows how to assign the DIGITAL IN  jack to DVD. Use the arrow buttons ( ) and the ENTER button on the remote control to navigate the display on the receiver. Conversely, you can use the MULTI JOG dial and ENTER button on the front panel.

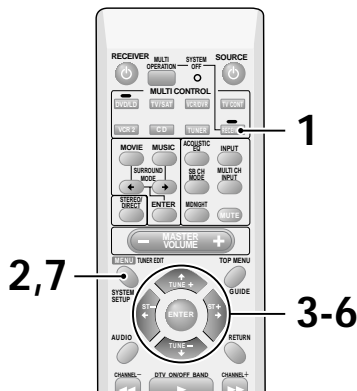

- 4 DIGITAL-IN should be selected, if not use the   buttons to select it. Press the ENTER button.

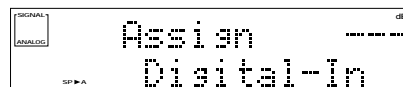

- 5 Use the   buttons to select DIGI-2: CD-R and press ENTER.

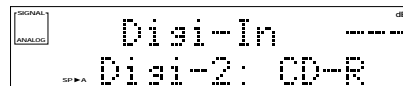



When you press ENTER, CD-R blinks.

- 1 Turn on the receiver and your TV, press the RECEIVER button on the remote control.

- 2 Press the SYSTEM SETUP button.



This display appears on the receiver.

- 3 Looking at the display on your receiver, use the   buttons to select INPUT ASSIGN. Press the ENTER button.

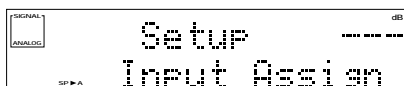

- 6 Use the   buttons to select DVD/LD and press ENTER.

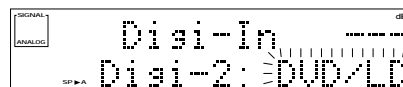

- 7 Press the SYSTEM SETUP button.

The receiver exits the setup process.

Easy Setup Guide Part2

1 QUICK setup

With this QUICK setup you can quickly and easily adjust the speakers settings so that you get enjoyable surround sound with minimum effort.

You must have front and surround speakers hooked up to use this setup.

You only need to do these settings once (unless you change the placement of your current speaker system or add new speakers, etc.).

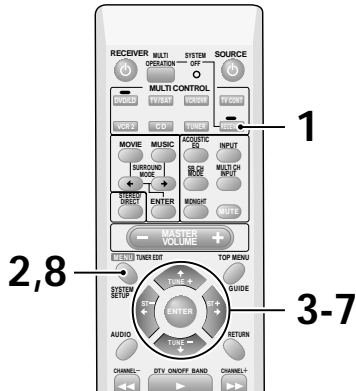

1 Press the RECEIVER button on the remote control.

2 Press the SYSTEM SETUP button.



This display appears on the receiver.

3 SURROUND SETUP should be selected, if not use the ▲▼ buttons to select it. Press the ENTER button.

4 Use the ▲▼ buttons to select QUICK. Press the ENTER button.

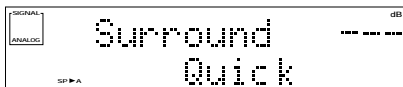

5 Use the ▲▼ buttons to navigate through the QUICK setup menus. When you get a menu you want to adjust press ENTER.

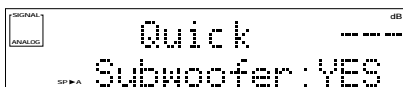

When ENTER is pressed, the setting for each selected menu blinks.

In each mode, the current settings are displayed automatically. We suggest you adjust all these settings when you first hook up the receiver.

SUBWOOFER setting:

If you connected a subwoofer select YES, if you didn't select NO.

CENTER SP setting:

If you connected a CENTER speaker select YES, if you didn't select NO.

SURRBACK SP setting:

If you connected a SURROUND speaker(s) select YES, if you didn't select NO.

ROOM SIZE setting:

Tell the receiver your room size so it can equalize the speakers properly. Use the chart below for an approximate definition of the settings.

S: 12 feet by 15 feet

M: 18 feet by 20 feet

L: 25 feet by 30 feet

LISTENING POSITION setting:

This setting establishes where your ideal listening position is. Choose from the three possibilities following the guide below.

FRONT: your listening position is closer to the front speakers.

CENTER: your listening position is equidistant from the front and surround speakers.

REAR: your listening position is closer to the surround speakers.

6 In a menu use the ▲▼ buttons to select the different settings. When you have the setting you want in a particular menu, press ENTER.



7 Repeat steps 5 and 6 to change other menus.

8 Press the SYSTEM SETUP button.

The receiver exits the setup process.

2 Playing a DVD with Surround Sound

- 1 Make sure the receiver, your TV, your subwoofer and your DVD player are switched ON.**
- 2 Press the DVD/LD button on the remote control.**
You should see DVD/LD in the display on the receiver.
- 3 Play a DVD then adjust the MASTER VOLUME.**



To get a more refined sound, make the sound settings in "Expert setup" (starting on page 79).

If you're having trouble getting surround sound playback look at this Frequently Asked Questions (FAQ) guide:

Q1: Even though I'm playing a DVD I'm not getting 5.1 channel playback.

A1: Either the DVD is not set for digital output, or the Dolby Digital/DTS output settings are not correct.

Set the DVD player to output a digital signal and set the Dolby Digital and DTS output properly. If you are unsure how to do this check the DVD initial setup in the manual that came with your DVD player.

Q2: There is no sound from the subwoofer or it is very low.

A2: There is a good possibility you haven't reached a part of the DVD that has an LFE channel (which feeds the subwoofer) yet. The LFE channel only appears in selected parts of the soundtrack. Continue playing and listen for the subwoofer.

If you want to hear more sound from the subwoofer set it to PLUS (see page 37 for more information and consult the memo on page 38).

Connecting Your Equipment

Connecting your TV

Before making or changing the connections, switch off the power and disconnect the power cord from the AC outlet.

Connect your TV to the jacks as shown below. Hook up with either component video, S video, or composite video cords (the quality descends in this order) **but you must use the same type of video cords to hook up your DVD player (and all other video components) as you use to hook up your TV.** If you plan to hook up your DVD player with component video cords hook up your TV with them as well. Composite video cords, which look just like regular RCA audio cords (see page 19) but have only one cable are the most common.

*The arrows indicate the direction of the signal.

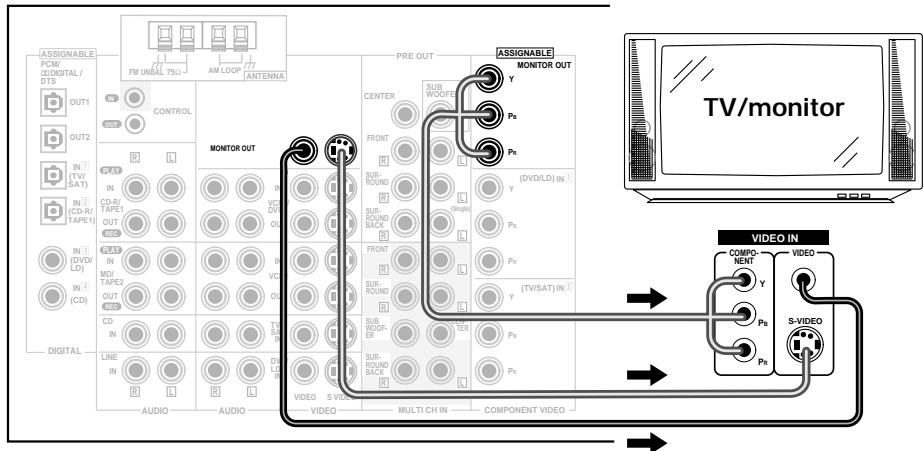

PREPARATION

S Video

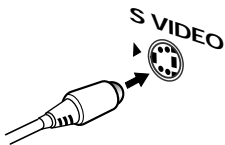

S video cables produce clearer picture reproduction by sending separate signals for the luminance and the color.

Component video

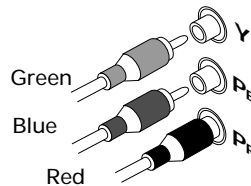

The video signal is divided into the luminance (Y) signal and the color (Pb and Pr) signals. In this way, interference between the signals is avoided.

Composite Video

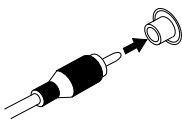

Composite video cords are the most common or standard video cord but also the lowest quality. The color on the connector is yellow to distinguish it from regular RCA audio cords which have white and red connectors (see page 19). It is important to use a true composite video cord and not an audio cord (though they look exactly the same) because the impedance is different and this will affect the picture quality.

Component Video Input Default Settings

If you use component video cords to hook up your video equipment it is easiest to do so following the default settings, which are listed below. Remember you must use component video cords from your video source (for example, a DVD player) to the receiver and from the receiver to your TV (or monitor). If you don't follow the default settings below you must assign the inputs you used with the "Assigning the Component Video Inputs" procedure. See page 77 to do this.

The default settings are:

COMPONENT VIDEO IN 1: DVD/LD

COMPONENT VIDEO IN 2: TV/SAT

Connecting Video Components

Before making or changing the connections, switch off the power and disconnect the power cord from the AC outlet.

Connect your video components as shown on this and the following page. For video components (for example, a DVD player) there are two types of connections to make, video and audio.

Hook up your video signal with either component video, S video or composite video cords (the quality descends in this order) but you must use the same type of cord as you used to hook up your TV.

For the audio signal, in order to use digital soundtracks like Dolby Digital or DTS you must hook up a digital input, with either a coaxial or optical cord (see page 21). It is also a good idea to hook up your components with analog audio connections as well.

If you want to record from your DVD player composite (or S video) cord connections and analog audio connections are necessary.

Connecting a DVD player

Before making or changing the connections, switch off the power and disconnect the power cord from the AC outlet.

Hook up your audio signal with either a coaxial or optical digital cords (you don't need to do both). If you hook up your DVD/LD player using component video cable connections you might need to setup your DVD player for component video output as well. See your DVD manual for details. If you have a DVD-Audio or Super Audio CD (SACD) compatible player, see "Connecting to the Multi Channel Analog Inputs" on page 20.

You need to hook up your audio with analog connections as well.

*The arrows indicate the direction of the signal.

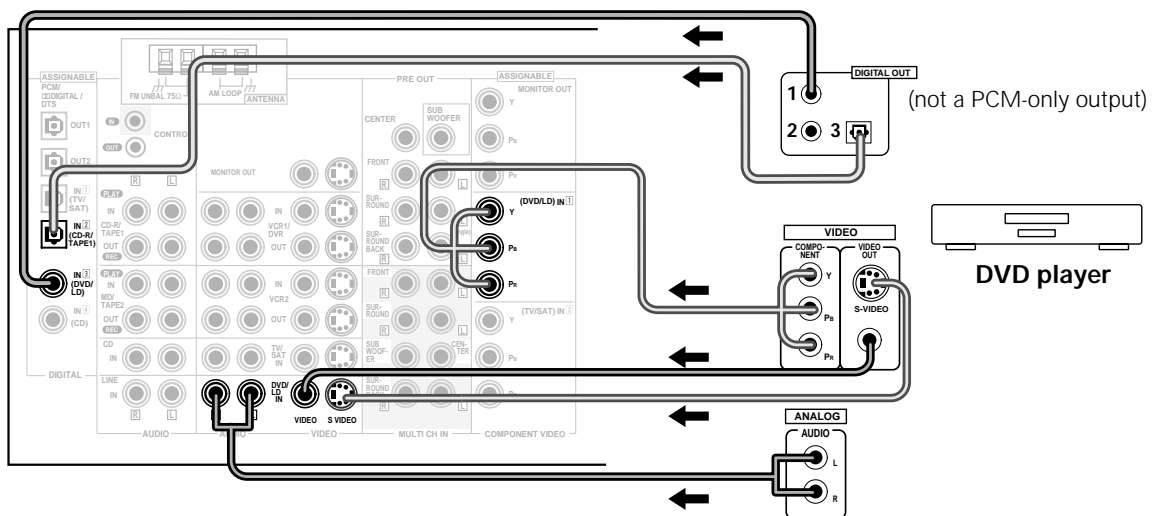

- Be sure to make either a digital coaxial or digital optical connection (pictured as DIGITAL jack 3 or DIGITAL jack 2 in this diagram) but you DON'T need to make both.
- If your digital connections are different than the default settings you will need to assign the digital jacks to the proper component(s) with the "Assigning the Digital Inputs" procedure. See page 76 to do this.
- If your component video connections are different from the default settings, you will need to assign them with "Assigning the Component Video Inputs". See page 77 for how to do this.

Connecting VCRs or DVRs

Before making or changing the connections, switch off the power and disconnect the power cord from the AC outlet.

Connect the video out of your VCR/DVR using either S video or composite video cords, depending on how you connected the receiver to your TV (see page 15). Use analog audio cords for the audio signal. To record, you also need to connect a set of audio/video outputs from the receiver to the audio/video inputs on your VCR/DVR. Note that to record video from a source component, the video connection from the source to the receiver and from the receiver to the recorder must be the same type.

*The arrows indicate the direction of the signal.

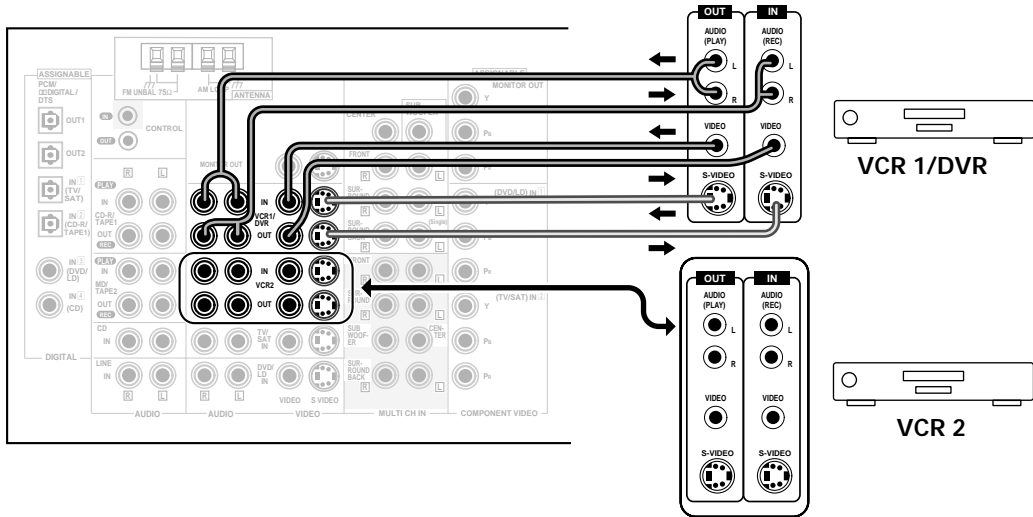

Connecting a Video Component to the Front Panel

Before making or changing the connections, switch off the power and disconnect the power cord from the AC outlet.

Connect a portable DVD player, video game console or any video component to the front panel as show here. Front video connections are accessed via the front panel input selector as VIDEO

*The arrows indicate the direction of the signal.

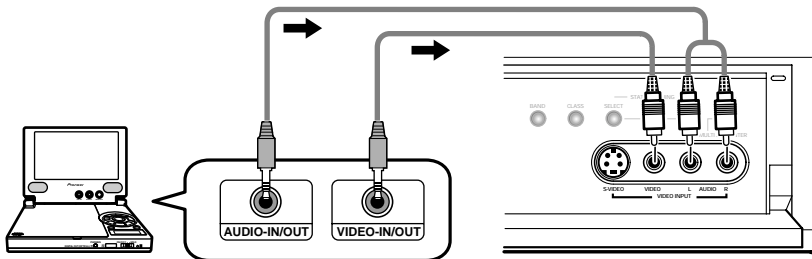

Be careful! For portable DVD players you will need a specialized cord (for the audio) that has a mini plug on one end and a regular plug on the other.

Connecting Your Equipment

Connecting Satellite TV (SAT) Components

Before making or changing the connections, switch off the power and disconnect the power cord from the AC outlet.

Hook up the video signal with either component video, S video, or composite video cords, depending on how you connected the receiver to your TV (see page 15).

For the audio signal, in order to use digital soundtracks broadcast you must hook up a digital input. Use either a coaxial or optical cable, it doesn't matter which (see page 21). We recommend hooking up your audio with analog cables as well (see below).

*The arrows indicate the direction of the TV signal.

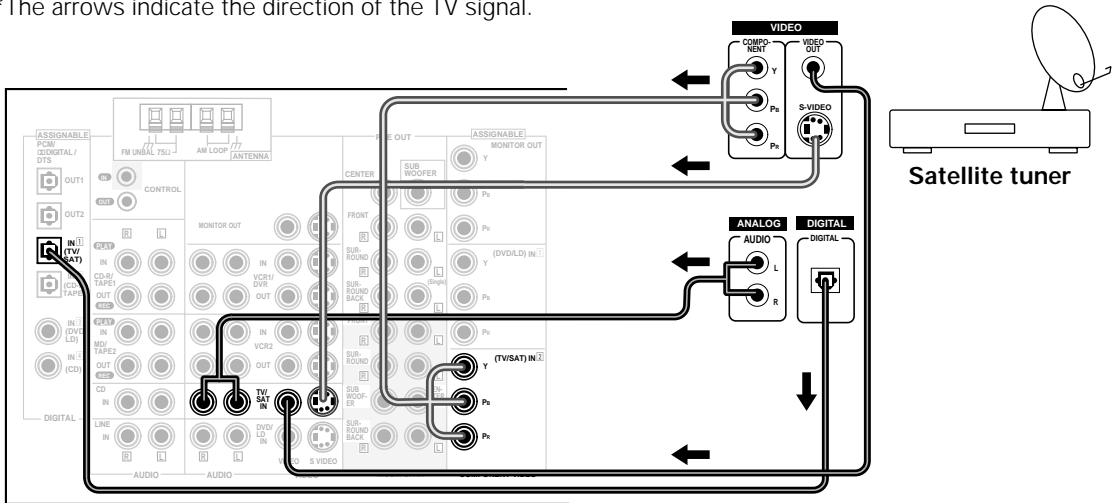

- If your component video connections are different from the default settings, you will need to assign them with "Assigning the Component Video Inputs". See page 77 to do this.
- If your digital connections are different than the default settings you will need to assign the digital jacks to the proper component(s) with the "Assigning the Digital Inputs" procedure. See page 76 to do this.

Connecting Your Equipment

Connecting to the Multi Channel Analog Inputs (DVD-Audio or Super Audio CD (SACD) compatible player)

Before making or changing the connections, switch off the power and disconnect the power cord from the AC outlet.

If you have a DVD-Audio or Super Audio CD (SACD) compatible player, or are using an external Dolby Digital/DTS decoder, connect it to the multichannel analog inputs as shown below.

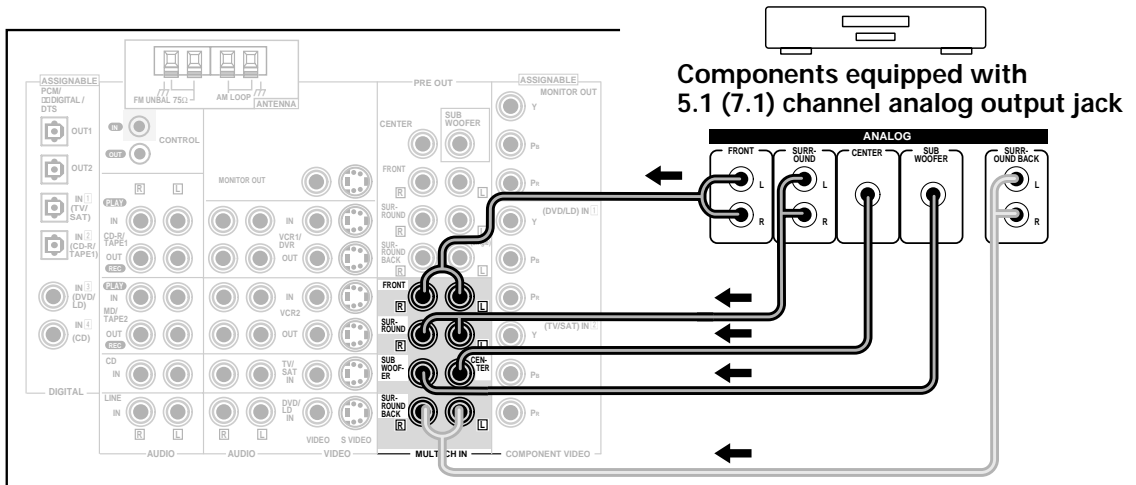

If you use only one surround back input, be sure to hook up to the SURROUND BACK jack.

Connecting Digital Audio Components

Before making or changing the connections, switch off the power and disconnect the power cord from the AC outlet.

Connect your digital components as shown below. The VSX-43TX has two coaxial, two optical inputs for a total of four digital inputs. In order to use digital soundtracks like Dolby Digital or DTS (among others) you need to make digital audio connections. You can do this by either a coaxial or an optical connection (you don't need to do both). The quality of these two types of connections is the same but since some digital components only have one type of digital terminal, it is a matter of matching like with like (for example, the coaxial out from the component to coaxial in on the receiver).

Hook up your digital equipment in accordance with this receiver's default settings (see next page) unless you want to, or need to, change them. To do this see "Assigning the Digital Inputs" on page 76.

There are two optical digital out jacks (the CD recorder is connected to one in the diagram below). If you connect this to the optical input on a digital recorder (currently these include MD, DAT and CD-R) you can make direct digital recordings with this unit.

We also recommend hooking up your digital components to analog audio jacks (see page 19) in order to make recordings because some digital sources may be protected against making digital copies.

*The arrows indicate the direction of the audio signal.

PREPARATION

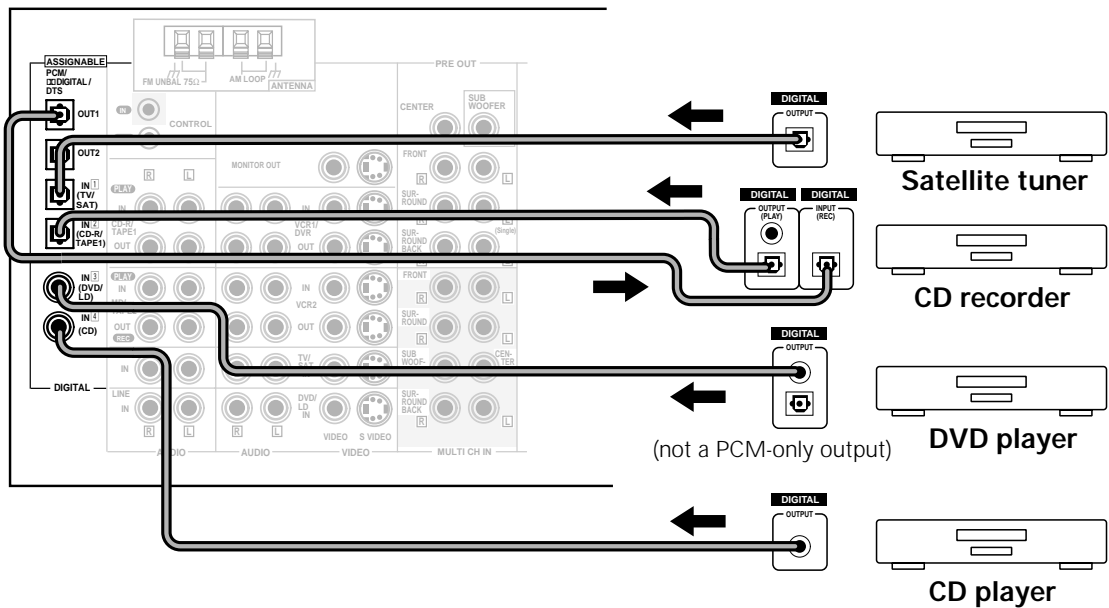

■ Coaxial cords/Optical cables

Commercially available digital audio coaxial cords (standard video cords can also be used) or optical cables (not supplied) are used to connect digital components to this receiver.

Be sure to insert completely and in the case of the optical cable, right-side up. If it is inserted improperly it can break the shutter on the optical terminal (this won't, however, affect the connection or insertion of an optical cable).

**Coaxial cord
(or standard [composite]
video cord)**

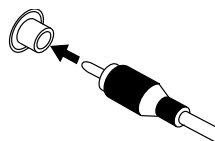

Optical cable

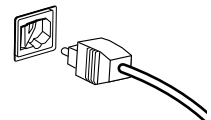

Connecting Your Equipment

Digital Input Default Settings

Unlike analog connections, the jacks for digital connections are not dedicated to one type of component, they can be used freely. Thus you must tell the receiver what digital component is connected to which jack so your components will be in sync with the names on the remote control buttons and the like. To avoid having to assign the digital inputs you can hook up your equipment in accordance with the receiver's default settings.

The default settings are:

DIGITAL IN **1** (optical): TV/SAT

DIGITAL IN **2** (optical): CD-R/TAPE1

DIGITAL IN **3** (coaxial): DVD/LD

DIGITAL IN **4** (coaxial): CD

See "Assigning the Digital Inputs" on page 76 if the way you hook up your equipment is different from the default settings listed above.

Connecting the Radio Antennas

Before making or changing the connections, switch off the power and disconnect the power cord from the AC outlet.

Connect the supplied FM wire antenna and the AM loop antenna to the ANTENNA terminals as shown below. These antennas should provide adequate reception quality in most cases, but connecting outdoor antennas should noticeably improve sound quality.

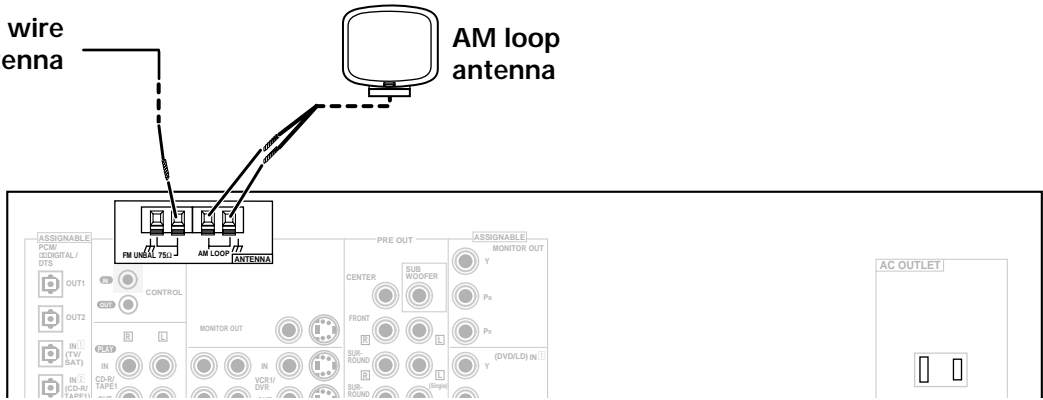

■ AM loop antenna

- ① Assemble the antenna.
- ② Twist exposed wire strands together and insert.
- ③ Attach to a wall, etc. (if desired) and face toward the direction providing the best reception.

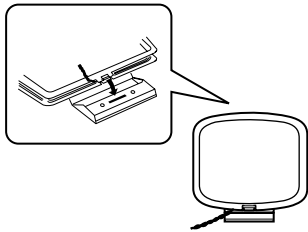

3/8 in. (10 mm)

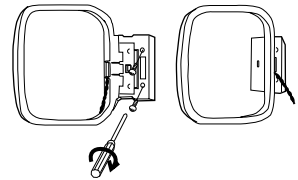

Using outdoor antennas

■ To improve FM reception

Connect an external FM antenna.

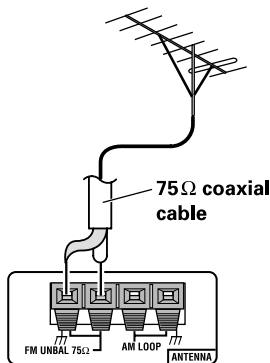

■ To improve AM reception

Connect a 15 to 18 feet (5 – 6 meter) length of vinyl-coated wire to the AM LOOP ANTENNA terminal in addition to the supplied AM loop antenna.

For best possible reception, suspend horizontally outdoors.

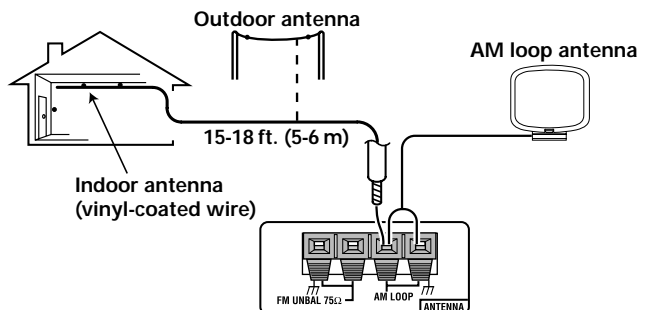

Connecting Speakers

Before making or changing the connections, switch off the power and disconnect the power cord from the AC outlet.

We recommend a full complement of seven speakers and a subwoofer as shown here but, naturally, everyone's home setup will vary. Simply connect the speakers you have in the manner described below.

One of the latest features of home theater is the use of surround back speakers. These speakers add even greater realism in movie sound effects and some new discs with soundtracks in Dolby Digital or DTS incorporate these channels. See the page 26 for speaker placement.

In general, make sure you connect the speaker on the right to the R terminal and the speaker on the left to the L terminal. Also make sure the positive and negative (+/-) terminals on the receiver match those on the speakers.



- We recommend speakers with a nominal impedance rated $8\ \Omega$ - $16\ \Omega$, but you can change the speaker impedance setting of the receiver (see page 25).
- If you only have one surround back speaker hook it up to the left surround back terminal.
- If you use a THX certified subwoofer use the THX INPUT jack on the subwoofer (if your subwoofer has one) or switch the filter position to THX on your subwoofer.

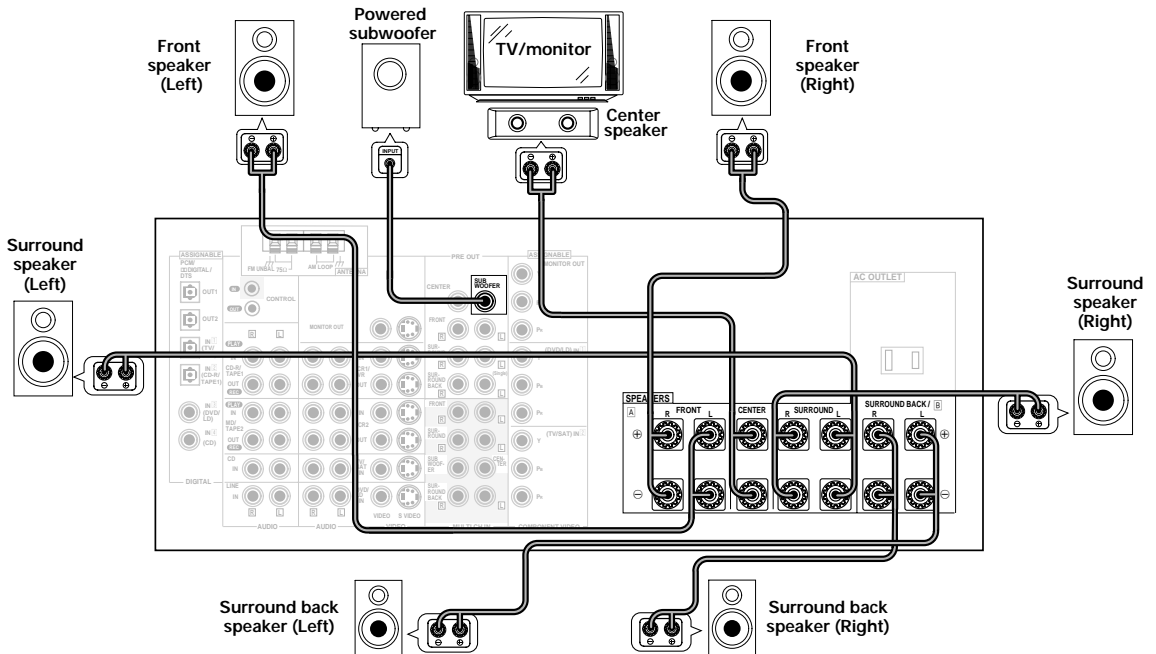

Speaker terminals

① Twist exposed wire strands tightly

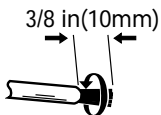

② Loosen speaker terminal and insert exposed wire.

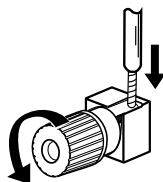

③ Tighten terminal.

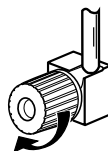

The speaker terminals also accept single banana plugs. (Refer to speaker manual for details.)

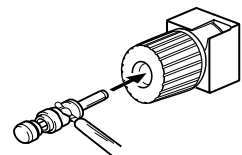

Speaker impedance

You can change the speaker impedance for VSX-43TX but we recommend using speakers with an impedance of 8 Ω -16 Ω (the default setting). If you are using 6 Ω - less than 8 Ω impedance speakers, you need to change the impedance setting. Use any speaker rated between 6 Ω -16 Ω .

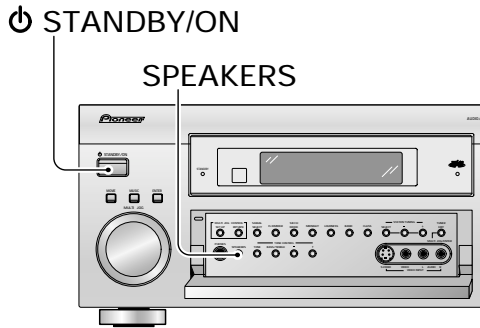

First put the receiver in STANDBY mode, then press the power button while holding down the SPEAKERS button.

The receiver will reset to the new impedance setting. With this method you can choose the 8 Ω -16 Ω setting or the 6 Ω -8 Ω setting.

To check which impedance setting to hold down the SPEAKERS button for 2-3 seconds. You'll get a display like these telling you the speaker impedance setting.



(This display indicates an 8 Ω -16 Ω impedance setting.)



(This display indicates a 6 Ω -less than 8 Ω impedance setting.)

Bi-wiring your speakers

This high quality but difficult method of wiring speakers will be unnecessary for most users. In order to do this your speakers must be bi-wireable (that is they must have separate terminals for the high and low frequencies).

To bi-wire a speaker, connect two sets of speaker cords to each speaker terminal on the receiver. The easiest way to do this is to connect one wire in the normal way, and use a banana plug for the other one. Make sure you use a parallel (not series) connection when doing so. Don't connect different speakers from the same terminal in this way.

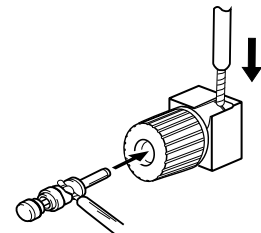

Connecting Your Equipment

Placing Your Speakers

Proper speaker placement is essential to realize the best sound from your system. The diagram and tips given here are just a rough guide, for more information see pages 91 & 92. Also, it is very important for speaker placement to read the instructions that come with your speakers so please be sure to do so.

Speaker placement

If you have a multiple speaker arrangement the placement of the speakers is extremely important. To achieve the best possible surround sound, install your speakers as shown below. Make sure all speakers are installed securely to prevent accidents and improve sound quality. Some speakers are designed to be floor-standing but others benefit greatly from speaker stands which raise them off the floor. Be sure to read your speaker manuals for the best placement of the speakers.

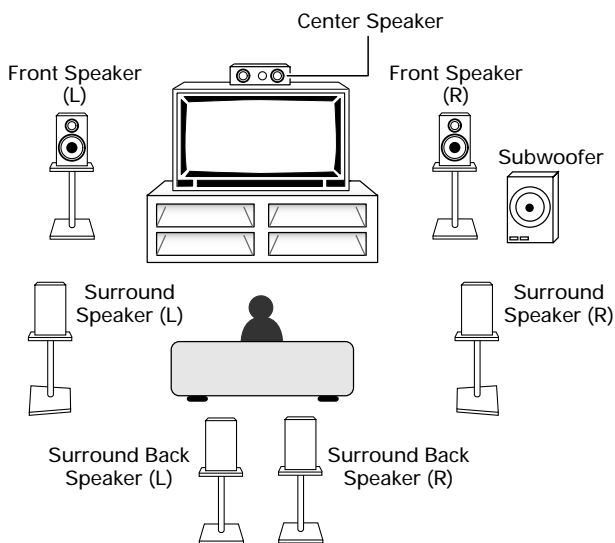

- When installing speakers near the TV, we recommend using magnetically shielded speakers to prevent distortion in the color of the TV screen. If you do not have magnetically shielded speakers and notice discoloration of the TV screen, place the speakers farther away from the TV.
- Install the center speaker above or below the TV so that the sound of the center channel is localized at the TV screen.
- THX recommends that if you have two surround back speakers place them close together.

CAUTION:

When installing the center speaker on top of the TV, be sure to secure it with suitable means.

AC Power Cord

Plug in the power cord to a wall outlet after you have finished hooking up the rest of your equipment.

CAUTION!

- The equipment should be disconnected by removing the mains plug from the wall socket when not in regular use, e.g. when on vacation.

AC Outlet [switched 100 W max]

Power supplied through this outlet is turned on and off by this unit's STANDBY/ON button. Total electrical power consumption of connected equipment should not exceed 100 W.

CAUTION!

- Do not connect appliances with high power consumption such as heaters, irons, or television sets to the AC OUTLET in order to avoid overheating or fire risk. This can cause the amplifier to malfunction.
- **DO NOT CONNECT A MONITOR OR TV SET TO THIS UNIT'S AC OUTLET.**

Displays & Controls

Display

All the display information is explained and/or referenced here.

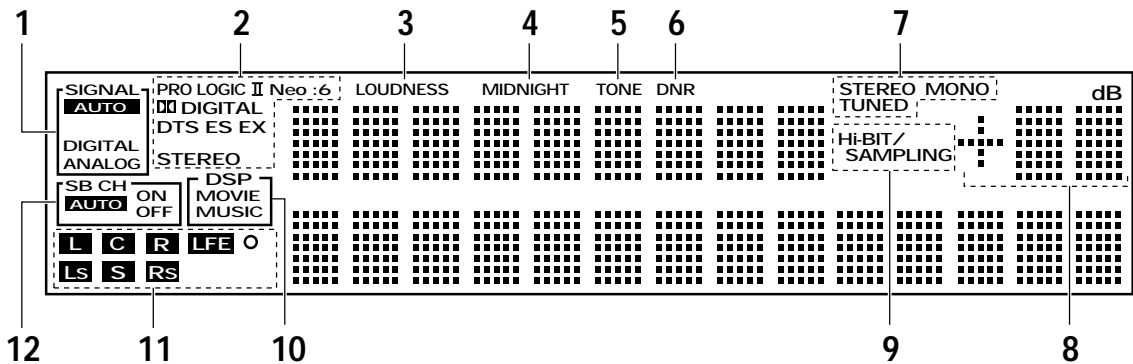

1 SIGNAL SELECT indicators

Light to indicate the input signal you selected.

AUTO: Lights when the receiver is set to select the audio input signal automatically.

DIGITAL: Lights when digital audio signals are selected.

ANALOG: Lights when analog audio signals are selected.

2 Digital format indicators

PRO LOGIC II: Lights during Dolby Pro Logic, Dolby Pro Logic II processing.

NEO:6: Lights during NEO:6 processing.

DIGITAL: Lights when a Dolby Digital signal is detected.

DTS: Lights when a DTS signal is detected.

ES: Lights when playing back a DTS ES signal.

EX: Lights when playing back a Dolby Digital EX signal.

STEREO: Lights during two-channel playback.

3 LOUDNESS indicator

Lights when LOUDNESS is on.

4 MIDNIGHT indicator

Lights when MIDNIGHT is on.

5 TONE indicator

Lights when the TONE control is on.

6 DNR indicator

Lights when DIGITAL NR is on.

7 TUNER indicators

STEREO: Lights when an FM stereo broadcast is received in the auto stereo mode.

MONO: Lights when the tuner is set to receive FM broadcasts and when MPX mode is selected.

TUNED: Lights when a broadcast is received.

8 Volume level indicator

9 Hi-BIT/SAMPLING indicator

Lights when a HI-BIT/SAMPLING mode is on.

10 DSP indicators

MOVIE: Lights when a MOVIE mode is selected. When a DSP MOVIE mode is selected DSP will light with a box around it.

MUSIC: Lights when a MUSIC mode is selected. When a DSP MUSIC mode is selected DSP will light with a box around it.

11 Program Format indicators

For Dolby Digital or DTS sources : These indicators change according to which channels are active in the source. When all three **LS** (left surround), **S** (surround) and **RS** (right surround) light at the same time it means a source with a 6.1 channel playback flag is being used.

L – Left front channel.

C – Center channel.

R – Right front channel.

LS – Left surround channel.

S – Surround channel or Surround back channel.

RS – Right surround channel.

LFE – Low Frequency Effects channel.

o – Lights when LFE signal is input.

12 SB CH indicators

Light to indicate the status of the surround back channels.

AUTO – Lights when the SB CH MODE or VIRTUAL SURROUND BACK mode is set to AUTO.

ON – Lights when the SB CH MODE or VIRTUAL SURROUND BACK mode is set to ON.

OFF – Lights when the SB CH MODE or VIRTUAL SURROUND BACK mode is set to OFF.

Front Panel

All the controls on the front panel are explained and/or referenced here. To open the front panel push gently on the lower third of the panel.

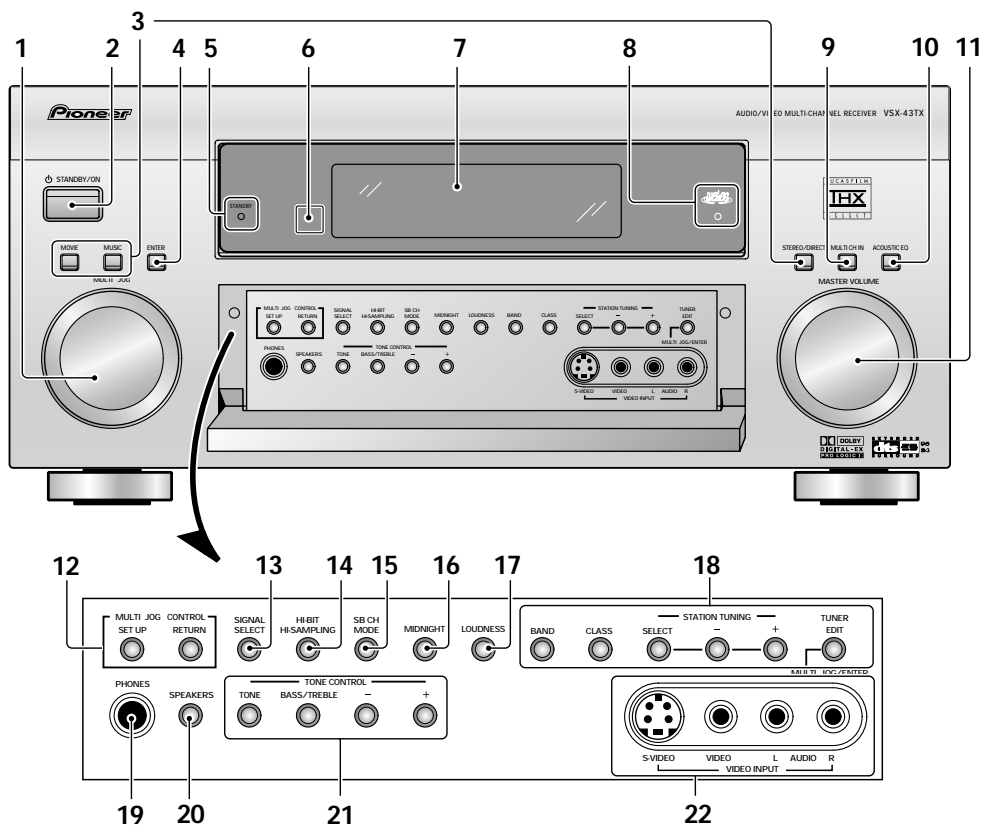

1 MULTI JOG dial

You can use this dial for many purposes. When you press the SET UP button (12), you can use it to perform SYSTEM SETUP operations; select a function (like a DVD) or a listening mode (like Dolby Pro logic II) or do TUNER EDIT functions (in TUNER mode).

2 **STANDBY/ON** button

Press to switch the receiver ON or into STANDBY mode.

3 Listening mode buttons (see pages 43-45)

There are two types of SURROUND modes:

MOVIE: Press to put the receiver into MOVIE listening mode (see page 44).

MUSIC: Press to put the receiver into MUSIC listening mode (see page 45).

STEREO/DIRECT (see page 43): Switches the receiver into STEREO mode if it was in a different sound mode or toggles between DIRECT and STEREO mode.

DIRECT playback bypasses the tone controls and channel level for the most accurate reproduction of a program source.

4 ENTER button

Use this button to enter information concerning the SYSTEM SETUP, listening mode or the tuner.

5 STANDBY indicator

Lights when the receiver is in STANDBY mode. (Please note that this receiver consumes a small amount of power [0.6 W] in the standby mode.)

6 Remote sensor

Receives the signals from the remote control.

7 Display (See page 27)

8 MCACC indicator (see page 47)

Lights when the ACOUSTIC CAL EQ is on.

9 MULTI CH IN button

Use this button to select the component you have hooked up to the MULTI CH IN terminals (for example, a DVD-Audio player).

10 ACOUSTIC EQ button (see page 47)

Use to switch on and off the Acoustic Calibration EQ.

11 MASTER VOLUME dial

Use to raise or lower the volume of the receiver.

12 MULTI JOG CONTROL buttons

SET UP

Press to switch the SYSTEM SETUP mode.

RETURN

Press to move back one step in the SYSTEM SETUP process.

13 SIGNAL SELECT button (see page 42)

Press SIGNAL SELECT repeatedly to select one of the following:

AUTO – If there are analog and digital signals input, the receiver automatically selects the digital signal.

DIGITAL – To select an optical or coaxial digital signal.

ANALOG – To select an analog signal.

14 HI-BIT HI-SAMPLING button (see page 50)

Use this button to switch the HI-BIT HI-SAMPLING on or off. Use to hear CD and DVD, as well as other digital soundtracks at a wider dynamic range, allowing for finer audio reproduction.

15 SB CH MODE button (see pages 51)

Use this button to turn the surround back channels ON/OFF/AUTO or switch the VIRTUAL SURROUND BACK mode between ON/OFF/AUTO.

16 MIDNIGHT button (See page 48)

Switches the MIDNIGHT mode on or off (cannot be used in THX CINEMA mode).

17 LOUDNESS button (see page 48)

Switches the LOUDNESS mode on or off (for all modes except THX CINEMA and MULTI CH IN).

18 TUNER CONTROL buttons (See page 54-58)

BAND

Press to select the AM or FM band.

CLASS

Press repeatedly to switch the preset station classes.

SELECT

Switches the $-/+$ buttons between station memory and frequency select modes.

$-/+$

Selects station memories or frequencies when using the tuner.

TUNER EDIT

Press to memorize and name a station for recall using the MULTI JOG and ENTER buttons.

19 PHONES jack

Connect headphones for private listening (no sound will be heard through the speakers).

20 SPEAKERS (A/B) button

The use of this button depends on how the SURRBACK SYSTEM (see page 35) are set. If NORMAL SYSTEM is chosen this button toggles between A and OFF. If SECOND ZONE is chosen this button toggles between A, B, A+B and OFF (see page 66). If FRONT BI-AMP is chosen this button toggles between A+B and OFF (see page 66).

21 TONE CONTROL buttons (see page 49)

TONE button

This button switches between TONE ON and TONE BYPASS, which bypasses the tone circuitry.

BASS/TREBLE button

Use to select whether the bass or treble will be adjusted.

$-/+$ buttons

Use to adjust the frequency levels.

22 VIDEO INPUT jacks (see page 17)

S-VIDEO

Video input for connecting a portable DVD player, video camera (etc.), that has an S video out.

RCA VIDEO / AUDIO (L/R)

Video input for connecting a portable DVD player, video camera, etc., that has standard RCA video/audio outputs.

Remote Control

This page describes the buttons on the remote control used to operate the receiver.

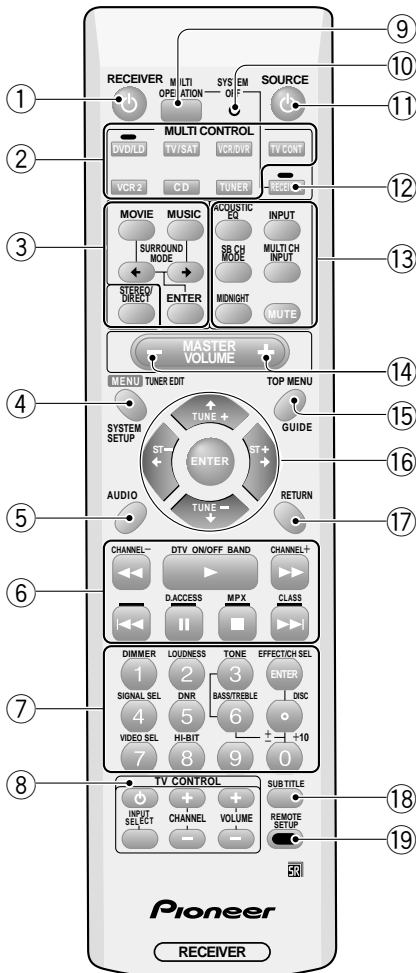

① **RECEIVER (STANDBY/ON) button**
Press to turn power of the receiver on or to standby (off).

② **MULTI CONTROL buttons**
These buttons are the basic controls that switch the mode of the receiver and the remote control, which allows you to control your other components.

TV CONT: Press so that the remote control can operate the TV control commands.

③ **Listening mode buttons (see page 43-45)**

SURROUND buttons (MOVIE, MUSIC, ← → & ENTER):

MOVIE: Press to put the receiver into MOVIE listening mode (see page 44).

MUSIC: Press to put the receiver into MUSIC listening mode (see page 45).

← →: Use to select the MOVIE or MUSIC listening mode.

ENTER: Use this button to enter information concerning the listening modes.

STEREO/DIRECT: Switches the receiver into STEREO mode if it was in a different listening mode or toggles between DIRECT and STEREO mode (see page 43).

④ **SYSTEM SET UP button**

Use for all system setups, including the speaker and sound systems. For more information see. "Setting up for Surround Sound" starting on page 34. When in TUNER control mode this functions as TUNER EDIT, and in DVD control mode, MENU functions.

⑤ **AUDIO button**

Use to switch the audio tracks of a DVD when in DVD mode.

⑥ **Command button for other components (see pages 61–62)**

Use these buttons to control other components you selected with the MULTI CONTROL buttons. You must input the preset code in order use this function (see page 59).

⑦ **Number buttons**

These can be used for many purposes depending on the mode of the remote control.

When the RECEIVER button is pressed, you enter the receiver mode and the buttons operate as below:

DIMMER (see page 53)

Use to adjust the brightness of the receiver's display.

LOUDNESS button (see page 48)

Switches the LOUDNESS mode on or off (for all modes except THX CINEMA and MULTI CH IN).

TONE buttons (see page 49)

This button switches between TONE ON and TONE BYPASS, which bypasses the tone circuitry.

SIGNAL SEL button (see page 42)

Press SIGNAL SEL repeatedly to select one of the following:

AUTO – If there are analog and digital signals input, the receiver automatically selects the digital signal.

DIGITAL – To select an optical or coaxial digital signal.

ANALOG – To select an analog signal.

DNR (DIGITAL NR) button (see page 47)

Switches the DIGITAL NR on or off (for all modes except THX CINEMA and MULTI CH IN).

BASS/TREBLE button (see page 49)

Use to select whether the bass or treble will be adjusted.

VIDEO SEL button (see page 53)

Use to toggle between the different video input possibilities.

HI-BIT button (see page 50)

Use this button to switch the HI-BIT HI-SAMPLING on or off. Use to hear CD and DVD, as well as other digital soundtracks at a wider dynamic range, allowing for finer audio reproduction.

(+/-) buttons

Use to adjust the TONE level, effect level and channel level as well as make Dolby Pro Logic II MUSIC parameter settings.

EFFECT/CH SEL button

Switches between the different channels so you can add volume individually to each channel with the + and - buttons. Also selects EFFECT mode of Pioneer original sound modes and Dolby Pro Logic II MUSIC parameter settings. You can then use the + and - buttons to make these adjustments.

⑧ TV CONTROL buttons

The following buttons are used to control the TV only and can be used once they are preset to control your TV.

⏻ : This is a dedicated TV button. Use it to turn on/off your TV.

INPUT SELECT: Press to select the input source for the TV.

CHANNEL +/- : Use these buttons to change the channel of the TV.

VOLUME +/- : Press to control the volume of the TV.

⑨ MULTI OPERATION button

Use this button to start the MULTI OPERATION mode. See pages 68–69 for how to program and use the MULTI OPERATION mode.

⑩ LED DISPLAY

This display flashes when a command is sent from the remote control to the receiver. It also flashes at other times, for example when teaching the receiver preset codes.

⑪ SOURCE ⏻ button

Use this button to turn on or off other components. You must input the preset code in order to use this function (see page 59).

⑫ RECEIVER button

Use this button to switch the remote control into receiver mode in order to get certain receiver functions or do receiver setups.

⑬ RECEIVER control buttons

ACOUSTIC EQ button (see page 47)

Use to switch on and off the Acoustic Calibration EQ.

SB CH MODE button (see pages 51)

Use this button to turn the surround back channels ON/OFF/AUTO or switch the VIRTUAL SURROUND BACK mode between ON/OFF/AUTO.

MIDNIGHT button (see page 48)

Switches the MIDNIGHT listening mode on or off (for all modes except THX CINEMA and MULTI CH IN).

INPUT button

Press to select an input source. The button will cycle through all the possible sources.

MULTI CH INPUT button (see page 50)

Use this button to select the component you have hooked up to the MULTI CH IN terminals (for example, a DVD-Audio player).

MUTE button

Press to mute or restore the volume.

⑭ MASTER VOLUME (-/+) buttons

Use to raise or lower the volume of the receiver.

⑮ TOP MENU/GUIDE button

Use to find stations or menus on a digital TV tuner. For a DVD player use this button to bring up the DVD menu.

⑯ ▲/▼/◀/▶/ENTER buttons

These buttons can be used for a variety of operations in the SYSTEM SETUP menu.

These buttons are used to control the menus for other components when in those modes (DVD, digital TV tuner, satellite tuner, cable tuner, etc.). In TUNER mode, they can select a station and/or a frequency.

⑰ RETURN button

When you are in a receiver setup operation this button will go back one step in the SYSTEM SETUP procedure. When you are using your DVD menu screen this button acts the same as the DVD player's "Return" button. When you are using cable tuners, satellite tuners or digital TV tuners this button will either exit you from the menu screen or act like a "Return" button above, depending on the maker of the unit.

⑱ SUBTITLE button

Use to switch the subtitles on a DVD player or disc.

⑲ REMOTE SETUP button.

Use to customize the remote control functions and the remote control itself. (See "Setting Up Remote Control to Control Other Components" starting on page 59)

Back Panel

All the terminals on the back panel are explained and/or referenced here.

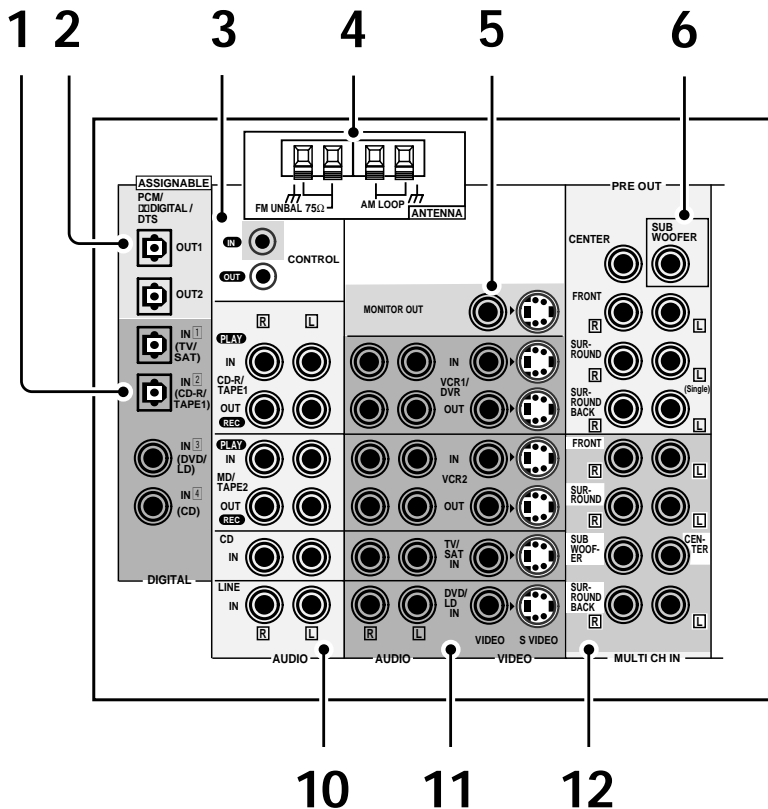

1 DIGITAL IN terminals (see page 21–22)

Use these terminals to input the signal from a DVD, CD player or any other kind of digital player. To be able to play Dolby Digital and other surround soundtracks you need to make digital connections. To do this use the digital terminals here. If you don't connect as per the default settings (see page 22) you need to complete "Assigning the Digital Inputs" (see page 76).

2 DIGITAL OUT terminals (see page 21)

Use these terminals to output a digital signal to a DVD-R, CD-R, MD recorder or any other kind of digital recorder.

3 CONTROL IN/OUT terminal (see page 71)

You can use this jack to hook up other PIONEER equipment, that has a CONTROL terminal, so that you can control them all by pointing the remote control(s) at one remote sensor.

4 Radio antenna terminals (see page 23)

Hook up antennas for the radio tuner built into the receiver here.

5 MONITOR OUT terminals (connect a TV or monitor here, see page 15)

Use these terminals to output a video signal to a TV or monitor.

6 PRE OUT analog terminals (connect an amplifier here, see page 67)

Use these terminals to output the audio signal from this amplifier to a different amplifier if that's how you choose to set up your system.

7 COMPONENT VIDEO MONITOR OUT terminals (connect a TV or monitor here, see page 15)

Use these terminals to output the video signal from the COMPONENT VIDEO IN terminals to your TV. See #13 for more information.

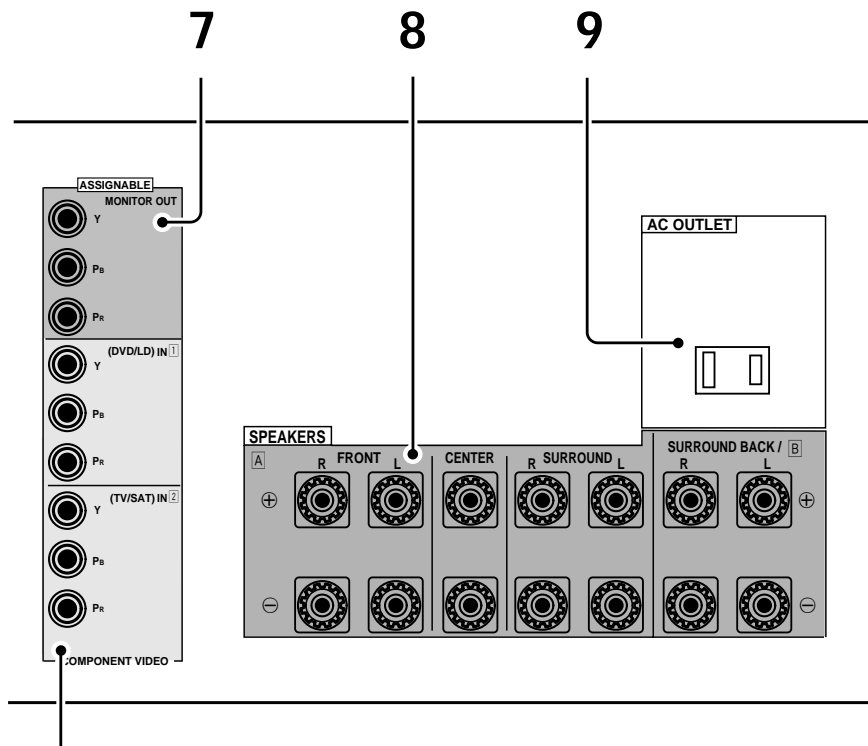

13

8 SPEAKERS terminals (see page 24)

Use these terminals to connect speakers to the receiver. The FRONT, CENTER and SURROUND terminals are for the main speaker system and the SURROUND BACK speakers can be set to either the main system, the SECOND ZONE or the FRONT BI-AMP setting. See page 65 to set the SURROUND BACK speakers.

9 AC OUTLET (switched 100 W max)

Hook up an external component to the power supply of this receiver. Only do this with audio or video components being used in this system and never hook up heavy equipment (like TVs, heaters, air conditioners, refrigerators, etc.) to this receiver.

10 Audio input/output terminals (connect analog components here, see page 19)

Use these terminals to input/output the audio signal from analog components (like a cassette deck or turntable). These are analog jacks.

11 Video components input/output terminals

Input/output signals from your video components (DVD, VCR, TV tuners, SAT tuners, etc.) here. (see page 16–18).

12 MULTI CH IN terminals (see page 20)

Use these terminals to input a multichannel surround signal (for example, a DVD-Audio signal) in an analog fashion. These are analog jacks.

13 COMPONENT VIDEO IN terminals (see page 15–18)

Use these terminals to hook up the video connections of your video components with this high quality method. Your components will have to have the terminals as well to take advantage of this kind of connection. If you don't connect as per the default settings (see page 15) you need to complete "Assigning the Component Video Inputs" (see page 77).

Setting Up for Surround Sound

To ensure the best possible surround sound, complete the following setup operations. Some of these are the same (and take precedence over) the settings you made in the Easy Setup Guide, so consider if the ones you made at that time were adequate. If you feel they were, move on to the next setting here. Use the arrow buttons (▲▼) and the ENTER button on the remote control to navigate the display on the receiver. Conversely, you can use the MULTI JOG dial and ENTER button on the front panel.

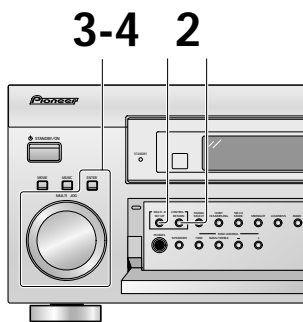
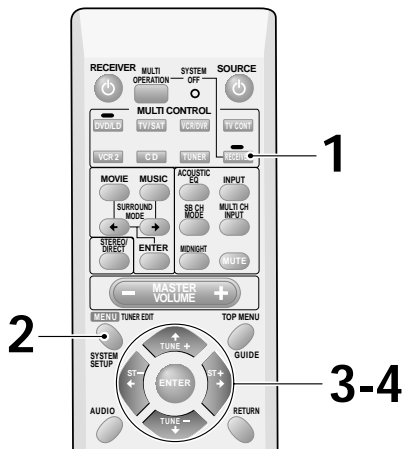

1 Turn on the receiver and press the **RECEIVER** button on the remote control.

2 Press the **SYSTEM SETUP** button.



This display appears on the receiver.

3 **SURROUND SETUP** should be selected. If it isn't use the ▲▼ buttons to select it. Press the **ENTER** button.



This display appears on the receiver.

4 Use the ▲▼ buttons to navigate through the menus. When you have the setting you want in a particular menu, press **ENTER**.

In each mode, the current settings are displayed. We suggest you do a basic system setup for surround sound when you first hook up the receiver. That gets it out of the way and you won't need to do it again unless you change your home set up (by adding new speakers, etc.). To do a basic setup use **SURRBACK** and **NORMAL** setups below.

To do a more advanced setup for surround sound see **EXPERT** setup starting on page 79.

SURRBACK (Surround Back) SYSTEM (See page 35)

Use to choose options for your surround back speakers.

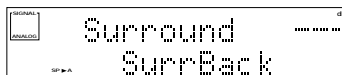

QUICK setup (see page 13)

Use to setup your surround sound system in the minimum amount of time.

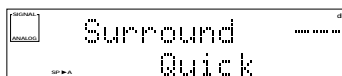

NORMAL setup (see pages 36–40)

Use this method to manually adjust all the surround sound functions.

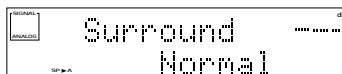

EXPERT setup (see page 79–87)

Use these settings to fine tune your surround sound and make it more personalized.

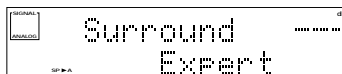

SURRBACK SYSTEM (Surround Back System)

This setup selects how your surround back system will be used. If you want to use it for surround back speakers in your main speaker system choose NORMAL SYSTEM. In this case you won't have any B (or secondary) speaker system as these speakers fill that role also for the VSX-43TX. If you want to use your surround back speakers in a different room choose SECOND ZONE. Alternatively, you can choose the FRONT BI-AMP setting, in order to deliver more power to the front speakers.

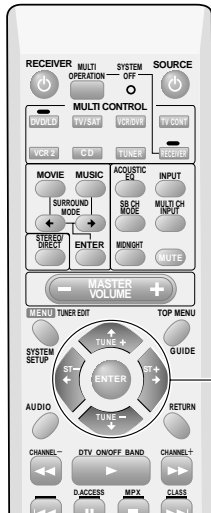

1-3

1-3

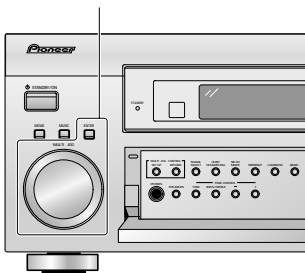

Follow steps 1-3 on page 34, if necessary, to get to the starting point mentioned here.

- 1 SURRBACK should be selected. If it isn't use the ▲▼ buttons to select it. Press the ENTER button.**

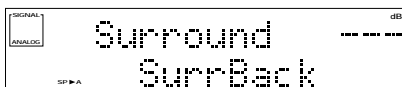

- 2 Use the ▲▼ buttons to select NORMAL SYSTEM, SECOND ZONE or FRONT BI-AMP setting. Press the ENTER button.**

NORMAL SYSTEM: if you want to use your surround back speakers as part the surround sound system in your main room.

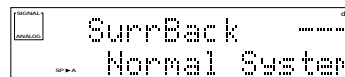

SECOND ZONE: Choose to use your surround back speakers for a B speaker system. That is, if you want to use your surround back speakers for a different room. You will hear the same source as is playing in the main room and multichannel soundtracks will be downmixed to stereo.

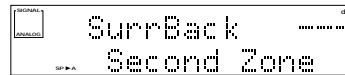

FRONT BI-AMP: Choose this setting if you want to deliver more power to your front speakers. This setting will use your surround back speaker terminals so you will only be able to get 5.1 channel playback. Also, you will have to bi-wire your speakers to do this (see page 65).

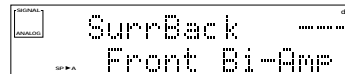

- 3 EXIT should be selected. Press the ENTER button.**



You will return to the SURROUND SETUP display. Next, proceed to either QUICK (on page 13) or NORMAL (on the next page).

If you want to change a setting before proceeding start over from step 1.

NORMAL setup

This is the manual method to setup your sound parameters for surround sound. It is more exact than the QUICK set up and should give you finer surround sound.

You only need to do these settings once (unless you change the placement of your current speaker system or add new speakers, etc.).

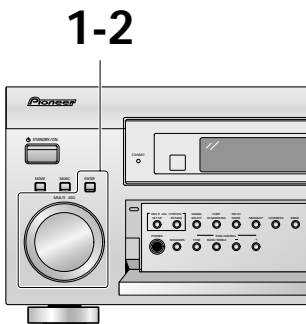
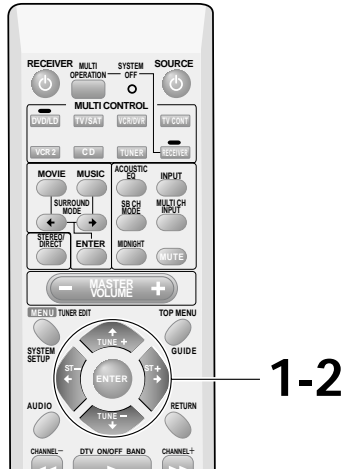

SPEAKER SET (See pages 37–38)

Use to specify the type and number of speakers you connected.

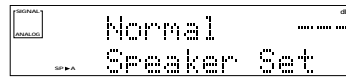

CHANNEL LEVEL (See page 39)

Use to balance the volumes of your different speakers. This is also necessary for the most realistic surround sound.

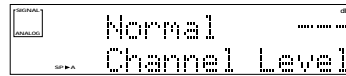

CHANNEL DELAY (See page 40)

Use to select the distance settings for each set of speakers. You must add distance settings to all your speakers for the most realistic surround sound. Adding a slight delay to some speakers enhances sound separation and is particularly important for achieving a surround sound effect. You need to figure out the distance from your listening position to your speakers to add the proper delay.

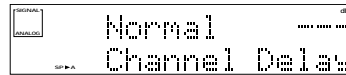

See the next four pages for more information on these settings.

Follow steps 1–3 on page 34, if necessary, to get to the starting point mentioned here.

- 1 Use the ▲▼ buttons to select **NORMAL**. Press the **ENTER** button.



- 2 Use the ▲▼ buttons to navigate through the **NORMAL** setup menus. When you have the setting you want in a particular menu, press **ENTER**.

In each mode the current settings are displayed. We suggest you adjust all these settings when you first hook up the receiver. That gets them out of the way and you won't need to return to this setting mode unless you change your home set up by adding new speakers (etc.).

SPEAKER SETTING

The information below shows you how to select the correct settings for the type and number of speakers you connected. Most importantly, you need to decide how to route the sound for all the speakers you connected. To do this select the size of the front, center, surround and surround back speakers (if you hooked them up). It is important to make these settings as accurately as possible or, in some cases, you may not get the full soundtrack from a disc.

Use the information below to complete the steps that follow and set up the receiver to match the speakers you have hooked up. If starting fresh, complete steps 1-2 in page 36.

FRONT (default setting is SMALL)

Select SMALL to send bass frequencies to the subwoofer. Select LARGE if your speakers will reproduce bass frequencies effectively or if you did not connect a subwoofer. (If you select SMALL for the front speakers the subwoofer will automatically be switched YES. Also, the center and surround speakers cannot be set to LARGE if the front speakers are set to SMALL. In this case, all bass frequencies are sent to the subwoofer.)

CENTER (default setting is SMALL)

- Select LARGE if your speaker will reproduce bass frequencies effectively.
- Select SMALL to send bass frequencies to the other speakers or subwoofer.
- If you did not connect a center speaker, choose NO. In this case, the center channel is output from the front speakers.

SURROUND (default setting is SMALL)

- Select LARGE if your speakers will reproduce bass frequencies effectively.
- Select SMALL to send bass frequencies to the other speakers or subwoofer.
- If you did not connect surround speakers choose NO. In this case, the sound of the surround channels is output from the front and center speakers.
- If the front speakers are set to SMALL, the surround speakers will automatically be set to SMALL.

SURROUND BACK (default setting is SMALL X2)

If you chose FRONT BI-AMP or SECOND ZONE in SURRBACK SYSTEM on page 35, or if you chose NO for SURROUND SPEAKERS, you won't be able to choose this setting.

- Select the number of surround back speakers you have. You can choose one speaker, two, or none.
- If you select one, make sure that speaker is hooked up to the **left** surround back terminal.
- Select LARGE if your speakers will reproduce bass frequencies effectively.
- Select SMALL to send bass frequencies to the other speakers or subwoofer.
- If you did not connect surround back speakers choose NO.
- If the front speakers or the surround speakers are set to SMALL, the surround back speakers will automatically be set to SMALL.
- If you choose THX in step 2 then the surround back speakers can only be set to SMALL (X1 or X2), or NO.

SUBWOOFER (default setting is YES)

- Leave it selected if you connected a subwoofer.
- If you selected SMALL for the front speakers the subwoofer will automatically be set to on (you won't be able to choose NO or PLUS).
- If you did not connect a subwoofer choose NO. In this case, the bass frequencies are output from the front or surround speakers.
- Choose the PLUS setting if you want stronger reproduction of deep bass sounds.
- If you select PLUS the bass frequencies that would normally come out the front and center speakers are all routed to the subwoofer.

Setting Up for Surround Sound

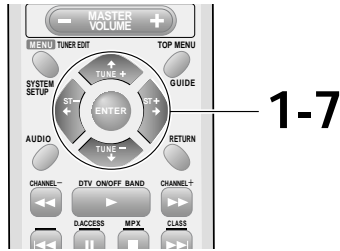

1-7

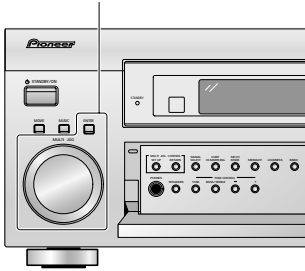

Follow steps 1-3 on page 34, if necessary, to get to the starting point mentioned here.

- 1 Use the ▲▼ buttons to select **NORMAL**. Press the ENTER button.



- 2 **SPEAKER SET** should be selected. If it isn't use the ▲▼ buttons to select it. Press the ENTER button.

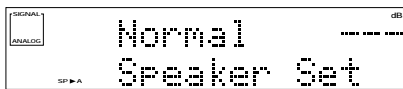

- 3 Use the ▲▼ buttons to select **FREE** or **THX** speaker system setting. Press the ENTER button.

FREE: To set all the speakers.

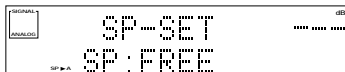

THX: All speakers are set to SMALL and the SUBWF to YES. You can select the number of surround back speakers.

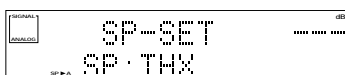

For FREE, select FREE and press ENTER. Then go to step 4.

For THX, select THX and press ENTER. Then go to step 5 but you only need to set the number of surround back speakers.

- 4 With the ▲▼ buttons choose the speakers that you want to set. Press the ENTER button.



You can select from FRONT, CENTER, SURROUND or SURROUND BACK. The selected setting blinks.

- 5 Use the ▲▼ buttons to choose the number (YES or NO, X1 or X2) and the size (LARGE or SMALL) for each set of speakers. Press the ENTER button.



PLUS is also a possibility for the SUBWF. If you selected THX in step 2, you only need to set the number of surround back speakers.

- 6 Repeat steps 3 & 4 for all speakers channels.

- 7 Use the ▲▼ buttons to select **EXIT** and press ENTER.



Next, proceed to CHANNEL LEVEL below. **If you want to change a setting before proceeding** start over from step 2.



If you have a subwoofer and like lots of bass, it may seem logical to select LARGE for your front speakers and leave the subwoofer selected. This may not, however, yield the best bass results. Depending on the size and shape of your room you may actually experience a decrease in the amount of bass due to what is called low frequency cancellations. If you have a subwoofer, listen to the bass response with the front speakers set to LARGE and SMALL alternately and let your ears judge which sounds best. If you have a subwoofer, the safest option is to route all the bass sounds to it by selecting SMALL for the front speakers.

CHANNEL LEVEL (channel balance)

The following steps show you how to balance the sound output level of your speakers. Proper speaker balance is essential for obtaining high quality surround sound. If continuing from SPEAKER SETTING go to step 2.

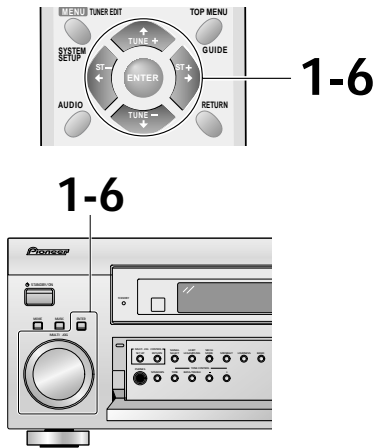

Follow steps 1-3 on page 34, if necessary, to get to the starting point mentioned here.

1 Use the ▲▼ buttons to select **NORMAL**. Press the ENTER button.

2 CHANNEL LEVEL should be selected. If it isn't use the ▲▼ buttons to select and press ENTER.

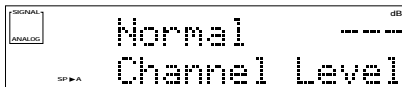

3 There are two ways to set the CHANNEL LEVEL: **MANUAL** or **AUTO**. Select a setting mode with the ▲▼ buttons and press ENTER.

Test tones will be output.

WARNING : Be prepared! The test tones are output at a high volume level.

MASTER VOLUME rotates to the reference position (0 dB) and the display on the receiver flashes TEST TONE. After a few seconds the test tone is output.

MANUAL: move the test tone manually and adjust the channel level.

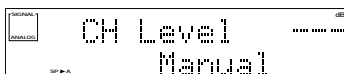

AUTO: the test tone moves by itself and you adjust the levels.

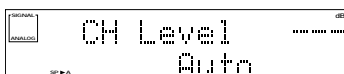

4 Adjust the speaker level with the below instructions for the method you chose.

Adjust the channel level from -10 dB to +10 dB in 0.5 dB increments.

The default setting is 0 dB.

In MANUAL (manual test tone) mode

To switch the test tone between each speaker use the ▲▼ buttons and push ENTER. Adjust the level of each speaker using the ▲▼ buttons and ENTER. When done go to step 5.

In AUTO (automatic test tone) mode

This mode switches the test tone between each speaker automatically. The test tone output cycles through the speakers in the following order:

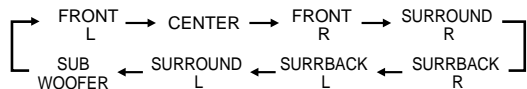

Adjust the level of each speaker using the ▲▼ buttons as the test tone is emitted and wait for it to move to the next speaker. When done go to step 6.

If you want to change a setting before proceeding you need to complete the procedure and start over from step 1.

5 When you have the levels you want press ENTER. EXIT should be selected (if it isn't select it with the ▲▼ buttons).

6 Press ENTER.

Next, proceed to CHANNEL DELAY next page.

If you want to change a setting before proceeding start over from step 2.



- If your subwoofer has a volume control, set it to the middle position before doing these operations.
- If you are using a Sound Pressure Level (SPL) meter take the readings from your main listening position and adjust the level of each speaker to 75dB SPL (C-weighting/slow reading).
- The volume of the subwoofer test tone tends to sound lower than it actually is. You may need to adjust the level after testing your system with an actual soundtrack.

Setting Up for Surround Sound

CHANNEL DELAY

Adding a slight delay to some speakers is necessary to achieve proper sound depth, separation as well as an effective surround sound effect. You need to figure out the distance from your listening position to your speakers to add the proper delay. The following steps show you how to set the delay time for each channel by specifying the distances from your listening position to each speaker. If continuing from CHANNEL LEVEL go to step 2.

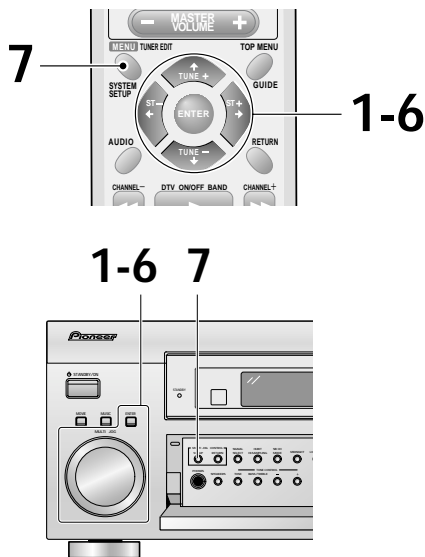

Follow steps 1-3 on page 34, if necessary, to get to the starting point mentioned here.

- 1 Use the ▲▼ buttons to select **NORMAL**. Press the **ENTER** button.



- 2 The **CHANNEL DELAY** should be selected. If it isn't use the ▲▼ buttons to select it. Press the **ENTER** button.



- 3 Select each speaker channel with the ▲▼ buttons and press **ENTER**.



You can select from L, C, R, RS, SBR, SBL, LS and SW. The selected setting blinks.

- 4 Use the ▲▼ buttons to add or subtract the distance in feet that the speaker is from your normal listening position. Press the **ENTER** button.

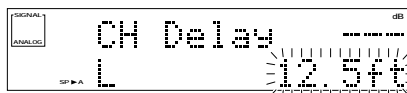

Adjust the speaker distance in half foot increments from 0.5 to 45 feet. The default setting is 10 feet.

- 5 Repeat steps 3 & 4 for all speaker channels.

- 6 Use the ▲▼ buttons to select **EXIT** and press **ENTER**.

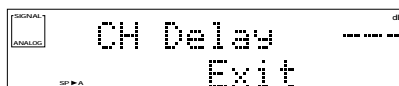

If you want to change a setting before proceeding start over from step 2.

- 7 Press the **SYSTEM SETUP** button to leave the **SYSTEM SETUP** mode.



Basic Operation

Stereo and Multichannel Playback

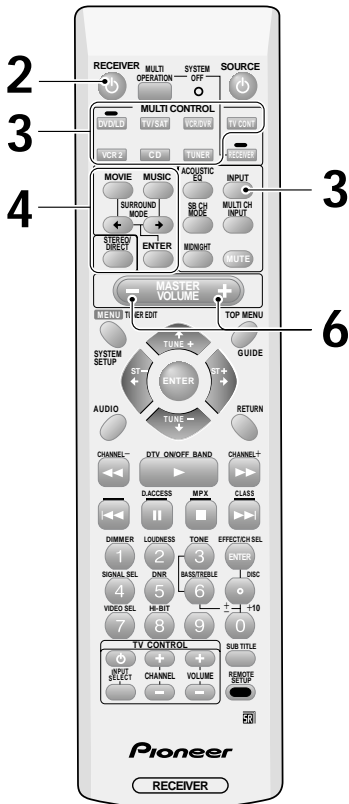
The following instructions show you how to play Dolby Digital or DTS sound sources with the VSX-43TX. Before doing so be sure to complete the setup procedures described in QUICK setup in the Easy Setup Guide Pt. 2 (starting on page 13) or Setting Up for Surround Sound (starting on page 34). This is particularly important to achieve a surround sound effect with Dolby Digital or DTS sources.



1 Turn on the power of the playback component.

2 Press the  RECEIVER button ( STANDBY/ON on the front panel) to turn on the receiver.

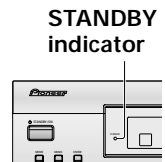

Be sure that the STANDBY indicator turns off on the front panel.



3 Press the MULTI CONTROL (or INPUT) on the remote control to select the source you want to playback.

Choose the type of signal input with the SIGNAL SELECT button. See the next page for more details, if necessary.



4 Choose a LISTENING MODE one of two ways.

For SURROUND modes: press MOVIE or MUSIC, use the   buttons to select the mode you want and press ENTER.
For STEREO/DIRECT: for press the button for that mode.

On the front panel, use the MOVIE or MUSIC buttons and the MULTI JOG dial. Press the button of the mode type you want and then use the dial to cycle through the possibilities. Press ENTER.

See "SURROUND Modes," on pages 44–45 for details on which modes are available and in which situations they are designed to be used.

5 Start playback of the component you selected in step 3.

6 Adjust the volume by using the MASTER VOLUME  /  buttons on the remote control. On the front panel use the MASTER VOLUME dial.

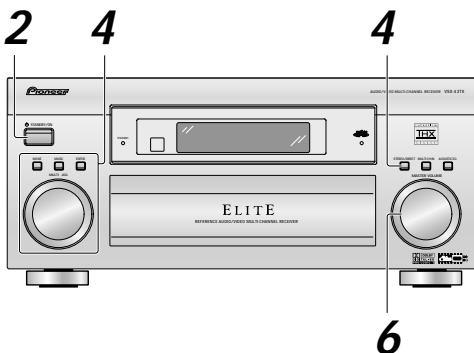

Switching ANALOG/DIGITAL Signal Input

This button selects the type of input signal, ANALOG or DIGITAL, sent to the receiver. You need to take special care to switch to the appropriate input when necessary. For example, the switch would have to be on DIGITAL to hear Dolby Digital or DTS surround sound material but it would have to be on analog to record from the ANALOG out jacks on the receiver. The default setting is AUTO (which chooses digital over analog when both are available but goes with whatever is available) for: DVD/LD, TV/SAT, VIDEO, CD, CDR/TAPE1. The default setting is ANALOG for: VCR1/DVR, VCR2, MD/TAPE2, TUNER and LINE.

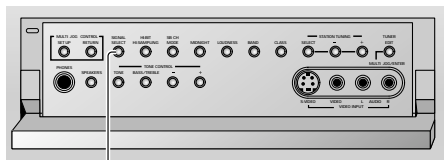
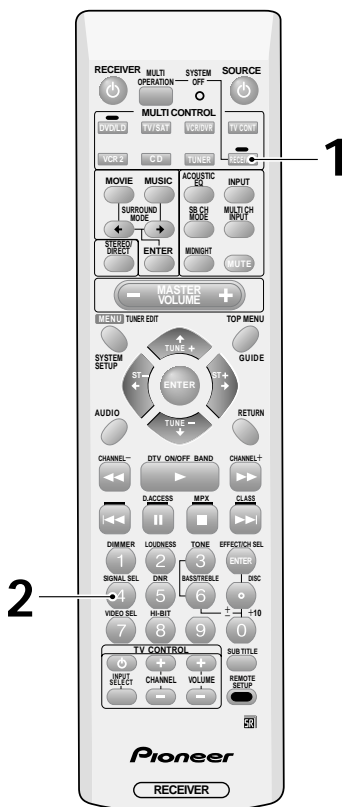

1 Press RECEIVER.

2 Press the SIGNAL SEL (SIGNAL SELECT on the front panel) button to select the input signal corresponding to the format of the source component.

Each press switches the signal in the order below:

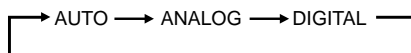

- When DIGITAL signal is selected, **DD** DIGITAL lights when a Dolby Digital signal is input; DTS lights when a DTS signal is input.
- If no digital inputs are assigned (see page 76) you can only choose ANALOG in the SIGNAL SELECT.
- Because the audio signal from a karaoke microphone and LDs are recorded with analog audio only, they are not output from the digital outputs. Set SIGNAL SELECT to ANALOG to listen to these formats.
- When an LD with DTS is played back with the SIGNAL SELECT set in ANALOG, digital noise caused by playing back the DTS signal directly (with no decoding) is output. To prevent noise, you need to make digital connections (See pages 21 & 22) and set SIGNAL SELECT to AUTO or DIGITAL.
- Some DVD players don't output DTS signals. For more details, refer to the instruction manual supplied with your DVD player.
- This receiver can only play back Dolby Digital, PCM (32 kHz, 44.1 kHz, 48 kHz, 88.2 kHz and 96 kHz sampling frequency), and DTS digital signal formats. If your source is not one of these select ANALOG for playback.

Listening Modes

The three listening mode types on the receiver are explained here (to select listening modes see page 41). The kind of playback you can get in the three modes depends on what kind of a source (DVD, etc.) you are using. The basic distinction is between 2 channel sources and multichannel sources. The MOVIE and MUSIC modes that are available to you will also differ according to your source and which SB CH MODE you choose. This is explained below as well.

For home theater the MOVIE and MUSIC listening modes are designed to deliver realistic and powerful multichannel surround sound that recreates the movie theater or concert experience. The first four MOVIE modes (THX CINEMA, DOLBY PRO LOGIC II MOVIE, DOLBY PRO LOGIC, NEO:6 CINEMA) and first two MUSIC modes (DOLBY PRO LOGIC II MUSIC, NEO:6 MUSIC) incorporate pure decoding of the signal. That is they present it just as it was recorded in the sound studio. With these modes the receiver will automatically employ the format of the sound source (for example, Dolby Digital or DTS) and display it on screen. The other modes are DSP modes. They add some type of effect to the signal.

You may need to experiment with these modes to see which suit your home system and personal tastes.

The MUSIC and STEREO modes are designed to be used with music sources but some MUSIC modes are also suitable for film soundtracks. Again, try different modes with various soundtracks to see which you like but you must choose one of the MOVIE and MUSIC listening modes in order to get surround sound.

Depending on your setup, in STEREO mode only the front two speakers, and sometimes the subwoofer (if you have one), are used.

STEREO modes

When a source is played in this mode, it plays through just the front left and right speakers (and possibly your subwoofer depending on your speaker settings). Dolby Digital and DTS multichannel sources are downmixed to stereo.

STEREO

In STEREO mode the audio plays according to the surround setup settings and you can still use ACOUSTIC CALIBRATION EQ, DIGITAL NR, MIDNIGHT, LOUDNESS, HI-BIT HI-SAMPLING mode and TONE CONTROL functions.

DIRECT

In DIRECT mode, the audio bypasses all types of signal processing to remain as close to the source audio quality as possible.



If you switch on ACOUSTIC CALIBRATION EQ, DIGITAL NR, MIDNIGHT, LOUDNESS, HI-BIT HI-SAMPLING mode and TONE CONTROL functions when DIRECT is selected, the receiver automatically switches to STEREO.

MOVIE modes (SURROUND mode)

The MOVIE mode is a newly designed system for enhancing movie soundtracks and other audio-visual sources that optimizes its effects in accordance with your source, SB CH MODE and speaker configuration. The first four modes (THX CINEMA, **DOLBY** PRO LOGIC II MOVIE, **DOLBY** PRO LOGIC, NEO:6 CINEMA) are for pure decoding of multichannel sound sources (for example, Dolby Digital or DTS). With these modes the receiver will automatically employ the format of the sound source (for example, Dolby Digital or DTS) and display it on screen. With two channel sources these first four modes will create surround channels. Next, there are six PIONEER original sound modes that use DSP (Digital Signal Processing) to create different types of sound environments as described below.

THX CINEMA

THX is a set of technical standards created by Lucasfilm Ltd. These standards were designed to emulate a film sound stage and thus reproduce, with the greatest possible accuracy, the soundtrack intended by the filmmakers.

DOLBY II MOVIE (**DOLBY** PRO LOGIC II MOVIE)*

This mode gives 5.1 channel surround sound. It is suitable for movies, especially those recorded in Dolby Surround. The channel separation and movement of surround effects is comparable to Dolby Digital 5.1. With sources other than stereo (5.1, etc.) the display will automatically show the type of decoding being employed (Dolby Digital, DTS-ES, etc.).

DOLBY PRO LOGIC*

This mode gives 4.1 channel surround sound. It is less sensitive to the quality of the source material, so may be useful when **DOLBY** PRO LOGIC II MOVIE or **DOLBY** PRO LOGIC II MUSIC modes do not give good results. With sources other than stereo (5.1, etc.) the display will automatically show the type of decoding being employed (Dolby Digital, DTS-ES, etc.).

NEO:6 CINEMA*

This mode gives 6.1 channel surround sound and is suitable for movies. The NEO:6 Cinema mode delivers good channel separation for movie soundtracks. With sources other than stereo (5.1, etc.) the display will automatically show the type of decoding being employed (Dolby Digital, DTS-ES, etc.).

ACTION

This mode is designed for action movies, which generally use lots of sound effects. The mode enriches the sound to make it more realistic and extends the parameters to pick up high and low sound effects.

SCI-FI

This mode is designed for science fiction movies. It creates a broad sound space, separating dialog from sound effects to heighten the overall impact of the soundtrack.

DRAMA

This mode is designed for movies with a lot of dialog. The elements of dialog are enhanced, making the characters seem more real. The mode also compresses the dynamic range somewhat so loud sounds do not overpower softer ones (compare this with the MIDNIGHT listening mode explained on page 48).

MUSICAL

This mode is primarily for music and adds a spacious feeling to the sound. A long delay time of reflected sounds provides resonant tones which emulate a concert hall.

MONOFILM

This mode is designed for older movies which are recorded with mono soundtracks. The special sound processing of this mode will allow you to experience these movies in surround sound even though they were not recorded that way originally.

5/7-D THEATER

This mode is especially designed to give sound depth to stereo sources. The overall effect builds a dynamic and broad sound space, allowing two-channel (stereo) signals to faithfully imitate a five speaker sound. The mode should be used in conjunction with Dolby Pro Logic for sources bearing the **DOLBY SURROUND** mark. The display will show either 5-D THEATER or 7-D THEATER according to the source, SB CH MODE and speaker configuration.

* When you input a multichannel signal the decoding is done automatically so you cannot choose these modes.

MUSIC modes (SURROUND mode)

The MUSIC modes allow you to transform your living room into a variety of different sonic environments when playing either two-channel or multichannel sources. It optimizes its effects in accordance with your source, SB CH MODE and speaker configuration. The first two modes are for pure decoding of multichannel sound sources. With these modes the receiver will automatically employ the format of the sound source (for example, Dolby Digital or DTS). With two channel sources these first four modes will create surround channels. Then there are five PIONEER original sound modes that use DSP (Digital Signal Processing) to create different types of sound environments as described below. Lastly, the 5/7-CH STEREO mode simply outputs a stereo signal through all of your speakers.

PRO LOGIC II MUSIC (PRO LOGIC II MUSIC)*

This mode gives 5.1 channel surround sound and is suitable for music. Compared to the Movie Mode PRO LOGIC, the surround effect is more enveloping. With sources other than stereo (5.1, etc.) the display will automatically show the type of decoding being employed (Dolby Digital, DTS-ES, etc.).

NEO:6 MUSIC*

This mode gives 6.1 channel surround sound and is suitable for music. The NEO:6 Music mode plays the stereo source as is through the front left/right speakers, and generates a natural, ambient surround and center sound. With sources other than stereo (5.1, etc.) the display will automatically show the type of decoding being employed (Dolby Digital, DTS-ES, etc.).

CLASSICAL

Simulates the acoustic effects of a large concert hall. Suitable for classical music. A long delay time of reflected sounds, coupled with reverb effects, let the listener experience the dynamic and rich sounds characteristic of concert halls and powerful orchestral performances.

CHAMBER

Simulates the acoustic environment of a very resonant concert hall. Rich reverberation and a full sound create the impression of a lively performance space.

JAZZ

Simulates the acoustic effects of a jazz club. Reflected sound is virtually below 100 msec so that the listener can experience a live band effect.

ROCK

Simulates the acoustic effects of a mid-sized concert hall. The listener can experience a live band effect with good separation of the instruments, a strong bass and the vivid feeling of a live performance.

DANCE

Simulates the acoustic effects of a dance club. Features a strong bass sound. Reflected sound delay time is virtually below 50 msec, for the listener to experience the visceral power of dance music.

5/7-CH STEREO

Simulates the acoustic environment of a regular stereo while using all the speakers in the system to induce a rich, all-around sound. The display will change to 5-CH STEREO or 7-CH STEREO according to the SB CH MODE and speaker configuration.

* When you input a multichannel signal the decoding is done automatically so you cannot choose these modes.

Basic Operation

Adjusting the Effect of a Listening Mode

The DSP (Digital Signal Processing) listening modes have sound processing added to accentuate a certain kind of atmosphere or effect (see the preceding pages for explanation). You can choose if you want to strengthen or weaken this effect in the given mode. The DSP MOVIE modes are: ACTION, SCI-FI, DRAMA, MUSICAL, MONOFILM, 5/7-D THEATER. The DSP MUSIC modes are: CLASSICAL, CHAMBER, JAZZ, ROCK, DANCE. The following instructions show you how to adjust the amount of effect.



1 Press RECEIVER.

2 Press the EFFECT/CH SEL button repeatedly until you see EFFECT in the receiver's display.

3 Use the +/- buttons to add or subtract the amount of effect.



- The amount of effect can be adjusted ranging from 10 to 90 (the default setting value is 50) by pressing +/-.
- 5/7CH STEREO modes cannot be adjusted.

Adding/Adjusting the Effect in Dolby Pro Logic II Music Mode

The Dolby Pro Logic II Music mode has three settings you can choose from which adjust the spatial feeling of the surround sound. These settings are best matched to each individual source instead of one setting being left on for all sources. The three settings and how to apply them are explained here.

1 Press RECEIVER.

2 Press the EFFECT/CH SEL button repeatedly and select the setting you want. They appear in the receiver's display.

CENTER WIDTH : With Pro Logic decoding center channel signals can come only from the center speaker. If no center speaker is present this channel is split between the two front speakers, creating a "phantom" channel. The CENTER WIDTH feature lets you adjust the center channel so it can be heard only from the center speaker, only as a "phantom" channel or in varying degrees of both.

DIMENSION: This allows you to adjust the soundfield towards the front or towards the rear of your room.

PANORAMA: This gives the music a wraparound surround feel.

3 Use the +/- buttons to add or subtract the amount of effect or turn on/off.

CENTER WIDTH : Strengthen or weaken the effect between 0-7. The default is 3.

DIMENSION: Move soundfield backward or forward with -3 being the furthest back and +3 being the furthest forward. The default is 0.

PANORAMA: Turn on or off. The default is off.

Listening with ACOUSTIC CALIBRATION EQ

You can listen to the soundtrack with the ACOUSTIC CALIBRATION EQ if you have adjusted ACOUSTIC CAL EQ in the EXPERT Setup menu (see page 79). To do so follow the instructions below. For information about ACOUSTIC CALIBRATION EQ mode, see page 84.

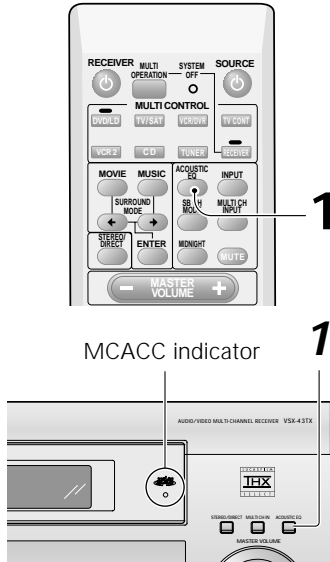

1 Press the ACOUSTIC EQ button on the remote control or ACOUSTIC EQ button on the front panel.

Each press switches ACOUSTIC CALIBRATION EQ mode on or off.

When ACOUSTIC EQ is being applied the MCACC indicator lights.



- You can't turn on ACOUSTIC CALIBRATION EQ mode on in MULTI CH IN mode.
- If you turn ACOUSTIC CALIBRATION EQ mode on in DIRECT mode, the receiver automatically switches to STEREO mode.

Reducing Noise During Playback (DIGITAL NR Function)

To reduce extraneous noise switch on DIGITAL NR. This feature is effective with sources containing a lot of background noise like cassette and video tape

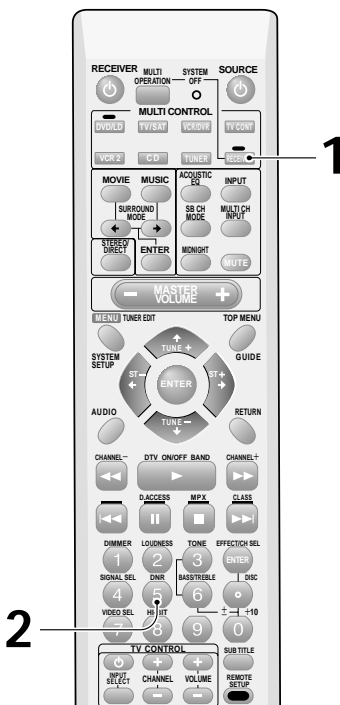

1 Press RECEIVER.

2 Press the DNR button on the remote control.

Each press switches DIGITAL NR on or off. When on, DNR lights in the display.



- In cases described below, noise may not be reduced even if DIGITAL NR is on.
 - Sudden noise
 - Extremely loud noise
 - Signals that contain too many high frequencies
- DIGITAL NR is effective at levels shown below for each source.

| | |
|-----------------------|----------|
| STEREO | |
| • Analog input | 10-18 dB |
| • Digital input | 10-15 dB |
| • AM/FM tuner | 10-15 dB |
| MOVIE/MUSIC | 6-10 dB |
- Depending on the condition of the source, there may not be a noticeable improvement in the quality of the sound.
- You can't use the DIGITAL NR mode with the THX CINEMA or MULTI CH IN modes, or a 96 kHz signal.
- If you set the DIGITAL NR on in DIRECT mode the receiver will switch to STEREO mode.

Listening in MIDNIGHT Mode

This useful feature makes it possible to get excellent surround sound effects even when listening at low volumes. It can be used with any surround sound source and play soundtracks so that the quieter sounds are audible even while playing a soundtrack at low volumes. This feature is applicable only when the master volume is under -20 dB.

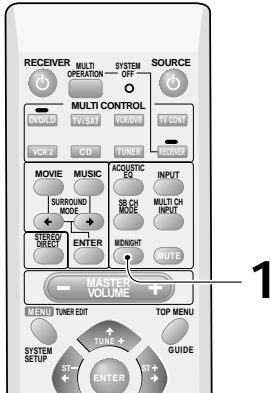

1 Press the MIDNIGHT button on the remote control.

Each press switches MIDNIGHT mode on or off. When on, MIDNIGHT lights in the display.



- The surround effect adjusts itself automatically in accordance with the volume level.
- You can't use the MIDNIGHT mode with the THX CINEMA, MULTI CH IN, LOUDNESS modes.
- If you set MIDNIGHT on when in DIRECT mode the receiver switches to STEREO mode.

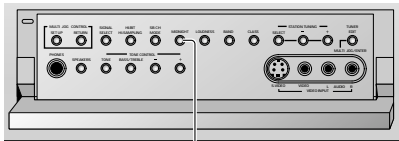

1

Listening in LOUDNESS Mode

The LOUDNESS mode boosts the bass and treble in a signal. It is useful for listening to music at low volumes. This feature is applicable only when the master volume is under -20 dB.

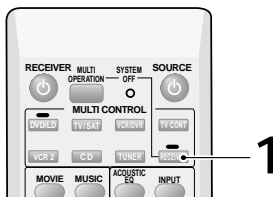

1 Press RECEIVER.

2 Press the LOUDNESS button on the remote control.

Each press switches LOUDNESS mode on or off. When on, LOUDNESS lights in the display.



- You can't use the LOUDNESS mode with the THX CINEMA, MULTI CH IN, MIDNIGHT modes.
- If you set LOUDNESS on in DIRECT mode the receiver will switch to STEREO mode.

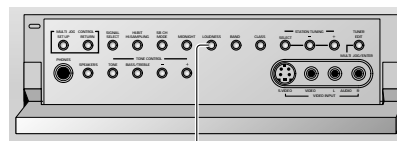
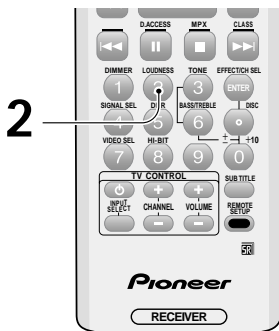

2

Adjusting Bass and Treble (TONE CONTROL)

You can adjust the low (bass) and high (treble) frequencies. The TONE button can also be used to bypass the tone circuitry.

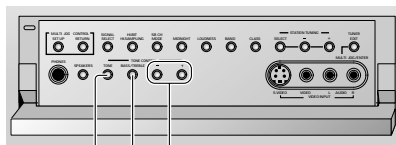
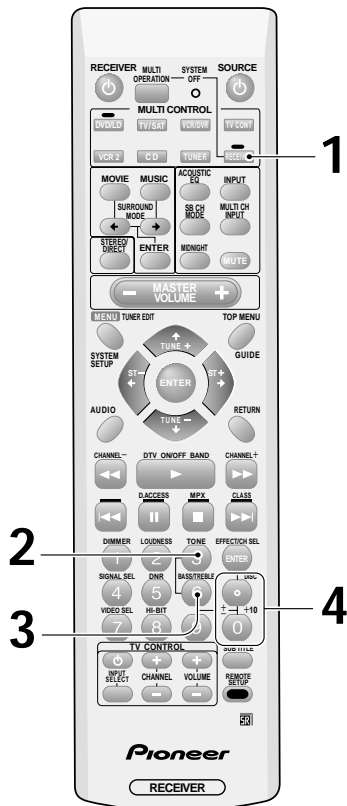

2 3 4

1 Press RECEIVER.

2 Press the TONE button on the remote control or the front panel to put the receiver in tone adjust mode.

There are two tone modes TONE: ON and TONE: BYPASS. The first means the tone functions are active and also lets you adjust these functions. The second means the tone controls are being bypassed, and thus have no effect on the sound.

3 Press the BASS/TREBLE button repeatedly to select BASS or TREBLE.

If TONE: BYPASS appears, press the TONE button to get TONE: ON.

4 Use the +/- buttons to adjust the low or high frequency levels.

A few seconds after you finish adjusting the tone the receiver will revert to the sound mode it was in at the beginning of the process.



- The TONE CONTROL can be adjusted in a range of ± 6 dB.
- The TONE CONTROL cannot be set on in THX CINEMA, MULTI CH IN modes.
- If you set TONE CONTROL on in DIRECT mode the receiver will switch to STEREO mode.

Listening in HI-BIT/SAMPLING Mode

Use to hear CD and DVD, as well as other digital soundtracks, at a wider dynamic range, allowing for finer audio reproduction.

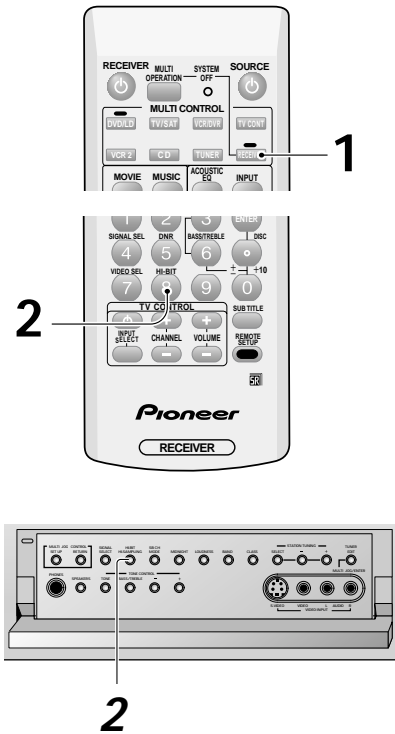

1 Press **RECEIVER**.

2 Press the **HI-BIT** button on the remote control or **HI-BIT HI-SAMPLING** button on the front panel.

Each press switches HI-BIT/SAMPLING mode on or off. HI-BIT/SAMPLING lights in the display.



- HI-BIT mode cannot be set on MULTI CH IN mode.
- If the receiver is in DIRECT mode and you press the HI-BIT button the receiver will switch to STEREO mode.
- This feature can't be used with 96 kHz and 88.2 kHz sources.

DVD-Audio/MULTI CHANNEL IN Playback

MULTI CH IN allows you to connect a DVD-Audio player or an external decoder to enjoy certain multichannel discs. To use MULTI CH IN playback follow the instructions below.

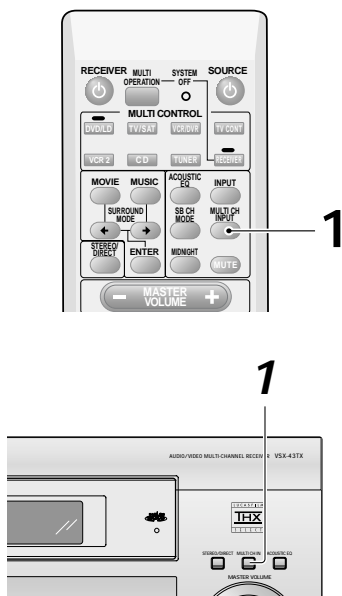

1 Press the **MULTI CH INPUT** button on the remote control or the **MULTI CH IN** button on the front panel.

Each press switches the input between the previous mode and MULTI CH IN.

ON: This is a true playback of the signal from the MULTI CH INPUT terminals, output without digital processing. You can only control each channel level.

OFF: Cancels the MULTI CH IN modes.



- You can't use any kind of sound processing together with MULTI CH IN. Selecting a listening mode, or switching these modes, cancels the MULTI CH IN.
- If any other speakers are set to NO the signal for that (those) channel(s) won't get output at all.
- You cannot set sound features (pages 47–49) on, in MULTI CH IN mode.
- If you're listening to DVD-Audio but can only get stereo sound set your DVD player's 5.1 channel analog playback to on.

SB CH MODE button

SB CH MODE

The SB CH MODE makes available surround back channels through your surround back speakers. You must have chosen NORMAL SYSTEM in the SURRBACK SYSTEM setting (see page 35) and have SURROUND and SURROUND BACK speakers set to something other than NO (see pages 37–38) to use this feature.

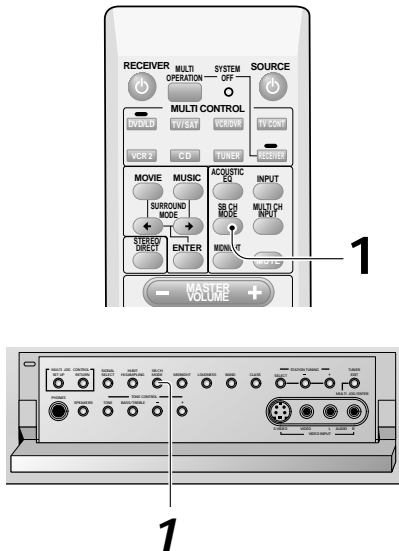

1 Press the SB CH MODE button on the remote control.

Each press switches between ON, OFF and AUTO.

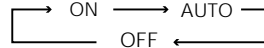

For each choice you can create SURROUND BACK channels under the conditions listed below.

ON: surround back channels are available with all SURROUND modes.

AUTO: same as above except whether SURROUND BACK channels are available with any of the PRO LOGIC II (or PRO LOGIC) modes depends on whether the source has an EX or ES flag or not.

With the NEO:6 modes surround back channels will always be available.

OFF: SURROUND BACK channels will not be heard.



- You can't use the SB CH MODE with MULTI CH IN or STEREO/DIRECT modes.

VIRTUAL SURROUND BACK Mode

The VIRTUAL SURROUND BACK mode emulates surround back channels through your surround speakers. You must have chosen NORMAL SYSTEM in the SURRBACK SYSTEM setting (see page 35); have SURROUND speakers set to something other than NO, and have chosen NO for the SURROUND BACK speakers in SPEAKER SETTING (see page 37-38) to use this mode.

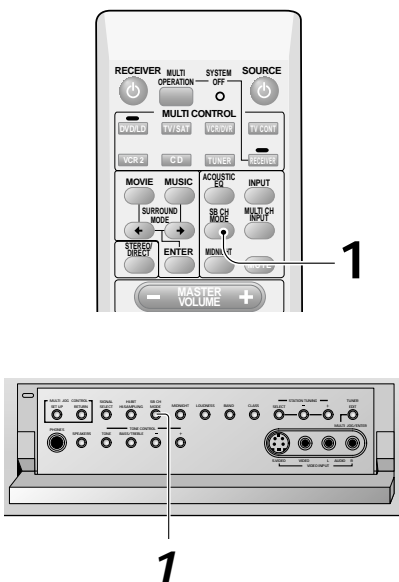

1 Press the SB CH MODE button on the remote control.

Each press switches between VIRT SB ON, VIRT SB OFF and VIRT SB AUTO.

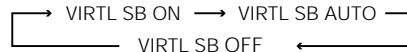

For each choice you can create VIRTUAL SURROUND BACK channels under the conditions listed below.

VIRT SB ON: virtual surround back sound is available with all SURROUND modes except THX CINEMA; for a stereo signal you must choose the NEO:6 MOVIE/MUSIC SURROUND mode or a Pioneer original sound mode (see pages 44–45).

VIRT SB AUTO: same as above except whether virtual surround back sound is available with any of the PRO LOGIC II (or PRO LOGIC) modes depends on whether the source has an EX or ES flag or not.

With the NEO:6 modes virtual surround back sound will always be available.

VIRT SB OFF: virtual surround back sound will not be heard.



- You can't use the VIRTUAL SURROUND BACK mode with the THX CINEMA, MULTI CH IN, STEREO/DIRECT modes.

DUAL MONO setting and playback

The dual mono setting can only be used when listening to Dolby Digital or homemade discs that have dual mono software encoded in them. Dual mono software usually is used to put two different mono soundtracks, that you can listen to together or separately, on one DVD. With this setting you can choose which dual mono setting you want to listen to. Remember this setting is only applicable if you are using Dolby Digital software with dual mono and want to isolate one of the channels therein.

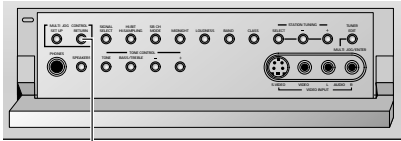

1

1 Press the RETURN button for more than three seconds to put the receiver in DUAL MONO mode.

Hold down the RETURN button to cycle through the different DUAL MONO settings. When you find the one you want release the button. The L (ch1) and R (ch2) indicators in the display light to indicate the playback channel.

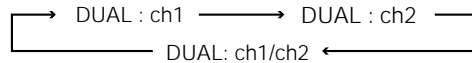

The different settings are: DUAL ch1, where you only hear channel 1; DUAL ch2, where you only hear channel 2; and DUAL ch1/ch2, where you hear both channels, but independently from different speakers.



- The default setting is DUAL ch1.
- You can only use this function with Dolby Digital sources that have this function

Using Headphones

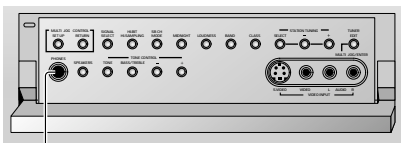

1 PHONES jack

1 Plug headphones into the PHONES jack on the front of the receiver.

No sound will be audible from the speakers when headphones are plugged in.



- All SURROUND modes will be downmixed to 2 channels.
- If you're listening to a 2 channel source there will be no matrix decoding (i.e. you will not be able to get surround sound decoding).
- For MULTI CH IN mode, only the signal input from the MULTI CH IN FRONT L and R channels can be heard.

Video Select

This function allows you to listen to one sound source while you watch a different video source on your TV. The sound source is set in the normal fashion as explained on page 41. You then change the video input with the VIDEO SEL button.



1 Press RECEIVER.

2 Press the VIDEO SEL button on the remote control to cycle through the different possible video inputs.

The first press shows the video input you are currently using. After that pressing VIDEO SELECT cycles through the possibilities in the following order:



The OFF setting means you are listening without a video signal. (Also, when you select CD, CD-R/TAPE1, MD/TAPE2, TUNER or LINE functions the VIDEO SELECT will be set to off.)

After choosing a video input the display on the receiver will show that input for about 5 seconds and then revert to showing the listening mode the receiver is in.



- The VIDEO SELECT remains set to the input you chose until you change the audio input.
- If you change functions the receiver will reset itself to make the video and audio inputs correspond. Also, if you switch the power of the receiver off when you turn it back on the video and audio inputs will reset so that they correspond.

Adjusting the Brightness of the Display (DIMMER)

Use the display DIMMER button to adjust the brightness of the fluorescent display.

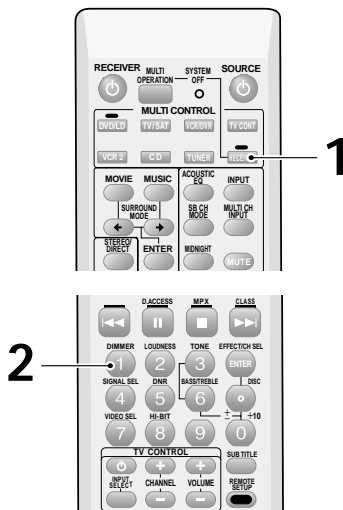

1 Press RECEIVER.

2 Use the display DIMMER button on the remote control to alternate between the different levels of brightness for the display.

Four levels of brightness ranging from very dim to very bright can be selected. Each press changes the brightness of the display. When cycling through the options, the default brightness can also be selected.



- Please note: It is a feature of this unit that the fluorescent display will be brighter for a few seconds after you choose a function (like DVD/LD, CD, etc.) and then get softer. This will still happen when you adjust the brightness but the new setting will be the one the display softens to.

Using the Tuner

Automatic and Manual Tuning

The following steps show you how to tune in FM and AM radio broadcasts using the automatic (search) and manual (step) tuning functions. If you already know the exact frequency of the station you want, see "Direct Access Tuning" on the following page.

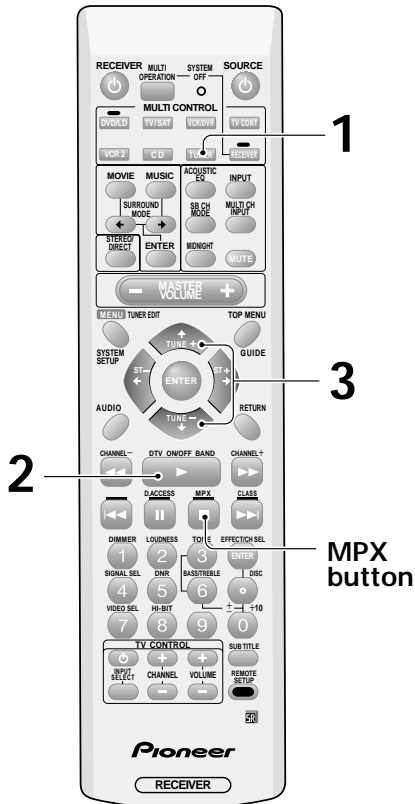

1 Press the TUNER button.

On the remote, this selects the tuner function on the receiver and sets the remote to the tuner operation mode.



2 Press the BAND button to select the band (FM or AM).

Each press switches the band: FM ↔ AM

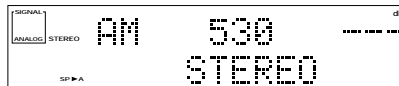

3 Tune in the station.

For Automatic Tuning

Press and hold TUNE -/+ for about one second, then release. The tuner starts searching the selected band and stop automatically at the first station it locates. Repeat to locate other stations.

For Manual Tuning

- To change frequencies one step at a time, press TUNE -/+ repeatedly.
- To change frequencies quickly, hold down TUNE -/+ and release when you reach the frequency you desire.

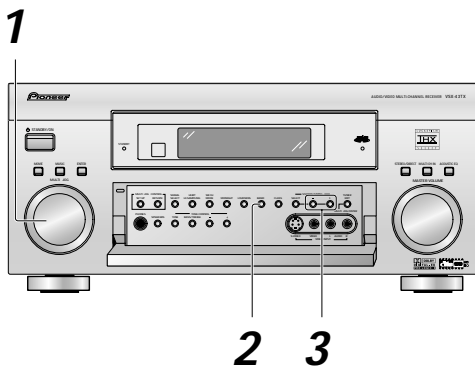

MPX Mode

If the TUNED or STEREO indicators do not light when tuning an FM station, because the station is too far away or the broadcast signal is weak, press MPX on the remote control to switch to MONO reception. This should improve reception enough for you to enjoy the broadcast.

Direct Access Tuning

The following steps show you how to tune directly to a specific frequency using the remote control.

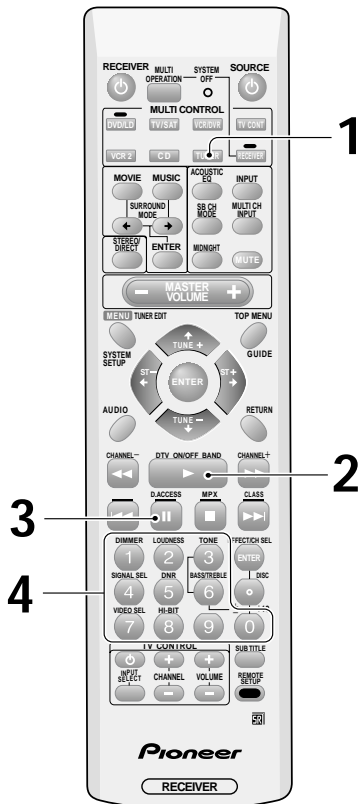

1 Press the TUNER button.

This selects the tuner function on the receiver and sets the remote to the tuner operation mode.

2 Press the BAND button to select the band (FM or AM).

Each press switches the band : FM ↔ AM

3 Press the D.ACCESS button to activate the direct access tuning mode.

The cursor blinks in the display on the front panel.



4 Use the number buttons to enter the frequency of the station you want.

Example:

To tune station 106.00 (FM), press: ① → ⑥ → ⑥ → ① → ①

To cancel before inputting the frequency

Press D.ACCESS, and enter the frequency again.

Memorizing Frequently Used Stations

The following steps show you how to memorize up to 30 radio stations in 3 classes (each holding 10 stations). When memorizing FM frequencies, the receiver also memorizes the MPX mode (STEREO or MONO).

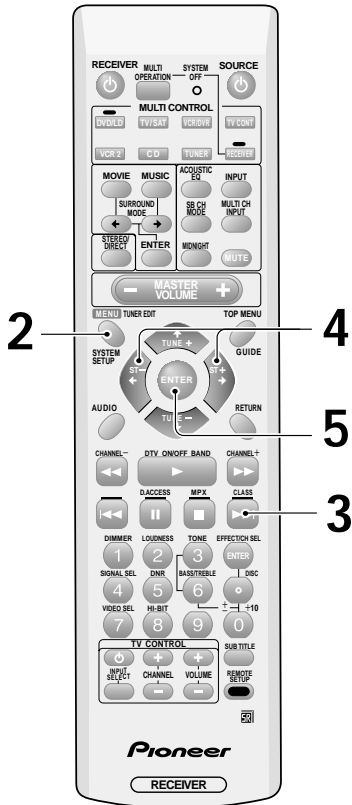

1 Tune in the station you want.

See "Automatic and Manual Tuning" or "Direct Access Tuning" on page 54 and 55.

2 Press the TUNER EDIT button to activate the memory function.

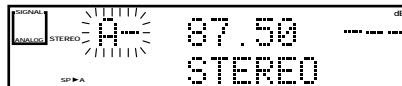

3 Press the CLASS button repeatedly to select a class number.

Each press switches the display:

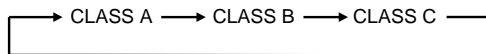

4 Press the ST +/- buttons (or the number buttons) repeatedly to select a channel (0~9) within the respective class.

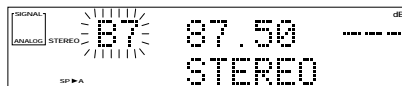

5 Press the ENTER button to input your choice.

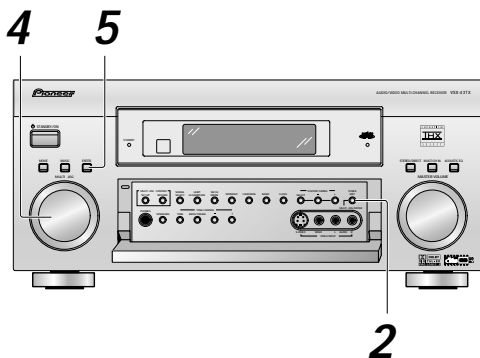

Naming Memorized Stations

You can input a name of up to four characters for each preset station in the receiver's memory (see the previous page). This name can be anything you choose. For example, you could input JAZZ for that station and when you listen to it the name, rather than the frequency number, will appear on your display.

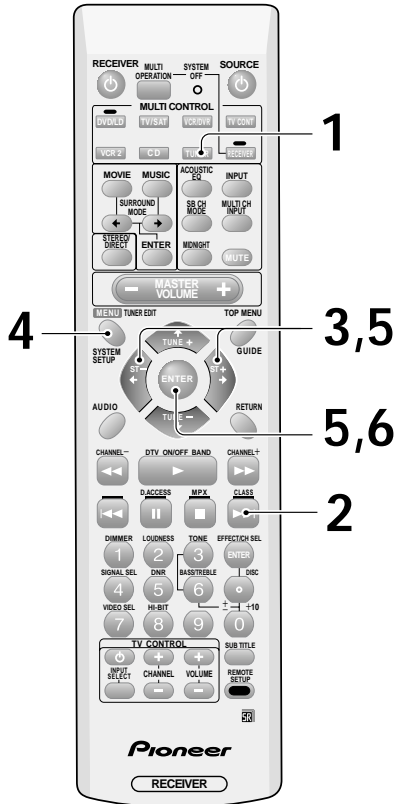

1 Press the TUNER button on the remote control.

2 Press CLASS repeatedly to select the class.

Repeatedly pressing this button cycles through the three available classes, A, B and C.

3 Press ST +/- to select the preset channel.

4 Press TUNER EDIT to select the station name mode.

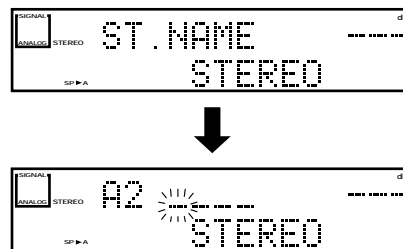

5 Enter the station name you want.

Names can be up to four characters long.

- Use the MULTI JOG dial (front panel) or the ST +/- buttons (remote) to select characters.
- Press ENTER to confirm a character. If no character is input, a space is input.

The possible selections are shown below.

ABCDEFGHIJKLMNOPQRSTUVWXYZ

abcdefghijklmnopqrstuvwxyz

0123456789

!"#\$%&'()*+,-./:;<=>@[\] _ { } [space]

To erase a station name, simply repeat steps 1-4 and input four spaces instead of a name.

6 Press ENTER when you have got the characters you want to enter.

Repeat steps 2 to 5 to memorize up to 30 preset broadcast station names.



- To change a station name, enter a new name over the top of the existing one.

1,5 5,6

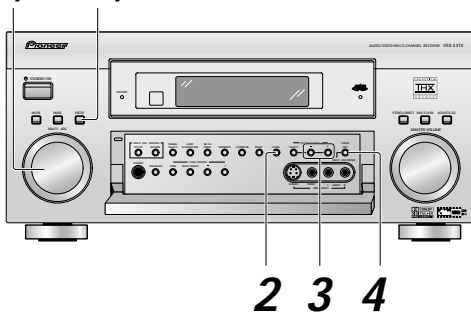

Recalling Memorized Stations

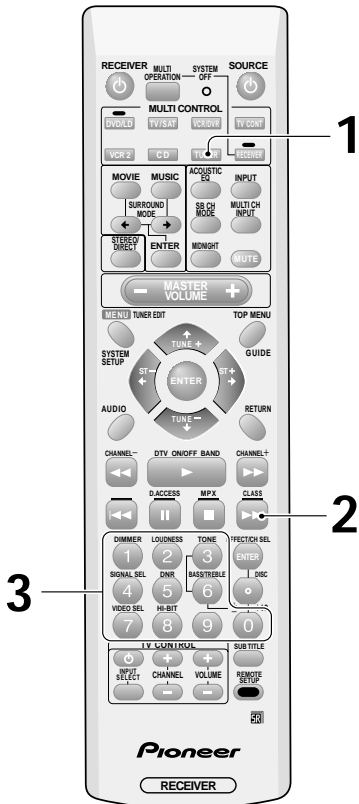

1 Press the TUNER button.

This selects the TUNER function on the receiver and sets the remote to the TUNER operation mode.



2 Press the CLASS button repeatedly to select a class number.

Each press switches the display:

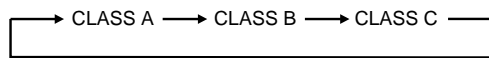

3 Use the NUMBER buttons to select the channel you desire.

To select channel 7, press ⑦.

To select channel 0, press ⑩.

For example : If 99.50 MHz (FM) was memorized in class B at channel 7.

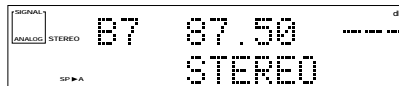

To step through each channel in order

Press the ST +/- buttons repeatedly.

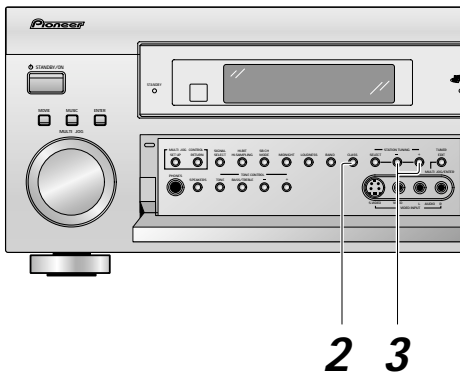

Remote Control of Other Components

Setting Up the Remote Control to Control Other Components

In addition to controlling the receiver, the supplied remote control can operate your other components (VCR, TV, DVD, CD, etc.) after you program it to do so. In this way, instead of fumbling with many different controls and buttons, you only need to use one remote control. If your component(s) are listed in the remote control's memory, simply follow the steps below. If your component(s) are not listed, or if you want the remote to learn additional operations, you can use the learning mode to input the information from the remote controls supplied with your other components.

Recalling Settings Stored in the Remote Control

The following steps show you how to recall the setting stored in the remote control. Once a setting is recalled and the component assigned, you can use this remote to easily operate the component.



- To exit from the remote control setup mode at any time, press **REMOTE SETUP**.
- See "Using Remote Control with Other Components" on pages 61–62 to operate your other components.
- The TUNER button cannot be assigned.

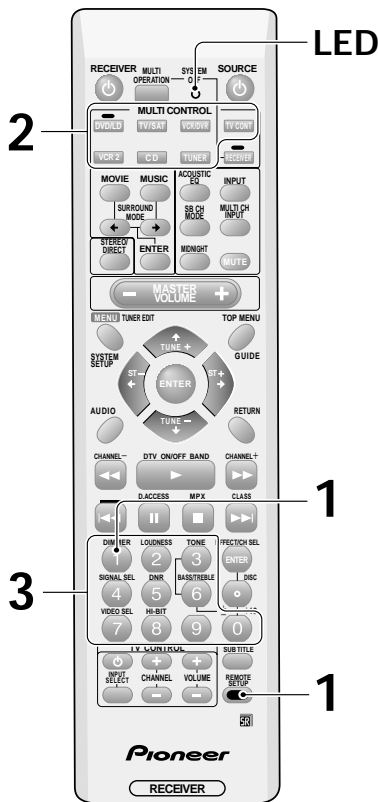

- 1 While holding down the REMOTE SETUP button press **1** to select the preset recall setup mode.**

The LED begins to blink.

To cancel the preset recall setup mode press **REMOTE SETUP**.

- 2 Press the MULTI CONTROL button for the component you want to control.**

The LED lights continuously.

- 3 Point the remote toward the component to be controlled, enter the 4 digit setup code (see pages 93–94 for codes).**

The LED blinks.

After a code has been input the power of the component being input will turn on or off.

The remote will return to the previous mode after thirty seconds of inactivity.

The power of the component being input will only turn on or off if that component is able to be turned on directly by remote control.

Repeat steps 2 through 3 to assign preset codes for as many components as necessary.

If you can't get your component to respond to any of the codes you can still program the component into the remote control using the procedure in the next section.

- 4 Press the REMOTE SETUP button to exit the preset recall setup mode.**

The remote control and receiver return to their previous operation modes.

Remote Control of Other Components

Programming Signals from Other Remote Controls (LEARNING Mode)

If preset codes are not available for your component(s), or the available preset codes do not operate correctly, you can use this procedure to program in signals from the remote control(s) of your other component(s). These steps can also be used to add further operations to the remote control that were successfully set with the stored settings (see page 59).



- To exit from the remote control setup mode at any time, press REMOTE SETUP.
- You can also program the ▲/▼/◀/▶ and ENTER buttons with the LEARNING mode.
- The TUNER button cannot be assigned.
- Some commands cannot be learned.

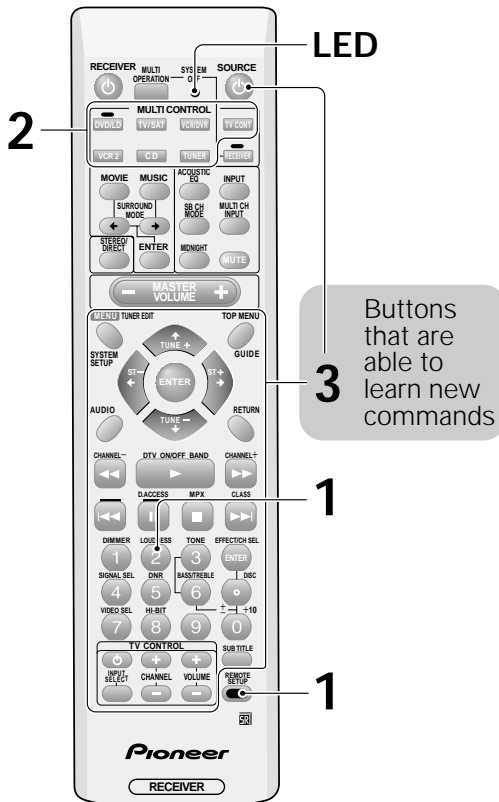

1 While holding down the REMOTE SETUP button press 2 to select the learning setup mode.

The LED begins to blink.

To cancel the learning setup mode press REMOTE SETUP.

2 Press the MULTI CONTROL button for the component you want to control.

The LED lights continuously.

3 Press the button to be programmed.

For example DVD/LED
The LED blinks rapidly.

- The TV ϕ , TV INPUT SELECT, TV CHANNEL +/- and TV VOLUME +/- buttons are only available for learning when programming TV CONTROL operations.

4 Point the remote controls at each other and press the button on the other remote control for the operation you wish to program.

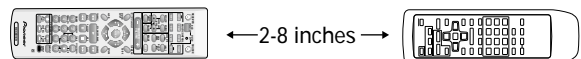

- ① Point the remote controls toward each other.
- ② Press the button on the other remote control corresponding to the operation you wish to program.

The LED will turn off and then light again.

To program additional operations for the current component, repeat steps 3 and 4.

To program operations for another component, repeat steps 2 through 4.

5 Press the REMOTE SETUP button to exit the learning setup mode.

The remote control and receiver return to their previous operation modes.

Using Remote Control with Other Components

CD/MD/CD-R/VCR/DVD/LD/DVD recorder/Cassette Deck operations



- The following operations are available from the receiver's remote control after you program it (see "Setting Up the Remote Control to Control Other Components," page 59).
- To perform these operations, press the **MULTI CONTROL** button for the component you want to control.
- For more information on individual commands consult the manual that came with the component.

| Button(s) | Function | Components |
|------------------------|-------------------------------------------------------------------------------------------------------------------------------------------------------------------------------------------------|------------------------------------------------------|
| SOURCE | Press to switch the components between STANDBY and ON . | CD/MD/CD-R/VCR/DVD/LD/ DVD recorder/Cassette deck |
| | Press to return to the start of the current track or chapter. Repeated presses skips to the start of previous tracks or chapter. | CD/MD/CD-R/DVD/LD/ |
| | Go back channels (channel -). | VCR/DVD recorder |
| | Play the reverse side of the tape on a reversible deck. | Cassette deck |
| | Press to advance to the start of the next track or chapter. Repeated presses skips to the start of following tracks or chapter. | CD/MD/CD-R/DVD/LD/ |
| | Go forward channels (channel +). | VCR/DVD recorder |
| | Pause playback or recording. | CD/MD/CD-R/VCR/DVD/LD/ DVD recorder/Cassette deck |
| | Hold down for fast forward playback. | CD/MD/CD-R/VCR/DVD/LD/ DVD recorder/Cassette deck |
| | Hold down for fast reverse playback. | CD/MD/CD-R/VCR/DVD/LD/ DVD recorder/Cassette deck |
| | Start playback. | CD/MD/CD-R/VCR/DVD/LD/ DVD recorder/Cassette deck |
| | Stop playback (on some models, pressing this when the disc is already stopped will cause the disc tray to open). | CD/MD/CD-R/VCR/DVD/LD/ DVD recorder/Cassette deck |
| SUBTITLE Button | Displays/changes the subtitles on multilingual DVDs. | DVD/DVD recorder |
| Number Buttons | Directly access tracks on a program source. | CD/MD/CD-R/LD |
| | Directly access chapter on a program source. | DVD/DVD recorder |
| | Directly select a channel. | VCR/DVD recorder |
| +10 Button | Select tracks or chapter higher than 10. Press this button and the remaining number to get the track or chapter (+10 Button + 3= track or chapter 13). Some components may operate differently. | CD/MD/CD-R/DVD/LD/ DVD recorder |
| ENTER/DISC Button | Press to start Search mode. | DVD |
| | Takes you to the disc navigator. | DVD recorder |
| | Changes between sides A & B of the disc. | LD |
| | Press to enter the selected channel. | VCR |
| | Selects a disc in a multi-disc CD player. | CD |
| MENU | Displays menus concerning the current DVD, DVR or VCR you are using. | DVD/DVD recorder/VCR |
| AUDIO | Changes the audio track of discs with more than one audio track. | DVD/LD/DVD recorder |
| | Changes between the tuner in the TV and the tuner in the VCR. | VCR |
| | Play the reverse side of the tape on a reversible deck. | Double cassette 2nd deck |
| TOP MENU /GUIDE button | Displays the top menu of the current DVD, LD or DVR you are using. | DVD/LD/DVD recorder |
| | Takes you to the guide menu of that system. | VCR |
| | Press to select a track | CD |
| RETURN button | Takes you to the previous menu. | DVD/LD/VCR/DVD recorder |
| & ENTER | Navigate menus/options. | DVD/LD/DVD recorder/VCR |
| | Basic playback options. | Double cassette 2nd deck |

Remote Control of Other Components

Cable TV/Satellite TV/Digital TV/TV operations



- The following operations are available from the receiver's remote control after you program it (see "Setting Up the Remote Control to Control Other Components," page 59).
- To perform these operations, press the **MULTI CONTROL** button for the component you want to control.
- For more information on individual commands consult the manual that came with the component.

| Button(s) | Function | Components |
|-------------------|-----------------------------------------------------------------------------------------|----------------------------------------|
| TV | Press to switch the TV, Satellite TV or Cable TV between STANDBY and ON . | Cable TV/ Satellite TV/ TV |
| INPUT SELECT | Press to switch the TV input. | TV |
| TV CHANNEL (+/-) | Select channels. | Cable TV/ Satellite TV/ TV |
| TV VOLUME (+/-) | Adjust the TV volume. | TV |
| MENU | Takes you to the TV menu of that system. | Cable TV/ Satellite TV/ TV/ Digital TV |
| GUIDE | Takes you to the guide menu of that system. | Cable TV/ Satellite TV/ TV/ Digital TV |
| RETURN | Exits the menu you are viewing. | Cable TV/ Satellite TV/ Digital TV |
| | A/BLUE | Satellite TV/ Digital TV |
| | B/Press to switch the DTV ON. | Satellite TV/ Digital TV |
| | C/GREEN | Satellite TV/ Digital TV |
| | Use to move back a page in the menu. | Cable TV |
| | D/RED | Satellite TV/ Digital TV |
| | E/YELLOW | Satellite TV/ Digital TV |
| | Use to move forward a page in the menu. | Cable TV |
| | Use to move back channels. | Digital TV/ TV/ Cable TV |
| | Use to move back a page in the menu. | Satellite TV |
| | Use to move forward channels. | Digital TV/ TV/ Cable TV |
| | Use to move forward a page in the menu. | Satellite TV |
| | Use to show the DTV manu. | Digital TV/ TV |
| Number Buttons | Use to select a specific TV channel. | Cable TV/ Satellite TV/ TV/ Digital TV |
| ENTER/DISC button | Use this button to immediately enter a new channel. | Cable TV/ TV/ Digital TV |
| ENTER | Press to select or adjust and navigate items on the menu screen. | Cable TV/ Satellite TV/ TV/ Digital TV |



- The first four buttons are dedicated to control the TV assigned to the TV CONT button. Thus if you only have one TV hooked up to this system, assign it to the TV CONT button. If you have two TVs, assign the main TV to the TV CONT button. If you hook up your system this way, the first four TV controls will always be accessible. For example, if you connect your TV to TV monitor, then use TV CONT for your TV. If you connect your TV to input source then use TV.
- Depending on the maker and individual model, there are some buttons that may not be able operate some equipment or may operate it in a different way.

Setting up the DIRECT FUNCTION

The direct function will not be necessary for most users. It is designed in case you have an external video source connected to your TV (a video source that is not going through the VSX-43TX). For this explanation we'll call this the external video deck. You'd like to control external video deck with this unit's remote control so you've assigned it a function button (for example purposes, the VCR 2 button). Yet, if you put the receiver in VCR 2 mode you'll get no picture on your TV because the external video deck signal is not going through the VSX-43TX. To get around this problem you set the DIRECT FUNCTION for VCR 2 to OFF. Now when you press VCR 2 function button you can control the external video deck with the remote but the receiver does not go into VCR 2 mode.



- To exit from the remote control setup mode at any time, press REMOTE SETUP.
- The default setting for all DIRECT FUNCTIONs is ON.

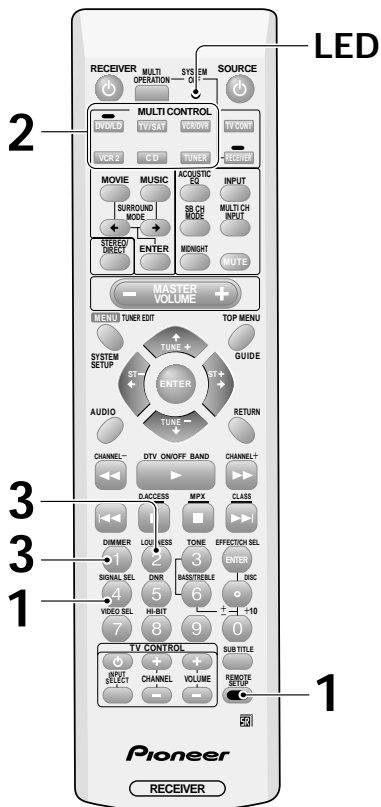

- 1 While holding down the REMOTE SETUP button press 4 to select the direct function setup mode.

The LED begins to blink.

To cancel the direct function setup mode press REMOTE SET UP.

- 2 Press the MULTI CONTROL button of the component whose direct function you want to turn on or off.

The LED lights and remains lit.

For example, if you want to turn off direct function for VCR 2, you would press VCR 2.

- 3 Set the DIRECT FUNCTION of each external source to OFF by pressing 2, ON by pressing 1.

The LED blinks.

ON: The direct function is on.

OFF: The direct function is off.

For example, if you want to turn off direct function for VCR 2, you would press 2.

- 4 Repeat steps 2-3 to set the direct function for as many components as you want.

- 5 Press the REMOTE SETUP button to exit the direct function setup mode.

Using Other Functions

Recording from Audio/Video Components

The following explanations show you how make a recording from one component to another connected to this receiver. Note that an analog recorder (such as a VCR) cannot record from a source that is connected using only a digital connection. Likewise, a digital recorder (such as a CD-R) cannot record digitally from a component that is connected using only analog connections. In both of these cases, make sure that the digital component also has analog connections to the receiver, and that the SIGNAL SELECT is set to ANALOG.

When recording from one digital component to another, bear in mind that the digital signal output from this receiver mirrors the input from the source. So if the input is, say, Dolby Digital, the output will also be Dolby Digital. Before recording, make sure that the recorder is compatible with the source digital audio format.

See page 19 for more on analog audio connections and page 21–22 for digital audio connections.



- The receiver's volume, channel level, balance, TONE, DIGITAL NR, MIDNIGHT, LOUDNESS, ACOUSTIC CAL EQ and surround effects have no effect on the recorded signal.
- In some cases, digital recordings have copy guard protections and making a digital copy is not possible. In this case you can only copy them in an analog manner.
- Some video recordings are copy-protected; these sources cannot be recorded.
- When recording video, the source must be connected to the receiver using the same type of video cord (composite, or S video) as you used to connect the recorder to the receiver.

Functions that can be recorded

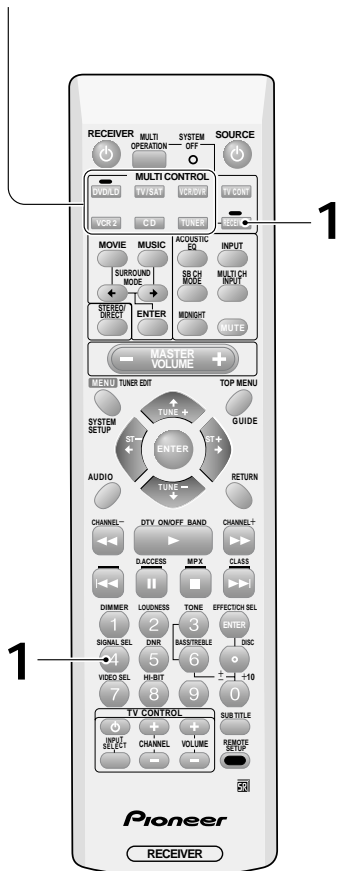

1 Select the source component. Set SIGNAL SELECT according to the source component's signal (ANALOG or DIGITAL).

2 Start recording (tape deck, CD recorder, VCR, etc.)

3 Playback the source to be recorded.

SECOND ZONE (Speaker System B)/FRONT BI-AMP Setup

Stereo playback in another room (SECOND ZONE)

This setup enables you to listen to a pair of stereo speakers independently of the main speaker system hooked up to the receiver. The VSX-43TX has two possibilities for playback in another room. You can choose SECOND ZONE, and use the speakers hooked up to the surround back terminals as a B speaker system, that is, playing the same source as the main speaker system but from independent stereo speakers.

1 Connect a pair of speakers to the surround back speaker terminals.

2 Select SECOND ZONE in the SURRBACK SYSTEMS setup (see page 35) setup.



Please use speakers with a nominal impedance rated 8 Ω-16 Ω.

Bi-amping the front speakers (FRONT BI-AMP)

For bi-amp playback you can connect both the A and B speaker terminals to your front speakers. To do this your speakers must be bi-wireable (that is they must have separate terminals for the high and low frequencies).

Bi-amping delivers more power to the front speakers, but disables the surround back speakers, so you will be limited to 5.1 channel playback.

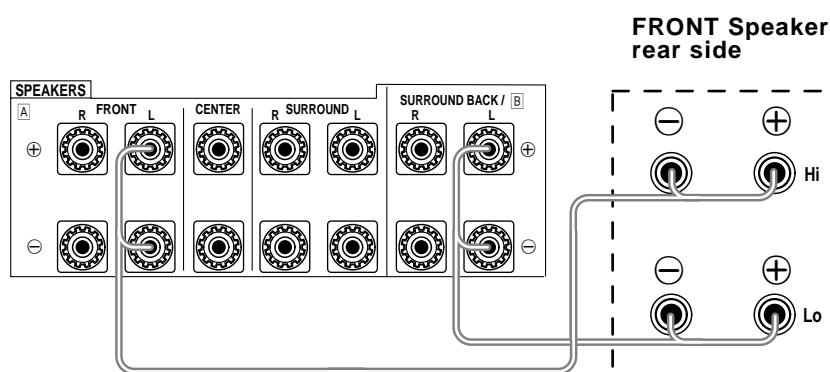

Caution!

Most speakers with both Hi and Low terminals have two metal plates that connect the Hi to the Low terminals. These must be removed when you are bi-amping the speakers or you could severely damage the amplifier. See your speaker manual for more information.

Caution!

Do not allow any speaker wire from any terminal to touch a wire from a different terminal.

1 Connect your speakers as shown.

Since both Front A and B speaker terminals output the same audio, it doesn't matter which set (A or B) is powering which part (HI or LOW) of the speaker.

2 Select FRONT BI-AMP in the SURRBACK SYSTEMS setup (see page 35).

The surround back channel amplifier is now used to power the B set of speaker terminals and the A+B (SP►AB) speaker setting is automatically selected. The speaker setting in this case can only be A+B or OFF.

Connecting Additional Amplifiers

This receiver has more than sufficient power for any home use, but it is possible to add additional amplifiers to every channel of your system. Make the connections shown below to add amplifiers to power your speakers. Before making or changing the connections, switch off the power and disconnect the power cord from the AC outlet.

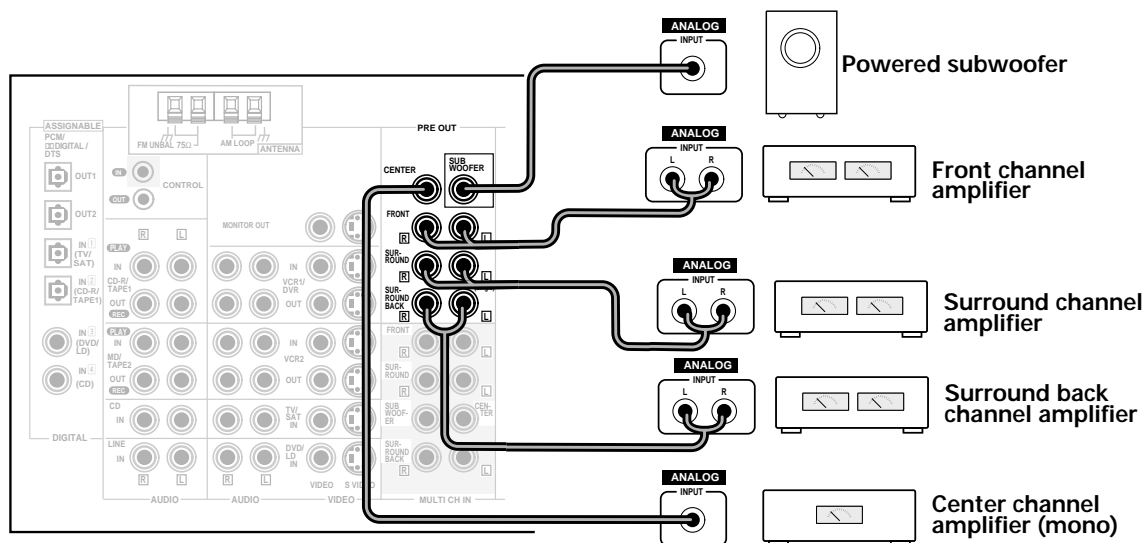

- You can use the additional amplifier on the surround back channels for a single speaker as well. In this case plug the amplifier into the L (SINGLE) terminal only.
- The sound from the surround back terminals will depend on how you have set up the SURRBACK SYSTEM (see pages 35).

Multi Operations

Multi operations allow you to tell the receiver and your other components to do a number of things with the push of only two buttons on the remote control (see "Performing Multi Operations" on the next page). For example, you can program the unit to turn on your TV, turn on your DVD player and start playing the loaded DVD. This allows you to freely decide which operations you want performed as well as the order in which you want them performed. The steps below show you how to program a string of up to 5 different operations for each MULTI CONTROL button. You don't need to program the power of this receiver (or any Pioneer component used) to go on, it (or they) will do so automatically when multi operations are performed.



- Be sure to set up each component before programming multi operations (see "Setting Up the Remote Control to Control Other Components", pages 59–60).
- To exit from the REMOTE SETUP mode at anytime press the REMOTE SETUP button.

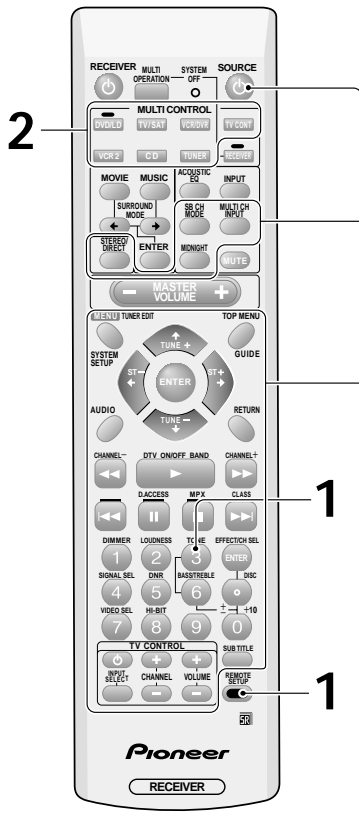

Buttons that can be programmed with Multi Operations

1 While holding down the REMOTE SETUP button press 3 to select the multi operation setup mode.

The LED begins to blink.
To cancel the multi operation setup mode press REMOTE SET UP.

2 Select a MULTI CONTROL button for this multi operation.

The LED lights and remains lit.
Each MULTI CONTROL button can be used for one multi operation. If a multi operation relates to using a DVD player, for example, it makes sense to select the DVD/LD button.

3 Press the operation button.

for example ► (play), you want to input.

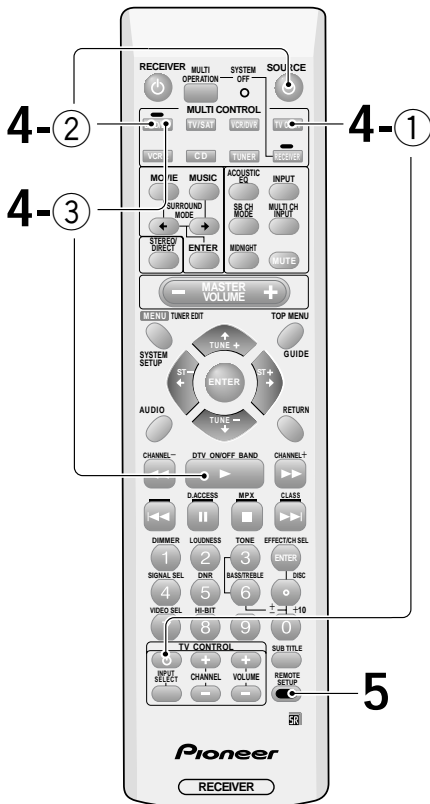

4 Repeat steps 2 and 3 to input multi operations to the MULTI CONTROL button you pressed in step 3.

You can repeat this process for up to five commands.

For example : you could enter the following three operations using the preceding steps 2 and 3.

- ① Press the TV CONTROL button and TV ⏻ (POWER) to turn on your TV (as explained above).
- ② Press the DVD/LD button then ⏻ (POWER) to turn on your DVD player (if it is not a PIONEER product).
- ③ Press the DVD/LD button then ▶ (play) to start playing the DVD player.

When you employ multi operations (see below), these three tasks will be performed in the same order.

5 Press the REMOTE SETUP button to exit the multi operation setup mode.

The remote control return to their previous operation modes.



You don't need to program power on for PIONEER components (except for the first generation of Pioneer DVRs), they will go on automatically if a command for that unit is entered in the multi operations settings. Also, your TV will go on automatically if a TV related command is entered in the multi operations.

Performing Multi Operations

Do the following to use the MULTI OPERATIONS.

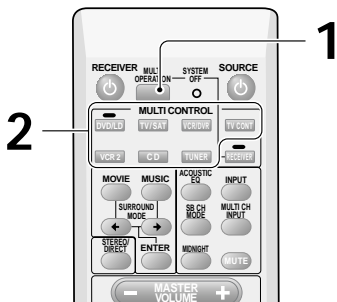

1 Press the MULTI OPERATION button.

2 Press the MULTI CONTROL button for the component that has been set up with multi operations.

The power of the receiver (and any Pioneer components use in the program) goes on and the programmed multi operations are performed automatically.

SYSTEM OFF

The SYSTEM OFF feature allows you to tell the receiver and your other components to stop and/or turn off with the push of only one button on the remote control. For example, you can program the unit to turn off your TV and turn off your DVD player, etc. You don't need to program power off for PIONEER components, they will go off automatically in this mode. The receiver itself will go off automatically as well.

The steps below show you how to program a string of up to 5 different SYSTEM OFF operations.



- Be sure to set up each component before programming SYSTEM OFF operations (see "Setting Up the Remote Control to Control Other Components", pages 59–60).
- To exit from the REMOTE SETUP mode at anytime press the REMOTE SETUP button.

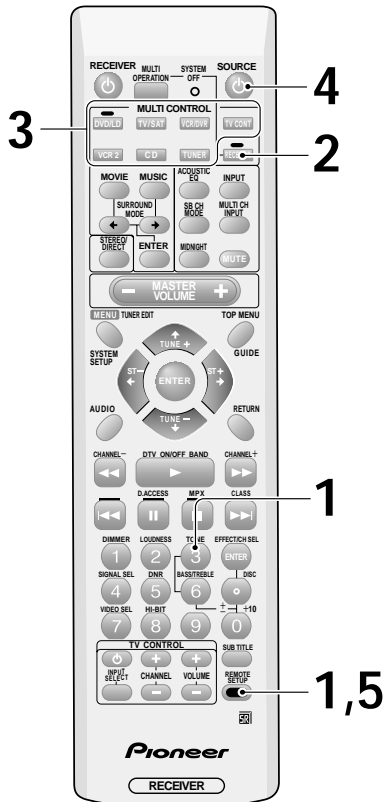

1 While holding down the REMOTE SETUP button press 3 to select the SYSTEM OFF setup mode.

The LED begins to blink.

To cancel the SYSTEM OFF setup mode press REMOTE SET UP.

2 Press the RECEIVER button.

The LED lights and remains lit.

3 Select a MULTI CONTROL button for SYSTEM OFF.

Each MULTI CONTROL button can be used for SYSTEM OFF. If a SYSTEM OFF command relates to using a DVD player, for example, it makes sense to select the DVD/LD button.

4 Press the SOURCE button of the component to be set with SYSTEM OFF operations.

5 Press the REMOTE SETUP button to exit the SYSTEM OFF setup mode.

The remote control return to their previous operation modes.

Using SYSTEM OFF

Do the following to use the SYSTEM OFF function.

The SYSTEM OFF feature allows you to tell the receiver and your other components to stop and/or turn off with the remote control. Most Pioneer components will automatically turn off. The receiver itself will go off automatically as well.

The following Pioneer components can be turned off using the SYSTEM OFF function:

DVD, DVD-Recorder, LD, CATV, CD, CD-R, MD, Satellite Tuner, Tape, Tuner, VCR, and TV.



- Be sure to set up each component before programming multi operations (see "Setting Up the Remote Control to Control Other Components", pages 59–60).
- To exit from the REMOTE SETUP mode at anytime press the REMOTE SETUP button.

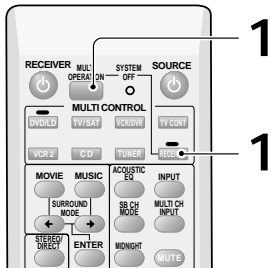

1 Press the MULTI OPERATION button and within 5 seconds press the RECEIVER button.

All the Pioneer components connected to the receiver and the receiver will stop and/or go off.

The PIONEER SR System: Operating other PIONEER components

Connecting an optional control cord allows you to operate other PIONEER components simply by pointing the receiver's remote control at the remote sensor on the front panel of the receiver. The receiver then sends the remote control signals to the other devices via the CONTROL OUT terminal.

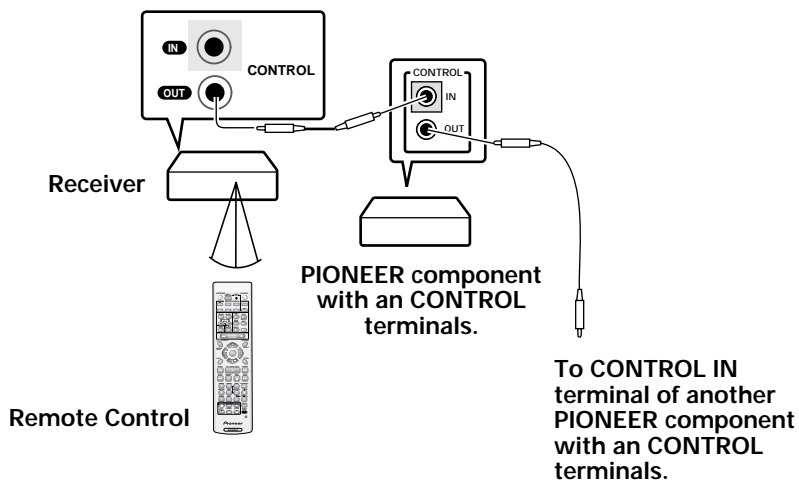

- You can also control PIONEER components (and those made by other manufacturers) by pointing the receiver's remote control directly at the respective component. This type of operation does not require control cords. All you have to do is recall the appropriate stored settings (see page 59).
- If you use a remote control hooked up via the CONTROL IN jack with a control cord, you won't be able to use this unit's remote control.
- If you use this feature make sure an analog (audio and/or video) connection has been made between the units.

Using Other Functions

Resetting the Remote Control

The following operations allow you to erase the settings stored in the remote control.

Erasing Multi Operations

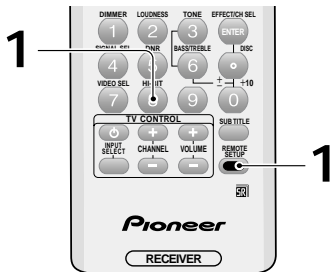

- 1 Press and hold both the **REMOTE SETUP** button and **8** for more than 3 seconds.

LED lights will blink 3 times and all multi operation settings will be erased.

Erasing Learned Remote Control Commands

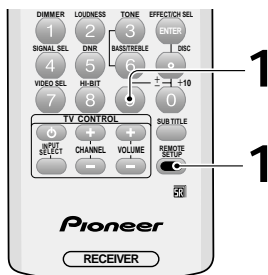

- 1 Press and hold both the **REMOTE SETUP** button and **9** for more than 3 seconds.

LED lights will blink 3 times and all learned remote control commands will be erased.

Erasing All Remote Control settings

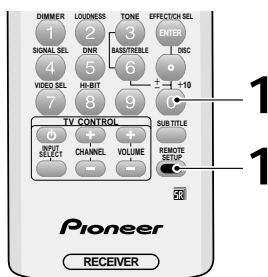

- 1 Press and hold both the **REMOTE SETUP** button and **0** for more than 3 seconds.

LED lights will blink 3 times and all remote control settings will be erased.

Resetting the Main Unit

The following operations allow you to reset the unit to the default settings.

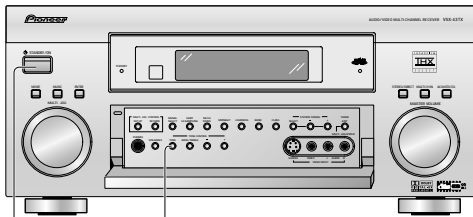

1 1

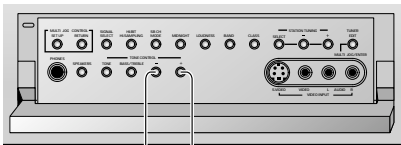

2 2

1 While holding down the TONE button press the STANDBY/ON button for about three seconds.

2 When you see RESET? appear in the display, press the TONE - button. OK? appears in the display, press TONE +.

When OK appears in the display all the settings, including the speaker, surround sound settings and tuner settings, will be reset in the unit to the factory default settings.

Fine Tuning Your System

Other System Settings

These settings are more advanced. Some could add depth or listenability to your sound (like the THX CINEMA setup) and others are for your convenience (like the FUNCTION RENAME). You can decide if you want to make these settings or not. They are not crucial to good surround sound. You only need to make these settings once (unless you change the placement of your current speaker system, add new speakers or components to your system, etc.). Use the arrow buttons (▲▼) and the ENTER button on the remote control to navigate the display on the receiver. Conversely, you can use the MULTI JOG dial and ENTER button on the front panel.

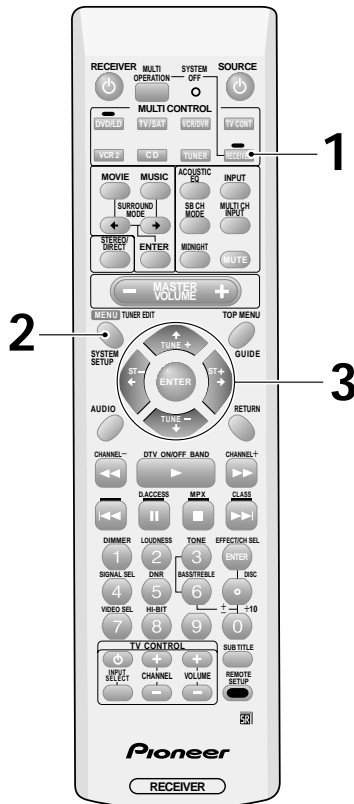

2 Press the **SYSTEM SETUP** button.

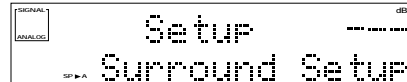

This display appears on the receiver.

3 Follow the order below to make advance settings. Use the ▲▼ buttons to choose a menu. When you have the setup you want press **ENTER**.

In each mode, the current settings are displayed automatically.

THX CINEMA Setup (page 75)

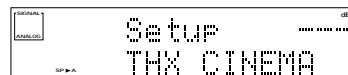

This setup lets you choose which multichannel decoding method, from stereo sources, the receiver will use for THX CINEMA.

INPUT ASSIGN (page 76-77)

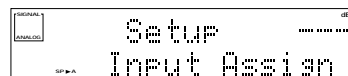

If you hook up your digital components in a different way than the default settings you need to tell the receiver how you hooked them up so the names on the remote control and front panel match your home setup. Do this with the DIGITAL-IN SELECT setup. Also, if you hooked up video devices with component video cable you need to tell the receiver which devices are hook up in this way. Do this with the COMPONENT-IN SELECT setup.

FUNCTION RENAME (page 78)

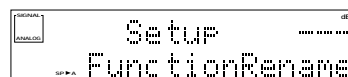

This feature allows you to change the names that appear in the receiver display to reflect what you have connected.

3 2 RETURN button

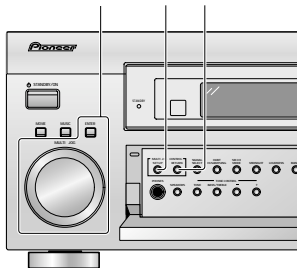

1 Turn on the receiver, press the **RECEIVER** button on the remote control.

THX CINEMA Setup

This setup lets you choose which decoding method for 2 channel sources the receiver will use for THX CINEMA. The three THX CINEMA decoding methods are; PRO LOGIC II MOVIE, PRO LOGIC and NEO:6 CINEMA. For more information on the decoding (playback) formats see "Techno Tidbits" on page 88.

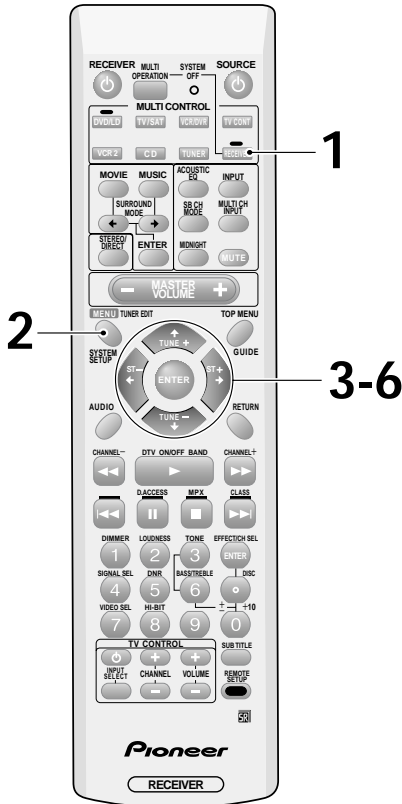

3-5 2 RETURN button

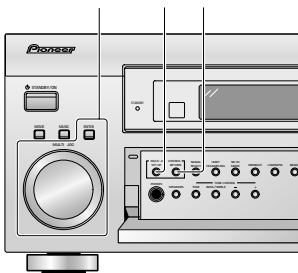

(If you are continuing from page 74 you can skip the first two steps.)

- 1 Turn on the receiver, press the RECEIVER button on the remote control.

- 2 Press the SYSTEM SETUP button.



This display appears on the receiver.

- 3 Looking at the display on your receiver, use the ▲▼ buttons to select THX CINEMA SETUP. Press the ENTER button.

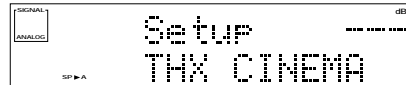

- 4 Use the ▲▼ buttons to choose a THX CINEMA decoding method. Press the ENTER button.

PRO LOGIC II MOVIE is selected.

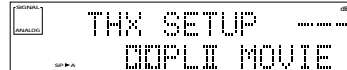

PRO LOGIC is selected.

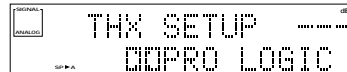

NEO:6 CINEMA is selected.

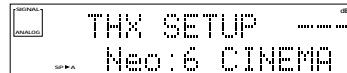

- 5 EXIT should be selected (if not, use the ▲▼ buttons to select it). Press ENTER.

- 6 Use the ▲▼ buttons to select EXIT and press ENTER, again.

This exits the SYSTEM SETUP mode and returns to normal operation.



The default is PRO LOGIC II MOVIE.

Assigning the Digital Inputs

If you did not hook up your digital equipment in accordance with the default settings for the digital inputs (see page 16,18 & 21) you need to complete the procedure below. You have to do this in order to tell the receiver what digital equipment is hooked up to which terminal so the buttons on the remote correspond to what you have hooked up.

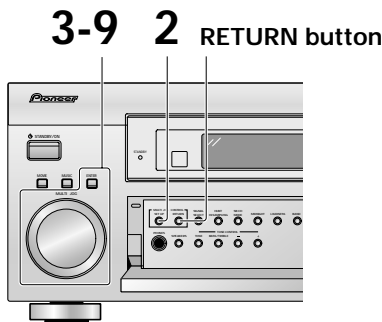
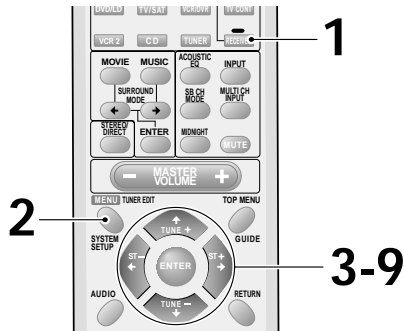

(If you are continuing from page 74 you can skip the first two steps.)

- 1 Turn on the receiver, press the RECEIVER button on the remote control.
- 2 Press the SYSTEM SETUP button.
- 3 Looking at the display on your receiver, use the ▲▼ buttons to select INPUT ASSIGN. Press the ENTER button.

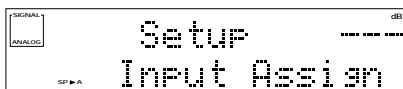

- 4 DIGITAL-IN should be selected, if not use the ▲▼ buttons to select it. Press the ENTER button.

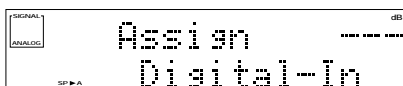

- 5 Use the ▲▼ buttons to move through the different digital input settings and press the ENTER button.

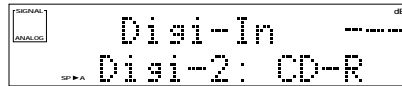

The available digital input settings are:
 DIGI-1: TV/SAT, DIGI-2: CD-R,
 DIGI-3: DVD/LD, DIGI-4: CD
 The selected setting will blink.

- 6 Use the ▲▼ buttons select the component that you hooked up to that digital in. Press the ENTER button.

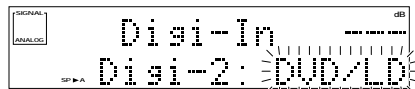

If you're not sure which component is connected to which digital in, look on the back of the receiver and check the cables you connected.

- 7 Repeat steps 5-6 to change other digital input settings.
- 8 When you're finished use the ▲▼ buttons to select EXIT and press ENTER.
 This exits the DIGITAL-IN SELECT mode.
- 9 Use the ▲▼ buttons to select EXIT and press ENTER, again.
 Then, use the ▲▼ buttons to select EXIT and press ENTER.
 This exits the SYSTEM SETUP mode and returns to normal operation.



- The possible digital inputs that can be assigned are: DVD/LD, TV/SAT, VCR1, VCR2, CD, CD-R, MD.
- If you assign a digital input to a certain function (for example DVD/LD) then any digital inputs previously assigned to that function will automatically be set to OFF. This is because one function cannot be assigned to two different places.

Assigning the Component Video Inputs

This receiver has two component video inputs. Their default settings are video inputs for the DVD/LD (COMPONENT VIDEO IN [1]) and TV/SAT (COMPONENT VIDEO IN [2]) functions, but you can reassign them if you want to use them as video inputs for other receiver functions (for example a VCR).

See pages 15–18 for more on connecting equipment using component video cords.

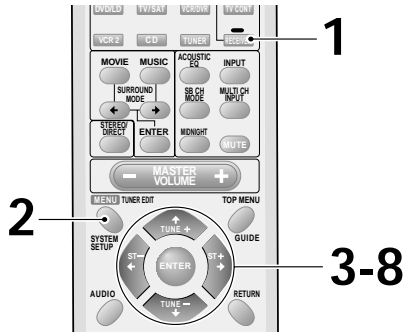

3-8 2 RETURN button

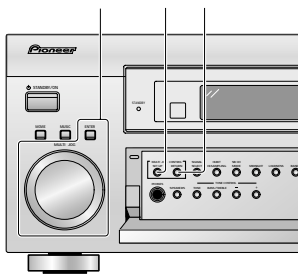

(If you are continuing from page 74 you can skip the first two steps.)

- 1 Turn on the receiver, press the RECEIVER button on the remote control.
- 2 Press the SYSTEM SETUP button.
- 3 Looking at the display on your receiver, use the ▲▼ buttons to select INPUT ASSIGN. Press the ENTER button.

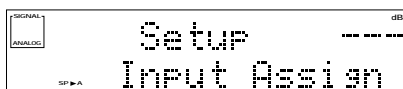

- 4 Use the ▲▼ buttons to select COMPONENT-IN then press ENTER.



- 5 Use the ▲▼ buttons to select the component video input you want to reassign. Press the ENTER button.



The available component video inputs are:
COMPO-1: DVD/LD, COMPO-2: TV/SAT
In the example above, we would select Compo-1.

The selected component video input blinks.

- 6 Use the ▲▼ buttons to assign a receiver function.



Choose between DVD/LD, TV/SAT, VCR1 and VCR2.

In the example above, we would select VCR1.

- 7 When you're finished use the ▲▼ buttons to select EXIT and press ENTER.

You will leave the "COMPONENT-IN SELECT" mode.

- 8 Use the ▲▼ buttons to select EXIT and press ENTER, again. Then, use the ▲▼ buttons to select EXIT and press ENTER.

This exits the SYSTEM SETUP mode and returns to normal operation.



If you connect any source component to the receiver using a component video input, you should also have your TV connected to this receiver's component video output.

FUNCTION RENAME

Use the FUNCTION RENAME capability to rename the display on the receiver for different functions (DVD, etc.). For example, you could rename DVD/LD as DVR-7000. For this setup in particular using the controls on the front panel is more convenient than using the remote control. Use the MULTI JOG dial instead of the ▲▼ buttons and use the ENTER button on the front panel.

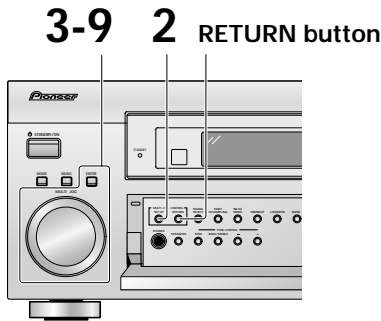

(If you are continuing from page 74 you can skip the first two steps.)

- 1 Turn on the receiver. (If you want to use the remote control for this setup, press the RECEIVER button.)

- 2 Press the SET UP button.



This display appears on the receiver.

- 3 Looking at the display on your receiver, use the MULTI JOG to select FUNCTION RENAME. Press the ENTER button.

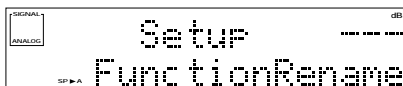

- 4 Use the MULTI JOG to select the name of the function (for example, DVD/LD) you want to change. Press ENTER.



Either the cursor underline bar or a character (depending on which is selected) will blink.

The functions are divided into three different on-screen displays so you may have to move through them to find the function you want to rename.

- 5 Use the MULTI JOG to cycle the cursor through the letters, numbers and symbols. Use the ENTER button to enter one of the possibilities or move forward a space.

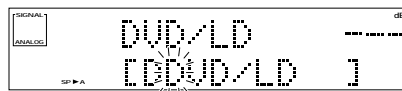

The possible selections are shown below.

```

ABCDEFGHIJKLMNPOQRSTUVWXYZ
abcdefghijklmnopqrstuvwxyz
0123456789
!"#$%&'()*+,-./:;<=>@[ \ ] ^ _ { } [space]
    
```

- 6 Repeat step 5 until you get the name as you want it.



You can input up to ten characters.

- 7 Press ENTER repeatedly to exit the name. The new function name is set.

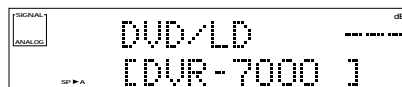

- 8 Repeat steps 4-7 to change other function names. Use the MULTI JOG to select EXIT and press ENTER.

- 9 Use the MULTI JOG to select EXIT and press ENTER.

This exits the SYSTEM SETUP mode and returns to normal operation.



Use the RETURN button to move the cursor back one character when entering a name.

Expert Setup

The settings here can only be done if you've performed the more basic preliminary setups. Thus, before doing these settings do either QUICK setup (page 13) or NORMAL setup (page 36-40). These settings are to further heighten your enjoyment of surround sound. They are not absolutely necessary but may give more defined and enjoyable surround sound. You can decide if you want to make these settings or not. You only need to make these settings once (unless you change the placement of your current speaker system, add new speakers or components to your system, etc.). View these settings on the receiver display. Use the arrow buttons (▲▼) and the ENTER button on the remote control to navigate the display on the receiver. Conversely, you can use the MULTI JOG dial and ENTER button on the front panel.

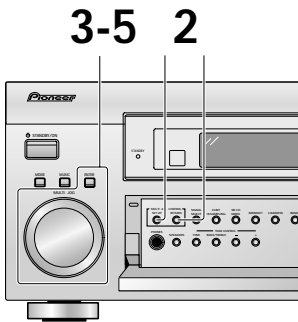
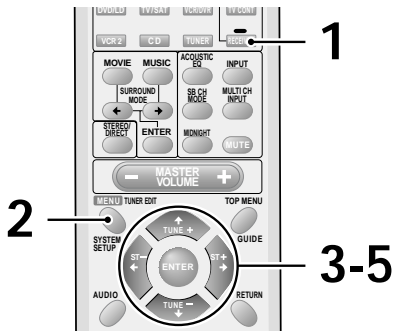

5 Follow the order below to make expert settings. Use the ▲▼ buttons to navigate through the menus. When you have the setting you want in particular menu, press ENTER.

In each mode the current settings are displayed by the receiver.

CROSSOVER NETWORK (page 80)

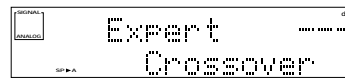

This feature determines which frequencies will be sent to the subwoofer (or large speakers).

FINE CHANNEL LEVEL (page 81)



This feature balances the sound output level of your speakers more finely than in the NORMAL setup.

FINE CHANNEL DELAY (page 82-83)

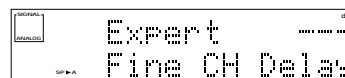

This feature adjusts the delay level of your speakers more finely than in the NORMAL setup.

ACOUSTIC CAL EQ (page 84-85)

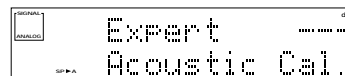

This feature allows you to adjust the amount of a certain frequency in a soundtrack, acting as a kind of room equalizer for your speakers.

BASS PEAK LEVEL (page 86)

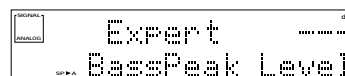

Dolby Digital and DTS audio sources include ultra-low bass tones. Set the bass peak level as needed to prevent the ultra-low bass tones from distorting the sound from the speakers.

DYNAMIC RANGE CONTROL (page 87)

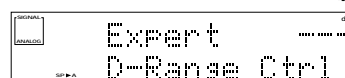

This feature makes possible excellent surround sound effects when listening to Dolby Digital and DTS sources at low volumes.

- 1 Turn on the receiver and press the RECEIVER button on the remote control.
- 2 Press the SYSTEM SETUP button.
- 3 Select SURROUND SETUP with the ▲▼ buttons. Press the ENTER button.

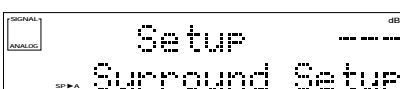

- 4 Select EXPERT with the ▲▼ buttons. Press the ENTER button.



CROSSOVER NETWORK

Crossover frequency is the point where the receiver divides the high and low sounds (the frequencies) between the speakers. Certain bass sounds will play back from the subwoofer if you selected it as YES (or PLUS) or from the front speakers if you selected them as LARGE. This setting decides where the cutoff will be between those bass sounds playing back from the speaker selected as above and the bass sounds for the entire soundtrack, which play back from all speakers used.

If all speakers are set to LARGE (see pages 37–38) this setup is unnecessary.

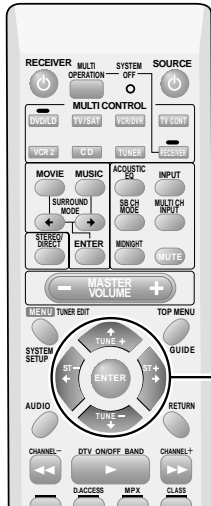

1-3

1-3

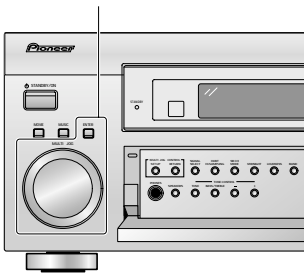

Follow steps 1-5 on page 79, if necessary, to get to the starting point mentioned here.

- 1 CROSSOVER** should be selected, if it isn't use the ▲▼ buttons to select it. Press ENTER.



- 2 Use the ▲▼ buttons to select frequency cut off point. Press ENTER.**

50 Hz: Sends bass frequencies below 50 Hz to the subwoofer (or large speakers).

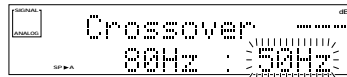

80 Hz: Sends bass frequencies below 80 Hz to the subwoofer (or large speakers).

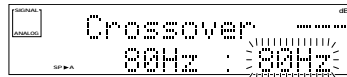

100 Hz: Sends bass frequencies below 100 Hz to the subwoofer (or large speakers).

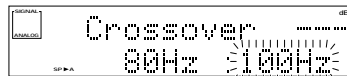

150 Hz: Sends bass frequencies below 150 Hz to the subwoofer (or large speakers).

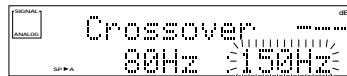

200 Hz: Sends bass frequencies below 200 Hz to the subwoofer (or large speakers).

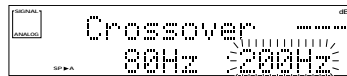

- 3 EXIT** should be selected (if it's not use the ▲▼ buttons to select it). Press ENTER.

Next, proceed to FINE CHANNEL LEVEL.

If you want to change a setting before proceeding

start over from step 1.



The default is 80Hz.

FINE CHANNEL LEVEL

The following steps show you how to balance the sound output level of your speakers more finely than in the NORMAL setup (see page 36). Proper speaker balance is essential for obtaining high quality surround sound and the better the speaker balance the better surround sound you can get. Do this procedure if you want to try and get even finer surround sound.

The main difference with this setup method and the CHANNEL LEVEL setup method in NORMAL setup is that here the test tone alternates between the front left speaker (which is used as the reference channel) and the target speaker (that is, the speaker whose level you want to adjust). Listen to the two tones and try to make them the same volume.

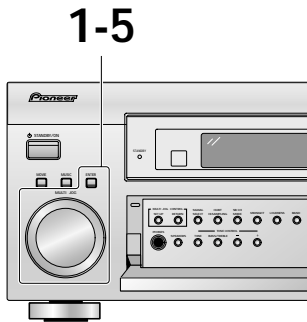
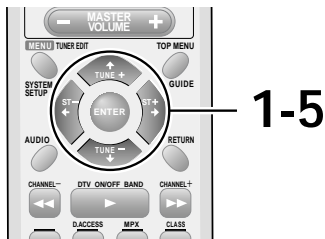

The adjustable channels are:

R (Front right), C (Center), LS (Surround left), RS (Surround right), SBL (Surround back left), SBR (Surround back right) and SW (Subwoofer).

3 Adjust the level of the channel using the ▲▼ buttons.



Try to get the volume level of the target speaker to match that of the front left speaker, which is the reference in this setup. The levels can be set within a range of -10 dB to +10 dB in 0.5 dB steps.

When you press ENTER you will automatically go to the next channel.

4 Press ENTER to select a new channel. Repeat step 3 for every channel.

If you want to change a setting before proceeding

Use the ▲▼ buttons to go back to the channel you want to adjust and press ENTER. Then follow step 3.

5 When done select EXIT (if it's not already selected) and press ENTER.

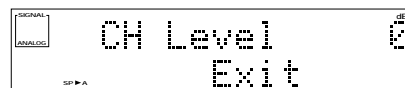

Next, if you want, proceed to FINE CHANNEL DELAY.

Follow steps 1-5 on page 79, if necessary, to get to the starting point mentioned here.

1 FINE CH LEVEL should be selected, if it isn't use the ▲▼ buttons to select it. Press ENTER.



2 Use the ▲▼ buttons to select the channel you want to adjust. Press ENTER.

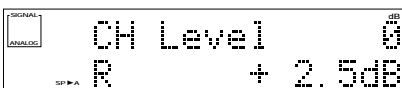

Test tones will be output.

WARNING : Be prepared! The test tones are output at a high volume level.

MASTER VOLUME rotates to the reference position (0 dB) and the display on the receiver flashes TEST TONE. After a few seconds the test tone is output.

Fine Tuning Your System

FINE CHANNEL DELAY

The following steps show you how to adjust the delay level of your speakers more finely than in the NORMAL setup (see page 36). Adding a slight delay to some speakers is necessary to achieve proper sound depth, separation as well as an effective surround sound effect. Do this procedure if you want to try and get even finer surround sound.

The main difference with this setup method and the CHANNEL DELAY setup method in NORMAL setup is that here the test tone sounds from a reference channel and you use that to measure the target speaker (that is, the speaker whose level you want to adjust).

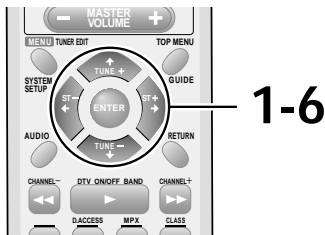

1-6

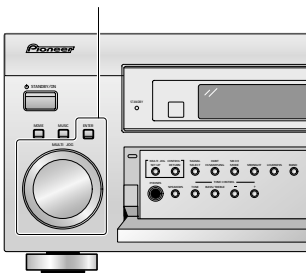

Follow steps 1-5 on page 79, if necessary, to get to the starting point mentioned here.

1 FINE CH DELAY should be selected, if it isn't use the ▲▼ buttons to select it. Press ENTER.

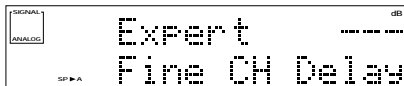

2 Use the ▲▼ buttons to adjust the distance of the FRONT L channel. Press ENTER.



Test tones will be output.
This channel will be the target distance which you use to measure the other channels.

3 Use the ▲▼ buttons to select the channel you want to adjust. Press ENTER.

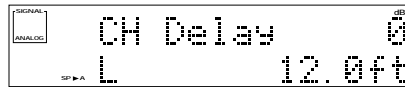

Test tones will be output.

The adjustable channels are:

R (Front right), C (Center), LS (Surround left), RS (Surround right), SBL (Surround back left), SBR (Surround back right) and SW (Subwoofer).

4 Adjust the level of each channel using the ▲▼ buttons.

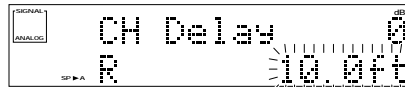

Listen to the reference channel and use it to measure the target channel. Stand facing the two speakers with your arms outstretched pointing at each speaker. Try to make the two tones sound as if they are arriving simultaneously at a position slightly in front of you and between your arm span.

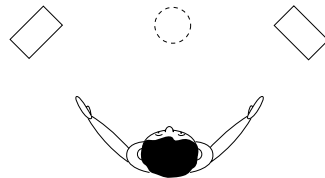

The distance can be set within a range of 0.5 to 45 feet in 0.5 foot steps.
When you press ENTER you will automatically go to the next channel.

5 Press ENTER to select a new channel. Repeat step 4 for every channel.

If you want to change a setting before proceeding

Use the ▲▼ buttons to go back to the channel you want to adjust and press ENTER. Then follow step 3.

6 When done select EXIT (if it's not already selected) and press ENTER.

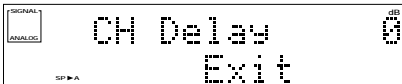

Next, if you want, proceed to ACOUSTIC CAL EQ.

ACOUSTIC CAL EQ

This setting is a kind of room equalizer for your speakers. This receiver let's you equalize the speakers in accordance with the front speakers.

The front left speaker will serve as the reference tone. The front left tone and the target speaker (the one you are trying to adjust) will sound in turns, so you can judge which needs to be louder.

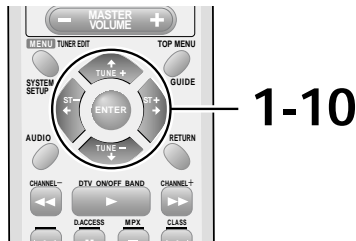

1-10

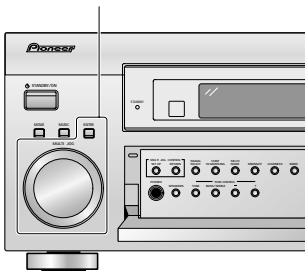

Follow steps 1-5 on page 79, if necessary, to get to the starting point mentioned here.

- 1 **ACOUSTIC CAL** should be selected, if it isn't use the ▲▼ buttons to select and press **ENTER**.

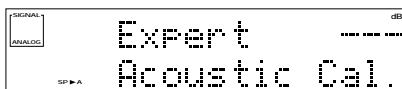

Test tones will be output.

WARNING: the test tones are very loud!!

Make sure there are no infants or small children in the room and that no one who will be scared, upset or damaged by loud noise is present. You yourself may want to wear earplugs.

ACOUSTIC CAL EQ: All speakers (except for the subwoofer) are set in accordance with the settings of the FRONT speakers. You can adjust each speaker individually to suit your taste. This setting allows the listener to enjoy a sound balance defined by the front speakers (the main speakers for home theater). The front left speaker will serve as the reference tone. The front left tone and the target speaker (the one you are trying to adjust) will sound in turns, so you can judge which needs to be louder.

- 2 Use the ▲▼ buttons to select the channel that you want to adjust. Press **ENTER**.

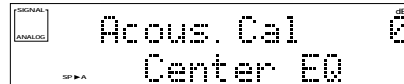

The adjustable channels are:

Center, Surround L, Surround R, Surr Back (surround back) L, Surr Back (surround back) R.

- 3 Use the ▲▼ buttons to select the frequency you want to adjust. Press **ENTER**.

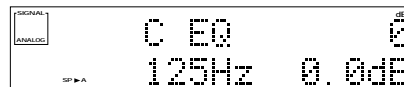

The adjustable frequencies are:

63Hz, 125Hz, 250Hz, 4kHz, 11.3kHz.

For the speakers you set to SMALL (see pages 37-38) you won't be able to adjust the 63 Hz setting.

- 4 Use the ▲▼ buttons to adjust the frequency. When you have it at the level you want press **ENTER**.

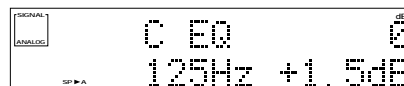

Set the frequencies within the -6 dB to +6 dB range in steps of 0.5 dB. If OVER appears in the display you have set the levels too high. Reduce them until OVER disappears.

- 5 The cursor automatically goes to the next frequency. Press **ENTER** and repeat steps 4 & 5 to adjust all the frequencies.

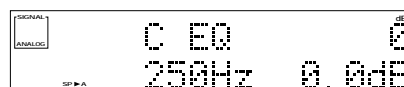

- 6 TRIM should be selected (if it isn't use the ▲▼ buttons to select it) and press ENTER.



- 7 Use the ▲▼ buttons to adjust the TRIM and press ENTER.

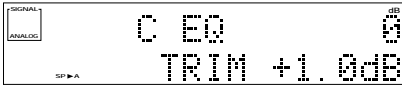

TRIM will balance the volume level of each frequency in the overall volume of that speaker.

- 8 EXIT should be selected (if it isn't use the ▲▼ buttons to select it) and press ENTER.



- 9 The cursor automatically goes to the next channel. Press ENTER and repeat steps 3–8 to adjust all the channels.

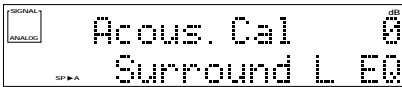

- 10 EXIT should be selected (if it isn't use the ▲▼ buttons to select it) and press ENTER.

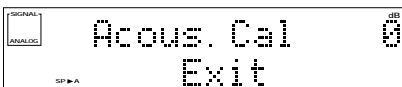

Next, if you want, proceed to BASS PEAK LEVEL.

BASS PEAK LEVEL

The LFE (Low Frequency Effect) channel in Dolby Digital and DTS program sources can produce heavily concentrated ultra-low bass tones that may exceed the capabilities of your speaker system. The following steps show you how to set the peak level for the LFE channel. If continuing from the preceding page the BASS PEAK LEVEL should be selected.

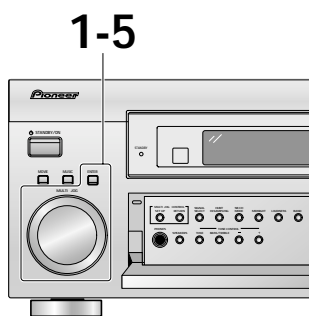
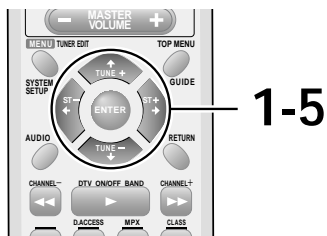

Follow steps 1-5 on page 79, if necessary, to get to the starting point mentioned here.

- 1 BASSPEAK LEVEL should be selected, if it isn't use the ▲▼ buttons to select it. Press ENTER.**

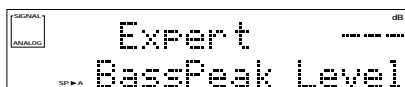

- 2 Use the ▲▼ buttons to select SETTING START or SETTING CANCEL. Press ENTER.**

SETTING START: The MASTER VOLUME is set to MIN (---dB), a test tone plays back and you make the setting (go to step 3).

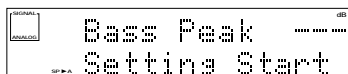

SETTING CANCEL: This setting won't limit the peak level of the LFE channel.

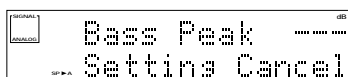

If you selected **SETTING CANCEL** go to step 4.

- 3 Use the ▲▼ buttons to adjust the test tones and specify the bass peak level.**

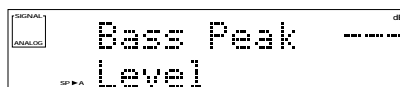

If you set this level before the receiver will have that level input but it will not appear on this setup screen. (The screen will always open with the level showing [- - -].)

- ① Raise the level gradually.
- ② Set the bass peak level at the point just before the tone starts to distort.

Be careful! Test tones play back at loud volumes . Make sure there are no infants or small children in the room at distortion level.

You can leave this setup any time by pressing ENTER.

If the YES or PLUS setting on the subwoofer is selected the test tone will only play back from the subwoofer. If not, the test tone will play back from all speakers set to LARGE except for the subwoofer.

- 4 Press ENTER.**

The display on the receiver will show RESUME and the MASTER VOLUME will return to its original position.

- 5 EXIT should be selected (if it isn't use the ▲▼ buttons to select it) and press ENTER.**

Next, if you want, proceed to DYNAMIC RANGE CONTROL

DYNAMIC RANGE CONTROL

This feature makes it possible to enjoy full surround sound effects on Dolby Digital and DTS sources even at low volumes. It does this by compressing the dynamic range. Dynamic range is the difference between the loudest and the softest sounds in any given signal. Compressing the range plays sounds so the quieter ones are audible and the louder ones don't get distorted or become overpowering. This feature only applies to Dolby Digital and DTS sources but the MIDNIGHT mode (explained on page 48) accomplishes the same end for a variety of sources. If continuing from BASS PEAK LEVEL, DYNAMIC RANGE CONTROL should be selected.

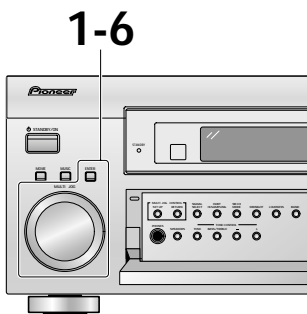
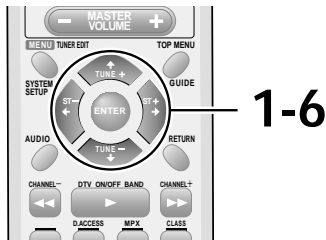

Follow steps 1-5 on page 79, if necessary, to get to the starting point mentioned here.

- 1 D-RANGE CTRL should be selected, if it isn't use the ▲▼ buttons to select it. Press ENTER.**

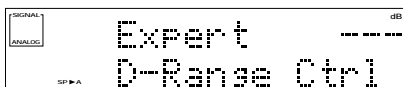

- 2 Use the ▲▼ buttons to choose either OFF, MID or MAX. Press ENTER.**



OFF: No Dynamic Range Control.
 MID: A moderate amount of Dynamic Range Control.
 MAX: The most Dynamic Range Control available is applied.

- 3 EXIT should be selected (if it isn't use the ▲▼ buttons to select it) and press ENTER.**

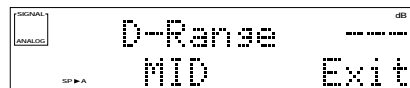

Dynamic Range Control is set. Go on to the next setting.

You may need to experiment with different Dolby Digital and DTS sources before you can use the DYNAMIC RANGE CONTROL setting to suit your low volume listening needs.

- 4 You are now finished with EXPERT SETUP, EXIT should be selected (if it isn't use the ▲▼ buttons to select it), press ENTER.**

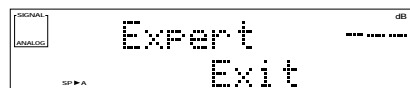

- 5 EXIT should be selected (if it isn't use the ▲▼ buttons to select it), press ENTER.**

- 6 Use the ▲▼ buttons to select EXIT, press ENTER.**

The receiver returns to normal operation.



The default is OFF.

Techno Tidbits & Problem-solving

Dolby



Dolby Digital

Dolby Digital is a discrete digital surround format used for multichannel surround sound. It was developed after the Dolby Surround System and Dolby Pro Logic Surround System. Dolby Digital is a high quality digital sound format that is used by many theatrical film releases.

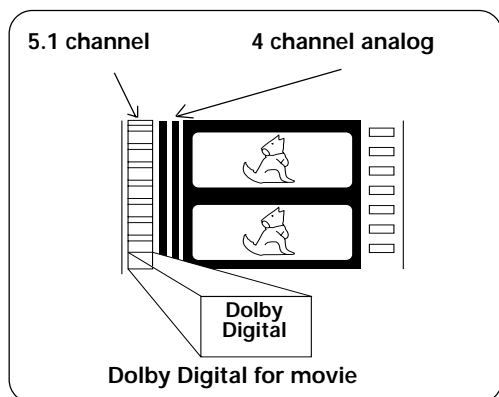

Soundtracks using linear PCM audio generate too much data for multichannel use. Dolby Digital technology was developed in response to the need for efficient multichannel digital sound. It uses masking technology and Adaptive Transform Coding, resulting in no audible loss of sound quality. In the present age of digital sound Dolby Digital is a standard audio format for DVD and has been adopted by HDTV broadcasts throughout the USA.

Other features include:

- 1) Downmixing on playback for compatibility with mono, stereo, Dolby Pro Logic and 5.1 channel audio.
- 2) A wide range of bitrates and channels.
- 3) Decoding dynamic range information and adjusting the dialog level in the soundtrack (called Dialog Normalization, see below for more information).

The advantages of the Dolby Digital system of encoding allow it to maintain its high quality sound while at the same time being very flexible, with the ability to handle many different types of soundtracks.

Dialog Normalization

When a Dolby Digital soundtrack is played back the Dialog Normalization function of the receiver activates automatically. Dialog Normalization is a Dolby Digital function that establishes the average dialog level for the program source being played. If the receiver's level does not match the average dialog level, first you see "DIAL NORM" and "OFFSET +4 dB" (as an example) appear in the receiver's display. In this example, the number +4 dB is the difference between the receiver's gain structure and the Dolby Digital average dialog level. To match the average dialog level, subtract or add the OFFSET level. For example, if the OFFSET level is +4 dB, the amplifier's output is 4 dB over the average recorded level.

Dolby Pro Logic II

Dolby Pro Logic II is an improved version of Dolby Pro Logic technology with extended matrix decoding technology that can create 5.1 channel sound from two channel sources. Dolby Pro Logic II creates basic 5 channel sound by using the innovative "steering logic" circuit. Therefore when listening to typical two-channel sources like CD, the listener can enjoy a richer spatial effect. When using software encoded with Dolby Surround, this decoding system affords the listener an improved surround experience with greater sound detail.

Chart Comparing Dolby Pro Logic and Dolby Pro Logic II

| | Pro Logic | Pro Logic II |
|------------------------|--------------------------------|--------------------------------|
| Effective sound source | Dolby Surround encoded sources | All two channel stereo sources |
| Surround Sound | Mono | Stereo |
| Frequency Range | Surround within 7kHz | All Channels/Full Range |

This unit has a three Dolby Pro Logic II functions. The first is "MOVIE Mode" (suitable for film soundtracks); "MUSIC Mode" (suitable for music); "Pro Logic Mode" (this mode is less sensitive to the quality of the source material, so may be useful when Movie Mode or Music Mode do not give good results). One can select one of them depending on your soundtrack of choice.

Dolby Digital Surround EX

This new recording technology is able to play 6.1 channel sound and was developed in a collaboration between Dolby Laboratories and Lucasfilm, Ltd. for the film "Stars Wars: The First Episode", the first movie ever to be made with Dolby Digital Surround EX technology. In a movie theater this format affords the listener vivid surround sound experience replete with the effect of sounds flying overhead, even for those seated towards the sides of the theater.

Dolby Digital Surround EX contains surround back channels which are dubbed into the soundtrack in the studio. The channels are encoded into the left and right channels of the soundtrack so this format can be compatible with Dolby Digital 5.1 channel decoding. For a list of movies that contain Dolby Digital Surround EX soundtracks see Dolby website at: <http://www.dolby.com>

THX Surround EX technology was developed for movie theater use originally but has been extended for home theater use and consumers can no benefit from this excellent, realistic sound format. (For more details see "THX Surround EX" on the next page.) This unit is equipped with a THX Surround EX decoder.

DTS



DTS

DTS has been adopted as a sound recording format in the movie theaters since the release of "JURASSIC PARK" in 1993, and has a good reputation for high quality sound and dynamic surround effects. In this system, 6 channels of digital sound are recorded on CD-ROM. DTS adopts a simultaneous playback format. With a low rate of compression of sound signals and a high rate of transmittance, a higher sound quality format is produced. For this reason, the format is being introduced in more and more movie theaters, and is being adopted for home use as DTS Digital Surround. When used with movies it's called DTS-LD DVD and for music software (5.1 channel CD) as DTS-CD.

DTS-ES

DTS launched a new surround format in November 2000. This has come to be known as DTS Extended Surround or simply DTS-ES. The technology has been advanced to include two new home formats DTS-ES Discrete 6.1 format, and DTS-ES Matrix 6.1 ch format, both are able to playback discrete, 6.1-channel content from DVDs and CDs. Both of these formats are compatible with a conventional DTS 5.1 ch decoder. In this system each channel is encoded and decoded individually, adding to the separation of the channels. Since DTS adds a third surround channel, the surround back channel, the realism and all-encompassing nature of the sound reaches levels not seen before in home theater. This unit is equipped with a DTS-ES decoder.

DTS Neo:6

This is a matrix decoding technology that transforms two-channel sources into 6.0 channel surround sound. There are two modes, CINEMA MODE and MUSIC MODE.

DTS 96/24

This high-quality format will be used for software which will be available from November, 2001. For compatibility with equipment that was produced before this format was made, DVD players can play this software using a conventional DTS 5.1ch decoder. This unit is equipped with a DTS 96 kHz/24 bit decoder to take advantage of the higher sound quality available.

THX®



THX is a Lucasfilm, Ltd. program dedicated to maximum accuracy in movie presentation. Movie sound tracks are recorded in large movie dubbing stages using movie theater equipment. For a sound track to be presented accurately in your home, special technologies are required. In your home the room is much smaller and has a bright sound, the speakers are very different and there are only six-eight of them, plus, you sit much closer to each one of those speakers. Because of these differences we often miss the power and emotion that thrills us in a good movie. Now Pioneer and THX have teamed up to bring the full glory of accurate cinema sound to the comfort and convenience of your home.

Re-Equalization™ : In a theater the room is very large and dead sounding, you sit a long way back from the speakers and the speakers themselves are very specialized. Because a sound track recorded in this dead sounding space when it is played at home it sounds overbright. THX Re-Equalization adjusts for this difference in a very precise way.

Adaptive Decorrelation™ : When a sound track sends mono sound to the surround speakers it often seems to be coming from one side instead of from all around you as it would in a theater. Adaptive Decorrelation helps to correct this inaccuracy.

Timbre Matching™ : When recording a sound track it is very important that the surround sounds move smoothly and seamlessly around the theater. It is very distracting when sounds seem to jump from speaker to speaker. Timbre Matching helps to smooth the movement of the surround sounds even though you are using only two speakers.

Bass Peak Level Manager™ : Some Dolby Digital sound tracks can produce bass peaks that are undesirable in a home theater environment. The Bass Peak Level Manager allows you to set the maximum peak levels appropriate to your system. (Set this function according to the **Bass Peak Level** instructions on page 86.)

Loudspeaker Position Time Synchronization™ : This feature allows you to adjust for the difference in the distance from each individual loudspeaker to the listening position. Doing this ensures that all the speakers operate in precise synchronization improving the seamless nature of the soundfield. (Set this function according to the **Channel Delay** instructions on page 40 and the **Fine Channel Delay** instructions on page 82-83.)

THX Surround EX™ : THX Surround EX-Dolby Digital Surround EX is a joint development of Dolby Laboratories and the THX division of Lucasfilm Ltd.

In a movie theater, film soundtracks that have been encoded with Dolby Digital Surround EX technology are able to reproduce an extra channel which has been added during the mixing of the program. This channel, called Surround Back, places sounds behind the listener in addition to the currently available front left, front center, front right, surround right, surround left and subwoofer channels. This additional channel provides the opportunity for more detailed imaging behind the listener and brings more depth, spacious ambience and sound localization than ever before.

When released to the home consumer market, movies that were created using the Dolby Digital Surround EX technology, may have a note to that effect on the packaging. A list of movies created using this technology can be found on the Dolby web site at <http://www.dolby.com>.

Only receiver and controller products bearing the THX Surround EX logo, when in the THX Surround EX mode, faithfully reproduce this new technology in the home.

This product may also engage the "THX Surround EX" mode during the playback of 5.1 channel material that is not Dolby Digital Surround EX encoded. In such case the information delivered to the Surround Back channel will be program dependent and may or may not be very pleasing depending on the particular soundtrack and the tastes of the individual listener.

Speaker Placement Information

Placement of your speakers is a crucial aspect of attaining accurate and realistic surround sound. Certain pointers concerning speakers stands, direction, angle and distance of speakers will be useful in this regard.

Firstly, it is best not to put your speakers directly on the floor. If you do this some of the sound vibration (especially bass) will go directly into the flooring and be lost. Instead we recommend using extremely hard objects (like cinder blocks) or designated speaker stands to support your speakers. Avoid placing the speakers on soft (like cushions or sofas) as these will also lead to sound loss and unstable surfaces (like flimsy shelving) as they may cause speaker accidents. In order to achieve a surround sound effect, make sure the speakers are a reasonable distance from your main listening position. Follow the diagrams and instructions below for optimum placement of each set of speakers.

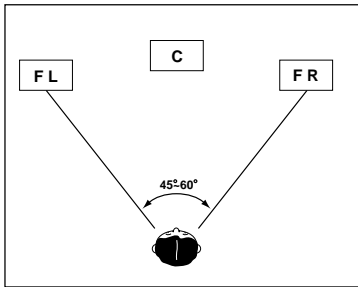

If you're using a CENTER speaker set the FRONT speakers to a wider angle. If not, set them to a narrower angle.

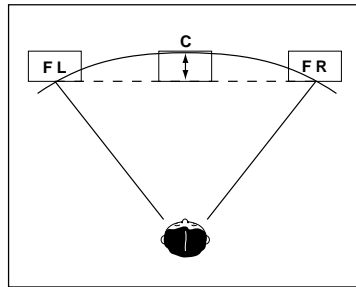

Make sure the CENTER speaker does not cross the forward plane of the FRONT speakers.

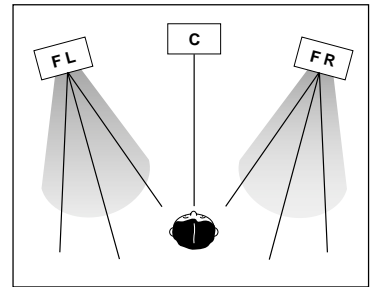

It is best to angle the speakers towards the listening position. The angle depends on the size of the room. Use less angle for bigger rooms.

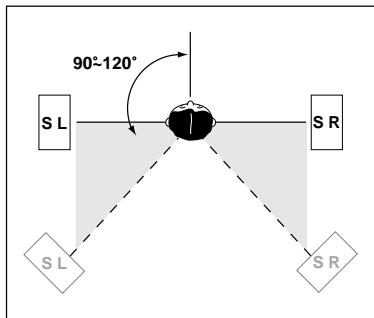

Surround speakers should be positioned a foot and a half to three feet higher than your ears and titled slight downward. Make sure the speakers don't face each other. For DVD Audio the speakers should be more directly behind the listener than for home theater playback.

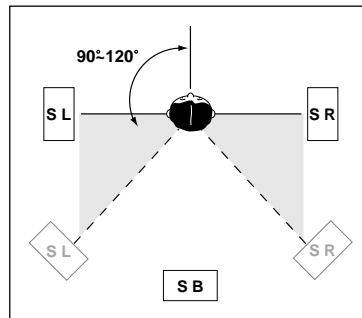

Surround back speakers should also be positioned a foot and a half to three feet higher than your ears and titled slight downward. Make sure the speakers don't face each other. For DVD Audio the speakers should be more directly behind the listener than for home theater playback.

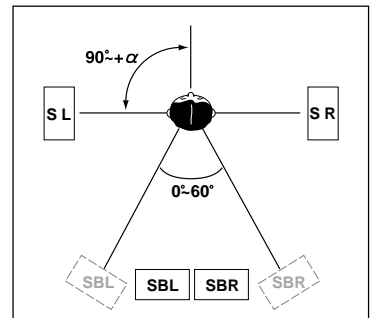

Speaker Placement for a Complete THX Speaker System

If you have a complete THX Speaker System set (LucasFilm authorized), follow the diagram below to place your speakers.

Notice the surround speakers should output at an angle parallel to the listener. Also, notice the angle of the front speakers.

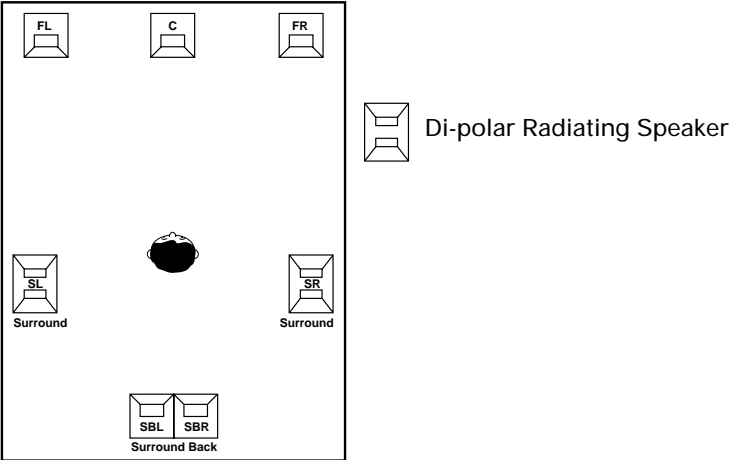

Speaker Placement for DVD-Audio (etc.) Sources

The best speaker placement for DVD-Audio (and other multichannel music sources) may be different than for regular DVD discs. For these formats follow the diagram at right as opposed to the home theater setups of the preceding pages.

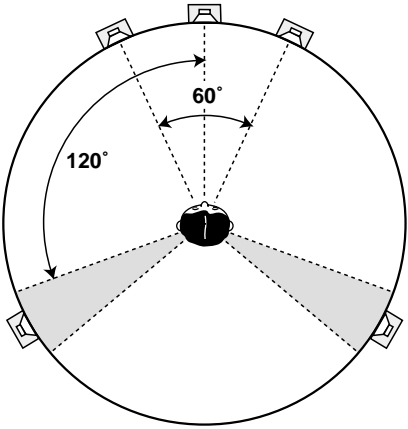

Preset Code List

You should have no problem controlling a component if you find the manufacturer in this list, but you can only set these codes for the button that is assigned to that component. So, for example, the TV codes can only be set to the TV or TVC button. Please note that there are cases where only certain functions may be controllable after assigning the proper preset code, or the codes for the manufacturer in the list will not work for the model that you are using. If you can't find a preset code that matches the component you want to control, you can still teach the remote individual commands from another remote control (page 60).

DVD

| Manufacturer | Code |
|--------------|------------------|
| TOSHIBA | 1010 |
| PANASONIC | 1002 |
| SONY | 1009 |
| JVC | 1005 |
| SAMSUNG | 1008 |
| RCA | 1007 |
| DENON | 1004 |
| PHILIPS | 1006 |
| TOSHIBA | 1010 |
| YAMAHA | 1011, 1012 |
| PIONEER | 1001, 1002, 1003 |

LD

| Manufacturer | Code |
|--------------|------------|
| SONY | 2008 |
| PHILIPS | 2006, 2007 |
| PANASONIC | 2005 |
| KENWOOD | 2004 |
| DENON | 2003 |
| YAMAHA | 2009 |
| PIONEER | 2001, 2002 |

TV

| Manufacturer | Code |
|---------------|------------------------------------------------------------|
| PIONEER | 5001, 5002, 5003, 5004, 5005, 5006, 5007, 5008, 5009, 5010 |
| ADMIRAL | 5011, 5012, 5013 |
| AIWA | 5014, 5015 |
| AKAI | 5016 |
| ALBA | 5017 |
| AOC | 5018 |
| BESTAR | 5019 |
| BLAUPUNKT | 5020 |
| BLUE SKY | 5021 |
| BRANDT | 5022 |
| BROSCONIC | 5023 |
| BUSH | 5024 |
| CLATRONIC | 5025 |
| CRAIG | 5026, 5027, 5028, 5029 |
| CROSLEX | 5030 |
| CURTIS MATHIS | 5031, 5032, 5033 |
| DAEWOO | 5034, 5035, 5036, 5037, 5038, 5039 |
| DAYTRON | 5040 |
| DUAL | 5041 |
| EMERSON | 5042, 5043, 5044, 5045, 5046, 5047, |

| | |
|------------------------|------------------------------|
| 5045, 5046, 5047, 5048 | |
| FERGUSON | 5049, 5050 |
| FIRST | 5051 |
| FISHER | 5052 |
| FUJITSU | 5053 |
| FUNAI | 5054, 5055, 5056 |
| GE | 5057, 5058, 5059, 5060 |
| GOLDSTAR | 5061, 5062, 5063, 5064 |
| GOODMANS | 5065, 5066 |
| HITACHI | 5067, 5068, 5069, 5070, 5071 |
| ICE | 5072 |
| IRRADIO | 5073 |
| ITT/NOKIA | 5074, 5075 |
| JC PENNY | 5076, 5077, 5078, 5079 |
| JVC | 5080, 5081 |
| KENDO | 5082 |
| KTV | 5083, 5084 |
| LOEWE | 5085 |
| LXI | 5086, 5087, 5088, 5089, 5090 |
| MAGNAVOX | 5091 |
| MARK | 5092 |
| MATSUI | 5093, 5094 |
| MATSUSHITA | 5095, 5096 |
| MEDIAON | 5097 |
| mitsubishi | 5098, 5099 |
| MIVAR | 5100 |
| NEC | 5101, 5102 |
| NOKIA OCEANIC | 5103 |
| NORDMENDE | 5104, 5105 |
| OKANO | 5106 |
| ONWA | 5107 |
| PANASONIC | 5108, 5109, 5110, 5111 |
| PHILCO | 5112, 5113, 5114 |
| PHILLIPS | 5004 |
| PHONOLA | 5115 |
| PORTLAND | 5116, 5117 |
| PROSCAN | 5118 |
| QUASAR | 5119, 5120 |
| RADIO | 5121, 5122 |
| RADIO SHACK | 5123, 5124, 5125 |
| RADIOLA | 5126 |
| RCA/PROSCAN | 5127, 5128, 5129 |
| SABA | 5130 |
| SAMSUNG | 5131, 5132 |
| SANYO | 5133, 5134, 5135 |
| SCHNEIDER | 5136 |
| SCOTT | 5137, 5138 |
| SHARP | 5139, 5140 |
| SIEMENS | 5141 |

| | |
|------------|------------------|
| SIGNATURE | 5142, 5143 |
| SONY | 5144, 5145 |
| SYLVANIA | 5146, 5147 |
| SYMPHONIC | 5148 |
| TATUNG | 5149 |
| TELEFUNKEN | 5150, 5151 |
| THORN | 5152 |
| TOSHIBA | 5153, 5154 |
| UNIVERSUM | 5155 |
| VIDECH | 5156, 5157 |
| W. WHOUSE | 5158 |
| WARDS | 5159, 5160, 5161 |
| WATSON | 5162 |
| ZENITH | 5163, 5164 |

VCR

| | |
|----------------|------------------------------------|
| PIONEER | 3001, 3002, 3003, 3004, 3005 |
| ADMIRAL | 3006 |
| AIWA | 3007, 3008, 3009 |
| AKAI | 3010, 3011 |
| ALBA | 3012 |
| AUDIO DYNAMIC | 3013, 3014 |
| BELL&HOWELL | 3015 |
| BLAUPUNKT | 3016, 3017 |
| BROSCONIC | 3018, 3019 |
| BUSH | 3020 |
| CANON | 3021 |
| CGM | 3022, 3023 |
| CITIZEN | 3024 |
| CLATRONIC | 3025 |
| CRAIG | 3026 |
| CURTIS MATHIS | 3027, 3028, 3029 |
| DAEWOO | 3030, 3031, 3032 |
| DBX | 3033, 3034 |
| DIMENSIA | 3035 |
| EMERSON | 3036, 3037, 3038, 3039, 3040, 3041 |
| FERGUSON | 3042 |
| FISHER | 3043, 3044, 3045, 3046 |
| FUNAI | 3047, 3048 |
| GE | 3049, 3050, 3051 |
| GOLDSTAR | 3052 |
| GOODMANS | 3053, 3054 |
| GRUNDIG | 3055 |
| HITACHI | 3056, 3057, 3058, 3059, 3060 |
| INSTANT REPLAY | 3061, 3062 |
| ITT/NOKIA | 3063 |
| JC PENNY | 3064, 3065, 3066, 3067, 3068, 3069 |
| JVC | 3070, 3071, 3072 |
| KENDO | 3073 |
| KENWOOD | 3074, 3075, 3076 |

Techno Tidbits & Problem-solving

| | |
|---------------|------------------------------------------------|
| LOEWE | 3077, 3078 |
| LUXOR | 3079 |
| LXI | 3080, 3081, 3082, 3083, 3084, 3085, 3086 |
| MARANTZ | 3087, 3088 |
| MARTA | 3089 |
| MATSUI | 3090 |
| MEMOREX | 3091, 3092 |
| MINOLTA | 3093, 3094 |
| MITSUBISHI | 3095, 3096, 3097, 3098, 3099 |
| MULTITECH | 3100, 3101, 3102 |
| NEC | 3103 |
| NOKIA OCEANIC | 3104 |
| NOKIA | 3105, 3106 |
| NORDMENDE | 3107 |
| OKANO | 3108 |
| OLYMPIC | 3109, 3110 |
| ORION | 3111 |
| PANASONIC | 3112, 3113, 3114, 3115, 3116, 3117 |
| PENTAX | 3118, 3119 |
| PHILCO | 3120, 3121 |
| PHILIPS | 3122 |
| PHONOLA | 3123 |
| QUASAR | 3124, 3125 |
| RCA/PROSCAN | 3126 |
| REALISTIC | 3127, 3128, 3129, 3130, 3131, 3132 |
| SABA | 3133 |
| SAMSUNG | 3134, 3135 |
| SANSUI | 3136 |
| SANYO | 3137, 3138 |
| SCHNEIDER | 3139, 3140 |
| SCOTT | 3141, 3142, 3143, 3144, 3145, 3146, 3147 |
| SEG | 3148 |
| SELECO | 3149 |
| SHARP | 3150, 3151, 3152 |
| SIEMENS | 3153, 3154, 3155 |
| SIGNATURE | 3156, 3157 |
| SONY | 3158, 3159, 3160, 3161, 3162, 3163 |
| SYLVANIA | 3164, 3165, 3166, 3167 |
| SYMPHONIC | 3168 |
| TANDBERG | 3169 |
| TASHIRO | 3170 |
| TATUNG | 3171, 3172 |
| TEAC | 3173, 3174, 3175 |
| TECHNICS | 3176, 3177 |
| TELEFUNKEN | 3178, 3179 |
| THORN | 3180, 3181 |
| TOSHIBA | 3182, 3183, 3184 |
| UNIVERSUM | 3185, 3186, 3187 |
| W. WHOUSE | 3188 |
| WARDS | 3189, 3190, 3191, 3192, 3193 |
| YAMAHA | 3194, 3195, 3196 |
| ZENITH | 3197 |

STB

| | |
|--------------------|---------------------------------------|
| PIONEER | 6001, 6002, 6003, 6004, 6005, 6006 |
| BELL | 6049 |
| BLAUPUNKT | 6007 |
| EHOSTAR | 6047 |
| GENERAL INSTRUMENT | 6008 |
| GOLDSTAR | 6009 |
| GRUNDIG | 6010, 6011 |
| HAMLIN | 6012, 6013 |
| HNS/HUGHES | 6014 |
| HITACHI | 6015 |
| ITT/NOKIA | 6016 |
| JERROLD | 6017, 6018, 6019 6020, 6021 |
| NEC | 6022, 6023 |
| OAK | 6024, 6025, 6026 |
| PANASONIC | 6027, 6028, 6029 |
| PHILIPS | 6030, 6031 |
| PRIMESTAR | 6048 |
| RADIO SHACK | 6032 |
| RCA | 6033 |
| SAMSUNG | 6034, 6035 |
| SCIENTIFIC ATLANTA | 6036, 6037, 6038 |
| SIEMENS | 6039, 6040 |
| SONY | 6041 |
| STAR CHOICE | 6048 |
| TOSHIBA | 6042, 6043 |
| TOCOM | 6044 |
| ZENITH | 6045, 6046 |

CD/CD-R

| | |
|-----------|---------------------------------|
| PIONEER | 7001, 7002 |
| DENON | 7003, 7004, 7005 |
| FISHER | 7006, 7007 |
| JVC | 7008, 7009, 7010, 7011 |
| KENWOOD | 7012, 7013, 7014, 7015, 7016 |
| MAGNAVOX | 7017, 7018 |
| MARANTZ | 7019 |
| ONKYO | 7020, 7021 |
| PANASONIC | 7022, 7023 |
| PHILIPS | 7024, 7025 |
| RCA | 7026, 7027 |
| SANYO | 7028 |
| SHARP | 7029 |
| SONY | 7030 |
| TEAC | 7031, 7032, 7033 |
| TECHNICS | 7034, 7035 |
| YAMAHA | 7036, 7037, 7038, 7039 |
| DENON | 7040, 7041 |
| JVC | 7042 |
| KENWOOD | 7043 |
| PHILIPS | 7044 |
| SONY | 7045 |

DVR

| | |
|---------|------|
| PIONEER | 4001 |
|---------|------|

MD

| | |
|---------|------------------|
| PIONEER | 8001, 8002, 8003 |
| DENON | 8004 |
| JVC | 8005 |
| KENWOOD | 8006 |
| SONY | 8007 |
| SHARP | 8002 |
| YAMAHA | 8008, 8009 |

TAPE

| | |
|-----------|---------------------------|
| PIONEER | 9001, 9002 |
| DENON | 9003, 9004 |
| FISHER | 9005, 9006 |
| JVC | 9007, 9008 |
| KENWOOD | 9009, 9010, 9011 |
| NAKAMICHI | 9012 |
| ONKYO | 9013, 9014, 9015 |
| PHILIPS | 9016, 9017 |
| SONY | 9018, 9019 |
| TEAC | 9020, 9021 |
| TECHNICS | 9022 |
| YAMAHA | 9023, 9024, 9025, 9026 |

Troubleshooting

Incorrect operations are often mistaken for trouble and malfunctions. If you think that there is something wrong with this component, check the points below. Sometimes the trouble may lie in another component. Investigate the other components and electrical appliances being used. If the trouble cannot be rectified even after exercising the checks listed below, ask your nearest PIONEER authorized service center or your dealer to carry out repair work.

| Symptom | Cause | Remedy |
|---------------------------------------------------------------------------------------------------------------------------------|-------------------------------------------------------------------------------------------------------------------------------------------------------------------------------------------------------------------------------------------------------|--------------------------------------------------------------------------------------------------------------------------------------------------------------------------------------------------------------------------------------------------------------------------------------------------------------------------------------------------------------------------------------------------------------------|
| Power | | |
| The power does not turn on. | <ul style="list-style-type: none"> The power plug is disconnected. The protection circuit may have been activated. | <ul style="list-style-type: none"> Connect the power plug to the wall outlet. Disconnect the power plug from the outlet, and insert again. |
| During loud playback the power suddenly switches off. | <ul style="list-style-type: none"> The protection circuit has been activated because the lowest actual impedance of the speakers (as opposed to the speakers' rated impedance) is dangerously low. | <ul style="list-style-type: none"> Turn down the volume. When it's convenient go to ACOUSTIC CALIBRATION EQ (page 84–85) and lower the 63 Hz and 125 Hz equalizer levels using MANUAL setting. |
| The unit does not respond when the buttons are pressed. | <ul style="list-style-type: none"> Static electricity caused by dry air. | <ul style="list-style-type: none"> Switch the unit off, then on again. Disconnect the power plug from the outlet, and insert again. |
| During operation, the unit suddenly switches off. | <ul style="list-style-type: none"> The speaker wires are frayed or sticking out of the jack, and are touching the back of the receiver or another set of wires. | <ul style="list-style-type: none"> Reinsert the speaker wires, making sure there are no stray strands of wire and that they are inserted fully (see page 24) |
| AMP ERR blinks in the display and the unit turns off. The STANDBY indicator will blink and the unit cannot be turned on. | <ul style="list-style-type: none"> The receiver probably has a serious problem. | <ul style="list-style-type: none"> Don't try to turn on the receiver. Call a Pioneer-accredited repair center to look at the problem. |
| FAN STOP blinks in the display and the unit turns off. | <ul style="list-style-type: none"> Something is stuck in the fan and/or the fan is broken. | <ul style="list-style-type: none"> Remove the foreign object from the fan. If you can't do this and/or the fan is broken call a Pioneer-accredited repair center to look at the problem. |
| OVERHEAT blinks in the display and no sound is output. | <ul style="list-style-type: none"> The receiver has gotten too hot. | <ul style="list-style-type: none"> Turn the receiver off and allow it to cool down with good ventilation. It is very likely that you have a heat dispersal and ventilation problem so please follow the instructions in "Installing the Receiver" (page 8) carefully. |
| THDCT NG blinks in the display and the unit turns off. | <ul style="list-style-type: none"> The thermistor (temperature sensor) is broken. | <ul style="list-style-type: none"> Turn the receiver off, unplug from wall and call a Pioneer-accredited repair center to look at the problem. |
| Setup | | |
| After the proper settings have been made, there still seems to be something wrong with the sound. | <ul style="list-style-type: none"> The speakers have been incorrectly connected (+/- connections are reversed). | <ul style="list-style-type: none"> Check all connections (see page 24). |
| No audio | | |
| No sound is output when a function is selected. | <ul style="list-style-type: none"> Improper connections. Sound is muted. The volume is turned down. Speakers are turned off. DIGITAL/ANALOG setting is incorrect. MULTI CH IN mode is on. | <ul style="list-style-type: none"> Make sure the component is connected correctly (see pages 15–22). Press MUTING on the remote control. Adjust MASTER VOLUME. Press SPEAKERS (A/B) to select the speakers you connected (see page 66). Select the proper signal with the SIGNAL SELECT button (see page 42). Turn MULTI CH IN mode off (see page 50). |

Techno Tidbits & Problem-solving

| Symptom | Cause | Remedy |
|---------------------------------------------------------------------------------|-----------------------------------------------------------------------------------------------------------------------------------------------------------------------------------------------------------------------------------------------------------------------------------------------------------------------------------------------------------------------------------------------------------------------------------------------------------------------------------------------------------------------------------|---------------------------------------------------------------------------------------------------------------------------------------------------------------------------------------------------------------------------------------------------------------------------------------------------------------------------------------------------------------------------------------------------------------------------------------------------------------------------------------------------------------------------------------------------------------------------------------------------------------------------------------------------------------------------------------------------------------------------------------------------------------------------------------------------|
| No sound output from the front speakers. | <ul style="list-style-type: none"> The front speakers are connected to the B speaker system jack. | <ul style="list-style-type: none"> Connect the front speakers to the A speaker system jacks (see page 24). |
| No sound output from surround or center speakers. | <ul style="list-style-type: none"> Speaker settings are incorrect. The surround and/or center speakers are disconnected. The listening mode is STEREO. | <ul style="list-style-type: none"> See SPEAKER SETTING on pages 37–38 to check the speaker settings. Connect the speakers (see page 24). Choose a surround listening mode (see pages 43–45). |
| No sound output from the subwoofer. | <ul style="list-style-type: none"> The subwoofer setting is NO. The subwoofer output setting is too low. The bass peak level setting is too low. There is very little low frequency information in your source. The crossover frequency is set too low. There is a problem with the subwoofer. The subwoofer isn't connected properly. | <ul style="list-style-type: none"> Change the setting to YES or PLUS (see page 37–38). Adjust the output setting to the level you want (see pages 39, 81). Adjust the peak level setting to the level you want. Change your subwoofer setting to one of the following (see pages 37–38): Front: SMALL Subwoofer: YES Front: LARGE Subwoofer: PLUS Raise the frequency level to match your speakers' characteristics (see page 80) Check the three following points: <ul style="list-style-type: none"> Check the power. Check the subwoofer volume control . Check the subwoofer hasn't automatically switched to standby mode (check the subwoofer manual) Check all connections. |
| No sound output from the surround back speakers. | <ul style="list-style-type: none"> The SB CH MODE is set to OFF. The source is not a 6.1 channel playback source. The surround back speakers aren't connected properly. The surround back channel is set to 1 speaker setting only, and the speaker is connected to the right channel output. | <ul style="list-style-type: none"> Set the SB CH MODE to ON or AUTO (see page 51). Set the SB CH MODE to ON or AUTO and choose one of the SURROUND listening modes (see pages 44–45, 51). Check all connections (see pages 15–22). Connect the speaker to the surround back left channel output (see page 24). |
| No sound output from one (set of) speaker(s). | <ul style="list-style-type: none"> The speaker system setting is NO. The speaker isn't connected properly. The source has no sound output for that channel. The speaker output level is set too small. | <ul style="list-style-type: none"> Change the speaker setting to YES (see pages 37–38). Check all connections. If you choose one of the SURROUND listening modes, a channel may be created for the speaker (see pages 44–45). Increase the speaker output level. |
| Sound is produced from some components, but not from digital components. | <ul style="list-style-type: none"> SIGNAL SELECT is set incorrectly. The digital inputs are assigned incorrectly, or not at all. The digital components aren't connected properly. The player is not compatible with the source you're using, or the player settings are incorrect. The MULTI CH IN mode has been selected. The digital output level has been turned down on a CD player or other component equipped with digital output level adjustment capability. | <ul style="list-style-type: none"> Set SIGNAL SELECT to AUTO or according to the type of connections made (see page 42). Set the digital input settings correctly (see page 76). Check all connections (see page 24). Choose a compatible source, or check the player's manual for the correct settings. Choose one of the listening modes (see page 41). The MULTI CH IN switches off automatically. Set the digital volume level of the player to full, or to the neutral position. |

| Symptom | Cause | Remedy |
|---------------------------------------------------------------------------------------------------|-----------------------------------------------------------------------------------------------------------------------------------------------------------------------------------------------------------------------------------------------------------------------------------------|----------------------------------------------------------------------------------------------------------------------------------------------------------------------------------------------------------------------------------------------------------------------------------------------------------------------------------------------------|
| Other audio problems | | |
| Subwoofer output is very low. | <ul style="list-style-type: none"> • Settings route signal away from subwoofer. | <ul style="list-style-type: none"> • To get more signal to the subwoofer set it to PLUS or choose SMALL for the front speakers (see pages 37–38). |
| During multi channel playback, there is no sound output from one speaker. | <ul style="list-style-type: none"> • That speaker is set to NO. | <ul style="list-style-type: none"> • Set the speaker to YES. |
| A multi channel DVD source appears to be downmixed from 2 channels during playback. | <ul style="list-style-type: none"> • The source is coming from something other than the MULTI CH IN jacks (for example, digital PCM output, etc.) | <ul style="list-style-type: none"> • Check the MULTI CH IN connection (see page 20) and select the type of playback with the MULTI CH IN button (see page 50). |
| Considerable noise in radio broadcasts. | <ul style="list-style-type: none"> • Incorrect frequency. • The antenna is not connected. • Digital cables are near the antenna terminals and wires. | <ul style="list-style-type: none"> • Tune in the correct frequency. • Connect the antenna (see page 23). • Route digital cables away from the antenna terminals and wires. |
| Broadcast stations cannot be selected automatically. | <ul style="list-style-type: none"> • The antenna is poorly positioned. • Interference caused by other equipment (fluorescent lamp, motor, etc.). • Weak radio signals. | <ul style="list-style-type: none"> • Adjust the direction and position for best reception. • Turn off the equipment causing the noise or move it away from the receiver. • Place the antenna farther away from the equipment causing the noise. • Connect an outdoor AM or FM antenna (see page 23). |
| Noise or hum can be heard even when there is no sound being input. | <ul style="list-style-type: none"> • There is electrical interference from another component or appliance. | <ul style="list-style-type: none"> • Check that personal computers or other digital components connected to the same power source are not causing interference. |
| When a search is performed by a DTS compatible CD player during playback, noise is output. | <ul style="list-style-type: none"> • The search function performed by the player interferes with the reading of digital information. | <ul style="list-style-type: none"> • This is not a malfunction, but be sure to turn the volume down to prevent the output of loud noise from your speakers. |
| When playing a DTS format LD there is noise audible on the soundtrack. | <ul style="list-style-type: none"> • The SIGNAL SELECT is on ANALOG. | <ul style="list-style-type: none"> • Set the SIGNAL SELECT to DIGITAL (see page 42). |
| Audio doesn't record (in some cases, even if video does). | <ul style="list-style-type: none"> • You are trying to make an analog recording from a digital signal, or a digital recording of an analog source. • The digital source is copy protected. • The jacks for recording have not been connected properly. | <ul style="list-style-type: none"> • You can only record analog to analog, or digital to digital. Make sure the playback and recording components are hooked up with the same kind of connections. • You can't record digital sources that have been copy protected. • Check connections (see pages 19 & 21). |

Techno Tidbits & Problem-solving

| Symptom | Cause | Remedy |
|---------------------------------------------------------------------------------------------------------------------|-----------------------------------------------------------------------------------------------------------------------------------------------------------------------------------------------------------------------------------------------------------------------------------------------------------------------------------------------------------|-----------------------------------------------------------------------------------------------------------------------------------------------------------------------------------------------------------------------------------------------------------------------------------------------------------------------------------------------------------------------------------------------------------------------------|
| Video | | |
| No image is output when a function is selected. | <ul style="list-style-type: none"> Improper connections. The input source is not properly selected. The video input selected on the TV monitor is incorrect. The TV or monitor is hooked up with cord that is different than that used for the video player. The component video setting is incorrect. | <ul style="list-style-type: none"> Make sure the component is connected correctly (see pages 15,16-18). Press the correct function button. Please read the TV monitor manual and change the settings accordingly. Use the same cable to connect to your TV and all your video equipment (see pages 15-22). Select the correct COMPONENT-IN SELECT setting (see page 77). |
| There is no image coming from the selected component video jacks. | <ul style="list-style-type: none"> The type of cord connected to the TV doesn't match your video input settings. | <ul style="list-style-type: none"> Change the settings to match the cord connected (see pages 15-22). |
| Can't record video. | <ul style="list-style-type: none"> The source is copy protected. You are trying to record a source connected to the component video jacks. The recorder's video input is hooked up using a different type of cord to the source video output. | <ul style="list-style-type: none"> You can't record sources that have been copy protected. Connect the component with S video or composite video cords (see pages 16-18). Hook up the source and the recorder using the same type of video cord (see pages 16-18). |
| Input/display | | |
| The display is dark. | <ul style="list-style-type: none"> The display DIMMER button is pushed. | <ul style="list-style-type: none"> Press DIMMER on the remote control repeatedly to return to the default setting (see page 53). |
| You can't get DIGITAL to come up when using the SIGNAL SELECT button. | <ul style="list-style-type: none"> Either the digital connections or the DIGITAL IN SELECT is incorrect. MULTI CH IN mode is on. | <ul style="list-style-type: none"> Make sure the digital connections (see page 16-18 & 21) and the DIGITAL-IN SELECT (see page 76) are done correctly. Turn MULTI CH IN mode off (see page 50). |
| The digital format indicator doesn't light up even when playing a non-PCM digital source. | <ul style="list-style-type: none"> The player is paused or stopped. There is a mistake in the player settings for audio output. | <ul style="list-style-type: none"> Play the source. Fix the audio settings (check the manual that came with your DVD player). |
| A compressed digital source is being played, but the digital format indicators don't light up. | <ul style="list-style-type: none"> Although it's a non-PCM digital source there is a possibility the present track is not the proper format (5.1, 6.1, or 7.1 channel). | <ul style="list-style-type: none"> There is no problem. The indicator won't light when the track is not a compressed digital source. |
| During playback of a compressed digital source, the PRO LOGIC II or NEO:6 indicators show in the display. | <ul style="list-style-type: none"> The digital signal is not being sent with the source. The audio is in two channel format. It has already been Dolby surround encoded. | <ul style="list-style-type: none"> Choose DIGITAL or AUTO with the signal select button (see page 42). This is not a malfunction. Check the manufacturer information for the source. |
| During playback of a Surround EX or DTS ES source on the AUTO setting, the EX and ES indicators won't light. | <ul style="list-style-type: none"> The source may be 6.1 playback compatible, but there is no signal from the source to indicate this. | <ul style="list-style-type: none"> Switch the SB CH MODE to ON (see page 51). |

| Symptom | Cause | Remedy |
|---------------------------------------------------------------------------------------------------------------------|---------------------------------------------------------------------------------------------------------------------------------------------------------------------------------------------------------------------------------------------------------------------------------------------------------------------------------------------------------------------------------------------------------------------------------------------------------------------------------------------|---------------------------------------------------------------------------------------------------------------------------------------------------------------------------------------------------------------------------------------------------------------------------------------------------------------------------------------------------------------------------------------------------------------------------------------------------------------------------------------------------------------------------|
| During playback of a DVD audio source, the player shows a transfer rate of 96kHz, but the receiver does not. | <ul style="list-style-type: none"> The multichannel connections are analog, so there is no digital transfer. | <ul style="list-style-type: none"> This is not a malfunction. See the player's manual for more details. |
| During playback of a 96kHz source, the display doesn't show 96kHz | <ul style="list-style-type: none"> The receiver may be on a different mode than STEREO. One of the DIGITAL NR, MIDNIGHT, LOUDNESS, or TONE features is switched on. | <ul style="list-style-type: none"> Switch to STEREO mode (see page 43). Turn it/them off (see page 47–49). |
| Remote control | | |
| Cannot be remote controlled. | <ul style="list-style-type: none"> The remote control batteries have worn out. Too far away or improper angle of operation. There is an obstacle between the receiver and the remote control. Strong light such as fluorescent light is shining onto the unit's remote control signal light-receiving window. A cord is connected to the CONTROL IN terminal on this unit. The IR Receiver type is mismatched with the setting. | <ul style="list-style-type: none"> Replace the batteries (see page 7). Operate within 25 feet and a 30° angle of the remote sensor on the front panel (see page 8). Remove the obstacle or operate from another position (see page 8). Avoid exposing the remote sensor on the front panel to direct light. Connect cord to the correct jack. Disconnect the IR Receiver from the rear panel, and set to the other IR Receiver type using the remote control. |
| Other components can't be operated with the system remote. | <ul style="list-style-type: none"> The preset code settings are wrong. The batteries wore out and the system settings were cleared. | <ul style="list-style-type: none"> Input the correct preset code. Reset the proper system settings. |
| The SR cable is connected, but the connected components can't be operated with the remote. | <ul style="list-style-type: none"> The SR cable hasn't been connected properly. The rest of the component connection have not been made. The component you have hooked up is not SR compatible. | <ul style="list-style-type: none"> Reinsert the SR cable, making sure it is the right jack (see page 71). Make sure an analog connection has been made between the units. This is not a malfunction. |

If the unit does not operate normally due to external effects such as static electricity

Disconnect the power plug from the outlet and insert again to return to normal operating conditions.

Schemata of Setup

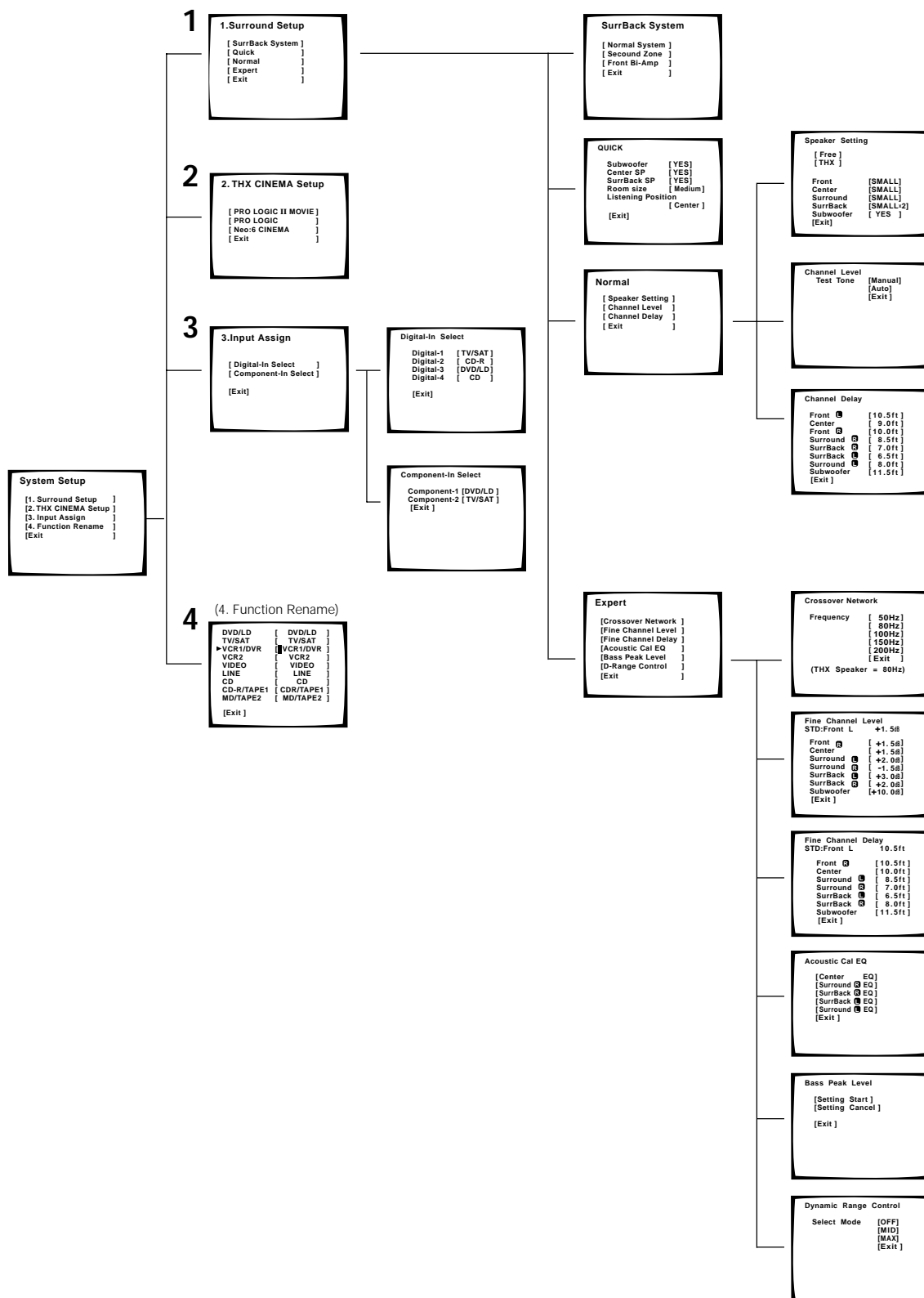



Dear Customer:

Selecting fine audio equipment such as the unit you've just purchased is only the start of your musical enjoyment. Now it's time to consider how you can maximize the fun and excitement your equipment offers. This manufacturer and the Electronic Industries Association's Consumer Electronics Group want you to get the most out of your equipment by playing it at a safe level. One that lets the sound come through loud and clear without annoying blaring or distortion-and, most importantly, without affecting your sensitive hearing.

Sound can be deceiving. Over time your hearing "comfort level" adapts to higher volumes of sound. So what sounds "normal" can actually be loud and harmful to your hearing. Guard against this by setting your equipment at a safe level BEFORE your hearing adapts.

To establish a safe level:

- Start your volume control at a low setting.
- Slowly increase the sound until you can hear it comfortably and clearly, and without distortion.

Once you have established a comfortable sound level:

- Set the dial and leave it there.

Taking a minute to do this now will help to prevent hearing damage or loss in the future. After all, we want you listening for a lifetime.

We Want You Listening For A Lifetime

Used wisely, your new sound equipment will provide a lifetime of fun and enjoyment. Since hearing damage from loud noise is often undetectable until it is too late, this manufacturer and the Electronic Industries Association's Consumer Electronics Group recommend you avoid prolonged exposure to excessive noise. This list of sound levels is included for your protection.

Decibel

| <u>Level</u> | <u>Example</u> |
|--------------|-------------------------------------------------------------------|
| 30 | Quiet library, soft whispers |
| 40 | Living room, refrigerator, bedroom away from traffic |
| 50 | Light traffic, normal conversation, quiet office |
| 60 | Air conditioner at 20 feet, sewing machine |
| 70 | Vacuum cleaner, hair dryer, noisy restaurant |
| 80 | Average city traffic, garbage disposals, alarm clock at two feet. |

THE FOLLOWING NOISES CAN BE DANGEROUS UNDER CONSTANT EXPOSURE

| | |
|-----|-----------------------------------------------------|
| 90 | Subway, motorcycle, truck traffic, lawn mower |
| 100 | Garbage truck, chain saw, pneumatic drill |
| 120 | Rock band concert in front of speakers, thunderclap |
| 140 | Gunshot blast, jet plane |
| 180 | Rocket launching pad |

Information courtesy of the Deafness Research Foundation.



Maintenance of External Surfaces

- Use a polishing cloth or dry cloth to wipe off dust and dirt.
- When the surfaces are dirty, wipe with a soft cloth dipped in some neutral cleanser diluted five or six times with water, and wrung out well, and then wipe again with a dry cloth. Do not use furniture wax or cleaners.
- Never use thinners, benzine, insecticide sprays or other chemicals on or near this unit, since these will corrode the surfaces.

Specifications

Amplifier Section

Continuous average power output of 100 watts* per channel, min., at 8 ohms, from 20 Hz to 20,000 Hz with no more than 0.09% total harmonic distortion (front).**

Continuous Power Output

| | |
|---------------------|--------------------------------------------|
| Front | 100 W +100 W (20 Hz - 20 kHz, 0.09 %, 8 Ω) |
| Center | 100 W +100 W (20 Hz - 20 kHz, 0.09 %, 8 Ω) |
| Surround | 100 W +100 W (20 Hz - 20 kHz, 0.09 %, 8 Ω) |
| Surround Back | 100 W +100 W (20 Hz - 20 kHz, 0.09 %, 8 Ω) |

Input (Sensitivity/Impedance)

| | |
|---------------------------------------------------------------------------|--------------|
| VCR 1/DVR, VCR 2, DVD/LD, TV/SAT, VIDEO, CD, CD-R/TAPE 1, MD/TAPE 2 | 335 mV/47 kΩ |
|---------------------------------------------------------------------------|--------------|

Frequency Response

| | |
|---------------------------------------------------------------------------|-------------------------------|
| VCR 1/DVR, VCR 2, DVD/LD, TV/SAT, VIDEO, CD, CD-R/TAPE 1, MD/TAPE 2 | 5 Hz to 100,000 Hz ± 3 dB |
|---------------------------------------------------------------------------|-------------------------------|

Output (Level/Impedance)

| | |
|----------------------------------------------------------------|---------------|
| VCR 1/DVR REC, VCR 2 REC, CD-R/TAPE 1 REC, MD/TAPE 2 REC | 335 mV/2.2 kΩ |
|----------------------------------------------------------------|---------------|

Tone Control

| | |
|----------------|-------------------------------------------------------|
| BASS | ± 6 dB (100 Hz) |
| TREBLE | ± 6 dB (10 kHz) |
| LOUDNESS | +4/+2 dB (100Hz/10 kHz) (at volume position -40dB) |

Signal-to-Noise Ratio (IHF, short circuited, A network)

| | |
|----------------------------------------------------------------------------------------|--------|
| VCR 1/DVR, VCR 2, DVD/LD, TV/SAT, VIDEO, CD, CD-R/TAPE 1, MD/TAPE 2, MULTI CH IN | 101 dB |
|----------------------------------------------------------------------------------------|--------|

Signal-to-Noise Ratio [EIA, at 1 W (1 kHz)]

| | |
|---------------------------------------------------------------------------|-------|
| VCR 1/DVR, VCR 2, DVD/LD, TV/SAT, VIDEO, CD, CD-R/TAPE 1, MD/TAPE 2 | 83 dB |
|---------------------------------------------------------------------------|-------|

* Measured pursuant to the Federal Trade Commission's Trade Regulation rule on Power Output Claims for Amplifiers.

** Measured by Audio Spectrum Analyzer.

VIDEO Section (S jack)

Input (Sensitivity/Impedance)

| | |
|--------------------------------------------------------------------|-----------------|
| VCR 1/DVR, VCR 2, VIDEO, DVD/LD, TV/SAT Luminance signal (Y) | 1 Vp-p/75 Ω |
| Chrominance signal (C) | 0.286 Vp-p/75 Ω |

Output (Level/Impedance)

VCR 1/DVR, VCR 2, MONITOR OUT

| | |
|------------------------------|-----------------|
| Luminance signal (Y) | 1 Vp-p/75 Ω |
| Chrominance signal (C) | 0.286 Vp-p/75 Ω |

Frequency Response

VCR 1/DVR, VCR 2, VIDEO, DVD/LD, TV/SAT

| | |
|----------------------------|---------------------------|
| Luminance signal (Y) | 5 Hz to 10 MHz ± 3 dB |
|----------------------------|---------------------------|

Signal-to-Noise Ratio

| | |
|----------------------------|-------|
| Luminance signal (Y) | 65 dB |
|----------------------------|-------|

Component Video Section

Input (Sensitivity)

| | |
|-------------|-------------|
| Y | 1 Vp-p/75 Ω |
| Pb/Pr | 0.7 V/75 Ω |

Output (Level/Impedance)

| | |
|-------------|-------------|
| Y | 1 Vp-p/75 Ω |
| Pb/Pr | 0.7 V/75 Ω |

Frequency Response

| | |
|-------------|---------------------------|
| Y | 5 Hz to 40 MHz ± 0 dB |
| Pb/Pr | 5 Hz to 40 MHz ± 0 dB |

VIDEO Section (Composite)

Input (Sensitivity/Impedance)

| | |
|-----------------------------------------------|-------------|
| VCR 1/DVR, VCR 2, VIDEO, DVD/LD, TV/SAT | 1 Vp-p/75 Ω |
|-----------------------------------------------|-------------|

Output (Level/Impedance)

| | |
|---------------------------------------------------|-------------|
| VCR 1/DVR, VCR 2, MONITOR OUT, MONITOR OUT2 | 1 Vp-p/75 Ω |
|---------------------------------------------------|-------------|

Frequency Response

| | |
|-----------------------------------------------------------|---------------------------|
| VCR 1/DVR, VCR 2, TV/SAT, DVD/LD VIDEO→MONITOR OUT, | 5 Hz to 10 MHz ± 3 dB |
|-----------------------------------------------------------|---------------------------|

Signal-to-Noise Ratio

| |
|-------|
| 65 dB |
|-------|

FM Tuner Section

Frequency Range

| |
|---------------------|
| 87.5 MHz to 108 MHz |
|---------------------|

Usable Sensitivity

| |
|-----------------------------------|
| Mono: 13.2 dBf, IHF (1.3 μV/75 Ω) |
|-----------------------------------|

50 dB Quieting Sensitivity

| |
|----------------|
| Mono: 20.2 dBf |
|----------------|

Signal-to-Noise Ratio

| |
|-------------------------|
| Mono: 73 dB (at 85 dBf) |
|-------------------------|

Distortion

| |
|-----------------------|
| Stereo: 0.5 % (1 kHz) |
|-----------------------|

Alternate Channel Selectivity

| |
|-----------------|
| 60 dB (400 kHz) |
|-----------------|

Stereo Separation

| |
|---------------|
| 40 dB (1 kHz) |
|---------------|

Frequency Response

| |
|--------------------------------|
| 30 Hz to 15 kHz (± 1) dB |
|--------------------------------|

Antenna Input

| |
|-----------------|
| 75 Ω unbalanced |
|-----------------|

AM Tuner Section

Frequency Range

| |
|----------------------|
| 530 kHz to 1,700 kHz |
|----------------------|

Sensitivity (IHF, Loop antenna)

| |
|----------|
| 350 μV/m |
|----------|

Selectivity

| |
|-------|
| 25 dB |
|-------|

Signal-to-Noise Ratio

| |
|-------|
| 50 dB |
|-------|

Antenna

| |
|--------------|
| Loop antenna |
|--------------|

Miscellaneous

Power Requirements

| |
|-----------------|
| AC 120 V, 60 Hz |
|-----------------|

Power Consumption

| |
|-------|
| 600 W |
|-------|

Power Consumption in Standby mode

| |
|-------|
| 0.6 W |
|-------|

AC Outlet SWITCHED

| |
|-------------------|
| 100 W (0.8 A) MAX |
|-------------------|

Dimensions

| |
|--------------------------------------------------------------------------------|
| 420 (W) × 188 (H) × 464 (D) mm (16-9/16 (W) × 7-7/16 (H) × 18-5/16 (D) in.) |
|--------------------------------------------------------------------------------|

Weight (without package)

| |
|----------------------|
| 17.3 kg (38 lb 3 oz) |
|----------------------|

Furnished Parts

FM wire Antenna

| |
|---|
| 1 |
|---|

AM loop Antenna

| |
|---|
| 1 |
|---|

"AA" IEC LR6 batteries

| |
|---|
| 2 |
|---|

Remote Control Unit

| |
|---|
| 1 |
|---|

Operating Instructions

| |
|---|
| 1 |
|---|

NOTE:

Specifications and the design are subject to possible modifications without notice, due to improvements.

Should this product require service in the U.S.A. and you wish to locate the nearest Pioneer Authorized Independent Service Company, or if you wish to purchase replacement parts, operating instructions, service manuals, or accessories, please call the number shown below.

8 0 0 - 4 2 1 - 1 4 0 4

Please do not ship your product to Pioneer without first calling the Customer Support Division at the above listed number for assistance.

Pioneer Electronics (USA) Inc.
Customer Support Division
P.O. BOX 1760, Long Beach,
CA 90801-1760, U.S.A.

For warranty information please see the Limited Warranty sheet included with your product.

Should this product require service in Canada, please contact a Pioneer Canadian Authorized Dealer to locate the nearest Pioneer Authorized Service Company in Canada.

Alternatively, please contact the Customer Satisfaction Department at the following address:

Pioneer Electronics of Canada, Inc.
Customer Satisfaction Department
300 Allstate Parkway, Markham, Ontario L3R OP2
(905)479-4411
1(877)283-5901

For warranty information please see the Limited Warranty sheet included with your product.

Si ce produit doit être réparé au Canada, veuillez vous adresser à un distributeur autorisé Pioneer du Canada pour obtenir le nom du Centre de Service Autorisé Pioneer le plus près de chez-vous. Vous pouvez aussi contacter le Service à la clientèle de Pioneer:

Pioneer Électroniques du Canada, Inc.
Service à la clientèle
300, Allstate Parkway, Markham, Ontario L3R OP2
(905)479-4411
1(877)283-5901

Pour obtenir des renseignements sur la garantie, veuillez vous reporter au feuillet sur la garantie restreinte qui accompagne le produit.

S018B_2L

Published by Pioneer Corporation.
Copyright © 2002 Pioneer Corporation.
All rights reserved.

PIONEER CORPORATION 4-1, Meguro 1-Chome, Meguro-ku, Tokyo 153-8654, Japan
PIONEER ELECTRONICS [USA] INC. P.O. BOX 1540, Long Beach, California 90801-1540, U.S.A.
PIONEER ELECTRONICS OF CANADA, INC. 300 Allstate Parkway, Markham, Ontario L3R OP2, Canada
PIONEER EUROPE NV Haven 1087, Keetberglaan 1, B-9120 Melsele, Belgium TEL: 03/570.05.11
PIONEER ELECTRONICS AUSTRALIA PTY. LTD. 178-184 Boundary Road, Braeside, Victoria 3195, Australia, TEL: [03] 9586-6300
PIONEER ELECTRONICS DE MEXICO S.A. DE C.V. San Lorenzo 1009 3er Piso Desp. 302 Col. Del Valle Mexico D.F. C.P. 03100
TEL: 55-5688-5290

Free Manuals Download Website

<http://myh66.com>

<http://usermanuals.us>

<http://www.somanuals.com>

<http://www.4manuals.cc>

<http://www.manual-lib.com>

<http://www.404manual.com>

<http://www.luxmanual.com>

<http://aubethermostatmanual.com>

Golf course search by state

<http://golfingnear.com>

Email search by domain

<http://emailbydomain.com>

Auto manuals search

<http://auto.somanuals.com>

TV manuals search

<http://tv.somanuals.com>