

Pioneer *sound.vision.soul*

**AUDIO/VIDEO MULTI-CHANNEL
RECEIVER**

VSX-59TXi

ELITE

**Register your product at
www.pioneerelectronics.com**

- **Protect your new investment**
The details of your purchase will be on file for reference in the event of an insurance claim such as loss or theft.
- **Receive free tips, updates and service bulletins on your new product**
- **Improve product development**
Your input helps us continue to design products that meet your needs.
- **Receive a free Pioneer newsletter**
Registered customers can opt in to receive a monthly newsletter.

Operating Instructions



The lightning flash with arrowhead, within an equilateral triangle, is intended to alert the user to the presence of uninsulated "dangerous voltage" within the product's enclosure that may be of sufficient magnitude to constitute a risk of electric shock to persons.

CAUTION

**RISK OF ELECTRIC SHOCK
DO NOT OPEN**

CAUTION:

TO PREVENT THE RISK OF ELECTRIC SHOCK, DO NOT REMOVE COVER (OR BACK). NO USER-SERVICEABLE PARTS INSIDE. REFER SERVICING TO QUALIFIED SERVICE PERSONNEL.



The exclamation point within an equilateral triangle is intended to alert the user to the presence of important operating and maintenance (servicing) instructions in the literature accompanying the appliance.

D1-4-2-3_En

Thank you for buying this pioneer product. Please read through these operating instructions so you will know how to operate your model properly. After you have finished reading the instructions, put them away in a safe place for future reference.

WARNING – TO PREVENT FIRE OR SHOCK HAZARD, DO NOT EXPOSE THIS APPLIANCE TO RAIN OR MOISTURE.

D1-4-2-1_En

CAUTION

– PREVENT ELECTRIC SHOCK DO NOT USE THIS (POLARIZED) PLUG WITH AN EXTENSION CORD. RECEPTACLE OR OTHER OUTLET UNLESS THE BLADES CAN BE FULLY INSERTED TO PREVENT BLADE EXPOSURE.

ATTENTION

– POUR PREVENIR LES CHOCS ELECTRIQUES NE PAS UTILISER CETTE FICHE POLARISEE AVEC UN PROLONGATEUR UNE PRISE DE COURANT OU UNE AUTRE SORTIE DE COURANT, SAUF SI LES LAMES PEUVENT ETRE INSEREES A FOND SANS EN LAISSER AUCUNE PARTIE A DECOUVVERT.

D2-4-4-1_EF

IMPORTANT NOTICE – THE SERIAL NUMBER FOR THIS EQUIPMENT IS LOCATED IN THE REAR. PLEASE WRITE THIS SERIAL NUMBER ON YOUR ENCLOSED WARRANTY CARD AND KEEP IN A SECURE AREA. THIS IS FOR YOUR SECURITY.

D1-4-2-6-1_En

This Class B digital apparatus complies with Canadian ICES-003.

Cet appareil numérique de la Classe B est conforme à la norme NMB-003 du Canada.

D8-10-1-3_EF

Information to User

Alteration or modifications carried out without appropriate authorization may invalidate the user's right to operate the equipment.

D8-10-2_En

NOTE: This equipment has been tested and found to comply with the limits for a Class B digital device, pursuant to Part 15 of the FCC Rules. These limits are designed to provide reasonable protection against harmful interference in a residential installation. This equipment generates, uses, and can radiate radio frequency energy and, if not installed and used in accordance with the instructions, may cause harmful interference to radio communications. However, there is no guarantee that interference will not occur in a particular installation. If this equipment does cause harmful interference to radio or television reception, which can be determined by turning the equipment off and on, the user is encouraged to try to correct the interference by one or more of the following measures:

- Reorient or relocate the receiving antenna.
- Increase the separation between the equipment and receiver.
- Connect the equipment into an outlet on a circuit different from that to which the receiver is connected.
- Consult the dealer or an experienced radio/TV technician for help.

D8-10-1-2_En

CAUTION: This product satisfies FCC regulations when shielded cables and connectors are used to connect the unit to other equipment. To prevent electromagnetic interference with electric appliances such as radios and televisions, use shielded cables and connectors for connections.

D8-10-3a_En

IMPORTANT SAFETY INSTRUCTIONS

READ INSTRUCTIONS — All the safety and operating instructions should be read before the product is operated.

RETAIN INSTRUCTIONS — The safety and operating instructions should be retained for future reference.

HEED WARNINGS — All warnings on the product and in the operating instructions should be adhered to.

FOLLOW INSTRUCTIONS — All operating and use instructions should be followed.

CLEANING — The product should be cleaned only with a polishing cloth or a soft dry cloth. Never clean with furniture wax, benzene, insecticides or other volatile liquids since they may corrode the cabinet.

ATTACHMENTS — Do not use attachments not recommended by the product manufacturer as they may cause hazards.

WATER AND MOISTURE — Do not use this product near water — for example, near a bathtub, wash bowl, kitchen sink, or laundry tub; in a wet basement; or near a swimming pool; and the like.

ACCESSORIES — Do not place this product on an unstable cart, stand, tripod, bracket, or table. The product may fall, causing serious injury to a child or adult, and serious damage to the product. Use only with a cart, stand, tripod, bracket, or table recommended by the manufacturer, or sold with the product. Any mounting of the product should follow the manufacturer's instructions, and should use a mounting accessory recommended by the manufacturer.

CART — A product and cart combination should be moved with care. Quick stops, excessive force, and uneven surfaces may cause the product and cart combination to overturn.



VENTILATION — Slots and openings in the cabinet are provided for ventilation and to ensure reliable operation of the product and to protect it from overheating, and these openings must not be blocked or covered. The openings should never be blocked by placing the product on a bed, sofa, rug, or other similar surface. This product should not be placed in a built-in installation such as a bookcase or rack unless proper ventilation is provided or the manufacturer's instructions have been adhered to.

POWER SOURCES — This product should be operated only from the type of power source indicated on the marking label. If you are not sure of the type of power supply to your home, consult your product dealer or local power company.

LOCATION — The appliance should be installed in a stable location.

NONUSE PERIODS — The power cord of the appliance should be unplugged from the outlet when left un-used for a long period of time.

GROUNDING OR POLARIZATION

- If this product is equipped with a polarized alternating current line plug (a plug having one blade wider than the other), it will fit into the outlet only one way. This is a safety feature. If you are unable to insert the plug fully into the outlet, try reversing the plug. If the plug should still fail to fit, contact your electrician to replace your obsolete outlet. Do not defeat the safety purpose of the polarized plug.
- If this product is equipped with a three-wire grounding type plug, a plug having a third (grounding) pin, it will only fit into a grounding type power outlet. This is a safety feature. If you are unable to insert the plug into the outlet, contact your electrician to replace your obsolete outlet. Do not defeat the safety purpose of the grounding type plug.

POWER-CORD PROTECTION — Power-supply cords should be routed so that they are not likely to be walked on or pinched by items placed upon or against them, paying particular attention to cords at plugs, convenience receptacles, and the point where they exit from the product.

OUTDOOR ANTENNA GROUNDING — If an outside antenna or cable system is connected to the product, be sure the antenna or cable system is grounded so as to provide some protection against voltage surges and built-up static charges. Article 810 of the National Electrical Code, ANSI/NFPA 70, provides information with regard to proper grounding of the mast and supporting structure, grounding of the lead-in wire to an antenna discharge unit, size of grounding conductors, location of antenna-discharge unit, connection to grounding electrodes, and requirements for the grounding electrode. See Figure A.

LIGHTNING — For added protection for this product during a lightning storm, or when it is left unattended and unused for long periods of time, unplug it from the wall outlet and disconnect the antenna or cable system. This will prevent damage to the product due to lightning and power-line surges.

POWER LINES — An outside antenna system should not be located in the vicinity of overhead power lines or other electric light or power circuits, or where it can fall into such power lines or circuits. When installing an outside antenna system, extreme care should be taken to keep from touching such power lines or circuits as contact with them might be fatal.

OVERLOADING — Do not overload wall outlets, extension cords, or integral convenience receptacles as this can result in a risk of fire or electric shock.

OBJECT AND LIQUID ENTRY — Never push objects of any kind into this product through openings as they may touch dangerous voltage points or short-out parts that could result in a fire or electric shock. Never spill liquid of any kind on the product.

SERVICING — Do not attempt to service this product yourself as opening or removing covers may expose you to dangerous voltage or other hazards. Refer all servicing to qualified service personnel.

DAMAGE REQUIRING SERVICE — Unplug this product from the wall outlet and refer servicing to qualified service personnel under the following conditions:

- When the power-supply cord or plug is damaged.
- If liquid has been spilled, or objects have fallen into the product.
- If the product has been exposed to rain or water.
- If the product does not operate normally by following the operating instructions. Adjust only those controls that are covered by the operating instructions as an improper adjustment of other controls may result in damage and will often require extensive work by a qualified technician to restore the product to its normal operation.
- If the product has been dropped or damaged in any way.
- When the product exhibits a distinct change in performance — this indicates a need for service.

REPLACEMENT PARTS — When replacement parts are required, be sure the service technician has used replacement parts specified by the manufacturer or have the same characteristics as the original part. Unauthorized substitutions may result in fire, electric shock, or other hazards.

SAFETY CHECK — Upon completion of any service or repairs to this product, ask the service technician to perform safety checks to determine that the product is in proper operating condition.

WALL OR CEILING MOUNTING — The product should not be mounted to a wall or ceiling.

HEAT — The product should be situated away from heat sources such as radiators, heat registers, stoves, or other products (including amplifiers) that produce heat.

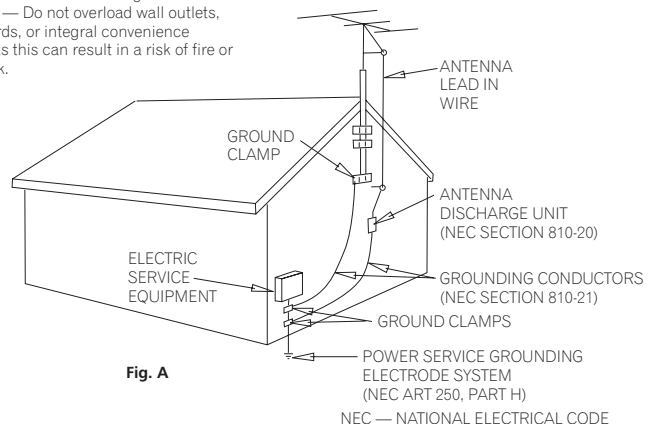

Fig. A

NEC — NATIONAL ELECTRICAL CODE

D1-4-2-2_En

CAUTION : USE OF CONTROLS OR ADJUSTMENTS OR PERFORMANCE OF PROCEDURES OTHER THAN THOSE SPECIFIED HEREIN MAY RESULT IN HAZARDOUS RADIATION EXPOSURE.

CAUTION : THE USE OF OPTICAL INSTRUMENTS WITH THIS PRODUCT WILL INCREASE EYE HAZARD. D6-8-2-1_En

For U.S. and Australia Model



ENERGY STAR

C67-7-3_En

WARNING: Handling the cord on this product or cords associated with accessories sold with the product will expose you to lead, a chemical known to the State of California and other governmental entities to cause cancer and birth defects or other reproductive harm.

Wash hands after handling

D36-P4_En



Dear Customer:

Selecting fine audio equipment such as the unit you've just purchased is only the start of your musical enjoyment. Now it's time to consider how you can maximize the fun and excitement your equipment offers. This manufacturer and the Electronic Industries Association's Consumer Electronics Group want you to get the most out of your equipment by playing it at a safe level. One that lets the sound come through loud and clear without annoying blaring or distortion-and, most importantly, without affecting your sensitive hearing.

Sound can be deceiving. Over time your hearing "comfort level" adapts to higher volumes of sound. So what sounds "normal" can actually be loud and harmful to your hearing. Guard against this by setting your equipment at a safe level BEFORE your hearing adapts.

To establish a safe level:

- Start your volume control at a low setting.
- Slowly increase the sound until you can hear it comfortably and clearly, and without distortion.

Once you have established a comfortable sound level:

- Set the dial and leave it there.

Taking a minute to do this now will help to prevent hearing damage or loss in the future. After all, we want you listening for a lifetime.

We Want You Listening For A Lifetime

Used wisely, your new sound equipment will provide a lifetime of fun and enjoyment. Since hearing damage from loud noise is often undetectable until it is too late, this manufacturer and the Electronic Industries Association's Consumer Electronics Group recommend you avoid prolonged exposure to excessive noise. This list of sound levels is included for your protection.

Decibel Level Example

30	Quiet library, soft whispers
40	Living room, refrigerator, bedroom away from traffic
50	Light traffic, normal conversation, quiet office
60	Air conditioner at 20 feet, sewing machine
70	Vacuum cleaner, hair dryer, noisy restaurant
80	Average city traffic, garbage disposals, alarm clock at two feet.

THE FOLLOWING NOISES CAN BE DANGEROUS UNDER CONSTANT EXPOSURE

90	Subway, motorcycle, truck traffic, lawn mower
100	Garbage truck, chain saw, pneumatic drill
120	Rock band concert in front of speakers, thunderclap
140	Gunshot blast, jet plane
180	Rocket launching pad

Information courtesy of the Deafness Research Foundation.



S001_En

If the socket outlets on the associated equipment are not suitable for the plug supplied with the product, the plug must be removed and appropriate one fitted. Replacement and mounting of an AC plug on the power supply cord of this unit should be performed only by qualified service personnel. The cut-off plug must be disposed of as an electrical shock hazard could exist if connected to a socket outlet.

D3-4-2-1a_En

The STANDBY/ON switch is secondary connected and therefore, does not separate the unit from mains power in STANDBY position. Therefore install the unit suitable places easy to disconnect the MAINS plug in case of the accident. The MAINS plug of unit should be unplugged from the wall socket when left unused for a long period of time.

D3-4-2-2a_En

Our philosophy

Pioneer is dedicated to making your home theater listening experience as close as possible to the vision of the moviemakers and mastering engineer when they created the original soundtrack. We do this by focusing on three important steps:

- 1 **Achieving the highest possible sound quality**
- 2 **Allowing for customized acoustic calibration according to any listening area**
- 3 **Fine-tuning the receiver with the help of world-class studio engineers¹**

Features

Easy setup using Advanced MCACC

Setting up for home theater sound is as easy as connecting your speakers, a DVD player or other source, and your TV. The Auto Surround Setup provides a quick but accurate surround sound setup, while for complete surround sound control you still have access to the full range of surround sound settings.

In addition, the Profession Acoustic Calibration EQ setup measures the reverb characteristics of your listening area, allowing you to customize your system calibration with the help of a graphical output that can be displayed on-screen, or using a computer.

i.LINK digital interface

The i.LINK interface makes it possible to connect this receiver to i.LINK-equipped components, allowing you to enjoy high sampling rate (up to 192kHz) PCM multichannel digital audio from DVD-Audio and SACD discs, as well as digital audio from DVD-Video, CD and Video CD discs, all with a single cable.

USB digital interface

It is possible to listen to multichannel audio sources from your computer by connecting to the USB interface on the rear of this receiver. Depending on your model of computer and the software installed, you can listen to any source compatible with your operating system through the speaker setup connected to this receiver.

Dolby Digital and DTS decoding, including Dolby Digital EX, DTS 96/24 and DTS-ES

Dolby Digital and DTS decoding brings theater sound right into your home with up to six channels of surround sound, including a special LFE (Low Frequency Effects) channel for deep, realistic sound effects.

With the addition of a surround back speaker, you can take advantage of the built-in Dolby Digital EX and DTS-ES decoders for six-channel surround sound.

Dolby Pro Logic IIx and DTS Neo:6 decoders

The built-in Dolby Pro Logic IIx and DTS Neo:6 decoders not only provide full surround sound decoding for Dolby Surround sources, but will also generate convincing surround sound for any stereo source.

THX certified design

This receiver is THX Ultra2™ certified, allowing you to take advantage of new THX technologies such as ASA (Advanced Speaker Array), which can process any 5.1 channel source for 6.1 channel (THX Surround EX) or 7.1 channel (THX Ultra2™ Cinema and THX MusicMode) playback. These features are also available when using the i.LINK interface.

Windows Media® Audio 9 Professional decoding

It is possible to listen to the Windows Media® Audio 9 Professional (WMA9 Pro) discrete surround format using the on-board WMA9 Pro decoder, or through the USB connection using a software decoder on your computer.

Seamless video conversion

With the Pioneer video converter, you can use a wide range of cords interchangeably, giving you more flexibility when making video connections.

Easy-to-use remote control

The remote control gives you not only complete control over every function of this receiver, but also over the main functions for other components in your home theater system. Using a system of preset codes, you can program the remote to operate a wide range of other equipment.

Energy-saving design

This receiver is designed to use less than 0.65 W of energy when in standby.

¹ *With the cooperation of AIR Studios, this receiver has been designated AIR Studios Monitor Reference:*



"i.LINK" and the i.LINK logo are trademarks of the Sony Corporation.

Contents

Our philosophy.....	5	03 Controls and displays	
Features.....	5	Front panel.....	30
01 Before you start		Display.....	32
Checking the supplied accessories.....	8	Remote control.....	33
Ventilation.....	8	Basic remote control displays.....	33
Installing the receiver.....	8	Remote control displays for the tuner.....	35
Using the remote control.....	9	Remote control displays for other components.....	36
Operating range of the remote control.....	9	04 Getting started	
Recharging the remote control.....	9	Introduction to home theater.....	39
Setting up the remote control.....	9	Automatically setting up for surround sound.....	39
Calibrating the remote control screen.....	10	Other problems when using the Auto Surround	
Setting the clock.....	10	Setup.....	41
Setting the button alert volume.....	11	Checking the settings on your DVD (or other)	
Setting the time-out setting.....	11	player.....	41
Resetting the remote control.....	11	Playing a source.....	41
Locking the remote control.....	12	05 Listening to your system	
Restarting the remote control.....	12	About the listening modes.....	43
Replacing the lithium-ion batteries.....	12	Listening in surround sound.....	43
02 Connecting your equipment		Using the Advanced surround effects.....	45
Rear panel.....	14	Using the Home THX modes.....	45
When making cable connections.....	15	Listening in stereo.....	46
Connecting your TV.....	16	Listening with headphones.....	46
Connecting a DVD player.....	17	Using the multichannel analog inputs.....	47
Connecting the multichannel analog outputs.....	18	Using the Stream Direct mode.....	47
Connecting a satellite/cable receiver or other		Listening with Acoustic Calibration EQ.....	48
set-top box.....	19	Selecting the input signal type.....	48
Connecting a VCR or DVD recorder.....	20	Selecting USB and multichannel analog	
Connecting other video sources.....	21	input channels.....	49
Using the component video jacks.....	22	Listening to high-sampling formats.....	49
About the video converter.....	22	Using the surround back channel.....	50
Connecting digital audio sources.....	23	Listening with virtual surround back speakers.....	51
Connecting analog audio sources.....	24	Creating a center speaker effect.....	51
Connecting a component to the front panel inputs.....	25	Using Hi-bit and Hi-sampling.....	52
Installing your speaker system.....	26	Using Midnight and Loudness listening.....	52
Connecting the speakers.....	26	Using the tone control.....	52
Placing the speakers.....	27	Switching the tone control on or off.....	52
Connecting antennas.....	28	Adjusting the bass and treble.....	53
AM loop antenna.....	28	Reducing noise during playback.....	53
FM wire antenna.....	28	Listening to dual mono soundtracks.....	53
Connecting external antennas.....	28	06 Using the tuner	
Plugging in the receiver.....	29	Finding a station.....	54
About the AC outlet.....	29	Tuning directly to a station.....	55
		MPX mode.....	55
		Memorizing station presets.....	55
		Naming station presets.....	56
		Listening to memorized station presets.....	56

07 The Surround Setup menu

Making receiver settings from the Surround Setup menu	57
Speaker Systems	58
Channel Level	60
Speaker Distance	61
Acoustic Calibration EQ	61
Professional Acoustic Calibration EQ	63
X-Curve	65
Checking your surround settings	66

08 Controlling other equipment

Using the remote control with other components	67
Recalling preset codes	67
Programming signals from other remote controls	69
Remote Direct function	70
Editing remote control button names	70
Multi Operation and System Off	72
Programming a multi operation or a shutdown sequence	72
Switching components on and off using the 12 volt trigger	74
Operating other Pioneer components with this unit's sensor	74

09 Using other functions

Making an audio or a video recording	75
Monitoring your recording	75
Reducing the level of an analog signal	76
Adjusting the delay of a soundtrack	76
Watching video and audio sources independently	76
Enhancing SACD playback	77
Using the A/D converters to give greater definition to 2-channel sound	77
Dimming the display	77
Switching the speaker impedance	78
Checking your system settings	78
Resetting the system	79
Default receiver settings	79

10 Other connections

Using speaker system B	80
Switching the speaker system	80
Using speaker system B in another room	80
Alternating surround speaker setups using speaker system B (ITU-R)	80
Bi-amping your front speakers	81
Bi-wiring your speakers	82
Adding a second set of surround speakers for Bi-Surround	82
Using the pre-outs	82
Connecting additional amplifiers	82
Connecting an external stereo pre-amplifier	83

Multi-room setup	83
Making multi-room connections	83
Using the sub room controls	84
Using the i.LINK interface	85
About i.LINK	86
About PQLS rate control	86
Creating an i.LINK network	86
Using the USB interface	87
Connecting a PC for Advanced MCACC output	88

11 Advanced setup

The Input Assign menu	90
Assigning the digital inputs	90
Assigning the component video inputs	91
Assigning the i.LINK inputs	91
Assigning the video inputs	92
The Expert Setup menu	92
OSD Adjustment	93
Bass Peak Level	93
Dynamic Range Control	94
Function Rename	94
OSD Overlay	94
12 Volt Trigger	95
Multi-Room Setting	95
THX Audio Setup	96
THX Ultra2 Subwoofer Setup	96
Surround Back Speaker Position	96

12 Additional information

Optimizing your speaker setup	97
Basic surround setup	97
THX speaker system setup	98
Speaker system setup for DVD-Audio/multichannel music sources	98
Troubleshooting	99
Power	99
No sound	100
Other audio problems	102
Video	103
Settings	103
Remote control	104
Display	105
i.LINK interface	106
i.LINK messages	106
USB interface	107
Miscellaneous	107
Surround sound formats	108
Dolby	108
DTS	108
Windows Media® Audio 9 Professional	109
PCM (Pulse Code Modulation)	109
About THX®	109
Maintenance of external surfaces	110
Specifications	111

Chapter 1

Before you start

Checking the supplied accessories

Please check that you've received the following supplied accessories:

- Microphone

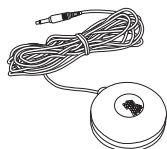

- Remote control unit



- Remote control unit recharger and AC adapter

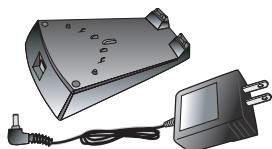

- AM loop antenna



- FM wire antenna

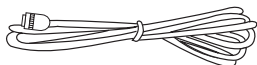

- Power cord

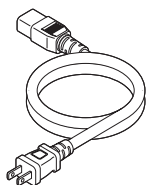

- U-shaped connectors x2 (attached to back of receiver)



- These operating instructions
- Warranty card

Ventilation

When installing this unit, make sure to leave space around the unit for ventilation to improve heat dispersal (at least 8 in. (20 cm) at the top). If not enough space is provided between the unit and walls or other equipment, heat will build up inside, interfering with performance and/or causing malfunctions.

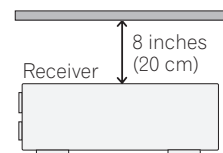

Slot and openings in the cabinet are provided for ventilation and to protect the equipment from overheating. To prevent fire hazard, do not place anything on top of the unit, make sure the openings are never blocked or covered with items (such as newspapers, table-cloths and curtains), and do not operate the equipment on thick carpet or a bed.

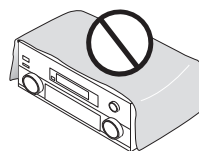

Installing the receiver

- When installing this unit, make sure to put it on a level and stable surface.

Don't install it on the following places:

- on a color TV (the screen may distort)
- near a cassette deck (or close to a device that gives off a magnetic field). This may interfere with the sound.
- in direct sunlight
- in damp or wet areas

- in extremely hot or cold areas
- in places where there is vibration or other movement
- in places that are very dusty
- in places that have hot fumes or oils (such as a kitchen)

Using the remote control

Keep the following in mind when using the remote control:

Operating range of the remote control

- Make sure that there are no obstacles between the remote and the remote sensor on the unit.
- The remote has a range of about 23 feet (7 meters).

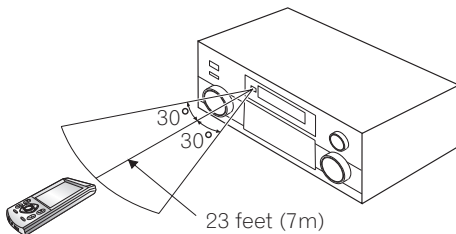

- Remote operation may become unreliable if strong sunlight or fluorescent light is shining on the unit's remote sensor.
- Remote controllers for different devices can interfere with each other. Avoid using remotes for other equipment located close to this unit.

Recharging the remote control

When the battery indicator on the remote control display shows that the rechargeable battery is almost depleted, recharge the remote as shown below. To make sure the battery doesn't run out completely, simply leave the remote control in the recharger when not in use.

Caution

- Do not use AC adaptors other than the one supplied.

1 Connect the AC adaptor to the recharger and plug it into an AC outlet.

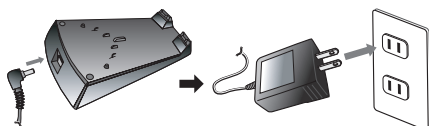

2 Place the remote control on the recharger, aligning the indent on the bottom of the remote with the tabs on the recharger.

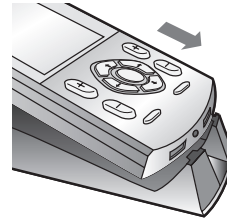

- When the remote control is recharging, you'll see the indicator appear in the upper right corner of the display:



Note

- If the remote hasn't been charged for awhile, the remote control display may remain blank for several minutes before the touch screen appears. If it continues to remain blank, try lifting the remote control up from the recharger and reseating it on the recharger. If after several tries, this does not work, see *Replacing the lithium-ion batteries* on page 12.

Setting up the remote control

After you have calibrated the screen and set the display clock, use the other settings to customize your remote control.

Note

- The remote control operations in this section are accessed from the remote setup menu. To go to the remote setup menu, press from the remote control Home menu ():



There are three remote setup menu screens, which can be navigated by using the touch panel ◀/▶ (cursor left/right) soft keys:

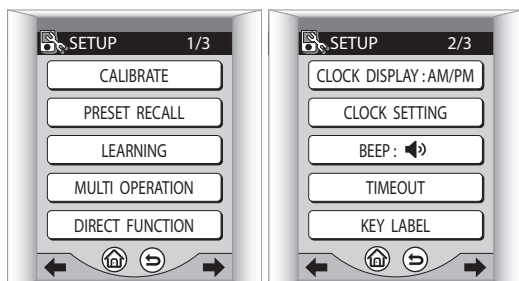

- For more on navigating the remote control menu screens, see *Basic remote control displays* on page 33.

Calibrating the remote control screen

This will make sure the remote control responds correctly when you touch it.

1 Press CALIBRATE.



2 Press the center of each cross point to align the touch screen with the LCD panel underneath.

This adjustment will make sure your remote control is calibrated correctly.



When you've touched both cross points, **PLEASE WAIT** is displayed and you'll return to the remote setup menu when calibration is finished.

Setting the clock

The remote control features a clock that shows both 12 and 24 hour formats.

1 Press CLOCK DISPLAY to select either AM/PM or 24H display format.

Each press switches between the two settings. The current display format is shown after **CLOCK DISPLAY**.



2 Press CLOCK SETTING to set the date.

Use the + and – buttons to set the year, month and day.



3 Press NEXT to continue and set the time.

Use the + and – buttons to set the hour and minute.



4 Press ENTER when you're finished.

You'll return to the remote setup menu.

Setting the button alert volume

You can set the volume of the 'beep' you hear when you press a button on the remote.

- **Press BEEP to select a setting.**

Each press selects between quiet, loud or off. The current setting is shown on the touch screen.



Setting the time-out setting

- Default setting: **60sec**

To save battery life, a timer automatically switches off the remote control off after a set amount of time if no commands are entered. You can adjust separate time-out settings for the LCD, and the remote backlight.

- 1 Press **TIMEOUT**.



- 2 Use the **+** and **-** buttons to set the **LCD TIMEOUT** and **BACKLIGHT TIMEOUT** settings.

You can adjust these from 20–120 seconds.

- The backlight timeout can't be longer than the LCD timeout setting.

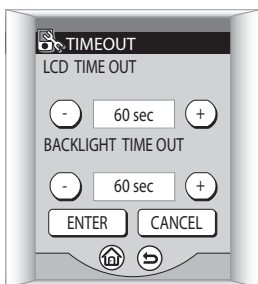

- 3 Press **ENTER** when you're finished.

You'll return to the remote setup menu.

Resetting the remote control

Use this feature to reset the remote control settings to the factory defaults.



- Doing this will erase any of your personalized settings.

- 1 Press **RESET TO DEFAULT**.

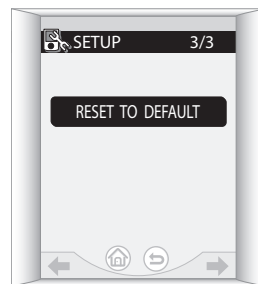

- 2 Confirm by pressing **YES** after reading each screen.

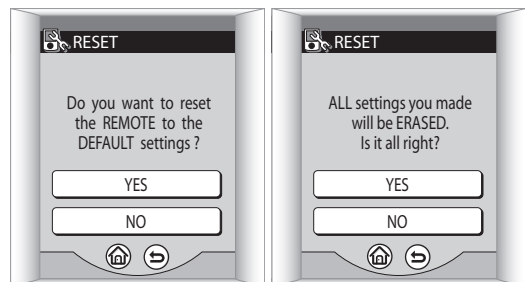

After the screen goes blank, the Home menu appears within a minute or so, and the remote control will be reset to the default settings.

Locking the remote control

This receiver has a remote control lock feature that makes the remote control touch screen and hard keys inoperative.

1 At the same time, press the ← and → hard keys for about three seconds.

- This is not possible from the remote setup screen.

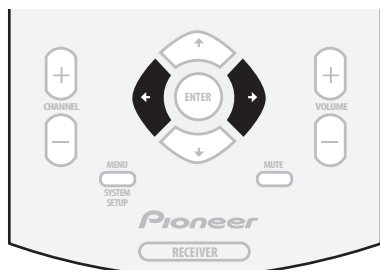

LOCKED! shows on the touch screen to indicate the remote control is locked.

2 To unlock the remote control, repeat step 1.

Once the remote control is unlocked, the touch screen shows the Home menu.

Restarting the remote control

If the remote control display freezes during operation (none of the buttons seem to work), you may need to restart the unit.



Important

- Doing this will *not* erase any of your personalized settings or presets except for the clock setting.

1 Use a small phillips screwdriver to remove the screw fixing the battery cover to the back of the remote.

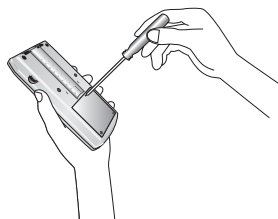

2 Remove the battery cover.

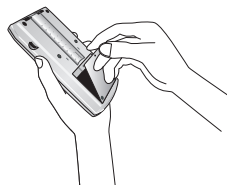

3 Use a pen or other sharp instrument to press the reset button located in the hole to the right (above the battery).

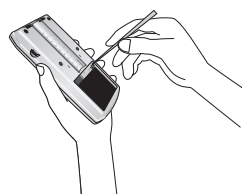

After restarting the remote control, the touch screen shows the Home menu.

Replacing the lithium-ion batteries

If you notice that the remote will no longer hold a charge, you may need to replace the lithium-ion battery cells.



Caution

- The lithium-ion batteries may present a fire or chemical burn hazard if misused. Do not disassemble, heat above 100°C (212°F), or incinerate.
- Replacement cells must be of type AZW7264, manufactured by NEC TOKIN Corporation. Use of any other battery cells may result in fire or explosion. Contact the Pioneer Customer Support division to obtain new batteries. Replacement cells are not covered under warranty.
- Dispose of used battery cells immediately after replacement. Keep away from children.
- When disposing of used batteries, please comply with governmental regulations or environmental public institution's rules that apply in your country or area.

1 Use a small phillips screwdriver to remove the screw fixing the battery cover to the back of the remote.

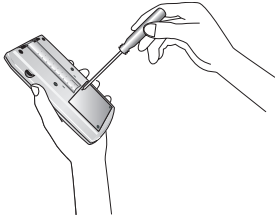

2 Remove the battery cover.

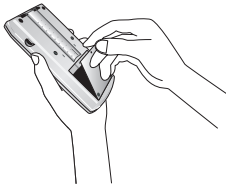

3 Disconnect the old battery cell from the unit.

Do not pull the connector out by holding onto the attached wires. Hold the connector firmly with your fingers, or use a small screwdriver (or other sharp tool) to disconnect it.

4 Connect the new battery cell.

Push the connector in until it is fully inserted. Make sure you keep the wire out of the way and line up the cell properly so that the battery cover can be closed easily.

Chapter 2

Connecting your equipment

This receiver provides you with almost limitless possibilities for connecting your audio/video system, but it doesn't have to be difficult. Depending on your needs, you could be up and running in no time after a few simple connections. This section has been designed so that you can read through this short introduction, then jump to the specific connections that you need to make. For a basic home theater setup, you may only need to look through the TV, DVD and speaker connections.

Rear panel

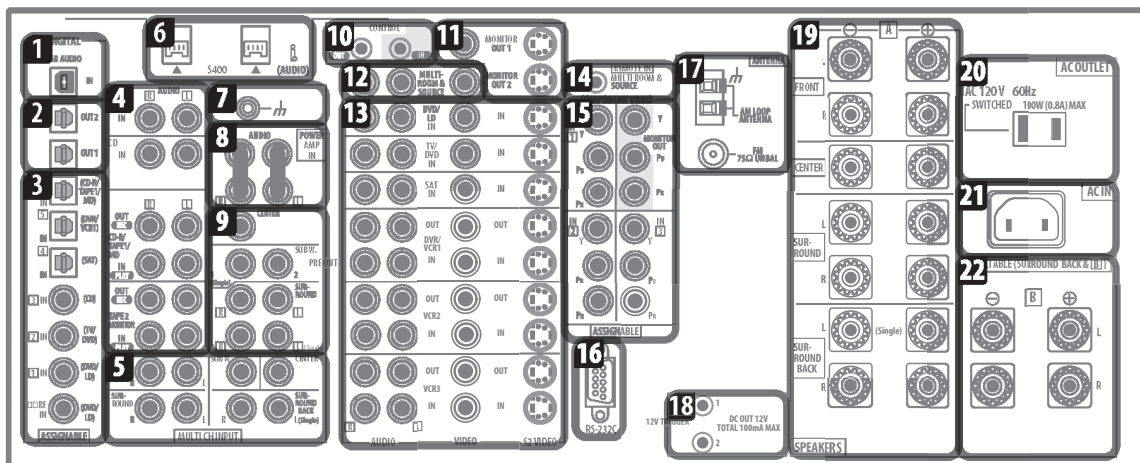

Caution

- Before making or changing the connections, switch off the power and disconnect the power cord from the power outlet. Plugging in components should be the last connection you make with your system.

1 USB audio input

The USB audio input allows you to use your PC as a playback source for stereo or multichannel digital audio. See *Using the USB interface* on page 87 for connection details.

2 Digital audio outputs

Two optical digital audio outputs for connecting to a CD, MD or other digital recorder. See *Connecting a VCR or DVD recorder* on page 20 for connection details.

3 Digital audio inputs

Three optical and three coaxial digital audio inputs for connecting digital audio sources to this receiver. There's also a **RF IN** jack for connection to an LD player with a **RF** output.

All the inputs are freely assignable to input functions for maximum flexibility.

- If a connected component does not correspond to the input function (**DVD/LD**, etc.), see *Assigning the digital inputs* on page 90 to assign it properly.

4 Stereo analog audio source inputs/outputs

Four sets of analog audio jacks for connection to audio sources such as CD players, tape decks and turntables. The **CD-R/TAPE 1/MD** and **TAPE 2 MONITOR** functions also feature outputs for recording. See *Connecting analog audio sources* on page 24 for connection details.

5 Multichannel analog audio inputs

7.1 channel analog inputs for connection to a DVD player with multichannel analog outputs. See *Connecting the multichannel analog outputs* on page 18 for connection details.

6 i.LINK connectors

Two S400-type i.LINK connectors allow you to connect this receiver to other compatible i.LINK audio devices for high-resolution, multichannel digital audio input/output. See *Using the i.LINK interface* on page 85 for connection details.

7 Turntable ground

A grounding (earth) terminal for use with turntables that require it. See *Connecting analog audio sources* on page 24 for connection details.

8 Pre-amplifier output/power amplifier input

When using this receiver as an integrated amplifier, leave the pre-amp outputs connected to the power amp inputs with the supplied U-shaped connectors. Removing these connectors allows you to use this unit as a pre-amplifier or power amplifier only, or to integrate another amplifier into your setup for more inputs. See *Using the pre-outs* on page 82 for connection details.

9 Multichannel pre-amplifier outputs

Multichannel pre-amp outputs that you can use to connect separate amplifiers for center, surround, surround back and subwoofer channels. See *Using the pre-outs* on page 82 for connection details.

10 Control input/output

Mini jack terminals for connection to other Pioneer components to enable you to control all your equipment from a single IR remote sensor. See *Operating other Pioneer components with this unit's sensor* on page 74 for connection details.

11 Monitor video outputs

Three video outputs consisting of a standard composite video output and two S-video outputs, for connection to monitors and TVs. See *Connecting your TV* on page 16 for connection details.

12 Multi-room and source outputs

Outputs for connection to a second amplifier in a separate room. See *Multi-room setup* on page 83.

13 Audio/video source inputs

Each of the seven source input functions has stereo analog audio jacks, a composite video jack and an S-video jack for basic connections. On top of these, you can assign digital audio and component video jacks to input functions as necessary. As well as audio/video inputs, the three input functions **DVR/VCR 1**, **VCR 2** and **VCR 3** also have audio/video outputs for recording. See *Connecting a VCR or DVD recorder* on page 20 for connection details.

14 Remote input (multi-room and source)

The remote input allows you to connect an external remote control sensor, for use in a multi-room setup, for example. See *Multi-room setup* on page 83 for connection details.

15 Component video inputs/output

The three component video inputs are freely assignable to any of the audio/video input functions. The component video output is for connection to a monitor or TV. See *Using the component video jacks* on page 22 for connection details.

16 RS-232C connector

This port is provided for connecting a personal computer for graphical output when using Advanced MCACC.

17 Antenna terminals

Connections for AM and FM radio antennas. See *Connecting antennas* on page 28 for connection details.

18 12V trigger jacks

These terminals output DC 12V according to the input functions (total 100 mA max.). See *Switching components on and off using the 12 volt trigger* on page 74 for connection details.

19 Speaker terminals

These are the main speaker terminals for front, center, surround and surround back speakers. See *Installing your speaker system* on page 26 for connection details.

20 AC power outlet

This 120V AC power outlet can be used to power another component in your setup (up to 100 W). Power to this outlet is switched off when the receiver is in standby.

21 AC power inlet

Connect the supplied power cord here.

22 B speaker terminals

Stereo B speaker terminals that you can use to connect a second pair of speakers for use in another room, for example. See *Using speaker system B* on page 80 for connection details.

When making cable connections

Be careful not to arrange cables in a manner that bends the cables over the top of this unit. If the cables are laid on top of the unit, the magnetic field produced by the transformers in this unit may cause a humming noise to come from the speakers.

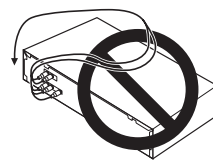

- When connecting optical cables, be careful when inserting the plug not to damage the shutter protecting the optical socket.

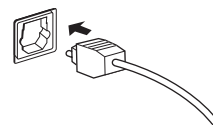

- When storing optical cable, coil loosely. The cable may be damaged if bent around sharp corners.

Connecting your TV

This page shows you how to connect your TV to the receiver. To be able to play the sound from the TV's built-in tuner, connect the analog audio outputs from your TV to this receiver.

If your TV has a built-in digital decoder, you can connect the digital audio output to this receiver to enjoy Dolby Digital and DTS sound from digital TV broadcasts.

1 Connect the MONITOR OUT 1 video jack on this receiver to a video input on your TV.

- You can use a standard RCA/phono jack video cable to connect to the composite video jack, or for higher quality video, you can use an S-video cable to connect to the S-video jack (**S2 VIDEO**).
- See *Using the component video jacks* on page 22 if you want to use the component video outputs to connect this receiver to your TV.

2 Connect the analog audio outputs from your TV to the TV/DVD AUDIO inputs on this receiver.

- Use a stereo RCA/phono jack cable for the connection.

3 Connect a coaxial digital audio output from your TV to the DIGITAL 2 (TV/DVD) input on this receiver.

- Use a coaxial cable designed for digital audio for the connection.
- If your TV only has an optical digital output, you can connect it to one of the optical inputs on this receiver using an optical cable. When you set up the receiver you'll need to tell the receiver which input you connected the TV to (see also *Assigning the digital inputs* on page 90).

Note

- If your TV doesn't have a digital audio output, omit step 3 above.
- If you use different cord types for the TV and the source component, overlay information doesn't appear.

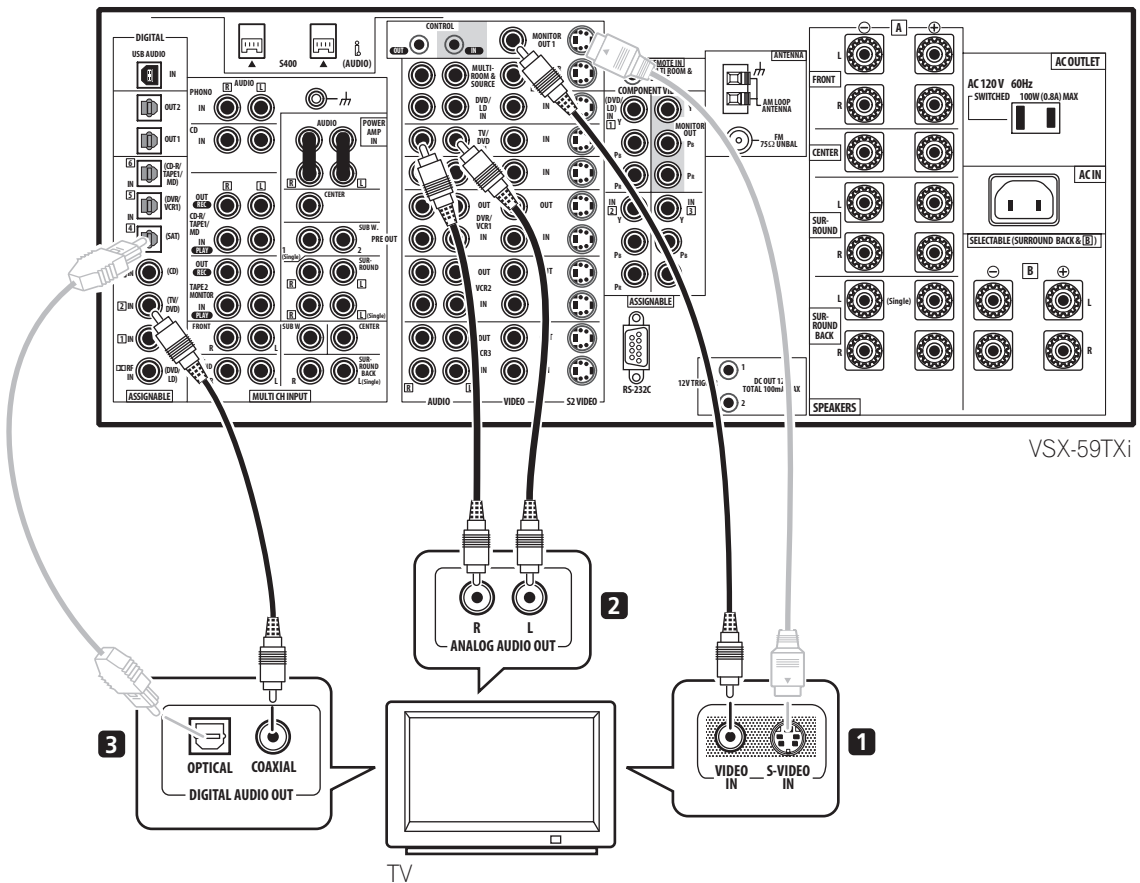

VSX-59TXi

Connecting a DVD player

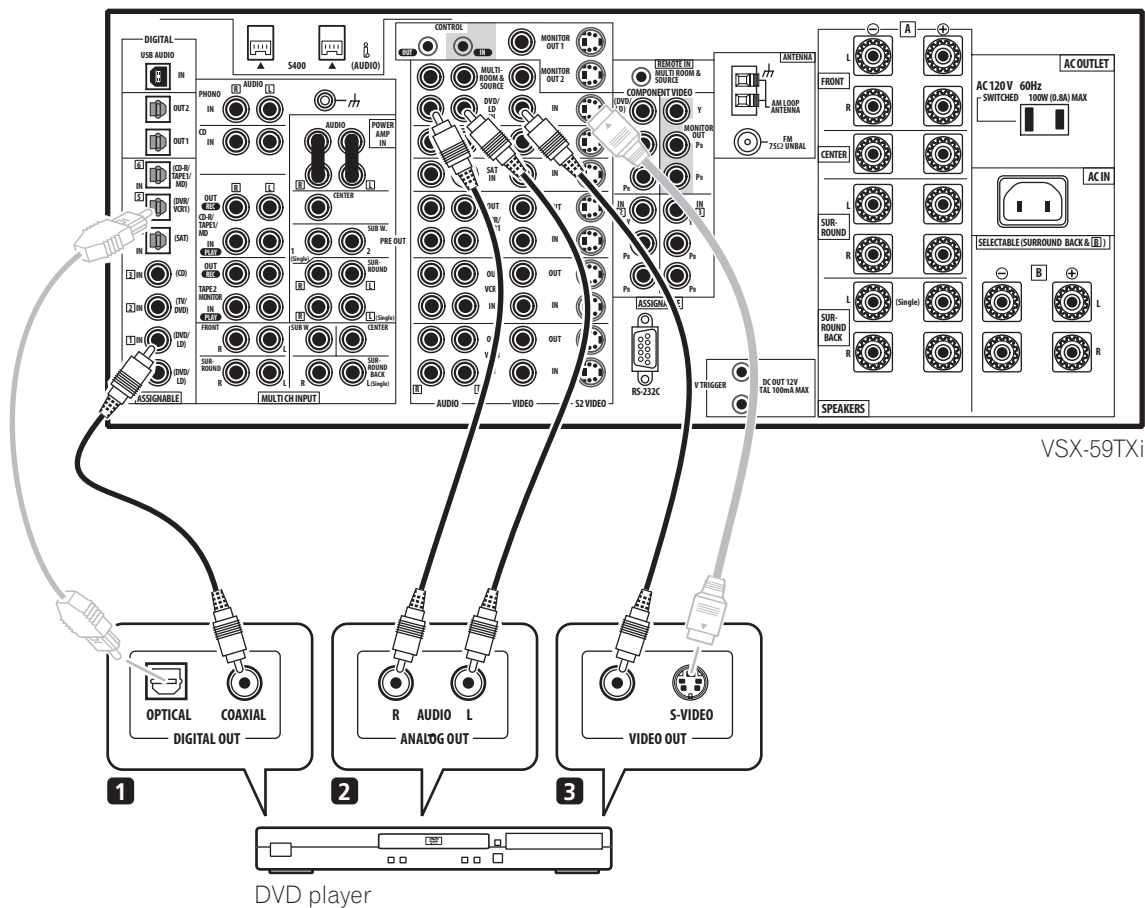

Different DVD players offer a different selection of connections, but all should give you at least a digital audio output, stereo analog audio outputs and a video output. Additionally, you may have a player with multichannel analog audio outputs and different kinds of video outputs to choose from.

1 Connect a coaxial digital audio output on your DVD player to the DIGITAL 1 (DVD/LD) input on this receiver.

- Use a coaxial cable designed for digital audio for the connection.
- If your DVD player only has an optical digital output, you can connect it to one of the optical inputs on this receiver using an optical cable. When you set up the receiver you'll need to tell the receiver which input you connected the player to (see also *Assigning the digital inputs* on page 90).

2 If your DVD player only has stereo analog audio outputs, connect these to the DVD/LD AUDIO inputs on this receiver.

- Use standard RCA/phono jack cables for the connections.
- If your DVD player has multichannel analog outputs, see *Connecting the multichannel analog outputs* below for how to connect it.

3 Connect a composite or S-video output on your DVD player to the DVD/LD VIDEO or DVD/LD S2 VIDEO input on this receiver.

- Use a standard video cable or an S-video cable for the connection.
- If your player also has a component video output, you can connect this too. See *Using the component video jacks* on page 22 for more on this.

Connecting the multichannel analog outputs

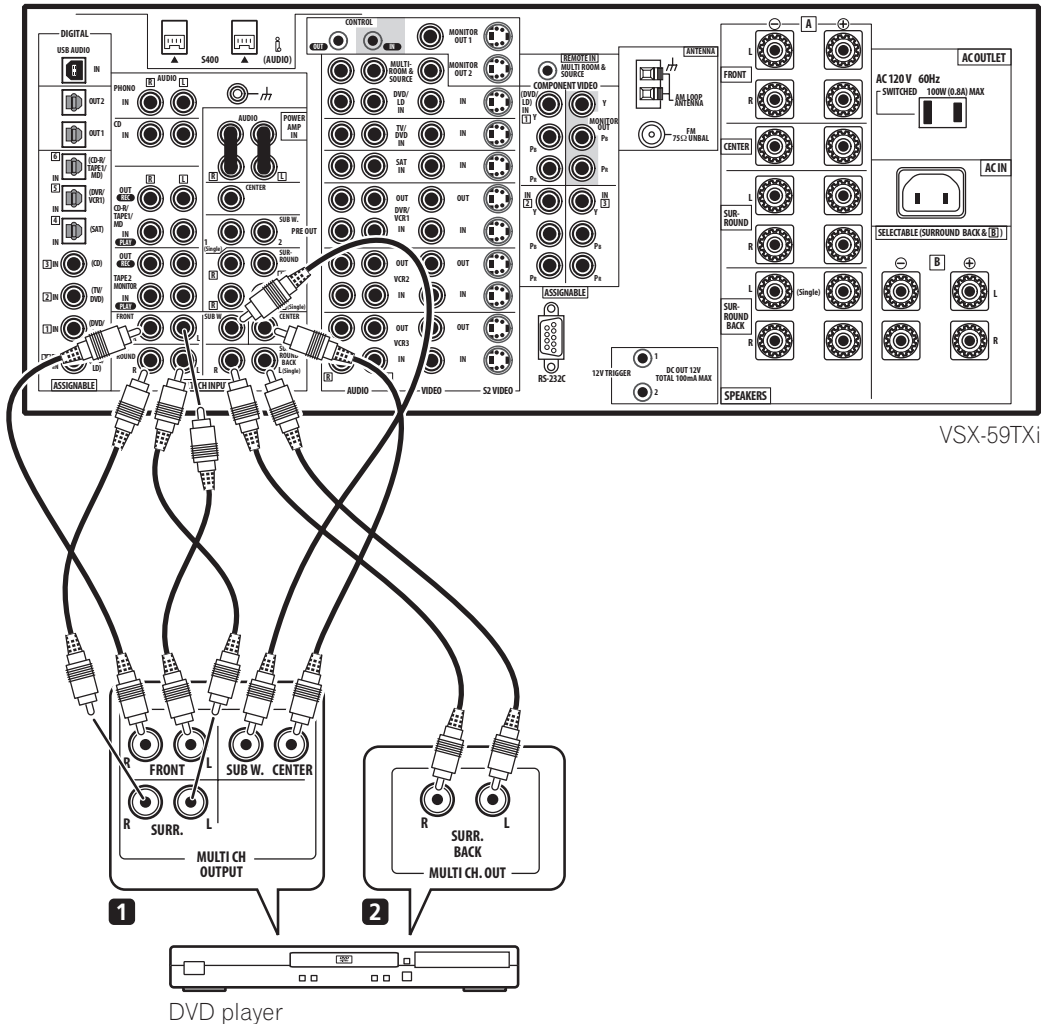

For DVD Audio and SACD playback, your DVD player may have 5.1, 6.1 or 7.1 channel analog outputs (depending on whether your player supports surround back channels).

1 Connect the front, surround, center and subwoofer outputs on your DVD player to the corresponding MULTI CH INPUTS on this receiver.

- Use standard RCA/phono jack cables for the connections.
- Take care to connect each output to its corresponding input on the receiver.

2 If your DVD player also has outputs for surround back channels, connect these to the corresponding MULTI CH INPUTS on this receiver.

- Use standard RCA/phono jack cables for the connections.
- If there is a single surround back output, connect it to the **SURROUND BACK L (SINGLE)** jack on this receiver.

Note

- To listen to multichannel analog audio you'll need to switch the input signal selector to **MULTI CH INPUT** (see *Playing a source* on page 41 for more on this). See also *Selecting USB and multichannel analog input channels* on page 49.

Connecting a satellite/cable receiver or other set-top box

Satellite and cable receivers, and terrestrial digital TV tuners are all examples of so-called 'set-top boxes'.

1 Connect a set of audio/video outputs on the set-top box component to the SAT AUDIO and VIDEO inputs on this receiver.

- Use a stereo RCA/phono jack audio cable for the audio connection and a video or S-video cable for the video connection.

2 Connect an optical digital audio output from your set-top box component to the DIGITAL 4 (SAT) input on this receiver.

- Use an optical cable for the connection.

- If your set-top box only has a coaxial digital output, you can connect it to one of the coaxial inputs on this receiver using a coaxial digital audio cable. When you set up the receiver you'll need to tell the receiver which input you connected the set-top box to (see also *Assigning the digital inputs* on page 90).

Note

- If your satellite/cable receiver doesn't have a digital audio output, omit step 2 above.

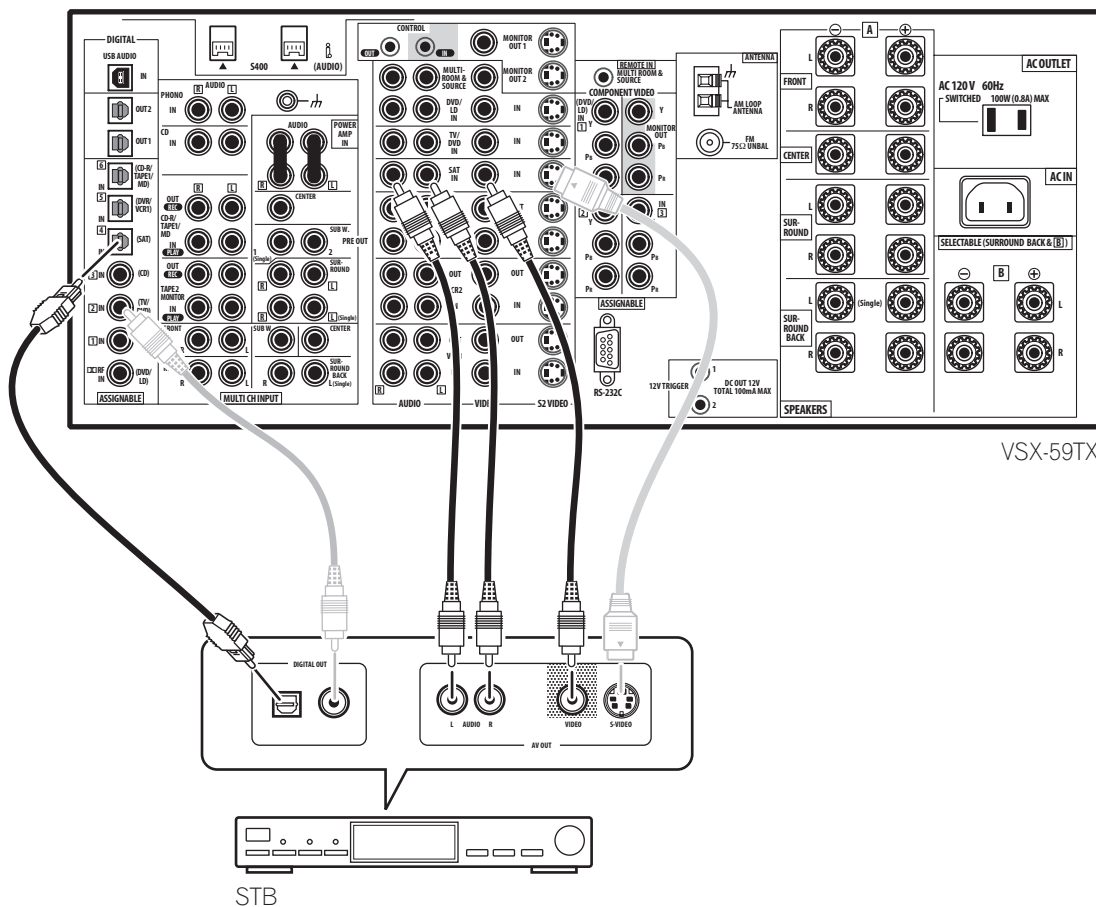

Connecting a VCR or DVD recorder

This receiver has three sets of audio/video inputs and outputs suitable for connecting analog or digital video recorders, including VCRs, DVD-recorders and HDD recorders.

1 Connect a set of audio/video outputs on the recorder to the DVR/VCR1 AUDIO and VIDEO inputs on this receiver.

- Use a stereo RCA/phono jack audio cable for the audio connection and a video or S-video cable for the video connection.
- For a second and third recorder, use the **VCR2 IN** and **VCR3 IN** inputs.

2 Connect a set of audio/video inputs on the recorder to the DVR/VCR1 AUDIO and VIDEO outputs on this receiver.

- Use a stereo RCA/phono jack audio cable for the audio connection and a video or S-video cable for the video connection.
- For a second and third recorder, use the **VCR2** and **VCR3** outputs.

3 Connect an optical digital audio output from the recorder to the **DIGITAL 5 (DVR/VCR1)** input on this receiver.

- Use an optical cable for the connection.
- If your recorder only has a coaxial digital output, you can connect it to one of the coaxial inputs on this receiver using a coaxial digital audio cable. When you set up the receiver you'll need to tell the receiver which input you connected the recorder to (see also *Assigning the digital inputs* on page 90).
- The digital outputs from other recorders can be connected to any spare digital audio inputs on this receiver. You can assign them when setting up the receiver (see also *Assigning the digital inputs* on page 90).

Note

- If your video component doesn't have a digital audio output, omit step **3** above.
- In order to record, you must connect the analog audio cables (the digital connection is for playback only).

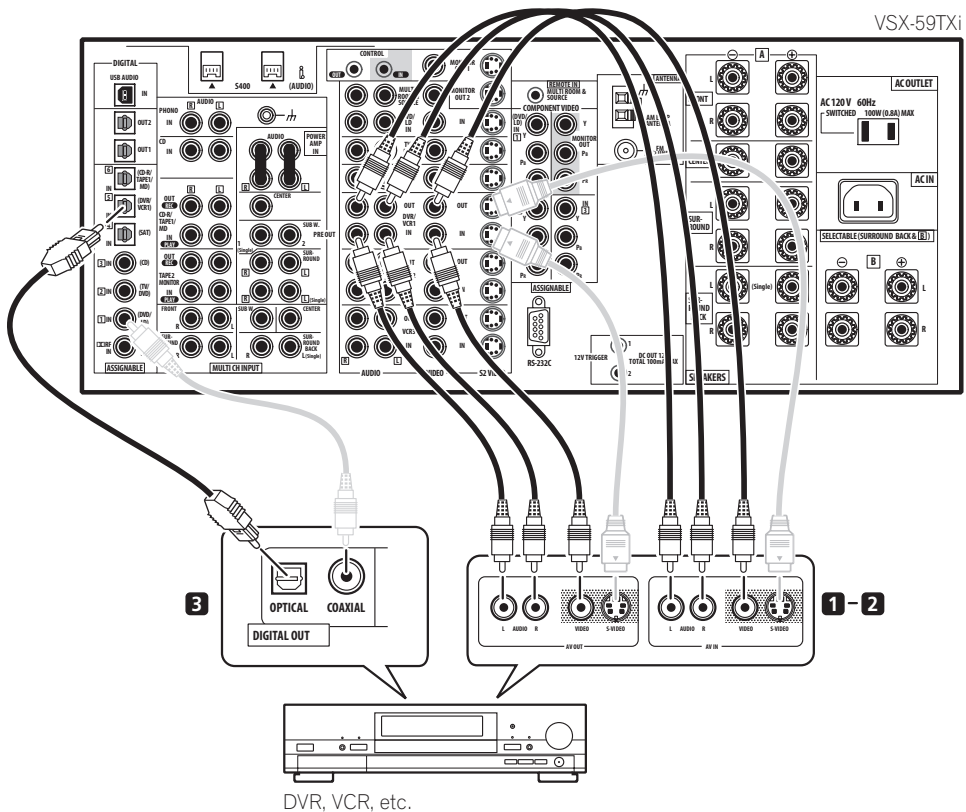

Connecting other video sources

You can basically use any of the audio/video inputs on this receiver for any kind of video source. The example illustration below shows a component connected to the **VCR2** inputs.

1 Connect the analog audio outputs and a video output of the source component to a set of spare audio/video inputs on this receiver.

- Use a stereo RCA/phono jack audio cable for the audio connection and a video or S-video cable for the video connection.

2 If the source component has a digital audio output, connect it to a spare digital audio input on this receiver.

- Use a coaxial cable designed for digital audio or an optical cable for the connection depending on the type of input you used.

- You may need to assign the digital input you used when setting up the receiver (see also *Assigning the digital inputs* on page 90).

3 If the source component is an LD player with a RF digital audio output, connect this to the RF input on this receiver.

To ensure compatibility with all laserdiscs, connect both the **PCM** and **RF** outputs from your LD player.

- Use a coaxial cable designed for digital audio for the **RF** connection.
- You may need to assign the **RF** digital input when setting up the receiver (see also *Assigning the digital inputs* on page 90).

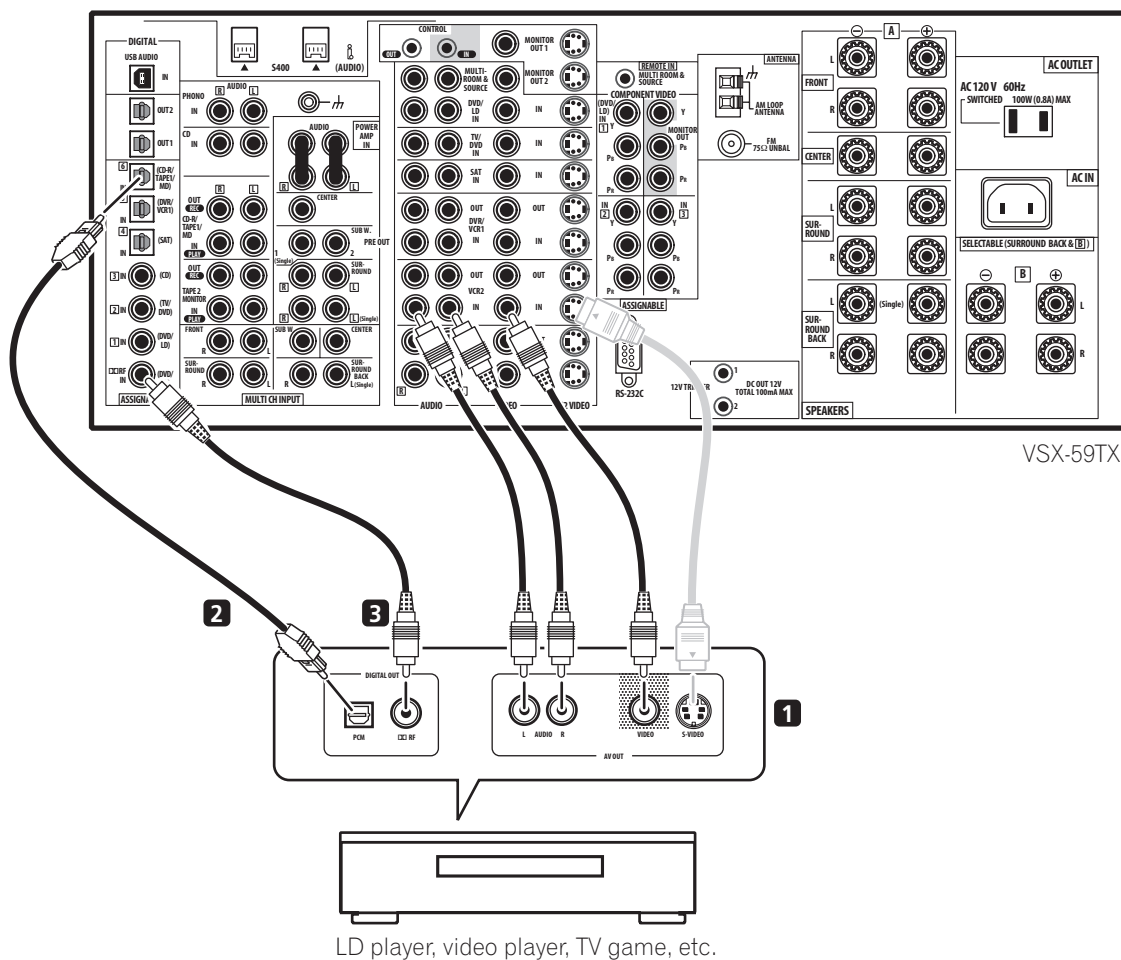

Using the component video jacks

Component video should deliver superior picture quality when compared to composite or S-video. A further advantage (if your source and TV are both compatible) is progressive-scan video, which delivers a very stable, flicker-free picture. See the manuals that came with your TV and source component to check whether they are compatible with progressive-scan video. Note that it is not possible to see overlay information when you have connected using component video cables.

1 Connect the component video outputs of your source to a set of component video inputs on this receiver.

There are three component video inputs; they are all freely assignable (**COMPONENT IN 1**, as a default, should already be assigned to **DVD/LD**) so that they can be used in conjunction with any of the audio/video input functions of the receiver.

Note that in most cases, you'll need to assign the component video input (see *Assigning the component video inputs* on page 91), or else you may see the S-video or composite video input instead.

- Use a three-way component video cable for the connection.

2 Connect the COMPONENT VIDEO MONITOR OUT jacks on this receiver to the component video inputs on your TV or monitor.

- Use a three-way component video cable.

About the video converter

The video converter allows you to connect various video sources using composite, S-video or component video connections and the signal will be output through all of the **MONITOR VIDEO OUT** jacks. The only exception is component video input, which is only output from the component video output. Therefore, if you want to connect any source using component video, you must also connect your TV using component video. If several video components are connected to the same input function, the converter gives priority to component, S-video, then composite (in that order).

- You can't see overlay information if you use different cord types for the TV and the source component.
- Also note that this feature is available with NTSC signals only. For a PAL signal, make sure you've used the same type of cable for your video component and monitor connections.

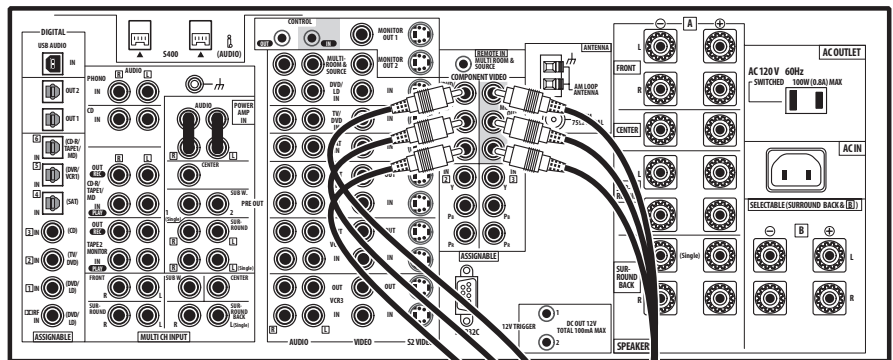

VSX-59TXi

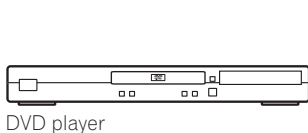

DVD player

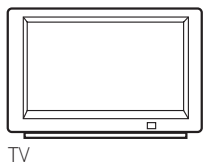

TV

Connecting digital audio sources

This receiver has both digital inputs and outputs, allowing you to connect digital components for playback and for making digital recordings. Many digital components also have analog connections for recording analog sources (such as a turntable or tape deck). See *Connecting analog audio sources* below for more on this.

1 Connect an optical digital audio output on your digital component to the DIGITAL 6 (CD-R/TAPE1/MD) input on this receiver.

- Use an optical cable for the connection.
- If your digital component only has a coaxial digital output, you can connect it to one of the coaxial inputs on this receiver using a coaxial cable. When you set up the receiver you'll need to tell the receiver which input you connected the component to (see also *Assigning the digital inputs* on page 90).
- The digital outputs from other components can be connected to any spare digital audio inputs on this receiver. You can assign them when setting up the receiver (see also *Assigning the digital inputs* on page 90).

2 Connect one of the DIGITAL outputs on this receiver to a digital input on the component.

- Use an optical cable to connect to the **DIGITAL OUT1** or **OUT2** (**OUT1** is shown in the illustration below).

Note

- In order to record some digital sources, you must make analog connections as explained in *Connecting analog audio sources* below.
- This unit has an on-board WMA9 Pro decoder, so it is possible to playback WMA9 Pro-encoded audio using a coaxial or optical digital connection when connected to a WMA9 Pro-compatible player. However, the connected PC, DVD player, set-top box, etc. must be able to output WMA9 Pro format audio signals through a coaxial or optical digital output.

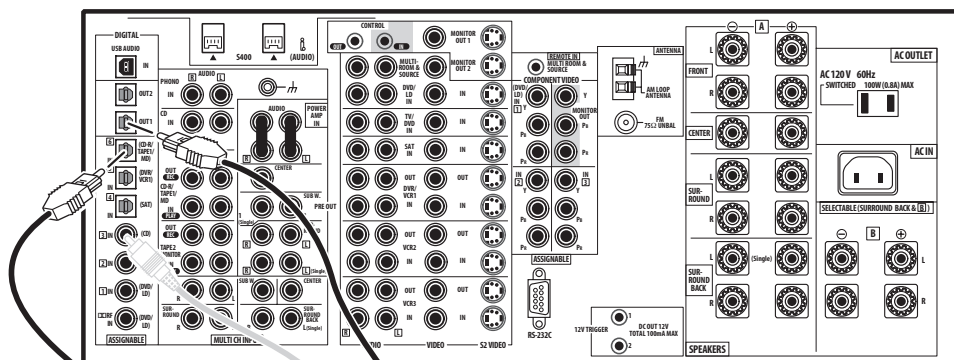

VSX-59TX1

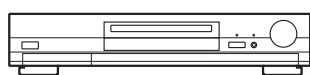
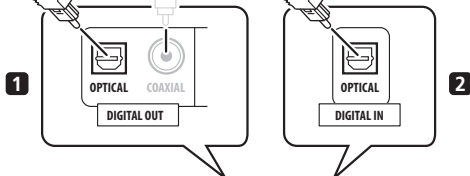

CD-R, MD, DAT, etc.

Connecting analog audio sources

This receiver features four stereo audio-only inputs. Two of these inputs have corresponding outputs for use with audio recorders.

One of the audio inputs (**PHONO**) is a dedicated turntable input which should not be used for any other type of component. This input also has a grounding terminal that most turntables require.

1 Connect the analog audio outputs of the source component to a set of spare audio inputs on this receiver.

- If you're connecting a tape deck, MD recorder, etc., connect the analog audio outputs (**REC**) to the analog audio inputs on the recorder.

- Use a stereo RCA/phono jack audio cable for the connections.
- If your cassette deck has a monitoring function, connect it to the **TAPE 2 MONITOR** jacks on the rear panel. See *Monitoring your recording* on page 75 for more on this.

2 Turntables only: Connect the stereo audio outputs to the PHONO inputs on this receiver.

- If your turntable has a grounding wire, secure it to the ground terminal on this receiver.
- If your turntable has line-level outputs (no grounding wire), connect them to the **CD** inputs instead.

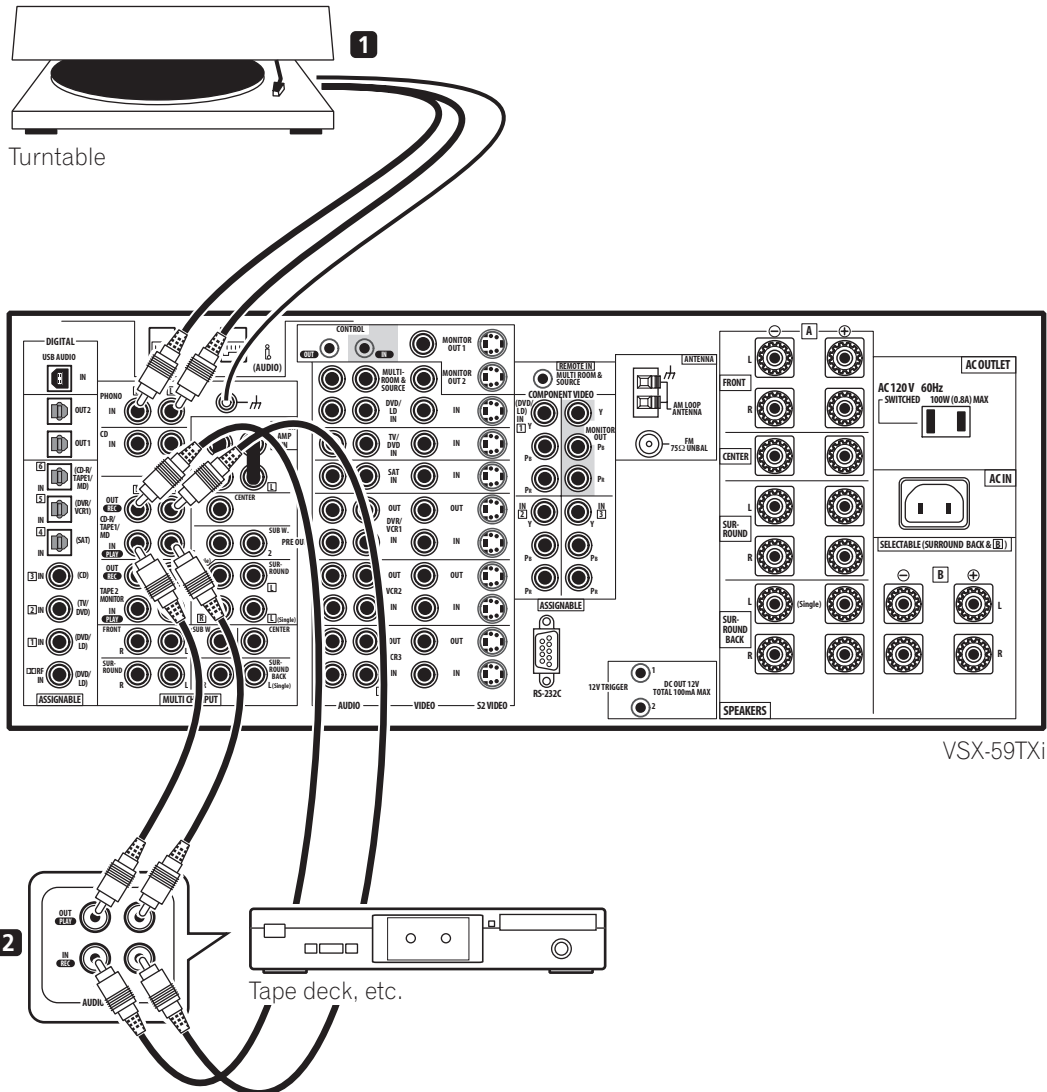

Connecting a component to the front panel inputs

The front panel inputs include a composite video jack (**VIDEO**), an S-video jack (**S-VIDEO**), stereo analog audio inputs (**AUDIO L/R**) and an optical digital audio input (**DIGITAL**). You can use these connections for any kind of audio/video component, but they are especially convenient for portable equipment such as camcorders,

video games and portable audio/video equipment.

- Pull down the front cover where indicated to access the front panel inputs.
- The illustration below shows example connections to a portable DVD player.

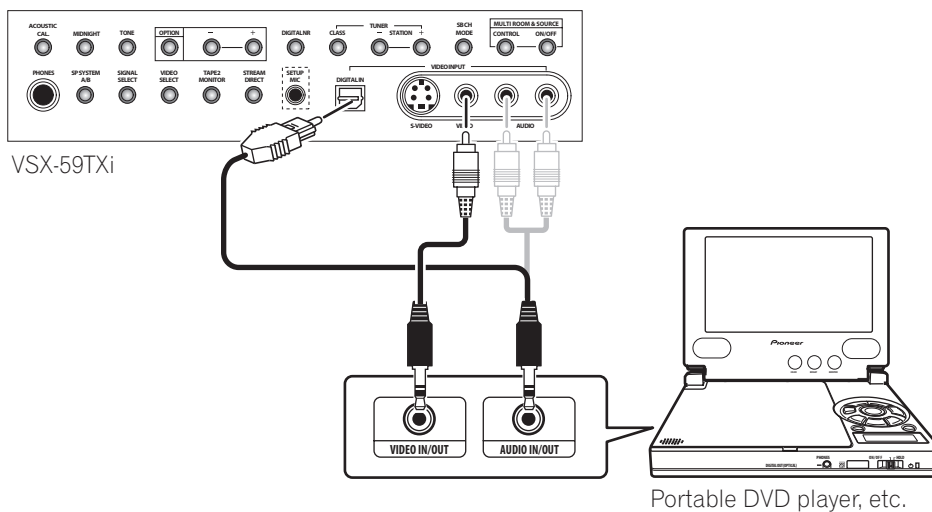

Installing your speaker system

To take full advantage of the receiver's surround sound capabilities connect front, center, surround and surround back speakers, as well as a subwoofer. Although this is ideal, other configurations with fewer speakers—no subwoofer or no center speaker, or even no surround speakers—will work. At the very least, front left and right speakers only are necessary. Note that your

main surround speakers should always be connected as a pair, but you can connect just one surround back speaker if you like (it must be connected to the left surround back terminal). You can use speakers with a nominal impedance between 4–16Ω (please see *Switching the speaker impedance* on page 78 if you plan to use speakers with an impedance of less than 6Ω).

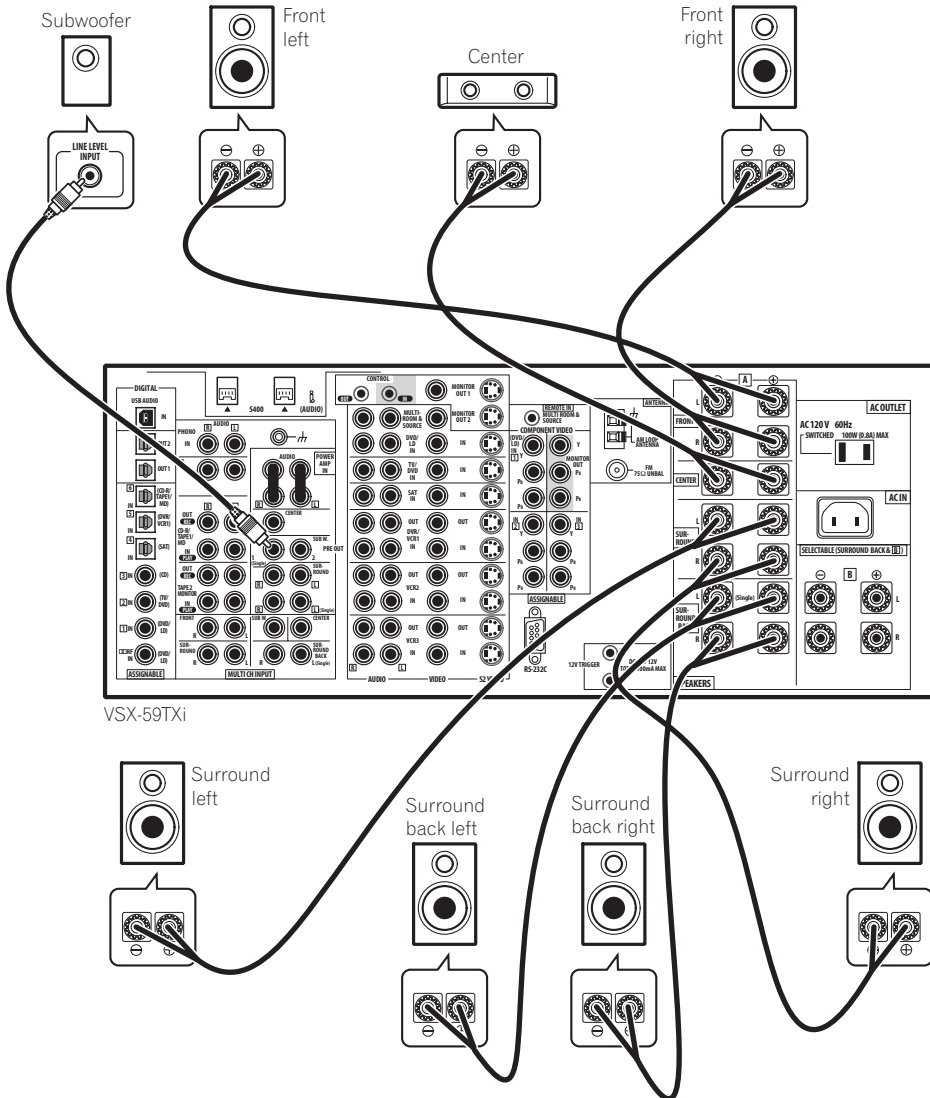

VSX-59TXi

Connecting the speakers

Each speaker connection on the receiver comprises a positive (+) red, and negative (–) white terminal. For proper sound you should take care to match these up with the terminals on the speakers themselves.

Caution

- Make sure that all the bare speaker wire is twisted together and inserted fully into the speaker terminal. If any of the bare speaker wire touches the back panel it may cause the power to cut off as a safety measure.

Bare wire connections

Before you start connecting the speakers, make sure that the speaker cable you're going to use is properly prepared with about 0.4 in. of insulator stripped from each wire, and the exposed wire strands twisted together.



To connect a terminal, unscrew the terminal a few turns until there is enough space to insert the exposed wire. Once the wire is in position, tighten the terminal until the wire is firmly clamped.

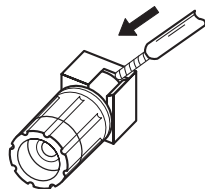

Banana plug connections

If you want to use speaker cables terminated with banana plugs, screw the speaker terminal fully shut then plug the banana plug into the end of the speaker terminal.

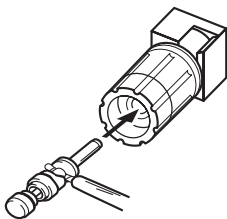

Note

- Please refer to the manual that came with your speakers for details on how to connect the other end of the speaker cables to your speakers.
- The speaker terminals on this receiver can be connected in a number of ways, depending on your setup. See *Speaker Systems* on page 58 for an overview of the possible configurations.

- *Other connections* on page 80 provides greater detail on alternate speaker setups such as using speaker system B (page 80), bi-surround (page 80), bi-amping (page 81) and bi-wiring (page 82).

Placing the speakers

Where you put your speakers in the room has a big effect on the quality of the sound. The following guidelines should help you to get the best sound from your system. (see also *Optimizing your speaker setup* on page 97).

- The subwoofer can be placed on the floor. Ideally, the other speakers should be at about ear-level when you're listening to them. Putting the speakers on the floor (except the subwoofer), or mounting them very high on a wall is not recommended.
- For the best stereo effect, place the front speakers 6–9 ft. apart, at equal distance from the TV.
- Install the center speaker above or below the TV so that the sound of the center channel is localized at the TV screen.
- When placing speakers near the TV, use magnetically shielded speakers to prevent possible interference, such as discoloration of the picture when the TV is switched on. If you do not have magnetically shielded speakers and notice discoloration of the TV picture, move the speakers farther away from the TV.
- If possible, install the surround speakers slightly above ear level.

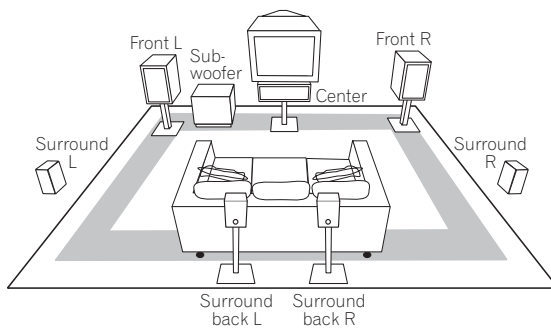

Caution

- Make sure that all speakers are securely installed. This not only improves sound quality, but also reduces the risk of damage or injury resulting from speakers being knocked over or falling in the event of external shocks such as earthquakes.

Connecting antennas

The supplied antennas provide a simple way to listen to AM and FM radio. If you find that reception quality is poor, an outdoor antenna should give you better sound quality—see *Connecting external antennas* below.

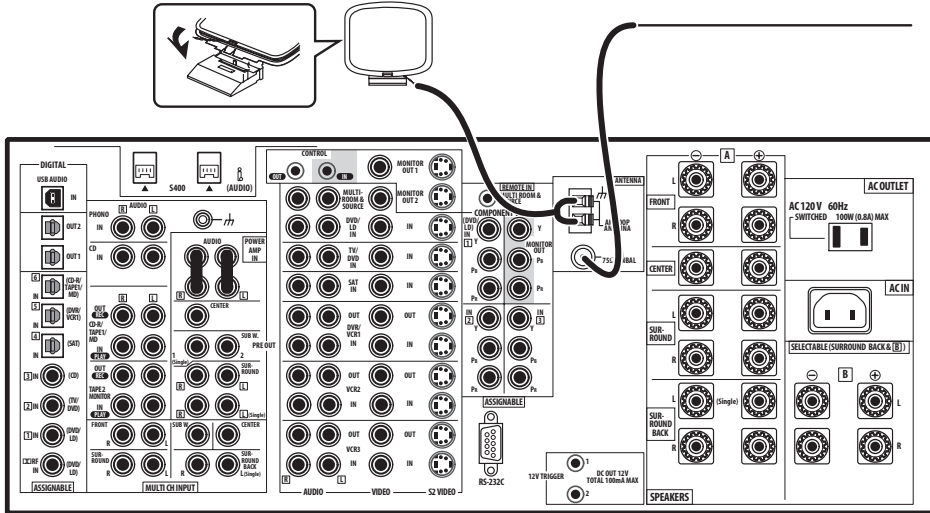

VSX-59TXi

AM loop antenna

1 Assemble the stand as shown in the illustration.

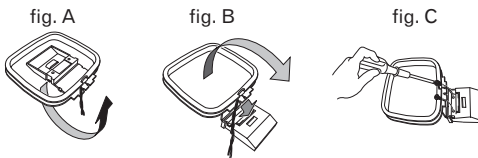

- Bend the stand in the direction indicated (fig. A).
- Clip the loop into the stand (fig. B).
- It's possible to fix the AM antenna to a wall (fig. C). Before fixing, make sure that the reception is satisfactory.

2 Pull off the protective shields of both AM antenna wires.

3 Press the AM LOOP antenna terminal tabs to open and insert one wire into each terminal.

4 Release the tabs to secure the AM antenna wires.

5 Place the AM antenna on a flat surface and point in the direction giving the best reception.

Avoid placing near computers, television sets or other electrical appliances and do not let it come into contact with metal objects.

Note

- The signal ground (⏏) is designed to reduce noise that occurs when an antenna is connected. It is not an electrical safety ground.

FM wire antenna

- Connect the FM wire antenna to the FM UNBAL 75Ω in the same way as the AM antenna.

For best results, extend the FM antenna fully and fix to a wall or door frame. Don't drape loosely or leave coiled up.

Connecting external antennas

To improve FM reception connect an external FM antenna to the FM UNBAL 75Ω.

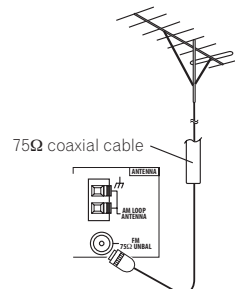

To improve AM reception, connect a 16–19 ft. length of vinyl-coated wire to the **AM LOOP** terminals without disconnecting the supplied AM loop antenna.

For the best possible reception, suspend horizontally outdoors.

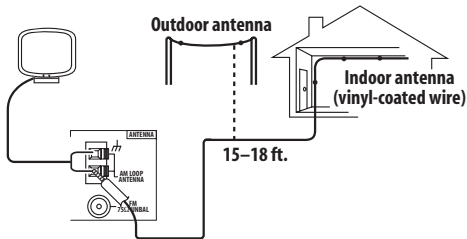

Plugging in the receiver

Only plug in after you have connected all your components, including the speakers.

Caution

- Handle the power cord by the plug part. Do not pull out the plug by tugging the cord, and never touch the power cord when your hands are wet, as this could cause a short circuit or electric shock. Do not place the unit, a piece of furniture, or other object on the power cord or pinch the cord in any other way. Never make a knot in the cord or tie it with other cables. The power cords should be routed so that they are not likely to be stepped on. A damaged power cord can cause a fire or give you an electric shock. Check the power cord once in a while. If you find it damaged, ask your nearest Pioneer authorized service center or your dealer for a replacement.

1 Plug the supplied power cord into the AC IN socket on the back of the receiver.

2 Plug the other end into a power outlet.

About the AC outlet

Power supplied through this outlet is turned on and off by the receiver's power switch. Total electrical power consumption of connected equipment should not exceed 100 W (0.8 A).

Caution

- Do not connect a monitor, TV set, heater, or similar appliance to this unit's AC outlet.
- Do not connect appliances with high power consumption to the AC outlet in order to avoid overheating and fire risk. This can also cause the receiver to malfunction.

Chapter 3

Controls and displays

Front panel

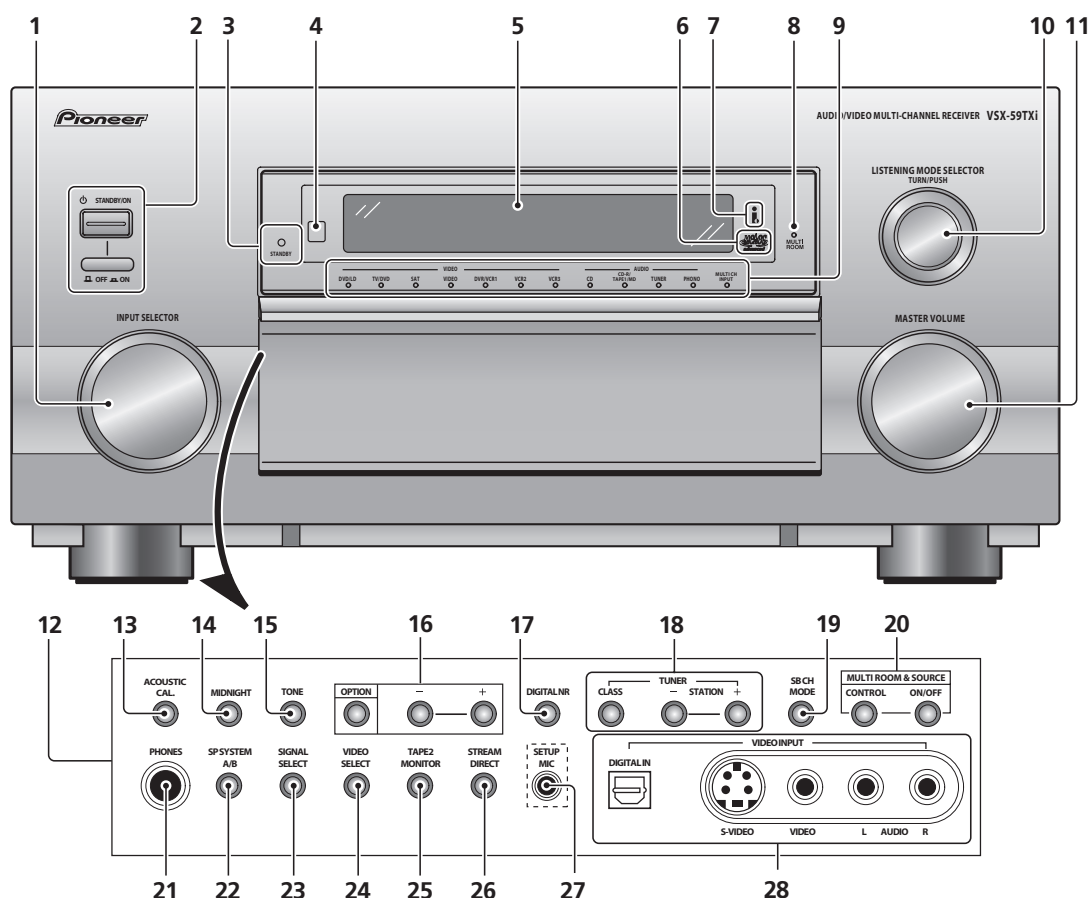
**1 INPUT SELECTOR dial** (page 41)

Turn to select a source component. The input indicators show the current component.

2 **STANDBY/ON** and **power OFF** / **ON**

Press **STANDBY/ON** to switch the receiver on or into standby. The **OFF** / **ON** switch turns of the main power (you can't switch on using the remote when it is in the **OFF** position).

3 STANDBY indicator

Lights when the receiver is in standby.

4 Remote sensor

Receives the signals from the remote control.

5 Display

See *Remote control* on page 33.

6 MCACC indicator (page 48)

Lights when Acoustic Calibration EQ is on. **Acoustic Cal EQ** is automatically set after the Auto Surround Setup has been completed.

7 i.LINK indicator (page 85)

Lights when an i.LINK-Audio-equipped component is selected.

8 MULTI ROOM indicator (page 83)

Shows whether the multi-room function is active or not.

9 Input indicators

Shows the currently selected source component. The **MULTI CH INPUT** indicator lights when a component connected to the **MULTI CH INPUT** is selected. Nothing lights if an unassigned i.LINK-equipped component or USB connection is selected.

10 LISTENING MODE SELECTOR dial (page 43)

Turn and push to select a listening mode.

11 MASTER VOLUME dial

Adjusts the volume.

12 Front panel controls

To access the front panel controls, push gently on the lower third portion of the panel with your finger.

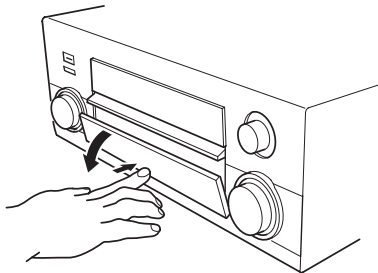

13 ACOUSTIC CAL. (page 48)

Press to switch Acoustic Calibration EQ on or off.

14 MIDNIGHT (page 52)

Press to switch **MIDNIGHT** mode on/off.

15 TONE

Press to switch between **TONE ON** and **TONE BYPASS**, which bypasses the tone controls.

16 OPTION (-/+)

Press **OPTION** repeatedly to select an option menu item, then use **-/+** to adjust the settings.

17 DIGITAL NR (page 53)

Press to switch **DIGITAL NR** on/off.

18 TUNER controls (page 55)

Use the front panel tuner controls for recalling station presets.

19 SB CH MODE (page 50)

Use to select the surround/virtual back channel mode.

20 MULTI ROOM & SOURCE controls

If you've made multi-room connections (see *Multi-room setup* on page 83) use these controls to control the sub room from the main room (see *Using the sub room controls* on page 84).

21 PHONES jack (page 46)

Use to connect headphones (no sound will be heard through the speakers).

22 SP SYSTEM A/B (page 82)

Press repeatedly to select speaker system **A, B, A/B** or off (in that order). (See *Using speaker system B* on page 80 for exceptions to this).

23 SIGNAL SELECT (page 48)

Press to select the type of input signal for the current source (**DVD, DVR/VCR**, etc.), and also to select the number of input channels for the USB and analog multichannel inputs.

24 VIDEO SELECT (page 76)

Press repeatedly to select the video source.

25 TAPE 2 MONITOR (page 75)

Press to monitor recordings on the device connected to the **TAPE 2 MONITOR** inputs/outputs as they are being made.

26 STREAM DIRECT (page 47)

Press to switch on/off Stream Direct.

27 SETUP MIC jack

Use to connect the supplied microphone.

28 VIDEO INPUT jacks (page 25)

- **DIGITAL IN** – Connect a game console, portable DVD player, video camera (etc.), that has an optical digital connection.
- **S-VIDEO** – Connect a video camera (etc.), that has an S-video out.
- **VIDEO / AUDIO (L/R)** – Connect a video camera, etc. that has standard RCA video/audio outputs.

Display

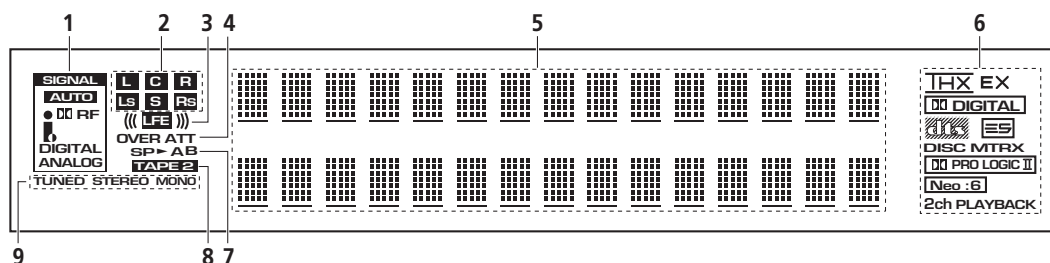

1 SIGNAL indicators (page 75)

Light to indicate the currently selected input signal.

AUTO lights when the receiver is set to select the input signal automatically.

2 Program format indicators

These change according to which channels are active in Dolby, DTS, DVD-A and SACD sources.

LS, S and **RS** will light at the same time to indicate 6.1 channel sources.

- **L** – Left front channel
- **C** – Center channel
- **R** – Right front channel
- **LS** – Left surround channel
- **S** – Surround channel (mono)
- **RS** – Right surround channel
- **LFE** – Low frequency effects channel

3 ((()))

Lights when an LFE signal is being input.

4 Analog level indicators

OVER indicator

Lights when an analog input signal is too high, risking distortion. Use the input attenuator to reduce the level.

ATT indicator (page 76)

Lights when the input attenuator is on.

5 Character display

6 Digital format indicators

- **DIGITAL** – Lights when a Dolby Digital signal is detected.
- **DTS** – Lights when a DTS signal is detected.
- **THX** – Lights when one of the Home THX modes is selected.
- **EX** – Lights during Surround EX matrix processing.
- **ES** – Lights when a decoding DTS-ES audio.
- **DISC** – Lights during DTS-ES discrete processing.

- **MTRX** – Lights during DTS-ES matrix processing.

- **PRO LOGIC II** – Lights during Dolby Pro Logic II and Pro Logic IIx processing.

- **Neo:6** – Lights during Neo:6 processing with 2-channel sources.

- **2ch PLAYBACK** – Lights during two-channel playback.

7 Speaker indicators

Light to indicate the current speaker system, **A** and/or **B**.

8 TAPE 2 (page 75)

Lights when the **TAPE 2** monitor is switched on.

9 Tuner indicators

STEREO (page 55)

Lights when listening to a stereo FM broadcast in auto/stereo mode.

TUNED

Lights when tuned to a broadcast.

MONO (page 55)

Lights when the tuner MPX mode is set to mono.

Remote control

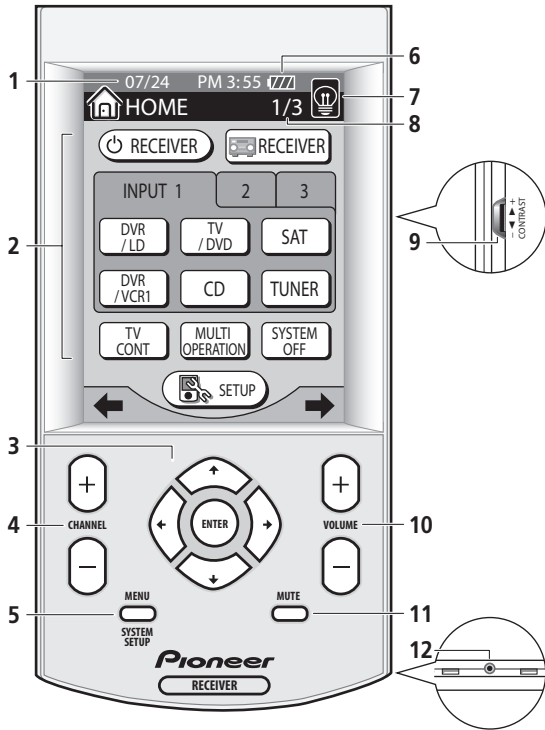

1 Date and time display

See *Setting the clock* on page 10 to set this to the current time.

2 LCD touch screen

The LCD touch screen appears when the screen is touched or a button on the remote control is pressed.

3 Cursor hard keys and ENTER

Use to navigate menus and select options/execute commands.

4 CHANNEL +/-

Use to select channels.

5 MENU / SYSTEM SETUP

Use to display the System Setup menu (or a menu when controlling other components, such as a DVD or TV).

6

Displays the rechargeable battery status. The recharge indicator () shows when the remote is being recharged.

7

Press to switch the touch screen backlight on or off.

8 Menu screen number

Displays the screen number in the current menu, as well as the number of screens.

9 Contrast control

Use to adjust the contrast of the LCD touch screen.

10 VOLUME +/-

Use to adjust the volume.

11 MUTE

Press to mute all output. Press again (or adjust the volume using the **MASTER VOLUME** control) to restore the sound.

12 Servicing terminal

For use by Pioneer service technicians.

Basic remote control displays

The remote control LCD touch screen has a number of displays from which you can control receiver functions, as well as control operations for other components. The basic menu screens are explained here.

Home menu screens

There are three Home menu screens, which can be navigated by using the touch panel (cursor left/right) soft keys or **INPUT 1, 2 or 3**.

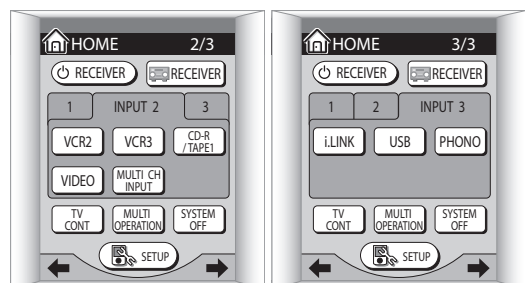
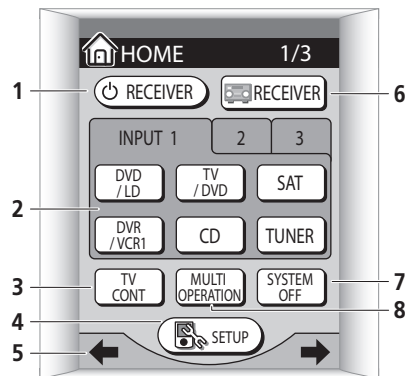

1 RECEIVER

Press to switch the receiver on or into standby.

2 INPUT 1 / 2 / 3

Press **1**, **2** or **3** to find the screen with the input source you want. After pressing the appropriate button to choose a source, you are taken to the corresponding function menu (see *Operating menus for additional components* below).

3 TV CONT

Press to access the TV control menu (see *TV control menu screens* below).

4 SETUP

Press to access the remote control setup menu (see *Setting up the remote control* on page 9).

5 ←/→ (soft keys)

Press to go to the previous/next Home menu screen.

6 RECEIVER

Press to go to the receiver main menu (see *Receiver menu screens* below).

7 SYSTEM OFF (page 72)

Press to switch off all Pioneer components in your system, or any other component you have also programmed to switch off using the System Off function.

8 MULTI OPERATION (page 72)

Use this button to perform multi operations.

Receiver menu screens

There are four receiver menu screens, which can be navigated by using the touch panel ←/→ (cursor left/right) soft keys.

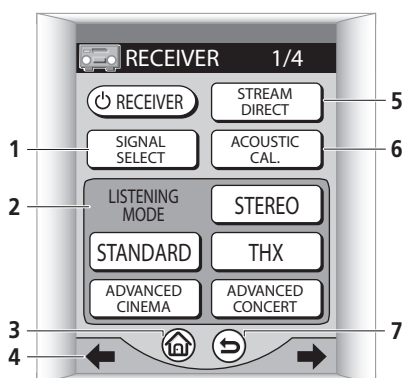
**1 SIGNAL SELECT** (page 48)

Press to select the type of input signal for the current source (**DVD**, **DVR/VCR**, etc.), and also to select the number of input channels for the USB and analog multichannel inputs.

2 LISTENING MODE selector (page 43)

Use to select a listening mode.

3

Press to return to the main Home menu (see *Home menu screens* above).

4 ←/→ (soft keys)

Press to go to the previous/next receiver menu screen.

5 STREAM DIRECT (page 47)

Press to select a Stream Direct mode.

6 ACOUSTIC CAL. (page 48)

Press to select an acoustic calibration EQ setting.

7

Press to go to the previous screen (or set of screens).

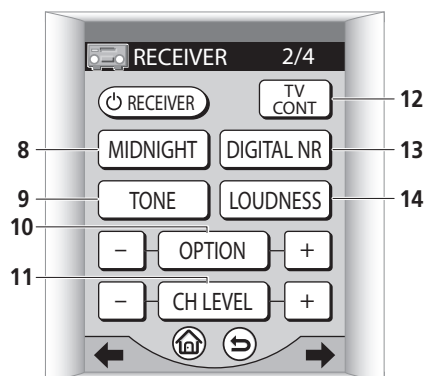
**8 MIDNIGHT** (page 52)

Press to switch on/off Midnight listening.

9 TONE (page 52)

Press to switch the tone controls on/off.

10 OPTION (-/+)

Press **OPTION** repeatedly to select an option menu item, then use **-/+** to adjust the settings.

11 CH LEVEL (+/-) (page 60)

Press **CH LEVEL** repeatedly to select a channel, then use **-/+** to adjust the level.

12 TV CONT

Press to access the TV control menu (see *TV control menu screens* below).

13 DIGITAL NR

Press to switch digital noise reduction on/off (see *Reducing noise during playback* on page 53).

14 LOUDNESS (page 52)

Press to switch Loudness on/off.

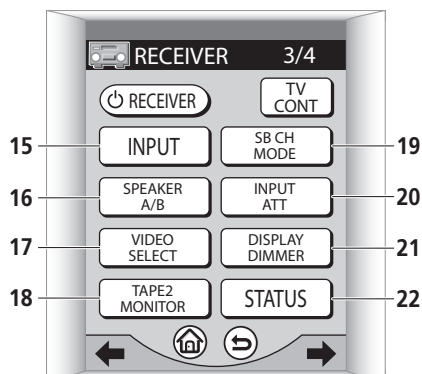

15 INPUT (page 41)

Press repeatedly to cycle through all possible input sources.

16 SPEAKER A/B (page 82)

Press repeatedly to select speaker system **A.B, A/B** or off (in that order). (See *Using speaker system B* on page 80 for exceptions to this).

17 VIDEO SELECT (page 76)

Press repeatedly to select the video source.

18 TAPE 2 MONITOR (page 75)

Press to monitor recordings on the device connected to the **TAPE 2 MONITOR** inputs/outputs as they are being made.

19 SB CH MODE (page 50)

Use to select the surround/virtual back channel mode.

20 INPUT ATT (page 76)

Press to switch the input attenuator on/off.

21 DISPLAY DIMMER (page 77)

Use to adjust the brightness of the front panel display.

22 STATUS (page 78)

Press to check selected receiver settings.

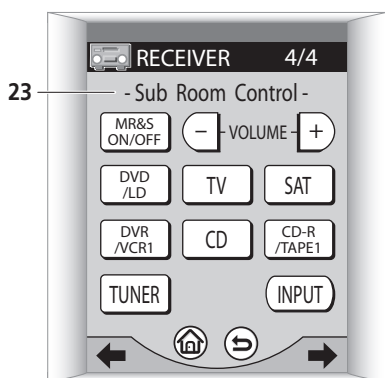

23

23 Sub Room Control (page 84)

Use this menu screen to control your sub room setup (if you've made multi-room connections). The source and **INPUT** buttons select input sources, and **VOLUME (+/-)** controls the sub room volume. Press **MR&S ON/OFF** to use the buttons on this screen in the sub room.

Remote control displays for the tuner

The functions on these screens are used to control the tuner (see also *Using the tuner* on page 54).

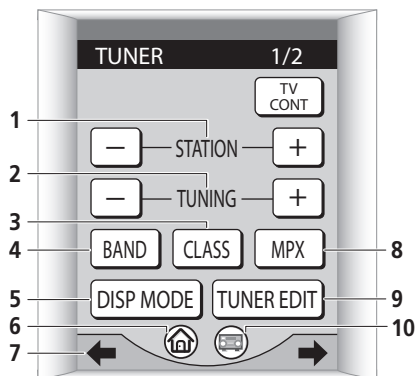

1 STATION + / - (page 55)

Press to select station presets.

2 TUNING + / - (page 54)

Use to select a listening mode.

3 CLASS (page 55)

Press to switch between the three banks (classes) of station presets.

4 BAND (page 54)

Press to switch between AM and FM radio bands.

5 DISP MODE (page 56)

Press to switch between the frequency display and the station name display.

6

Press to return to the main Home menu (see *Home menu screens* above).

7 (soft keys)

Press to go to the previous/next receiver menu screen.

8 MPX (page 55)

Press to listen to a radio broadcast in mono.

9 TUNER EDIT (page 55)

Press to memorize and name a station preset.

10

Press to go to the receiver main menu (see *Receiver menu screens* above).

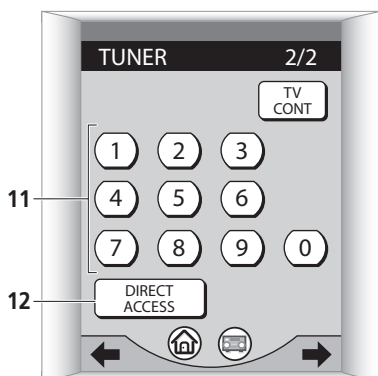
**11 Number buttons** (page 56)

Use to input a radio frequency.

12 DIRECT ACCESS (page 55)

After pressing, you can access a radio station directly using the number buttons.

Remote control displays for other components

The functions on these screens are available once you've programmed the remote to control the appropriate component (for example, your TV or DVD player). See *Using the remote control with other components* on page 67 for more on this. These screens work in tandem with the remote control hard keys (see *Remote control* above).

TV control menu screens

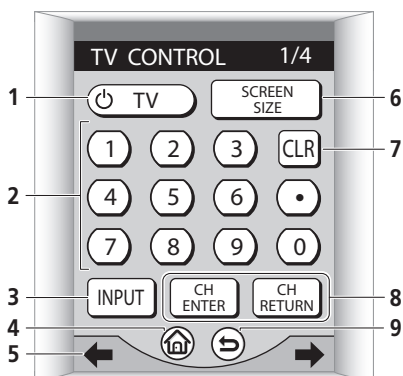
**1** TV

Press to switch TV power on/off.

2 **Number buttons**

Use to select a channel directly.

3 **INPUT**

Use to select the audio/video input source.

4

Press to return to the main Home menu (see *Home menu screens* above).

5 **(soft keys)**

Press to go to the previous/next TV control menu screen.

6 **SCREEN SIZE**

Use to select the screen size on your TV.

7 **CLR**

Press to clear an entry.

8 **CH ENTER**

Use to enter channel selections directly.

CH RETURN

Press to return to the channel last selected.

9

Press to go to the previous screen (or set of screens).

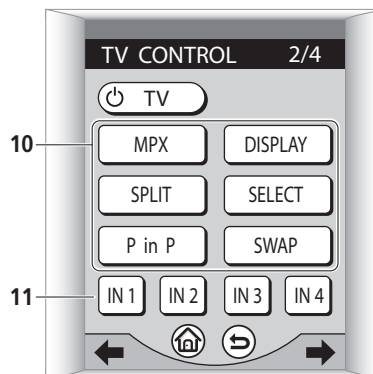
**10** **MPX**

Press to mute/restore the sound.

DISPLAY

Press to change the display.

SPLIT

Press to split the screen.

SELECT

Press to select items on-screen.

P in P

Use for picture-in-picture.

SWAP

Press to swap small and large pictures with P in P.

11 IN1 / IN2 / IN3 / IN4

These are unassigned buttons which can be used to learn new commands. See *Programming signals from other remote controls* on page 69 for more on this.

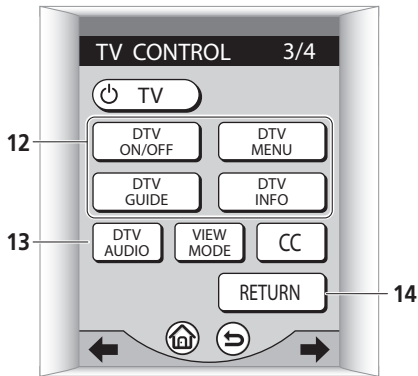

12 DTV controls

DTV ON/OFF

Press to switch the digital TV on/off.

DTV MENU

Press to display the DTV menu.

DTV GUIDE

Press to access the digital TV guide.

DTV INFO

Press to display the DTV information screen.

13 DTV AUDIO

Press to switch between DTV audio options.

VIEW MODE

Press to switch between view modes available.

CC

Press to switch close-captioning on/off.

14 RETURN

Press to return to the DTV main menu.

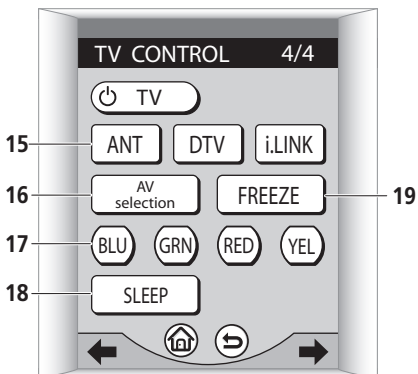

15 ANT / DTV / i.LINK

Use to select the type of antenna, DTV, or i.LINK component you've connected to your TV.

16 AV selection

Press to select the programmed picture quality mode.

17 BLU / GRN / RED / YEL

Use to make selections from a DTV menu.

18 SLEEP

Press to set the TV sleep timer.

19 FREEZE

Press to freeze the picture when using a plasma display.

Operating menus for additional components

The example below shows the DVD menu screen.

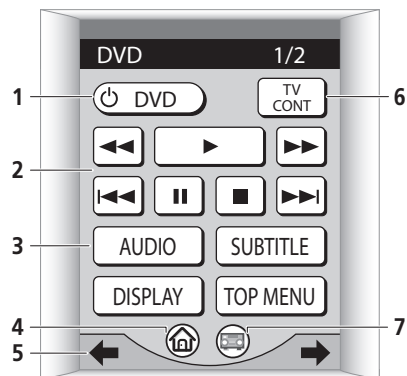

1 DVD

Press to switch DVD power on/off.

2 Playback buttons

◀▶ (backward/forward scan)

Press and hold for fast backward/forward scanning

▶ (play)

Press to start or resume playback.

◀▶▶ (backward/forward skip)

Press ◀▶ to jump back to the beginning of the current chapter or track, then to previous chapters. Press ▶▶ to jump to the next chapter or track.

■ (stop)

Press to stop the disc (you can resume playback by pressing ▶ (play)).

⏸ (pause)

Press to pause playback. Press again to restart.

3 AUDIO

Press to select the audio channel or language.

SUBTITLE

Press to select a subtitle display.

DISPLAY

Press to display/change disc information shown on-screen.

TOP MENU

Press to display the top menu of a DVD disc.

4 

Press to return to the main Home menu (see *Home menu screens* above).

5  **(soft keys)**

Press to go to the previous/next TV control menu screen.

6 TV CONT

Press to access the TV control menu (see *TV control menu screens* above).

7 

Press to go to the receiver main menu (see *Receiver menu screens* above).

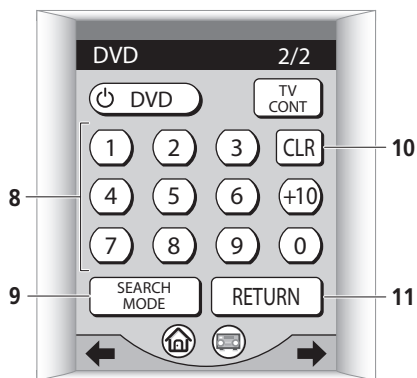
**8 Number buttons**

Use to directly access tracks, chapters and titles.

9 SEARCH MODE

Use to access the search mode (to jump to a particular part of the disc).

10 CLR

Press to clear an entry.

11 RETURN

Press to return to a previous menu screen.

Chapter 4

Getting started

Introduction to home theater

You are probably used to using stereo equipment to listen to music, but may not be used to home theater systems that give you many more options (such as surround sound) when listening to soundtracks.

Home theater refers to the use of multiple audio tracks to create a surround sound effect, making you feel like you're in the middle of the action or concert. The surround sound you get from a home theater system depends not only on the speakers you have set up in your room, but also on the source and the sound settings of the receiver.

DVD-Video has become the basic source material for home theater due to its size, quality, and ease of use. The true multichannel audio possible using DVD is what creates a convincing surround sound effect and gives you the feeling of 'being there'.

Follow the steps in *Automatically setting up for surround sound* below to achieve the best possible surround sound by calibrating this receiver to your listening area.

Automatically setting up for surround sound

The Auto Surround Setup measures the acoustic characteristics of your listening area, taking into account ambient noise, speaker size and distance, and tests for both channel delay and channel level. After you have set up the microphone provided with your system, the receiver uses the information from a series of test tones to optimize the speaker settings and equalization for your particular room.

Make sure you do this before moving on to *Playing a source* on page 41.

Important

- Make sure the microphone and speakers are not moved during the Auto Surround Setup.
- Using the Auto Surround Setup will overwrite any existing speaker settings in the receiver.
- After three minutes of inactivity during the Auto Surround Setup, the OSD will go to sleep until a button is pressed.

Caution

- The test tones used in the Auto Surround Setup are output at high volume.

1 Switch on the receiver and your TV.

If headphones are connected to the receiver, disconnect them.

2 Connect the microphone to the SETUP MIC jack on the front panel.

Make sure there are no obstacles between the speakers and the microphone.

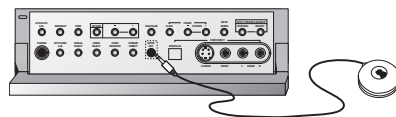

If you have a tripod, use it to place the microphone so that it's about ear level at your normal listening position. Otherwise, place the microphone at ear level using a table or a chair.

3 Using the remote control, press RECEIVER on the touch screen, then press the SYSTEM SETUP button.



An on-screen display (OSD) appears on your TV. Use the **↑/↓/←/→** hard keys and **ENTER** on the remote control to navigate through the screens and select menu items.

- The **↑/↓** (cursor up/down) hard keys select menu items and the **←/→** (cursor left/right) hard keys change the setting of the item selected.

4 'Auto Surround Setup' should be highlighted. Press ENTER.

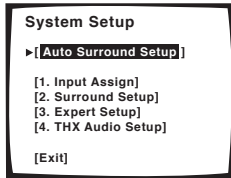

5 Specify how you are using your speaker system. Highlight 'Go Next' then press ENTER.

If you are using a normal surround setup, or if you're not sure, leave the settings at their default:

- **Speaker System Select – Normal Surround**
- **SP-B (speaker system B) – Second Zone**
- **X-Curve – ON**

For settings other than the default, see *Speaker Systems* on page 58.

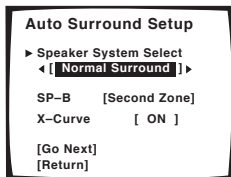

6 Follow the instructions on-screen.

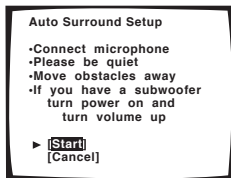

- Make sure the microphone is connected.
- If you're using a subwoofer, switch it on and turn up the volume.
- See below for notes regarding high background noise levels and other possible interference.

7 Make sure 'Start' is selected, then press ENTER.

A progress report is displayed on-screen while the receiver outputs test tones to determine the speakers present in your setup. Try to be as quiet as possible while it's doing this.

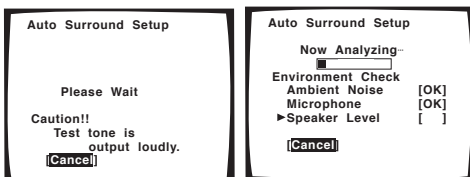

- Do not to turn down the volume during the test tones. This may result in incorrect speaker settings.

8 Confirm the speaker configuration in the OSD.

The configuration shown on-screen should reflect the actual speakers you have.

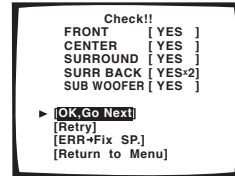

If the speaker configuration displayed isn't correct, use the ↑/↓ (cursor up/down) buttons to select **Retry**, then press **ENTER**. Follow the instructions from step 6.

If the configuration is incorrect and you want to input the settings manually, select **ERR→Fix SP** then press **ENTER**. Use ↑/↓ (cursor up/down) to select the speaker then ←/→ (cursor left/right) to specify the size (and number for surround back). When you're finished, go to the next step.

If you see an **ERR** message in the right side column, there may be a problem with the speaker connection. If selecting **Retry** (above) doesn't fix the problem, turn off the power and check the speaker connections.

9 Make sure 'OK, Go Next' is selected, then press ENTER.

A progress report is displayed on-screen while the receiver outputs more test tones to determine the optimum receiver settings for channel level, speaker distance, and acoustic calibration EQ.

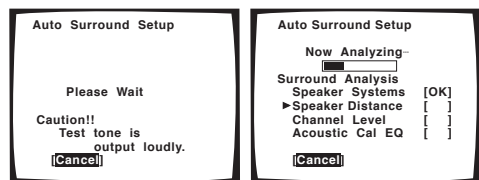

Again, try to be as quiet as possible while this is happening. It may take up to 6 minutes.

10 The Auto Surround Setup has finished! Press SYSTEM SETUP to exit the System Setup menu.

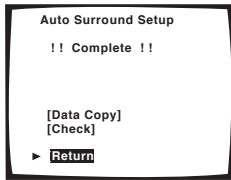

The settings made in the Auto Surround Setup should give you excellent surround sound from your system, but it is also possible to adjust these settings manually using the Surround Setup menu (starting on page 57).

If you plan to go on and make advanced settings at this point, you can select **Data Copy** to start customizing your surround sound settings. See *Acoustic Calibration EQ* on page 61 for more on this.

You can also choose to view all the settings by selecting **Check**. See *Checking your surround settings* on page 66 for more on this.

If you selected **Return**, you can select **Exit** to leave the System Setup menu screen.

Note

- If you select **Cancel** at any time during the Auto Surround Setup, the receiver automatically exits and no settings will be made.
- Remember to disconnect the microphone after you've finished the Auto Surround Setup.

Other problems when using the Auto Surround Setup

If the room environment is not optimal for the Auto Surround Setup (too much background noise, echo off the walls, obstacles blocking the speakers from the microphone) the final settings may be incorrect. Check for household appliances (air conditioner, fridge, fan, etc.), that may be affecting the environment and switch them off if necessary.

Some older TVs may interfere with the operation of the microphone. If this seems to be happening, switch off the TV when doing the Auto Surround Setup.

Checking the settings on your DVD (or other) player

Before continuing, you may want to check the digital audio output settings on your DVD player and digital satellite receiver.

- **Check that your DVD player/satellite receiver is set to output Dolby Digital, DTS and 88.2/96kHz PCM (2 channel) audio.**

If there is an option for MPEG audio, set this to convert the MPEG audio to PCM.

If you connected the multichannel analog outputs of the player to this receiver, make sure that the player is set to output multichannel analog audio.

Note

- Depending on your DVD player or source discs you may only be able to output analog and stereo digital audio. In this case you need to change the listening mode to **SURROUND** if you want multichannel surround sound.

Playing a source

Here are the basic instructions for playing a source (such as a DVD disc) with your home theater system.

1 Turn on the power of the playback component (for example a DVD player), your TV and subwoofer (if you have one).

- If your source is the TV's built-in tuner, then switch to the channel you want to watch, otherwise make sure that the TV's video input is set to this receiver. (For example, if you connected this receiver to the **VIDEO 1** jacks on your TV, make sure that **VIDEO 1** input is now selected.)

2 If the receiver isn't already on, press **RECEIVER** to switch it on.



3 Change the receiver input to the source you want to play.

You can use the front panel **INPUT SELECTOR** knob or the dedicated **INPUT** buttons on the remote control touch screen Home menu (see *Basic remote control displays* on page 33 if you're unsure how to do this).

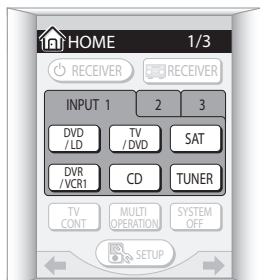

4 Start playback of the DVD (or other component).

If you're playing a Dolby Digital or DTS surround sound DVD disc, you should hear surround sound. If you are playing a stereo source, you will only hear sound from the front left/right speakers in the default listening mode.

- See also *Listening to your system* on page 43 for more information on different ways of listening to sources.

5 Use the MASTER VOLUME control (front panel or remote) to adjust the volume level.

- Turn down the volume of your TV so that all the sound is coming from the speakers connected to this receiver.

Note

- If you need to manually switch the input signal type from digital to analog (stereo or multichannel), press **SIGNAL SELECT** on the front panel or from the remote control receiver menu (see also *Using other functions* on page 75).
- For more detailed surround sound setup, see *The Surround Setup menu* on page 57.
- With WMA9 Pro, sound problems may occur depending on your computer system. WMA9 Pro 7.1 channel 96kHz sources will be downsampled to 5.1 channel 48kHz. If sound problems occur please connect using the USB interface (see *Using the USB interface* on page 87).

Chapter 5

Listening to your system

About the listening modes

Using this receiver you can enjoy listening to sources, analog or digital, in either stereo or surround sound. However, the listening mode options and the current active mode may change depending on your speaker setup and the type of source you're listening to.

Note

- The remote control operations in this section are accessed from the various receiver menus (for a more detailed explanation, see *Receiver menu screens* on page 34). To go to the receiver menu, press **RECEIVER** from the remote control Home menu (🏠) and use the **←/→** (cursor left/right) soft keys to go to the previous/next screen.

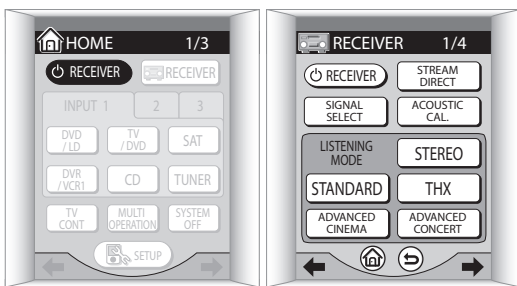

- You can't select listening modes when the Stream Direct mode (see page 47) is switched on.
- With the WMA9 Pro format, 2-channel sources can only be heard in stereo, and you can't select the **DIGITAL** or **DTS** modes with multichannel sources.

Listening in surround sound

Using this receiver, you can listen to any source in surround sound. However, the options available will depend on your speaker setup and the type of source you're listening to.

If you connected surround back speakers, see also *Using the surround back channel* on page 50.

See also *Using the Advanced surround effects* and *Using the Home THX modes* below for further stereo and surround playback options.

Tip

- In the steps below, you can also use the front panel **LISTENING MODE SELECTOR** dial instead of the remote control to select listening modes. Simply turn the dial to cycle through the available options, pressing forward to select a mode.
- While listening to a source, press STANDARD for surround sound playback.**



With multichannel sources (such as DVDs and digital satellite broadcasts), the **DIGITAL** or **DTS** indicator on the front panel lights depending on the source format. Any active Advanced surround or Home THX mode is canceled.

With two channel sources, press **STANDARD** repeatedly to select from:

- DIGITAL Pro Logic IIx MOVIE** – Up to 7.1 channel sound, especially suited to movie sources (the display shows **5CH MOVIE+VSB** with the **VSB MODE** switched on)
 - DIGITAL Pro Logic IIx MUSIC** – Up to 7.1 channel sound, especially suited to music sources (the display shows **5CH MUSIC+VSB** with the **VSB MODE** switched on)
 - PRO LOGIC** – 4.1 channel surround sound with sound from the surround speakers in mono (the display shows **5CH SURR+VSB** with the **VSB MODE** switched on)
- 7 CH SURROUND** is displayed instead of **PRO LOGIC** when the **SB CH MODE** is switched on
- NEO:6 CINEMA** – 6.1 channel sound, especially suited to movie sources
 - NEO:6 MUSIC** – 6.1 channel sound, especially suited to music sources

With multichannel sources, if you have connected surround back speaker(s) and have selected **SB CH MODE ON**, you can press **STANDARD** repeatedly to select:

- **Pro Logic IIx MOVIE** – See above
- **Pro Logic IIx MUSIC** – See above
- **SX** (Studio extension) – Adds surround back channel sound (taken from the left/right surround output) to 5.1 channel sources
- **EX** (Extension decode) – Creates surround back channel sound for 5.1 channel sources and provides pure decoding for 6.1 channel sources (like Dolby Digital Surround EX and DTS-ES)

Note

- If the **SB CH MODE** is switched to **OFF**, or the surround back speakers are set to **NO**, **Pro Logic IIx** (above) becomes **Pro Logic II** (5.1 channel sound).
- In modes that give 6.1 channel sound, the same signal is heard from both surround back speakers.

Dolby Pro Logic IIx Music settings

When listening in Dolby Pro Logic IIx Music mode, there are three further parameters you can adjust: Center Width, Dimension, and Panorama.

1 With 'Pro Logic IIx MUSIC' mode active, press OPTION repeatedly to select CENTER WIDTH, DIMENSION or PANORAMA.

The remote control menu for this step is shown below (see note at the start of this chapter if you need help).

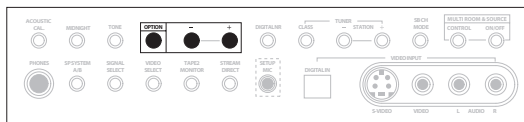

- **CENTER WIDTH** – Makes the center channel wider (higher settings) or narrower (lower settings)
- **DIMENSION** – Makes the sound more distant (minus settings), or more forward (positive settings)
- **PANORAMA** – Creates more spacious surround sound

2 Use the (OPTION) +/- buttons to adjust the setting.

Center Width is adjustable between **0** and **7** (default : **3**); Dimension between **-3** and **+3** (default : **0**); Panorama is **On** or **Off** (default : **Off**).

3 Press OPTION again to adjust other settings.

Note

- If the **SB CH MODE** is switched to **OFF**, **Pro Logic IIx** (above) becomes **Pro Logic II** (5.1 channel sound), however the above setting will still be effective.

Neo:6 Music settings

When listening in Neo:6 Music mode, you can adjust the center image to create a wider stereo effect with vocals.

1 With NEO:6 MUSIC mode active, press OPTION repeatedly to select CENTER IMAGE.

The remote control menu for this step is shown below (see note at the start of this chapter if you need help).

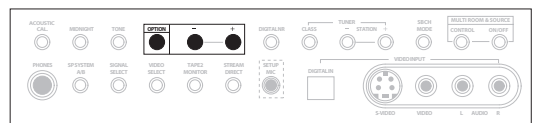

2 Use the (OPTION) +/- buttons to adjust the setting.

Adjust the effect from **0** (no effect) to **10** (most prominence given to the center channel). The default setting is **3**.

Using the Advanced surround effects

The Advanced surround effects can be used for a variety of additional surround sound effects. The Advanced Cinema modes are designed to be used with movies, and the Advanced Concert modes are for music.

- Press **ADVANCED CINEMA** or **ADVANCED CONCERT** to select a listening mode.



Press **ADVANCED CINEMA** repeatedly to select from:

- **ACTION** – Designed for action movies with dynamic soundtracks
- **SCI-FI** – Designed for science fiction with lots of special effects
- **DRAMA** – Designed for movies with lots of dialog
- **MUSICAL** – Creates a concert hall-type sound for musicals
- **MONOFILM** – Creates surround sound from mono soundtracks
- **5/7-D THEATER** – Creates an extra wide stereo field

Press **ADVANCED CONCERT** repeatedly to select from:

- **CLASSICAL** – Gives a large concert hall-type sound
- **CHAMBER** – Creates a space with alot of reverb
- **JAZZ** – Creates the sound of a small jazz club
- **ROCK** – Creates a live concert sound for rock music
- **DANCE** – Designed for music with lots of bass
- **5/7CH STEREO** – Allows you to hear stereo sources from all the speakers in your setup

Adjusting the Advanced Surround effect level

You can emphasize or reduce the effect of the Advanced Surround modes as you like. For each Advanced Surround mode you can set the effect level independently.

- 1 With one of the Advanced surround modes active, press **OPTION** repeatedly until **EFFECT** shows in the front panel display.

The remote control menu for this step is shown below (see note at the start of this chapter if you need help).

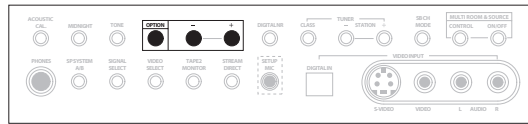

- 2 Use the **(OPTION) +/-** buttons to adjust the effect level.

The effect level can be adjusted from **10** (min) to **90** (max).

Using the Home THX modes

THX and Home THX are technical standards created by THX, Ltd. for cinema and home theater sound. Home THX is designed to make home theater audio sound more like what you hear in a cinema. See *About THX®* on page 109 for more on this.

Different THX options will be available depending on the source and the **SB CH** mode setting (see *Using the surround back channel* on page 50 for more on this).

- Press **THX** to select a THX listening mode.

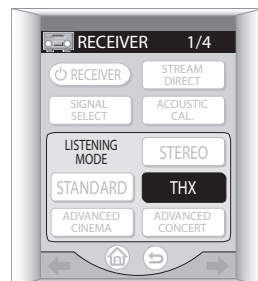

With two channel sources, press **THX** repeatedly to select a matrix-decoding process for the **THX CINEMA** mode (see *Listening in surround sound* above for an explanation of each process):

- **Pro Logic IIx MOVIE**
- **PRO LOGIC**
- **NEO:6 CINEMA**

With multichannel sources, press **THX** repeatedly to select from:

- **THX CINEMA** – Gives you cinema-quality sound from your home theatre system using all the speakers in your setup
- **THX SURROUND EX** – Allows you to hear 6.1 or 7.1 channel playback with 5.1 channel sources
- **Pro Logic IIx MOVIE** – Allows you to hear 7.1 channel playback with 5.1 channel sources (especially suited to movie sources)
- **THX ULTRA2 CINEMA** – Allows you to hear 7.1 channel playback with 5.1 channel sources
- **THX MUSICMODE** – Allows you to hear 7.1 channel playback with DVD-A and SACD multichannel music sources

Note

- If you only have one surround back speaker connected, **THX ULTRA2 CINEMA** and **THX MUSICMODE** are not available.
- When selecting the Dolby Pro Logic modes above, the display shows the mode you selected, then after a few seconds, shows **THX CINEMA**.
- You won't be able to use the THX options when playing two-channel DVD-A and SACD sources.
- With multichannel DVD-A and SACD sources, you can only select **THX MUSICMODE**.

Listening in stereo

You can hear any source through just the front left and right speakers (and possibly your subwoofer depending on your speaker settings).

- While listening to a source, press **STEREO** for stereo playback.



STEREO shows in the front panel display. Any active Advanced surround or Home THX mode is canceled. Dolby Digital and DTS multichannel sources are downmixed to stereo.

Listening with headphones

When headphones are connected, only the **STEREO** (default) and **PHONES SURROUND** modes are available. **PHONES SURROUND** is a virtual surround sound experience for headphones which provides realistic and dynamic surround sound.

When you connect a pair of headphones, the listening mode automatically changes to **STEREO** or **PHONES SURROUND**. When you disconnect them it reverts to the previous mode.

- With headphones connected, press **STANDARD** to select **PHONES SURROUND**, or **STEREO** for stereo sound.

You can also turn the front panel **LISTENING MODE SELECTOR** dial to select either **STEREO** or **PHONES SURROUND**.

Note

- Many features of this receiver are not accessible when the headphones are connected.
- If the U-shaped connectors (on the rear panel) aren't in place, you won't be able to use the headphones.
- When headphones are connected, no sound is heard from the speakers.
- If you're listening to a WMA9 Pro format source, only **STEREO** is available.

Using the multichannel analog inputs

If you've connected to the multichannel inputs on the rear panel (see *Connecting the multichannel analog outputs* on page 18), you will be able to select them as your input source. See *Using the Stream Direct mode* below if you want to bypass the signal processing in this receiver for a pure analog signal.

1 Press 'Multi-ch in' on the remote control Home menu (🏠) screen.

You can also use the **INPUT SELECTOR** dial on the front panel.

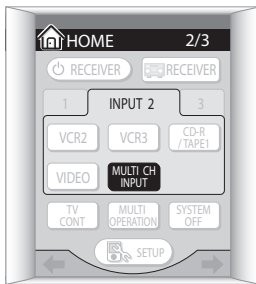

2 If necessary, press SIGNAL SELECT to choose the number of channels you'll hear.

See *Selecting USB and multichannel analog input channels* on page 49 for more on this.

Note

- The number of channels you hear will depend on the source and the SB CH mode setting (see *Using the surround back channel* on page 50 for more on this).

Using the Stream Direct mode

- Default setting: **SD:1 NORMAL** (on)

Use the Stream Direct mode when you want to hear the truest possible reproduction of a source. All unnecessary signal processing is bypassed, and you're left with the pure analog or digital sound source.

1 While listening to a source, press STREAM DIRECT to switch on or off.

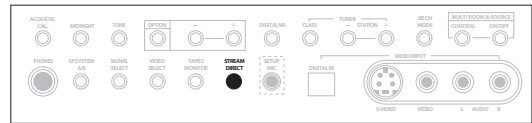

2 If you want to change the Stream Direct mode, press OPTION repeatedly to select Stream Direct (appears on the front panel as SD:1, 2 or 3) then use the (OPTION) +/- buttons to adjust the setting.

- SD:1 NORMAL** – Analog and digital sources are heard according to the settings made in the Surround Setup (speaker setting, channel level, speaker distance, acoustic calibration EQ, and X-curve), as well as with dual mono, the input attenuator, and any sound delay and hi-bit/hi-sampling settings. You will hear sources according to the number of channels in the signal.
- SD:2 2CH→DIRECT** – Use this setting for stereo analog and digital sources. All processing unnecessary for 2-channel signals is bypassed (such as speaker distance and acoustic calibration EQ) and you will hear the source through the shortest possible signal path. All sound will be heard through the front left and right speakers only (no subwoofer output is heard). With multichannel sources, playback is the same as the **NORMAL** setting (above).
- SD:3 ANA→DIRECT** – All analog sources are heard without any digital processing. All processing is done through the analog circuitry and the center channel, if present, will be sent to the front right and left speakers (the channel level is adjusted automatically). With digital sources, playback is the same as the **NORMAL** setting (above).

Note

- You can't use Digital NR, Midnight/Loudness listening, the SB CH mode, the tone control, or any of the listening modes when Stream Direct is on.
- If you connect the headphones when **SD:3 ANA→DIRECT** is selected, only the front left and right channels will be heard with multichannel sources.
- Stereo formats with surround sound information (such as Dolby Surround) are treated the same as multichannel sources.
- When the speaker impedance is set to 4Ω in *Switching the speaker impedance* on page 78, or when the Digital Safety is switched on (see *Troubleshooting* section on *Power* on page 99), the setting is fixed at **SD:1 NORMAL**.

Listening with Acoustic Calibration EQ

You can listen to sources using the Acoustic Calibration Equalization set in *Automatically setting up for surround sound* on page 39 or *Acoustic Calibration EQ* on page 61. Refer to these pages for more on acoustic calibration equalization.

- While listening to a source, press **ACOUSTIC CAL.** to select an Acoustic Calibration EQ setting.

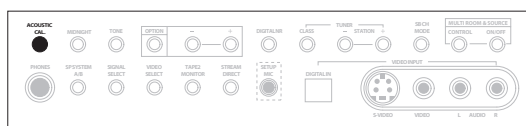

Press repeatedly to select between:

- **ALL CH ADJ** – No special weighting is given to any one channel.
- **FRONT CH ALIGN** – All speakers are heard in accordance with the front speaker settings.
- **CUSTOM 1/2** – Custom settings
- **OFF** – Switches Acoustic Calibration EQ off.

Selecting the input signal type

Most of the audio inputs have both analog and digital jacks. You can select the type of signal to be used in each case.

The input signal type for the current input is indicated in the display. With digital signals, the signal type (Dolby Digital or DTS) also shows in the display.

The default **AUTO** setting is usually sufficient, letting the receiver decide the most suitable signal type. However, if you want to record from the **DVR/VCR1 IN/OUT** jacks, then you should set the input signal type to analog.

If you have selected the USB interface or the multichannel analog inputs as your input source, see *Selecting USB and multichannel analog input channels* below.

- Press **SIGNAL SELECT** to select the type of input signal for the current source.

With the remote, you may need to press **RECEIVER** on the Home menu (🏠) first before reaching the receiver menu screen shown below (use the **←/→** (cursor left/right) soft keys to go to the previous/next menu screen).

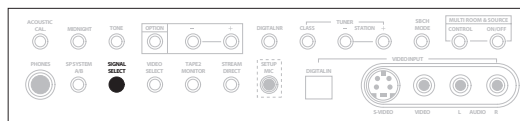

Press repeatedly to choose between:

- **ANALOG** – Selects an analog signal.
- **i** – Selects an i.LINK signal.
- **DIGITAL** – Selects an optical or coaxial digital signal.
- **RF** – Selects a **RF** signal.
- **AUTO** – This is the default setting. The receiver selects the first available signal in the following order: **i**; **RF**; **DIGITAL**; **ANALOG**.

Note

- If no digital inputs (including the **RF** input) are assigned for the current source, the input signal type will default to **ANALOG**.
- When using **DIGITAL IN** terminals the following digital signal formats are supported: Dolby Digital, DTS and PCM (32, 44.1, 48, 88.2 and 96 kHz sampling frequencies). If you are using the i.LINK connectors, DVD-A (including 176.4/192 kHz) and SACD are also supported. If your source is not supported, select **ANALOG**.
- Some DVD players don't output DTS signals. For more details, refer to the instruction manual supplied with your DVD player.
- Even when i.LINK is selected and the i.LINK indicator lights, you won't hear any sound if the output settings of your i.LINK device are off.
- The audio signal from karaoke microphones and some LDs is not output from the digital outputs. Select **ANALOG** to listen to these formats.

- If you want to play DTS-encoded sources, you need to have digital connections. If **ANALOG** is selected, you'll hear digital noise through your speakers.
- Make sure you connect your DVD/LD or LD players using the **RF** jack. If your player has a **RF** output this will ensure you can use all LDs. Refer to *Connecting other video sources* on page 21.
- The input signal for unassigned i.LINK-equipped components is fixed to **i**. See *Assigning the i.LINK inputs* on page 91.

Selecting USB and multichannel analog input channels

When you've selected the USB interface or the multichannel analog inputs as your input source, the **SIGNAL SELECT** button is used to specify the number of input channels.

- **After selecting USB or MULTI CH IN as your input source, press SIGNAL SELECT to choose the number of input channels.**

Select one of the following options:

- **2 CHANNEL**
- **6 CHANNEL**
- **7 CHANNEL**
- **8 CHANNEL**

The **8 CHANNEL** setting is the default.

Listening to high-sampling formats

This receiver supports 88.2/96kHz (24-bit) digital formats (such as DTS 96/24 and PCM 96kHz sources up to 24-bit) when connected to a compatible DVD player with digital connections. If you have connected this receiver to an i.LINK-equipped component, 176.4/192kHz (24-bit) digital formats (such as DVD-A and SACDs) are also supported. You can listen to these formats without downsampling in one of three ways:

- **Switch the Stream Direct mode on.**

See *Using the Stream Direct mode* on page 47.

For the following options, the **Pro Logic** modes cannot be selected for DTS 96kHz (24-bit) sources without downsampling:

- **Select one of the Home THX modes.**

See *Using the Home THX modes* on page 45.

- **Select the STEREO or STANDARD listening mode and switch off any other sound processing features.** These features include:

- Real Phantom (page 51)
- Virtual Surround Back (page 51)
- Midnight/Loudness (page 52)
- Digital Noise Reduction (page 53)
- Dynamic Range Control (page 94)

Note that you'll still be able to use the tone control (see *Using the tone control* on page 52).

Note

- You will see the sampling frequency in the display (with DTS 96kHz (24-bit) sources, **96** is only displayed when the signal is being processed at 96kHz).
- Even if your DVD player can't output 96kHz (24-bit) digital signals, you can still listen to DTS 96/24 sources processed at 96kHz if it has a DTS output feature. Other formats (such as PCM192/96kHz sources) are not compatible unless the digital output of your DVD player supports high-sampling digital signals.

Using the surround back channel

- Default setting: **SB CH ON**

You can have the receiver automatically use 6.1 or 7.1 decoding for 6.1 encoded sources (for example, Dolby Digital EX or DTS-ES), or you can choose to always use 6.1 or 7.1 decoding with other sources (for example, 5.1 encoded material). With 5.1 encoded sources, a surround back channel will be generated, but the

material may sound better in the 5.1 format for which it was originally encoded, in which case you can simply switch the surround back channel off. The table below indicates when you will hear the surround back channel when playing various kinds of sources. (●=Sound plays through surround back channel speaker(s); ★ = **7 CH SURROUND** shows in the display; ◆ = Home THX is selected and two surround back speakers are connected)

Type of source	SB CH mode	Standard / THX				Advanced surround
		Multichannel sources	Stereo sources			
			Pro Logic II x	Pro Logic	NEO:6	
Dolby Digital EX/DTS-ES encoded multichannel source with 6.1ch surround	ON	●				●
	AUTO	●				●
Dolby Digital/DTS encoded multichannel source	ON	●				●
	AUTO	●◆				●
Dolby Digital/DTS encoded stereo source; other digital stereo source	ON		●	●★	●	●
	AUTO		●	●★	●	●
Analog 2-channel (stereo) source	ON		●	●★	●	●
	AUTO		●	●★	●	●

- **Press SB CH MODE repeatedly to cycle through the surround back channel options.**

The remote control menu for this step is shown below (see note at the start of this chapter if you need help).

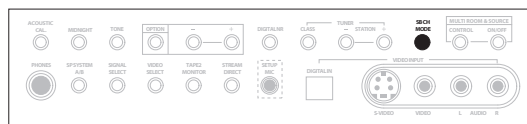

Each press changes the setting as follows (see the table above for an explanation of each):

- **SB CH AUTO** – Automatically switches to 6.1 or 7.1 decoding for 6.1 encoded sources (for example, Dolby Digital EX or DTS-ES)
- **SB CH ON** – 6.1 or 7.1 encoding is always used (for example, on 5.1 encoded material)

- **SB CH OFF** – Surround back channel is switched off

Note

- You will only hear the surround back channel when you've selected **SP▶A** as the speaker setting (see *Switching the speaker system* on page 80). Changing the speaker system may automatically change this setting (see notes below).
- If the surround back speaker is set to **NO** in *Speaker Systems* on page 58, or you have selected **SP▶A+B** as the speaker setting, you can only use the virtual surround back effect (see next page).
- You can't select the surround back channel setting (it is automatically switched off) when you've selected **SP▶B** as the speaker setting or when **Bi-Surround** is selected in *Speaker Systems* on page 58.
- You can't use the surround back channel setting when Stream Direct is on or when the **STEREO** mode is selected.
- When the THX mode is selected, you can't select **SB CH OFF** if you're listening to DVD-Audio or SACD.

Listening with virtual surround back speakers

- Default setting: **VIRTUAL SB OFF**

If you don't have real surround back speakers connected, you can use the Virtual Surround Back feature to simulate one.

Sometimes the material may sound better in the 5.1 format for which it was originally encoded. In this case you can have the receiver only apply this effect to 6.1 encoded sources like Dolby Digital EX or DTS-ES (**VSB AUTO**), or you can simply switch it off (**VSB OFF**).

Note that this feature only works when the surround channels are active and the surround back speaker is set to **NO** in *Speaker Systems* on page 58. It is also available when the speaker system has been set to **SP►AB** (see *Switching the speaker system* on page 80).

See also *Using the surround back channel* above.

- Press **SB CH MODE** repeatedly to cycle through the virtual surround back channel options.

The remote control menu for this step is shown below (see note at the start of this chapter if you need help).

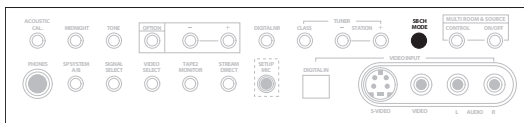

Each press cycles through the options as follows:

- **VSB AUTO**
- **VSB ON**
- **VSB OFF**

Note

- You can't select the virtual surround back setting when you've selected **SP►B** as the speaker setting (see *Using speaker system B* on page 80) or when **Bi-Surround** is selected in *Speaker Systems* on page 58.
- You can't use the virtual surround back setting when Stream Direct is on or when **STEREO**, or one of the THX modes is selected.

Creating a center speaker effect

If you don't have a center speaker connected, the center speaker channel is mixed to your two front speakers. However, using the Real Phantom setting, you can create a center speaker effect for an effective front surround effect.

- 1 Press **OPTION** repeatedly to select **R.PHANTOM**.

The remote control menu for this step is shown below (see note at the start of this chapter if you need help).

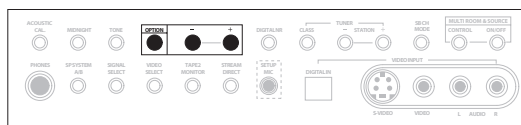

- 2 Use the **(OPTION) +/-** buttons to change the setting.

- **Mid** – A subtle center speaker effect is applied to the front left and right channels.
- **Max** – A strong center speaker effect is applied to the front left and right channels.
- **OFF** – The center speaker effect is switched off.

Note

- Real Phantom is automatically switched off and **R.PHANTOM** won't appear in the display (in step 1) if Stream Direct or the **STEREO** listening mode is switched on. The center speaker must also be set to **NO** in *Speaker Systems* on page 58.

Using Hi-bit and Hi-sampling

You can use both Hi-bit and Hi-sampling to create a wider dynamic range with digital sources like CDs or DVDs.

1 Press **OPTION** repeatedly to select **HI-BIT** or **HI-SAMPLING**.

The remote control menu for this step is shown below (see note at the start of this chapter if you need help).

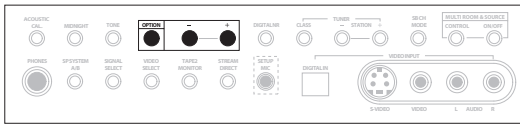

2 Use the **(OPTION) +/-** buttons to switch the selected mode on or off.

Note

- Hi-bit and Hi-sampling may not work with Stream Direct or analog sources.
- You can't use Hi-bit with SACD or sources over 88.2kHz when using one of the digital inputs (including i.LINK).

Using Midnight and Loudness listening

- Default setting: **Off**

The Midnight listening feature allows you to hear effective surround sound of movies at low volume levels.

The Loudness feature is useful for listening to music sources at low volumes.

- Press **MIDNIGHT** or **LOUDNESS** to switch the effect on or off.

LOUDNESS is only available when using the remote control. The remote menu for this step is shown below (see note at the start of this chapter if you need help).

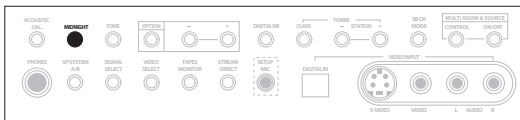

Note

- You can't use the Midnight and Loudness modes at the same time.
- You can't use either of these modes when using the tone controls, or Stream Direct or the Home THX modes.
- Midnight and Loudness automatically adjust according to the volume at which you're listening. However, the volume must be under -20dB for these features to take effect.

Using the tone control

You can use the tone control to make customized settings for the bass and treble.

Switching the tone control on or off

- Default setting: **BYPASS**

You'll need to switch the tone control on to adjust the bass and treble below.

- Press **TONE** to switch the tone control on or off. When the tone control is switched off, **BYPASS** shows in the display. The remote control menu for this step is shown below (see note at the start of this chapter if you need help).

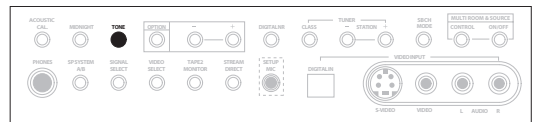

Note

- You can't use the tone control with Stream Direct, Midnight, Loudness, or any of the Home THX modes.

Adjusting the bass and treble

- Default setting: Bass: **0**, Treble: **0**

You can adjust the bass and treble controls separately to adjust the overall tone.

1 Press **OPTION** repeatedly to select **BASS** or **TREBLE**.

The remote control menu for this step is shown below (see note at the start of this chapter if you need help).

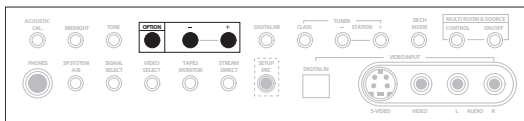

2 Use the **(OPTION) +/-** buttons to adjust the sound.

The bass and treble can be adjusted from **-6** to **+6**.

3 Press **ENTER** to confirm.

Reducing noise during playback

If you have a noisy source (for example, cassette or video tape with lots of background noise), you may be able to improve the quality of the sound by switching on digital noise reduction (**DIGITAL NR**).

- Press the **DIGITAL NR** button to switch digital noise reduction on or off.

The remote control menu for this step is shown below (see note at the start of this chapter if you need help).

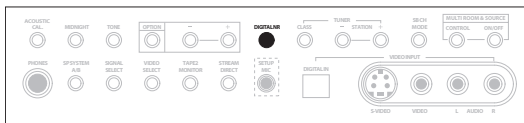

Note

- Depending on the source, there may not be a noticeable improvement in the quality of the sound.
- You can't use digital noise reduction with Stream Direct or the Home THX modes.

Listening to dual mono soundtracks

You can specify how dual mono encoded Dolby Digital soundtracks should be played. Dual mono is not widely used, but is sometimes necessary when two languages need to be sent to separate channels.

1 Press **OPTION** repeatedly to select **DUAL MONO**.

The remote control menu for this step is shown below (see note at the start of this chapter if you need help).

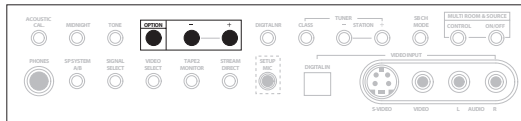

2 Use the **(OPTION) +/-** buttons to change the setting.

- **CH1** – Only channel 1 is played
- **CH2** – Only channel 2 is played
- **CH1/CH2** – Both channels are played through the front speakers

Note

- On the **CH1** and **CH2** settings the sound comes only from the center speaker (or from the front speakers if **NO** was selected for the center speaker setting).
- This setting works only with dual mono encoded Dolby Digital and DTS soundtracks.
- When listening to a dual mono source, the **L** and **R** indicators on the front panel flash. The channel you select will light in the display.

Chapter 6

Using the tuner

Note

- The remote control operations in this section are accessed from the remote control tuner menus. If you're not sure how to navigate the touch panel, see *Basic remote control displays* on page 33. To go to the tuner menu, press **TUNER** on the remote control Home menu (🏠):

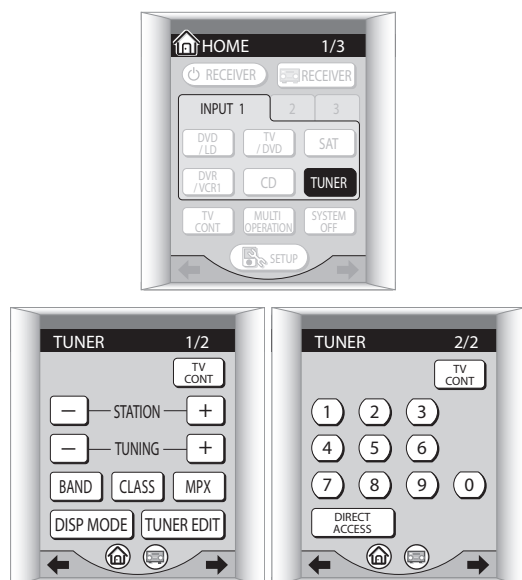

Finding a station

The following steps show you how to tune in to FM and AM radio broadcasts using the automatic (search) and manual (step) tuning functions. If you already know the exact frequency of the station you want to listen to, see *Tuning directly to a station* below. Once you are tuned to a station you can memorize the frequency for recall later—see *Memorizing station presets* on page 55 for more on how to do this.

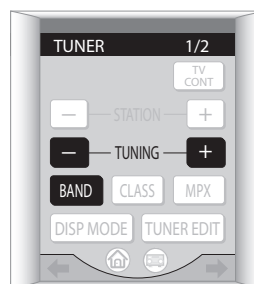

1 Press **BAND** to change the band (FM or AM), if necessary.

Each press switches the band between FM and AM.

2 Tune to a station using the **TUNING +/-** buttons.

Automatic tuning

To search for stations in the currently selected band, press and hold either of the **TUNING +/-** buttons for about a second. The receiver will start searching for the next station, stopping when it has found one. Repeat this step to search for other stations.

Manual tuning

To change the frequency one step at a time, press the **TUNING +/-** buttons repeatedly.

High speed tuning

Press and hold the **TUNING +/-** buttons for high speed tuning, releasing the button once you reach the frequency you want.

Tuning directly to a station

Sometimes, you'll already know the frequency of the station you want to listen to. In this case, you can simply enter the frequency directly using the number buttons on the remote control.

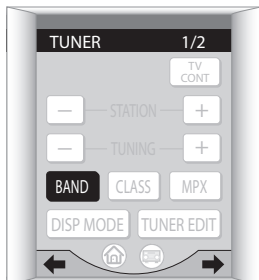

1 On the tuner touch screen menu, press BAND to change the band (FM or AM), if necessary.

Each press switches the band between FM and AM.

2 Press DIRECT ACCESS.

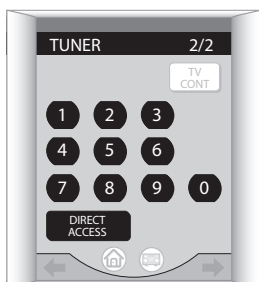

3 Use the number buttons to enter the frequency of the radio station.

For example, to tune to 106.00 (FM), press **1, 0, 6, 0, 0**.

Note

- If you make a mistake while inputting the frequency, press the **DIRECT ACCESS** button again to cancel the frequency and start again.

MPX mode

If there is interference or noise during a stereo FM radio broadcast (the **STEREO** indicator is lit), or the radio reception is weak, press **MPX** on the tuner touch screen menu to switch the receiver into mono reception mode (the **MONO** indicator lights). This should improve the sound quality and allow you to enjoy the broadcast.

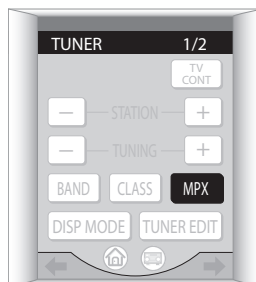

Memorizing station presets

If you often listen to a particular radio station, it's convenient to have the receiver store the frequency for easy recall whenever you want to listen to that station. This saves the effort of manually tuning in each time. The receiver can memorize up to 30 stations, stored in three banks, or classes, (A, B and C) of 10 stations each. When memorizing FM frequencies, the receiver also stores the MPX setting (see *MPX mode* above).

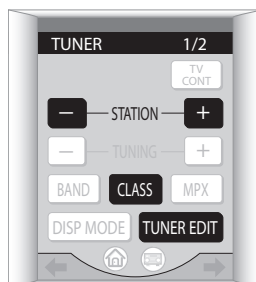

1 Tune to a station you want to memorize.

See *Finding a station* on page 54 and *Tuning directly to a station* above for more details on how to do this.

2 Press TUNER EDIT.

The display shows **MEMORY INPUT** then a blinking memory class (**A, B** or **C**).

3 Press CLASS to select one of the three classes.

Press repeatedly to cycle through the three memory classes, **A, B** and **C**.

4 Use the STATION +/- buttons (or number buttons) to select the station preset you want.

Press **STATION +/-** repeatedly to select a preset number.

- 5 While the display is blinking, press **ENTER**.
- 6 Repeat steps 1 – 5 to memorize up to 30 stations.

Naming station presets

You can input a name of up to eight characters for each preset station in the receiver's memory. For example, you could input **New Jazz** for that station and when you listen to it the name, rather than the frequency, will appear in the display.

1 Press **CLASS** repeatedly to select the class.

Press repeatedly to cycle through the three memory classes, **A**, **B** and **C**.

2 Use the **STATION +/-** buttons to select an FM or AM preset station.

3 Press **TUNER EDIT** to select the station name mode (**NAME INPUT**).

4 Edit the name as necessary and press **ENTER**.

Use the **↑/↓** (cursor up/down) hard keys to change the character and the **←/→** (cursor left/right) hard keys to move forward/back a position. The name can be up to eight characters (the possible characters are listed below).

ABCDEFGHIJKLMNOPQRSTUVWXYZ

abcdefghijklmnopqrstuvwxyz

0123456789

!"#\$%&'()*+,-./:;<=>?@[\]

Any time you want to exit the process, press the **TUNER EDIT** button.

- 5 Press **ENTER** when you're done.
- 6 Repeat steps 2 – 5 to memorize up to 30 preset broadcast station names.

Tip

- To change a station name, just enter the new name over the top of the old one. To erase a station name, enter a new name of eight spaces.
- You can switch between the frequency display and the station name display using the **DISP MODE** button.

Listening to memorized station presets

You can do this from both the remote control and the front panel.



1 Press **CLASS** to select the class in which the station is stored.

Press repeatedly to cycle through the three memory classes, **A**, **B** and **C**.

2 Use the **STATION +/-** buttons to select the station memory in which the station is stored.

You can also use the number buttons on the remote control to recall the station preset.

Chapter 7 The Surround Setup menu

Making receiver settings from the Surround Setup menu

This receiver allows you to make detailed settings to optimize the surround sound performance. You only need to make these settings once (unless you change the placement of your current speaker system or add new speakers.).

These settings are designed to fine-tune your system, but if you're satisfied with the settings made in *Introduction to home theater* on page 39, it isn't necessary to make all of these settings.

Important

- For many of the settings below, you'll have to connect the setup microphone to the front panel and place it about ear level at your normal listening position. See *Introduction to home theater* on page 39 if you're unsure how to do this. Also see *Other problems when using the Auto Surround Setup* on page 41 for notes regarding high background noise levels and other possible interference.
- If you're using a subwoofer, switch it on and turn up the volume to the middle position.
- After three minutes of inactivity during the **Auto** setup options (including Professional Acoustic Calibration EQ measurement), the OSD will go to sleep until a button is pressed. With other screens, the receiver automatically exits and no settings will be made.

Caution

- The test tones used in the Surround Setup are output at high volume (the volume increases to 0db automatically).

1 Switch on the receiver and your TV.

If headphones are connected to the receiver, disconnect them.

- 2 Using the remote control, press RECEIVER on the touch screen, then press the SYSTEM SETUP button.



An on-screen display (OSD) appears on your TV. Use the **↑/↓/←/→** hard keys and **ENTER** on the remote control to navigate through the screens and select menu items.

- The **↑/↓** (cursor up/down) hard keys select menu items and the **←/→** (cursor left/right) hard keys change the setting of the item selected.

- 3 Select 'Surround Setup' then press ENTER.

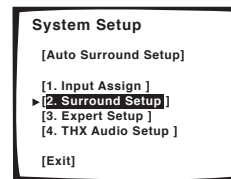

- 4 Select the setting you want to adjust.

If you are doing this for the first time, you may want to adjust these settings in order:

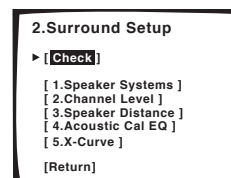

- **Speaker Systems** – Specify the size and number of speakers you've connected (page 58).

- **Channel Level** – Adjust the overall balance of your speaker system (page 60).
- **Speaker Distance** – Specify the distance of your speakers from the listening position (page 61).
- **Acoustic Cal EQ** – Adjust overall equalization depending on your room characteristics (page 61).
- **X-Curve** – Adjust the amount of 're-equalization' necessary to achieve a flat frequency response from your home theater system (page 65).

5 Make the adjustments necessary for each setting, pressing ENTER to confirm after each screen.

When you're finished, you can check through your settings screen by screen by selecting **Check** from the Surround Setup menu (see *Checking your surround settings* on page 66 for more on this).

Speaker Systems

You need to specify the number of speakers you have in your system, and how you want to route the sound. It is a good idea to make sure that the settings made in *Introduction to home theater* on page 39 are correct.

1 Select 'Speaker Systems' then press ENTER.

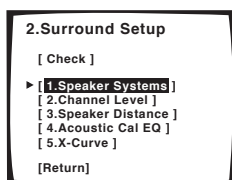

2 Select how you want to set up your speakers then press ENTER.

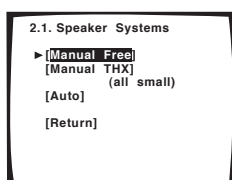

- **Manual Free** – Manually set all speakers.
- **Manual THX** – All speakers are set to **SMALL**. You can only select the number of surround back speakers.
- **Auto** – All speakers are set automatically. (The microphone must be hooked up to the front panel to do this.)

3 Specify how your speakers are configured.

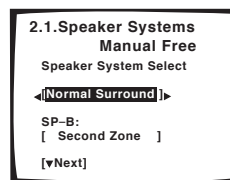

Use ←/→ (cursor left/right) to cycle through the following options:

- **Normal Surround** – Select for normal home theater use.
- **Front Bi-Amp** – Select this setting if you're bi-amping your front speakers (see *Bi-amping your front speakers* on page 81).
- **Bi-Surround** – Select if you're using two sets of surround speakers (see *Adding a second set of surround speakers for Bi-Surround* on page 82).

If you selected **Normal Surround**, you'll also have to select the speaker system B setting:

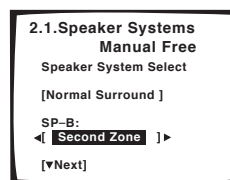

- **Second Zone** – Select if you want to hear speaker system B in a separate room.
- **ITU-R** – Select this setting to use two switchable main speaker systems using speaker system B (see *Alternating surround speaker setups using speaker system B (ITU-R)* on page 80).
- **OFF** – Select if no speakers are connected to the B terminals.

4 Press ENTER to go to the next screen.

- If you selected **Auto** in step 2, you will have to select **Next** and then press **ENTER** to continue to the auto (test tone) setup.

Select **Start** and press **ENTER** to start the test tones when you've made sure the room is free of ambient noise. Go to step 8 when you see **OK** appear on the OSD.

5 Choose the set of speakers that you want to set then select a speaker size.

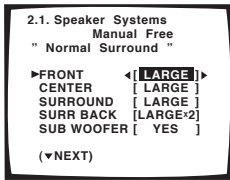

Use ←/→ (cursor left/right) to select the size (and number) of each of the following speakers:

- **FRONT** – Select **LARGE** if your front speakers reproduce bass frequencies effectively, or if you didn't connect a subwoofer. Select **SMALL** to send the bass frequencies to the subwoofer.
- **CENTER** – Select **LARGE** if your center speaker reproduces bass frequencies effectively, or select **SMALL** to send bass frequencies to the other speakers or subwoofer. If you didn't connect a center speaker, choose **NO** (the center channel is sent to the front speakers).
- **SURROUND** – Select **LARGE** if your surround speakers reproduce bass frequencies effectively. Select **SMALL** to send bass frequencies to the other speakers or subwoofer. If you didn't connect surround speakers choose **NO** (the sound of the surround channels is sent to the front speakers or a subwoofer).
- **SURR BACK** – Select the number of surround back speakers you have (one, two or none). Select **LARGE** if your surround back speakers reproduce bass frequencies effectively. Select **SMALL** to send bass frequencies to the other speakers or subwoofer. If you didn't connect surround back speakers choose **NO**.
- **SUBWOOFER** – LFE signals and bass frequencies of channels set to **SMALL** are output from the subwoofer when **YES** is selected (see notes below). Choose the **PLUS** setting if you want the subwoofer to output bass sound continuously or you want deeper bass (the bass frequencies that would normally come out the front and center speakers are also routed to the subwoofer). If you did not connect a subwoofer choose **NO** (the bass frequencies are output from other speakers).

Note

- If you selected **Manual THX** (in step 2) you can only adjust the surround back settings.
- If you selected **Front Bi-Amp** (in step 3) you can't adjust the surround back settings.

- If you select **SMALL** for the front speakers the subwoofer will automatically be fixed to **YES**. Also, the center and surround speakers can't be set to **LARGE** if the front speakers are set to **SMALL**. In this case, all bass frequencies are sent to the subwoofer.
- If the surround speakers are set to **NO**, the surround back speakers will automatically be set to **NO**.
- If you select one surround back speaker only, make sure that speaker is hooked up to the left surround back terminal.

6 Press ENTER to go to the next screen.

7 Choose a crossover frequency.

This setting decides the cutoff between bass sounds playing back from the speakers selected as **LARGE**, or the subwoofer, and bass sounds playing back from those selected as **SMALL**. It also decides where the cutoff will be for bass sounds in the LFE channel.

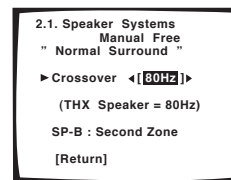

Use ←/→ (cursor left/right) to select the crossover frequency:

- **50Hz** – Sends bass frequencies below 50 Hz to the subwoofer (or **LARGE** speakers).
- **80Hz** – Sends bass frequencies below 80 Hz to the subwoofer (or **LARGE** speakers).
- **100Hz** – Sends bass frequencies below 100 Hz to the subwoofer (or **LARGE** speakers).
- **150Hz** – Sends bass frequencies below 150 Hz to the subwoofer (or **LARGE** speakers).
- **200Hz** – Sends bass frequencies below 200 Hz to the subwoofer (or **LARGE** speakers).

Note

- If you selected **Manual THX** (in step 2) the crossover frequency is set to **80Hz** and this screen doesn't appear.

8 Select 'Return' and press ENTER to return to the Surround Setup menu.

Tip

- If you have a subwoofer and like lots of bass, it may seem logical to select **LARGE** for your front speakers and **PLUS** for the subwoofer. This may not, however, yield the best bass results. Depending on the speaker placement of your room you may actually experience

a decrease in the amount of bass due low frequency cancellations. In this case, try changing the position or direction of speakers. If you can't get good results, listen to the bass response with it set to **PLUS** and **YES** or the front speakers set to **LARGE** and **SMALL** alternatively and let your ears judge which sounds best. If you're having problems, the easiest option is to route all the bass sounds to the subwoofer by selecting **SMALL** for the front speakers.

Channel Level

Using the channel level settings, you can adjust the overall balance of your speaker system, an important factor when setting up a home theater system. If you're unsure of the best channel level settings, simply select **Auto** from the setup options below.

1 Select 'Channel Level' then press ENTER.

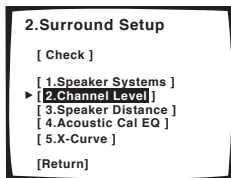

2 Select a setup option and press ENTER to start the test tones.

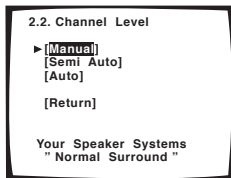

- **Manual** – Move the test tone manually from speaker to speaker and adjust individual channel levels.
- **Semi Auto** – Adjust channel levels as the test tone moves from speaker to speaker automatically.
- **Auto** – The levels are set automatically by the receiver as it outputs the test tones. (For this setup you must have the mic connected.)

3 If you selected 'Manual' or 'Semi Auto', adjust the level of each channel using the ←/→ (cursor left/right) hard keys.

If you selected **Manual**, use ↑/↓ (cursor up/down) to switch speakers. The Semi Auto setup will output test tones in the order shown on-screen:

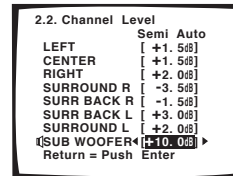

Adjust the level of each speaker as the test tone is emitted.

Note

- If you are using a Sound Pressure Level (SPL) meter, take the readings from your main listening position and adjust the level of each speaker to 75 dB SPL (C-weighting/slow reading).
- The subwoofer test tone is output at low volumes. You may need to adjust the level after testing with an actual soundtrack.

4 If you selected 'Manual' or 'Auto', select 'Return' then press ENTER to finish. With 'Semi Auto', simply press ENTER.

With the **Auto** setup, **!! Complete !!** is displayed on-screen after the channel levels are set.

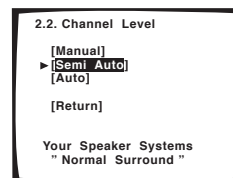

To check the settings, select **Check** and press **ENTER** instead of selecting **Return** above. When you're finished select **Return** then press **ENTER**.

Tip

- You can change the channel levels at any time by using **CHANNEL +/-** on the front panel or from the remote control receiver menu (see *Basic remote control displays* on page 33 for more on this). You can set separate levels for each listening mode (Standard/Home THX, Advanced Cinema/Advanced Concert and Stereo) as well as for **SB CH ON**. However, these settings will be cleared if you use the Surround Setup or Auto Surround Sound Setup to set the channel levels at a later date.

Speaker Distance

For good sound depth and separation from your system, you need to specify the distance of your speakers from the listening position. The receiver can then add the proper delay needed for effective surround sound.

1 Select 'Speaker Distance' then press ENTER.

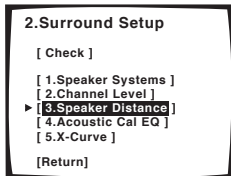

2 Choose a unit of measurement and press ENTER.

Speaker distance can be expressed in either feet or meters.

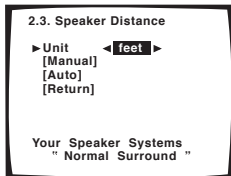

3 Select a setup option and press ENTER.

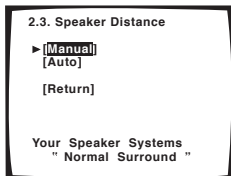

- **Manual** – Select each speaker in turn and adjust the distance manually.
- **Auto** – The speaker distances are set automatically by the receiver as it outputs test tones. (For this setup you must have the mic connected.)

4 If you selected 'Auto', select 'Start' and press ENTER. If you selected 'Manual', adjust the distance of each speaker using the ←/→ (cursor left/right) hard keys.

Using the **Manual** setup, you can adjust the distance of each speaker in 0.2 feet (0.05 meter) increments.

With the **Auto** setup, **!! Complete !!** is displayed on-screen after the speaker distances are set. If you want to check the settings, select **Check** and press **ENTER**.

5 Select 'Return' then press ENTER to finish.



Tip

- For best surround sound, make sure the surround back speakers are the same distance.

Acoustic Calibration EQ

Acoustic Calibration Equalization is a kind of room equalizer for your speakers (excluding the subwoofer). It works by measuring the acoustic characteristics of your room and neutralizing the ambient characteristics that can color the original source material. You can also make these settings manually to get a frequency balance that suits your tastes. A more advanced setup is also available, where you can make detailed settings according to your room's reverb characteristics (see *Professional Acoustic Calibration EQ* on page 63). You should have the mic connected when using any of the setup options.

Setting the Acoustic Calibration EQ automatically

1 Select 'Acoustic Cal EQ' then press ENTER.

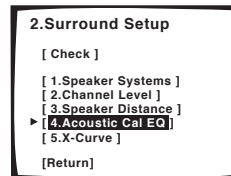

2 Select 'Auto' then press ENTER.

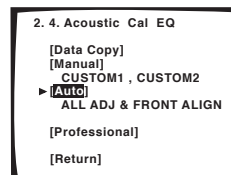

As the receiver outputs test tones, the frequency balance is adjusted automatically for the following settings:

- **ALL CH ADJ** – All the speakers are set individually so no special weighting is given to any one channel.
- **FRONT CH ALIGN** – All speakers are set in accordance with the front speaker settings.

!! Complete !! is displayed on-screen after the acoustic calibration equalization is set. If you want to check the settings, select **Check** and press **ENTER**.

3 Select 'Return' then press ENTER to finish.

Setting the Acoustic Calibration EQ manually

Before manually adjusting the Acoustic Calibration EQ, we recommend copying the **ALL CH ADJ** or the **FRONT CH ALIGN** settings from the **Auto** setup above (or from *Introduction to home theater* on page 39) to one of the custom settings. Instead of just a flat EQ curve, this will give you a reference point from which to start (see *Copying your Acoustic Calibration EQ settings* below for how to do this).

1 Select 'Acoustic Cal EQ' then press ENTER.

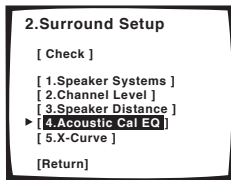

2 Select 'Manual' then press ENTER.

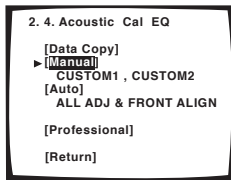

3 Select CUSTOM1 or CUSTOM2 then press ENTER.

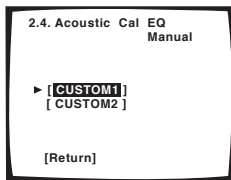

4 Select the channel you want, adjust the frequency curve to your liking, then move to the next speaker.

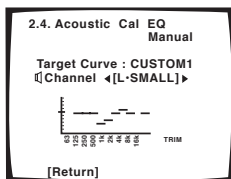

Use the **←/→** (cursor left/right) hard keys to select the channel, then **ENTER** to select it.

Use the **←/→** (cursor left/right) hard keys to select the frequency and **↑/↓** (cursor up/down) to boost or cut the EQ. When you're finished, press **ENTER** to move to the next channel.



Tip

- Changing the frequency curve of one channel too drastically will affect the overall balance. If the speaker balance seems uneven, you can raise or lower channel levels using test tones with the **TRIM** feature. Use **→** (cursor right) to move to the far right side of the OSD, then use **↑/↓** (cursor up/down) to raise or lower the channel level for the current speaker.

5 When you're done, press ↓ (cursor down) to select 'Return' then press ENTER to finish.



Note

- If the message **OVER !!** appears on-screen, it means the frequency curve may result in distortion from the speaker. Adjust the frequency curve accordingly.

Copying your Acoustic Calibration EQ settings

If you want to manually adjust the Acoustic Calibration EQ (see *Setting the Acoustic Calibration EQ manually* above), we recommend copying the **ALL CH ADJ** or the **FRONT CH ALIGN** settings from the **Auto** setup above (or from *Introduction to home theater* on page 39) to one of the custom settings. Instead of just a flat EQ curve, this will give you a reference point from which to start.

1 Select 'Acoustic Cal EQ' then press ENTER.

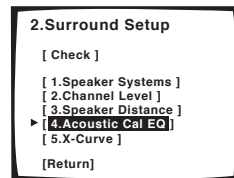

2 Select 'Data Copy' then press ENTER.

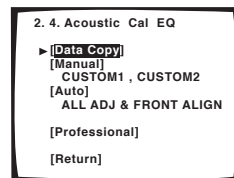

3 Select CUSTOM1 or CUSTOM2 then use the ←/→ (cursor left/right) hard keys to select the setting you want to copy.

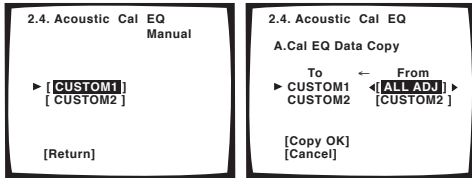

- You can also copy from one custom setting to another. For more on the **ALL CH ADJ** and **FRONT CH ALIGN** settings, see *Setting the Acoustic Calibration EQ automatically* above.

4 Select 'Copy OK' and press ENTER to confirm. You will be taken to the Acoustic Calibration EQ settings menu. Select **Return** then press **ENTER** to go back to the Surround Setup menu.

Professional Acoustic Calibration EQ

This setup minimizes the unwanted effects of room reverberation by calibrating your system based on the direct sound coming from the speakers. It can also provide you with a graphical output of the frequency response of your room.

Note

- Before setting up with Professional Acoustic Calibration EQ, you should finish calibrating using the Auto Surround Setup on page 39.

How to use Professional Acoustic Calibration EQ

If you find that lower frequencies seem overly reverberant in your listening room (i.e. it sounds 'boomy'), or that different channels seem to exhibit different reverb characteristics, use the auto pro setup to calibrate the room automatically. This should provide a more balanced calibration than simply using the standard Acoustic Calibration EQ. The manual setup allows you to customize your system calibration with the help of a graphical output that can be displayed on-screen, or using a computer (with software available from Pioneer—see *Connecting a PC for Advanced MCACC output* on page 88 for more on this).

How to interpret the graphical output

The graph shows decibels on the vertical axis and time (in milliseconds) on the horizontal axis. A straight line indicates a flat-response room (no reverb), whereas a sloping line indicates the presence of reverberation when outputting test tones. The sloping line will eventually flatten out when the reverberant sound stabilizes (this usually takes about 100ms or so).

By analyzing the graph, you should be able to see how your room is responding to certain frequencies. Differences in channel level and speaker distance are taken into account automatically (compensation is provided for comparison purposes), but the frequency measurements are always shown without the equalization performed by this receiver.

Note that due to an effect known as 'group delay', lower frequencies will take longer to be generated than higher frequencies (this is most obvious when comparing the frequencies at 0ms). This initial slope is not a problem (i.e. excessive reverb) with your listening room.

Setting Professional Acoustic Calibration EQ according to your room characteristics

Using the manual setup, you can set the time period at which the frequency response is analyzed for calibration. You can pinpoint the time that is best for calibration of the system for your particular room characteristics. The graph below shows the difference between standard acoustic calibration and professional calibration (the gray circles represent the point at which the microphone captures the sound for frequency analysis).

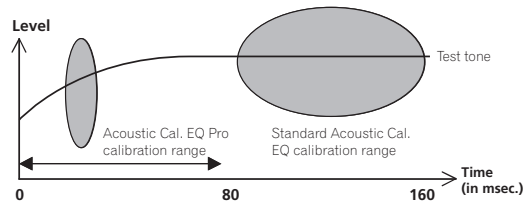

As soon as audio is output from your speaker system, it is influenced by room characteristics, such as walls, furniture, and the dimensions of the room. The sooner the frequency analysis, the less it is influenced by the room. We recommend an earlier time setting of 20–40ms to compensate for two major factors that will influence the sound of most rooms:

- Reverberance of high vs. low frequencies –** Depending on your room, you may find that lower frequencies seem overly reverberant compared to higher frequencies (i.e. your room sounds 'boomy'). This may result in a skewed frequency analysis if the measurement is done too late.

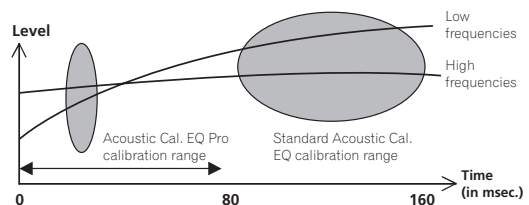

- **Reverb characteristics for different channels** – Reverb characteristics can be somewhat different for each channel. Since this difference increases as the sound is influenced by the various room characteristics, it is often better to capture a frequency analysis early on for smoother mixing of channel frequencies/sounds.

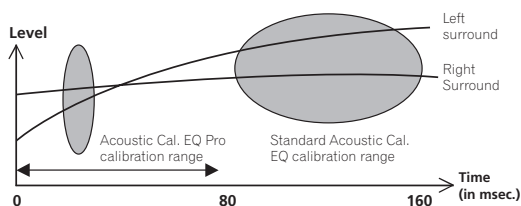

If your room isn't affected by the factors above, it is often not necessary to make a 20–40ms setting. Later time settings may provide a more detailed sound experience with your speaker system. It is best to try and see what works best for your particular room.

Note that changing the room (for example, moving furniture or paintings) will affect the calibration results. In such cases, you should recalibrate your system.

Using Professional Acoustic Calibration EQ

- 1 Select 'Acoustic Cal EQ' then press ENTER.

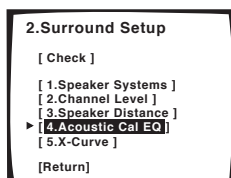

- 2 Select 'Professional' then press ENTER.

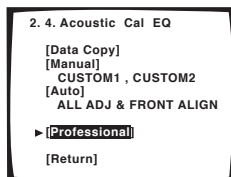

- 3 Select a setup option and press ENTER.

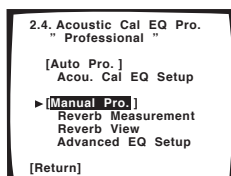

- **Auto Pro.** – The receiver automatically sets an early time period (20–40 ms or 60–80 ms) for reverb measurement, giving you a system calibration based on the direct sound coming from the speakers. The frequency balance for each channel is then adjusted to minimize the effect of the room characteristics on the overall sound.
- **Manual Pro.** – You can set an early time period for reverb measurement manually, giving you the flexibility to choose the direct sound calibration that works best with your listening area. After you have made this setting, the frequency balance for each channel is adjusted automatically, calibrating your system according to your custom setting.

- 4 If you selected 'Auto Pro.', select 'Start' and press ENTER.

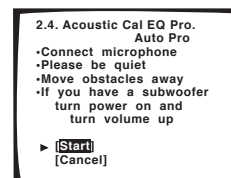

!! Complete !! is displayed on-screen after the acoustic calibration equalization is set. Select **Return** to return to the professional acoustic calibration equalization menu.

- 5 Select a manual setup option and press ENTER.

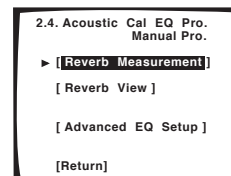

- **Reverb Measurement** – Use this to measure the reverb characteristics of your room for separate channels in select frequency ranges.
- **Reverb View (Normal)** – You can check the reverb measurements made for specified frequency ranges in each channel. **PC Output** will also show as an option after you've completed the reverb measurement. See *Connecting a PC for Advanced MCACC output* on page 88 for more on this option.
- **Advanced EQ Setup** – Use this to select the time period that will be used for frequency adjustment and calibration, based on the reverb measurement of your listening area. Note that using this setup will alter the settings you made in *Automatically setting up for surround sound* on page 39.

6 If you selected 'Reverb Measurement', select 'Start' and press ENTER.

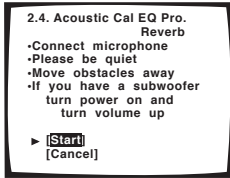

!! Complete !! is displayed on screen when the reverb measurement is finished (this may take 2–6 minutes). You can select **Reverb View** (above) to see the results on-screen. See *Connecting a PC for Advanced MCACC output* on page 88 for more on setting up your computer for the graphical output.

7 If you selected 'Reverb View', you can use the cursor buttons (hard keys) to check the reverb characteristics for each channel. Select 'Return' and press ENTER when you're done.

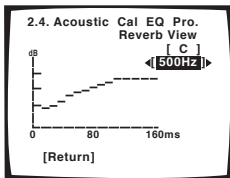

Use the ←/→ (cursor left/right) buttons to select the channel and the frequency you want to check. Use the ↑/↓ (cursor up/down) buttons to go back and forth between the two. Note that the markers on the vertical axis indicate decibels in 2dB steps.

8 If you selected 'Advanced EQ Setup', input the time setting you want to use for calibration, then select 'Go'. Select 'Start' from the next screen.

Based on the reverb measurement above, you can manually choose the time period that will be used for the final frequency adjustment and calibration. Even though you can make this setting without reverb measurement, it is best to use the measurement results as a reference for your time setting. For an optimal system calibration based on the direct sound coming from the speakers, we recommend using the **20–40ms** setting.

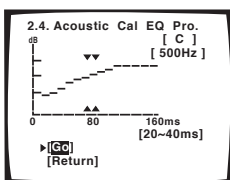

Use the ←/→ (cursor left/right) buttons to select the channel, frequency, and time setting. Use the ↑/↓ (cursor up/down) buttons to switch between them.

You can switch between your connected speakers (excluding the subwoofer), and display the measurements for the following frequencies: 63Hz, 125 Hz, 250Hz, 500Hz, 1kHz, 2kHz, 4kHz, 8kHz and 16kHz.

Select the setting from the following time periods (in milliseconds): 0–20ms, 10–30ms, 20–40ms, 30–50ms, 40–60ms, 50–70ms and 60–80ms. This setting will be applied to all channels during calibration.

When you're finished, select **Go**. It will take about 2–11 minutes for the calibration to finish.

!! Complete !! is displayed on-screen after the acoustic calibration equalization is set. If you want to check the settings, select **Check** and press **ENTER**.

X-Curve

Most soundtracks mixed for cinema sound too bright when played back in large rooms. The X-Curve setting acts as a kind of re-equalization for home theater listening, and restores proper tonal balance of movie soundtracks.

1 Select 'X-Curve' then press ENTER.

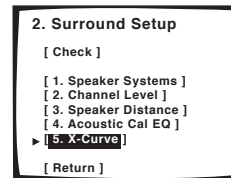

2 Use the ←/→ (cursor left/right) hard keys to switch the X-Curve ON or OFF.

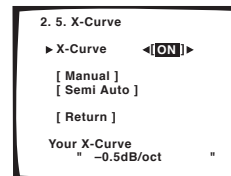

If you select **OFF**, the frequency curve will be flat and you won't be able to adjust the X-Curve.

3 Select a setup option and press ENTER.

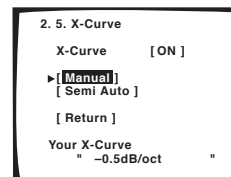

- **Manual** – Adjust the X-Curve manually.

- **Semi Auto** – The X-Curve is calculated automatically. The larger your listening area (as determined by the speaker distance setting), the greater the X-Curve slope (see the following step for more on this).

4 Check the X-Curve setting. If you selected 'Manual', make any adjustments necessary to the X-Curve.

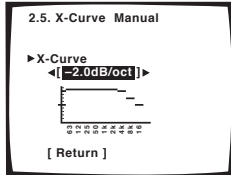

Use the \leftarrow/\rightarrow (cursor left/right) hard keys to adjust the setting. The X-Curve is expressed as a downwards slope in decibels per octave, starting at 2kHz. The sound becomes less bright as the slope increases (to a maximum of **-3.0dB/oct**). Use the following guidelines to set the X-Curve according to your room size:

Room size (m ²)	≤36	≤48	≤60	≤72	≤300	≤1000
X-Curve (dB/oct)	-0.5	-1	-1.5	-2	-2.5	-3

5 Select 'Return' then press ENTER to finish.



Note

- Since the principal is the same, X-Curve isn't applied when you're using any of the Home THX modes (see *Using the Home THX modes* on page 45).

Checking your surround settings

You can check through the receiver settings screen by screen after you're finished using the Surround Setup.

1 Select 'Check' from the Surround Setup menu and press ENTER.

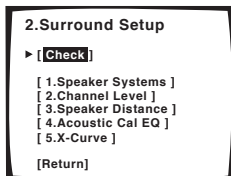

2 Use the \leftarrow/\rightarrow (cursor left/right) hard keys to cycle through the settings screen by screen.

These appear in the same order as the Surround Setup menu. Select **Return** then press **ENTER** to go back to the Surround Setup menu.



Chapter 8

Controlling other equipment

Using the remote control with other components

The supplied remote control can operate not only this receiver, but also your TV, DVD player and other components. If the component is listed in the remote control's memory, simply follow the steps in *Recalling preset codes* below. If the component is not listed, or if you want the remote to learn additional operations, see *Programming signals from other remote controls* on page 69.

Note

- The remote control operations in this section are accessed from the remote setup menu. To go to the remote setup menu, press  from the remote control Home menu ():

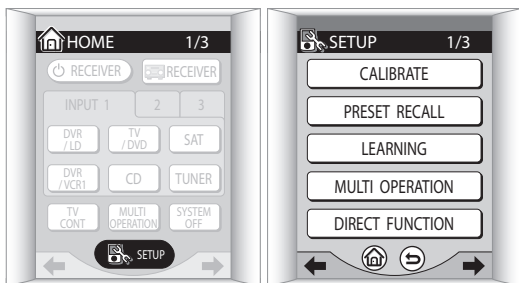

- For more on navigating the remote control menu screens, see *Basic remote control displays* on page 33. See also *TV control menu screens* on page 36 and *Operating menus for additional components* on page 37.
- When using a TV, it is often best to use the **TV/DVD** input for the TV source, and **TV CONT** for the TV screen or monitor.

Recalling preset codes

The following steps show you how to recall preset codes for each input source. Use the remote control touch screen to do this.



- 1 Make sure the component you want to control is switched on.
- 2 Press **PRESET RECALL** on the remote setup menu.

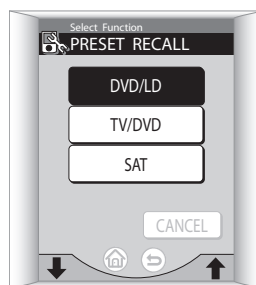

- 3 From the 'Select Function' screen, choose the input function which matches the connection for the component you want to control.

For example, press **DVD/LD** if you want to control the DVD player that you connected to the **DVD/LD** terminals.



- Use the / (cursor up/down) buttons to scroll through the component options.
- You can select any button, but choosing a button that's already assigned will overwrite the old preset (and any other operations you may have programmed).

4 From the 'Replacing Device' screen choose the type of component that you've connected.

In this example, we're setting the remote to control a DVD player, so we'll select **DVD**.



- It is best to have the input source button (**DVD/LD**) match the component.

5 From the 'Setting Makers' screen, select the name of the company that makes your component.

Use the **↑/↓** (cursor up/down) buttons to scroll through the available manufacturers. Here we'll select **PIONEER** as an example.

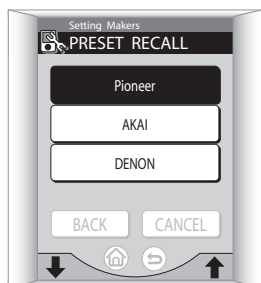

6 Select a setting type.

There may be only one option listed, or there may be several. Start with the first button available, which will show the makers name and **1** (in this case **Pioneer-1**).

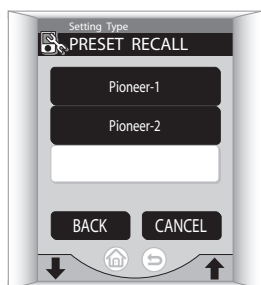

7 Point the remote at the component and press **TRY** to test if you've set it up properly.

If the component you are trying to control turns on/off, the setup for this component is complete and you can go to **step 8**.



If the component doesn't respond, it's possible that:

- Your component manufacturer has several preset codes for the same component. Press **BACK** to go back and select another number (if there is one) from the list.
- Your component doesn't have a standby mode (and therefore won't switch on/off).
- There is something blocking the path between the remote control and the remote sensor of the component you're trying to control.
- The preset code is unavailable for your component. Press **CANCEL** to exit, then try using the method described in *Programming signals from other remote controls* below to program the component into the remote control. If your component type is different from the set of controls associated with the input source (for example you want to control an LD with the **DVD/LD** button), it is useful to choose **INSTALL** in the next step to change the screen to control the component you've connected.

8 Press **INSTALL** to confirm and go back to the 'Select Function' screen to control another component.



From the **Select Function** screen (step 3), you can press **⏠** to exit and return to the remote control Home menu screen.

To exit without saving the preset you have assigned, press **CANCEL** instead of **INSTALL** above.

Tip

- Pioneer DVD recorders fall into the following setting types:

Pioneer-1 – DVR-7000

Pioneer-2-4 – DVR-310, DVR-510H

Pioneer-5 – DVR-57H, DVR-810H

If you have more than one Pioneer DVD recorder of setting type **2-4**, you can select different setting types for each (allowing for separate control).

Programming signals from other remote controls

If the preset code for your component is not available, or the available preset codes do not operate correctly, you can program signals from the remote control of another component. This can also be used to program additional operations (buttons not covered in the presets) after assigning a preset code in *Recalling preset codes* above.

1 Press LEARNING on the remote setup menu.



2 From the 'Select Function' screen, choose the input function which matches the connection for the component you want to control.

For example, press **DVD/LD** if you want to program signals for the DVD player that you connected to the **DVD/LD** terminals.

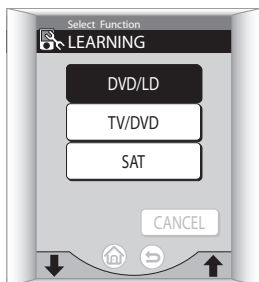

- Use the **↑/↓** (cursor up/down) buttons to scroll through the component options (the **RECEIVER** and **TUNER** screens are not available).

3 On the touch screen, press the button that corresponds to the command you want to teach the remote control.

For example, choose the **▶** (play) button to program this remote control to start playback on your DVD player.

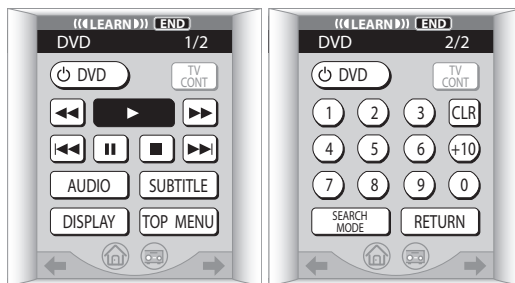

A remote icon shows in the top right corner of the touch screen after you've selected a button (you can deselect it by pressing it again).

- Remote control soft keys such as **⏪**, **⏩**, **⏮**, **⏭** (cursor left/right) and **TV CONT** are used to select menu screens (even in learning mode), so therefore cannot be programmed.
- The **Learn*** and **L*** buttons that appear on some component screens are unassigned buttons which can be used to learn new commands. See *Editing remote control button names* on page 70 to change the name once you've programmed a command.
- You can program the remote control hard keys (**VOLUME +/-** and **MUTE** are only available with **TV CONTROL**), but the command will remain the same for all screens of the component selected.
- Press **END** to go back without making any changes.

4 While the icon is displayed, point the two remote controls toward each other and press the button on the other remote control corresponding to the operation you want to program.

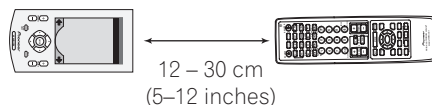

When the command has been learned, **OK!** shows on the remote control touch screen and the remote control returns to the command learning screen (step 3). Repeat steps 3 and 4 to program additional commands.

If you want to learn signals for additional components, press **END** to go back to the **Select Function** screen and start again from step 2.

Note

- If you see **Failed** (or **OK!** doesn't appear) on the touch panel, or **OK!** is displayed, but you find that the command wasn't learned, try teaching the command again, but vary the distance (closer or farther) between the remote controls. Some signals may be stronger than others and require more distance (a projector's remote signal, for example).
- There may be certain remote signals that can't be programmed correctly.
- The remote control has a limited memory. If you see **Memory Full** appear in the display, use the **PRESET RECALL** feature in *Recalling preset codes* on page 67 to overwrite any programmed buttons that you aren't using. This will free up memory to program additional remote signals.

Remote Direct function

- Default setting: All inputs – **ON**

On the default setting, when you press an input select button (**DVD/LD**, **DVR/VCR1**, etc.), both the receiver input source and the remote control change to the selected function.

When an input select button is set to **OFF**, pressing that button changes the function of the remote control only. This can be useful when you want to operate one component without interrupting playback of another.

1 Press DIRECT FUNCTION on the remote setup menu.



2 Choose the setting of an input by pressing the ON/OFF button on the touch screen.

Each press switches between **ON** and **OFF**.



- Use the **↑/↓** (cursor up/down) buttons to scroll through the component options.

3 Press OK to confirm the settings.

Editing remote control button names

You can rename the buttons on the remote control menu screens for different input sources (such as **DVD/LD** or **SAT**). You may want to do this if you taught the remote control a new command in *Programming signals from other remote controls* above, but the command doesn't correspond with the button name.

1 Press KEY LABEL on the remote setup menu.

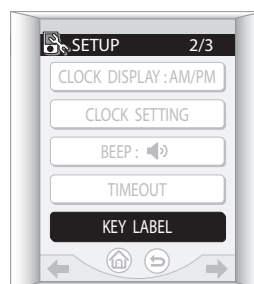

2 From the 'Select Function' screen, select the input source menu that contains the button you want to rename.

For example, press **DVD/LD** if you taught the **DVD/LD** remote screen a new command from your DVD player.

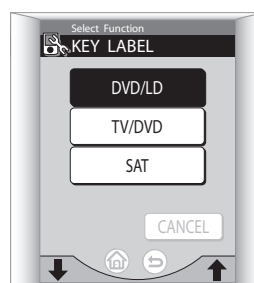

3 Select the button you want to rename.

For example, choose the **SEARCH MODE** button if it was programmed with the 'eject' command from your DVD player's remote.



- Remote control soft keys such as , , (cursor left/right) and **TV CONT** are used to select menu screens (even in learning mode), so therefore cannot be renamed.
- Press **END** to go back without making any changes.

4 Choose how you want to change the look of the button.

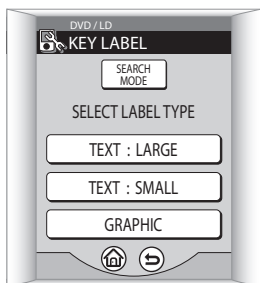

Select one of the following options:

- **TEXT : LARGE** – Select this if you want to input a short name, such as **EJECT**.
- **TEXT : SMALL** – Select this if the name is fairly long, for example, **DVD Tray Eject**.
- **GRAPHIC** – Select this if you want to replace the button name with an icon, such as .

5 Edit the button as necessary.

If you selected the text input method:



- Use the letter and number buttons to spell out the name you want.
- Press **SPACE** to add a space in the name.
- Press **CLEAR** to delete characters one at a time.
- Press (small text only) to go to the next line.
- Use the (cursor left/right) soft keys to go forward/back a screen.

If you selected the graphic input method:



- Use the icon buttons to select a graphic.
- Press **CLEAR** to return to the original button appearance.
- Press to go back without editing the button.

6 Press OK when you've finished.

PLEASE WAIT shows in the remote display while the name or graphic is input and you'll return to step 3.

Note

- With power buttons, you won't be able to delete the 'o' graphic. These buttons are best left for switching the component on or off.
- After confirming, you won't be able to return to the original button appearance without resetting the remote control (as described on page 11).

Multi Operation and System Off

The Multi Operation feature allows you to program a series of commands for the components in your system. For example, you could turn on your TV, turn on your DVD player and start playing the loaded DVD using only two buttons on the remote control.

Similar to multi operations, System Off allows you to use one button to stop and switch off a series of components in your system at the same time.

Note

- Before Multi Operation and System Off will work correctly, you must setup the remote to work with your TV and other components (see *Recalling preset codes* on page 67 and *Programming signals from other remote controls* on page 69 for more on this).
- Power on and off commands only work with components that have a standby mode.

Programming a multi operation or a shutdown sequence

1 Press MULTI OPERATION on the remote setup menu.



2 From the 'Select Function' screen, choose the input function.

This will be the one that starts the multi operation when you select it as an input source. For example, press **DVD/LD** if the multi operation is being used to switch on the DVD player connected to the **DVD/LD** terminals.

If you are programming a shutdown (system off) sequence, select **RECEIVER** from the end of the list.

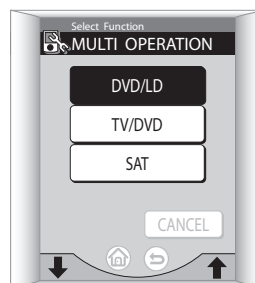

- Use the **↑/↓** (cursor up/down) buttons to scroll through the component options.

3 Press 'Add' to choose an operation in the sequence.

If this is the first command in the sequence, the operation you're adding will be placed at the top. Otherwise, the command will simply take the next place in the sequence.

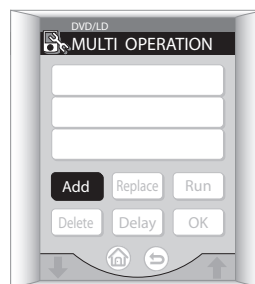

4 Choose the component and command you want to add to the multi operation or shutdown sequence.

For example, choose **DVD/LD** from the select function menu (this now takes the name of the multi-operation component), then **▶** (play) or **■** (stop) from the DVD menu to start (or stop) playback on your DVD player.



- Press **END** to go back without making any changes.

- You don't need to program the receiver to switch to the input function selected in step 2, or to switch on or off. This is done automatically.

With Pioneer components, you don't need to:

- program the power to switch off in a shutdown sequence;
- program the power to switch on if it's the source component selected in step 2;
- program a Pioneer TV or monitor to switch on if the input function (selected in step 2) has video input terminals;

These take priority in multi operations (not shutdown).

5 If necessary, add a delay between operations by pressing 'Delay'.

Some components may take a few seconds to switch on or off, or perform certain operations. In these cases, you may want to add a slight delay (up to sixty seconds is possible) between commands.

Use the + and - buttons on the **Delay Time** screen to adjust the delay time then press **OK**.



- If you want to change the delay time after it's been set, press the delay time, then press **SET** to come back to this screen.

6 Repeat steps 3 to 5 for additional commands.

As each command is entered, they will appear in order on the remote touch screen.



- To test the sequence before confirming it, press **Run**.
- To replace a command in the sequence, select the command then press **Replace**. Add the operation as shown in the steps above.

- To add a new command above another command, press the existing command before pressing **Add**.
- To erase a command, select the operation you want to erase and press **Delete**.
- Commands will be stored regardless of how you exit from this screen.

7 Press OK when you're finished.

PLEASE WAIT shows in the remote display while the multi operation is stored and you'll return to step 2.

Using multi operations

You can start multi operations with the receiver switched on, or in standby.

- 1 From the remote control Home menu press **MULTI OPERATION**.



- 2 Press a function button that has been set up with a multi operation.

The receiver switches on (if it was in standby) and the programmed multi operation is performed automatically.

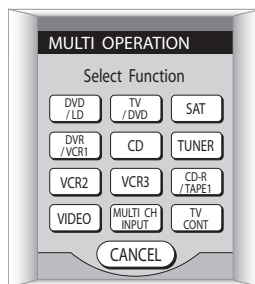

Using System off

- From the remote control Home menu  press **SYSTEM OFF**.

The command sequence you programmed will run, then all Pioneer components will switch off, followed by this receiver.



Switching components on and off using the 12 volt trigger

You can connect components in your system (such as a screen or projector) to this receiver so that they switch on or off using a 12 volt trigger when you select an input function. However, you must specify which input functions switch on which trigger(s) using the Expert Setup menu (see *12 Volt Trigger* on page 95 to do this). Note that this will only work with components that have a standby mode.

- Connect the **12V TRIGGER** jack of this receiver to the **12V TRIGGER** of another component.

Two connections are possible. Use a cable with a mono mini-plug on each end for each connection.

After you've specified the input functions that will switch on the trigger(s), you'll be able to switch the component on or off just by pressing the input function(s) you've set on page 95.

Operating other Pioneer components with this unit's sensor

Many Pioneer components have SR **CONTROL** jacks which can be used to link components together so that you can use just the remote sensor of one component. When you use a remote control, the control signal is passed along the chain to the appropriate component.

Note that if you use this feature, make sure that you also have at least one set of analog audio jacks connected to another component for grounding purposes.

- Decide which component you want to use the remote sensor of.

When you want to control any component in the chain, this is the remote sensor at which you'll point the corresponding remote control.

- Connect the **CONTROL OUT** jack of that component to the **CONTROL IN** jack of another Pioneer component.

Use a cable with a mono mini-plug on each end for the connection.

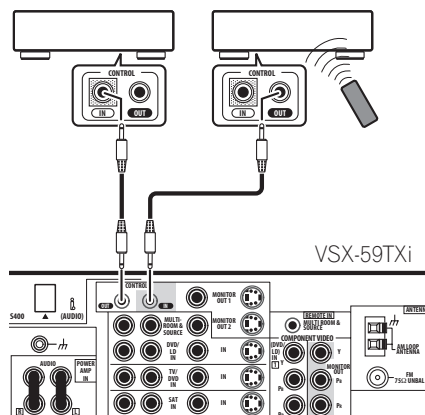

- Continue the chain in the same way for as many components as you have.

Note

- If you want to control all your components using this receiver's remote control, refer to *Using the remote control with other components* on page 67 and *Programming signals from other remote controls* on page 69.

Chapter 9

Using other functions

Making an audio or a video recording

You can make an audio or a video recording from the built-in tuner, or from an audio or video source connected to the receiver (such as a CD player or TV).

Keep in mind you can't make a digital recording from an analog source or vice-versa, so make sure the components you are recording to/from are hooked up in the same way (see *Connecting your equipment* on page 14 for more on connections).

You can record using composite and S-video connections interchangeably, but you won't be able to record sources connected to the component video inputs. See *About the video converter* on page 22 for more on this.

For more information about video connections, see *Connecting a VCR or DVD recorder* on page 20 and *Connecting other video sources* on page 21.

1 Select the source you want to record.

Use the **INPUT** buttons (or the **INPUT SELECTOR** dial on the front panel).

2 Select the input signal (if necessary).

Press **SIGNAL SELECT** to select the input signal corresponding to the source component (see *Selecting the input signal type* on page 48 for more on this).

3 Prepare the source you want to record.

Tune to the radio station, load the CD, video, DVD etc.

4 Prepare the recorder.

Insert a blank tape, MD, video etc. into the recording device and set the recording levels.

Refer to the instructions that came with the recorder if you are unsure how to do this. Most video recorders set the audio recording level automatically—check the component's instruction manual if you're unsure.

5 Start recording, then start playback of the source component.





Note

- The receiver's volume, tone (bass, treble, Midnight, Loudness), and surround effects have no effect on the recorded signal.
- Some digital sources are copy-protected, and can only be recorded in analog.
- Some video sources are copy-protected. These cannot be recorded.

Monitoring your recording

You can listen to (monitor) the recording as it's being made if you've connected a cassette deck with a monitoring function to the **TAPE 2 MONITOR** jacks on the rear panel.

- **Press TAPE 2 MONITOR to switch between the recorded signal and the original source signal.**

With the remote, you may need to press  on the Home menu () first before reaching the receiver menu screen shown below (use the / (cursor left/right) soft keys to go to the previous/next menu screen).

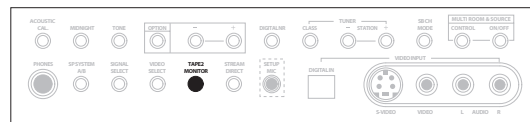

Tip

- To record the tape 2 monitor signal to a recorder connected to the **CD-R/TAPE 1** inputs, select any input (except **CD-R/TAPE 1**) and switch the tape 2 monitor on.

Reducing the level of an analog signal

The input attenuator lowers the input level of an analog signal when it's too strong. You can use this if you find that the **OVER** indicator lights often, or you can hear distortion in the sound.

- From the remote control receiver menu, press **INPUT ATT** to switch the input attenuator on or off.

You may need to press **RECEIVER** on the Home menu (🏠) first before reaching the receiver menu screen shown below (use the **←/→** (cursor left/right) soft keys to go to the previous/next menu screen).



Note

- The attenuator isn't available with digital sources, or when using Stream Direct modes 2 or 3.

Adjusting the delay of a soundtrack

Some monitors have a slight delay when showing video, so the soundtrack will be slightly out of sync with the picture. By adding a bit of delay, you can adjust the sound to match the presentation of the video.

- 1 Press **OPTION** repeatedly until **SOUND DELAY** shows in the display.

With the remote, you may need to press **RECEIVER** on the Home menu (🏠) first before reaching the receiver menu screen shown below (use the **←/→** (cursor left/right) soft keys to go to the previous/next menu screen).

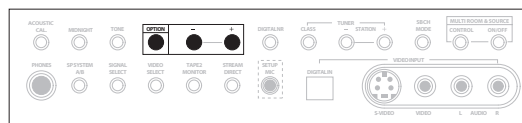

- 2 Use the **(OPTION) +/-** buttons to adjust the amount of delay.

The delay can be adjusted from 0.0–6.0 frames (in 0.1 frame steps).

- 3 Press **ENTER** to confirm.

Note

- When listening to an analog source, you can't use sound delay when Stream Direct is on.
- One second is equal to 30 frames of NTSC format video, and 25 frames of PAL.

Watching video and audio sources independently

You can listen to a sound source and select a different video source on your TV.

- While listening to a source, press **VIDEO SELECT** to select the video source you want to watch.

With the remote, you may need to press **RECEIVER** on the Home menu (🏠) first before reaching the receiver menu screen shown below (use the **←/→** (cursor left/right) soft keys to go to the previous/next menu screen).

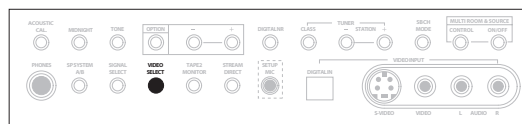

Press repeatedly to cycle through the possible video sources. You can select **DVD/LD**, **TV**, **SAT**, **VIDEO**, **DVR/VCR1**, **VCR2**, **VCR3** or **OFF** (no video signal).

Note

- If you change the source using the input buttons (or front panel **INPUT SELECTOR** dial), the system returns to normal playback.

Enhancing SACD playback

You can get more detail from SACDs by maximizing the dynamic range (during digital processing) using the SACD gain feature.

1 Press **OPTION** repeatedly until **SACD GAIN** shows in the display.

With the remote, you may need to press **RECEIVER** on the Home menu (🏠) first before reaching the receiver menu screen shown below (use the **←/→** (cursor left/right) soft keys to go to the previous/next menu screen).

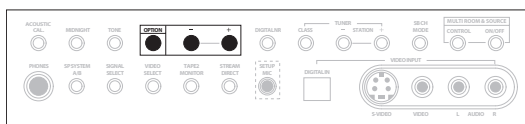

2 Use the **(OPTION) +/-** buttons to switch the SACD gain between **0dB** and **6dB**.

For most SACD sources, selecting **6dB** will result in high sound quality and greater detail. The level will be adjusted automatically for playback at the same volume.

3 Press **ENTER** to confirm.

Note

- You shouldn't have any problems using this feature with most SACD discs, but if the sound distorts, it is best to switch the gain setting back to **0dB**.

Using the A/D converters to give greater definition to 2-channel sound

This receiver has high-quality 192kHz (24bit) A/D converters that can be used in parallel to provide greater resolution of DSP processing with analog 2-channel sources. There are two ways to get 192kHz A/D conversion:

1 Switch the **SD:1 NORMAL Stream Direct mode on**.

See *Using the Stream Direct mode* on page 47 for more on this.

2 Select the **STEREO** listening mode and switch off any other sound processing features.

These features include:

- Midnight/Loudness (page 52)
- Digital Noise Reduction (page 53)
- Dynamic Range Control (page 94)

Also, make sure you also switch the multichannel input to **2 CHANNEL** in *Selecting USB and multichannel analog input channels* on page 49.

Dimming the display

You can choose between four brightness for the front panel display. Note that when selecting sources, the display automatically brightens for a few seconds.

- From the remote control receiver menu, press **DISPLAY DIMMER** repeatedly to change the brightness of the front panel display.

You may need to press **RECEIVER** on the Home menu (🏠) first before reaching the receiver menu screen shown below (use the **←/→** (cursor left/right) soft keys to go to the previous/next menu screen).



Switching the speaker impedance

- Default setting: **Speaker 6Ω**

We recommend using speakers of 6Ω to 16Ω with this system, but it is possible to switch the impedance setting if you plan to use speakers with a lower impedance rating (for example, less than 6Ω).

- **With the receiver in standby, press \odot STANDBY/ON while holding down the OPTION – button.**

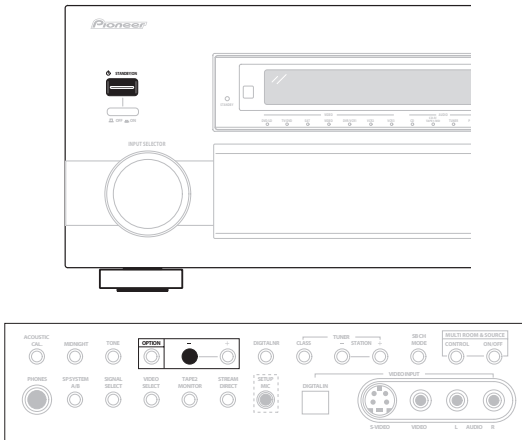

Each time you do this, you switch between the impedance settings:

- **Speaker 4Ω** – Use this setting if your speakers are rated lower than 6Ω.
- **Speaker 6Ω** – Use this setting if your speakers are rated 6Ω or more.

Note

- If you select **Speaker 4Ω** above, the Stream Direct setting is fixed at **SD:1 NORMAL** (see *Using the Stream Direct mode* on page 47).

Checking your system settings

Use the status display screen to check the various settings you've made for features such as sound delay, digital noise reduction, and high-sampling.

- 1 **From the remote control receiver menu, press STATUS to check the system settings.**

You may need to press RECEIVER on the Home menu (HOME) first before reaching the receiver menu screen shown below (use the \leftarrow/\rightarrow (cursor left/right) soft keys to go to the previous/next menu screen).



These appear on both the OSD and the front panel display.

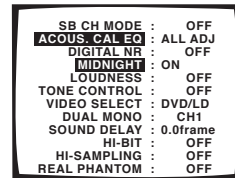

The front panel display shows each of the following settings for two seconds each:

Surround back speaker/ Virtual back speaker	Video select
Acoustic calibration EQ	Dual mono
Digital noise reduction	Sound delay
Midnight	Hi-bit
Loudness	High-sampling
Tone	Real phantom

Note

- If the Stream Direct mode is switched on, some settings above will show **OFF**, even though they are switched on.

- 2 **When you're finished, press STATUS again to switch off the display.**

Resetting the system

Use this feature to reset the system to its factory default settings (see *Default receiver settings* below).

1 Switch the receiver into standby.

2 While holding down the front panel DIGITAL NR button, press and hold STANDBY/ON for about three seconds.

The display shows **RESET?**.

3 Press the front panel OPTION + button.

The display shows **OK?**.

4 Within 5 seconds, press OPTION –.

The receiver should now be reset.



Note

- This doesn't affect the presets that you have programmed into the remote control (see *Using the remote control with other components* on page 67). See *Resetting the remote control* below to do this.

Default receiver settings

The table below shows the factory default settings. When you reset the system, the receiver reverts to these defaults:

Setting type	Default setting	Page ref.
Input	DVD/LD	
Master volume	--- dB (no sound)	
Listening mode	STANDARD (video inputs, multichannel inputs, USB) STEREO (audio inputs)	page 43
Advanced surround effect level	90 (5/7CH STEREO) 50 (all other modes)	page 45
Listening mode (w/ headphones)	STEREO	page 46
USB / multichannel input channel setting	8 channels	page 47
Stream Direct mode	SD:1 NORMAL (ON)	page 47
Acoustic Calibration EQ	OFF (switches to ALL CH ADJ after the Auto Surround Setup)	page 48
Input signal select	AUTO except multichannel inputs (ANALOG) and USB (DIGITAL)	page 48
Surround Back Channel mode	ON (with surround back speaker(s) connected)	page 50
Virtual Surround Back mode	OFF	page 51
Hi-bit/Hi-sampling	OFF	page 52
Midnight/Loudness	OFF	page 52

Setting type	Default setting	Page ref.
Tone	BYPASS	page 52
Digital NR	OFF	page 53
Dual mono	CH1	page 53
Speakers Systems	Normal Surround	page 58
Speaker B setting	Second Zone	page 58
Speakers (front, center, surround, surround back) setting	All SMALL	page 59
Subwoofer setting	YES	page 59
Crossover frequency	80Hz	page 59
Channel levels	All 0 dB (no adjustment)	page 60
Speaker distance settings	All 10 ft.	page 61
Acoustic Calibration	0dB (no calibration)	page 61
X-Curve	OFF (switches to ON after the Auto Surround Setup)	page 61
Tape 2 monitor	OFF	page 75
Input attenuator	OFF (all inputs)	page 76
Sound delay	0.0 frames	page 76
SACD gain	0dB	page 77
Speaker A/B setting	A	page 80
Digital jack assignment	Digital-1 (coaxial) – DVD/LD Digital-2 (coaxial) – TV/DVD Digital-3 (coaxial) – CD Digital-4 (optical) – SAT Digital-5 (optical) – DVR/VCR1 Digital-6 (optical) – CD-R/TAPE1/MD RF (coaxial) – DVD/LD	page 90
Component video jack assignment	Component1 – DVD/LD Component2 – OFF Component3 – OFF	page 91
Video input assignment	MULTI IN – OFF USB – OFF	page 92
Bass Peak Level	OFF (No limit)	page 93
Dynamic range control	OFF	page 94
OSD overlay	ON	page 94
12 volt trigger	OFF · OFF	page 95
THX Ultra2 subwoofer	NO	page 96
Surround back speaker position	0-1ft	page 96

Chapter 10

Other connections

Using speaker system B

You can connect a pair of speakers to the B speaker terminals on the rear panel to listen to stereo playback in another room, or you can also use these terminals to hear surround sound when playing DVD-Audio sources. Once you've made these connections, you'll have to change the speaker setting in *Speaker Systems* on page 58 to specify how you're using speaker system B.

Switching the speaker system

This unit has three speaker system settings which allow you to select the speaker system(s) you want to use. What you will hear depends on the settings you made in *Speaker Systems* on page 58. If you selected **Normal Surround** for speaker system A, and **Second Zone** for speaker system B, sound is output according to the explanations below.

- Use the **SPEAKER A/B** button on the remote control receiver menu screen to select a speaker system setting.

You can also use the **SP SYSTEM A/B** button on the front panel.

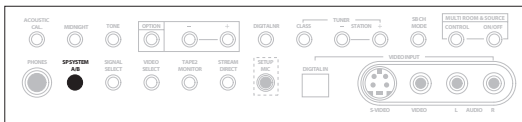

Press repeatedly to cycle through the speaker system options:

- **SP▶A** – Sound is output from speaker system A and the same signal is output from the pre-out terminals.
- **SP▶B** – Sound is output from the two speakers connected to speaker system B. Multichannel sources will be downmixed to these two speakers. The same signal is output from the surround back channel pre-out terminals.
- **SP▶AB** – Sound is output from speaker system A (up to 5 channels, depending on the source), the two speakers in speaker system B, and the subwoofer. The sound from speaker system B will be the same as the sound from speaker system A (multichannel sources will be downmixed to 2 channels). The same signal as speaker A is output from the pre-out terminals, except for the surround back pre-outs, which output the same signal as speaker B.
- **SP▶** (off) – No sound is output from the speakers. The same sound is output from the pre-out terminals as when selecting speaker system A (above).

 **Note**

- The subwoofer output depends on the settings you made in *Speaker Systems* on page 58. However, if **SP▶B** is selected above, no sound is heard from the subwoofer (the LFE channel is not downmixed).
- Depending on the settings in *Speaker Systems* on page 58 and *Using the Stream Direct mode* on page 47, output from the surround back pre-out terminals may change.
- All speaker systems are switched off when headphones are connected.

Using speaker system B in another room

Connect a pair of speakers to the speaker B terminals on the rear panel the same way you connected your speakers in *Connecting the speakers* on page 26. Make sure to review *Placing the speakers* on page 27 when placing the speakers in another room.

We recommend using speakers with a nominal impedance between 6–16Ω (please see *Switching the speaker impedance* on page 78 if you plan to use speakers with a lower impedance).

Alternating surround speaker setups using speaker system B (ITU-R)

After you connect an alternate set of surround speakers, you can use speaker system B to provide surround sound when listening to sources like DVD-Audio discs. This will give you a setup of 9 speakers where the front and center speakers can be used with normal 7.1 surround (speaker system A), or 5.1 surround with DVD-Audio sources (speaker system B in ITU-R setting).

1 Connect an alternate (ITU-R) set of surround speakers as shown below.

Connect the ITU-R surround left speaker to the left speaker terminal of speaker system B. Connect the ITU-R surround right speaker in the same way.

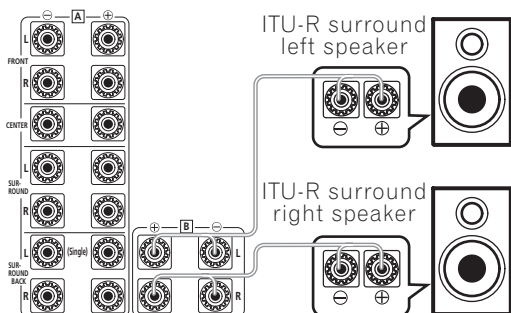

- Make sure that the + / - connections are properly inserted.

2 Select the 'ITU-R' setting from the Speaker Systems menu.

See *Speaker Systems* on page 58 to specify how you're using speaker system B. **Normal Surround** should be selected to make this setting.

3 Use the SPEAKER A/B button on the remote control receiver menu screen to select a speaker system setting.

You can also use the **SP SYSTEM A/B** button on the front panel.

Choose between the following settings (the shaded boxes indicate the active speakers in each setup):

- **SP▶A: Normal** – Normal surround (for movies, etc.)

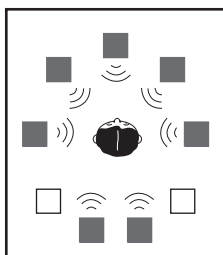

- **SP▶B: ITU-R** – ITU-R surround setup for DVD-Audio and other multichannel music sources. See *Speaker system setup for DVD-Audio/multichannel music sources* on page 98 for more on this.

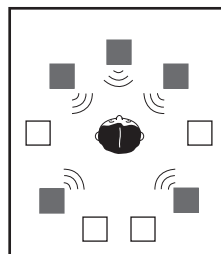

- **SP▶OFF** – No sound is output from the speakers.

Note

- Depending on the Stream Direct mode, the surround channel signal(s) will be output from either the surround, or surround back channel pre-outs when **SP▶B: ITU-R** is selected.

Bi-amping your front speakers

Bi-amping is when you connect the high frequency driver and low frequency driver of your speakers to different amplifiers (in this case, to both front and surround back terminals) for better crossover performance. Your speakers must be bi-ampable to do this (having separate terminals for high and low) and the sound improvement will depend on the kind of speakers you're using.

1 Connect your speakers as shown below.

This illustration below shows the connections for bi-amping your front left speaker. Hook up your front right speaker in the same way.

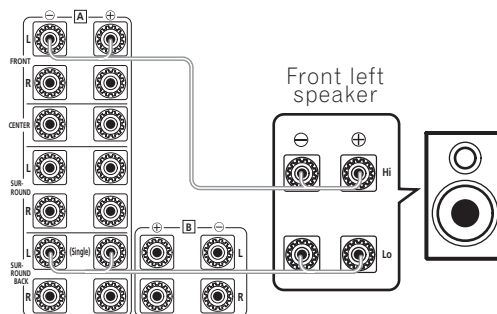

Since both front and surround back speaker terminals output the same audio, it doesn't matter which set (front or surround back) is powering which part (**Hi** or **Low**) of the speaker.

- Make sure that the + / - connections are properly inserted.

2 Select the 'Front Bi-Amp' setting from the Speaker Systems menu.

See *Speaker Systems* on page 58 to specify how you're using the surround back speaker terminals.

Note

- For 7.1 surround sound with this configuration, you must connect an additional amplifier to the surround back channel pre-outs. See *Connecting additional amplifiers* on page 82 for more on this.

Caution

- Most speakers with both **Hi** and **Low** terminals have two metal plates that connect the **Hi** to the **Low** terminals. These must be removed when you are bi-amping the speakers or you could severely damage the amplifier. See your speaker manual for more information.
- If your speakers have a removable crossover network, make sure you do not remove it for bi-amping. Doing so may damage your speakers.

Bi-wiring your speakers

The reasons for bi-wiring are basically the same as bi-amping, but additionally, interference effects within the wire could be reduced, producing better sound. Again, to do this your speakers must be bi-wireable (that is they must have separate terminals for the high and low frequencies). When bi-wiring, make sure you've selected **Normal Surround** in *Speaker Systems* on page 58.

- To bi-wire a speaker, connect two speaker cords to each speaker terminal on the receiver.

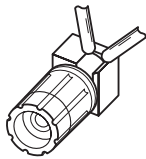

Caution

- Make sure you use a parallel (not series, which are fairly uncommon) connection when bi-wiring your speakers.
- Don't connect different speakers from the same terminal in this way.

Adding a second set of surround speakers for Bi-Surround

If your listening area is quite long, and you are seated far from the front speakers, you may want to add an extra set of left and right surround speakers instead of your surround back speakers. These should be placed between the front speakers and your existing surround speakers (which should already be placed on either side of your listening position).

1 Connect a second set of surround speakers as shown below.

Connect the second surround left speaker to the surround back left speaker terminal. Connect the second surround right speaker in the same way.

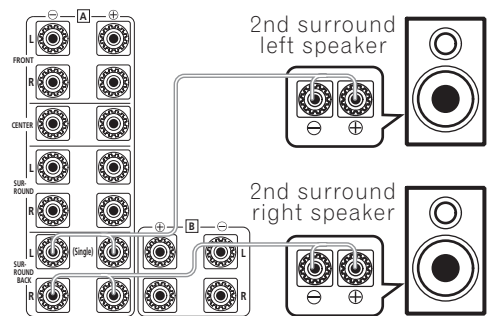

- Make sure that the + / - connections are properly inserted.

2 Select the 'Bi-Surround' setting from the Speaker Systems menu.

See *Speaker Systems* on page 58 to specify how you're using the surround back speaker terminals.

Using the pre-outs

Connecting additional amplifiers

This receiver has more than enough power for any home use, but it's possible to add additional power to every channel of your system using the pre-outs. If you use additional amps for the front channels take out the U-shaped connectors (see item 8 in *Rear panel* on page 14). Make the connections shown below to add amplifiers to power your speakers.

Note

- Before making or changing the connections, switch off the power and disconnect the power cord from the AC outlet.

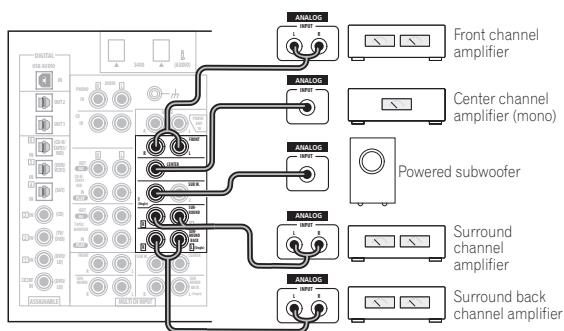

- You can use the additional amplifier on the surround back channel pre-outs for a single speaker as well. In this case plug the amplifier into the left (L (Single)) terminal only.

Connecting an external stereo pre-amplifier

It's possible to use a separate stereo pre-amp with this receiver if necessary. You might want to do this if you need to connect more sources than this receiver can accommodate, or if you prefer to use a specific pre-amp for sound quality reasons. You can connect sources to either this receiver or to the external pre-amp (giving you a greater number of input possibilities).

Note that with sources connected this receiver, any signal sent to the two front channels will be sent to the pre-amplifier before being heard through the front speakers in your system.

1 Remove the U-shaped connectors that connect the FRONT PRE OUT jacks to the POWER AMP IN jacks.

2 Use a stereo RCA audio cable to connect the FRONT PRE OUT jacks of this receiver to a stereo input on the pre-amp.

For example, connect to the CD or tape inputs on the rear of the pre-amp. You'll have to select that source if you want to hear the stereo signal from this receiver.

3 Use a stereo RCA audio cable to connect the stereo pre-out jacks of the pre-amp to the POWER AMP IN jack of this receiver.

This will allow you to hear the stereo source from the external pre-amp through this receiver. For stereo sources connected directly to the external pre-amp, this receiver acts as a standard power amplifier. For digital sources connected to this receiver, the receiver acts as a digital decoder/digital-to-analog converter and as a power amplifier.

Multi-room setup

When used together with an optional IR receiver, this receiver can power two independent systems in separate rooms. Different sources can be playing in both rooms at the same time or, depending on your needs, the same source can also be used. The main and sub rooms have independent power (the main room power can be off while the sub room is on) and the sub room can be controlled by this unit's remote control. You may need to specify your volume setting and IR receiver type in *Multi-Room Setting* on page 95.

Making multi-room connections

It is possible to make these connections if you have a separate amplifier, speakers, TV and an IR receiver (such as the Pioneer MR-100) for your sub room.

1 Connect the IR receiver sensor to the green MULTI-ROOM & SOURCE REMOTE IN jack on the rear of this receiver.

2 Connect a separate amplifier and TV monitor to the MULTI-ROOM & SOURCE OUT jacks on the rear of this receiver.

You should have a pair of speakers attached to the sub room amplifier as shown in the illustration below.

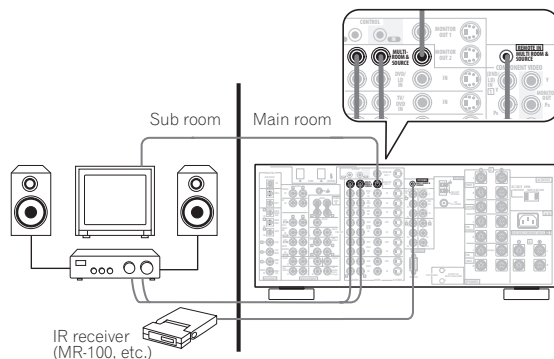

Note

- It is not possible to hear the digital output of a component in the sub room. However, you can connect the analog outputs of your digital component into the receiver's (analog) input terminals to hear the component in the sub room.
- You can't use sound controls (such as the tone controls or Midnight listening) or any surround modes in the sub room. You can, however, use the features available with your sub room amplifier.

- When selected in the main room, i.LINK sources can't be heard in the sub room unless they can output both i.LINK and analog signals at the same time. Also, the sound from an i.LINK source selected in the sub room switches off if the same source is selected as an i.LINK source in the main room.

Using the sub room controls

You can use the remote to adjust the sub room volume and select sources from either the main room or the sub room. You can also do this using the front panel controls.



Important

- The receiver must be switched on (or in standby) in the main room to control the sub room.

Using the remote control in the sub room

- 1 Point the remote control at the IR receiver and press **RECEIVER**.

This switches on the multi-room feature (**MULTI ROOM&SOURCE**).

- 2 Use the Home menu screen buttons to control the sub room.

The **INPUT** buttons work for the sub room the same way they would for the main room (see *Home menu screens* on page 33 for more detail), and the hard-key volume controls adjust the volume in the sub room.

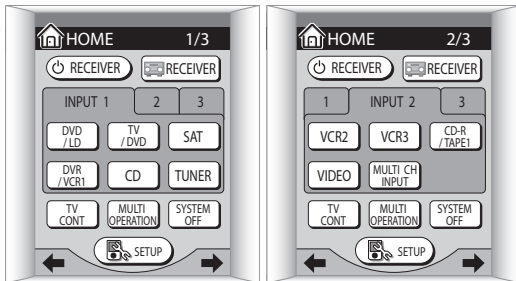

Tip

- Press **MR&S ON/OFF** to use the buttons on the **Sub Room Control** screen in the sub room.



Using the remote control in the main room

- 1 From the receiver menu screens on the remote control, select the **Sub Room Control** screen.

If you're unsure how to do this, see *Receiver menu screens* on page 34.



- 2 Press **MR&S ON/OFF** to switch on the multi-room feature.

You can also press the **MULTI ROOM & SOURCE ON/OFF** button on the front panel.

The **MULTI ROOM** indicator lights on the front panel to indicate the multi-room feature has been switched on.

- 3 Use the **Sub Room Control** screen buttons the same way you control this receiver from the main Home menu.

The source input buttons work the same way as the controls listed in *Home menu screens* on page 33, and the on-screen volume control adjusts the sub room.

Using the front panel multi-room controls

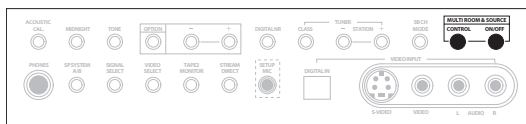

1 Press the MULTI ROOM & SOURCE ON/OFF button on the front panel.

The **MULTI ROOM** indicator lights on the front panel to indicate the multi-room control has been switched on.

2 Press CONTROL.

Make sure that any operations for the sub room are done while **MULTI ROOM** shows in the display. If **MULTI ROOM** is not showing, the front panel controls affect the main room only.

3 Use the INPUT SELECTOR dial to select the source.

Select between **DVD/LD**, **TV/DVD**, **SAT**, **DVR/VCR 1**, **CD**, **CD-R/TAPE 1** or **TUNER** (in that order).

If you select **TUNER**, you can use the front panel **TUNER** controls to select a preset station (see *Listening to memorized station presets* on page 56 if you're unsure how to do this).

4 Use the MASTER VOLUME dial to adjust the volume.

This is only possible if you selected the **VARIABLE** volume control in *Multi-Room Setting* on page 95.

5 When you're finished, press CONTROL again to return to the main room controls.

You can also press the **MULTI ROOM & SOURCE ON/OFF** button on the front panel to switch off all output to the sub room.

Note

- Multi-room can't be used when you're setting up the system (from the on-screen **System Setup** menu).
- If you're using a Pioneer amplifier in the sub room, you may want to cover the remote sensor so that this remote control doesn't accidentally control the sub room amplifier.
- You won't be able to switch the main room off completely unless you've switched off the multi-room control first.
- When someone is controlling the system from the main room, you won't be able to operate the sub room controls.

Using the i.LINK interface

If you have a component with an i.LINK connector, you can connect it to this receiver using an i.LINK cable.

Since the i.LINK interface does not transmit video signals, the video signal of i.LINK-connected components must be connected with other cables (see *Connecting your equipment* on page 14 for more on making video connections). If you've already hooked up the video signal from the component, assign the i.LINK input to the input function to which you've connected the video signals (see *Assigning the i.LINK inputs* on page 91).

The two i.LINK connectors on the rear of your receiver are 4-pin connectors. Use a 4-pin, S400 i.LINK cable to connect i.LINK-equipped components.

Important

- Please use 4-pin, S400 cables less than 3.5 meters long. Although longer ones are available, they may not work reliably.
- If your i.LINK connector comes into contact with metallic parts of the receiver other than the i.LINK terminal, an electrical short may occur. Some cables have metal parts that may touch the unit when connected. Please take care to use a suitable i.LINK cable only.
- There may be cases where the PQLS/rate control function and/or the i.LINK audio does not work properly even when connected to i.LINK Audio-compatible equipment.
- During playback through an i.LINK connection, do not disconnect i.LINK cables or switch off any components connected using i.LINK.
- Copy-protected 96kHz DVD-Video discs can be heard through the i.LINK connection, but they will be down-sampled to 48kHz.

- Use an i.LINK cable to connect one of the i.LINK connectors on this receiver to an i.LINK connector on your i.LINK component.

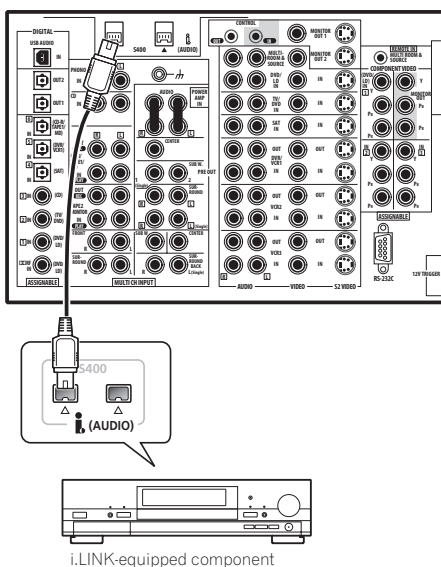

- The arrow on the cable connector body should face down for correct alignment with the connector on the player. When properly connected, the i.LINK plug will snap into the connector. If not connected properly the receiver will not be able to recognize any connected components.

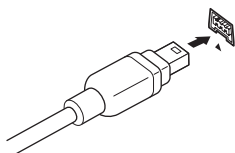

Note

- You can connect several components together using i.LINK. See *Creating an i.LINK network* below.

About i.LINK

i.LINK is a trademark name for IEEE1394, a high-speed interface for digital audio, video and other data found on personal computers, digital camcorders, and other kinds of audio and audio/visual equipment. A single i.LINK connector can both send and receive data at the same time, so only one cable is required to connect components for two-way communication.

"i.LINK" and the "i.LINK" logo are trademarks of Sony Corporation.

About PQLS rate control

Pioneer's PQLS (Precision Quartz Lock System) technology provides high-precision digital audio from DVD-A, SACD and audio CD sources when you use the i.LINK interface. A precision quartz controller in this receiver eliminates distortion caused by timing errors (jitter), giving you the best possible digital-to-analog conversion from the digital source.

To take advantage of PQLS, you must have a player compatible with rate-control, and it must be switched on and connected to this receiver through the i.LINK network.

Creating an i.LINK network

Using i.LINK it is possible to chain up to 17 components together so that the digital audio and control signals from each component is available to other components in the network. With the addition of an i.LINK repeater, it's possible to connect up to 63 components.

i.LINK connectors come in 4-pin and 6-pin configurations. This player uses the 4-pin connection, but the two types can be mixed on a network.

This receiver is compatible with i.LINK Audio (A&M protocol) components, such as DVD players. Note that when connected to i.LINK MPEG-II TS equipment (such as a digital satellite tuner), i.LINK DV equipment (such as a DVD recorder or DV camcorder), or an i.LINK-equipped personal computer, audio and video signals are not transmitted, and connecting to these devices sometimes causes network interruptions. Check the operating instructions supplied with your other i.LINK components for compatibility information.

This receiver is DTCP (Digital Transmission Content Protection) compliant, so you can play DVD-A, DVD-Video, and SACD i.LINK audio.

When setting up an i.LINK network, it's important that the components form an open ended chain (fig. 1), or a tree (fig. 2).

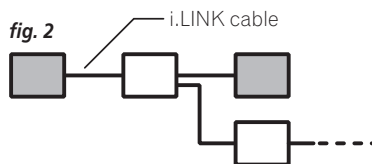
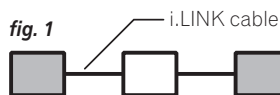

The system will not work if the connected components form a loop. If a loop is detected, the message **LOOP CONNECT** shows in the display. Figs. 3 and 4 show connections that form a loop.

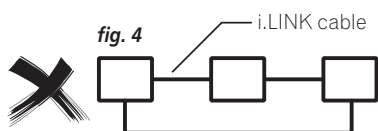
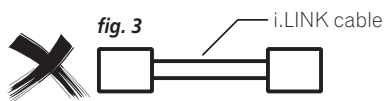

Another consideration when connecting i.LINK devices is the speed of the interface. At present there are three speeds; S100 (slowest), S200 and S400 (fastest). This receiver uses the S400 type. Although you can use components with different speeds together, we recommend connecting slower-speed components at the edge of the network if possible (shown by the shaded boxes in figs. 1 and 2). This will keep the network free of bottlenecks.

When used within an i.LINK network, this receiver must be on for the i.LINK connection to be maintained. Other components in the network may or may not maintain the connection in standby (none will when the power is completely off)—check the operating instructions supplied with individual components. Note that the audio may be momentarily interrupted if a component in the i.LINK network is switched on/off, or its i.LINK connection is switched on/off.

This product complies with the following i.LINK interface specifications:

1) IEEE Std. 1394a-2000, Standard for a High Performance Serial Bus

2) Audio and Music Data Transmission Protocol 2.0

Following the standard for AM824 sequence adaptation layers, the product is compatible with IEC60958 bitstream, DVD-A and SACD.

Using the USB interface

It is possible to listen to multichannel audio sources from your computer by connecting to the USB interface on the rear of this receiver. Depending on your model of computer and the software installed, you can listen to any source compatible with your operating system through the speaker setup you've connected to this receiver.

1 Connect your computer's USB terminal to the USB terminal on the rear panel of this receiver.

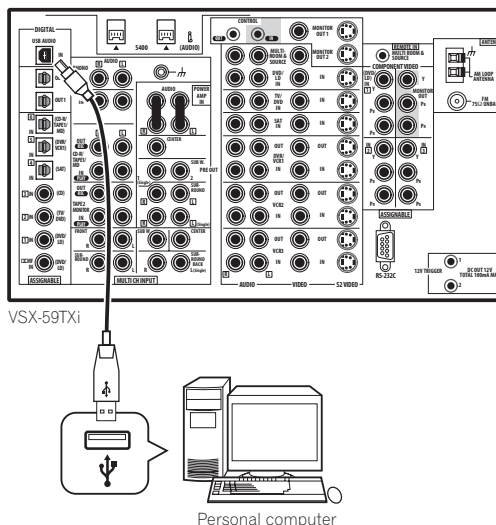

2 Switch on your computer and this receiver.

3 If you're connecting for the first time, wait for the USB driver installation to finish.

The installation may take a minute or two to complete. Make sure you leave the USB cable connected until the dialog box indicates that the USB setup is finished. Note that some older operating systems may require a disc for installation.

4 Press 'USB' on the remote control Home menu (🏠) screen.

You can also use the **INPUT SELECTOR** dial on the front panel to select **USB**.

5 Make any necessary settings required to select the USB interface as your computer audio output.

You will need to access your speaker settings from the **Control Panel** of your operating system:

- **Windows® XP** – Select **Sound, Speech, and Audio Devices**, and then select **Change the speaker settings**. Select **Audio**, then **PIONEER AV Receiver/Amplifier** from the drop down menu.

- **Windows® 98SE** – Select **Multimedia**, and then select **Audio**. Choose **PIONEER AV Receiver/Amplifier** from the drop down menu.
- **Windows® Me/Windows® 2000** – Select **Sound and Multimedia** and then select **Audio**. Choose **PIONEER AV Receiver/Amplifier** from the drop down menu.

You will also need to make sure the correct speaker setting is selected with the audio software you're using. Please refer to the manual that came with the software to make these settings.

6 Turn up the volume control on your computer and this receiver.

You may want to start with a fairly low volume on this receiver and turn it up as necessary after you've checked your levels.

7 Start playback of a source on your computer.

8 If necessary, press SIGNAL SELECT to choose the number of channels you'll hear.

See *Selecting USB and multichannel analog input channels* on page 49 for more on this.



Note

- Windows® XP, Windows® 2000, Windows® Millennium Edition and Windows® 98 Second Edition operating systems have been tested for compatibility with this interface, but depending on your computer setup, you may find that your system is not compatible.
- This USB interface supports up to 8 channels of audio.
- Make sure you use a USB cable that connects from an A-type connector (from your PC) to a 4-pin B-type connector (to the receiver).
- The USB specification is version 1.1 compatible, and the USB Audio Class specification is 1.0 compatible.
- You won't be able to control this receiver using your computer (and vice-versa).
- Sampling formats up to 48kHz can be heard using the USB connection (formats above 48kHz sampling must be downsampled).
- Any computer alert sounds will also be heard through the speakers unless you switch them off from the computer's control panel.
- You won't be able to hear the audio from the USB connection through the digital outputs of this receiver.
- Even when the receiver is switched off, it will remain selected in your speaker settings.
- Note that using hubs or extensions may cause connection problems.



Caution

- Make sure you don't switch off the computer or unplug the USB cable during playback.
- To prevent noise being output, don't use other software on your computer during playback.
- Pioneer is not responsible for computer system damage, software crashes or failures, or any other possible computer problems due to this configuration.

Microsoft Windows® XP, Windows® 2000, Windows® Millennium Edition and Windows® 98 Second Edition are registered trademarks of Microsoft Corporation, Inc.

Connecting a PC for Advanced MCACC output

If you used the *Professional Acoustic Calibration EQ* on page 63 to measure the reverb characteristics of your listening room, you'll be able to connect a computer using the RS-232C jack on the back panel to check the results graphically. Use a commercially-available RS-232C cable to connect the RS-232C jack on your computer to the 9-pin RS-232C jack on this receiver (the cable must be cross type, female–female).

To obtain the software to output the results, please register this unit online as instructed on the front cover of the manual. After registering, you will be able to access the download area from the Pioneer website, where both the software and instruction manual will be available. If you have any questions regarding, please contact the Customer Support Division of Pioneer.

Please make sure your system meets the following requirements:

- Operating system must be Windows® XP, Windows® 2000, Windows® Millennium Edition, Windows® 98 Second Edition, or Windows® NT 4.0 (Service pack 6).
- CPU must be at least Pentium 3 / 300MHz or AMD K6 / 300MHz (or equivalent) with at least 128MB of memory, and your monitor must be able to display a minimum resolution of 800x600.
- An RS-232C port connector is necessary for graphical output. Refer to the operating instructions and/or the PC manufacturer for more information on making the proper port settings.
- System must have internet access.

Before doing these steps, make sure you complete steps 1–6 in *Using Professional Acoustic Calibration EQ* on page 64.

1 Select 'PC Output' and press ENTER.

When the receiver is ready for transmission, **Operate a PC** shows on the OSD.

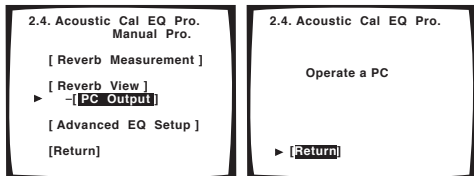

- If **PC Output** isn't displayed, the receiver probably doesn't have any transmission data. Make sure you have completed steps 1–6 in *Using Professional Acoustic Calibration EQ* on page 64.

2 Connect your computer to the RS-232C jack on the rear panel of the receiver.

Use a commercially-available cable to connect the RS-232C jack on your computer to the 9-pin RS-232C jack on this receiver. See the documentation provided with the Advanced MCACC application for more information.

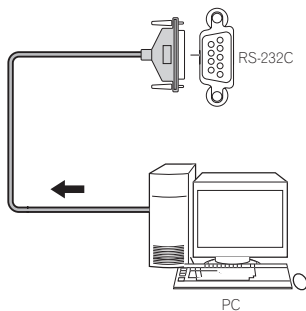

3 Start the MCACC application on your computer.

Follow the instructions provided with the application. It will take about ten seconds for the transmission to complete, then you will be able to analyze the output on your computer. Since the data will be cleared from the receiver when you restart reverb measurement or turn off the receiver, you might want to save the information on your PC after measurement.

4 When you're finished, select 'Return' on the on-screen display.

You'll be taken to the Advanced EQ Setup. Depending on the results, you may want to continue with the Advanced EQ setup (see *Setting Professional Acoustic Calibration EQ according to your room characteristics* on page 63 for more on this). You can also simply press **Return** again to exit the Professional Acoustic Calibration EQ setup.

Chapter 11

Advanced setup

The Input Assign menu

You only need to make settings in the Input Assign menu if you didn't hook up your digital equipment according to the default settings for the digital inputs, or if you have connected equipment using component video or i.LINK cables.

To access the Input Assign menu, follow the steps below.

- 1 Make sure your receiver and TV are both switched on.
- 2 Using the remote control, press RECEIVER on the touch screen, then press the SYSTEM SETUP button.



An on-screen display (OSD) appears on your TV. Use the **↑/↓/←/→** hard keys and **ENTER** on the remote control to navigate through the screens and select menu items.

- The **↑/↓** (cursor up/down) hard keys select menu items and the **←/→** (cursor left/right) hard keys change the setting of the item selected.

3 Select 'Input Assign' then press ENTER.

The Input Assign menu appears on screen:

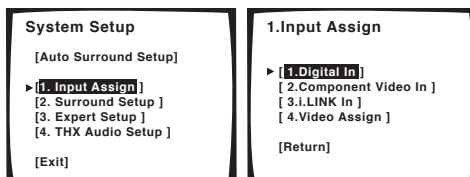

Assigning the digital inputs

- Default settings:
 - Digital-1** (coaxial) – DVD/LD
 - Digital-2** (coaxial) – TV/DVD
 - Digital-3** (coaxial) – CD
 - Digital-4** (optical) – SAT
 - Digital-5** (optical) – DVR (/VCR1)
 - Digital-6** (optical) – CD-R (/TAPE1/MD)
 - RF** (coaxial) – DVD/LD

You only need to do this if you didn't hook up your digital equipment according to the default settings for the digital inputs (see above). This setting tells the receiver what digital equipment is hooked up to which terminal so the buttons on the remote correspond to what you have hooked up.

1 Select 'Digital In' from the Input Assign menu and press ENTER.

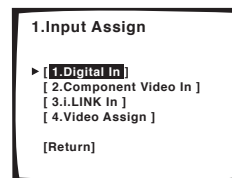

2 Select the number of the digital input to which you've connected your digital component.

The numbers correspond with the numbers beside the inputs on the back of the receiver.

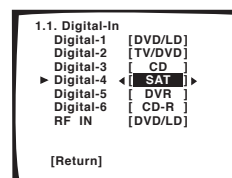

3 Use the ←/→ (cursor left/right) hard keys to select the component that corresponds with the one you connected to that input.

Select between **DVD/LD**, **TV/DVD**, **SAT**, **DVR/VCR 1**, **VCR 2**, **VCR 3** or **CD-R** (however, the **RF IN** setting doesn't include **CD-R**).

- If you assign a digital input to a certain function (for example, **DVD/LD**) then any digital inputs previously assigned to that function will automatically be switched off.

4 When you're finished, select RETURN and press ENTER.

You will return to the Input Assign menu.

Assigning the component video inputs

- Default settings:
Component 1 – DVD/LD
Component 2 – OFF
Component 3 – OFF

If you used component video cords to connect your video equipment you must tell the receiver which device it is, or else you may see the S-video or composite video input instead of the component video signal.

1 Select 'Component Video In' from the Input Assign menu and press ENTER.

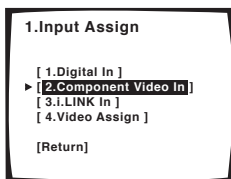

2 Select the number of the component video input to which you've connected your video player.

The numbers correspond with the numbers beside the inputs on the back of the receiver.

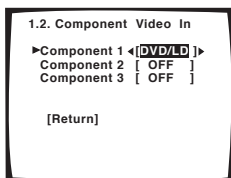

3 Use the ←/→ (cursor left/right) hard keys to select the component that corresponds with the one you connected to that input.

- If you connect the TV monitor with component video cord, and the DVD player with composite or S video cord then you should set that terminal to **OFF**.

4 When you're finished, select RETURN and press ENTER.

You will return to the Input Assign menu.

Assigning the i.LINK inputs

If you assign i.LINK-equipped components to an input (for example **DVD/LD**), you will be able to select both audio and video signals from i.LINK-equipped components using the **INPUT** button (or **INPUT SELECTOR** dial on the front panel). Assigning i.LINK sources also allows you to keep the sound settings you've made for other input functions.

1 Select 'i.LINK Input' from the Input Assign menu and press ENTER.

If no i.LINK-equipped components are connected **i.LINK Input** cannot be selected.

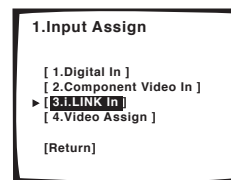

2 Select an i.LINK-equipped component.

When a number of i.LINK-equipped components are connected to your receiver, the i.LINK-equipped component you are looking for might be listed on additional display screens.

- **i.LINK** is displayed after unassigned device names (e.g. **DV-59AVi [i.LINK]**).
- If a connected device cannot output (playback) a source using the i.LINK connection, **[- - -]** is displayed after the input device name (e.g. **DV-59AVi [- - -]**). Non-compatible devices cannot be assigned to inputs.
- When the cables for an assigned input device become loose or the power is cut to the device, an asterisk (*) appears before the device name (e.g. ***DV-59AVi [CD]**).

3 Use the ←/→ (cursor left/right) hard keys to select the component that you want to assign.

When you assign an i.LINK-equipped video component, select the input source to which you have connected the video signal from the component.

- If you assign an i.LINK input to a certain function (for example **DVD/LD**) then any digital inputs previously assigned to that function will automatically be set to **i.LINK** (not assigned).
- **TUNER** and **PHONO** inputs cannot be assigned.

4 When you're finished, select RETURN and press ENTER.

You will return to the Input Assign menu.

Assigning the video inputs

- Default settings:

MULTI IN – OFF

USB – OFF

You can choose to watch a video source at the same time as you listen to the audio source from the multichannel analog inputs or USB connector. To do this, you must let the receiver know which video component you want to watch. After making the settings below, the corresponding video input is selected at the same time that you choose either **MULTI IN** or **USB** as the input source.

- 1 Select 'Video Assign' from the Input Assign menu and press ENTER.

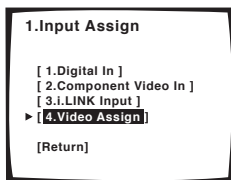

- 2 Select which input to which you want to assign a video source.

Choose either **MULTI IN** or **USB**.

- 3 Use the ←/→ (cursor left/right) hard keys to select the video source you want to assign.

Any video source available on the receiver can be assigned, and you can also assign the same video source to both inputs.

- 4 When you're finished, select RETURN and press ENTER.

You will return to the Input Assign menu.

The Expert Setup menu

The settings in the Expert Setup menu are more advanced features of this receiver that you can use to make detailed adjustments when you're more familiar with the system.

You only need to make these settings once (unless you change the placement of your current speaker system or add new speakers.).

- 1 Make sure your receiver and TV are both switched on.

- 2 Using the remote control, press RECEIVER on the touch screen, then press the SYSTEM SETUP button.

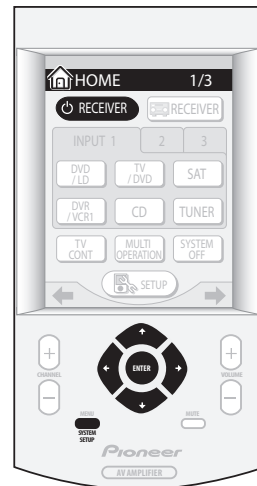

An on-screen display (OSD) appears on your TV. Use the ↑/↓/←/→ hard keys and **ENTER** on the remote control to navigate through the screens and select menu items.

- The ↑/↓ (cursor up/down) hard keys select menu items and the ←/→ (cursor left/right) hard keys change the setting of the item selected.

- 3 Select 'Expert Setup' then press ENTER.

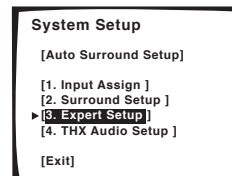

4 Select the setting you want to adjust.

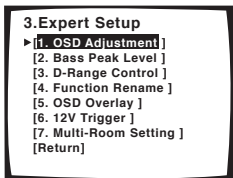

- **OSD Adjustment** – Adjust the position of the on-screen display on your TV.
- **Bass Peak Level** – Prevent bass tones from distorting the sound from your speakers.
- **D-Range Control** – Specify the amount of dynamic range adjustment to Dolby Digital soundtracks.
- **Function Rename** – Change the names that appear on the receiver display and on-screen display.
- **OSD Overlay** – Switch the on-screen display (for basic functions) on or off.
- **12V Trigger** – Specify which components are switched on or off using the 12 volt trigger.
- **Multi-Room Setting** – Specify your volume setting and IR receiver type for a multi-room setup.

5 Make the adjustments necessary for each setting, pressing ENTER to confirm after each screen. When you're finished, you can select Return, then press ENTER to go back to the System Setup menu.

OSD Adjustment

Use this feature to adjust your TV display if it seems difficult to see all the instructions on the screen.

1 Select 'OSD Adjustment' from the Expert Setup menu.

2 Use the ↑/↓/←/→ hard keys to move the display field around until you get one that you feel best suits your TV.

You can move the screen displays up or down and left or right to get the best match for your TV.

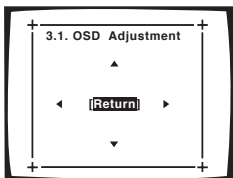

3 Press ENTER.

You will return to the Expert Setup menu.

Bass Peak Level

Some audio sources (for example, Dolby Digital and DTS) include ultra-low bass tones. Set the bass attenuator as needed to prevent the ultra-low bass from distorting the sound.

1 Select 'Bass Peak Level' from the Expert Setup menu.

The current setting is displayed.

- When [- - -] is displayed, no bass is output.
- When [OFF] is displayed the attenuator is off (bass output is not affected).

2 Select a setup option.

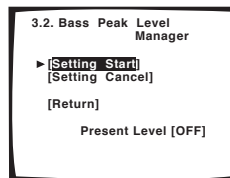

- **Setting Start** – The volume is set to MIN (---dB), a test tone plays back and you make the setting.
- **Setting Cancel** – Switches the attenuator off.

3 If you selected 'Setting Start', use the ←/→ (cursor left/right) hard keys to adjust the test tones and specify the bass peak level then press ENTER.

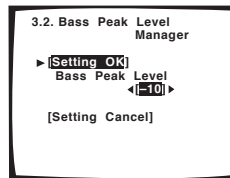

Set the bass peak level gradually, then press ENTER at the point just before the tone starts to distort. When you're finished, the display on the receiver will show RESUME and the volume will return to its original position.

- The test tones are output at loud volumes.
- If the YES or PLUS setting on the subwoofer is selected (in Speaker Systems on page 58), the test tone will only play back from the subwoofer. If not, the test tone will play back from all speakers set to LARGE (except for the subwoofer).

4 When you're finished, select RETURN and press ENTER.

You will return to the Expert Setup menu.

Note

- Since the THX Ultra2 feature has a bass limiter to control bass peaks, the bass attenuator is automatically switched off if you set up your system using the *THX Ultra2 Subwoofer Setup* on page 96.

Dynamic Range Control

- Default setting: **OFF**

This setting specifies the amount of dynamic range adjustment to movie soundtracks. You may want to use this when listening to surround sound at low volumes.

1 Select 'D-Range Control' from the Expert Setup menu.

2 Choose the setting that you want.

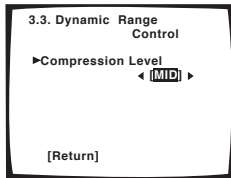

- OFF** – No dynamic range adjustment (use when listening at higher volume).
- MID** – Mid setting.
- MAX** – Dynamic range is reduced (loud sounds are reduced in volume while quieter sounds are increased)

3 When you're finished, select RETURN and press ENTER.

You will return to the Expert Setup menu.

Function Rename

You can customize the names that appears on the display when you select an input source (for example, you could change the name of **VCR1/DVR** to **DVR-310**).

1 Select 'Function Rename' from the Expert Setup menu.

2 Select the name of the input you want to rename and press ENTER.

The functions are divided into three different on-screen displays so you may have to move through them to find the function you want to rename.

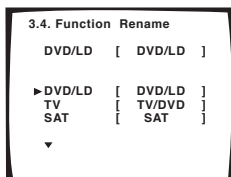

3 Edit the name as necessary and press ENTER.

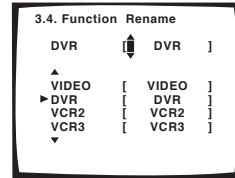

Use the **↑/↓** (cursor up/down) hard keys to change the character and the **←/→** (cursor left/right) hard keys to move forward/back a position. The name can be up to ten characters (the possible characters are listed below).

ABCDEFGHIJKLMNOPQRSTUVWXYZ

abcdefghijklmnopqrstuvwxyz

0123456789

!"#\$%&'()*+,-./:;<=>?@[\]

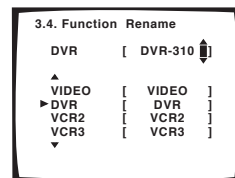

4 Select another name to edit, or select 'Return' from the bottom of the list if you're done. Press ENTER.

If you've selected another name, repeat step 3, otherwise you'll return to the Expert Setup menu.

OSD Overlay

- Default setting: **ON**

You can choose whether or not you want to see basic functions (such as selecting input sources) using the on-screen display. Only the System Setup menu and Status screen (*Checking your system settings* on page 78) appear on the OSD.

1 Select 'OSD Overlay' from the Expert Setup menu.

2 Choose the setting that you want.

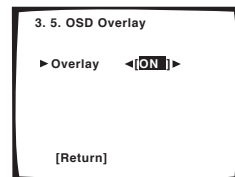

- OFF** – The on-screen display is switched off except for the System Step menu and Status screens.
- ON** – The on-screen display is switched on for basic functions.

3 When you're finished, select RETURN and press ENTER.

You will return to the Expert Setup menu.

12 Volt Trigger

- Default setting: **OFF · OFF** (all components)

After connecting a component to one of the 12 volt triggers (see *Switching components on and off using the 12 volt trigger* on page 74), it switches on automatically when you select an input function set to switch the trigger on. Specify which input functions switch on which trigger(s) below.

1 Select '12 Volt Trigger' from the Expert Setup menu.

2 Select an input function and choose the setting that you want.

This should be the input function, that when selected, switches on one (or both) of the 12 volt triggers.

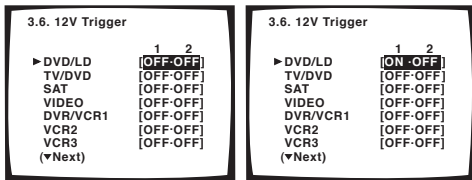

- **OFF · OFF** – 12 volt triggers 1 and 2 are switched off.
- **OFF · ON** – 12 volt trigger 1 is switched off; 12 volt trigger 2 is switched on.
- **ON · OFF** – 12 volt trigger 1 is switched on; 12 volt trigger 2 is switched off.
- **ON · ON** – 12 volt triggers 1 and 2 are switched on.

3 Repeat for as many input functions as you would like to set.

4 When you're finished, select RETURN and press ENTER.

You will return to the Expert Setup menu.

Multi-Room Setting

- Default setting: **VARIABLE / PIONEER**

If you've made multi-room connections (see *Multi-room setup* on page 83) you may need to specify your volume setting and IR receiver type.

1 Select 'Multi-Room Setting' then press ENTER.

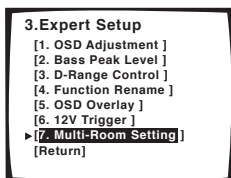

2 Select the volume level setting.

- **VARIABLE** – Use this setting if you've connected a power amplifier in the sub room (this receiver is simply being used as a pre-amp) and you will be using this receiver's controls to adjust the volume.
- **FIXED** – Use this setting if you've connected a fully integrated amplifier (such as another Pioneer VSX receiver) in the sub room and want to use that receiver's volume controls.

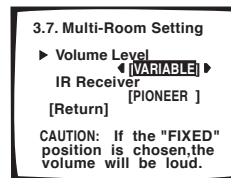

With the **FIXED** setting, the source is sent from this receiver at maximum volume, so make sure the volume is quite low in the sub room at first and then experiment to find the correct level.

3 Select the type of IR receiver you're using.

- **PIONEER** – Use this setting if you're using a Pioneer MR-100 (or if the IR receiver you're using doesn't seem to work after selecting others).
- **OTHERS** – Use this setting for all other IR receivers.

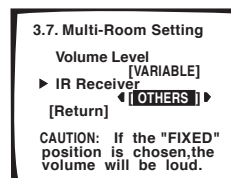

4 Select 'Return' then press ENTER to finish.

You will return to the Expert Setup menu.

Note

- Some IR receivers may not work with this receiver. Check with your audio dealer for more information.

THX Audio Setup

The settings in the THX Audio Setup menu allow you to get optimum sound from the Home THX modes (on page 45) if you're using a subwoofer and surround back speakers with your home theater system. See *THX speaker system setup* on page 98 for more on this.

To access the THX Audio Setup menu, follow the steps below.

- 1 Make sure your receiver and TV are both switched on.
- 2 Using the remote control, press RECEIVER on the touch screen, then press the SYSTEM SETUP button.

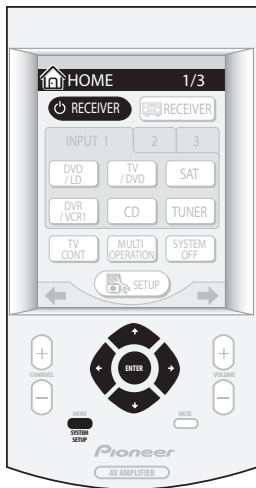

An on-screen display (OSD) appears on your TV. Use the **↑/↓/←/→** hard keys and **ENTER** on the remote control to navigate through the screens and select menu items.

- The **↑/↓** (cursor up/down) hard keys select menu items and the **←/→** (cursor left/right) hard keys change the setting of the item selected.

- 3 Select 'THX Audio Setup' then press ENTER.

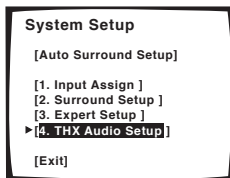

THX Ultra2 Subwoofer Setup

With some speaker setups, depending on the position of the subwoofer and the walls in your listening area, you may experience overly resonant frequencies in the bass. If you have this problem use the THX Ultra2 subwoofer setup to switch on boundary gain compensation (see *About THX®* on page 109 for more on this).

- 1 Select 'Ultra2 SW Setup' from the THX Audio Setup menu.
- 2 Specify whether your subwoofer is THX Ultra2 certified or not.
If your subwoofer isn't THX Ultra2 certified, but you still want to switch boundary gain compensation on, select **YES** here, but the effect might not work properly.
- 3 Select either **ON** or **OFF** for the Boundary Gain Compensation setting.
- 4 When you're finished, select **RETURN** and press **ENTER**.

You will return to the THX Audio Setup menu.

Surround Back Speaker Position

For the most effective results when using the THX Ultra2 Cinema and THX MusicMode listening modes (see *Using the Home THX modes* on page 45) with the Advanced Speaker Array (ASA) system (see *About THX®* on page 109), it is required that you make the setting below.

Note

- If you don't have surround back speakers, or just have one, you won't be able to select this setting.

- 1 Select 'SB SP Position' from the THX Audio Setup menu.

- 2 Specify the distance of your surround back speakers from each other.

- **0–1 ft** – Surround speakers within 1 foot apart (best for THX surround sound).
- **<1–4 ft** – Surround speakers between 1 and 4 feet apart.
- **4 ft<** – Surround speakers more than 4 feet apart.

- 3 When you're finished, select **RETURN** and press **ENTER**.

You will return to the THX Audio Setup menu.

Chapter 12 Additional information

Optimizing your speaker setup

In addition to the speaker placement tips outlined in *Placing the speakers* on page 27, you can use the diagrams and explanations provided below as a reference for optimum placement of each set of speakers.

Basic surround setup

If you're using a center speaker, place the front speakers at a wider angle. If not, place them at a narrower angle.

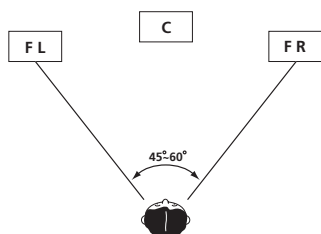

Make sure the center speaker does not cross the line formed by the leading edge of the front left and right speakers.

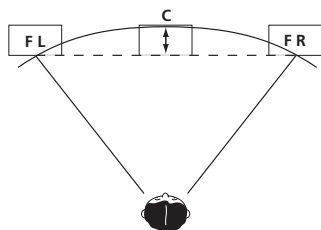

It is best to angle the speakers towards the listening position. The angle depends on the size of the room. Use less of an angle for bigger rooms.

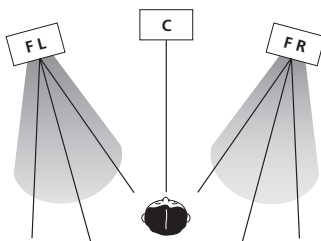

Surround and surround back speakers should be positioned a foot-and-a-half to three feet (60 cm–90 cm) higher than your ears and tilted slight downward. Make sure the speakers don't face each other. For DVD-Audio, the speakers should be more directly behind the listener than for home theater playback.

No surround back speakers

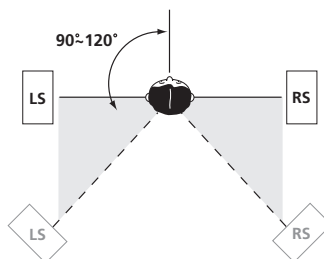

One surround back speaker

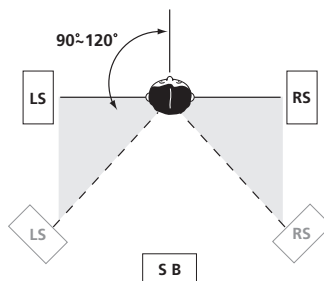

Two surround back speakers

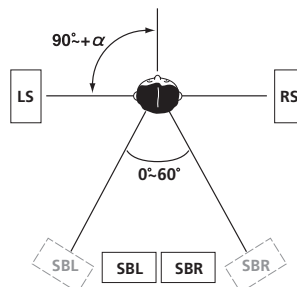

THX speaker system setup

If you have a complete THX speaker system, follow the diagram below to place your speakers. Note that the surround speakers (⊞ indicates bi-polar radiating speakers) should output at an angle parallel to the listener.

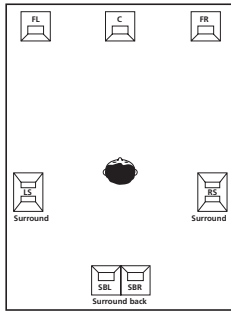

If you have two surround back speakers THX recommends placing them together and the same distance from your listening position so you can take advantage of the ASA feature. For more details see *Advanced Speaker Array™ (ASA)* on page 110.

See also *THX Audio Setup* on page 96 to make the settings that will give you the best sound experience when using the Home THX modes (on page 45).

Speaker system setup for DVD-Audio/ multichannel music sources

The best speaker placement for DVD-Audio (and other multichannel music sources) may be different than for regular DVD discs. For these formats, some sound studios use the setup shown in the diagram below (as recommended by ITU-R) instead of the setups in *Basic surround setup* on page 97.

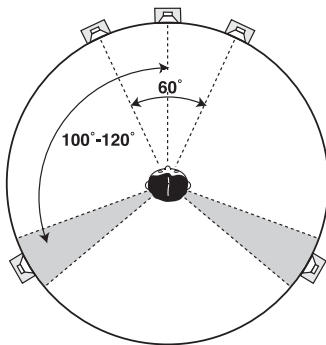

Note

- If you connect an alternate set of surround speakers, you can use speaker system B to provide additional surround sound options when listening to multichannel music sources. See *Alternating surround speaker setups using speaker system B (ITU-R)* on page 80 for how to set it up.
- If you're using two surround back speakers, you can select the **STANDARD SX** listening mode during DVD-Audio playback to simulate the sound achieved from the setup shown in the diagram above. The sound from the surround and surround back speakers are combined to create a virtual surround speaker.

Troubleshooting

Incorrect operations are often mistaken for trouble and malfunctions. If you think that there is something wrong with this component, check the points below. Sometimes the trouble may lie in another component. Investigate the other components and electrical appliances being used. If the trouble cannot be rectified even after exercising the checks listed below, ask your nearest Pioneer authorized service center or your dealer to carry out repair work.

Power

Symptom	Cause	Remedy
The power does not turn on.	<ul style="list-style-type: none"> The power plug is disconnected. The protection circuit may have been activated. Something is obstructing the rear panel fan. 	<ul style="list-style-type: none"> Connect the power plug to the wall outlet. Disconnect the power plug from the outlet, and insert again. Unplug the receiver from the wall and call a Pioneer-authorized independent service company.
The receiver suddenly switches off.	<ul style="list-style-type: none"> The speaker wires are frayed or sticking out of the jack, and are touching the back of the receiver or another set of wires. The receiver has a serious problem. 	<ul style="list-style-type: none"> Reinsert the speaker wires, making sure there are no stray strands of wire and that they are inserted fully. Unplug the receiver from the wall and call a Pioneer-authorized independent service company.
During loud playback the power suddenly switches off.	<ul style="list-style-type: none"> The protection circuit has been activated because the lowest actual impedance of the speakers (as opposed to the speakers rated impedance) is dangerously low. 	<ul style="list-style-type: none"> Turn down the volume. When its convenient, go to <i>Acoustic Calibration EQ</i> on page 61 and lower the 63 Hz and 125 Hz equalizer levels using the manual setting. Turning the digital safety feature on may allow you to turn up the volume a little more. To switch between SAFETY 1 (medium effect), SAFETY 2 (more effect) and SAFETY OFF, put the receiver into standby, then press the ⊖ STANDBY/ON button while holding down the OPTION button on the front panel. If the power switches off even with SAFETY 2 switched on, turn down the volume.
AMP ERR blinks in the display, then the power automatically switches off.	<ul style="list-style-type: none"> The receiver has a serious problem. 	<ul style="list-style-type: none"> After about a minute (you won't be able to switch the unit on during this time), switch the receiver back on. If the message persists, call a Pioneer-authorized independent service company.
FAN STOP blinks in the display, then the power automatically switches off.	<ul style="list-style-type: none"> Something is obstructing the rear panel fan. The fan is malfunctioning. 	<ul style="list-style-type: none"> Remove the obstruction and try switching the receiver back on. If the fan is still not working, or you can't remove the object, unplug the receiver from the wall and call a Pioneer-authorized independent service company. Unplug the receiver from the wall and call a Pioneer-authorized independent service company.
OVERHEAT blinks in the display and no sound is output.	<ul style="list-style-type: none"> The internal temperature of the unit has become too high. 	<ul style="list-style-type: none"> After allowing the unit to cool down in a well-ventilated place, try switching the receiver back on. Make sure you follow the guidelines for improving heat dispersal in <i>Ventilation</i> on page 8.

No sound

Symptom	Cause	Remedy
No sound is output when an input source is selected.	• Improper connections.	• Make sure you have properly connected the component to the corresponding input on the back of the receiver (see <i>Connecting your equipment</i> on page 14).
	• Sound is muted or the volume is turned down.	• Press MUTE or adjust the volume accordingly.
	• The TAPE 2 monitoring feature is on.	• Press TAPE 2 MONITOR to switch it off (see <i>Monitoring your recording</i> on page 75).
	• Speakers are turned off or selected improperly with the SP SYSTEM A/B switch.	• Press SP SYSTEM A/B to select the proper speaker set (see <i>Switching the speaker system</i> on page 80).
	• The input signal type is incorrect.	• Press SIGNAL SELECT to select the proper input signal (see <i>Selecting the input signal type</i> on page 48).
No sound output from the front speakers.	• The i.LINK source selected for the main room has also been selected as a source in the sub room.	• Choose a different source or choose a different input signal for the main room, such as DIGITAL or ANALOG (see <i>Selecting the input signal type</i> on page 48).
	• The U-shaped connectors that connect the POWER AMP IN terminals to the front channel pre outs are not connected.	• Reconnect the POWER AMP IN terminals to the front channel pre-outs using the supplied U-shaped connectors (see item 8 in <i>Rear panel</i> on page 14).
No sound from the surround or center speakers.	• The front speakers are connected to the B speaker system jack.	• Connect the front speakers to the A speaker system jacks (see <i>Installing your speaker system</i> on page 26).
	• Speaker settings are incorrect. (for example, they have been set to NO).	• Check you speaker settings in <i>Speaker Systems</i> on page 58.
	• The surround and/or center levels are turned down.	• Check the levels in <i>Channel Level</i> on page 60.
	• The surround and/or center speakers are disconnected.	• Check <i>Installing your speaker system</i> on page 26 to make sure the speakers are connected correctly.
	• The STEREO listening mode has been selected.	• Choose a surround listening mode (see <i>Listening in surround sound</i> on page 43).
	• Speaker system B is selected.	• Select speaker system A (see <i>Switching the speaker system</i> on page 80).
	• The 2 channel input setting is selected when using the multichannel analog inputs or the USB interface.	• Change the setting accordingly (see <i>Selecting USB and multichannel analog input channels</i> on page 49).
No sound from surround back speakers.	• Surround back speakers are set to NO .	• Set the surround back speakers to LARGE or SMALL (see <i>Speaker Systems</i> on page 58).
	• The SB CH mode is switched off.	• Set the surround back channel to SB CH ON (see page 50).
	• The source is not a 6.1 channel playback source.	• Choose an Advanced surround listening mode (see <i>Listening in surround sound</i> on page 43).
	• The surround back speakers are disconnected.	• Check <i>Installing your speaker system</i> on page 26 to make sure the speakers are connected correctly.
	• The surround back channel is on the 1 speaker setting, and your speaker is connected to the right channel output.	• Connect the speaker to the surround back left channel output (<i>Installing your speaker system</i> on page 26).
	• The wrong input setting is selected when using the multichannel analog inputs or the USB interface.	• Change the setting accordingly (see <i>Selecting USB and multichannel analog input channels</i> on page 49).
	• The SB CH MODE is switched to AUTO and the Dolby Surround EX / DTS ES software you're playing has no flag to indicate it is 6.1 compatible.	• You can still listen with surround back sound by setting the surround back channel to SB CH ON (page 50).

Symptom	Cause	Remedy
No sound from subwoofer.	<ul style="list-style-type: none"> The subwoofer is disconnected or switched off. The subwoofer's settings are incorrect. 	<ul style="list-style-type: none"> Connect or switch on the subwoofer (see <i>Installing your speaker system</i> on page 26). Set the subwoofer (see <i>Speaker Systems</i> on page 58). Set the front speakers to SMALL (see <i>Speaker Systems</i> on page 58).
	<ul style="list-style-type: none"> The crossover frequency is set too low. The bass attenuator is set too low. The subwoofer's levels are too low. 	<ul style="list-style-type: none"> Set the crossover frequency to a (higher) frequency that matches your speaker characteristics (see <i>Speaker Systems</i> on page 58) See <i>Bass Peak Level</i> on page 93 to adjust the setting. See <i>Channel Level</i> on page 60 to check the speaker levels. Check the volume control on the subwoofer to make sure it is turned up.
No sound from one speaker.	<ul style="list-style-type: none"> The speaker setting has been set to NO. The speaker level is too low. The speaker isn't connected properly. 	<ul style="list-style-type: none"> Change the setting in <i>Speaker Systems</i> on page 58. Check the level in <i>Channel Level</i> on page 60. Check <i>Installing your speaker system</i> on page 26 to make sure the speaker is connected correctly.
	<ul style="list-style-type: none"> The source has no sound output for that channel. 	<ul style="list-style-type: none"> By choosing an Advanced surround listening mode (see <i>Listening in surround sound</i> on page 43), you may be able to create an extra channel for the speaker.
The program indicator lights for a channel, but no sound is output from the corresponding speaker.	<ul style="list-style-type: none"> A mute signal is recorded on the channel. 	
Sound is produced from analog components, but not from digital ones (DVD, LD, CD-ROM etc.).	<ul style="list-style-type: none"> The digital input assignment is wrong. The digital components aren't connected properly. The player is not compatible with the source you're using, or the player settings are incorrect. The digital output level has been turned down on a CD player or other component equipped with digital output level adjustment capability. Analog input has been selected. 	<ul style="list-style-type: none"> Assign the digital inputs correctly (see <i>Assigning the digital inputs</i> on page 90). Make sure you have properly connected the digital component to the corresponding input on the back of the receiver (see <i>Connecting your equipment</i> on page 14). Choose a compatible source, or check the component's manual for the correct settings. Set the digital volume level of the player to full, or to the neutral position. Select digital input (see <i>Selecting the input signal type</i> on page 48).
When playing an LD the input signal type is DORF but there is still no sound.	<ul style="list-style-type: none"> The LD is not a Dolby Digital compatible disc. 	<ul style="list-style-type: none"> Set the input signal to AUTO (see <i>Selecting the input signal type</i> on page 48). Also make sure your LD player is hooked up with analog connections in addition to digital and DORF connections (see <i>Connecting other video sources</i> on page 21).
No sound output from the headphones.	<ul style="list-style-type: none"> The U-shaped connectors that connect the POWER AMP IN terminals to the front channel pre-outs are not connected. 	<ul style="list-style-type: none"> Reconnect the POWER AMP IN terminals to the front channel pre-outs using the supplied U-shaped connectors (see item 8 in <i>Rear panel</i> on page 14).
No sound is output or a noise is output when Dolby Digital/DTS software is played back.	<ul style="list-style-type: none"> A DVD player not compatible with Dolby Digital/DTS is being used. The settings on the DVD player are incorrect and/or the DTS signal output is turned off. The digital output level is turned down on a CD player or other component equipped with digital output level adjustment capability. (The DTS signal has been altered by the player, and cannot be read.) 	<ul style="list-style-type: none"> Make sure your DVD player is compatible with Dolby Digital/DTS. Make sure the player's settings are correct and/or the DTS signal out is on. Refer to the instruction manual supplied with the DVD player. Set the digital volume level of the player to full, or to the neutral position.
No sound is output when the AM/FM is selected.	<ul style="list-style-type: none"> Incorrect frequency. The antenna is not connected. 	<ul style="list-style-type: none"> Tune into the correct frequency. Connect the antenna (see <i>Connecting antennas</i> on page 28).

Symptom	Cause	Remedy
No digital output from the DVD player when playing a multichannel DVD-Audio or SACD disc.	<ul style="list-style-type: none"> DVD players do not output digital audio when playing these kinds of discs. 	<ul style="list-style-type: none"> To enjoy fully multichannel DVD-Audio and SACD discs, connect your DVD player to this receiver through the multichannel analog inputs. See <i>Connecting the multichannel analog outputs</i> on page 18 and also the operating instructions that came with your DVD player.
No digital output when playing a 192/176.4 kHz sampling rate DVD-Audio disc.	<ul style="list-style-type: none"> DVD players do not output digital audio at these sampling rates. Usually, players output the audio from these discs at a downsampled rate of 96/88.2 kHz or 48/44.1 kHz. Some discs prohibit all digital output. 	<ul style="list-style-type: none"> This is not a malfunction. To enjoy fully these discs, connect your DVD player to this receiver through the multichannel analog inputs. See <i>Connecting the multichannel analog outputs</i> on page 18 and also the operating instructions that came with your DVD player.
During playback of a Dolby Surround EX / DTS ES soundtrack, the LS , S and RS indicators light but there is no surround back channel sound.	<ul style="list-style-type: none"> The listening mode is not set correctly. 	<ul style="list-style-type: none"> Set the surround back channel to SB CH AUTO (see <i>Using the surround back channel</i> on page 50).

Other audio problems

Symptom	Cause	Remedy
Broadcast stations cannot be selected automatically, or there seems to be considerable noise in radio broadcasts.	FM broadcasts	
	<ul style="list-style-type: none"> The FM antenna is not fully extended or is poorly positioned. Weak radio signals. 	<ul style="list-style-type: none"> Fully extend the FM wire antenna, position for best reception, and secure to a wall. Connect an outdoor FM antenna (see page 28).
	AM broadcasts	
	<ul style="list-style-type: none"> The AM antenna is poorly positioned. Weak radio signals. Interference caused by other equipment (fluorescent lamp, motor, etc.). 	<ul style="list-style-type: none"> Adjust the direction and position for best reception. Connect an additional internal or external AM antenna (see page 28). Turn off the equipment causing the noise or move it away from the receiver. Place the antenna farther away from the equipment causing the noise.
Noise is output when scanning a DTS CD.	<ul style="list-style-type: none"> The scan function performed by the player slightly alters the digital information, making it unreadable. 	<ul style="list-style-type: none"> This is not a malfunction, but be sure to turn the volume down to prevent the output of loud noise from your speakers.
When playing a 96 kHz/24bit disc the sound is too loud.	<ul style="list-style-type: none"> Different discs have different recording levels so some may be louder than others. 	<ul style="list-style-type: none"> Turn the volume down.
When playing a DTS format LD there is audible noise on the soundtrack.	<ul style="list-style-type: none"> The input signal type is set to ANALOG. 	<ul style="list-style-type: none"> Set the input signal type to DIGITAL (see <i>Selecting the input signal type</i> on page 48)
Can't record audio.	<ul style="list-style-type: none"> You are trying to make an analog recording from a digital signal, or a digital recording of an analog source. The digital source is copy protected. 	<ul style="list-style-type: none"> You can only record analog to analog, or digital to digital. You can't record digital sources that have been copy protected.
	<ul style="list-style-type: none"> The analog REC jacks have not been connected properly. 	<ul style="list-style-type: none"> Check your analog connections (see <i>Connecting analog audio sources</i> on page 24).
	<ul style="list-style-type: none"> The analog signal is too strong. 	<ul style="list-style-type: none"> Turn on input attenuator (see <i>Reducing the level of an analog signal</i> on page 76). If the source has an analog output setting, lower it as necessary.
The sound distorts and/or the OVER indicator won't stop lighting.		
You can only hear treble from speakers.	<ul style="list-style-type: none"> The front speakers are set to SMALL. 	<ul style="list-style-type: none"> Set the front speakers to LARGE (see <i>Speaker Systems</i> on page 58).
Subwoofer output is very low.	<ul style="list-style-type: none"> The speaker settings result in very little audio signal being sent to the subwoofer. 	<ul style="list-style-type: none"> To route more audio signal to the subwoofer, set it to PLUS, or select SMALL for the front speaker setting (see <i>Speaker Systems</i> on page 58).
Everything seems to be set up correctly, but the playback sound is odd.	<ul style="list-style-type: none"> The speakers are out of phase. 	<ul style="list-style-type: none"> Check that the positive/negative speaker terminals on the receiver are matched with the corresponding terminals on the speakers (page 26).
Noise or hum can be heard even when there is no sound being input.	<ul style="list-style-type: none"> There is electrical interference from another component or appliance. 	<ul style="list-style-type: none"> Check that personal computers or other digital components connected to the same power source are not causing interference.

Video

Symptom	Cause	Remedy
No image is output when an input is selected.	<ul style="list-style-type: none"> The video connections are incorrect. You are using component video connections for your source, but not for your TV. You are using component video connections and the component video inputs are assigned incorrectly. The DVD/video player settings are incorrect. The video input selected on the TV monitor is incorrect. 	<ul style="list-style-type: none"> Make sure the video component is connected correctly (see pages 17–21). Using the video converter, video signals can be converted from a composite or S-video input to a component video output, but not vice-versa. See <i>About the video converter</i> on page 22 for more on this. Check <i>Assigning the component video inputs</i> on page 91 to make sure you're assigned the correct input. Set correctly. Refer to the instruction manual supplied with the DVD/video player. Set correctly. Refer to the instruction manual supplied with the TV.
The System Setup screen doesn't appear.	<ul style="list-style-type: none"> The MONITOR OUT jack hasn't been connected. Some TVs connected to the receiver with component video cords do not display the System Setup screen when the Color Burst feature is on. 	<ul style="list-style-type: none"> Connect the MONITOR OUT jack to the TV monitor (see <i>Connecting your TV</i> on page 16). When the receiver is in standby, switch to COLOR BURST OFF by holding down the VIDEO SELECT button and pressing ⏻ STANDBY/ON. (the current setting appears in the display). The multi-room control must be switched off to do this.
Color noise appears on the System Setup screen.	<ul style="list-style-type: none"> Some TVs connected to the receiver with composite video cords display color noise on the System Setup screen when the Color Burst feature is off. 	<ul style="list-style-type: none"> When the receiver is in standby, switch to COLOR BURST ON by holding down the VIDEO SELECT button and pressing ⏻ STANDBY/ON (the current setting appears in the display). The multi-room control must be switched off to do this.
Overlay information doesn't appear on your TV or monitor.	<ul style="list-style-type: none"> Overlay information doesn't appear when you are using different types of video cords for source and TV connections, or when using component video connections. 	<ul style="list-style-type: none"> Do not use component video cables if you would like to see overlay information and use the same type of video cable (for example, <i>only</i> composite, or <i>only</i> S-video) for both source and TV connections.
Can't see or hear television programs.	<ul style="list-style-type: none"> The video input selected on the TV monitor is incorrect. 	<ul style="list-style-type: none"> Set the TV input to the channel you want to watch, instead of the receiver input.
There is residual screen noise after an overlay message disappears.	<ul style="list-style-type: none"> Some TVs exhibit this display problem. 	<ul style="list-style-type: none"> This is not a malfunction with this receiver.
Can't record video.	<ul style="list-style-type: none"> You are trying to record a source connected to the component video jacks. The source is copy protected. 	<ul style="list-style-type: none"> Connect the source component to either the composite video or the S video jacks (see <i>Connecting your equipment</i> on page 14). You can't record sources that have been copy protected.

Settings

Symptom	Cause	Remedy
The Auto Surround Setup continually shows an error.	<ul style="list-style-type: none"> The ambient noise level in the room is too high. 	<ul style="list-style-type: none"> Keep the noise level in the room as low as possible when using the Auto Surround Setup. If the noise cannot be kept low enough, you will have to set up the surround sound manually (page 57).
After using the Auto Surround Setup, the subwoofer distance setting is set further than the actual measured distance.	<ul style="list-style-type: none"> The low-pass filter found in subwoofers can introduce a delay in the playback sound. 	<ul style="list-style-type: none"> This is not a malfunction. The Auto Surround Setup has compensated for the delay caused by the filter.
After using the Auto Surround Setup, the speaker size setting (LARGE or SMALL) is incorrect.	<ul style="list-style-type: none"> There was some inaudible low-frequency noise in the room. 	<ul style="list-style-type: none"> The low-frequency noise could have been caused by an air conditioner or motor. Switch off all appliances in the room and rerun the Auto Surround Setup.
The display shows KEY LOCK ON when you try to make settings.	<ul style="list-style-type: none"> Your Pioneer dealer has enabled the key lock feature. 	<ul style="list-style-type: none"> Ask your Pioneer dealer to disable the key lock.

Remote control

Symptom	Cause	Remedy
The receiver cannot be remote controlled.	• You are too far away or at a bad angle for operation.	• Operate within 23 ft., 30° of the remote sensor on the front panel (see <i>Using the remote control</i> on page 9).
	• There is an obstacle between the receiver and the remote control.	• Remove the obstacle or operate from another angle of position.
	• Strong light such as fluorescent light.	• Avoid exposing the remote sensor on the front panel to direct light.
	• The remote control has a weak charge.	• Recharge the remote control (see <i>Recharging the remote control</i> on page 9). You can also use the remote while it's placed on the recharger.
	• The remote control is locked.	• Unlock the remote control (see <i>Locking the remote control</i> on page 12).
	• The CONTROL IN jack has been hooked up.	• Disconnect the CONTROL IN jack (see <i>Operating other Pioneer components with this unit's sensor</i> on page 74).
Other components cannot be remote controlled.	• The IR-receiver does not correspond with the type specified in the multi-room settings.	• Change the setting to correspond with your IR-receiver (<i>Multi-Room Setting</i> on page 95).
	• The proper code hasn't been input into the remote control to control that component. • Something is plugged into the CONTROL IN jack.	• Input the proper code into the remote control (see page 67). • Either point remote at the remote sensor of the unit that is plugged into the CONTROL IN jack or unplug the cable from the CONTROL IN jack and use remote normally (see <i>Operating other Pioneer components with this unit's sensor</i> on page 74).
The remote control doesn't seem to recharge properly (the recharge indicator doesn't light), or it won't hold a charge.	• The remote control hasn't been seated properly on the recharger.	• Reseat it on the recharger, making sure to align the indent on the bottom of the remote with the tabs on the recharger.
	• The battery cells need to be replaced.	• See <i>Replacing the lithium-ion batteries</i> on page 12.
The remote control display is flashing LOW BATTERY or is blank.	• The remote control needs to be recharged.	• Place the remote control on the recharger. If the remote hasn't been charged for awhile, the remote control display may remain blank for several minutes before the touch screen appears. See <i>Recharging the remote control</i> on page 9 for more on this.
	• The remote control contrast needs to be adjusted.	• Use the contrast control on the right-hand side of the remote to adjust the contrast as necessary.
The remote control display is blank or very hard to see.	• The remote control backlight is switched on in a bright room.	• Switch the backlight off.
	• The Direct Function feature for the component you want to select is switched off.	• See <i>Remote Direct function</i> on page 70 to switch it on again.
When you press an input select button on the Home menu screen, the receiver input source doesn't change to the selected function.	• You have selected a button that cannot learn commands.	• Select another button that can learn commands (see <i>Programming signals from other remote controls</i> on page 69).
	• You have already selected a button for learning.	• Press the same button again to deselect it or press END to go back a screen (see <i>Programming signals from other remote controls</i> on page 69).
Can't program certain buttons with remote signals when using the learning feature.	• You have selected a button that accesses a menu.	• These buttons cannot be programmed (see <i>Programming signals from other remote controls</i> on page 69).
	• The display changes after selecting a button when using the learning feature.	• These buttons cannot be programmed (see <i>Programming signals from other remote controls</i> on page 69).
The SR cable is connected, but the connected components can't be operated with the remote.	• The SR cable hasn't been connected properly.	• Reinsert the SR cable, making sure it's connected to the right jack (see <i>Operating other Pioneer components with this unit's sensor</i> on page 74).
	• The rest of the component connections have not been made.	• Make sure an analog connection has been made between the units.
	• The component you have hooked up is not a Pioneer product.	• This feature only works with Pioneer products.
The remote control touch screen doesn't respond.	• The remote control display has frozen (stopped operating).	• Restart the remote control (see <i>Restarting the remote control</i> on page 12).

Symptom	Cause	Remedy
The date and time have suddenly changed.	• The remote control is low on batteries and reset the date automatically.	• Reset the clock (see <i>Setting the clock</i> on page 10).
	• The date was cleared after restarting the remote control.	• Reset the clock (see <i>Setting the clock</i> on page 10).

Display

Symptom	Cause	Remedy
The display is dark or off.	• The display is set to dark or off.	• Press DIMMER on the remote control repeatedly to select a different brightness.
After making an adjustment the display goes off.	• The display is set to off.	• Press DIMMER on the remote control repeatedly to select a different brightness.
You can't get DIGITAL or DRF to display when using the SIGNAL SELECT button.	• There is a problem with the digital connections or the digital input is assigned incorrectly.	• Check your digital connections and/or assign the digital inputs correctly (see <i>Assigning the digital inputs</i> on page 90).
	• The TAPE 2 monitoring feature is on.	• Press TAPE 2 MONITOR to switch it off (see <i>Monitoring your recording</i> on page 75).
	• You've selected an unassigned i.LINK source input.	• Select the correct source input or assign your i.LINK connections correctly (see <i>Assigning the i.LINK inputs</i> on page 91).
The Dolby/DTS indicator doesn't light when playing Dolby/DTS software.	• The player is paused. • The player's sound output settings are wrong.	• Press play. • Set the player correctly (consult the manual that came with the player, if necessary).
When playing a DVD-Audio CD, the DVD player display shows 96 kHz . However, the receiver's display does not.	• The audio from these discs is output from the analog audio jacks of the DVD player only; the receiver does not show the sampling rate of the input signal through the analog inputs.	• This is not a malfunction. See also the operating instructions that came with your DVD player.
During playback of a DTS 96/24 source, the display doesn't show 96kHz .	• The source is being downsampled.	• See <i>Listening to dual mono soundtracks</i> on page 53 for several different ways listen to sources without downsampling.
	• One of the DIGITAL NR , MIDNIGHT or LOUDNESS features are switched on.	• Turn it/them off by pressing the corresponding button on the remote control or front panel.
When playing Dolby Digital or DTS sources, the receiver's format indicators do not light.	• No digital connection, or the digital connection is incorrect.	• Check the digital audio connection (page 17).
	• The receiver's input signal type is set to analog.	• Set the receiver to AUTO or DIGITAL (see <i>Selecting the input signal type</i> on page 48).
	• The DVD player is set to output Dolby Digital and/or DTS audio as PCM.	• Check the settings on the player. Set the output for Dolby Digital and DTS (no PCM conversion). See also the operating instructions that came with your DVD player.
When playing certain discs, the one currently playing is actually PCM.	• The disc has several playback audio tracks;	• Switch the playback audio channel on your DVD player. See the operating instructions that came with your DVD player.
	• The audio format of the disc is not 5.1/6.1 channel.	• This is not a malfunction. Check the disc packaging for details of the audio formats available on the disc.
When playing a disc, the Pro Logic II or Neo:6 indicator lights on the receiver.	• The input signal type is set to analog.	• Set the receiver to AUTO or DIGITAL (see <i>Selecting the input signal type</i> on page 48).
	• A 2 channel soundtrack is currently playing.	• This is not a malfunction. Check the disc packaging for details of the audio formats available on the disc.
	• The soundtrack currently playing is encoded using Dolby Surround.	• This is not a malfunction. Check the disc packaging for details of the audio formats available on the disc.
During playback of a Surround EX or DTS ES source on the Stream Direct or SB CH AUTO setting, the EX and ES indicators don't light, or the signal is not properly processed.	• The source may be Dolby Surround EX / DTS ES software, but it has no flag to indicate it is 6.1 compatible.	• Switch the surround back channel setting (page 50) to SB CH ON then switch to the THX Surround EX or Standard EX listening mode (see <i>Listening in surround sound</i> on page 43).

i.LINK interface

Symptom	Cause	Remedy
No sound is output.	<ul style="list-style-type: none"> An output signal is not produced from the i.LINK connector on the source player. The selected component is not compatible with i.LINK audio. The input signal is set to DORF, DIGITAL or ANALOG. 	<ul style="list-style-type: none"> Refer to the manual that came with the source player. Refer to the manual that came with the source player. Select i.LINK or AUTO using the SIGNAL SELECT button (see <i>Selecting the input signal type</i> on page 48).
i.LINK indicator does not light up even when an i.LINK-equipped component is selected.	<ul style="list-style-type: none"> The DORF, DIGITAL or ANALOG input signal is selected. 	<ul style="list-style-type: none"> Select i.LINK or AUTO using the SIGNAL SELECT button (see <i>Selecting the input signal type</i> on page 48).
The program format indicators don't disappear when SACD playback stops.	<ul style="list-style-type: none"> The program format indicators remain lit until another format source is input. 	<ul style="list-style-type: none"> This is not a malfunction.
You can't get i.LINK to display when using the SIGNAL SELECT button.	<ul style="list-style-type: none"> i.LINK-equipped component(s) are not ready. i.LINK input setting is incorrect. 	<ul style="list-style-type: none"> Turn on the component(s). Select the correct i.LINK input setting (see <i>Assigning the i.LINK inputs</i> on page 91).
After upgrading a component, it is not recognized and cannot be selected using the i.LINK connection.	<ul style="list-style-type: none"> Depending on the upgrade process, certain components may cease to be recognized by the receiver. 	<ul style="list-style-type: none"> You may need to reset the i.LINK database memory in the receiver: With the receiver in standby, press ⏻ STANDBY/ON while holding down OPTION+. When you see DB CLEAR? appear in the display, press OPTION-, then OPTION+ again to confirm. When you've reset the i.LINK database memory, DB CLEAR SET shows in the display.

i.LINK messages

You may see the following messages displayed in the front panel display when using the i.LINK interface.

Message	Explanation
BUS FULL	The i.LINK bus has reached its capacity and cannot transmit any more data.
CANNOT LINK 1	The connection between the receiver and the selected i.LINK-equipped component is unstable. If the i.LINK cables appear to be connected properly and both the receiver and i.LINK-equipped component are on, switch both units off, then on again to re-establish the connection between them.
CANNOT LINK 2	The receiver can't identify the selected i.LINK-equipped component. For example, the receiver may not be able to identify an i.LINK-equipped personal computer.
LINK CHECK	The receiver is checking the i.LINK network. It does this when components are added to, or removed from the network. The sound may be interrupted if this happens during playback.
LOOP CONNECT	The i.LINK network cannot function because the connected components form a loop. See <i>Creating an i.LINK network</i> on page 86 for more on this.
NO NAME	When an i.LINK-equipped component has no name, this message is displayed instead of the proper component name.
NO SIGNAL	A component is outputting an i.LINK signal that the receiver cannot reproduce. This receiver can only reproduce signals from i.LINK-Audio-equipped components. See <i>About i.LINK</i> on page 86 for more on this.
PQLS OFF	This is displayed when PQLS turns off during playback. The sound may be interrupted momentarily when this happens.
PQLS ON	This is displayed when PQLS turns on during playback. The sound may be interrupted momentarily when this happens.
UNKNOWN	When an i.LINK-equipped component name cannot be recognized, this message is displayed instead of the proper component name.

USB interface

Symptom	Cause	Remedy
No sound.	<ul style="list-style-type: none"> The computer settings are incorrect. 	<ul style="list-style-type: none"> Make sure you have set up your computer system to output through the USB interface (see <i>Using the USB interface</i> on page 87).
	<ul style="list-style-type: none"> The software or source material you are using is not compatible with USB output. 	<ul style="list-style-type: none"> Update to a more recent version of your existing software, try a different audio program, or try a different source.
	<ul style="list-style-type: none"> The volume control on your computer is set too low. 	<ul style="list-style-type: none"> Turn up the volume on your computer.
No sound from one or more channels.	<ul style="list-style-type: none"> The software settings are incorrect, or the program you are using cannot output multichannel audio. 	<ul style="list-style-type: none"> Try changing the software settings. If this doesn't work, update to a more recent version of your existing software, or try a different audio program.
	<ul style="list-style-type: none"> The wrong input setting is selected for the USB interface. 	<ul style="list-style-type: none"> Change the setting accordingly (see <i>Selecting USB and multichannel analog input channels</i> on page 49).

Miscellaneous

Symptom	Cause	Remedy
The receiver doesn't seem to respond when the buttons are pressed.	<ul style="list-style-type: none"> Static electricity caused by dry air. 	<ul style="list-style-type: none"> Switch the power off then on again. If this doesn't seem to work, try disconnecting the power plug from the outlet, and insert again.
One of the Home THX 7.1 channel modes is selected, but there are certain options that can't be chosen.	<ul style="list-style-type: none"> There is only one surround back speaker connected or the current settings are for only one surround back speaker. 	<ul style="list-style-type: none"> Make sure there are two surround back speakers connected (see <i>Connecting the speakers</i> on page 26) and make the necessary settings in <i>Speaker Systems</i> on page 58.
There seems to be a time lag between the speakers and the output of the subwoofer.	<ul style="list-style-type: none"> The subwoofer channel can be delayed slightly if run through a low-pass filter. 	<ul style="list-style-type: none"> See <i>Automatically setting up for surround sound</i> on page 39 to set up your system again using MCAAC (this will automatically compensate for a delay in the subwoofer output).
The receiver doesn't memorize the last volume level you used before switching it off.	<ul style="list-style-type: none"> The receiver was switched off immediately after changing the volume level. 	<ul style="list-style-type: none"> Make sure to switch off the receiver two seconds or more after changing the volume.
The receiver doesn't memorize the last adjustments you made before switching it off.	<ul style="list-style-type: none"> The receiver was switched off immediately after changing the receiver status. 	<ul style="list-style-type: none"> Make sure to switch off the receiver two seconds or more after changing the receiver status.

 **Note**

- If the unit does not operate normally due to external effects such as static electricity, disconnect the power plug from the outlet and insert again to return to normal operating conditions.

Surround sound formats

Below is a brief description of the main surround sound formats you'll find on DVDs, satellite, cable and terrestrial broadcasts, and video cassettes.

Dolby

The Dolby technologies are explained below. See www.dolby.com for more detailed information.



Dolby Digital

Dolby Digital is a multichannel digital audio coding system widely used in cinemas, and in the home for DVD and digital broadcast soundtracks. It can deliver up to six discrete audio channels, comprising five full range channels and a special LFE (low frequency effects) channel used mainly for deep, rumbling sound effects; hence the term "5.1-channel" Dolby Digital.

In addition to the format features above, Dolby Digital decoders offer downmixing for compatibility with mono, stereo and Dolby Pro Logic audio from a number of bit rates and channels. Another feature, called Dialog Normalization, attenuates programs based on the average level of dialog in a program relative to its peak level (also known as Dialnorm) in order to achieve uniform playback level.

Dolby Digital Surround EX

Dolby Digital Surround EX (the EX stands for EXtended) is an extension of Dolby Digital encoding whereby a surround back channel is matrixed into the surround left/right channels for 6.1 channel playback. This allows for compatibility with Dolby Digital 5.1 channel decoding, as well as for pure decoding using Dolby Digital EX.

Dolby Pro Logic IIx and Dolby Surround

Dolby Pro Logic IIx is an improved version of the Dolby Pro Logic II (and Dolby Pro Logic) *decoding* system. Using the innovative "steering logic" circuit, this system extracts surround sound from sources as follows:

- **Dolby Pro Logic** – 4.1 channel sound (mono surround) from any stereo source
- **Dolby Pro Logic II** – 5.1 channel sound (stereo surround) from any stereo source
- **Dolby Pro Logic IIx** – 6.1 or 7.1 channel sound (stereo surround and surround back) from two channel or 5.1 channel sources

With two channel sources, the ".1" subwoofer channel is generated by bass management in the receiver.

Dolby Surround is an *encoding* system which embeds surround sound information within a stereo soundtrack, which a Dolby Pro Logic decoder can then use for enhanced surround listening with greater sound detail.

Manufactured under license from Dolby Laboratories. "Dolby", "Pro Logic", "Surround EX" and the double-D symbol are trademarks of Dolby Laboratories.

DTS

The DTS technologies are explained below. See www.dtstech.com for more detailed information.



DTS Digital Surround

DTS Digital Surround is a 5.1-channel audio coding system from Digital Theater Systems Inc. now widely used for DVD-Video, DVD-Audio, 5.1 music discs, digital broadcasts, and video games. It can deliver up to six discrete audio channels, comprising five full range channels, including an LFE channel. Higher sound quality is achieved through the use of a low compression rate, and high rates of transmittance during playback.

DTS-ES

DTS-ES (the ES stands for Extended Surround) is a decoder that is capable of decoding both DTS-ES Discrete 6.1 and DTS-ES Matrix 6.1 encoded sources. DTS-ES Discrete 6.1 gives 'true' 6.1 channel sound, with a completely separate (discrete) surround back channel. DTS-ES Matrix 6.1 has a surround back channel matrixed into the surround left/right channels. Both sources are also compatible with a conventional DTS 5.1 channel decoder.

DTS Neo:6

DTS Neo:6 can generate 6.1 channel surround sound from any matrixed stereo source (such as video or TV) and from 5.1 channel sources. It uses both the channel information already encoded into the source, as well as its own processing to determine channel localization (with two channel sources, the ".1" subwoofer channel is generated by bass management in the receiver). Two modes (Cinema and Music) are available using DTS Neo:6 with two channel sources.

DTS 96/24

DTS 96/24 is an extension of the original DTS Digital Surround which offers high quality 96 kHz / 24-bit audio using a DTS 96/24 decoder. This format is also fully backward compatible with all existing decoders. This means that DVD players can play this software using a conventional DTS 5.1 channel decoder.

"DTS", "DTS-ES Extended Surround", "DTS 96/24" and "Neo:6" are trademarks of Digital Theater Systems, Inc.

Windows Media® Audio 9 Professional

Windows Media® Audio 9 Professional (WMA9 Pro) is a discrete surround format developed by Microsoft Corporation.



WMA9 Pro can support up to 5.1/7.1 channel playback with sampling rates up to 24-bit/96kHz. Using the unique WMA compression techniques, WMA9 Pro can deliver multichannel music and soundtracks over high-speed internet networks at low bit rates with minimal audio degradation. Playback may be enjoyed with the Windows Media® Player 9 Series (or other third-party media player) on a personal computer, or with an AV amplifier with on-board WMA9 Pro decoding.

Windows Media® and the Windows logo are trademarks or registered trademarks of Microsoft Corporation in the United States and/or other countries.

PCM (Pulse Code Modulation)

PCM (also known as Linear PCM) is a digital audio coding system that does not use compression to reduce the amount of data needed to represent the analog audio. PCM audio can be found on CDs and some DVDs.

About THX®

THX is an exclusive set of standards and technologies established by the world-renowned film production company, Lucasfilm Ltd. These were designed to make film soundtracks, in both movie theaters and in your home theater, as faithful as possible to what the director intended.

The THX technologies are explained below. See www.thx.com for more detailed information.

**THX Cinema™ processing**

THX engineers developed patented technologies to accurately translate the sound from the movie theater environment into the home, correcting the tonal and spatial errors that occur. When the THX indicator shows in the display, THX features are automatically added in Cinema modes (see *Using the Home THX modes* on page 45).

Re-Equalization™

The tonal balance of a film soundtrack will be excessively bright and harsh when played back over audio equipment in the home because film soundtracks were designed to be played back in large movie theaters using very different professional equipment. Re-Equalization restores the correct tonal balance for watching a movie soundtrack in a small home environment.

Timbre Matching™

This feature filters the sound going to the surround speakers so that it more closely matches the sound coming from the front speakers. This ensures seamless panning between the front and surround speakers.

Adaptive Decorrelation™

By slightly changing one surround channel's time and phase relationship with respect to the other surround channel, Adaptive Decorrelation expands the listening position and creates the same spacious surround experience as in a movie theater using only two speakers.

THX Ultra2™

Before any home theater component can be THX Ultra2™ certified, it must incorporate all the features described here and also pass a rigorous series of quality and performance tests. THX Ultra2™ requirements cover every aspect of the product including pre-amplifier performance and operation, and hundreds of other parameters in both the digital and analog domain.

THX Surround EX™

THX Surround EX-Dolby Digital Surround EX is a joint development of THX Ltd. and Dolby Laboratories, Inc. This technology reproduces an additional surround back channel, bringing greater depth, spacious ambience, sound localization and detailed imaging behind the listener.

This product may also engage the THX Surround EX mode during the playback of 5.1 channel material that is not Dolby Digital Surround EX encoded. In such case the information delivered to the surround back channel may have unpredictable results.

Advanced Speaker Array™ (ASA)

When you set up your home theater system using all eight speaker outputs and the two surround back speakers are placed close together as shown in the diagram in *THX speaker system setup* on page 98, the surround sound experience is optimized for THX Ultra2™ Cinema and THX MusicMode.

THX's ASA circuitry will automatically detect DTS-ES (Matrix and 6.1Discrete) and Dolby Digital Surround EX encoded soundtracks for correct playback using all 8 speakers.

Please note that some Dolby Digital Surround EX soundtracks are missing the digital flag that allows ASA to switch automatically. Therefore, if you know that the movie that you are watching is encoded in Surround EX, you may manually select the THX Surround EX playback mode.

THX Ultra2™ Cinema mode

This mode plays 5.1 movies using all 8 speakers giving you the best possible movie watching experience. In this mode ASA processing blends the side surround speakers and back surround speakers giving you the optimal mix of ambient and directional surround sounds.

THX MusicMode™

ASA technology optimizes playback of 5.1 encoded music sources such as DTS and Dolby Digital using all 8 speakers in your setup.

Boundary Gain Compensation™

Depending on the listener's and the subwoofer's position, the listener may experience an excessive bass effect. This feature compensates for excessive bass resulting from a boundary gain effect. This feature is designed to operate when used with a subwoofer certified to THX Ultra2™ specifications.

THX and Ultra 2 are trademarks or registered trademarks of THX Ltd. Surround EX is a jointly developed technology of THX Ltd. and Dolby Laboratories, Inc. and is a trademark of Dolby Laboratories, Inc. Used under authorization. All rights reserved.

Maintenance of external surfaces

- Use a polishing cloth or dry cloth to wipe off dust and dirt.
- When the surfaces are dirty, wipe with a soft cloth dipped in some neutral cleanser diluted five or six times with water, and wrung out well, and then wipe again with a dry cloth. Do not use furniture wax or cleaners.
- Never use thinners, benzene, insecticide sprays or other chemicals on or near this unit, since these will corrode the surfaces.

Specifications

Amplifier section

Continuous average power output of 160 watts* per channel, min., at 6 ohms, from 20 Hz to 20,000 Hz with no more than 0.09% total harmonic distortion (front).**

Continuous Power Output (6 Ω)

Front. 160 W + 160 W (20 Hz-20 kHz, 0.09%)
 Center 160 W (20 Hz-20 kHz, 0.09%)
 Surround 160 W + 160 W (20 Hz-20 kHz, 0.09%)
 Surr. back 160 W + 160 W (20 Hz-20 kHz, 0.09%)

Continuous Power Output (8 Ω)

Front. 130 W + 130 W (20 Hz-20 kHz, 0.09%)
 Center 130 W (20 Hz-20 kHz, 0.09%)
 Surround 130 W + 130 W (20 Hz-20 kHz, 0.09%)
 Surr. back 130 W + 130 W (20 Hz-20 kHz, 0.09%)

Audio Section

Input (Sensitivity/Impedance)

PHONO MM 4.7 mV/47 kΩ
 LINE 382 mV/47 kΩ

Phono Overload level (T.H.D.0.1%, 1kHz)

PHONO MM 120 mV

Frequency Response

PHONO MM 20 Hz to 20,000 Hz ± 0.3 dB
 LINE 5 Hz to 100,000 Hz ± 0.5 dB

Output (Level/Impedance)

LINE 382 mV/2.2 kΩ

Tone Control

BASS ± 6 dB (100 Hz)
 TREBLE ± 6 dB (10 kHz)
 LOUDNESS +4/+2 dB (100Hz/10 kHz)
 (at volume position -40dB)

Signal-to-Noise Ratio (IHF, short circuited, A network)

PHONO MM 86 dB
 LINE 105 dB

Signal-to-Noise Ratio [EIA, at 1 W (1 kHz)]

PHONO MM 83 dB
 LINE 93 dB

* Measured pursuant to the Federal Trade Commission's Trade Regulation rule on Power Output Claims for Amplifiers
 ** Measured by Audio Spectrum Analyzer

Video Section

Input (Sensitivity/Impedance) 1 Vp-p/75 Ω
 Output (Level/Impedance) 1 Vp-p/75 Ω
 Signal-to-Noise Ratio 70 dB
 Frequency Response 5 Hz to 10 MHz ±0.5 dB

Component Video Section

Input (Sensitivity/Impedance) 1 Vp-p/75 Ω
 Output (Level/Impedance) 1 Vp-p/75 Ω

Signal-to-Noise Ratio 70 dB
 Frequency Response 5 Hz to 100 MHz ±0.5 dB

FM Tuner Section

Frequency Range 87.5 MHz to 108 MHz
 Usable Sensitivity Mono: 13.2 dBf, IHF (1.3 μV/75 Ω)
 50 dB Quieting Sensitivity Mono: 20.2 dBf
 Stereo: 38.6 dBf
 Signal-to-Noise Ratio Mono: 73 dB (at 85 dBf)
 Stereo: 70 dB (at 85 dBf)
 Distortion Stereo: 0.5% (1 kHz)
 Alternate Channel Selectivity 60 dB (400 kHz)
 Stereo Separation 40 dB (1 kHz)
 Frequency Response 30 Hz to 15 kHz ± 1dB
 Antenna Input 75 Ω unbalanced

AM Tuner Section

Frequency Range 530 kHz to 1,700 kHz
 Sensitivity (IHF, Loop antenna) 350 μV/m
 Selectivity 25 dB
 Signal-to-Noise Ratio 50 dB
 Antenna Loop antenna

Miscellaneous

Power Requirements AC 120 V, 60 Hz
 Power Consumption 735 W, 970 VA
 Power Consumption in Standby mode 0.65 W
 AC Outlet
 SWITCHED 100 W (0.8 A) MAX
 Dimensions 440 (W) × 204 (H) × 476 (D) mm
 (17-5/16 (W) × 8 (H) × 18-3/4 (D) in.)
 Weight (without package) 31.0 kg (68.4 lb 6 oz)

Furnished Parts

Microphone 1
 Remote control unit 1
 Remote control unit recharger 1
 AC adapter 1
 AM loop antenna 1
 FM wire antenna 1
 Power cord 1
 U-shaped connectors 2
 These operating instructions 1
 Warranty card 1

Note

- Specifications and the design are subject to possible modifications without notice, due to improvements.
- This product includes FontAvenue® fonts licensed by NEC corporation. FontAvenue is a registered trademark of NEC corporation.

Should this product require service in the U.S.A. and you wish to locate the nearest Pioneer Authorized Independent Service Company, or if you wish to purchase replacement parts, operating instructions, service manuals, or accessories, please call the number shown below.

8 0 0 - 4 2 1 - 1 4 0 4

Please do not ship your product to Pioneer without first calling the Customer Support Division at the above listed number for assistance.

Pioneer Electronics (USA) Inc.
Customer Support Division
P.O. BOX 1760, Long Beach,
CA 90801-1760, U.S.A.

For warranty information please see the Limited Warranty sheet included with your product.

Should this product require service in Canada, please contact a Pioneer Canadian Authorized Dealer to locate the nearest Pioneer Authorized Service Company in Canada.

Alternatively, please contact the Customer Satisfaction Department at the following address:

Pioneer Electronics of Canada, Inc.
Customer Satisfaction Department
300 Allstate Parkway, Markham, Ontario L3R OP2
(905)479-4411
1(877)283-5901

For warranty information please see the Limited Warranty sheet included with your product.

Si ce produit doit être réparé au Canada, veuillez vous adresser à un distributeur autorisé Pioneer du Canada pour obtenir le nom du Centre de Service Autorisé Pioneer le plus près de chez-vous. Vous pouvez aussi contacter le Service à la clientèle de Pioneer:

Pioneer Électroniques du Canada, Inc.
Service à la clientèle
300, Allstate Parkway, Markham, Ontario L3R OP2
(905)479-4411
1(877)283-5901

Pour obtenir des renseignements sur la garantie, veuillez vous reporter au feuillet sur la garantie restreinte qui accompagne le produit.

S018B_2L

Published by Pioneer Corporation.
Copyright © 2003 Pioneer Corporation.
All rights reserved.

PIONEER CORPORATION 4-1, Meguro 1-Chome, Meguro-ku, Tokyo 153-8654, Japan
PIONEER ELECTRONICS (USA) INC. P.O. BOX 1540, Long Beach, California 90810-1540, U.S.A. TEL: (800) 421-1404
PIONEER ELECTRONICS OF CANADA, INC. 300 Allstate Parkway, Markham, Ontario L3R OP2, Canada TEL: (905) 479-4411
PIONEER EUROPE NV Haven 1087, Keetberglaan 1, B-9120 Melsele, Belgium TEL: 03/570.05.11
PIONEER ELECTRONICS ASIACENTRE PTE. LTD. 253 Alexandra Road, #04-01, Singapore 159936 TEL: 656-472-1111
PIONEER ELECTRONICS AUSTRALIA PTY. LTD. 178-184 Boundary Road, Braeside, Victoria 3195, Australia, TEL: (03) 9586-6300
PIONEER ELECTRONICS DE MEXICO S.A. DE C.V.
Blvd.Manuel Avila Camacho 138 10 piso Col.Lomas de Chapultepec, Mexico,D.F. 11000 TEL: 55-9178-4270

K002E

Free Manuals Download Website

<http://myh66.com>

<http://usermanuals.us>

<http://www.somanuals.com>

<http://www.4manuals.cc>

<http://www.manual-lib.com>

<http://www.404manual.com>

<http://www.luxmanual.com>

<http://aubethermostatmanual.com>

Golf course search by state

<http://golfingnear.com>

Email search by domain

<http://emailbydomain.com>

Auto manuals search

<http://auto.somanuals.com>

TV manuals search

<http://tv.somanuals.com>