

Pioneer

**AUDIO/VIDEO
MULTI-CHANNEL RECEIVER**

VSX-709RDS

VSX-609RDS

Operating Instructions

IMPORTANT 1



The lightning flash with arrowhead symbol, within an equilateral triangle, is intended to alert the user to the presence of uninsulated "dangerous voltage" within the product's enclosure that may be of sufficient magnitude to constitute a risk of electric shock to persons.

CAUTION

**RISK OF ELECTRIC SHOCK
DO NOT OPEN**

CAUTION:
TO PREVENT THE RISK OF ELECTRIC SHOCK, DO NOT REMOVE COVER (OR BACK). NO USER-SERVICEABLE PARTS INSIDE. REFER SERVICING TO QUALIFIED SERVICE PERSONNEL.



The exclamation point within an equilateral triangle is intended to alert the user to the presence of important operating and maintenance (servicing) instructions in the literature accompanying the appliance.

IMPORTANT 2

FOR USE IN THE UNITED KINGDOM

The wires in the mains lead are coloured in accordance with the following code :

Blue : Neutral
Brown : Live

If the plug provided is unsuitable for your socket outlets, the plug must be cut off and a suitable plug fitted.

The cut-off plug should be disposed of and must not be inserted into any 13 amp socket as this can result in electric shock. The plug or adaptor or the distribution panel should be provided with 5 amp fuse. As the colours of the wires in the mains lead of this appliance may not correspond with coloured markings identifying the terminals in your plug, proceed as follows :

The wire which is coloured blue must be connected to the terminal which is marked with the letter N or coloured black. The wire which is coloured brown must be connected to the terminal which is marked with the letter L or coloured red.

Do not connect either wire to the earth terminal of a three - pin plug.

NOTE

After replacing or changing a fuse, the fuse cover in the plug must be replaced with a fuse cover which corresponds to the colour of the insert in the base of the plug or the word that is embossed on the base of the plug, and the appliance must not be used without a fuse cover. If lost replacement fuse covers can be obtained from your dealer.

Only 5 A fuses approved by B.S.I. or A.S.T.A. to B.S. 1362 should be used.

Thank you for buying this Pioneer product. Please read through these operating instructions so you will know how to operate your model properly. After you have finished reading the instructions, put them away in a safe place for future reference.

In some countries or regions, the shape of the power plug and power outlet may sometimes differ from that shown in the explanatory drawings. However, the method of connecting and operating the unit is the same.

Power cord CAUTION!

Handle the power cord by the plug. Do not pull out the plug by tugging the cord and never touch the power cord when your hands are wet as this could cause a short circuit or electric shock. Do not place the unit, a piece of furniture, etc., on the power cord, or pinch the cord. Never make a knot in the cord or tie it with other cords. The power cords should be routed such that they are not likely to be stepped on. A damaged power cord can cause a fire or give you an electrical shock. Check the power cord once in a while. When you find it damaged, ask your nearest PIONEER authorized service center or your dealer for a replacement.

WARNING: TO PREVENT FIRE OR SHOCK HAZARD, DO NOT EXPOSE THIS APPLIANCE TO RAIN OR MOISTURE.

This product complies with the Low Voltage Directive (73/23/EEC), EMC Directives (89/336/EEC, 92/31/EEC) and CE Marking Directive (93/68/EEC).

THE POWER SWITCH IS SECONDARY CONNECTED AND THEREFORE DOES NOT SEPARATE THE UNIT FROM MAINS POWER IN STANDBY POSITION.

Maintenance of External Surfaces

- Use a polishing cloth or dry cloth to wipe off dust and dirt.
- When the surfaces are dirty, wipe with a soft cloth dipped in some neutral cleanser diluted five or six times with water, and wrung out well, and then wipe again with a dry cloth. Do not use furniture wax or cleansers.
- Never use thinners, benzene, insecticide sprays or other chemicals on or near this unit, since these will corrode the surfaces.



Features	4
Introductory Information	5
Checking the Supplied Accessories	5
Using this Manual	5
Installing the Receiver	5
When Making Cable Connections	5
Preparing the Remote Control	6
Connecting Your System	7
Audio Components	7
Video Components	8
Digital Components	9
DVD 5.1 Channel Components	11
Antennas	12
Speakers	13
Preparations	15
Setting Up for Surround Sound	15
Setting the Volume Level of Each Channel	21
Setting Up the Remote Control	22
Clearing One of the Remote Control Settings (VSX-709RDS)	25
Clearing All the Remote Control Settings	25
Direct Function	26
Programming a Different Component into a MULTI CONTROL Button (VSX-709RDS)	27
Checking Preset Code (VSX-709RDS)	27
Displays & Controls	28
Front Panel	28
Remote Control (VSX-709RDS)	30
Remote Control (VSX-609RDS)	32
Display	34
Sound Modes	35
Learning About the Sound Modes	35
Switching ANALOG/DIGITAL Signal Input	36
Playing a Source	37
Playing Sources with Dolby Digital or DTS Sound	38
Selecting a Sound Mode	39
Using in MIDNIGHT Listening Mode	41
Using the Tuner	42
Finding a Station	42
Tuning Directly to a Station	43
Memorizing Stations	44
Naming Memorized Stations	45
Recalling Memorized Stations	46
An Introduction to RDS & EON	47
Searching for RDS Programmes	49
Setting EON	50
Making a Recording	51
Making an Audio or a Video Recording	51
Controlling the Rest of Your System	52
CD/MD/CD-R/VCR/LD Player Controls	52
Cassette Deck Controls	53
DVD Player/DVR Controls	54
Cable TV/Satellite TV/TV Controls	55
Additional Information	56
Troubleshooting	56
Preset Code List for VSX-709RDS	58
Preset Code List for VSX-609RDS	63
Specifications	66

Decoding of DTS (Digital Theater Systems)

This is the latest and most widely used digital theater system for cinemas throughout the world. The decoder has been incorporated into this receiver and is able to achieve high sound quality as well as produce dynamic surround sound effects.

Manufactured under license from Digital Theater Systems, Inc. US Pat. No. 5,451,942 and other worldwide patents issues and pending. "DTS" and "DTS Digital Surround" are trademarks of Digital Theater Systems, Inc. © 1996 Digital Theater Systems, Inc. All right reserved.

Decoding of Dolby Digital and Dolby Pro Logic

No need to worry about program formats. When playing Dolby Digital or Dolby Surround software in the  (Dolby) Surround mode, decoding switches automatically according to the input signal. When connecting a DVD/LD player or LD player using the  RF output, a commercially available RF demodulator (RFD-1) is required.

Manufactured under license from Dolby Laboratories. "Dolby", "Pro Logic" and the double-D symbol are trademarks of Dolby Laboratories. Confidential unpublished works. © 1992 - 1997 Dolby Laboratories. All rights reserved.

RDS (Radio-Data System)

With the RDS system, FM stations can send additional information with their regular programs. For example, the stations send their station name, and information about the type of programs they broadcast, such as news, sports or music. This unit receives three types of RDS information: Radio Text (RT), Programme Service Name (PS), and Programme Type (PTY). When EON is turned on and a function other than the tuner is set, the function will switch to the FM station automatically when Traffic Information or News begins.

Advanced Theater Modes

Four sound modes that enhance DTS and Dolby Surround performance by simulating the environment of a movie theater (DRAMA, ACTION), or the ambience of a concert hall (MUSICAL). With EXPANDED THEATER, you can enjoy Dolby Surround encoded software in simulated Dolby Digital.

DSP Surround Modes

DSP (Digital Signal Processing) surround modes give you the capability of transforming your living room into six different sonic environments when listening to music or movies.

Midnight Listening Mode

Midnight Listening mode allows you to obtain excellent surround sound effects even when listening at low volumes, something that was previously impossible.

DVD 5.1 channel input

A special 5.1 Channel input makes the VSX-709RDS/609RDS fully compatible with Dolby Digital decoders and DVD players with 5.1 channel outputs.

Remote Control of Other Components

The supplied remote control can be used to operate a variety of other components simply by recalling the appropriate preset codes. Only the VSX-709RDS has a learning function in the remote control which can be used to teach it new commands.

The Energy-saving Design

This unit is designed to use less than 1 W of energy when this unit is in standby mode.

Checking the Supplied Accessories

Please check that you've received the following supplied accessories:

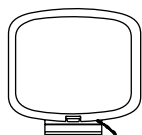

AM loop antenna



FM wire antenna

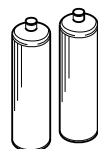

VSX-609RDS:
AA size IEC R6P batteries (x2)
VSX-709RDS:
AA size IEC LR6 batteries (x2)



VSX-609RDS



VSX-709RDS

Remote control

Using this Manual

This manual is for the **VSX-709RDS/VSX-609RDS audio/video multi-channel receivers.**

It is divided into two main sections:

Set up

This section covers installing your receiver and connecting up all the other components in your home theater system to it. It also describes how to set up a multi-channel speaker system to take full advantage of the great surround sound features of your receiver.

Operation

This section shows you how to use every feature of the receiver and its remote control. It also covers using the supplied remote control to operate your other home theater components. To find out more about a specific button, control or indicator, see Displays & Controls starting on page 28. This will point you to the relevant chapter in the manual. In the Additional Information section (p.56 – 66) you'll find a troubleshooting section and specifications.

The following symbols are used throughout this manual:



Provides detailed precautions and advice on operations, etc.



Indicates that display is blinking.

Installing the Receiver

Please note:

- Do not place objects directly on top of this unit. This would prevent proper heat dispersal.
- When installing in a rack, shelf, etc., be sure to leave more than 20 cm of space above the receiver.

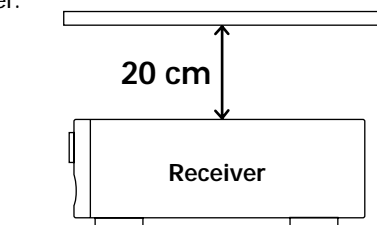

When Making Cable Connections

Be careful not to arrange cables in a manner that bends the cables over the top of this unit as shown in the illustration. If the cables are brought over this unit, the magnetic field produced by the transformers in this unit may cause a humming noise to come from the speakers.

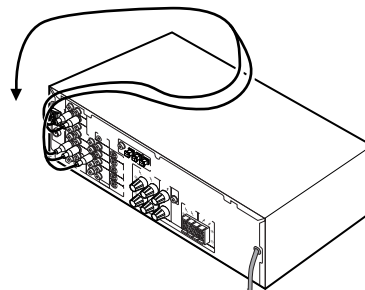

Preparing the Remote Control

Loading the batteries

VSX-609RDS

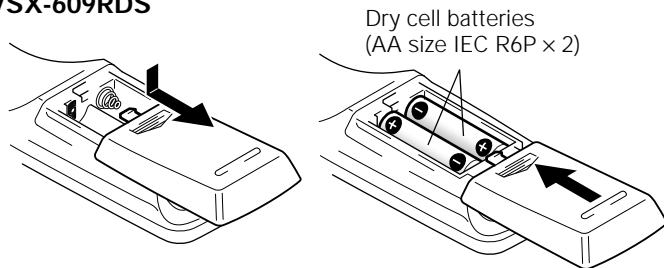

Dry cell batteries
(AA size IEC R6P × 2)

CAUTION!

Incorrect use of batteries may result in such hazards as leakage and bursting. Observe the following precautions:

- Never use new and old batteries together.
- Insert the plus and minus sides of the batteries properly according to the marks in the battery case.
- Batteries with the same shape may have different voltages. Do not use different batteries together.

VSX-709RDS

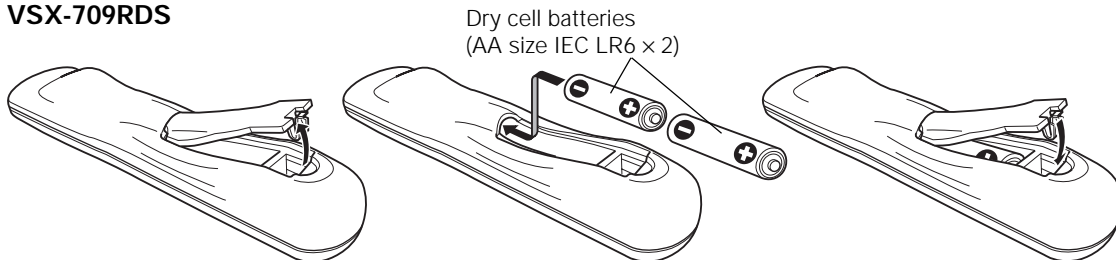

Dry cell batteries
(AA size IEC LR6 × 2)

Operating range of remote control



The remote control may not work properly if:

- There are obstacles between the remote control and the receiver's remote sensor.
- Direct sunlight or fluorescent light is shining onto the remote sensor.
- The receiver is located near a device that is emitting infrared rays.
- The receiver is operated simultaneously with another infrared remote control.

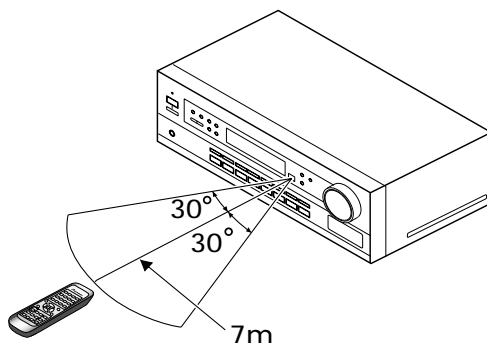

Operating other Pioneer components

By connecting a control cord (optional), you can control other Pioneer equipment using this remote control. Point the remote control towards the remote sensor of this unit, even when operating other equipment.

The remote control signals are received by the remote sensor of this unit, and sent to the other devices via the **CONTROL OUT** terminal.



You can also control Pioneer components by pointing the receiver's remote control directly at the component. This type of operation does not require control cords.

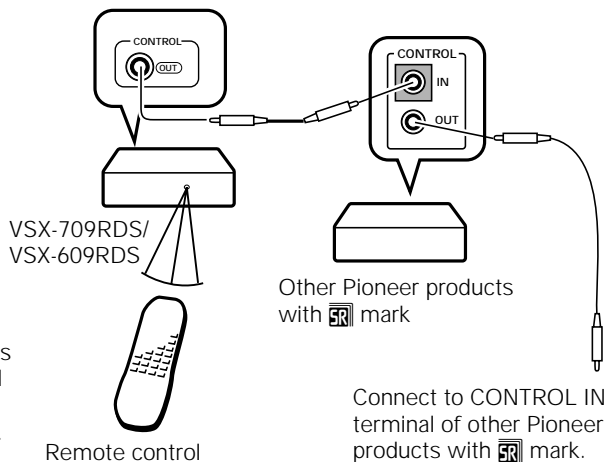

Connecting Your Equipment

Before making or changing the connections, switch off the power and disconnect the power cord from the AC outlet.

Audio Components

To begin set up connect your audio components to the jacks as shown below. These are all analog connections and your analog audio components (cassette deck etc.) use these jacks. Remember that for components you want to record with you need to hook up four plugs (a set of stereo ins and a set of stereo outs), but for components that only play you only need to hook up one set of stereo plugs (two plugs). To use Digital sources features you must hook up your digital components to the digital inputs, but it is also a good idea to hook up your digital components to analog audio jacks. If you want to record to/from digital components (like an MD) to/from analog components you must hook up your digital equipment with these analog connections. See p.9, 10 for more on digital connections.



- Only the VSX-709RDS has S-video jacks and optical digital out jack.
- The arrows indicate the direction of the audio signal.

VSX-709RDS

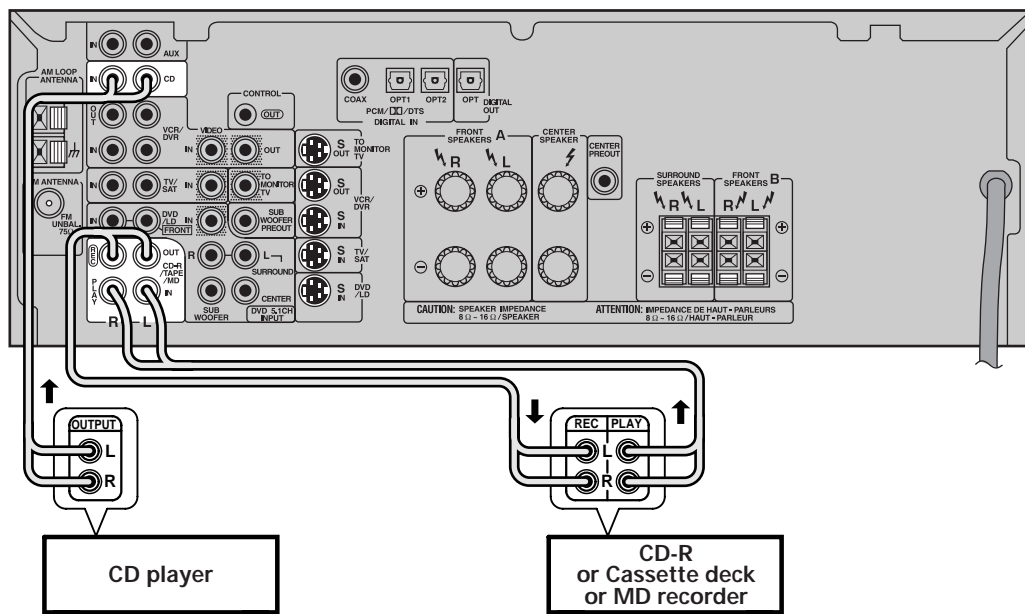

■ Audio cords

Use audio cords (not supplied) to connect the audio components.

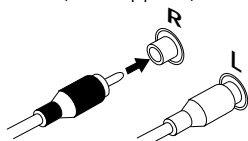

Connect red plugs to R (right) and white plugs to L (left). Be sure to insert completely.

Cassette deck placement

Depending on where the cassette deck is placed, noise may occur during playback of your cassette deck which is caused by leakage flux from the transformer in the receiver. If you experience noise, move the cassette deck farther away from the receiver.

Video Components

Connect your video components to the jacks as shown below. Regarding digital video components (like a DVD player), you must use the analog connections pictured on this page for the video signal but in order to use a digital source you should hook up their audio to a digital input (see the next page). It is also a good idea to hook up your digital components with analog audio connections as well (see the previous page). To cover all possible laser discs a DVD/LD player or LD player requires an analog connection (as shown here) and two digital connections (see the next page).

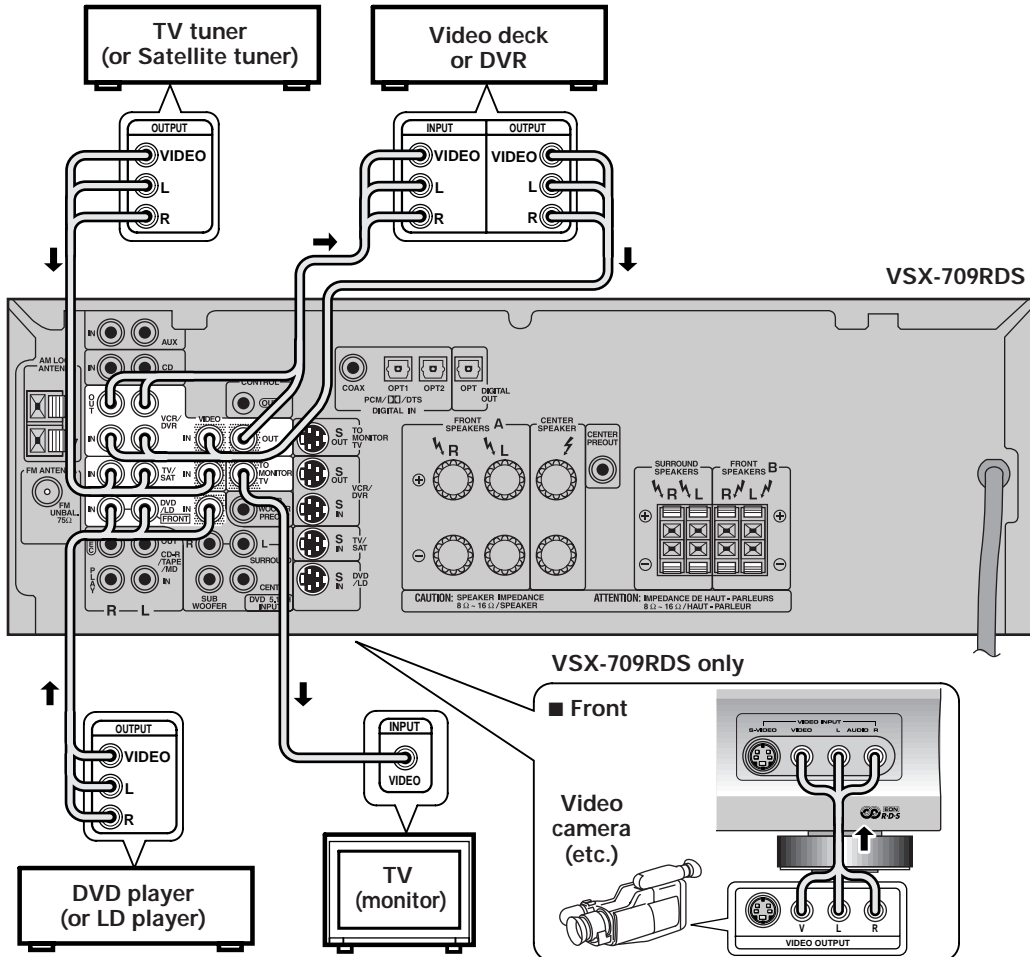

■ Audio/Video cords
 Use audio/video cords (not supplied) to connect the video components and a video cord to connect the monitor TV.

Connect red plugs to R (right), white plugs to L (left), and the yellow plugs to VIDEO.
 Be sure to insert completely.

VSX-709RDS only

■ Front

Video camera (etc.)

Front video connection are accessed via the front panel input selector as "VIDEO."

Memo VSX-709RDS only
 If your video components have S-video jacks, you could use S-video cords (not supplied) to the S-video connector on the front and rear of the receiver. However, **if you use S-video cords for your video hookups you must also hook up your TV with S-video connections. Conversely, if you use regular composite video cords for video hookups, you should use them for your TV as well.**

Digital Components

In order to hear PCM/Dolby Digital/DTS soundtracks you need to make digital audio connections. You can do this by either coaxial or optical connections (you do not need to do both). The quality of these two types of connections is the same, but since some digital components only have one type of digital terminal, it is a matter of matching like with like. The receiver has one coaxial and two optical inputs for a total of three digital inputs. You must assign the jacks to the proper component(s) (refer to pages 19 – 20). Connect your digital components as shown below. There is one digital out jack (VSX-709RDS only). If you connect this to the optical input on a digital recorder (currently these include MD, DAT and CD-R), you can make direct digital recordings with this receiver.

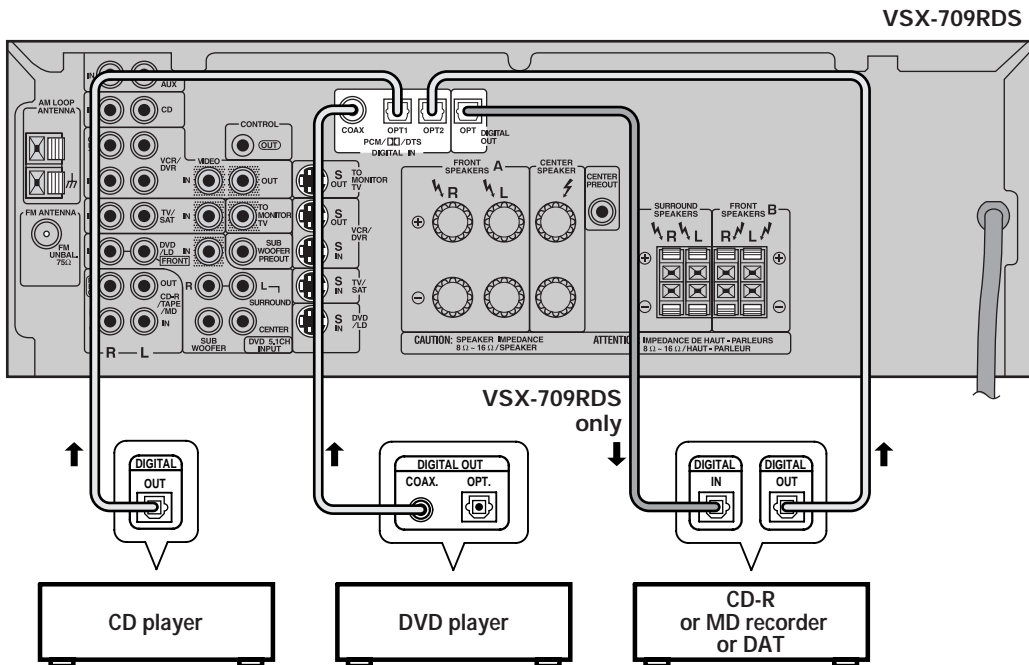

■ Digital audio cords/Optical cables

Commercially available digital audio coaxial cords (standard video cords can also be used) or optical cables (not supplied) are used to connect digital components to this receiver. When you use optical digital input or output terminals, pull off the caps and insert the plugs. Be sure to insert completely.

Digital audio cord (or standard video cord)

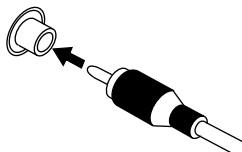

Optical cable

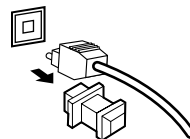

Example of connection using a DVD/LD or LD player

When playing an LD recorded in Dolby Digital

To connect a DVD/LD or LD player with its **RF** output, a commercially available RF demodulator (RFD-1) is required. The RF demodulator changes the digital signal to a form which can be processed by the VSX-709RDS/VSX-609RDS models through their digital input jacks. For more details, refer to the instruction manual supplied with the RFD-1.

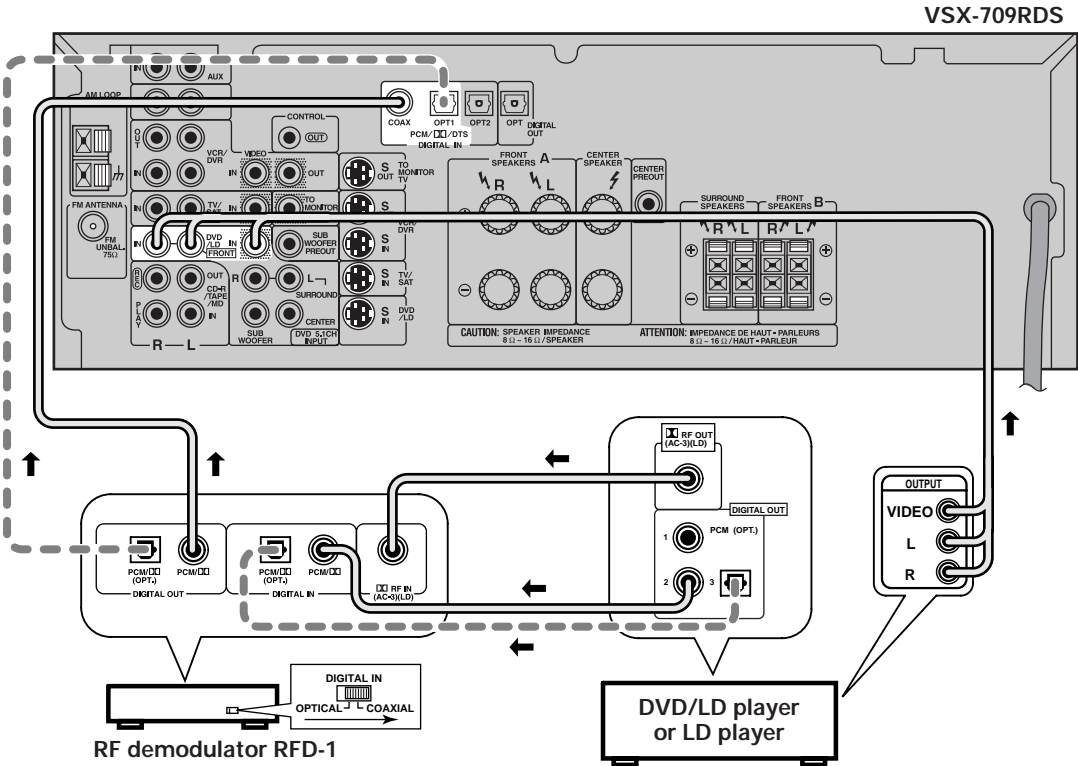

Make sure the RF demodulator digital in switch is set correctly (optical or coaxial depending on the connection).

DVD 5.1 Channel Components

In some cases, you may need an external decoder to play special DVD discs and the like. If you find you need an external decoder, hook one up as shown below. For most people this component is unnecessary. (See p.40)

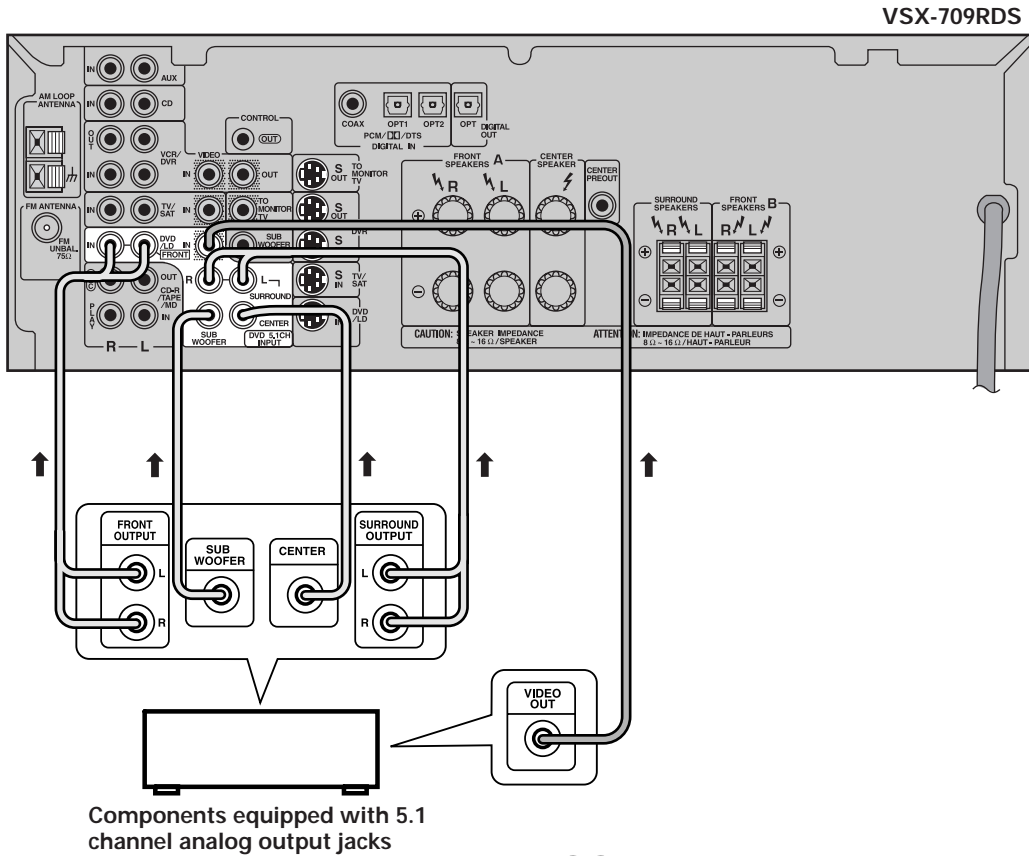

The 5.1 channel input can only be used when DVD 5.1 CH is selected.

Antennas

Hook up the supplied radio antennas as shown below.

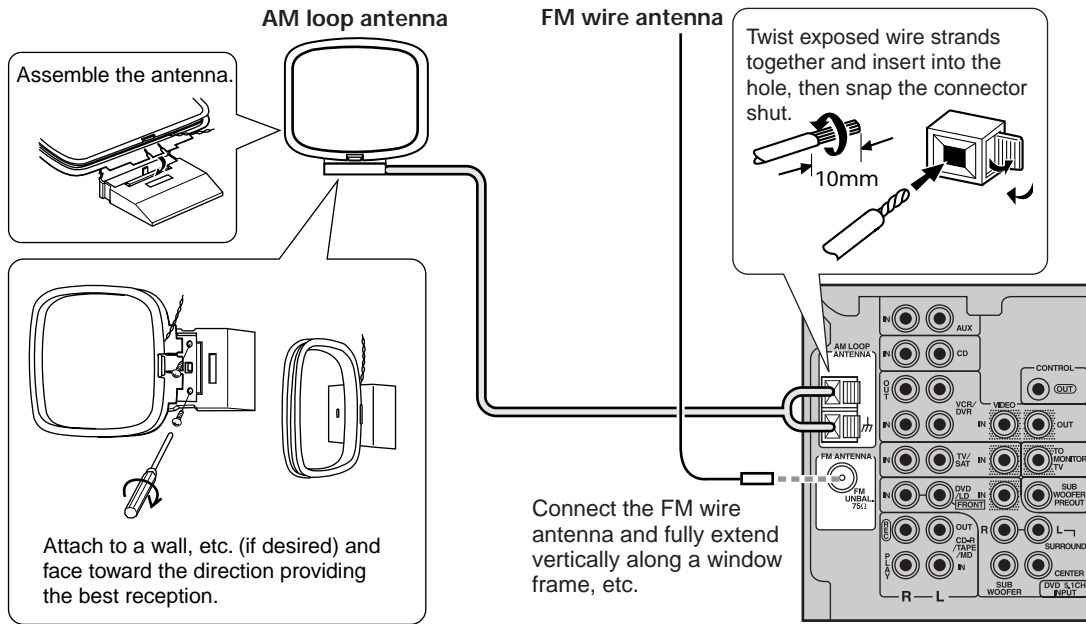

Using external antennas

■ To improve FM reception

Connect an external FM antenna.

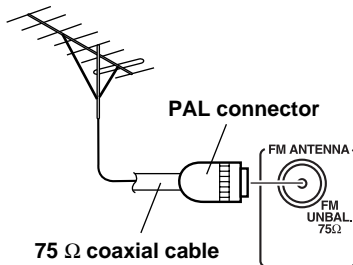

■ To improve AM reception

Connect a 5 – 6 meter length of vinyl-coated wire to the AM antenna terminal without disconnecting the supplied AM loop antenna.

For the best possible reception, suspend horizontally outdoors.

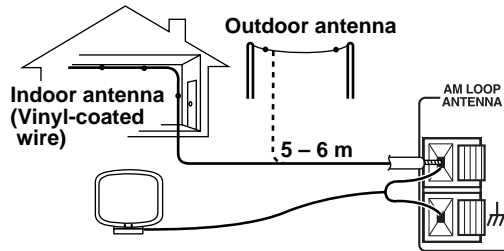

■ Speaker terminals

- ① Twist exposed wire strands together.
- ② Loosen speaker terminal and insert exposed wire.
- ③ Tighten terminal.

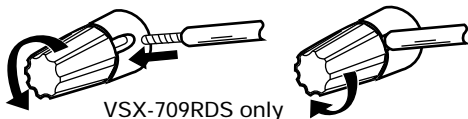

Use good quality speaker wire to connect the speakers to the receiver.

- ① Twist around 10 mm of bare wire strands together.
- ② Unclip the speaker terminal and insert the wire.
- ③ Snap shut the speaker terminal to secure.

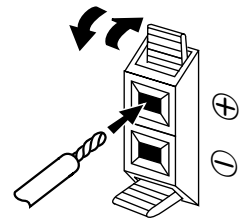

Speakers

A full complement of six speakers is shown here but, naturally, everyone's home setup will vary. Simply connect the speakers you have in the manner described below. The receiver will work with just two stereo speakers (called "front" speakers in the diagram) but it is recommended to be used with at least three speakers. Make sure you connect the speaker on the right to the R (right) terminal and the speaker on the left to the L (left) terminal. Also make sure the positive and negative (+/-) terminals on the receiver match those on the speakers.



The receiver has two speaker systems, A & B. A is the main system supporting the full complement of surround sound speakers. If you switch on both A & B speaker systems, only the front speakers and the sub woofer will be audible. No sound will come from the center or surround speakers but multi channel sources will be down-mixed to the active speakers so no sound will be lost. Similarly, if you choose just the B system you'll only hear the speakers connected to the B system, and multi channel sources will be down-mixed to these two speakers. Please use speakers rated between 8 Ω - 16 Ω.

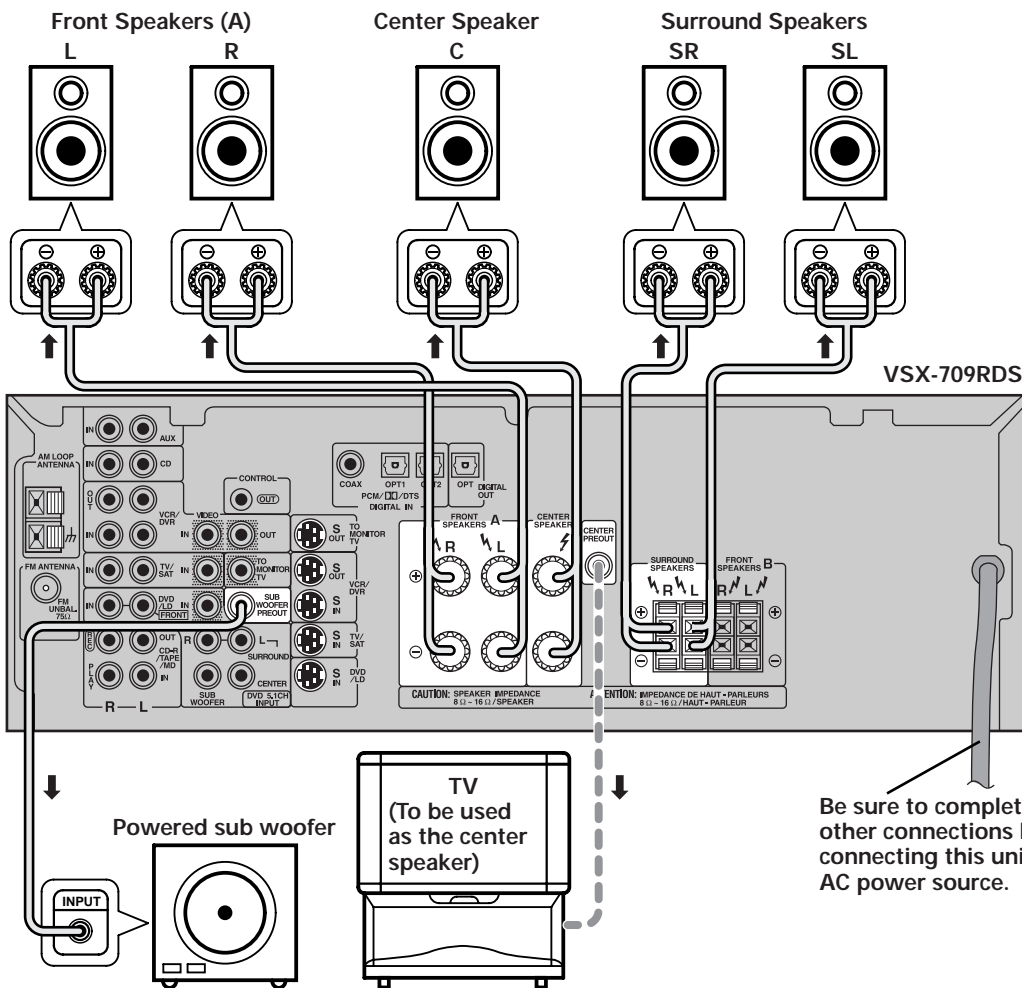

When using the speaker on your TV as the center speaker, connect the CENTER PREOUT jack on this unit to the audio input jack on your TV. In this case, the center speaker shown is unnecessary.

Speaker placement

If you have a multiple speaker arrangement, the placement of the speakers is extremely important. To achieve the best possible surround sound, install your speakers as shown below. Make sure all speakers are installed securely to prevent accidents and improve sound quality. Be sure to consult your speaker manuals for the best placement of the speakers. Some speakers are designed to be floor-standing but others benefit greatly from speaker stands which raise them off the floor.

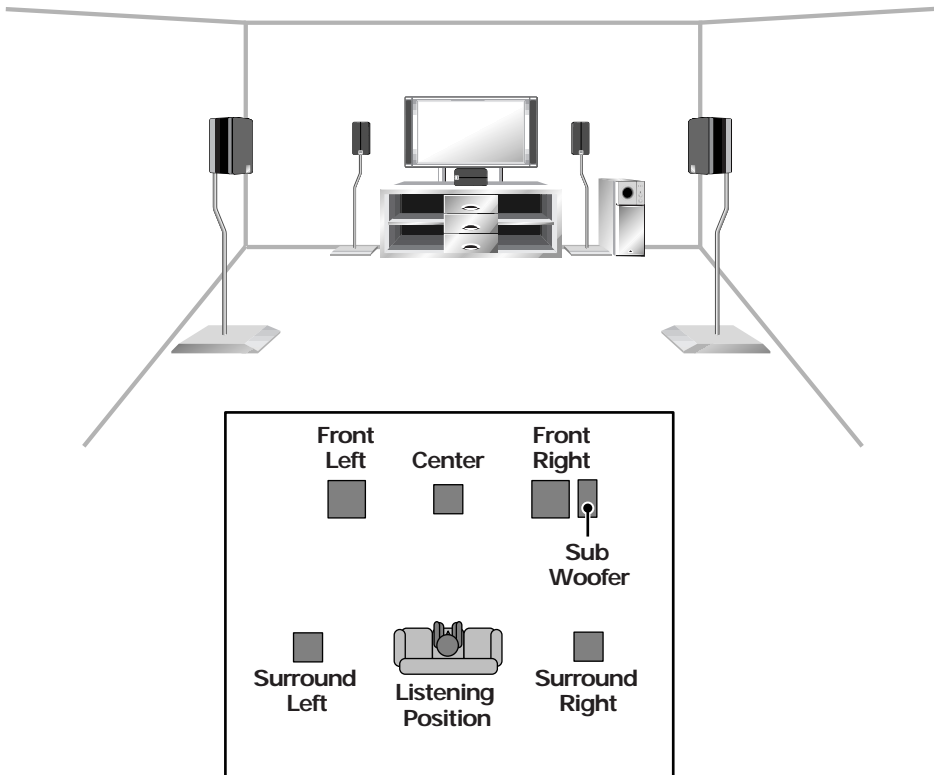

- Install the left and right front speakers at equal distances from the TV.
- When installing speakers near the TV, we recommend using magnetically shielded speakers to prevent possible interference such as distortion in the color of the TV screen. If you do not have magnetically shielded speakers, and notice discoloration of the TV screen, place the speakers farther away from the TV.
- Install the center speaker above or below the TV so that the sound of the center channel is localized at the TV screen.

CAUTION:

When installing the center speaker on top of the TV, be sure to secure it with tape or some other suitable means. Otherwise, the speaker may fall from the TV due to external shocks such as earthquakes, and it may endanger those nearby or damage the speaker.

- If possible, install the surround speakers slightly above ear level.
- It may be difficult to obtain a cohesive surround effect if the surround speakers are installed farther away from the listening position than the front and center speakers.

Before operating the receiver, be sure to press the main power button on the front panel to turn the power ON (➔).

Setting Up for Surround Sound

To ensure the best possible surround sound, be sure to complete the following setup operations. This is particularly important when using the **DD** (Dolby)/DTS mode. You only need to make these settings once (unless you change the placement of your current speaker system or add new speakers, etc.). Refer to the following pages for detailed descriptions of the settings available for each mode.

VSX-709RDS

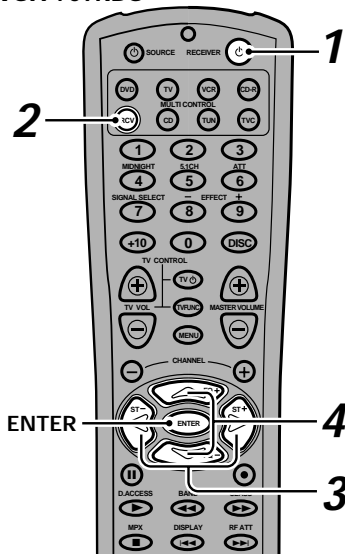

1 Press RECEIVER to turn the power on.

The STANDBY indicator goes out.

2 Press RCV (VSX-709RDS) or RECEIVER (VSX-609RDS).

This switches the remote control to the surround setup mode.

3 Press or to select the mode you want to set.

For best results, start with "Speakers setting mode" and make your initial adjustments in the order described below. The current settings are displayed automatically.

Speakers (Front, Center, Surround) setting mode (page 16)

Use to specify the type of speakers you have connected.

SUB WOOFER ON/PLUS/OFF setting mode (page 17)

Use to specify the sub woofer as on or off.

Crossover frequency setting mode (page 17)

Use to determine which frequencies will be sent to the sub woofer (or "Large" speakers if you don't have a sub woofer).

LFE attenuator setting mode (page 17)

Use to specify the peak level for the LFE channel and the crossover network for rerouted bass frequencies.

Low cut filter ON/OFF setting mode (page 18)

Use to cut the distorted sound from the sub woofer.

FRONT speakers distance setting mode (page 18)

Use to specify the distance from your listening position to your front speaker.

CENTER speaker distance setting mode (page 18)

Use to specify the distance from your listening position to your center speaker.

SURROUND speakers distance setting mode (page 18)

Use to specify the distance from your listening position to your surround speakers.

Dynamic range control setting mode (page 19)

Use to compress the dynamic range of the soundtrack.

Dual mono setting mode (page 19)

Use with Dolby Digital software that has dual mono encoding if you want to isolate one channel or listen in this specialized mono mode.

Coaxial digital input setting (page 19)

Use to specify the input to be assigned to the coaxial digital input.

Optical digital input setting (page 20)

Use to specify the input to be assigned to the optical digital input.

VSX-609RDS

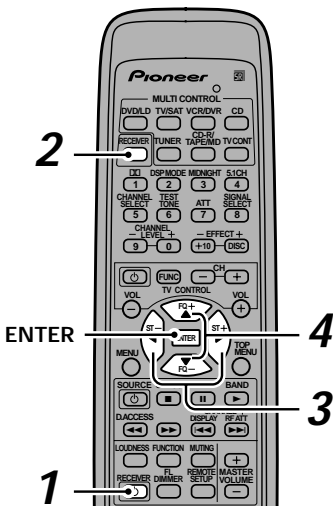

4 Press or to select the setting you want.

The setting is entered automatically.

5 Repeat steps 3 and 4 to set other surround modes.



Press ENTER to exit the setting mode. The setting mode is automatically exited if no operation is performed within 20 seconds.

Speakers (Front, Center, Surround) setting mode

This setting establishes the size and configuration of the speaker system you have connected. So, for example, here you set whether you have connected surround speakers or not, and how big they are. Selecting "Large" or "Small" will determine how much bass is sent by the receiver to the speakers being set. This setup system has certain constraints. For example, all your speakers cannot be set to "Large." You need to decide which speakers should receive the most bass and set them to "Large."

In the display, "F", "C", and "S" refer to front, center, and surround speakers respectively. Speaker size is denoted as "L" for large speakers, "S" for small speakers, and "*" (asterisk) if no speaker is connected.



If the cone size (diameter) of the speaker is larger than 12 cm, please set to Large.

Switch the speakers setting mode according to the speakers you hooked up. Use the Δ or ∇ buttons.

The configurations shown on the right will appear in the display on the front of the receiver. One of them should match your speaker setup. Cycle through the different possibilities until you find the one that matches your setup.

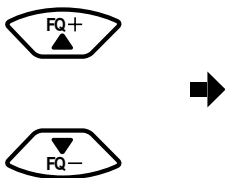

- Press \triangleright to advance to the next receiver setting, and press \triangleleft to return to a previous receiver setting.

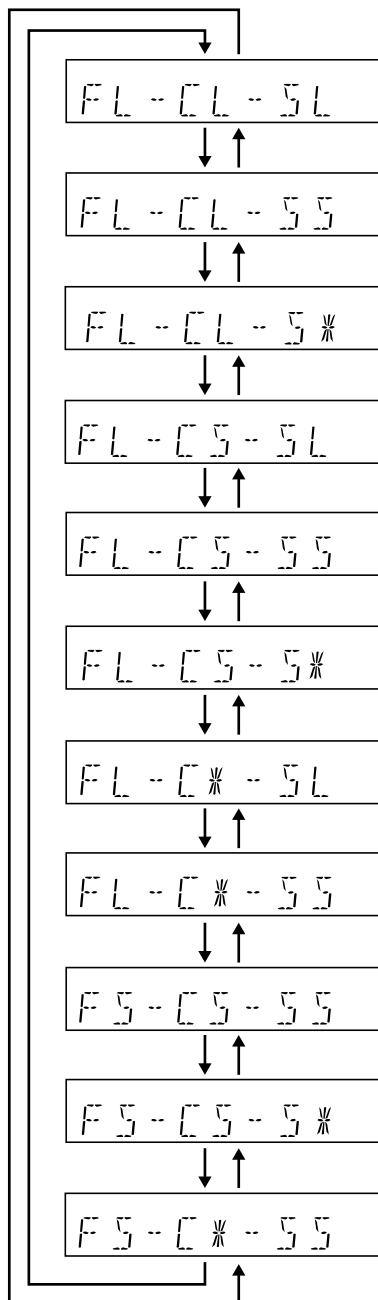

SUB WOOFER ON/PLUS/OFF setting mode

Sets whether the sub woofer is used or not. Also, when used you have the option to use the "PLUS" setting.



- Initial setting is "ON".
- Setting the front speaker size to "Small" in the Speakers setting mode automatically locks the sub woofer in the "ON" position.
- Use the PLUS for extra bass. When you use PLUS, you will get the bass sounds from the sub woofer even if the front speakers are set to "Large".

SUBWF ON -81_{dB}

Press Δ or ∇ to select sub woofer ON, PLUS or OFF.

Crossover frequency setting mode

Crossover frequency is the point where the receiver divides the high and low sounds (the frequencies) between the speakers. Since most smaller speakers can't handle deep bass tones, this setting allows you to send those sounds to the sub woofer (or speakers set to "Large" if you don't have a sub woofer) instead of the speakers set to "Small" in your system. Choose the point at which you want the frequency routed to the sub woofer (or "Large" speakers).

We recommend setting this to 200 Hz if smaller bookshelf-type speakers are used for your "Small" speakers.



- Initial setting is "100 Hz".
- If all speakers (front, center, and surround) are set to "Large" in Speakers setting mode, crossover frequency cannot be set because there are no "Small" speakers (** * appears in the display).

X.OVER 100 -81_{dB}

Press Δ or ∇ to specify the crossover frequency for your small speakers (100 Hz, 150 Hz or 200 Hz).

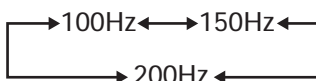

100 Hz

Sends bass frequencies below 100 Hz to the sub woofer (or "Large" speakers).

150 Hz

Sends bass frequencies below 150 Hz to the sub woofer (or "Large" speakers).

200 Hz

Sends bass frequencies below 200 Hz to the sub woofer (or "Large" speakers).

LFE attenuator setting mode

Dolby Digital and DTS audio sources include ultra-low bass tones. Set the LFE (Low Frequency Effect) attenuator as needed to prevent the ultra-low bass tones from distorting the sound from the speakers.



- Initial setting is "0 dB".
- When ∞ is selected (** * appears in the display), LFE is not available.

LFEATT 10 -81_{dB}

Press Δ or ∇ to set the attenuation level (0 dB, 10 dB or ** * dB(∞)).



Low cut filter ON/OFF setting mode

Turn the low cut filter ON when distorted sound is output through the sub woofer.



- Initial setting is "OFF".
- If the SUB WOOFER is set to "OFF" in the SUB WOOFER ON/OFF setting mode, the low cut filter cannot be set.

LCF ON -81_{dB}

Press Δ or ∇ to select low cut filter ON or OFF.

FRONT speakers distance setting mode

Sets the distance from the front speakers to the listening position.



- Adjust the speaker distance in 0.3 m increments from 0.3 m to 9.0 m.
- Initial setting is 3.0 m.

FRNT 3m -81_{dB}

Press Δ or ∇ to set the distance of the FRONT speakers from the main listening position (up to 30 steps).

CENTER speaker distance setting mode

Normally, the front and center speakers are placed at different distances from the listening position. This means that the sound from these speakers will not coincide. To compensate for this, set the center speaker distance setting.



- Adjust the speaker distance in 0.3 m increments from 0.3 m to 9.0 m.
- Initial setting is 3.0 m.
- When "C*" is selected in Speakers setting mode, the center distance cannot be set.

CENT 3m -81_{dB}

Press Δ or ∇ to set the distance of the CENTER speaker from the main listening position (up to 30 steps).

SURROUND speakers distance setting mode

Adding the proper delay to the surround speakers is necessary to achieve a surround effect. The surround speakers are placed at various distances from the listening position. So to compensate for this, set the surround speakers distance setting.



- Adjust the speaker distance in 0.3 m increments from 0.3 m to 9.0 m.
- Initial setting is 3.0 m.
- When "S*" is selected in Speakers setting mode, the surround distance cannot be set.

SURR 3m -81_{dB}

Press Δ or ∇ to set the distance of the SURROUND speakers from the main listening position (up to 30 steps).

Dynamic range control setting mode

Dynamic range is the difference between the loudest and softest sounds in any given signal. The dynamic range control helps you play back sounds so the quieter sounds are audible yet the louder sounds don't get distorted. It does this by compressing the dynamic range. When watching a movie at low volume, setting this function enables you to hear low level sounds to more easily but you won't be jolted by louder sounds.



- Initial setting is "OFF".
- When the volume level is increased, set to "OFF".
- For listening enjoyment at low volumes, set to "MAX" for maximum dynamic range compression.
- Dynamic range control is effective only when a Dolby Digital signal is being played back.

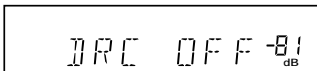

Press Δ or ∇ to set the dynamic range control (OFF, MAX, or MID).

Dual mono setting mode

The dual mono setting can only be used when listening to Dolby Digital discs that contain a dual mono soundtrack. With this setting you can choose which channel is the dual mono setting you want to listen to. Thus, it is useful for soundtracks that have one language on one channel and a different language on the other. Remember you can only use this setting if you have Dolby Digital software with this feature and want to isolate one of the channels therein.

There are two different ways to route the sound in the dual mono setting, one is with Dolby Digital mode on, the other with Dolby Digital mode off. If Dolby Digital mode is switched on, the ch1 setting will play channel 1 through your center speaker. The ch2 setting will play channel 2 through your center speaker and the MIX setting will play both channels through the center speaker. With Dolby Digital mode off, the dual mono sound routing is as follows: In the ch1 setting you will hear channel 1 out of both front speakers. In the ch2 setting you will hear channel 2 out of both speakers. In the L. c1 R. c2 setting the speakers will play the soundtrack independently of each other. The left front speaker will play channel 1 and the right front speaker will play channel 2. The last setting, MIX, mixes both channels and plays them out of both speakers.



- The default setting of this feature is L. c1 R. c2.

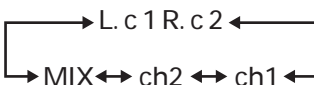

Press Δ or ∇ to cycle through the possible Dual mono settings.

Coaxial digital input setting

Sets the input component to be assigned to the COAX (coaxial) digital input jack.



- Initial setting is "DVD".

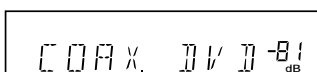

Press Δ or ∇ to select the coaxial digital input (DVD, TV, CD, CD-R, VCR, DVR or OFF).

After you assign the component to the COAX digital jack, when you select that component, for example DVD, the receiver will automatically change to the digital input setting. You can see this in the DIGITAL/ANALOG indicator on the front of the receiver.

Optical digital input setting 1

Sets the input component to be assigned to the OPT 1 (optical) input jack.



- Initial setting is "CD".

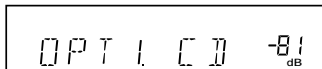

Press Δ or ∇ to select the optical digital input 1 (DVD, TV, CD, CD-R, VCR, or OFF).

After you assign the component to the OPT 1 digital jack, when you select that component, for example CD, the receiver will automatically change to the digital input setting. You can see this in the DIGITAL/ANALOG indicator on the front of the receiver.

Optical digital input setting 2

Sets the input component to be assigned to the OPT 2 (optical) input jack.



- Initial setting is "CD-R".

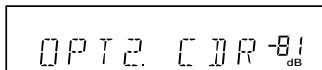

Press Δ or ∇ to select the optical digital input 2 (DVD, TV, CD, CD-R, VCR, or OFF).

After you assign the component to the OPT 2 digital jack, when you select that component, for example CD-R, the receiver will automatically change to the digital input setting. You can see this in the DIGITAL/ANALOG indicator on the front of the receiver.

Setting the Volume Level of Each Channel (Adjusting the Speaker Volume Balance)



- Test tone is only output in Dolby Digital/Dolby surround/DTS modes.
- Levels can be set for each surround mode.
- Initial setting is 0 dB.
- Since the SUB WOOFER transmits ultra-low frequencies, its sound may seem quieter than it actually is.

VSX-709RDS

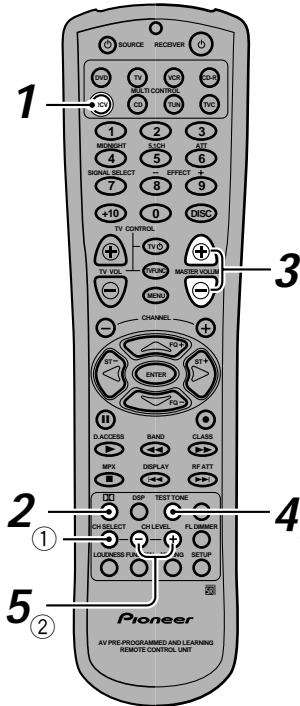

1 Press RCV (VSX-709RDS) or RECEIVER (VSX-609RDS).

This switches the remote control to the surround setup mode.

2 Press \square .

3 Press MASTER VOLUME + or - to adjust the volume to an appropriate level.

4 Press TEST TONE to output the test tone.

The test tone is output in the following order.

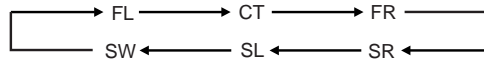

5 Adjust speaker levels so that you hear the test tone at the same volume from each speaker when seated in the main listening position.

The channel level range is ± 10 dB.

6 Press TEST TONE to turn off the test tone.

VSX-609RDS

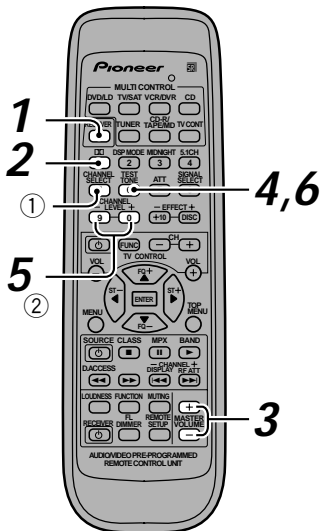

The speaker volume balance can be adjusted without outputting the test tone by pressing CH (CHANNEL) SELECT and CH (CHANNEL) LEVEL +/-.

- ① Press CH (CHANNEL) SELECT to select the channel you want to adjust.
- ② Press CH (CHANNEL) LEVEL + or - to adjust the volume.

Setting Up the Remote Control

In addition to controlling the receiver, the supplied remote control can operate your other components (DVD, MD, VCR, TV, LD, CD, etc.). If your component(s) are listed in the "Preset Code List" on pages 58 to 65, simply recall the corresponding preset code.

Recalling preset codes (VSX-709RDS)

The following steps show you how to recall preset codes for each MULTI CONTROL button. Once the preset code is assigned, pressing the button will automatically set the remote control to operate the respective component.



- Refer to "Preset Code List" on pages 58 to 62 for the components and manufacturers available.
- Refer to "Controlling the Rest of Your System" on pages 52 to 55 for detailed explanations on how to operate your other components.

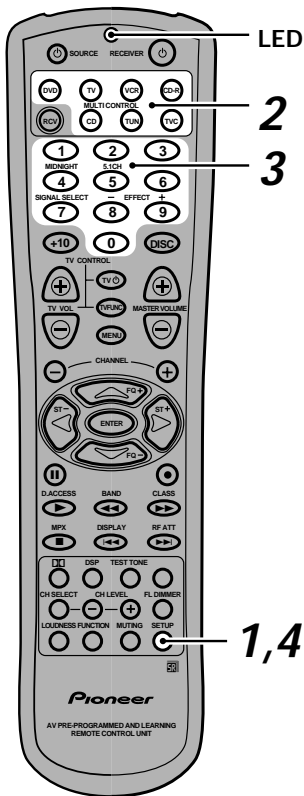

1 Press SETUP and hold for three seconds to select the preset mode.

The LED will blink twice.

(To cancel the preset mode)
Press SETUP.

2 Press the MULTI CONTROL button for the component you want to control.

Each button can be set to control one of the following components

- : DVD/LD player or DVD Recorder
- : TV, Satellite tuner or Cable TV tuner
- : CD player, CD-R, Tape deck or MD recorder
- : CD player, CD-R, Tape deck or MD recorder
- : VCR or DVR (DVD Recorder)
- : TV, Satellite tuner or Cable TV tuner
- : FM/AM tuner

3 Use the number buttons to enter the 4 digit preset code.

The LED will blink after each digit is input and will blink twice to confirm a valid code has been input.

If the LED shows one long blink it means an invalid code has been input. Check the preset code list and try again. If you are not able to input a preset code you can refer to page 24 to teach the remote control individual commands.

Repeat steps 1 through 3 to recall preset codes for as many components as necessary.

4 Press SETUP to exit the preset mode.

The remote control returns to the previous operation mode.

It will also return to the previous mode after ten seconds of inactivity.



- The RCV (Receiver) button cannot be preset.
- You can only input a code for the component type written on each MULTI CONTROL button. See page 27 for information on how to program a different type of component than specified on the button.
- If you recall a preset code for the tuner (TUN MULTI CONTROL), you will not be able to control the built-in tuner of this receiver using the remote control. To reset the remote control to the built-in tuner, input the preset code 0080.

Recalling preset codes (VSX-609RDS)

The following steps show you how to recall preset codes for each MULTI CONTROL button. Once the preset code is assigned, pressing the button will automatically set the remote control to operate the respective component.



- Refer to "Preset Code List" on pages 63 to 65 for the components and manufacturers available.
- Refer to "Controlling the Rest of Your System" on pages 52 to 55 for detailed explanations on how to operate your other components.

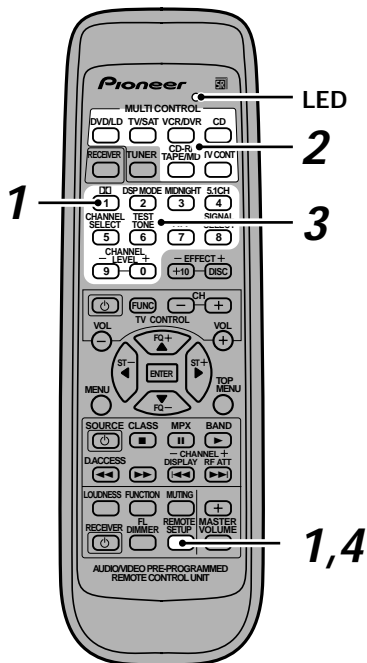

1 Press REMOTE SETUP and 1 at the same time to select the preset mode.

The LED on the remote control starts to blink.

(To cancel the preset mode at any time)
Press REMOTE SET UP.

2 Press the MULTI CONTROL button for the component you want to control.

Each button can be set to control one of the following components

DVD/LD	: DVD or LD player
TV/SAT	: TV or Satellite tuner
VCR/DVR	: VCR or DVR (DVD recorder)
CD	: CD player
CD-R/TAPE/MD	: CD Recorder or Tape deck or MD player
TV CONT	: TV or Cable TV tuner

The LED lights steadily.

3 Point the remote control toward the component to be controlled, enter the 3 digit preset code.

When you enter the preset code, the remote control emits a power ON/OFF signal. If the component turns ON or OFF, you have entered the proper code.

If the component does not turn ON or OFF and there is more than one preset code, try inputting another code (starting again from step 2).

Some manufacturers use several sets of remote control signals and the first code may not correspond to your component.

Repeat steps 2 through 3 to recall preset codes for as many components as necessary.

4 Press REMOTE SETUP to exit the preset mode.

The remote control returns to the previous operation mode.

- When operating a Pioneer DVD/LD player, set the preset code to "111" in the preset mode.
- TUNER cannot be preset.

Learning mode: Programming signals from other remote controls (VSX-709RDS only)

If preset codes are not available for your component(s), or the available preset codes do not operate correctly, you can use this function to program in signals from the remote control(s) of your other component(s). This operation can also be used after recalling a preset code to program additional operations not covered in the preset codes.

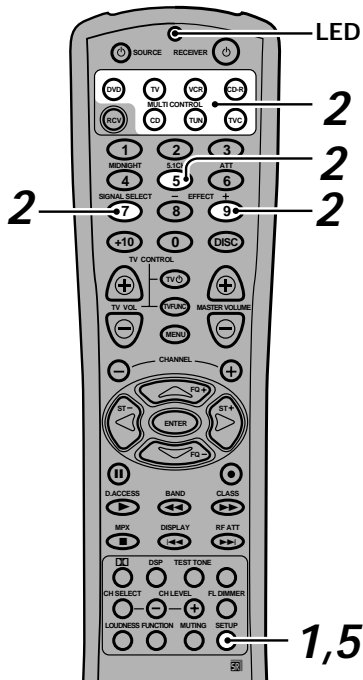

The highlighted buttons can learn new functions

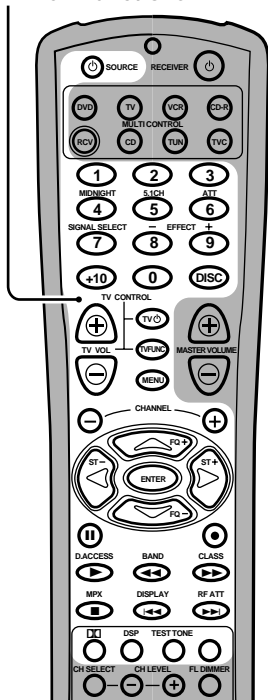

1 Press **SETUP** and hold for three seconds.

The LED will blink twice.

2 Press the **MULTI CONTROL** button for the component you want to control and then press **9, 7, 5** to select the Learning setup mode. The remote control is ready to learn new commands from other remote controls.

The LED flashes rapidly

To cancel Learning setup mode
Press **SETUP** button.

After ten seconds if no commands are entered the remote control will revert to its previous mode.

3 Press the button to be programmed (for example the **▶ [play]** button).

4 Point the remote controls at each other, about 2 – 5 cm apart, and press the button on the other remote control for the operation you want to program .

① Point the remote controls toward each other.

② Press the button on the other remote control corresponding to the operation you wish to program. The LED on this receiver's remote will go out and then blink twice when the operation is learned. Press the teaching button repeatedly, varying the distances between the remote, until you see this receiver's remote blink twice indicating the operation has been learned.

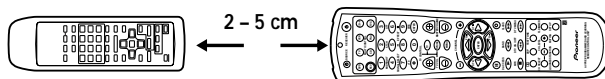

To program additional operations for the current component

Repeat steps 3 and 4.

To program operations for another component

Repeat steps 2 through 4.

5 Press **SETUP** to exit the Learning setup mode.

After ten seconds of inactivity the remote control will automatically leave the Learning mode and revert to its previous mode.



Some commands from other remote controls cannot be learned, but in most cases the remotes just need to be moved closer together or farther apart.

Clearing One of the Remote Control Settings (VSX-709RDS)

This method clears one of the buttons you have programmed and restores the factory installed preset to that button.

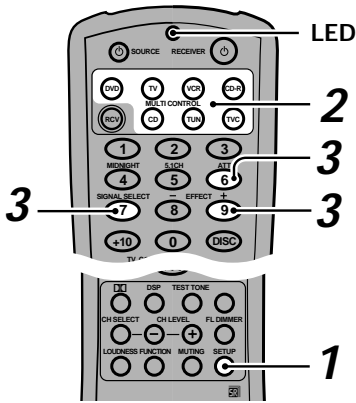

1 Press SETUP and hold for three seconds.

The LED will blink twice.

2 Press the MULTI CONTROL button relating to the button to be cleared.

3 Press 9, 7, 6.

4 Press the button to be cleared.

5 Press the button to be cleared once more.

The LED blinks twice to indicate the button has been cleared.

Clearing All the Remote Control Settings

VSX-709RDS

Clears all presets, all learnt functions and restores the factory presets.

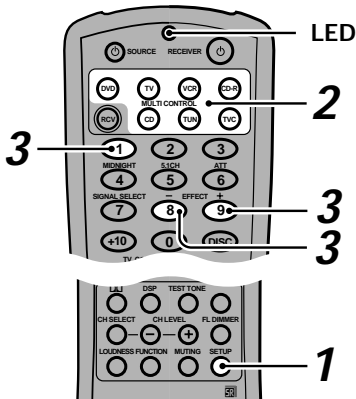

1 Press SETUP and hold for three seconds.

The LED will blink twice.

2 Press any MULTI CONTROL button.

3 Press 9, 8, 1.

The LED blinks in sets of twos twice (thus four times) to indicate the button has been cleared.

VSX-609RDS

Clears all presets and restores factory default settings.

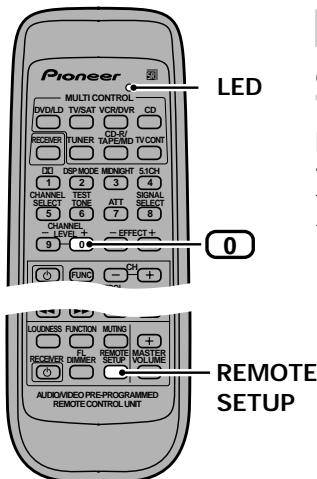

Press and hold REMOTE SETUP and 0 at the same time for more 3 seconds.

The LED display at the top of the remote control will blink. After blinking three times, all the settings will be canceled.

Direct Function

The Direct function is a useful feature which allows you to keep the receiver in one function (for example, CD) while putting the remote control in a different function. This could let you, for example, use the remote control to setup and listen to a CD on the receiver and then use the remote control to rewind a tape in your VCR while you continue to listen to your CD player.

When the Direct function is ON any MULTI CONTROL button you press will change the function of both the receiver and the remote control. When you turn the Direct function OFF, you can operate the remote control without affecting the receiver. Thus you could switch the remote control to the VCR and operate that component while the receiver plays a different component.

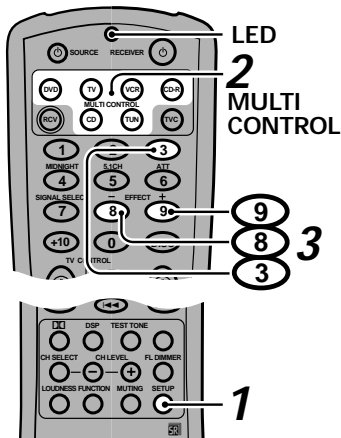

VSX-709RDS

To set a MULTI CONTROL button to Direct OFF:

- 1 Press **SETUP** and hold for three seconds.
The LED will blink twice.
- 2 Press the **MULTI CONTROL** button which you want to set to OFF.
- 3 Press **9, 8, 3**.
The LED blinks twice to indicate the button has been set.

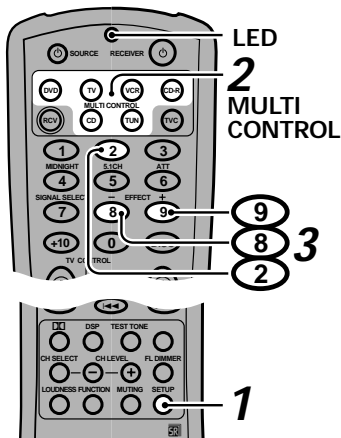

To set a MULTI CONTROL button to Direct ON:

- 1 Press **SETUP** and hold for three seconds.
The LED will blink twice.
- 2 Press the **MULTI CONTROL** button which you want to set to ON.
- 3 Press **9, 8, 2**.
The LED blinks twice to indicate the button has been set.



TVC doesn't have this feature and thus can't use the Direct function.

VSX-609RDS

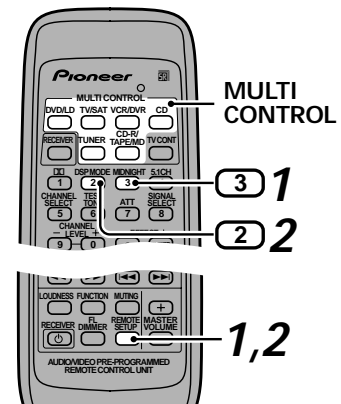

- 1 To turn the Direct function OFF (the default setting is ON), press **REMOTE SETUP** and number button **3** at the same time.

- 2 To turn the the Direct function ON (if you have turned it off), press **REMOTE SETUP** and number button **2** at the same time.



TV CONT doesn't have this feature and thus can't use the Direct function.

Programming a Different Component into a MULTI CONTROL Button (VSX-709RDS)

This feature changes a selected MULTI CONTROL button to a different component. For example, if you don't have a second TV, but you do have a second VCR, you could reassign the TV MULTI CONTROL to VCR so that VCR control buttons are available when you select TV.

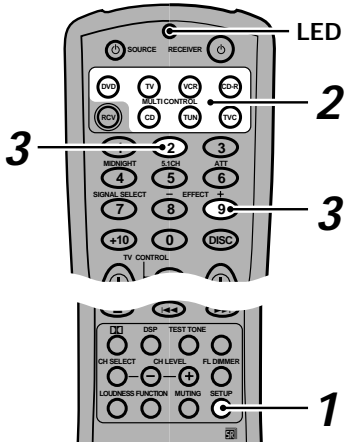

1 Press SETUP and hold for three seconds.

The LED will blink twice.

2 Press the MULTI CONTROL button which you want to change.

For the example above, press VCR.

3 Press 9, 9, 2.

4 Press the MULTI CONTROL button which you want to be duplicated.

In the above example, press TV. The LED will blink twice. The TV button will not now make the remote function as a VCR controller. Remember to assign the correct preset code for your equipment. The default is Pioneer equipment.

Checking Preset Code (VSX-709RDS)

To check which preset code is associated with a MULTI CONTROL button:

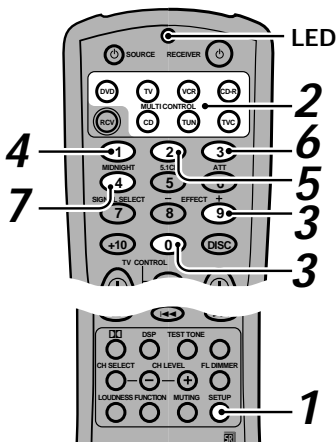

1 Press SETUP and hold for three seconds.

The LED on the remote control will blink twice.

2 Press the MULTI CONTROL button you want to check the preset code for.

3 Press 9, 9, 0.

Each preset code consists of four digits, for example 1329. Each digit will be represented by a series of blinks on the remote control's LED.

4 Press 1 to check to see the left-most digit.

In above example, the LED blinks once to see that the code of the left-most digit is "1".

5 Press 2.

In above example, the LED blinks three times.

6 Press 3.

In above example, the LED blinks twice.

7 Press 4 to check to see the right-most digit.

In above example, the LED blinks nine times.

Front Panel

This illustration shows the VSX-709RDS model.

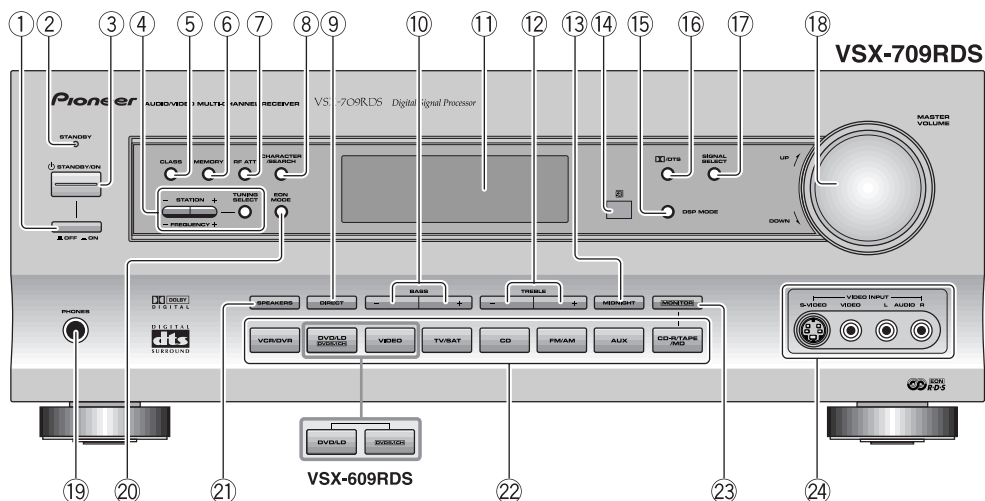

① **OFF/ ON (Main power) button**

If the button is OFF (■), the power of the receiver is shut off and the STANDBY/ON button (③) on the receiver or the remote control do not function. Pressing the button again will turn the receiver ON (☰) and the receiver enters the standby mode. In the standby mode, you can turn on the receiver using the STANDBY/ON button (③) on the receiver or the remote control.

② **STANDBY indicator**

Lights when the receiver is in standby mode (note that the receiver consumes a small amount of power (1 W) in standby mode).

③ **STANDBY/ON button**

Switches the receiver between on and standby (note that the receiver consumes a small amount of power (1 W) in standby mode).

④ **TUNING SELECT button**

Switches between station memory and frequency select modes.

STATION (+/-) buttons

Selects station memories when using the tuner.

FREQUENCY (+/-) buttons

Selects the frequency when using the tuner.

⑤ **CLASS button (see pages 44 – 46)**

Switches between the three banks (classes) of station memories.

⑥ **MEMORY button (see page 45)**

Press to memorize a station for recall using the STATION (+/-) buttons.

⑦ **RF ATT button (see p. 42)**

Use to lower the input level of a radio signal that is too powerful or contain interference thus causing the receiver to distort

⑧ **CHARACTER/SEARCH button (see p.45, 49)**

Use to search for different program types in RDS mode. It is also used to input station names.

⑨ **DIRECT button**

Use to switch Direct playback on or off. This mode bypasses the tone controls and channel levels for the most accurate reproduction of a program source.

⑩ **BASS (+/-) buttons**

Use to increase/decrease bass (within a range of - 6 dB to 6 dB in 2 dB steps).

⑪ **Display (see page 34)**

⑫ **TREBLE (+/-) buttons**

Use to increase/decrease treble (within a range of - 6 dB to 6 dB in 2 dB steps).

- ⑬ **MIDNIGHT button (see page 41)**
Use when listening to movie soundtracks at low volume. This feature will enable you to hear quiet sounds and not get jolted by loud or sudden sound effects.
- ⑭ **Remote sensor (SR)**
Receives the signals from the remote control.
- ⑮ **DSP MODE button (see page 39)**
Use to switch between the various DSP modes available (**HALL1, HALL 2, JAZZ, DANCE, THEATER1, THEATER 2**) and **DSP off**. Use to create different surround sound effects from any stereo source.
- ⑯ **Dolby /DTS button (see pages 38, 39)**
Use to switch between the various Dolby/DTS surround modes.
- ⑰ **SIGNAL SELECT button (see page 36)**
Use to select between an analog or digital signal.
- ⑱ **MASTER VOLUME**
Use to set the overall listening volume.
- ⑲ **PHONES jack**
Use to connect headphones but this does not switch the speakers off.
- ⑳ **EON MODE button (see p. 50)**
Use to search for different programs that are transmitting traffic or news information (this search method is called EON).
- ㉑ **SPEAKERS button**
Use to switch the speaker system A → B → A+B → off.
- ㉒ **Function buttons**
Use to select a source for playback or recording.
- ㉓ **MONITOR button**
Press to switch tape monitoring on/off.
- ㉔ **VIDEO INPUT jacks (VSX-709RDS only)**
Connect a video camera, video game system, etc. to the VIDEO INPUT jacks (refer to page 8).

Remote Control (VSX-709RDS)

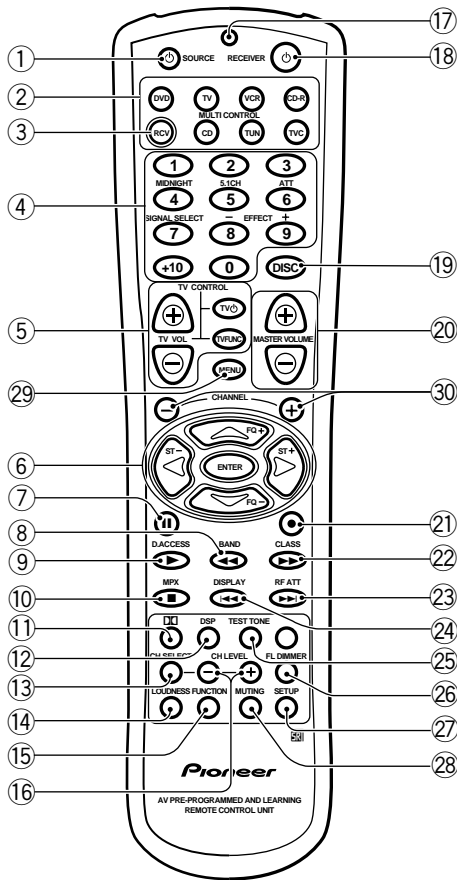

- ① **SOURCE** button
Use to turn on/off other components connected to the receiver.
- ② **MULTI CONTROL** buttons
Use to put the receiver/remote control in the stated mode.
For other equipment controls, see Controlling the Rest of Your System on pages 52 – 55.
- ③ **RCV** button (see page 15)
Use this button when setting up the surround sound for the receiver.
- ④ **Number/Mode** buttons (see pages 22, 43)
Use the number buttons to select the radio frequency in tuner Direct access mode or the tracks in CD, DVD mode etc.

Also, buttons marked with the following names have special functions. If you try to use one of these functions but the display flashes it means that function cannot be used in the current mode (for example DSP modes cannot be used when 5.1 CH setting is on).

MIDNIGHT (see page 41)

Use to put receiver in Midnight mode. To use first press the RCV button then operate this button.

5.1 CH (see page 40)

When the DVD/LD or DVD 5.1 CH function is selected each press switches the DVD/LD input between DVD/LD and DVD 5.1 CH. To use first press the RCV button then operate this button.

ATT

Use to attenuate (lower) the level of an analog input signal and prevent distortion (refer to p.34 (14), (15)). To use first press the RCV button then operate this button.

SIGNAL SELECT (see page 36)

Use to select the proper signal (analog, digital) for the source you are inputting. To use first press the RCV button then operate this button.

EFFECT +/- buttons

Use to adjust the amount of effect in different DSP sound modes or advanced listening modes. To use, first press the RCV button then operate this button.

⑤ **TV CONTROL** buttons

The following five sets of buttons are dedicated TV controls.

TV VOL +/- buttons

Use to adjust the volume on your TV.

TV button

Use to turn on the power of the TV.

TV FUNC button

Use select the TV function.

⑥ **◀▶ ▲▼ (FQ +/-, ST +/-) & ENTER** buttons (see pages 15 – 20, 42)

Use these arrow buttons when setting up your surround sound system (see pages 15 – 20). These buttons are also used to control DVD menus/options. The FQ +/- buttons can be used to find radio frequencies. The ST +/- buttons can be used to select the stations of memorized radio frequencies.

⑦ **||** button

Use to pause other components.

⑧ **◀◀** button (BAND)

Use to fast reverse search on CD etc. Also use to switch between the AM and FM band when in TUNER mode.

⑨ **▶▶** button (D. ACCESS)

Use to play other components. Also use to directly access a radio station by pressing the number of the station you want.

10 ■ button (MPX)

Use to stop other components. Also use to switch between auto stereo and mono reception of FM broadcasts. If the signal is weak then switching to MONO will improve the sound quality.

11 ■ button

Use to put receiver in Dolby Digital, Dolby Surround and DTS modes. To use first press the RCV button then operate this button.

12 DSP button

Use to put receiver in one of the DSP modes. To use first press the RCV button then operate this button.

13 CH SELECT

Use to select a speaker when setting up the surround sound of the receiver. To use, first press the RCV button, then operate this button.

14 LOUDNESS button

Use to switch on the loudness. This feature is useful for getting good bass and treble sounds listening at low volumes.

15 FUNCTION button

Use to select the playback or recording source. This button lets you cycle through the different functions of the receiver in the following order: CD, tuner (FM/AM), AUX, CD-R/TAPE/MD, VCR/DVR, DVD/LD, VIDEO and TV/SAT.

16 CH LEVEL +/- buttons

Use to adjust the output level of the selected channel(s).

17 LED display

This display flashes when a command is sent from the remote control to the receiver. It also flashes at other times, for example, when teaching the receiver preset codes.

18 RECEIVER  button

This switches the receiver between STANDBY mode and power ON.

19 DISC button

Only used when controlling other components.

20 MASTER VOLUME +/- buttons

Use to set the overall listening volume.

21 ● button

Use to record with other components.

22 ►► button (CLASS)

Use to fast forward search on CDs etc. Also use the CLASS feature to switch between the three banks (classes) of station memories.

23 ►►| button (RF ATT)

Use to skip forward tracks on CD players etc. Also use to lower the input level of a radio signal.

24 |◀◀ button (DISPLAY)

Use to skip backward tracks on CD players etc. Also use to display the RDS information.

25 TEST TONE

Use to sound the TEST TONE when setting up the surround sound of the receiver. To use, first press the RCV button, then operate this button.

26 FL DIMMER button

Use to make the fluorescent display (FL) dimmer or brighter. There are three brightness settings as well as an off setting.

27 SETUP button (see p.22, 24)

Use this button when setting up the remote control to control other components.

28 MUTING button

Use to mute the sound or restore the sound if it has been muted.

29 MENU button

Use to access different menus associated with your DVD player.

30 CHANNEL +/- buttons

Use to change channels on your TV.

Remote Control (VSX-609RDS)

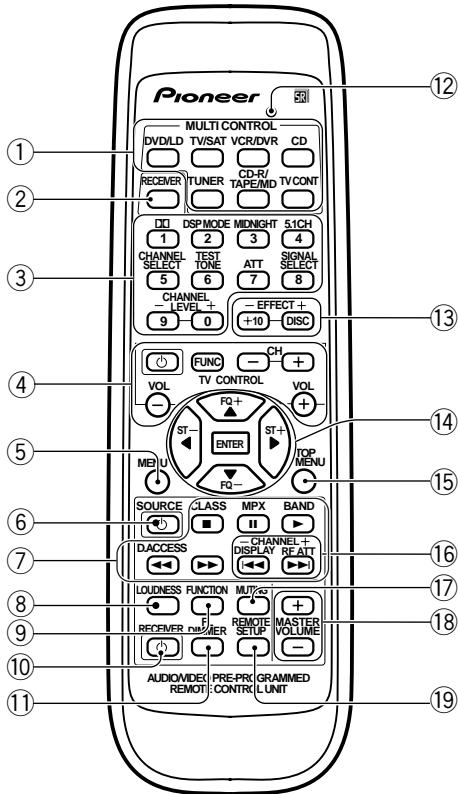

1 MULTI CONTROL buttons

Use to put the receiver/remote control in the stated mode.
For other equipment controls, see Controlling the Rest of Your System on pages 52 – 55.

2 RECEIVER button (see page 15)

Use this button when setting up the surround sound for the receiver.

3 Number/Mode buttons (see pages 22, 43)

Use the number buttons to select the radio frequency in tuner Direct access mode or the tracks in CD, DVD mode etc.

Also, buttons marked with the following names have special functions. If you try to use one of these functions but the display flashes it means that function cannot be used in the current mode (for example DSP modes cannot be used when 5.1 CH setting is on).

DD (see pages 38, 39)

Use to put receiver in Dolby Digital, Dolby Surround and DTS modes. To use first press the RECEIVER button then operate this button.

DSP MODE (see pages 39)

Use to put receiver in one of the DSP modes. To use first press the RECEIVER button then operate this button.

MIDNIGHT (see page 41)

Use to put receiver in Midnight mode. To use, first press the RECEIVER button, then operate this button.

5.1 CH (see page 40)

When the DVD/LD or DVD 5.1 CH function is selected each press switches the DVD/LD input between DVD/LD and DVD 5.1 CH. To use, first press the RECEIVER button, then operate this button.

CHANNEL SELECT (see page 21)

Use to select a speaker when setting up the surround sound of the receiver. To use, first press the RECEIVER button, then operate this button.

TEST TONE (see page 21)

Use to sound the TEST TONE when setting up the surround sound of the receiver. To use, first press the RECEIVER button, then operate this button.

ATT

Use to attenuate (lower) the level of an analog input signal and prevent distortion (refer to p.34 (14), (15)). To use, first press the RECEIVER button, then operate this button.

CHANNEL LEVEL +/- (see page 21)

Use to set up the levels of the surround sound of the receiver. To use, first press the RECEIVER button, then operate this button.

SIGNAL SELECT (see page 36)

Use to select the proper signal (analog, digital) for the source you are inputting. To use, first press the RECEIVER button, then operate this button.

4 TV CONTROL buttons

The following four sets of buttons are dedicated TV controls.

FUNC button

Use to select the TV function.

Power button

Use to turn on the power of the TV.

CH +/- buttons

Use to change channels on your TV.

VOL +/- buttons

Use to adjust the volume on your TV.

5 MENU button

Use to access different menus associated with your DVD player.

⑥ SOURCE \odot button

Use to turn on/off other components connected to the receiver.

⑦ The following buttons are both controls for other components (like a DVD player) and dedicated tuner controls. The tuner controls are explained here. You can use them after you have pushed the TUNER MULTI CONTROL button.

CLASS button (see pages 44, 46)

Use to switch between the three banks (classes) of station memories.

MPX button (see page 42)

Use to switch between auto stereo and mono reception of FM broadcasts. If the signal is weak then switching to MONO will improve the sound quality. Also, this is the pause button for CDs, tapes, DVDs, etc.

BAND button (see pages 42, 43)

Use to switch between the AM and FM band when in TUNER mode.

D. ACCESS button (see page 43)

Use to directly access a radio station by pressing the number of the station you want.

⑧ LOUDNESS button

Use to switch on the loudness. This feature is useful for getting good bass and treble sounds listening at low volumes.

⑨ FUNCTION button

Use to select the playback or recording source. This button lets you cycle through the different functions of the receiver in the following order: CD, tuner (FM/AM), AUX, CDR/TAPE/MD, VCR/DVR, DVD/LD, DVD 5.1 CH., and TV/SAT.

⑩ RECEIVER \odot button

This switches the receiver between STANDBY mode and power ON.

⑪ FL DIMMER button

Use this button to make the fluorescent display (FL) dimmer or brighter. There are three brightness settings as well as an off setting.

⑫ LED display (see pages 23, 25)

This display flashes when a command is sent from the remote control to the receiver. It also flashes at other times, for example when teaching the receiver preset codes.

⑬ EFFECT +/- buttons (see page 39)

Use to adjust the amount of effect in different DSP sound modes or advanced listening modes.

⑭ \blacktriangleleft \blacktriangleright \blacktriangleup \blacktriangledown (FQ +/-, ST +/-) & ENTER buttons (see pages 15 – 20, 42)

Use these arrow buttons when setting up your surround sound system (see pages 15 – 20). These buttons are also used to control DVD menus/options and for deck 1 of a double cassette deck player. The FQ +/- buttons can be used to find radio frequencies. The ST +/- buttons can be used to select the stations of memorized radio frequencies.

⑮ TOP MENU button

In DVD mode this button brings you to the top or most fundamental menu.

⑯ CHANNEL +/- buttons (\blacktriangleleft /DISPLAY, \blacktriangleright /RF ATT)

Use to select the stations of memorized radio frequencies. Also use to skip tracks backward or forward on CDs, DVDs, etc. Also use to display the RDS information (DISPLAY) and use to lower the input level of a radio signal (RF ATT).

⑰ MUTING button

Use to mute the sound or restore the sound if it has been muted.

⑱ MASTER VOLUME +/- buttons

Use to set the overall listening volume.

⑲ REMOTE SETUP button (see page 23)

Use this button when setting up the remote control to control other components.

Display

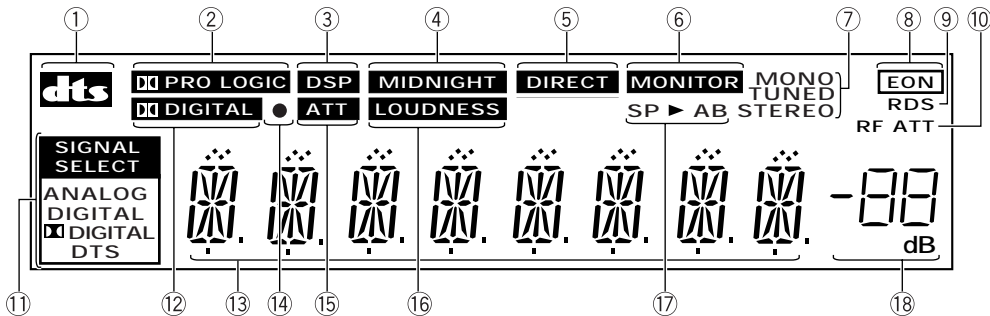

- ① **DTS indicator**
Lights when DTS mode is being used.
- ② **PRO LOGIC indicator**
When the **PRO LOGIC** (Dolby)/DTS mode of the receiver is on, this lights to indicate playback of a two channel source.
- ③ **DSP indicator**
Lights when any Advanced Theater or DSP mode is selected.
- ④ **MIDNIGHT indicator**
Lights when Midnight listening mode is in use.
- ⑤ **DIRECT indicator**
Lights when Direct playback is ON. This function bypasses all tone, balance, DSP and Dolby Surround effects.
- ⑥ **MONITOR indicator**
Lights when **MONITOR** is selected to hear a recording as it's being made (see page 51).
- ⑦ **Tuner indicators**
MONO:
Lights when the mono mode is set using the MPX button.
TUNED:
Lights when a broadcast is being received.
STEREO:
Lights when a stereo FM broadcast is being received in Auto stereo mode.
- ⑧ **EON indicator**
The box around EON indicator lights to inform you that the currently tuned station carries the EON data service. When the EON mode is set, the EON indicator lights, but during actual reception of an EON broadcast the EON indicator will flash. An empty box in the EON indicator spot means it is possible to pick up an EON broadcast but the receiver has not been set to do so (this will only appear when RDS is switched on).
- ⑨ **RDS indicator**
Lights when an RDS broadcast is received.
- ⑩ **RF ATT indicator**
Lights when the RF ATT is on (see p. 42).
- ⑪ **SIGNAL SELECT indicators**
Light to indicate the type of input signal assigned for the current component (see "Front Panel", 17, SIGNAL SELECT).
ANALOG : Lights when an analog signal is selected.
DIGITAL : Lights when a digital audio signal is selected.
PRO LOGIC : Lights when a Dolby Digital signal is played.
DTS: Lights when a source with DTS audio signals is played.
- ⑫ **DIGITAL indicator**
When the **PRO LOGIC** (Dolby)/DTS mode of the receiver is on, this lights to indicate playback of a Dolby Digital signal. However **PRO LOGIC** lights during 2 channel playback of Dolby Digital.
- ⑬ **Character display**
Shows the radio frequency or function (DVD/LD, CD, etc.) receiver is using .
- ⑭ **(Overload) indicator**
This lights when an analog signal is too strong (the SIGNAL SELECT needs to be on ANALOG). It indicates the sound is distorting and the signal should be reduced.
- ⑮ **ATT indicator**
Lights when ATT is used to attenuate (reduce) the level of the input signal (can only be used in ANALOG mode).
- ⑯ **LOUDNESS indicator**
Lights when the LOUDNESS, used to boost the bass and treble in quiet listening, is on.
- ⑰ **SP ► AB (Speakers) indicator**
Shows if the speaker system is on or not. **SP ► A** and/or **B** means speakers are switched on. **SP ►** means speakers are switched off.
- ⑱ **Master volume level display**
Shows the overall volume level. Volume level is maintained even when the power is off.
-- dB indicates the minimum level, and 0 dB indicates the maximum level.
• Depending on the level settings you make for individual channels, the MAX level can range between -10 dB and 0 dB.

Learning About the Sound Modes

The sound modes are explained here.

There are two cinema modes: STANDARD, and ADVANCED THEATER. These are designed to be used with multi channel surround sound audio/visual sources (like DVDs and LDs). Intrinsic to home theater, these modes can deliver realistic and powerful surround sound that recreates the movie theater experience. You may need to experiment with them to see which settings suit your home system and personal tastes. The DSP and STEREO modes are designed to be used with music sources but some DSP modes are also suited for film soundtracks. Again, try different settings with various soundtracks to see which you like.



STANDARD mode

This mode is for pure decoding of Dolby Digital, DTS and Dolby Surround. No special effects are added. It is good for enjoying movies that have been recorded in Dolby Digital, DTS or Dolby Surround.

You can identify Dolby Digital software by the  or  marks. Most Dolby Surround software is marked , but unmarked software may also incorporate Dolby Surround.

ADVANCED THEATER modes

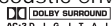

MUSICAL

Simulates the acoustic environment of a large concert hall and is suitable for music on musical sources marked  () or .

DRAMA

Simulates the relaxed environment of a classic medium size movie theater, and is suitable for watching dramas on sources marked  () or .

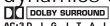
ACTION

Simulates the acoustic environment of a modern large movie theater. You can enjoy the power and dynamics of motion picture audio which is suitable for action movies on sources marked ,  or .

EXPANDED

This mode is especially designed to give sound depth to stereo sources. The overall effect builds a dynamic and broad sound space, allowing two-channel (stereo) signals to faithfully imitate a five speaker sound. Use with Dolby Pro Logic for a stereo surround effect. You can also use with Dolby Digital sources for a wider stereo field than STANDARD mode.

DSP modes

The DSP (Digital Signal Processing) modes allow you to transform your living room into a variety of different sonic environments when playing standard (two-channel) stereo sources, Dolby Surround sources, and Dolby Digital sources. If you try to add this effect to functions which cannot use it "SP off" flashes in the display.

HALL 1

Simulates the acoustic environment of a large concert hall of wooden construction. Complex delay of reflected sounds coupled with reverberation effects create a dynamic and beautiful sound characteristic of an orchestra performing in a concert hall, making it suitable for classical music.

HALL 2

Simulates the acoustic environment of a concert hall with stone walls. The rich reverberations and natural fullness of the sound create the auditory impression of being in a concert hall, making it suitable for classical music.

JAZZ

Simulates the acoustic environment of a jazz club. Less delay on the reflected sounds emphasizes the sensation of hearing a live band.

DANCE

Simulates the acoustic environment and strong bass sound of a nightclub with a square dance floor. A short delay on the reflected sounds emphasizes the raw power of the dance music.

THEATER 1

Adjusts the delay of the reflected sound to simulate the acoustic environment of a medium sized movie theater.

THEATER 2

Simulates the acoustic environment of a theater while maintaining proper localization of each channel.

Switching ANALOG/DIGITAL Signal Input

When you select a function (for example, CD) that is only hooked up by a digital connection, then the ANALOG/DIGITAL signal input switch will automatically choose digital. If you have that function hooked up by both digital and analog connections this switch lets you choose which to listen to.

VSX-709RDS

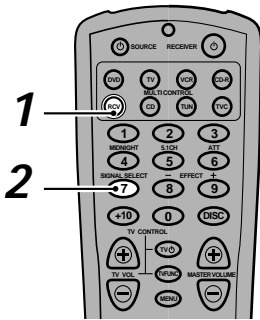

1 Press RCV (VSX-709RDS) or RECEIVER (VSX-609RDS).

This switches the remote control to the surround setup mode.

2 Press SIGNAL SELECT to select the input signal corresponding to the source component.

Each press switches between ANALOG and DIGITAL signal selection.

3 While SIGNAL SELECT is set to DIGITAL, DIGITAL lights when a Dolby Digital signal is input, DTS lights when a DTS signal is input.

VSX-609RDS

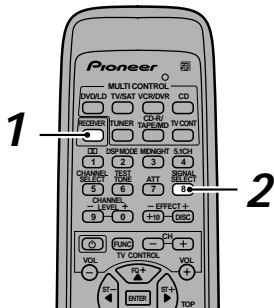

Each press switches between ANALOG and DIGITAL signal selection.

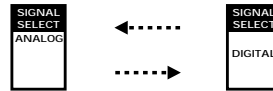

When a Dolby Digital signal is input.

When a DTS signal is input.

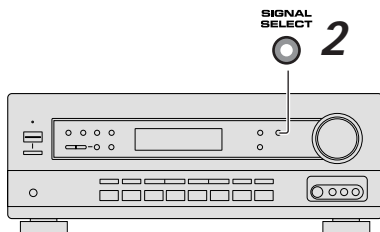

- SIGNAL SELECT is fixed in the "ANALOG" position for components not assigned to one of the two digital input jacks.
- This receiver can only play back Dolby Digital, PCM (32kHz, 44kHz, and 48kHz), DTS, digital signal formats. With digital signal formats other than these, set SIGNAL SELECT to "ANALOG".
- When an LD or CD player compatible with DTS is played back with SIGNAL SELECT set in "ANALOG", digital noise is output caused by playing back the DTS directly (no decoding). To prevent noise, you need to make digital connections (Refer to page 9) and set SIGNAL SELECT to "DIGITAL".
- Some DVD players don't output DTS signals. For more details, refer to the instruction manual supplied with your DVD player.

Before operating the receiver, be sure to press the main power button on the front panel to turn the power ON (➔).

Playing a Source

VSX-709RDS

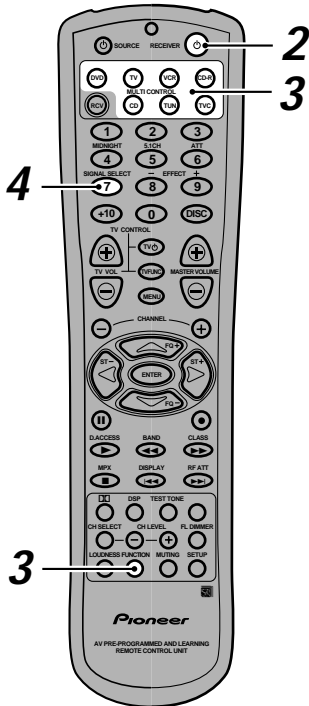

1 Turn on the power of the playback component.

2 Press RECEIVER to turn on the power of the receiver.

Be sure that the standby indicator turns off on the front panel.

3 Press a MULTI CONTROL button or the FUNCTION button to select the source you want to playback.

If the Direct function is OFF you have to use the FUNCTION button to select the source (see p.26).

4 If necessary, press SIGNAL SELECT to select the input signal corresponding to the source component (as above).

5 Start playback of the component you selected in step 1.

VSX-609RDS

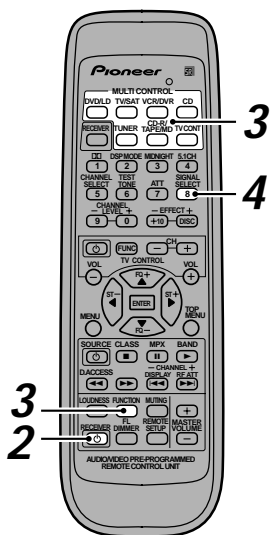

Before operating the receiver, be sure to press the main power button on the front panel to turn the power ON (⏻).

Playing Sources with Dolby Digital or DTS Sound

VSX-709RDS

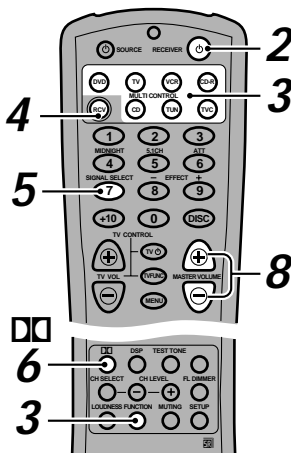

VSX-609RDS

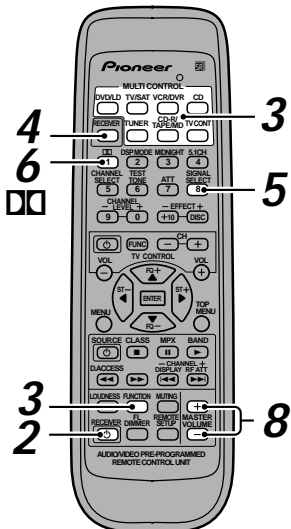

1 Turn on the power of the playback component.

2 Press **RECEIVER** to turn on the power of the receiver.

Be sure that the standby indicator turns off on the front panel.

3 Press a **MULTI CONTROL** button or the **FUNCTION** button to select the source you want to playback.

If the Direct function is OFF you have to use the FUNCTION button to select the source (see p.26).

4 Press **RCV (VSX-709RDS)** or **RECEIVER (VSX-609RDS)**.

This set the remote control to select the sound mode.

5 Press **SIGNAL SELECT** to select **DIGITAL**.

(Refer to "Switching ANALOG/DIGITAL Signal Input" on page 36.)

6 Press to switch the Dolby Digital/DTS mode on.

7 Start playback of the component you selected in step 1.

8 Press **MASTER VOLUME (+/-)** to adjust the volume level.



- When an LD or CD player compatible with DTS is played back with SIGNAL SELECT set in "ANALOG", digital noise is output caused by playing back the DTS directly (no decoding). To prevent noise, you need to make digital connections (Refer to page 9) and set SIGNAL SELECT to "DIGITAL".

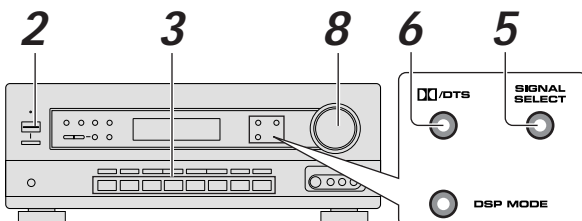

When playing LD recorded in Dolby Digital

When connecting a DVD/LD player or LD player using the RF output, a commercially available RF demodulator (RFD-1) is required. The RF demodulator changes the RF signal to a digital signal which is then processed by the receiver at the digital input jacks. For more details, refer to the instruction manual supplied with the RFD-1.

Selecting a Sound Mode

To ensure the best possible surround sound, be sure to complete the set up procedures described in "Setting Up for Surround Sound" (starting on page 15) before using the sound modes. This is particularly important when using the **DD** (Dolby)/DTS mode.

Surround operation

VSX-709RDS

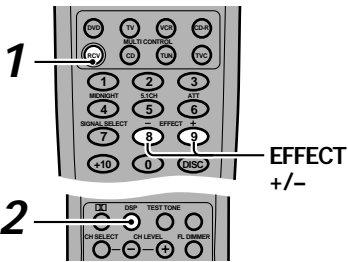

1 Press RCV (VSX-709RDS) or RECEIVER (VSX-609RDS).

This sets the remote control to select the sound mode. (You can skip this step when using the controls on the receiver.)

2 Press DSP MODE to select the sound mode.

Each press changes the DSP mode as follows:

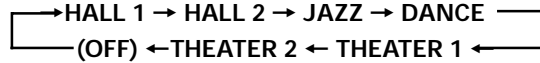

VSX-609RDS

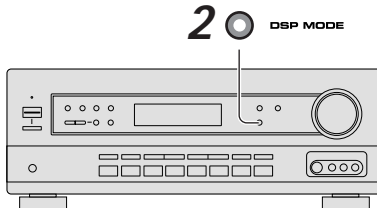
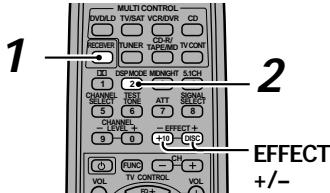

The amount of effect for each DSP mode can be adjusted in the range of 10 to 90 (the default setting value is 70) by pressing EFFECT +/-.

ADVANCED THEATER mode (Dolby/DTS mode)

Switch on the Dolby/DTS mode by pressing the **DD** surround button. When Dolby/DTS mode is ON, Dolby Pro Logic, Dolby Digital and DTS, and signal processing is performed automatically corresponding to the input signal. Use this button to cycle through the various modes. For all modes other than STANDARD, DSP is switched on and will appear in the display.

VSX-709RDS

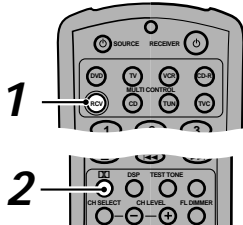

1 Press RCV (VSX-709RDS) or RECEIVER (VSX-609RDS).

This sets the remote control to select the sound mode. (You can skip this step when using the controls on the receiver.)

2 Switch the Dolby/DTS mode on and off by pressing **DD on the remote control or **DD**/DTS on the front panel.**

Each press changes the display as follows.



Refer to page 35 for more details about each surround effect.



The effects of Dolby/DTS mode can be adjusted in the range of 10 to 90 by pressing EFFECT +/- (the default setting is 70). Also, the effect level can be set in each Dolby/DTS mode by pressing the EFFECT +/- button. The STANDARD mode cannot be changed.

VSX-609RDS

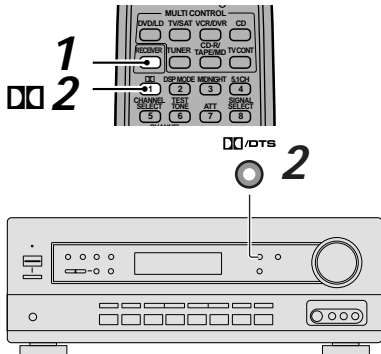

Operation

DVD 5.1 CH input playback (VSX-709RDS)

Connect a component with 5.1 channel output to use the surround sound created by 5.1 channel playback.

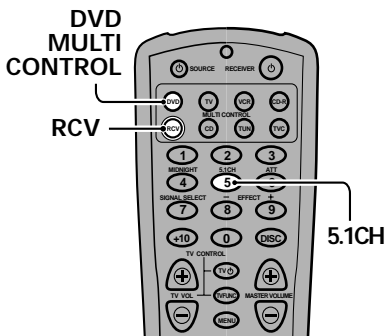

There are two ways to switch on DVD 5.1 CH mode. With the remote control press the DVD MULTI CONTROL button. Then press the RCV button and number button 5 (5.1CH). On the main unit simply press the DVD/LD button.

Press number button 5 (5.1CH) on the remote to go back to the DVD normal mode. To exit this mode using the main unit simply press another function button (DVD/LD, etc.).

Each press switches the input: DVD/LD ↔ DVD 5.1ch

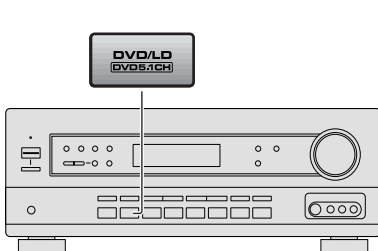

- When 5.1CH input is selected, Dolby/DTS mode, DSP mode, SIGNAL SELECT, ATT, DIRECT, TONE, MID-NIGHT mode, LOUDNESS and speakers B cannot be operated.
- When 5.1CH input is selected, only the volume level and channel levels can be set.

DVD 5.1 CH input playback (VSX-609RDS)

Connect a DVD player with 5.1 channel output to use the surround sound created by 5.1 channel playback.

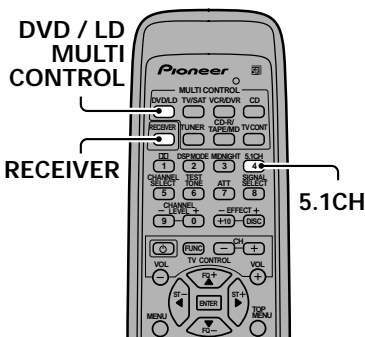

There are two ways to switch on DVD 5.1 CH mode. With the remote control press the DVD / LD MULTI CONTROL button. Then press the RECEIVER button and number button 4 (5.1CH). On the main unit simply press the DVD 5.1CH button.

Press number button 4 (5.1CH) on the remote control to go back to the DVD/LD normal mode. To exit this mode using the main unit simply press another function button (DVD/LD, etc.).

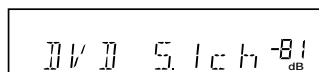
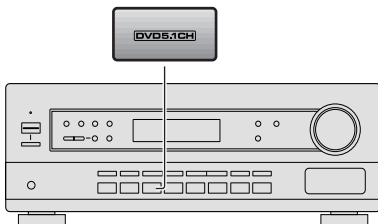

- When 5.1CH input is selected, Dolby/DTS mode, DSP mode, SIGNAL SELECT, ATT, DIRECT, TONE, MID-NIGHT mode, LOUDNESS cannot be operated.
- When 5.1CH input is selected, only the volume level and channel levels can be set.

Using in MIDNIGHT Listening Mode

When the volume is low, surround effects tend to become less than satisfactory. Turn the MIDNIGHT listening mode on to enjoy the effects of quality surround sound even at low volumes. This mode allows you to hear effective surround sound of movies at low volume levels.

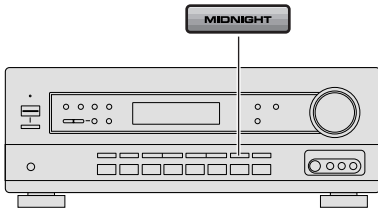

Press MIDNIGHT.

Each press switches MIDNIGHT listening mode on or off.



The effect automatically adjusts according to the volume level.

Finding a Station

The following steps show you how to tune in to FM and AM radio broadcasts using the automatic (search) and manual (step) tuning functions. If you already know the exact frequency of the station you want to listen to, see Tuning Directly to a Station on the following page. Once you are tuned to a station you can memorize the frequency for recall later—see Memorizing Stations on page 44 for more on how to do this.

VSX-709RDS

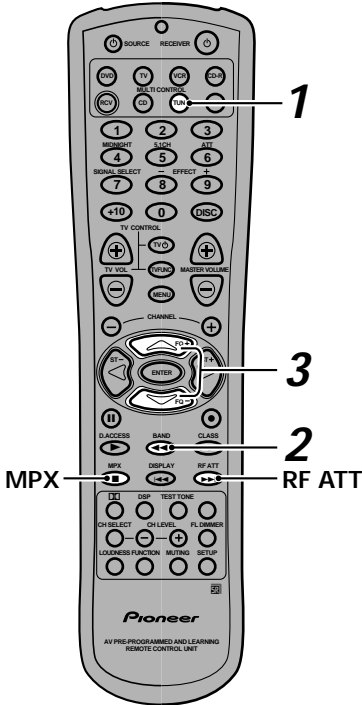

1 Press the **MULTI CONTROL TUN (TUNER)** button.

On the receiver, press the **FM/AM** button to select the tuner mode.

2 Use the **BAND** button to change the band (FM or AM), if necessary.

Each press switches the band between FM and AM (on the front panel use the **FM/AM** button).

3 Tune to a station.

Automatic tuning

To search for stations in the currently selected band, press and hold either the **FQ +** or **FQ -** button for about a second. The receiver will start searching for the next station, stopping when it has found one. Repeat this step to search for other stations.

Manual tuning

To change the frequency one step at a time, press the **FQ + / FQ -** buttons.

High speed tuning

Press and hold the **FQ +** or **FQ -** button for high speed tuning, releasing the button once the desired frequency is reached.

MPX mode

If the **TUNED** or **STEREO** indicator doesn't light when tuning to an FM station because the signal is weak, press the **MPX** button to switch the receiver into mono reception mode. This should improve the sound quality and allow you to enjoy the broadcast.

RF ATT mode

If the radio signal is too strong and/or the sound is distorting, press the **RF ATT** button to attenuate (lower) the radio signal input and reduce the distortion.

VSX-609RDS

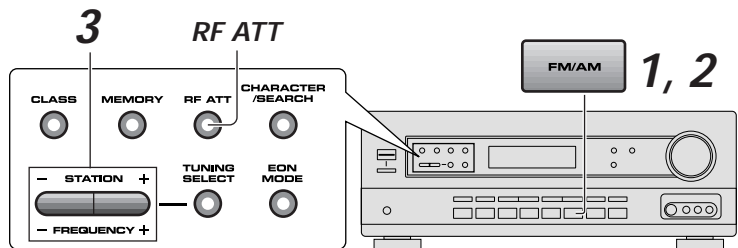
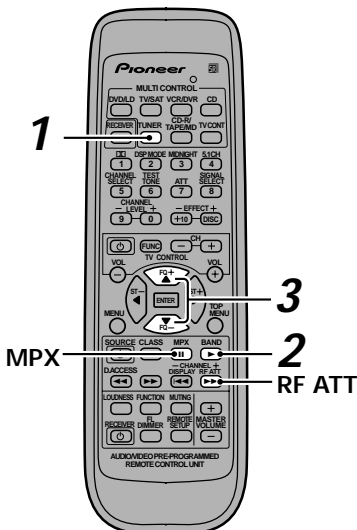

Tuning Directly to a Station

Sometimes, you'll already know the frequency of the station you want to listen to. In this case, you can simply enter the frequency directly using the number buttons on the remote control (this function is not available using the front panel controls of the receiver).

VSX-709RDS

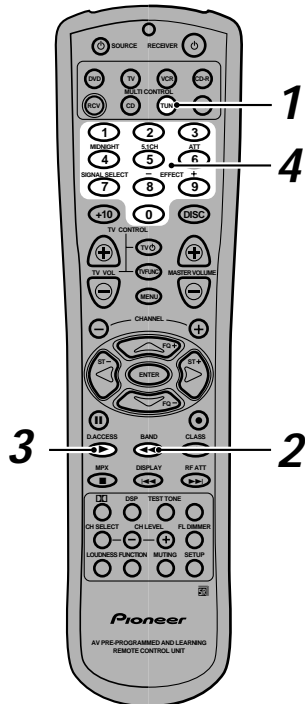

1 Press the MULTI CONTROL TUN (TUNER) button.

2 Press the BAND button to select either FM or AM.

Each press switches the band between FM and AM.

3 Press D. ACCESS (Direct Access).

4 Use the number buttons to enter the frequency of the radio station.

Example:

To tune to 106.00 (FM), press **1 - 0 - 6 - 0 - 0**

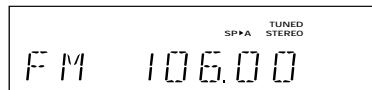

If you make a mistake while inputting the frequency, press the **D.ACCESS** button twice to cancel the frequency and start again.

VSX-609RDS

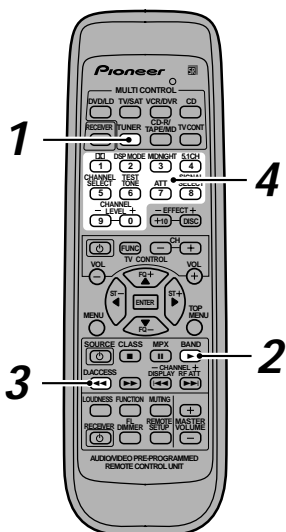

Memorizing Stations (front panel only)

If you often listen to a particular radio station, it's convenient to have the receiver store the frequency for easy recall whenever you want to listen to that station. This saves the effort of manually tuning in each time. The receiver can memorize up to 30 stations, stored in three banks, or classes (A,B and C) of 10 presets each. When memorizing FM frequencies, the receiver also stores the MPX setting (auto stereo or mono), and RF ATT settings. The process for memorizing stations is only possible from the controls on the front panel of the receiver.

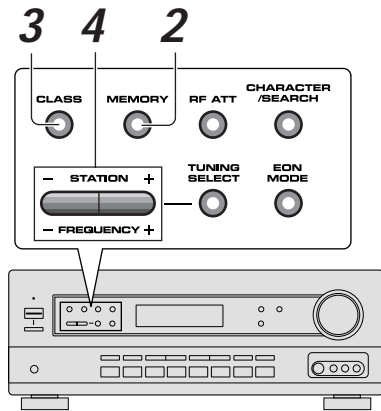

1 Tune to a station you want to memorize.

See "Finding a Station" and "Tuning Directly to a Station" on pages 42 and 43 for more on how to do this.

2 Press MEMORY.

The display shows a blinking memory class.

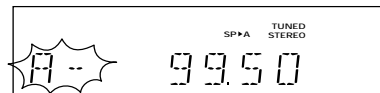

3 Press CLASS to select one of the three classes.

Repeatedly pressing this button cycles through the three available classes, A, B and C.

4 Press STATION +/- to choose the preset memory number.

Pressing these buttons repeatedly cycles through the 10 available preset memories in each class.

After choosing the location you want, the preset class and number blink for about 5 seconds and the receiver stores the station.

Repeat steps 1 to 4 to memorize up to 30 stations.

Character display used for station name input:

Character	A	B	C	D	E	F	G	H	I	J	K	L	M	N	O
Display indications	A	B	C	D	E	F	G	H	I	J	K	L	M	N	O
Character	P	Q	R	S	T	U	V	W	X	Y	Z	[\]	_
Display indications	P	Q	R	S	T	U	V	W	X	Y	Z	[\]	_
Character	!	0	1	2	3	4	5	6	7	8	9	"	%	&	'
Display indications	!	0	1	2	3	4	5	6	7	8	9	"	%	&	'
Character	()	*	+	,	-	.	/	:	=	?	@			
Display indications	()	*	+	,	-	.	/	:	=	?	@			

Naming Memorized Stations (front panel only)

You can input a name of up to four characters for each preset station in the receiver's memory (see the previous page). This name can be anything you choose. For example, you could input "BBC1" for that station and when you listen to it the name, rather than the frequency number, will appear on your display.

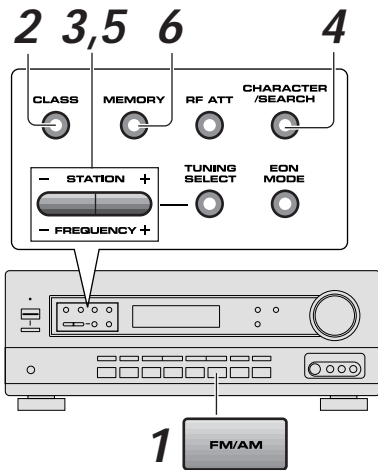

1 Press FM/AM to set the tuner function.

2 Press CLASS repeatedly to select the class.

Repeatedly pressing this button cycles through the three available classes, A, B and C.

3 Press STATION (+/-) to select the preset channel.

4 Press CHARACTER/SEARCH to select the character input mode.

5 Press STATION (+/-) to choose the first character.

The STATION +/- buttons scroll through the letters, numbers and symbols you can input. Refer to "Character display used station name input" on page 44.



6 Press MEMORY to input the first of the four characters.

That character appears in the display and the cursor automatically moves to the next space. After four characters have been entered, the character input mode is exited.

Repeat steps 2 to 6 to memorize up to 30 preset broadcast station names.



To erase or change the station name

Perform the procedures of "Naming Memorized Stations" and enter four spaces to erase the memorized station name. When you want to change a memorized station name, input the new station name using the same procedure.

Recalling Memorized Stations

Having memorized up to 30 stations (see the previous page for how to do this), you can quickly recall one of these stations.

VSX-709RDS

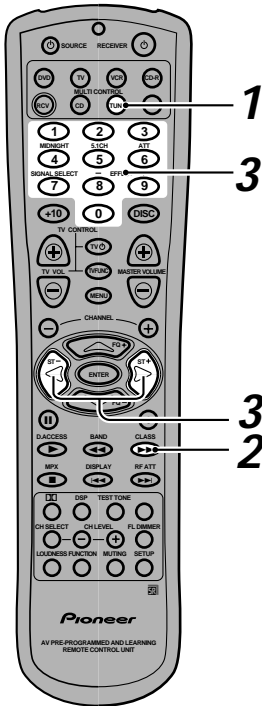

1 Press the MULTI CONTROL TUN (TUNER) button.

On the receiver, press the **FM/AM** button to select the tuner mode.

2 Press CLASS to select the class in which the station is stored.

Repeatedly pressing this button cycles through the three available classes, A, B and C.

3 Use the ST +/- buttons to select the station memory in which the station is stored.

On the receiver, press STATION +/- buttons to select the station memory in which the station is stored. Alternatively, recall the station memory using the number buttons on the remote control.



If the receiver is left disconnected from the AC power outlet for a lengthy period, the station memories will be lost and will have to be reprogrammed.

VSX-609RDS

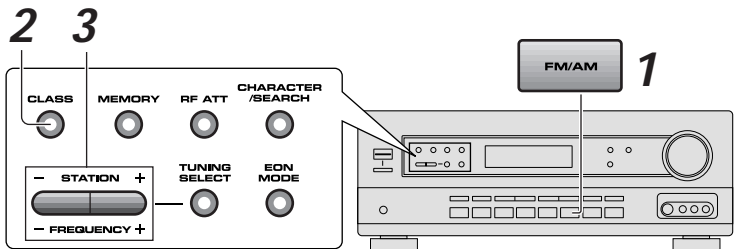
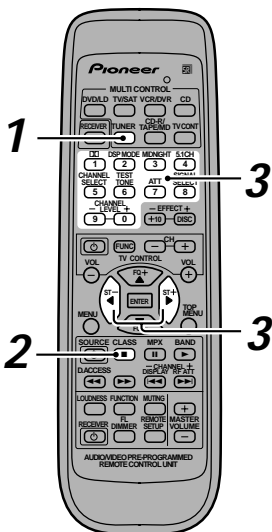

An Introduction to RDS & EON

Radio Data System, or RDS as it's usually known, is a system used by FM radio stations to provide listeners with various kinds of information—the name of the station and the kind of show they're broadcasting, for example. This information shows up as text on the display, and you can switch between the kind of information shown. Although you don't get RDS information from all FM radio stations, you do with most.

Probably the best feature of RDS is that you can search automatically by type of programme. So, if you felt like listening to jazz, you could search for a station that's broadcasting a show with the programme type, "JAZZ." There are around 30 such programme types, including various genres of music, news, sport, talk shows, financial information, and so on.

The receiver lets you display three different kinds of RDS information: Radio Text, Programme Service Name, and Programme Type.

Radio Text (**RT**) is messages sent by the radio station. These can be anything the broadcaster chooses—a talk radio station might give out its telephone number as RT, for example.

Programme Service Name (**PS**) is the name of the radio station.

Programme Type (**PTY**) indicates the kind of programme currently being broadcast.

The receiver can search for and display the following programme types:

News	Accounts of facts, events and reportage
Affairs	Current affairs
Info	General information
Sport	Any aspect of sports
Educate	Educational material
Drama	Radio plays or serials
Culture	National or regional culture, theatre, etc.
Science	Science and technology
Varied	Usually talk-based material, such as quiz shows or interviews.
Pop M	Pop music
Rock M	Rock music
M.O.R. M	"Middle of the road" music
Light M	'Light' classical music
Classics	'Serious' classical music
Other M	Other music not fitting any of the above categories
Weather	Weather reports, forecasts and Meteorological information
Finance	Stock market reports, commerce, trading, etc.
Children	Children's entertainment
Social A	Social affairs
Religion	Beliefs and faiths, involving Gods, the nature of existence, and ethics
Phone in	Public expressing their views by phone
Travel	Holiday-type travel rather than traffic announcements
Leisure	Leisure interests and hobbies
Jazz	Polyphonic, syncopated music characterised by improvisation
Country	Country music
Nation M	Popular music in a language other than English
Oldies	Popular music from the '50s
Folk M	Folk music
Document	Documentaries

In addition, there is a programme type, ALARM!, used for exceptional emergency announcements. You can't search for this, but the tuner will switch automatically to this RDS broadcast signal.

Using the RDS display

To display the different types of RDS information available (RT, PS and PTY as explained on the previous page), press TUN (TUNER) on the remote control and use the DISPLAY button (also marked ◀▶) to cycle through the types of RDS information.

Each press changes the display as follows:

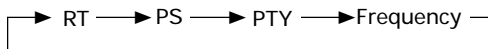

This unit converts lower case characters transmitted by broadcast station to upper case characters.

Basics of EON

EON (Enhanced Other Network information)

EON is a function that allows you to set the receiver to switch to a frequency automatically when a programme featuring traffic information or news is being broadcast. It cannot be used in areas that EON information is not transmitted and when FM broadcast stations do not transmit PTY data. When the broadcast ends, the tuner returns to the original frequency or function.

There are two types of EON you can set the tuner to:

- 1) TA (Traffic Announcement)
This mode will set the tuner to pick up traffic information when it is broadcast.
- 2) NEWS
This mode will set the tuner to pick up news when it is broadcast.

Setting EON allows automated reception of TA/NEWS broadcasts

When EON is turned on, the receiver will automatically jump to those EON-linked broadcasts. Even if a receiver function other than the tuner is being used, the receiver function will switch to the FM station automatically when an EON-linked Traffic Information or News programme begins. When the programme ends, the original function will be restored. The EON function will not operate, however, when the tuner is on AM.

The receiver's internal Program Identification function

PI (Programme Identification)

This is an identifying marker the tuner automatically attaches to stations stored in your preset memory classes (see p. 44). The marker distinguishes between stations which transmit RDS data and those that don't, so that the receiver knows which stations to look at when searching for RDS or EON transmissions. The code is not displayed on the receiver and you don't need to do anything in regards to setting the PI codes.

PI code registration

The receiver will automatically register a PI code for any station you input into the memory classes (see p. 44) which can receive RDS or EON data.

To erase PI codes, follow this procedure:

1. Press the EON MODE button for two seconds or more.
"ERASE PI" will be displayed.
2. Press MEMORY button within 5 seconds.

Searching for RDS Programmes (front panel only)

One of the most useful features of RDS is the ability to search for a particular kind of radio programme. You can search for any of the programme types listed on page 47—this covers all kinds of music, as well as news, weather forecasts, sports programmes, and a variety of others.

1 Press FM/AM button to select the FM band.

RDS is only broadcast on FM.

2 To select the PTY search mode press the CHARACTER/SEARCH button until you see SEARCH in the display.

SEARCH

3 Use the STATION +/- buttons to select the programme type you want to hear.

JAZZ

4 Press MEMORY search for the programme type.

The tuner searches through the FM stations stored in the station memories.

If the tuner finds a matching programme type, the tuner plays 5 seconds of the station. To listen to that station, press the MEMORY button. (The tuner stops searching.)

If you don't press the MEMORY button during the above mentioned 5 seconds, the tuner resumes the search.

When the tuner finds a programme type you searched for, the frequency display will blink for about 5 seconds and then the display will show FINISH briefly.

96 103.00 → FINISH

If NO PTY is displayed it means the tuner couldn't find that programme type at the time of the search.

NO PTY

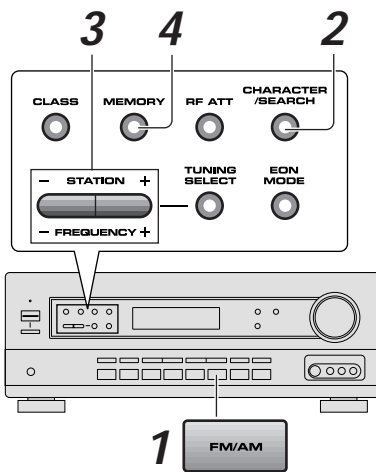

This function searches RDS stations preset in the 30-channel memory. If this function is set when no stations have been preset, "NO PTY" will be displayed. If the desired PTY could not be found amongst the RDS stations in memory, the same display appears.

Setting EON (front panel only)

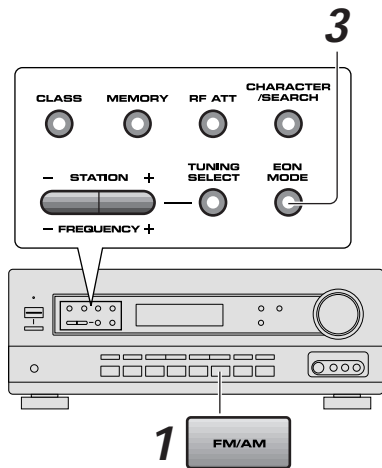

1 Press FM/AM button to select the FM band.

EON is only broadcast on FM.

2 Tune into an EON FM station (see p.42–43, 46).

The box around EON indicator lights to inform you that the currently tuned station carries the EON data service.

3 Press the EON MODE button to select the mode.

There are two EON modes: EON TA and EON NEWS. EON TA will automatically search for traffic reports and EON NEWS will automatically search for news reports among your preset stations.

Each press changes the display as follows.

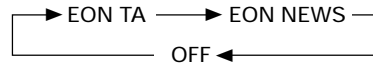

4 EON mode has been set. If the receiver finds such information on the EON-linked broadcast, it will automatically jump to it.

The receiver is set to receive EON information even when it is not in TUNER mode. If such information is found the receiver will automatically switch into TUNER mode to pick up the EON broadcast. When the programme ends the receiver will return to the original mode.

When the EON mode is set the EON indicator with a box around it lights, but during actual reception of an EON-linked broadcast the EON indicator will flash. An empty box in the EON indicator spot means it is possible to pick up an EON-linked broadcast but the receiver has not been set to do so (this will only appear when RDS is switched on).



- The EON mode is cancelled if you switch to AM reception while setting EON. It starts once again when you return to FM reception.
- Simultaneous requests for Traffic Information (TA) and News programmes is not possible.
- You cannot operate the MEMORY and CHARACTER/SEARCH buttons while the EON indicator lights.
- Functions other than TUNER cannot be changed while the EON indicator flashes (while receiving on EON-linked broadcast).

If you want to change to a function other than TUNER, press the EON MODE button and turn the EON mode off.

Making a Recording

Making an Audio or a Video Recording

The following steps show you how to make an audio or a video recording from the built in tuner, or from an audio or a video source connected to the receiver (such as a CD player or TV). Recordings can be made to a CD-Recorder, cassette deck, MD, VCR, or DVR deck connected to the CD-R/TAPE/MD, VCR or DVR in/out connectors.



The receiver's volume, balance tone (bass, treble, loudness), and surround effects (Dolby Pro Logic/Dolby Digital and DSP settings) have no effect on the recorded signal.

VSX-709RDS

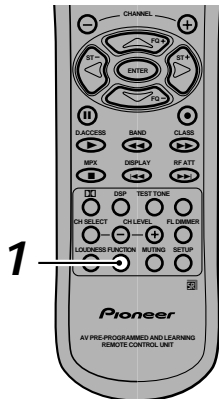

- 1 Press the FUNCTION button to select a source to record (you can also use the MULTI CONTROL buttons if the Direct function is on).**

All functions except MONITOR are accessible from the remote control.

On the receiver, select the source directly using the front panel buttons.

- 2 Prepare the program source.**

Tune to the radio station, load the CD, etc. For a video recording load the video, DVD etc.

- 3 Insert a blank tape, MD, video etc. into the recording device connected to either CD-R/MD/TAPE or VCR/DVR and set the recording levels.**

Refer to the instructions that came with the recorder if you are unsure how to do this. Most video recorders set the audio recording level automatically—check your video's instruction manual if you are unsure whether yours has manual controls.

VSX-609RDS

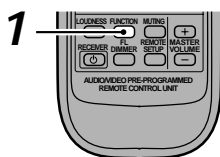

- 4 Start recording, then start playback of the source component.**

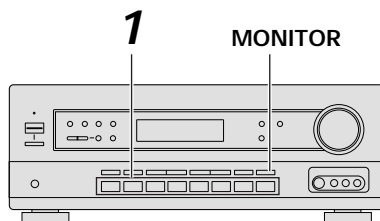

Record MONITOR

You can listen to (monitor) the recording as it's being made using the **MONITOR** button on the the front panel (a cassette deck would have to have a record monitor function).

Press the **MONITOR** button to switch between the recorded signal and the original source signal.

Making a digital recording (VSX-709RDS only)

The VSX-709RDS has one digital output jack. If you want to make a digital recording from this receiver hook up this optical output to the optical input on the digital component you want to record into. The source component (like MD, CD, DVD, etc) must be digital also, of course. Make sure the analog/digital switch is set to digital (see p. 36). The recording procedure is the same as described above (except you don't need to set the recording levels).

Controlling the Rest of Your System

CD/MD/CD-R/VCR/LD Player Controls



This remote control can control these components after entering the proper codes or teaching the receiver the commands (VSX-709RDS only). (see p.22 – 24)

Use MULTI CONTROL buttons to put the remote control in the stated mode.

VSX-709RDS

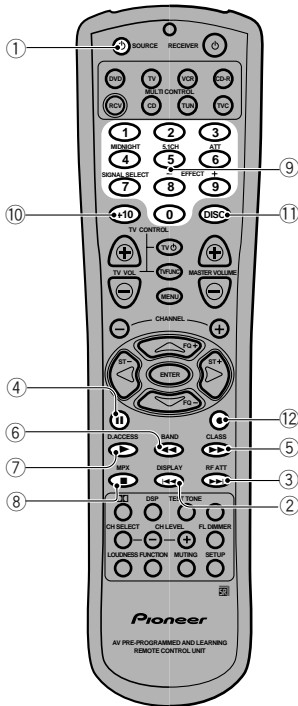

① SOURCE

Press to switch the CD, MD, CD-R, VCR or LD player between **STANDBY** and **ON**.

② ◀◀

Press to return to the start of the current track. Repeated presses skips to the start of previous tracks. When controlling a VCR, use this button to go back channels (channel -).

③ ▶▶

Press to advance to the start of the next track. Repeated presses skips to the start of following tracks. When controlling a VCR, use this button to go forward channels (channel +).

④ ||

Press to pause playback.

⑤ ▶▶▶

Hold down for fast forward playback.

⑥ ◀◀◀

Hold down for fast reverse playback.

⑦ ▶

Press to start playback.

⑧ ■

Press to stop playback (on some models, pressing this when the disc is already stopped will cause the disc tray to open).

⑨ Number buttons

Used to directly access tracks on a program source.

⑩ +10 button

Use to select tracks higher than 10. Press this button and the remaining number to get the track (+10 + 3 = track 13).

⑪ DISC button

For a multiple CD player use this button to choose the disc. On an MD player use it ejects the disc, on a VCR it switches between the tuner (for watching videos) and the TV. On an LD it changes sides of the LD.

⑫ ● Recording button (VSX-709RDS only)

Use to start recording. To prevent accidental recording, this button must be pressed twice to take effect (the second press must be within 10 seconds of the first).

⑬ MENU (VSX-609RDS only)

Press to advance to the start of the next track. Repeated presses skips to the start of following tracks.

⑭ TOP MENU (VSX-609RDS only)

Press to return to the start of the current track. Repeated presses skips to the start of previous tracks.

⑮ ◀▶▶▶▲▼ & ENTER buttons (VSX-609RDS only)

These buttons can be used play or stop (etc.) many components and also to navigate DVD menus/options. Specifically:

- ◀ to rewind or reverse program source
- ▶ to fast forward program source
- ▲ to pause program source
- ▼ to stop program source

ENTER to play program source

▲▼ pressed together to start recording (for recording devices only).

VSX-609RDS

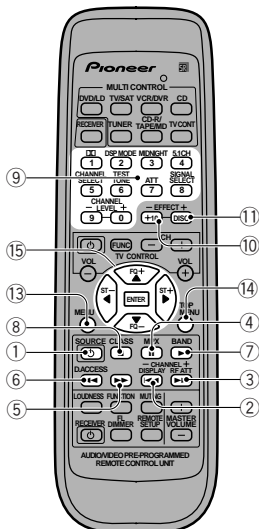

Cassette Deck Controls



This remote control can control these components after entering the proper codes or teaching the receiver the commands (VSX-709RDS only). (see p.22 – 24)

Use MULTI CONTROL buttons to put the remote control in the stated mode.

VSX-709RDS

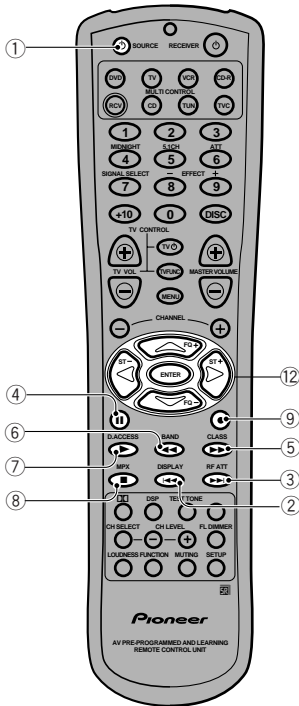

① SOURCE

Press to switch the cassette deck between **STANDBY** and **ON** (not possible on all models).

②

Use to play the reverse side of the tape on a reversible deck.

③

Use to play the forward side of the tape on a reversible deck.

④

Press to pause playback or recording.

⑤

Press to fast forward the tape. Pressing during playback starts forward search.

⑥

Press to rewind the tape. Pressing during playback starts reverse search.

⑦

Press to start playback.

⑧

Press to stop playback.

⑨ ● Recording button (VSX-709RDS only)

Use to start recording. To prevent accidental recording, this button must be pressed twice to take effect (the second press must be within 10 seconds of the first).

⑩ MENU (VSX-609RDS only)

Use to do a rewind music search.

⑪ TOP MENU (VSX-609RDS only)

Use to do a forward music search.

⑫ These controls can be used for deck one of a dual tape deck

▲ : Press to pause the tape.

▼ : Press to stop the tape.

ENTER : Press to start playback

◀ : Press to rewind the tape.

▶ : Press fast forward the tape

For deck two or any deck that can recorded:

▲▼ : Pressed together to start recording

VSX-609RDS

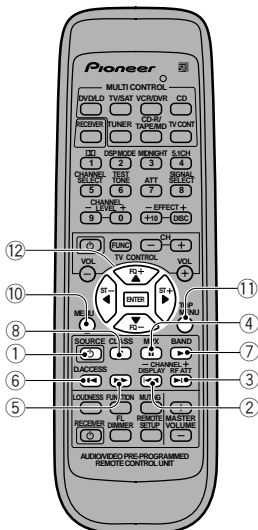

DVD Player/DVR Controls



This remote control can control this component after entering the proper codes or teaching the receiver the commands (VSX-709RDS only). (see p.22 – 24)

Use MULTI CONTROL buttons to put the remote control in the stated mode.

VSX-709RDS

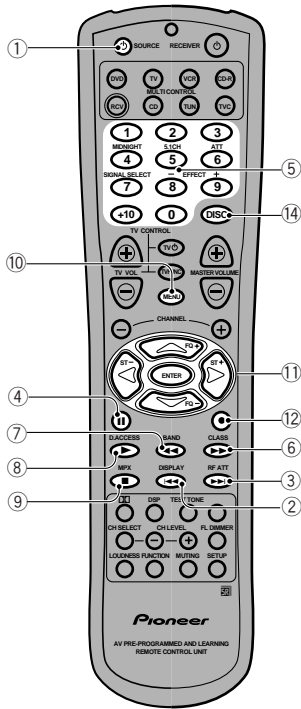

① **SOURCE**

Press to switch the DVD player/DVR between STANDBY and ON.

② **Fast Reverse**

Press to return to the start of the current chapter (track). Repeated presses skips to the start of previous tracks. When controlling a DVR, use this button to go back channels (channel -).

③ **Fast Forward**

Press to advance to the start of the next chapter (track). Repeated presses skips to the start of following tracks. When controlling a DVR, use this button to go forward channels (channel +).

④ **Pause**

Press to pause playback (on some models this will freeze-frame the picture).

⑤ **Number buttons**

Use the number buttons to navigate the on-screen display. The +10 button is used to select tracks higher than 10.

⑥ **Fast Forward (Hold)**

Hold down for fast forward playback.

⑦ **Fast Reverse (Hold)**

Hold down for fast reverse playback.

⑧ **Play**

Press to start playback (on some models, pressing this when the disc tray is empty will cause the disc tray to open).

⑨ **Stop**

Press to stop playback (on some models, pressing this when the disc is already stopped will cause the disc tray to open).

⑩ **MENU**

Displays menus concerning the current DVD or DVR you are using.

⑪ **Use these buttons to navigate DVD menus**

- ▲ : up
- ▼ : down
- ENTER: enter the command selected
- ◀ : left
- ▶ : right
- ▲▼ : pressed together starts recording (VSX-609RDS only)

⑫ **Recording button (VSX-709RDS only)**

Use to start recording. To prevent accidental recording, this button must be pressed twice to take effect (the second press must be within 10 seconds of the first).

⑬ **TOP MENU (VSX-609RDS only)**

Use to display the lead trailer on a DVD.

⑭ **DISC (VSX-709RDS only)**

Use to display the lead trailer on a DVD.

VSX-609RDS

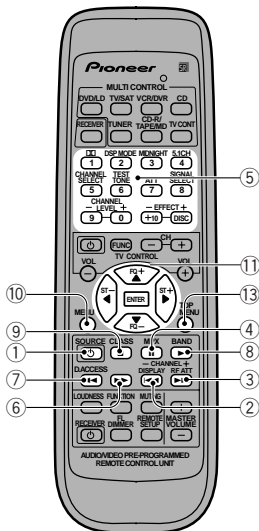

Cable TV/Satellite TV/TV Controls



This remote control can control this component after entering the proper codes or teaching the receiver the commands (VSX-709RDS only). (see p.22 – 24)

Use MULTI CONTROL buttons to put the remote control in the stated mode.

VSX-709RDS

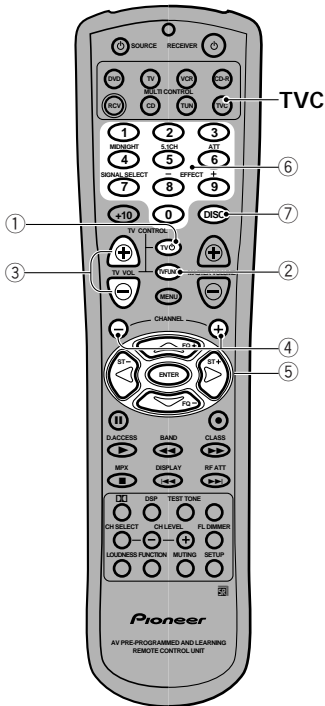

- ① **TV (power)**
Press to switch the TV or CATV between **STANDBY** and **ON**.
- ② **TV FUNC (TV only)**
Press to switch the TV input. (Not possible with all modes. If it doesn't work with the preset code, use the learning feature — see page 24.)
- ③ **TV VOL +/-**
Use to adjust the TV volume.
- ④ **CHANNEL +/-**
Use to select channels.
- ⑤ **▲/▼/◀/▶/ENTER**
Press to select or adjust and navigate items on the menu screen.
- ⑥ **Number buttons**
Use to select a specific TV channel.
- ⑦ **DISC button (VSX-709RDS only)**
Use to enter a channel.
- ⑧ **◀◀ (VSX-609RDS only)**
Use to move to lower numbered channels
- ⑨ **▶▶ (VSX-609RDS only)**
Use to move to higher numbered channels
- ⑩ **EFFECT +/- (VSX-609RDS only)**
For TV and cable TV use to immediately enter a new channel (Channel Enter function). For satellite TV use this button to exit the menu screen.

VSX-609RDS

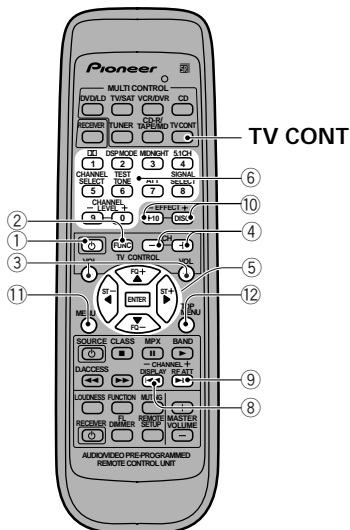

- ⑪ **MENU (VSX-609RDS only)**
Use to select the menu screen.
- ⑫ **TOP MENU (VSX-609RDS only)**
Use to bring up the GUIDE on a satellite TV.



The first four buttons for the VSX-609RDS, and the first three buttons for the VSX-709RDS, are dedicated to control the TV assigned to the TVC (TV CONT) button. Thus if you only have one TV to hook up to this system assign it to the TVC (TV CONT) MULTI CONTROL button. If you have two TVs, assign the main TV to the TVC (TV CONT) button. If you hook up your system this way, the first four TV controls will always be accessible.

Troubleshooting

Incorrect operations are often mistaken for trouble and malfunctions. If you think that there is something wrong with this component, check the points below. Sometimes the trouble may lie in another component. Investigate the other components and electrical appliances being used. If the trouble cannot be rectified even after exercising the checks listed below, ask your nearest Pioneer authorized service center or your dealer to carry out repair work.

Symptom	Cause	Remedy
The power does not turn ON.	<ul style="list-style-type: none"> The power plug is disconnected. Main power button is OFF (■). The protection circuit may have been activated. 	<ul style="list-style-type: none"> Connect the power plug to the wall outlet. Set the Main power button to ON (▲). Disconnect the power plug from the outlet, and insert again.
The unit does not respond when the buttons are pressed.	<ul style="list-style-type: none"> Static electricity caused by dry air. 	<ul style="list-style-type: none"> Disconnect the power plug from the outlet, and insert again.
No sound is output when a function is selected.	<ul style="list-style-type: none"> Improper connections. Sound is muted. The volume is turned down. The MONITOR is ON. Speakers are turned OFF. 	<ul style="list-style-type: none"> Make sure the component is connected correctly (refer to pages 7 to 14). Press MUTING on the remote control. Adjust MASTER VOLUME. Press the MONITOR button. Press SPEAKERS to select the speakers you connected.
No image is output when a function is selected.	<ul style="list-style-type: none"> Improper connections. The input source is not properly selected. 	<ul style="list-style-type: none"> Make sure the component is connected correctly (refer to page 8). Press the correct function button.
Considerable noise in radio broadcasts.	<ul style="list-style-type: none"> Incorrect frequency. The antenna is not connected. RF and/or digital cables are near the antenna terminals and wires. 	<ul style="list-style-type: none"> Tune in the correct frequency. Connect the antenna (refer to page 12). Route RF and digital cables away from the antenna terminals and wires.
FM broadcasts		
	<ul style="list-style-type: none"> The FM antenna is not fully extended or is poorly positioned. Weak radio signals. 	<ul style="list-style-type: none"> Fully extend the FM wire antenna, position for best reception, and secure to a wall. Connect an outdoor FM antenna (refer to page 12).
AM broadcasts		
	<ul style="list-style-type: none"> The AM antenna is poorly positioned. Weak radio signals. Interference cause by other equipment (fluorescent lamp, motor, etc.). 	<ul style="list-style-type: none"> Adjust the direction and position for best reception. Connect an additional internal or external AM antenna (refer to page 12). Turn off the equipment causing the noise or move it away from the receiver. Place the antenna farther away from the equipment causing the noise.

Symptom	Cause	Remedy
Broadcast stations cannot be selected automatically.	<ul style="list-style-type: none"> Weak radio signal. 	<ul style="list-style-type: none"> Connect an outdoor antenna (refer to page 12).
No sound from surround or center speakers.	<ul style="list-style-type: none"> Speaker settings are incorrect. The rear and/or center levels are turned down. The surround and/or center speakers are disconnected. 	<ul style="list-style-type: none"> Refer to "Speakers setting mode" on page 16 to check the speaker settings. Refer to "Setting the Volume Level of Each Channel" on page 21 to check the speaker levels. Connect the speakers (refer to page 13).
Sound is produced from other components, but not from LD or DVD player.	<ul style="list-style-type: none"> SIGNAL SELECT is set incorrectly. The digital inputs are assigned incorrectly, or not at all. 	<ul style="list-style-type: none"> Set SIGNAL SELECT to "DIGITAL" or "ANALOG" according to the type of connections made. (refer to page 36). Set the digital input settings correctly (refer to pages 19 – 20).
No sound is output or a noise is output when software with DTS is played back.	<ul style="list-style-type: none"> SIGNAL SELECT is set to "ANALOG". A DVD player not compatible with DTS is used, or the setting of DVD player is incorrect. The digital output level is adjusted on a CD player or other components equipped with digital output level adjustment capability. (The DTS signal has been altered by the player, and cannot be read.) 	<ul style="list-style-type: none"> Make digital connections (refer to page 9) and set SIGNAL SELECT to "DIGITAL" (refer to page 36). Refer to the instruction manual supplied with the DVD player. Set the digital volume level of the player to full, or to the neutral position.
When a search is performed by a DTS compatible CD player during playback, noise is output.	<ul style="list-style-type: none"> The search function performed by the player slightly alters the digital information, making it unreadable. 	<ul style="list-style-type: none"> This is not a malfunction, but be sure to turn the volume down to prevent the output of loud noise from your speakers.
Cannot be remote controlled.	<ul style="list-style-type: none"> The remote control batteries have worn out. Too far away or bad angle of operation. There is an obstacle between the receiver and the remote control. Strong light such as fluorescent light is shining onto the unit's remote control sensor. 	<ul style="list-style-type: none"> Replace the batteries (refer to page 6). Operate within 7 m, 30° of the remote sensor on the front panel (refer to page 6). Remove the obstacle or operate from another position. Avoid exposing the remote sensor on the front panel to direct light.
The display is dark or off.	<ul style="list-style-type: none"> The FL DIMMER button is pushed. 	<ul style="list-style-type: none"> Press FL DIMMER on the remote control repeatedly to return to the default.

If the unit does not operate normally due to external effects such as static electricity

Disconnect the power plug from the outlet and insert again to return to normal operating conditions.

Preset Code List for VSX-709RDS

CABLE TV

Manufacture	Code
ABC	1014, 1017
Andover	1544
Birmingham Cable Communications	1276
British Telecom	1003, 1105
Cabletime	1161, 1271, 1377, 1448
Clyde	1086
Cryptovision	1600
Decsat	1423
Filmnet	1443
France Telecom	1451
GEC	1086
Grundig	1529
Jerrold	1003, 1014, 1276
MNet	1019, 1443
PVP Stereo Visual Matrix	1003
Pioneer	1144, 1533
STS	1156
Salora	1382
Satbox	1375
Scientific Atlanta	1008, 1017, 1277
Tele+1	1443
Teleservice	1281
Tudi	1286
United Cable	1003
Videoway	1250
VisiCable+	1481
Westminster	1105
Wolsey Gene	1544
Zenith	1000, 1525

CD PLAYER (1/2)

Manufacture	Code
Aiwa	0124
Akai	0108, 0156, 0199
Arcam	0157
Audio Research	0157
AudioTon	0157
Audiolab	0157
Audiomeca	0157
Bestar	0164
California Audio Labs	0029
Condor	0134, 0164
Curtis Mathes	0029
Cyrus	0157
Denon	0003, 0034, 0873
Dual	0196
Fisher	0179
Grundig	0157
Harman/Kardon	0173
JVC	0072
Kenwood	0028, 0190, 0681, 1059
Linn	0157
Marantz	0029, 0038, 0129, 0157
Matsui	0157
MCS	0029

CD PLAYER (2/2)

Manufacture	Code
Memorex	0164
Meridian	0157
Micromega	0157
Mitsubishi	0108, 0156
NAD	0000
Naim	0157
Onkyo	0101, 0102, 0868
Orion	1044
Panasonic	0029
PMG	0164
Philips	0157, 0626
Pioneer	0032, 0192, 0244, 0468, 1062(CD-R)
Poppy	0164
Quad	0157
Quasar	0029
Revox	0157
Rotel	0157
Sansui	0202
Sanyo	0179
Schneider	0134
Sharp	0037, 0861
Sherwood	0114, 0196
Sony	0000, 0490
Technics	0029, 0207
Thorens	0157
Universum	0157
Yamaha	0036, 0187

CASSETTE DECK

Manufacture	Code
Aiwa	1197, 1200
Akai	1188, 1189
Arcam	1076
Denon	1076, 1412
Grundig	1029
Harman/Kardon	1182
JVC	1244, 1273, 1274
Kenwood	1070, 1071, 1205, 1233, 1234
Marantz	1029
Memorex	1099, 1101
Mitsubishi	1189
Onkyo	1135, 1136
Panasonic	1229
Philips	1029
Pioneer	1027, 1099, 1101, 1220
Revox	1029
Sharp	1205
Sony	1170, 0243
Technics	0229
Thorens	0029
Yamaha	1205

LASERDISC PLAYER

Manufacture	Code
Cyrus	0388
Marantz	0064, 0194
Philips	0064, 0194, 0388
Pioneer	0059
Radiola	0388
Salora	0064
Sony	0193, 0201
Telefunken	0059

TUNER

Manufacture	Code
Aiwa	0121, 0405, 1405
Akai	0115, 0346
Arcam	0189, 0642
Audiolab	1189
Denon	0004, 1104, 1160
Ferguson	0531
Fine Arts	1189
Fisher	0360
Goodmans	0346
Grundig	0189, 1189
Harman/Kardon	0110
JVC	0074, 0464, 0531
Kenwood	0027, 0313, 0314, 0569, 1027, 1313, 1569
Marantz	0189, 1089, 1189
Micromega	0189, 1189
Onkyo	0135
Optimus	1023
Palladium	0690
Panasonic	0309, 0518
Philips	0189, 0600, 0642, 1089, 1189
Phonotrend	0502
Pioneer	0014, 0080, 0289, 0531, 0690, 1023
Revox	0189
Roadstar	0346
Saba	0531
Saisho	0346
Sansui	0346
Sanyo	0360
Schneider	0531
Sharp	0186
Sherwood	0502
Sony	0158, 1058, 1158, 1258
Technics	0208, 0309, 0518, 1308, 1309, 1518
Telefunken	0531
Thorens	0189, 1189
Uher	0346, 0531, 0690
Yamaha	0176

SATELLITE TUNER (1/3)

Manufacture	Code
ABsat	1123
AST	1351
Alba	1362, 1421, 1455, 1613
Aldes	1288
Amstrad	1080, 1252, 1345, 1461, 1501, 1509
Ankaro	1220, 1288, 1369, 1519
Anttron	1183, 1421
Armstrong	1243
Astra	1108
Astro	1173, 1501, 1520
Avalon	1396
Axis	1369, 1530
BT	1668
Beko	1189
Best	1369
Blaupunkt	1173
Boca	1243, 0513
Brain Wave	1332
British Sky Broadcasting	1847
Bush	1067
CNT	1520
Cambridge	1344
Canal Satellite	1853
Canal+	1853
Channel Master	1362
Commlink	1288
Connexions	1396
Crown	1243
Cyrus	1200
D-box	1723
DDC	1362
DNT	1200, 1396
Echostar	1396, 1453, 1871
Emanon	1421
FTE Humax	1863
Ferguson	1067, 1183, 1189, 1336
Fidelity	1252
Finlux	1108, 1344, 1397, 1455
Fracarro	1871
Freecom	1421
Fuba	1369, 1396, 1421
G-Sat	1183
Galaxis	1288, 1834, 1863
General Instrument	1201
Gold Box	1853
Gooding	1571
Goodmans	1189
Grundig	1173, 1189, 1571
Hinari	1183
Hirschmann	1173, 1397, 1501, 1502, 1573
Hitachi	1455
Houston	1668
Huth	1220, 1243, 1288, 1346
ITT	1108
InVideo	1871
Intervision	1592
JVC	1571

SATELLITE TUNER (2/3)

Manufacture	Code
Johansson	1332
Kathrein	1092, 1123, 1173, 1200, 1442, 1504
Kreiselmeier	1173
Kyostar	1421
La Sat	1513, 1520
Lenco	1421
Lennox	1592
Lupus	1369
Luxor	1108, 1573
Manhattan	1455, 1520, 1592
Marantz	1200
Maspro	1092, 1336
Matsui	1344, 1571
MediaSat	1853
Mediamarkt	1243
Minerva	1571
Morgan's	1243, 1513
Navex	1332
Neuhaus	1501
Neusat	1834
Newhaus	1220
Nokia	1108, 1397, 1455, 1573, 1723, 1873
Nordmende	1362
Orbitech	1501
Oxford	1344
Pace	1067, 1183, 1241, 1336, 1455, 1791, 1847
Palladium	1571
Palsat	1501
Panda	1455
Phillips	1133, 1200, 1292, 1455, 1571, 1853
Phonotrend	1288, 1592
Pioneer	1329, 1853
Planet	1871
Promax	1455
Prosat	1288
Quadral	1362, 1519
RFT	1200, 1220, 1288
Radiola	1200
Radix	1396, 1882
SAT	1351, 1461
SEG	1369, 1421
Saba	1336, 1520
Sabre	1455
Sagem	1820
Salora	1108
SatPartner	1332, 1421, 1502, 1520
Satcom	1346, 1605
Satec	1183
Satmaster	1346
Schwaiger	1183, 1504
Seemann	1396, 1530
Siemens	1173
Skymaster	1288, 1519, 1605
Sony	1278, 1282
Strong	1872
Sunstar	1513
TPS	1820
Tantec	1336, 1455
TechniSat	1005, 1501

SATELLITE TUNER (3/3)

Manufacture	Code
Techniland	1346
Telefunken	1421
Teleka	1243, 1613
Telesat	1605
Thomson	1455, 1853
Tonna	1346, 1668
Triad	1351
Triasat	1501
Unitor	1332
Universum	1173, 1571
Ventana	1200
Vortec	1421
Winersat	1332
Wisi	1173, 1351, 1396, 1455
XSat	1123, 1889
Xcom Multimedia	1889
Zehnder	1419, 1520, 1552

TELEVISION (1/6)

Manufacture	Code
Acura	0009
Admiral	0163, 0213
Adyson	0032, 0217
Akai	0208
Akura	0218, 0264
Alaron	0216
Alba	0009, 0036, 0037, 0218, 0371
Allorgan	0294
Amplivision	0217
Amstrad	0009, 0037, 0371
Anitech	0009, 0068, 0076
Arcam	0216, 0217
Asberg	0076
Asuka	0218
Atlantic	0206
Audiosonic	0037, 0109
Autovox	0076, 0206
BPL	0282
BSR	0294
BTC	0218
Bang & Olufsen	0565
Basic Line	0009, 0218
Baur	0010, 0037, 0554
Beko	0370
Beon	0037
Binatone	0217
Blaupunkt	0191, 0195, 0200, 0213, 0554
Blue Sky	0218
Blue Star	0282
Bondstec	0247
Boots	0217
Brandt	0109, 0196, 0198, 0205
Britannia	0216
Bush	0009, 0036, 0037, 0218, 0282, 0294, 0371, 0374
CGE	0074, 0076, 0084, 0247, 0306
CS Electronics	0216
CTC	0247

TELEVISION (2/6)

Manufacture	Code
Carrefour	0036
Cascade	0009
Cathay	0037
Centurion	0037
Century	0213
Cimline	0009
Clarivox	0037
Clatronic	0076, 0247, 0370
Condor	0320, 0370
Contec	0009, 0036, 0216
Continental Edison	0196, 0198, 0205
Crosley	0074, 0076, 0084, 0213
Crown	0009, 0037, 0076, 0370, 0418
Crystal	0431
Cybertron	0218
Daewoo	0009, 0037, 0374
Dainichi	0215, 0218
Dansai	0037
Dayton	0009
De Graaf	0208
Decca	0037, 0072
Dixi	0009, 0037
Dual Tec	0217
Dumont	0070
Elbe	0259
Elin	0037
Elite	0218, 0320
Elta	0009
Emerson	0213
Erres	0012, 0037
Expert	0206
Ferguson	0005, 0037, 0073, 0109, 0190, 0238, 0287
Fidelity	0216
Finlandia	0208
Finlux	0037, 0070, 0072, 0105
Firstline	0009, 0216, 0217, 0247, 0294, 0321
Fisher	0208, 0217, 0303, 0370
Flint	0455
Formenti	0037, 0213, 0320
Frontech	0163, 0247, 0264, 0431
Fujitsu	0072, 0206
Funai	0264, 0294, 0303
GEC	0037, 0043, 0072, 0205, 0217
GPM	0218
Geloso	0009, 0213
Genexxa	0163, 0218
GoldStar	0037, 0109, 0217, 0290
Goodmans	0036, 0037, 0072, 0217, 0371, 0374
Gorenje	0370
Graetz	0163
Granada	0037, 0072, 0146, 0208, 0217
Grandin	0282

TELEVISION (3/6)

Manufacture	Code
Grundig	0070, 0191, 0195, 0205, 0554
HCM	0009, 0282
Hanseatic	0037, 0320
Hinari	0009, 0036, 0037, 0218
Hisawa	0282, 0455
Hitachi	0032, 0036, 0043, 0044, 0105, 0109, 0163, 0196, 0198, 0217, 0225, 0306
Huanyu	0216, 0374
Hypson	0037, 0264, 0282
ICE	0217, 0264, 0371
ICeS	0218
ITS	0371
ITT	0163
Imperial	0074, 0076, 0084, 0247, 0370, 0418
Indiana	0037
Ingelen	0163
Inno Hit	0072
Interbuy	0068
Interfunk	0037, 0163, 0247
Intervision	0037, 0068, 0102, 0217, 0264
Isukai	0218
JVC	0036, 0053, 0190, 0192, 0371, 0653
Kaisui	0009, 0216, 0217, 0218, 0282
Kamp	0216
Kapsch	0163, 0206
Kawasho	0216
Kendo	0037
Kingsley	0216
Kneissel	0259
Korpel	0037
Koyoda	0009
Leyco	0037, 0072, 0264, 0294
Liesenk & Tter	0037
Lloytron	0032
Loewe	0075
Luma	0206
M Electronic	0009, 0037, 0068, 0105, 0109, 0163, 0217, 0287, 0374
Magnadyne	0102, 0247
Magnafoon	0076, 0102, 0213
Manesth	0217, 0264, 0320
Marantz	0037
Mark	0037
Matsui	0009, 0035, 0036, 0037, 0072, 0208, 0217, 0294, 0371
McMichael	0043
Mediator	0012, 0037
Memorex	0009
Metz	0213
Minerva	0070, 0554
Mitsubishi	0036, 0108, 0150
Mivar	0216, 0290, 0291, 0292
Motion	0076

TELEVISION (4/6)

Manufacture	Code
Multitech	0009, 0076, 0102, 0216
MTC	0216
NEI	0037, 0431
Neckermann	0037, 0191, 0213, 0554
Nicamagic	0216
Nikkai	0032, 0035, 0037, 0072, 0216, 0218, 0264
Noblisko	0076, 0102
Nordmende	0109, 0196, 0198, 0213, 0287
Oceanic	0163, 0215
Orion	0037, 0294, 0320, 0321
Osaki	0032, 0072, 0217, 0218, 0264
Oso	0218
Osume	0032, 0072, 0157
Otto Versand	0010, 0036, 0037, 0191, 0213, 0217, 0320, 0554
Palladium	0370, 0418
Panama	0217, 0264
Panasonic	0163, 0213, 0214, 0226, 0250, 0650
Pathe Cinema	0213, 0216, 0238, 0320
Pathe Marconi	0196, 0198, 0205
Pausa	0009
Perdio	0320
Phase	0032
Philco	0074, 0076, 0084, 0213, 0247
Philips	0012, 0037, 0043, 0374, 0554
Phonola	0012, 0037
Pioneer	0109, 0163, 0166, 0287, 0423, 0679
Profex	0009, 0076
Proline	0321
Protech	0009, 0037, 0102, 0217, 0247, 0264, 0418, 0431
Pye	0012
Quelle	0010, 0037, 0070, 0074, 0084, 0200, 0213, 0306, 0554
Questa	0036
R-Line	0037
RBM	0070
Radiola	0012, 0037
Rank Arena	0036
Revvox	0037
Rex	0163, 0206, 0259, 0264
Rhapsody	0216
Roadstar	0009, 0218, 0264, 0418
SBR	0012, 0037, 0043
SEG	0036, 0076, 0217, 0264
SEI	0102, 0213, 0294

TELEVISION (5/6)

Manufacture	Code
Saba	0075, 0109, 0163, 0196, 0198, 0205, 0213, 0287
Saccs	0238
Saisho	0009, 0264, 0431
Salora	0163
Sambers	0076, 0102, 0213
Samsung	0009, 0037, 0090, 0217, 0264, 0290, 0370
Sandra	0216
Sanyo	0036, 0072, 0146, 0157, 0208, 0213
Schneider	0037, 0218, 0247, 0303, 0371
Sei-Sinudyne	0010
Seleco	0163, 0206, 0259
Sentra	0035
Sharp	0036, 0093, 0680
Shorai	0294
Siarem	0102, 0213
Siemens	0037, 0157, 0191, 0195, 0200, 0213, 0554
Silver	0036
Sinudyne	0102, 0213, 0294
Solavox	0032, 0163
Sonitron	0208
Sonoko	0009, 0037
Sonolor	0163, 0208, 0215
Sontec	0037
Sony	0010, 0036
Soundwave	0037, 0418
Standard	0009, 0217, 0218
Stern	0163, 0206, 0259
Sunkai	0294, 0321
Supertech	0216
Susumu	0218
Sysline	0037
Tandy	0072, 0163, 0217, 0218
Tashiko	0036, 0043, 0217
Tatung	0037, 0072, 0217
Tec	0217, 0247
Technema	0320
Technics	0250, 0650
Telefunken	0005, 0074, 0084, 0101, 0109, 0213, 0306
Telemeister	0320
Teletech	0009
Teleton	0036, 0206, 0217
Tensai	0218, 0294, 0320
Textet	0216, 0218
Thomson	0109, 0196, 0198, 0205, 0287
Thorn	0035, 0037, 0072, 0074, 0084, 0190, 0192
Tomashi	0282
Toshiba	0035, 0036, 0070, 0243
Triumph	0243
Uher	0206, 0303, 0320
Ultra	0192

TELEVISION (6/6)

Manufacture	Code
Ultravox	0102
Universum	0037, 0105, 0264, 0370
Vestel	0037
Videosat	0247
Videotechnic	0217
Vision	0320
Voxson	0163
Waltham	0217
Watson	0037, 0320
Watt Radio	0102
Wega	0036
White	
Westinghouse	0037, 0216, 0320
Yoko	0037, 0217, 0264, 0431
Zanussi	0206

VCR (1/4)

Manufacture	Code
ASA	0037, 0081
Aiwa	0000, 0307, 0348, 0352
Akai	0041, 0053, 0106, 0315
Akiba	0072
Alba	0020, 0072, 0209, 0278, 0315, 0352
Ambassador	0020
Amstrad	0000, 0278, 0325, 0332
Anitech	0072
Asuka	0037
Baird	0000, 0041, 0104, 0107
Basic Line	0020, 0072, 0278
Blaupunkt	0003, 0006, 0016, 0034, 0154, 0162, 0195, 0226, 0227, 0403
Brandt	0187, 0320, 0321
Brandt Electronic	0041
Bush	0072, 0209, 0278, 0352
CGE	0000
Catron	0020
Cimline	0072
Clatronic	0020
Combitech	0352
Condor	0020
Crown	0020, 0072, 0278
Cyrus	0081
Daewoo	0020, 0278
Dansai	0072
De Graaf	0042, 0166
Decca	0000, 0081
Denon	0042
Dual	0041
Dumont	0000, 0081, 0104
ESC	0240, 0278
Elbe	0038
Elcatech	0072
Ferguson	0041, 0107, 0320, 0321

VCR (2/4)

Manufacture	Code
Fidelity	0000
Finlandia	0081, 0104,
Finlux	0000, 0042, 0081, 0104
Firstline	0037, 0043, 0045, 0072, 0209
Fisher	0046, 0047, 0054, 0104
Frontech	0020
Funai	0000
GEC	0081
General	0020
GoldHand	0072
GoldStar	0037, 0225
Goodmans	0000, 0020, 0037, 0072, 0278, 0403
Graetz	0005, 0041, 0104, 0240
Granada	0046, 0081, 0104
Grandin	0000, 0037, 0072
Grundig	0003, 0006, 0007, 0016, 0072, 0081, 0195, 0207, 0226, 0347, 0349, 0403
HCM	0072
Hanseatic	0037
Hinari	0004, 0072, 0240, 0352
Hitachi	0000, 0004, 0041, 0042, 0166, 0235, 0240
Hypson	0072
ITT	0005, 0041, 0046, 0104, 0106, 0240, 0384
ITV	0037, 0278
Imperial	0000
Ingersol	0004
Interfunk	0081
JVC	0008, 0041, 0067, 0206, 0207, 0384, 0486
Kaisui	0072
Kendo	0106, 0209
Kenwood	0041
Korpel	0072
Lenco	0278
Leyco	0072
Loewe	0004, 0006, 0037, 0081
Logik	0004, 0240
Luxor	0043, 0046, 0048, 0104, 0106
M Electronic	0000
Manesth	0045, 0072
Marantz	0003, 0006, 0081
Matsui	0004, 0036, 0088, 0209, 0348, 0352
Melectronic	0038
Memorex	0000, 0037, 0046, 0104
Memphis	0072
Metz	0003, 0006, 0037, 0162, 0195, 0227, 0347

VCR (3/4)

Manufacture	Code
Minerva	0006, 0016, 0195
Mitsubishi	0043, 0067, 0081
Multitech	0000, 0072
Murphy	0000
NEC	0038, 0041, 0067
Neckermann	0081
Nesco	0072
Nokia	0041, 0046, 0104, 0106, 0240
Nordmende	0041, 0297, 0320, 0321, 0384
Oceanic	0000, 0041
Okano	0315, 0348
Orion	0004, 0036, 0088, 0209, 0348, 0352
Osaki	0000, 0037, 0072
Otto Versand	0081
Palladium	0006, 0037, 0041, 0072
Panasonic	0162, 0226, 0227
Pathe Cinema	0036
Pathe Marconi	0041
Pentax	0042
Perdio	0000
Philco	0038
Philips	0081, 0384, 0403
Phonola	0081
Pioneer	0058, 0067, 0081, 0168, 0235
Portland	0020
Profex	0322
Profitronic	0240
Proline	0000
Pye	0081
Quartz	0046
Quelle	0081
RFT	0403
Radiola	0081
Rex	0041, 0384
Roadstar	0037, 0072, 0240, 0278
SBR	0081
SEG	0240, 0322
SEI	0004, 0081
Saba	0041, 0206, 0207, 0297, 0320, 0321, 0384
Saisho	0004, 0036, 0088, 0209
Salora	0043, 0046, 0106
Samsung	0240, 0432
Sansui	0041, 0067
Sanyo	0046, 0104
Saville	0352
Schaub Lorenz	0000, 0005, 0041, 0104
Schneider	0000, 0072, 0081
Seleco	0041
Sentra	0020
Sharp	0048
Shintom	0072, 0104
Shorai	0004
Siemens	0003, 0006, 0016, 0037, 0054, 0081, 0104, 0195

VCR (4/4)

Manufacture	Code
Silva	0037
Singer	0045
Sinudyne	0004, 0081
Solavox	0020
Sonolor	0046
Sontec	0037
Sony	0011, 0032, 0033, 0034
Sunkai	0348
Sunstar	0000
Suntronic	0000
Tashiko	0000
Tatung	0000, 0041, 0081
Tec	0020
Technics	0162, 0226
Teleavia	0041
Telefunken	0041, 0187, 0320, 0321, 0384
Tenosal	0072
Tensai	0000, 0322
Thomson	0041, 0320, 0384
Thorn	0036, 0041, 0104
Toshiba	0041, 0043, 0045, 0081, 0384
Towada	0322
Uher	0240
Universum	0000, 0006, 0016, 0037, 0081, 0106, 0195, 0240, 0325
Yamishi	0072
Yokan	0072
Yoko	0020, 0240

DVD PLAYER

Manufacture	Code
Akai	0611
JVC	0558
Kenwood	0534
Onkyo	0612
Panasonic	0490, 0632
Philips	0539
Pioneer	0525, 0571, 0632, 0631 (DVD-R)
Samsung	0573
Sony	0533
Thomson	0551
Toshiba	0503
Yamaha	0545

MD RECORDER

Manufacture	Code
Denon	0873
Kenwood	0681, 1059
Onkyo	0868
Orion	1044
Pioneer	1063
Sharp	0861
Sony	0490

Preset Code List for VSX-609RDS

DVD PLAYER

Manufacture	Code
TOSHIBA	001
SONY	002
PANASONIC	003
JVC	004
SAMSUNG	005
SHARP	006
AKAI	007
RCA	009
PIONEER	000, 008

LASERDISC PLAYER

Manufacture	Code
DENON	110
HITACHI	109
PHILIPS	108
RADIOLA	108
SONY	101, 102
TELEFUNKEN	100
PIONEER	100, 111 (DVD/LD player)

SATELLITE TUNER

Manufacture	Code
PIONEER	200, 204

VCR (1/3)

Manufacture	Code
PHILIPS	414, 428
PANASONIC	408, 432
THOMSON	417, 428, 449
SONY	416, 417, 457, 458, 459
JVC	407, 417, 428
GRUNDIG	408, 414, 441, 453, 454, 455
AKAI	417, 442
HITACHI	406, 417, 441
TOSHIBA	405, 409, 414, 417, 428
MITSUBISHI	407, 409, 414
SHARP	402
ORION	424, 445, 446
SANYO	444
FERGUSON	417, 449, 450
BLAUPUNKT	408, 417, 432, 455
NOKIA	417, 442, 444
SELECO	417
AIWA	441, 446
AKIBA	453
ALBA	424, 446, 447, 448, 452
AMBASSADOR	452
AMSTRAD	441
ANITECH	453
ASA	411, 414
BAIRD	417, 441, 444, 450
BASIC LINE	448, 452, 453
BRANDT	449, 451

VCR (2/3)

Manufacture	Code
BRANDT	
ELECTRONIQUE	417
BUSH	424, 446, 447, 448, 453
CATRON	452
CGB	441
CIMLINE	453
CLATRONIC	452
CONDOR	452
CROWN	448, 452, 453
DAEWOO	448, 452
DANSAI	453
DE GRAAF	406
DECCA	414, 441
DUAL	417
DUMONT	414, 441, 444
ELCATECH	453
FIDELITY	441
FINLANDIA	414, 444
FINLUX	406, 414, 441, 444
FIRSTLINE	405, 409, 411, 424, 453
FISHER	444
FRONTECH	452
FUNAI	441
GBC	414
GENERAL	452
GOLDSTAR	411
GOODMANS	411, 441, 448, 452, 453
GRAETZ	417, 444
GRANADA	414, 444
GRANDIENTE	441
GRANDIN	411, 441, 453
HCM	453, 454
HINARI	445, 446, 453, 454
HYPSON	453
IMPERIAL	441
INTERFUNK	414
ITT	417, 428, 442, 444
ITV	411, 448
KAISUI	453
KENDO	424, 444
KORPEL	453
LEYCO	453
LOEWE	411, 414
LUXOR	409, 442, 444
M-ELECTRONIC	441
MANESTH	405, 453
MARANTZ	414
MATSUI	424, 445, 446
MEMOREX	411, 441, 444
MEMPHIS	453
METZ	432, 455
MINERVA	455
MULTITECH	441, 453
MURPHY	441
NBC	407, 417
NECKERMANN	414
NESCO	453
NORDMENDE	417, 428

VCR (3/3)

Manufacture	Code
OCEANIC	417, 441
OSAKI	411, 441, 453
OTTO VERSAND	414
PALLADIUM	411, 417, 453
PATHE MARCONI	417
PENTAX	406
PERDIO	441
PHONOLA	414
PORTLAND	452
PROLINE	441, 454
PYE	414
QUELLE	414
RADIOLA	414
REX	417, 428
ROADSTAR	411, 448, 453
SABA	417, 428, 449
SAISHO	424, 445
SALORA	409, 442
SANSUI	407, 417
SBR	414
SCHAUB LORENZ	417, 441
SCHNEIDER	414, 441, 453
SEI	414
SENTRA	452
SHINTOM	453
SIEMENS	411, 444, 455
SINGER	405
SINUDYNE	414
SOLAVOX	452
SUNSTAR	441
SUNTRONIC	441
TASHIKO	441
TATUNG	414, 417, 441
TEC	452
TELEAVIA	417
TELEFUNKEN	417, 428, 449, 451
TENOSAL	453
TENSAI	441
THORN	417, 444
UNIVERSUM	411, 414, 441, 442, 455
YAMISHI	453
YOKAN	453
YOKO	452
PIONEER	400, 407, 414, 443, 456 (DVD video Recorder)

CASSETTE DECK (1/2)

Manufacture	Code
AKAI	829
ARCAM	810
DENON	810, 827
FISHER	813
GRUNDIG	821
JVC	802
KENWOOD	804, 807, 822
LUXMAN	815
MARANTZ	821
MEMOREX	825

CASSETTE DECK (2/2)

Manufacture	Code
MITSUBISHI	829
NAKAMICHI	816
ONKYO	817, 819
PHILIPS	821
SANSUI	824
SHERWOOD	818
SONY	814, 823
TANDBERG	820
TECHNICS	803
TOSHIBA	826, 828
YAMAHA	811, 822
PIONEER	800, 825

CD PLAYER

Manufacture	Code
AKAI	335
ARCAM	336
ASUKA	337
AUDIO TON	336
BUSH	332
CALIFORNIA AUDIO LAB	304
CYRUS	336
DENON	309
DUAL	319, 337
FISHER	340
GOLDSTAR	330
GRUNDIG	336
HITACHI	334
INTER SOUND	337
JVC	331
KENWOOD	310, 311
KODAK	322
LINN	336
LUXMAN	341
M ELECTRONIC	344
MARANTZ	304, 336
MATSUI	336
MCS	304
MEMOREX	300
MERIDIAN	336
MITSUBISHI	335
NAD	316
NAIM	336
ONKYO	342
PANASONIC	304
PHILIPS	322, 336, 346
QUAD	336
QUASAR	304
ROADSTAR	344
ROTEL	336
SABA	319
SANYO	340
SHARP	343
SONY	316, 329
TECHNICS	304, 333
TELEFUNKEN	319
THOMSON	319
UNIVERSUM	336
YAMAHA	338, 339
PIONEER	300, 345 (CD recorder)

TELEVISION (1/4)

Manufacture	Code
PHILIPS	607, 631, 634, 656
SONY	604
GRUNDIG	631, 653
PANASONIC	608, 622, 631, 642
TOSHIBA	605, 653
TELEFUNKEN	636, 637, 652
SHARP	602
SAMSUNG	607, 638, 644, 646
HITACHI	606, 631, 633, 634, 636, 642, 643, 654
SABA	631, 636, 642, 651
BRANDT	636
SANYO	635, 645, 648
THOMSON	636, 651, 652
FERGUSON	607, 636, 651
NOKIA	632, 642, 652
MITSUBISHI	609, 631
SCHNEIDER	607, 641, 647
GOLDSTAR	607, 650
BLAUPUNKT	631
NORDMENDE	632, 636, 651, 652
RADIOLA	607
JVC	613
DAEWOO	607, 644, 656
ORION	607, 632, 639, 640
SIEMENS	631
ACURA	644
ADMIRAL	631
AKAI	632, 635, 642
AKUBA	641
ALBA	607, 639, 641, 644
AMSTRAD	642, 644, 647
ANITECH	644
ASA	645
ASUKA	641
AUDIOGONIC	607, 636
BASIC LINE	641, 644
BAUR	607, 631, 642
BEKO	638
BEON	607
BLUE SKY	641
BLUE STAR	618
BPL	618
BTC	641
BUSH	607, 641, 642, 644, 647, 656
CASCADE	644
CATHAY	607
CENTURION	607
CGB	642
CIMLINE	644
CLARIVOX	607
CLATRONIC	638
CONDOR	638
CONTEC	644
CROSLEY	632
CROWN	638, 644
CRYSTAL	642
CYBERTRON	641
DAINICHI	641
DANSAI	607
DAYTON	644
DECCA	607, 648
DIXI	607, 644
DUMONT	653

TELEVISION (2/4)

Manufacture	Code
ELIN	607
ELITE	641
ELTA	644
EMERSON	642
ERRES	607
FINLANDIA	635, 643, 655
FINLUX	607, 632, 645, 648, 653, 654, 655
FIRSTLINE	640, 644
FISHER	632, 635, 638, 645
FORMENTI	607, 632, 642
FRONTECH	631, 642, 646
FRONTECH/PROTECH	632
FUJITSU	648
FUNAI	640, 646
GBC	632, 642
GEC	607, 634, 648
GELOSO	632, 644
GENEXXA	631, 641
GOODMANS	607, 639, 647, 648, 656
GORENJE	638
GPM	641
GRAETZ	631, 642
GRANADA	607, 635, 642, 643, 648
GRANDIENTE	657
GRANDIN	618
HANSEATIC	607, 642
HCM	618, 644
HINARI	607, 641, 644
HISAWA	618
HUANYU	656
HYPSON	607, 618, 646
ICE	646, 647
IMPERIAL	638, 642
INDIANA	607
INGELEN	631
INTERFUNK	607, 631, 632, 642
INTERVISION	646, 649
ISUKAI	641
ITC	642
ITT	631, 632, 642
JEC	605
KAISUI	618, 641, 644
KAPSCH	631
KENDO	642
KENNEDY	632, 642
KORPEL	607
KOYODA	644
LEYCO	607, 640, 646, 648
LIESENK & TTER	607
LUXOR	632, 642, 643
M ELECTRONIC	631, 644, 645, 654, 655, 656
M-ELECTRONIC	607, 636, 651
MAGNADYNE	632, 649
MAGNAFON	649
MANESTH	639, 646
MARANTZ	607
MARK	607
MATSUI	607, 639, 640, 642, 644, 647, 648
MCMICHAEL	634
MEDIATOR	607

TELEVISION (3/4)

Manufacture	Code
MEMOREX	644
METZ	631
MINERVA	631, 653
MULTITECH	644, 649
NECKERMANN	607, 631
NEI	607, 642
NIKKAI	605, 607, 641, 646, 648
NOBLIKO	649
OCEANIC	631, 632, 642
OSAKI	641, 646, 648
OSO	641
OSUME	648
OTTO VERSAND	607, 631, 632, 642
PALLADIUM	638
PANAMA	646
PATHO CINEMA	642
PAUSA	644
PHILCO	632, 642
PHOENIX	632
PHONOLA	607
PROFEX	642, 644
PROTECH	607, 642, 644, 646, 649
QUELLE	607, 631, 632, 642, 645, 653
R-LINE	607
RBM	653
REDIFFUSION	632, 642
REX	631, 646
ROADSTARO	641, 644, 646
SAISH	639, 644, 646
SALORA	631, 632, 642, 643
SAMBERS	649
SBR	607, 634
SCHAUB LORENZ	642
SEG	642, 646
SEI	632, 640, 649
SELECO	631, 642
SIAREM	632, 649
SINUDYNE	632, 639, 640, 649
SKANTIC	643
SOLAVOX	631
SONOKO	607, 644
SONOLOR	631, 635
SONTEC	607
SOUNDWAVE	607
STANDARD	641, 644
STERN	631
SUSUMU	641
SYSLINE	607
TANDY	631, 641, 648
TASHIKO	634
TATUNG	607, 648
TEC	642
TELEAVIA	636
TELETECH	644
TENSAI	640, 641
THORN	607, 631, 642, 645, 648
TOMASHI	618
TOWADA	642
ULTRAVOX	632, 642, 649

TELEVISION (4/4)

Manufacture	Code
UNIVERSUM	607, 631, 638, 642, 645, 646, 654, 655
VESTEL	607
VOXSON	631
WALTHAM	643
WATSON	607
WATT RADIO	632, 642, 649
WHITE	
WESTINGHOUSE	607
YOKO	607, 642, 646
PIONEER	600, 607, 631, 632, 636, 642, 651

MD RECORDER

Manufacture	Code
SONY	901
KENWOOD	903
SHARP	902
TEAC	904
ONKYO	905
DENON	906
PIONEER	900, 902, 907

Specifications

Amplifier Section

Continuous Power Output (STEREO MODE)
FRONT 80 W + 80 W (DIN 1 kHz, THD 0.9 %, 8Ω)

Continuous Power Output (SURROUND MODE)
FRONT 80 W/ch (1 kHz, THD 0.9 %, 8Ω)
CENTER 80 W (1 kHz, THD 0.9 %, 8Ω)
SURROUND 80 W/ch (1 kHz, THD 0.9 %, 8Ω)

• Above specifications are applicable when the power supply is 230V.

Input (Sensitivity/Impedance)
VCR/DVR, DVD/LD, TV/SAT, CD, AUX,
CD-R/TAPE/MD (, VIDEO) 200 mV/47 kΩ

Frequency Response
VCR/DVR, DVD/LD, TV/SAT, CD, AUX,
CD-R/TAPE/MD (, VIDEO) 5 Hz to 100,000 Hz -3 dB

Output (Level/Impedance)
VCR/DVR, CD-R/TAPE/MD 200 mV/2.2 kΩ

Tone Control
BASS ± 6 dB (100 Hz)
TREBLE ± 6 dB (10 kHz)
LOUDNESS +9 dB/+9 dB (100 Hz/10 kHz)

Signal-to-Noise Ratio
[DIN (Continuous rated power output/50 mW)]
VCR/DVR, DVD/LD, TV/SAT, CD, AUX,
CD-R/TAPE/MD (, VIDEO) 88 dB/64 dB

VIDEO Section

Input (Sensitivity/Impedance)
VCR/DVR, TV/SAT, DVD/LD (, VIDEO) 1 Vp-p/75 Ω

Output (Level/Impedance)
VCR/DVR, TO MONITOR TV 1 Vp-p/75 Ω

Frequency Response
VCR/DVR, TV/SAT, DVD/LD (, VIDEO)
→ TO MONITOR TV 5 Hz to 7 MHz -0 dB

Signal-to-Noise Ratio 55 dB

FM Tuner Section

Frequency Range 87.5 MHz to 108 MHz
Usable Sensitivity Mono: 15.2 dBf, IHF (1.6 μV/75 Ω)
50 dB Quieting Sensitivity Mono: 20.2 dBf
Stereo: 41.2 dBf
Sensitivity (DIN) Mono: 1.1 μV (S/N 26 dB)
Stereo: 50 μV (S/N 46 dB)

Signal-to-Noise Ratio Mono: 76 dB (at 85 dBf)
Stereo: 72 dB (at 85 dBf)
Signal-to-Noise Ratio (DIN) Mono: 62 dB
Stereo: 58 dB
Distortion Stereo: 0.6 % (1 kHz)
Alternate Channel Selectivity 70 dB (400 kHz)
Stereo Separation 40 dB (1 kHz)
Frequency Response 30 Hz to 15 kHz (± 1 dB)
Antenna Input 75 Ω unbalanced

AM Tuner Section

Frequency Range 531 kHz to 1,602 kHz
Sensitivity (IHF, Loop antenna) 350 μV/m
Selectivity 30 dB
Signal-to-Noise Ratio 50 dB
Antenna Loop antenna

Miscellaneous

Power Requirements
UK model AC 230 V, 50/60 Hz
European model AC 220 – 230 V, 50/60 Hz
Power Consumption 220 W
Power Consumption in Standby mode 1.0 W
Dimensions
VSX-709RDS 420 (W) × 158 (H) × 401 (D) mm
VSX-609RDS 420 (W) × 158 (H) × 391 (D) mm
Weight (without package)
VSX-709RDS 8.4 kg
VSX-609RDS 8.4 kg

Furnished Parts

FM Antenna 1
AM Loop Antenna 1
Dry Cell Batteries
VSX-709RDS (SIZE "AA" (IEC LR6)) 2
VSX-609RDS (SIZE "AA" (IEC R6P)) 2
Remote Control Unit 1
Operating Instructions 1

NOTE:

Specifications and the design are subject to possible modifications without notice, due to improvements.

Published by Pioneer Corporation.
Copyright © 1999 Pioneer Corporation.
All rights reserved.

PIONEER CORPORATION 4-1, Meguro 1-Chome, Meguro-ku, Tokyo 153-8654, Japan
PIONEER ELECTRONICS [USA] INC. P.O. BOX 1540, Long Beach, California 90801-1540, U.S.A.
PIONEER ELECTRONICS OF CANADA, INC. 300 Allstate Parkway, Markham, Ontario L3R OP2, Canada
PIONEER ELECTRONIC [EUROPE] N.V. Haven 1087, Keetberglaan 1, 9120 Melsele, Belgium TEL: 03/570.05.11
PIONEER ELECTRONICS AUSTRALIA PTY. LTD. 178-184 Boundary Road, Braeside, Victoria 3195, Australia, TEL: [03] 9586-6300
PIONEER ELECTRONICS DE MEXICO S.A. DE C.V. San Lorenzo Num 1009 3er piso Desp. 302 Col. Del Valle,
Mexico D.F. C.P. 03100 TEL: 5-688-52-90

Free Manuals Download Website

<http://myh66.com>

<http://usermanuals.us>

<http://www.somanuals.com>

<http://www.4manuals.cc>

<http://www.manual-lib.com>

<http://www.404manual.com>

<http://www.luxmanual.com>

<http://aubethermostatmanual.com>

Golf course search by state

<http://golfingnear.com>

Email search by domain

<http://emailbydomain.com>

Auto manuals search

<http://auto.somanuals.com>

TV manuals search

<http://tv.somanuals.com>