

**Pioneer** *sound.vision.soul*

## AUDIO/VIDEO MULTI-CHANNEL RECEIVER

# VSX-816

Register your product at

[www.pioneerelectronics.com](http://www.pioneerelectronics.com) (US)

[www.pioneerelectronics.ca](http://www.pioneerelectronics.ca) (Canada)

- **Protect your new investment**

The details of your purchase will be on file for reference in the event of an insurance claim such as loss or theft.

- **Receive free tips, updates and service bulletins on your new product**

- **Improve product development**

Your input helps us continue to design products that meet your needs.

- **Receive a free Pioneer newsletter**

Registered customers can opt in to receive a monthly newsletter.

## Operating Instructions

Thank you for buying this Pioneer product. Please read through these operating instructions so you will know how to operate your model properly. After you have finished reading the instructions, put them away in a safe place for future reference.

If the AC plug of this unit does not match the AC outlet you want to use, the plug must be removed and appropriate one fitted. Replacement and mounting of an AC plug on the power supply cord of this unit should be performed only by qualified service personnel. If connected to an AC outlet, the cut-off plug can cause severe electrical shock. Make sure it is properly disposed of after removal. The equipment should be disconnected by removing the mains plug from the wall socket when left unused for a long period of time (for example, when on vacation).

D3-4-2-1a\_A\_En

**WARNING** – TO PREVENT FIRE OR SHOCK HAZARD, DO NOT EXPOSE THIS APPLIANCE TO RAIN OR MOISTURE.

D1-4-2-1\_En

**IMPORTANT NOTICE** – THE SERIAL NUMBER FOR THIS EQUIPMENT IS LOCATED IN THE REAR. PLEASE WRITE THIS SERIAL NUMBER ON YOUR ENCLOSED WARRANTY CARD AND KEEP IN A SECURE AREA. THIS IS FOR YOUR SECURITY.

D1-4-2-6-1\_En

**NOTE:** This equipment has been tested and found to comply with the limits for a Class B digital device, pursuant to Part 15 of the FCC Rules. These limits are designed to provide reasonable protection against harmful interference in a residential installation. This equipment generates, uses, and can radiate radio frequency energy and, if not installed and used in accordance with the instructions, may cause harmful interference to radio communications. However, there is no guarantee that interference will not occur in a particular installation. If this equipment does cause harmful interference to radio or television reception, which can be determined by turning the equipment off and on, the user is encouraged to try to correct the interference by one or more of the following measures:

- Reorient or relocate the receiving antenna.
- Increase the separation between the equipment and receiver.
- Connect the equipment into an outlet on a circuit different from that to which the receiver is connected.
- Consult the dealer or an experienced radio/TV technician for help.

D8-10-1-2\_En

This Class B digital apparatus complies with Canadian ICES-003.

Cet appareil numérique de la Classe B est conforme à la norme NMB-003 du Canada.

D8-10-1-3\_FF

#### Information to User

Alteration or modifications carried out without appropriate authorization may invalidate the user's right to operate the equipment.

D8-10-2\_En

**CAUTION:** This product satisfies FCC regulations when shielded cables and connectors are used to connect the unit to other equipment. To prevent electromagnetic interference with electric appliances such as radios and televisions, use shielded cables and connectors for connections.

D8-10-3a\_En

*Manufactured under license from Dolby Laboratories. "Dolby", "Pro Logic", "Surround EX", and the double-D symbol are trademarks of Dolby Laboratories.*

*"DTS", "DTS-ES", "DTS 96/24" and "Neo:6" are trademarks of Digital Theater Systems, Inc.*

**CAUTION** – PREVENT ELECTRIC SHOCK DO NOT USE THIS (POLARIZED) PLUG WITH AN EXTENSION CORD. RECEPTACLE OR OTHER OUTLET UNLESS THE BLADES CAN BE FULLY INSERTED TO PREVENT BLADE EXPOSURE.

**ATTENTION** – POUR PREVENIR LES CHOCS ELECTRIQUES NE PAS UTILISER CETTE FICHE POLARISEE AVEC UN PROLONGATEUR UNE PRISE DE COURANT OU UNE AUTRE SORTIE DE COURANT, SAUF SI LES LAMES PEUVENT ETRE INSEREES A FOND SANS EN LAISSER AUCUNE PARTIE A DECOUVERT.

D2-4-4-1\_EF

**WARNING:** Handling the cord on this product or cords associated with accessories sold with the product will expose you to chemicals listed on proposition 65 known to the State of California and other governmental entities to cause cancer and birth defect or other reproductive harm.

**Wash hands after handling**

D36-P4\_A\_En

For U.S. and Australia Model



C67-7-3\_En



The lightning flash with arrowhead, within an equilateral triangle, is intended to alert the user to the presence of uninsulated "dangerous voltage" within the product's enclosure that may be of sufficient magnitude to constitute a risk of electric shock to persons.

**CAUTION**  
RISK OF ELECTRIC SHOCK  
DO NOT OPEN



**CAUTION:**  
TO PREVENT THE RISK OF ELECTRIC SHOCK, DO NOT REMOVE COVER (OR BACK). NO USER SERVICEABLE PARTS INSIDE. REFER SERVICING TO QUALIFIED SERVICE PERSONNEL.

The exclamation point within an equilateral triangle is intended to alert the user to the presence of important operating and maintenance (servicing) instructions in the literature accompanying the appliance.

D1-4-2-3\_En

# IMPORTANT SAFETY INSTRUCTIONS

**READ INSTRUCTIONS** — All the safety and operating instructions should be read before the product is operated.

**RETAIN INSTRUCTIONS** — The safety and operating instructions should be retained for future reference.

**HEED WARNINGS** — All warnings on the product and in the operating instructions should be adhered to.

**FOLLOW INSTRUCTIONS** — All operating and use instructions should be followed.

**CLEANING** — The product should be cleaned only with a polishing cloth or a soft dry cloth. Never clean with furniture wax, benzene, insecticides or other volatile liquids since they may corrode the cabinet.

**ATTACHMENTS** — Do not use attachments not recommended by the product manufacturer as they may cause hazards.

**WATER AND MOISTURE** — Do not use this product near water — for example, near a bathtub, wash bowl, kitchen sink, or laundry tub; in a wet basement; or near a swimming pool; and the like.

**ACCESSORIES** — Do not place this product on an unstable cart, stand, tripod, bracket, or table. The product may fall, causing serious injury to a child or adult, and serious damage to the product. Use only with a cart, stand, tripod, bracket, or table recommended by the manufacturer, or sold with the product. Any mounting of the product should follow the manufacturer's instructions, and should use a mounting accessory recommended by the manufacturer.

**CART** — A product and cart combination should be moved with care. Quick stops, excessive force, and uneven surfaces may cause the product and cart combination to overturn.



**VENTILATION** — Slots and openings in the cabinet are provided for ventilation and to ensure reliable operation of the product and to protect it from overheating, and these openings must not be blocked or covered. The openings should never be blocked by placing the product on a bed, sofa, rug, or other similar surface. This product should not be placed in a built-in installation such as a bookcase or rack unless proper ventilation is provided or the manufacturer's instructions have been adhered to.

**POWER SOURCES** — This product should be operated only from the type of power source indicated on the marking label. If you are not sure of the type of power supply to your home, consult your product dealer or local power company.

**LOCATION** — The appliance should be installed in a stable location.

**NONUSE PERIODS** — The power cord of the appliance should be unplugged from the outlet when left un-used for a long period of time.

## GROUNDING OR POLARIZATION

- If this product is equipped with a polarized alternating current line plug (a plug having one blade wider than the other), it will fit into the outlet only one way. This is a safety feature. If you are unable to insert the plug fully into the outlet, try reversing the plug. If the plug should still fail to fit, contact your electrician to replace your obsolete outlet. Do not defeat the safety purpose of the polarized plug.

- If this product is equipped with a three-wire grounding type plug, a plug having a third (grounding) pin, it will only fit into a grounding type power outlet. This is a safety feature. If you are unable to insert the plug into the outlet, contact your electrician to replace your obsolete outlet. Do not defeat the safety purpose of the grounding type plug.

**POWER-CORD PROTECTION** — Power-supply cords should be routed so that they are not likely to be walked on or pinched by items placed upon or against them, paying particular attention to cords at plugs, convenience receptacles, and the point where they exit from the product.

**OUTDOOR ANTENNA GROUNDING** — If an outside antenna or cable system is connected to the product, be sure the antenna or cable system is grounded so as to provide some protection against voltage surges and built-up static charges. Article 810 of the National Electrical Code, ANSI/NFPA 70, provides information with regard to proper grounding of the mast and supporting structure, grounding of the lead-in wire to an antenna discharge unit, size of grounding conductors, location of antenna-discharge unit, connection to grounding electrodes, and requirements for the grounding electrode. See Figure A.

**LIGHTNING** — For added protection for this product during a lightning storm, or when it is left unattended and unused for long periods of time, unplug it from the wall outlet and disconnect the antenna or cable system. This will prevent damage to the product due to lightning and power-line surges.

**POWER LINES** — An outside antenna system should not be located in the vicinity of overhead power lines or other electric light or power circuits, or where it can fall into such power lines or circuits. When installing an outside antenna system, extreme care should be taken to keep from touching such power lines or circuits as contact with them might be fatal.

**OVERLOADING** — Do not overload wall outlets, extension cords, or integral convenience receptacles as this can result in a risk of fire or electric shock.

**OBJECT AND LIQUID ENTRY** — Never push objects of any kind into this product through openings as they may touch dangerous voltage points or short-out parts that could result in a fire or electric shock. Never spill liquid of any kind on the product.

**SERVICING** — Do not attempt to service this product yourself as opening or removing covers may expose you to dangerous voltage or other hazards. Refer all servicing to qualified service personnel.

**DAMAGE REQUIRING SERVICE** — Unplug this product from the wall outlet and refer servicing to qualified service personnel under the following conditions:

- When the power-supply cord or plug is damaged.
- If liquid has been spilled, or objects have fallen into the product.
- If the product has been exposed to rain or water.
- If the product does not operate normally by following the operating instructions. Adjust only those controls that are covered by the operating instructions as an improper adjustment of other controls may result in damage and will often require extensive work by a qualified technician to restore the product to its normal operation.
- If the product has been dropped or damaged in any way.
- When the product exhibits a distinct change in performance — this indicates a need for service.

**REPLACEMENT PARTS** — When replacement parts are required, be sure the service technician has used replacement parts specified by the manufacturer or have the same characteristics as the original part. Unauthorized substitutions may result in fire, electric shock, or other hazards.

**SAFETY CHECK** — Upon completion of any service or repairs to this product, ask the service technician to perform safety checks to determine that the product is in proper operating condition.

**WALL OR CEILING MOUNTING** — The product should not be mounted to a wall or ceiling.

**HEAT** — The product should be situated away from heat sources such as radiators, heat registers, stoves, or other products (including amplifiers) that produce heat.

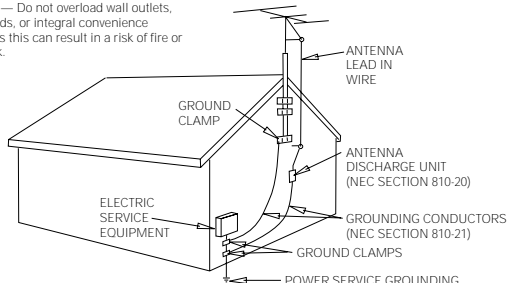

Fig. A

NEC — NATIONAL ELECTRICAL CODE

D1-4-2-2\_En

# Contents

## 01 Before you start

Checking what's in the box .....	6
Loading the batteries .....	6
Installing the receiver .....	6
Ventilation.....	6

## 02 5 minute guide

Introduction to home theater .....	7
Listening to Surround Sound .....	7
Using the Quick Setup .....	8

## 03 Quick surround sound setup

Automatically setting up for surround sound (MCACC).....	9
Other problems when using the Auto MCACC Setup .....	11

## 04 Connecting up

Making cable connections .....	12
Analog audio cables.....	12
Digital audio cables .....	12
Video cables.....	12
Connecting a DVD player and TV .....	13
Connecting the multichannel analog outputs.....	14
Connecting a satellite receiver or other digital set-top box .....	14
Connecting other audio components .....	15
About the WMA9 Pro decoder .....	15
Connecting other video components .....	16
Using the component video jacks .....	17
Connecting to the front panel video terminal .....	17
Connecting antennas .....	18
Using external antennas.....	18
Connecting the speakers .....	19
Hints on speaker placement.....	20
AC outlet.....	21

## 05 Controls and displays

Front panel .....	22
Display .....	23
Remote control.....	25
Operating range of remote control .....	27

## 06 Listening to your system

Auto playback .....	28
Listening in surround sound.....	28

Using the Advanced surround effects.....	29
Setting the effect options .....	29
Listening in stereo.....	30
Listening with Acoustic Calibration EQ .....	30
Using surround back channel processing.....	31
Using Virtual Surround Back (VSB).....	31
Using Midnight and Loudness.....	32
Using the Sound Retriever.....	32
Enhancing dialog .....	32
Using the tone controls .....	32
Playing other sources .....	33
Choosing the input signal .....	33
Selecting the multichannel analog inputs .....	33

## 07 The System Setup menu

Making receiver settings from the System Setup menu.....	34
Surround back speaker setting .....	34
Manual MCACC speaker setup .....	35
Fine Channel Level .....	36
Fine Speaker Distance .....	36
Acoustic Calibration EQ .....	37
Manual speaker setup .....	39
Speaker Setting .....	40
Crossover Network .....	41
Channel Level .....	41
Speaker Distance .....	42

## 08 Using the tuner

Listening to the radio.....	43
Improving FM stereo sound .....	43
Tuning directly to a station .....	43
Saving station presets .....	43
Naming station presets.....	44
Listening to station presets.....	44

## 09 Making recordings

Making an audio or a video recording .....	45
--	----

## 10 Controlling the rest of your system

Operating other Pioneer components .....	46
Setting the remote to control other components .....	46
Selecting preset codes directly .....	47
Erasing one of the remote control button settings .....	47
Erasing all of the remote control presets .....	47
Direct function .....	48

Confirming preset codes .....	48
Controls for TVs .....	49
Controls for other components .....	50

## 11 Other connections

Using XM Radio .....	52
Connecting your XM Radio receiver .....	52
Listening to XM Radio .....	53
Using XM Surround .....	53
Saving channel presets .....	53
Second Zone speaker B setup .....	54
Switching the speaker system .....	54
Bi-amping your front speakers .....	55
Bi-wiring your speakers .....	55
Connecting additional amplifiers .....	56
Using this receiver with a Pioneer plasma display .....	56
Using the SR+ mode with a Pioneer plasma display .....	57

## 12 Other Settings

The Input Assign menu .....	58
The Other Setup menu .....	59
Dynamic Range Control Setup .....	59
Dual Mono Setup .....	60
LFE Attenuator Setup .....	60
SR+ Setup for Pioneer plasma displays ..	60

## 13 Additional information

Troubleshooting .....	61
XM radio messages .....	63
Resetting the main unit .....	63
Switching the speaker impedance .....	63
Specifications .....	64
Power cord caution .....	65
Cleaning the unit .....	65

## Chapter 1: Before you start

### Checking what's in the box

Please check that you've received the following supplied accessories:

- Setup microphone
- Remote control unit
- Dry cell batteries (AA size IEC R6) x2
- AM loop antenna
- FM wire antenna
- These operating instructions

### Loading the batteries

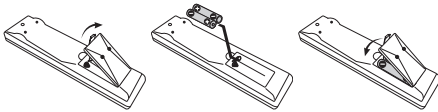

#### Caution

Incorrect use of batteries may result in such hazards as leakage and bursting. Observe the following precautions:

- Never use new and old batteries together.
- Insert the plus and minus sides of the batteries properly according to the marks in the battery case.
- Batteries with the same shape may have different voltages. Do not use different batteries together.
- When disposing of used batteries, please comply with governmental regulations or environmental public instruction's rules that apply in your country or area.

### Installing the receiver

When installing this unit, make sure to put it on a level and stable surface. Don't install it on the following places:

- on a color TV (the screen may distort)
- near a cassette deck (or close to a device that gives off a magnetic field). This may interfere with the sound.
- in direct sunlight
- in damp or wet areas
- in extremely hot or cold areas
- in places where there is vibration or other movement
- in places that are very dusty
- in places that have hot fumes or oils (such as a kitchen)

### Ventilation

When installing this unit, make sure to leave space around the unit for ventilation to improve heat dispersal (at least 8 in. (20 cm) at the top). If not enough space is provided between the unit and walls or other equipment, heat will build up inside, interfering with performance and/or causing malfunctions.

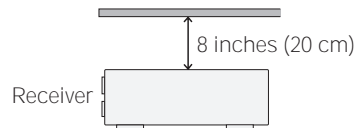

Slot and openings in the cabinet are provided for ventilation and to protect the equipment from overheating. To prevent fire hazard, do not place anything directly on top of the unit, make sure the openings are never blocked or covered with items (such as newspapers, table-cloths and curtains), and do not operate the equipment on thick carpet or a bed.

## Chapter 2: 5 minute guide

### Introduction to home theater

Home theater refers to the use of multiple audio tracks to create a surround sound effect, making you feel like you're in the middle of the action or concert. The surround sound you get from a home theater system depends not only on your speaker setup, but also on the source and the sound settings of the receiver.

This receiver will automatically decode multichannel Dolby Digital, DTS, or Dolby Surround sources according to your speaker setup. In most cases, you won't have to make changes for realistic surround sound, but other possibilities (like listening to a CD with multichannel surround sound) are explained in *Listening to your system* on page 28.

### Listening to Surround Sound

With the following quick setup guide, you should have your system hooked up for surround sound in no time at all. In most cases, you can simply leave the receiver in the default settings.

- Be sure to complete all connections before connecting to an AC power source.

#### 1 Connect your DVD player and TV.

See *Connecting a DVD player and TV* on page 13 to do this. For surround sound, you'll want to hook up using a digital connection from the DVD player to the receiver.

#### 2 Connect your speakers and place them for optimal surround sound.

See *Connecting the speakers* on page 19.

Where you place the speakers will have a big effect on the sound. Place your speakers as shown below for the best surround sound effect. Also see *Hints on speaker placement* on page 20 for more on this.

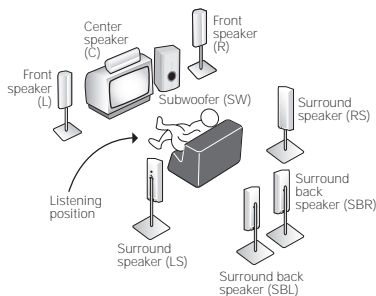

#### 3 Plug in and switch on the receiver, followed by your DVD player, subwoofer and TV.

Make sure you've set the video input on your TV to this receiver. Check the manual that came with the TV if you don't know how to do this.

#### 4 Press QUICK SETUP on the front panel to specify your speaker setup, room size and listening position.

Use the **MULTI JOG** dial to select and **ENTER** to confirm your selection. See *Using the Quick Setup* below for more on this.

#### 5 Play a DVD, and adjust the volume.

Make sure that **DVD** is showing in the receiver's display. If it isn't, press **DVD** on the remote to set the receiver to the DVD input.<sup>1</sup>

There are several other sound options you can select. See *Listening to your system* on page 28 for more on this.<sup>2</sup>

#### Note

<sup>1</sup> You may need to set your DVD player to output Dolby Digital, DTS and 88.2/96kHz PCM (2 channel) audio (see your DVD player's manual for more on this).

<sup>2</sup> Depending on your DVD player or source disc, you may only get 2 channel sound. In this case, the listening mode must be set to **STANDARD** (see *Listening in surround sound* on page 28 if you need to do this) if you want multichannel surround sound.

## Using the Quick Setup

You can use the Quick Setup to get your system up and running with just a few button presses. The receiver automatically makes the necessary settings after you have selected your speaker setup, room size and listening position. Use the front panel controls for the steps below.

- If you want a more complete setup option, refer to *Automatically setting up for surround sound (MCACC)* on page 9. If you choose to do so, you can skip the Quick Setup.<sup>1</sup>

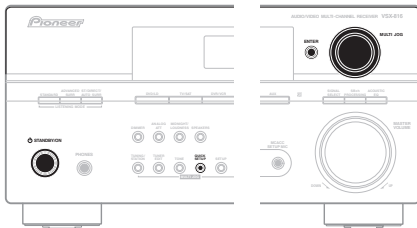

**1 If the receiver is off, press**  
 ⏻ **STANDBY/ON** to turn the power on.

**2 Press QUICK SETUP.**

- SW DET** flashes in the display while the receiver checks your setup for a subwoofer. **SW YES** or **SW NO** confirms the subwoofer check, then the display prompts you to select your speaker setup.

**3 Use the MULTI JOG dial to choose your speaker setup.**

When a subwoofer was detected in step 2, the following choices are available:

**2.1ch – 3.1ch – 4.1ch – 5.1ch – 6.1ch – 7.1ch**

If a subwoofer wasn't detected in step 2, you can cycle between the following choices:

**2.0ch – 3.0ch – 4.0ch – 5.0ch – 6.0ch – 7.0ch**

- Check the table below to find the speaker setup that corresponds with your system.

	Front Speakers	Center Speaker	Surround Speakers	Surround Back Sp.	Sub Woofer
<b>2.0 ch</b>	✓				
<b>2.1 ch</b>	✓				✓
<b>3.0 ch</b>	✓	✓			
<b>3.1 ch</b>	✓	✓			✓
<b>4.0 ch</b>	✓		✓		
<b>4.1 ch</b>	✓		✓		✓
<b>5.0 ch</b>	✓	✓	✓		
<b>5.1 ch</b>	✓	✓	✓		✓
<b>6.0 ch</b>	✓	✓	✓	(1 speaker)	
<b>6.1 ch</b>	✓	✓	✓	(1 speaker)	✓
<b>7.0 ch</b>	✓	✓	✓	(2 speakers)	
<b>7.1 ch</b>	✓	✓	✓	(2 speakers)	✓

**4 Press ENTER.**

**5 Use the MULTI JOG dial to choose your room size.**

Depending on the distance of your speakers from the listening position, choose between small, medium, or large (**S**, **M** or **L**), **M** being an average-sized room.

**6 Press ENTER.**

**7 Use the MULTI JOG dial to choose your listening position.**

You can cycle between the following choices:

- FWD** – If you are nearer to the front speakers than the surround speakers
- MID** – If you are equal distance from the front and surround speakers
- BACK** – If you are nearer to the surround speakers than the front speakers

**8 Press ENTER to confirm your setup.**

The display shows the speaker setup, room size and listening position that you have selected.

### Note

<sup>1</sup> See also *Making receiver settings from the System Setup menu* on page 34 for more setup options.



## Chapter 3:

## Quick surround sound setup

## Automatically setting up for surround sound (MCACC)

The Auto Multi-Channel Acoustic Calibration (MCACC) setup measures the acoustic characteristics of your listening area, taking into account ambient noise, speaker size and distance, and tests for both channel delay and channel level. After you have set up the microphone provided with your system, the receiver uses the information from a series of test tones to optimize the speaker settings and equalization for your particular room.

**Important**

- The Auto MCACC Setup will overwrite any existing speaker settings you've made.
- Make sure the headphones are unplugged.

**Caution**

- The test tones used in the Auto MCACC Setup are output at high volume.

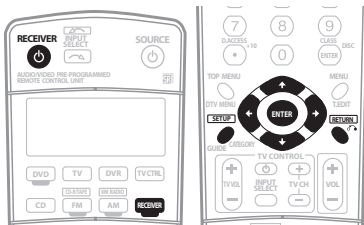

**1 Switch on the receiver and your TV.**

**2 Connect the microphone to the MCACC SETUP MIC jack on the front panel.**

**Note**

- 1 The screensaver automatically starts after three minutes of inactivity. If you cancel the Auto MCACC Setup at any time, the receiver automatically exits and no settings will be made.
- 2 If you are planning on bi-amping your front speakers, or setting up a separate speaker system in another room, read through *Surround back speaker setting* on page 34 and make sure to connect your speakers as necessary before continuing.

Make sure there are no obstacles between the speakers and the microphone.



If you have a tripod, use it to place the microphone so that it's about ear level at your normal listening position. Otherwise, place the microphone at ear level using a table or a chair.

**3 Press RECEIVER on the remote control, then press the SETUP button.**

An on-screen display (OSD) appears on your TV. Use **↑/↓/←/→** and **ENTER** on the remote control to navigate through the screens and select menu items. Press **RETURN** to exit the current menu.

- Press **SETUP** at any time to exit the System Setup menu.<sup>1</sup>

**4 Select 'Auto MCACC' from the System Setup menu then press ENTER.**

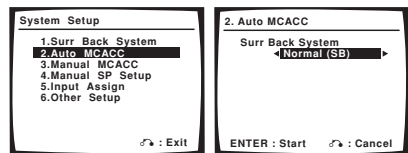

**5 Make sure 'Normal (SB)' is selected then press ENTER.<sup>2</sup>**

Try to be as quiet as possible after pressing **ENTER**. The system outputs a series of test tones to establish the ambient noise level.

## 6 Follow the instructions on-screen.

- Make sure the microphone is connected.
- If you're using a subwoofer, it is automatically detected every time you switch on the system. Make sure it is on and the volume is turned up.
- See below for notes regarding background noise and other possible interference.

## 7 Wait for the test tones to finish.

A progress report is displayed on-screen while the receiver outputs test tones to determine the speakers present in your setup. Try to be as quiet as possible while it's doing this.

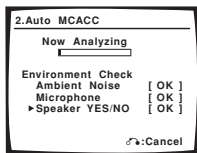

- For correct speaker settings, do not adjust the volume during the test tones.

## 8 Confirm the speaker configuration.

The configuration shown on-screen should reflect the actual speakers you have.

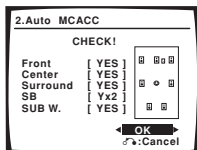

If the speaker configuration displayed isn't correct, use **↑/↓** to select the speaker and **←/→** to change the setting (and number for surround back). When you're finished, go to the next step.

If you see an error message (**ERR**) in the right side column, there may be a problem with the speaker connection. If selecting **RETRY** doesn't fix the problem, turn off the power and check the speaker connections.

## 9 Make sure 'OK' is selected, then press ENTER.

A progress report is displayed on-screen while the receiver outputs more test tones to determine the optimum receiver settings for channel level, speaker distance, and Acoustic Calibration EQ.

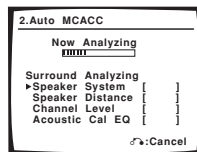

Again, try to be as quiet as possible while this is happening. It may take 3–8 minutes.

## 10 The Auto MCACC Setup has finished! Select 'SKIP' to go back to the System Setup menu.

The MCACC indicator on the front panel will light to show the setup is complete.

The settings made in the Auto MCACC Setup should give you excellent surround sound from your system, but it is also possible to adjust these settings manually using the System Setup menu (starting on page 34).<sup>1</sup>

You can also choose to view the settings by selecting individual parameters from the **Analyzed Data Check** screen:

- **Speaker Setting** – The size and number of speakers you've connected (see page 40 for more on this)
- **Speaker Distance** – The distance of your speakers from the listening position (see page 42 for more on this)

### Note

- Depending on the characteristics of your room, sometimes identical speakers with cone sizes of around 5 inches (12cm) will end up with different size settings. You can correct the setting manually using the *Speaker Setting* on page 40.
  - The subwoofer distance setting may be farther than the actual distance from the listening position. This setting should be accurate (taking delay and room characteristics into account) and generally does not need to be changed.

- **Channel Level** – The overall balance of your speaker system (see page 41 for more on this)
- **Acoustic Cal EQ** – Adjustments to the frequency balance of your speaker system based on the acoustic characteristics of your room (see page 37 for more on this)

Press **RETURN** after you have finished checking each screen. When you're finished, select **SKIP** to go back to the System Setup menu.

### Other problems when using the Auto MCACC Setup

If the room environment is not optimal for the Auto MCACC Setup (too much background noise, echo off the walls, obstacles blocking the speakers from the microphone) the final settings may be incorrect. Check for household appliances (air conditioner, fridge, fan, etc.), that may be affecting the environment and switch them off if necessary. If there are any instructions showing in the front panel display, please follow them.

- Some older TVs may interfere with the operation of the microphone. If this seems to be happening, switch off the TV when doing the Auto MCACC Setup.

## Chapter 4:

## Connecting up

## Making cable connections

**Important**

- Before making or changing connections, switch off the power and disconnect the power cord from the AC outlet.
- Make sure not to bend the cables over the top of this unit. If this happens, the magnetic field produced by the transformers in this unit may cause a humming noise from the speakers.
- Before unplugging the power cord, switch the power into standby.

## Analog audio cables

Use stereo RCA phono cables to connect analog audio components. These cables are typically red and white, and you should connect the red plugs to R (right) terminals and white plugs to L (left) terminals.

Analog audio cables

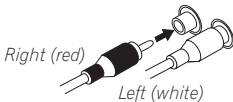

## Digital audio cables

Commercially available coaxial digital audio cables or optical cables should be used to connect digital components to this receiver.<sup>1</sup>



Coaxial digital audio cable

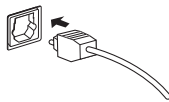

Optical cable

## Video cables

## Standard RCA video cables

These cables are the most common type of video connection and are used to connect to the composite video terminals. The yellow plugs distinguish them from cables for audio.



Standard RCA video cable

## S-video cables

S-video cables give you a clearer picture reproduction than standard RCA video cables by sending separate signals for the luminance and color.



S Video

## Component video cables

Use component video cables to get the best possible color reproduction of your video source. The color signal of the TV is divided into the luminance (**Y**) signal and the color (**P<sub>B</sub>** and **P<sub>R</sub>**) signals and then output. In this way, interference between the signals is avoided.

Component video cables

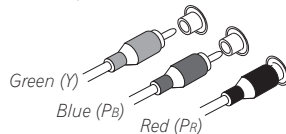
**Note**

- 1 • When connecting optical cables, be careful when inserting the plug not to damage the shutter protecting the optical socket.
- When storing optical cable, coil loosely. The cable may be damaged if bent around sharp corners.
- You can also use a standard RCA video cable for coaxial digital connections.

## Connecting a DVD player and TV

This page shows you how to connect your DVD player and TV to the receiver.

### 1 Connect a coaxial digital audio output on your DVD player to the DIGITAL COAX 1 (DVD/LD) input on this receiver.

Use a coaxial digital audio cable for the connection.<sup>1</sup>

### 2 Connect the composite video output and the stereo analog audio outputs<sup>2</sup> on your DVD player to the DVD/LD inputs on this receiver.

Use a standard RCA video cable<sup>3</sup> and a stereo RCA phono cable for the connection.

- If your DVD player has multichannel analog outputs, see *Connecting the multichannel analog outputs* below for how to connect it.

### 3 Connect the analog audio outputs from your TV to the TV/SAT inputs on this receiver.

This will allow you to play the sound from the TV's built-in tuner. Use a stereo RCA phono cable to do this.

- If your TV has a built-in digital decoder, you can also connect an optical digital audio output from your TV to the **DIGITAL OPT 2 (TV/SAT)** input on this receiver. Use an optical cable for the connection.

### 4 Connect the MONITOR OUT video jack on this receiver to a video input on your TV.

Use a standard RCA video cable to connect to the composite video jack.<sup>4</sup>

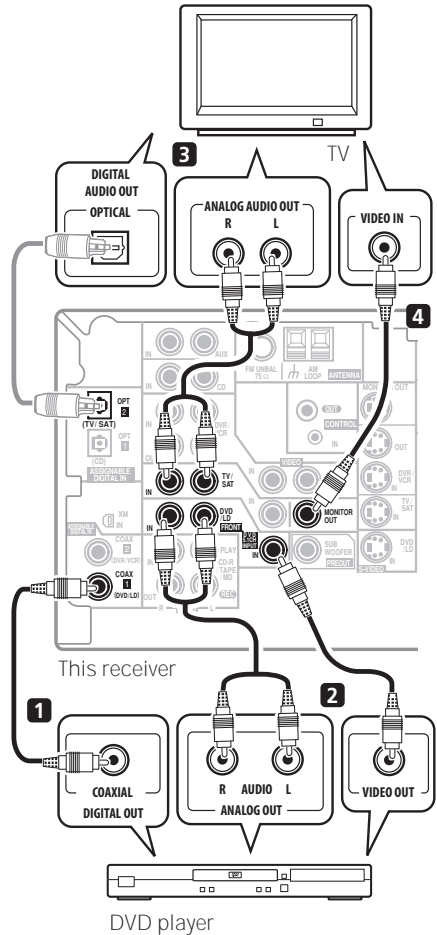

#### Note

<sup>1</sup> If your DVD player only has an optical digital output, you can connect it to the optical input on this receiver using an optical cable. When you set up the receiver you'll need to tell the receiver which input you connected the player to (see *The Input Assign menu* on page 58).

<sup>2</sup> This connection will allow you to make analog recordings from your DVD player.

<sup>3</sup> For better quality, you can also connect with S-video using the **S-VIDEO DVD/LD** jack. If your player also has a component video output, you can connect this too. See *Using the component video jacks* on page 17 for more on this.

<sup>4</sup> For better quality, you can also connect with S-video using the **S-VIDEO MONITOR OUT** jack. See *Using the component video jacks* on page 17 if you want to use the component video outputs to connect this receiver to your TV.

## Connecting the multichannel analog outputs

For DVD Audio and SACD playback, your DVD player may have 5.1 channel analog outputs. In this case, you can connect the multichannel analog outputs to the multichannel inputs of this receiver as shown below.<sup>1</sup>

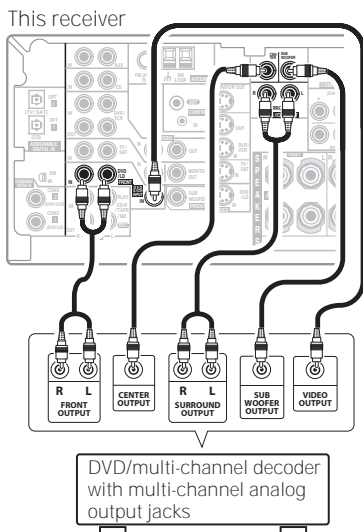

## Connecting a satellite receiver or other digital set-top box

Satellite and cable receivers, and terrestrial digital TV tuners are all examples of so-called 'set-top boxes'.

### 1 Connect a set of audio/video outputs on the set-top box component to the TV/SAT AUDIO and VIDEO inputs on this receiver.<sup>2</sup>

Use a stereo RCA phono cable for the audio connection and a standard RCA video cable for the video connection.<sup>3</sup>

### 2 Connect an optical digital audio output from your set-top box component to the DIGITAL OPT 2 (TV/SAT) input on this receiver.

Use an optical cable for the connection.<sup>4</sup>

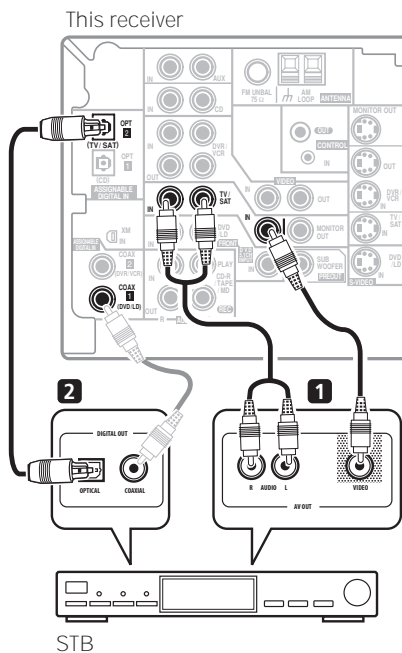

### Note

<sup>1</sup> The multichannel input can only be used when **DVD 5.1 ch** is selected (see page 33).

<sup>2</sup> If you've already connected your TV to the **TV/SAT** inputs, simply choose another input. However, to receive a signal, you'll need to press the input select button for the input you connected the set-top box to.

<sup>3</sup> For better quality, you can also connect with S-video using the **S-VIDEO TV/SAT** jack. If your set-top box also has a component video output, you can connect this too. See *Using the component video jacks* on page 17 for more on this.

<sup>4</sup> If your satellite/cable receiver doesn't have a digital audio output, omit this step. If it only has a coaxial digital output, you can connect it to one of the coaxial inputs on this receiver using a coaxial digital audio cable. When you set up the receiver you'll need to tell the receiver which input you connected the set-top box to (see *The Input Assign menu* on page 58).



However, the connected DVD player, set-top box, etc. must be able to output WMA9 Pro format audio signals through a coaxial or optical digital output.



*Microsoft, Windows Media®, and the Windows logo are trademarks, or registered trademarks of Microsoft Corporation in the United States and/or other countries.*

## Connecting other video components

This receiver has audio/video inputs and outputs suitable for connecting analog or digital video recorders, including VCRs, DVD recorders and HDD recorders.

### 1 Connect a set of audio/video outputs on the recorder to the DVR/VCR AUDIO and VIDEO inputs on this receiver.

Use a stereo RCA phono cable for the audio connection and a standard RCA video cable for the video connection.<sup>1</sup>

### 2 Connect a set of audio/video inputs on the recorder to the DVR/VCR AUDIO and VIDEO outputs on this receiver.

Use a stereo RCA phono cable for the audio connection and a standard RCA video cable for the video connection.<sup>2</sup>

### 3 Connect a coaxial digital audio output on your video component to the DIGITAL COAX 2 (DVR/VCR) input on this receiver.

Use a coaxial digital audio cable for the connection.<sup>3</sup>

#### Note

<sup>1</sup> For better quality, you can also connect with S-video using the **S-VIDEO DVR/VCR IN** jack. If your video component also has a component video output, you can connect this too. See *Using the component video jacks* on page 17 for more on this.

<sup>2</sup> For better quality, you can also connect with S-video using the **S-VIDEO DVR/VCR OUT** jack.

<sup>3</sup> If your video component only has an optical digital output, you can connect it to the optical input on this receiver using an optical cable. When you set up the receiver you'll need to tell the receiver which input you connected the player to (see *The Input Assign menu* on page 58).



## Using the component video jacks

Component video should deliver superior picture quality when compared to composite video. A further advantage (if your source and TV are both compatible) is progressive-scan video, which delivers a very stable, flicker-free picture. See the manuals that came with your TV and source component to check whether they are compatible with progressive-scan video.



### Important

- If you connect any source component to the receiver using a component video input, you must also have your TV connected to this receiver's **COMPONENT VIDEO MONITOR OUT** jacks.

### 1 Connect the component video outputs of your source to a set of component video inputs on this receiver.

Use a three-way component video cable for the connection.

### 2 If necessary, assign the component video inputs to the input source you've connected.

This only needs to be done if you didn't connect according to the following defaults:

- **COMP 1** – DVD
- **COMP 2** – TV
- **COMP 3** – DVR

See *Assigning the component video inputs* on page 58 for more on this.

### 3 Connect the COMPONENT VIDEO MONITOR OUT jacks on this receiver to the component video inputs on your TV or monitor.

Use a three-way component video cable.

## Connecting to the front panel video terminal

Front video connections are accessed via the front panel using the **VIDEO** button. There are standard audio/video jacks as well as an S-video jack and an optical input. Hook them up the same way you made the rear panel connections.

This receiver

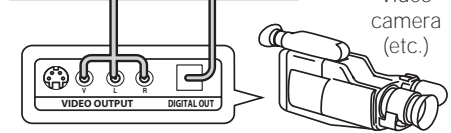
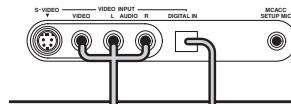

## Connecting antennas

Connect the AM loop antenna and the FM wire antenna as shown below. To improve reception and sound quality, connect external antennas (see *Using external antennas* below).

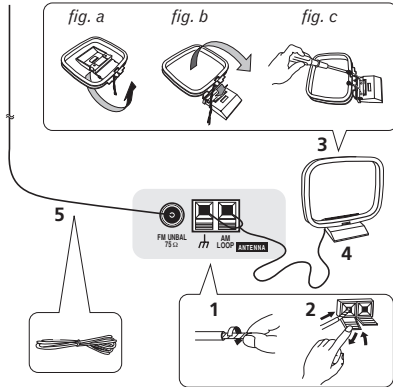

**1 Pull off the protective shields of both AM antenna wires.**

**2 Push open the tabs, then insert one wire fully into each terminal, then release the tabs to secure the AM antenna wires.**

**3 Fix the AM loop antenna to the attached stand.**

To fix the stand to the antenna, bend in the direction indicated by the arrow (*fig. a*) then clip the loop onto the stand (*fig. b*).

- If you plan to mount the AM antenna to a wall or other surface, secure the stand with screws (*fig. c*) before clipping the loop to the stand. Make sure the reception is clear.

**4 Place the AM antenna on a flat surface and in a direction giving the best reception.**

**5 Connect the FM wire antenna in the same way as the AM loop antenna.**

For best results, extend the FM antenna fully and fix to a wall or door frame. Don't drape loosely or leave coiled up.

## Using external antennas

### To improve FM reception

Use an F connector to connect an external FM antenna.

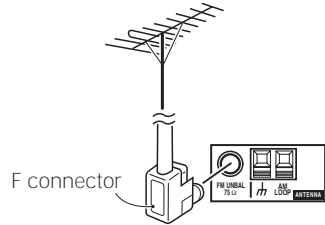

### To improve AM reception

Connect a 15–18 foot length of vinyl-coated wire to the AM antenna terminal without disconnecting the supplied AM loop antenna. For the best possible reception, suspend horizontally outdoors.

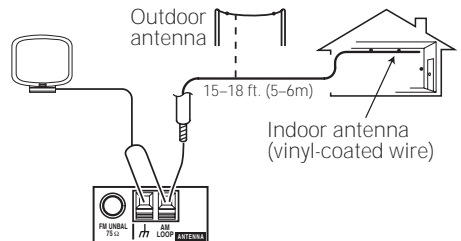

... and inserted fully into the speaker  
... wire to connect the speakers to the receiver.

---

...nge the front speaker setting (see *Speaker Setting* on page 40) to large.  
...ack speaker, connect it to the surround back left (**L**) terminal.



## Overhead view of speaker setup

You can also refer to the 3-D speaker setup illustration on page 7.

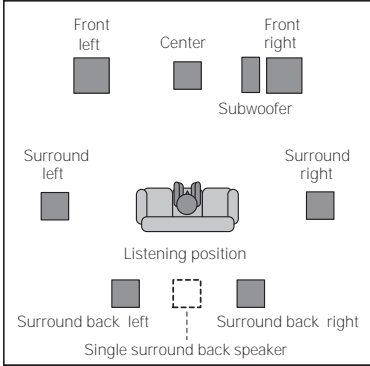

The diagrams below show suggested surround and surround back speaker orientation. The first diagram (fig. A) shows orientation with one surround back speaker (or none) connected. The second (fig. B) shows orientation with two surround back speakers connected.

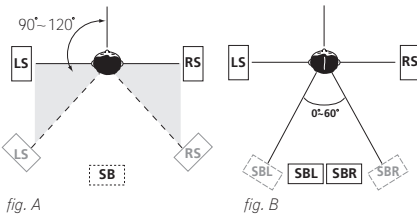

## 3-D view of 7.1 channel speaker setup

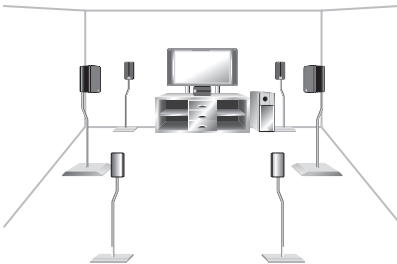

## AC outlet

Power supplied through this outlet is turned on and off by the receiver's power switch. Total electrical power consumption of connected equipment should not exceed 100 W (0.8 A).

- This unit should be disconnected by removing the power plug from the wall socket when not in regular use (ex. when on vacation).

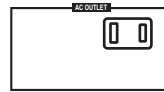

### ⚠ Caution

- Do not connect a TV set, monitor, heater, or similar appliance to this unit's AC outlet.
- Do not connect appliances with high power consumption to the AC outlet in order to avoid overheating and fire risk. This can also cause the receiver to malfunction.
- Since a subwoofer or power amplifier can exceed the 100W maximum when playing sources at a high volume, this type of equipment should not be connected to the AC outlet.





**DIGITAL** – Lights when a digital audio signal is detected.

**DIGITAL** – Lights when a Dolby Digital encoded signal is detected.

**ANALOG** – Lights when an analog signal is detected.

**DTS** – Lights when a source with DTS encoded audio signals is detected.



## 2

When the **STANDARD** mode is on, this lights to indicate decoding of a DTS multichannel signal.

## 3 **DIGITAL**

When the **STANDARD** mode of the receiver is on, this lights to indicate decoding of a Dolby Digital multichannel signal.

## 4 **PRO LOGIC IIx**

When the (**STANDARD**) Pro Logic II mode of the receiver is on,  **PRO LOGIC II** lights to indicate Pro Logic II decoding.  **PRO LOGIC IIx** lights to indicate Pro Logic IIx decoding (see *Listening in surround sound* on page 28).

## 5 **VIR.SB**

Lights during Virtual surround back processing (page 31).

## 6 **DIRECT**

Lights when source direct playback is in use. Direct playback bypasses the tone controls for the most accurate reproduction of a source.

## 7 **AUTO SURR.**

Lights when Auto Surround (see *Auto playback* on page 28) or XM Surround (page 53) is on.

## 8 **ATT**

Lights when **ANALOG ATT** is used to attenuate (reduce) the level of the analog input signal.

## 9 **SLEEP**

Lights when the sleep mode is active (see *Remote control* below).

## 10 **Tuner indicators**

 – Lights when the mono mode is set using the **MPX** button.

 – Lights when a stereo FM broadcast is being received in auto stereo mode.

 – Lights when a broadcast is being received.

## 11 **Speaker indicators**

Lights to indicate the current speaker system, **A** and/or **B** (page 54).

## 12 **Character display**

### 13 **Neo:6**

When the (**STANDARD**) Neo:6 mode of the receiver is on, this lights to indicate Neo:6 processing.

### 14 **ADV.SURR. (Advanced Surround)**

Lights when one of the Advanced Surround modes has been selected.

### 15 **WMA9 Pro**

Lights to indicate decoding of a WMA9 Pro signal.

### 16 **MIDNIGHT**

Lights during Midnight listening (page 32).

### 17 **D.E.**

Lights when Dialog Enhancement (**DIALOG E**) is switched on (page 32).

### 18 **LOUDNESS**

Lights during Loudness listening (page 32).

### 19 **EX**

Lights when a Dolby Digital Surround EX encoded signal is detected.

### 20 **Master volume level**

Shows the overall volume level.

### 21 **MCACC channel EQ / Sound Retriever indicators**

These indicators show the EQ balance for each channel in *Checking your Acoustic Calibration EQ settings* on page 39. Also, **L** and **R** light when the Sound Retriever is active (page 32).



## Remote control

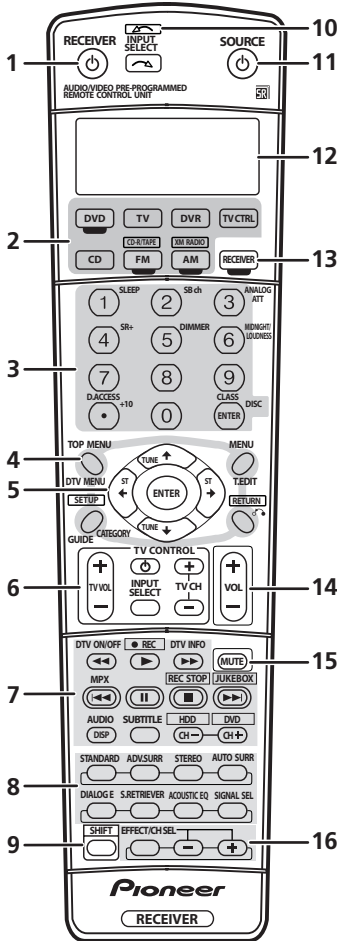

### 1 RECEIVER

This switches between standby and on for this receiver.

### 2 MULTI CONTROL buttons

Press to select control of other components (see *Controlling the rest of your system* on page 46).

### 3 Number buttons and other receiver/component controls

Use the number buttons to directly select a radio frequency (page 43) or the tracks on a CD, DVD, etc.

**DISC (ENTER)** can be used to enter commands for TV or DTV, and can also be used to select a disc in a multi-CD player.

The following are accessed by pressing the **RECEIVER** button first:

**SLEEP** – Press to change the amount of time before the receiver switches into standby (**90 min – 60 min – 30 min – Off**). You can check the remaining sleep time at any time by pressing **SLEEP** once.

**SB ch** – Selects the surround back channel mode (page 31) or virtual surround back mode (page 31).

**ANALOG ATT** – Attenuates (lowers) the level of an analog input signal to prevent distortion.

**SR +** – Switches the SR+ mode on/off (page 57).

**DIMMER** – Dims or brightens the display.

**MIDNIGHT/LOUDNESS** – Use Midnight when listening to movie soundtracks at low volume. Use Loudness to boost the bass and treble at low volume (page 32).

**D.ACCESS** – After pressing, you can access a radio station directly using the number buttons (page 43).

**CLASS** – Switches between the three banks (classes) of radio station presets (page 43).

### 4 Tuner/component control buttons/SETUP

The following button controls (except **SETUP**) can be accessed after you have selected the corresponding **MULTI CONTROL** button (**DVD, FM, AM, TV, etc.**)

**TOP MENU** – Displays the disc 'top' menu of a DVD.

**DTV MENU** – Displays menus on a digital TV.

**MENU** – Displays the disc menu of DVD-Video discs. It also displays TV and DTV menus.

**T.EDIT** – Press to memorize and name a station for recall (page 43).

**SETUP** (Press **RECEIVER** first to access)  
Use to access the System Setup menu (see page 34).

**GUIDE** – Displays the guides on a digital TV.

**RETURN** – Press to confirm and exit the current menu (also use to return to the previous menu with DVDs or to select closed captioning with DTV).

#### 5 **←→↓↑ (TUNE/ST +/-) /ENTER**

Use the arrow buttons when setting up your surround sound system (see page 34). Also used to control DVD menus/options and for deck 1 of a double cassette deck player. Use the **TUNE ↓/↑** buttons to find radio frequencies and use **ST ←/→** to find preset stations (page 43).

#### 6 **TV CONTROL buttons**

These buttons are dedicated to control the TV assigned to the **TV CTRL** button. Thus if you only have one TV to hook up to this system assign it to the **TV CTRL MULTI CONTROL** button. If you have two TVs, assign the main TV to the **TV CTRL** button (see page 46 for more on this).



**TV**  – Use to turn on/off the TV power.

**TV VOL +/-** – Use to adjust the TV volume.

**INPUT SELECT** – Use to select the TV input signal.

**TV CH +/-** – Use to select channels.

#### 7 **Component control buttons**

The main buttons (, , etc.) are used to control a component after you have selected it using the **MULTI CONTROL** buttons.

The controls above these buttons can be accessed after you have selected the corresponding **MULTI CONTROL** button (for example **DVD**, **DVR** or **TV** (when connected to a DTV)).

**DTV ON/OFF** – Switches a digital TV on/off.

**DTV INFO** – Use to bring up information screens on a digital TV.

**MPX** – Switches between stereo and mono reception of FM broadcasts. If the signal is weak then switching to mono will improve the sound quality (page 43).

**AUDIO** – Changes the audio language or channel on DVD discs.

**DISP** – Switches between named station presets and radio frequencies (page 44).

**SUBTITLE** – Displays/changes the subtitles included in multilingual DVD-Video discs.

**CH +/-** – Use to select channels when using a TV, VCR, DVR, etc.

The following DVR controls can be accessed by pressing **SHIFT**:

● **REC** – Starts recording.

**REC STOP** – Stops recording.

**JUKEBOX** – Switches to the Jukebox feature.

**HDD/DVD** – These buttons switch between the hard disk and DVD controls for DVD/HDD recorders.

#### 8 **RECEIVER CONTROL buttons**

**STANDARD** – Press for Standard decoding and to switch between the various Pro Logic IIx and Neo:6 options (page 28).

**ADV.SURR.** – Use to switch between the various surround modes (page 29).

**STEREO** – Switches between direct and stereo playback. Direct playback bypasses the tone controls and any other signal processing for the most accurate reproduction of a source (page 30). Also selects the Auto Surround mode (*Auto playback* on page 28).

**AUTO SURR** – Selects Auto Surround (*Auto playback* on page 28) and XM Surround (page 53).

**DIALOG E** – Use to make dialog stand out when watching TV or a movie (page 32).

**S. RETRIEVER** – Press to restore CD quality sound to compressed audio sources (page 32).

**ACOUSTIC EQ** – Press to select an Acoustic Calibration EQ setting (page 30).

**SIGNAL SEL** – Use to select an input signal (page 33).

## 9 SHIFT

Press to access the DVR controls (above the component control buttons) as well as some receiver controls.

## 10 INPUT SELECT

Use to select the input source (use **SHIFT** for **INPUT SELECT** .

## 11 SOURCE

Press to turn on/off other components connected to the receiver (see page 46 for more on this).

## 12 Character display (LCD)

This display shows information when transmitting control signals.

The following commands are shown when you're setting the remote to control other components (see *Controlling the rest of your system* on page 46):

**SETUP** – Indicates the setup mode, from which you choose the options below.

**PRESET** – See *Selecting preset codes directly* on page 47.

**DIRECT F** – See *Direct function* on page 48.

**ERASE** – See *Erasing one of the remote control button settings* on page 47.

**RESET** – See *Erasing all of the remote control presets* on page 47.

**READ ID** – See *Confirming preset codes* on page 48.

## 13 RECEIVER

Switches the remote to control the receiver (used to select the green commands above the number buttons (**DIMMER**, etc). Also use this button to set up surround sound (page 9, page 34).

## 14 VOL +/-

Use to set the listening volume.

## 15 MUTE

Mutes the sound or restores the sound if it has been muted (adjusting the volume also restores the sound).

## 16 EFFECT/CH SEL

Press repeatedly to select a channel, then use **+/-** to adjust the level (see *Tip* on page 42). Also adjusts the level of the Advanced Surround effects, Dolby Pro Logic IIx Music, and Neo:6 Music parameters (page 29). You can then use the **+/-** buttons to make these adjustments.

## Operating range of remote control

The remote control may not work properly if:

- There are obstacles between the remote control and the receiver's remote sensor.
- Direct sunlight or fluorescent light is shining onto the remote sensor.
- The receiver is located near a device that is emitting infrared rays.
- The receiver is operated simultaneously with another infrared remote control unit.

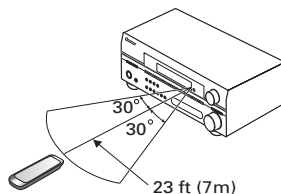

## Chapter 6:

## Listening to your system

**Important**

- Certain features explained in this section will not be possible depending on the source (for example, PCM 88.2 / 96 kHz, DTS 96 kHz (24 bit) or WMA 9 Pro sources).

## Auto playback

The simplest, most direct listening option is the Auto Surround feature. With this, the receiver automatically detects what kind of source you're playing and selects multichannel or stereo playback as necessary.<sup>1</sup>



- **While listening to a source, press AUTO SURR for auto playback of a source.**

Press repeatedly until **AUTOSURR.** shows briefly in the display (it will then show the decoding or playback format). Check the digital format indicators in the display to see how the source is being processed.

- When listening to XM Radio, **AUTO SURR** selects the XM Surround feature (page 53).

## Listening in surround sound

Using this receiver, you can listen to any source in surround sound. However, the options available will depend on your speaker setup and the type of source you're listening to.

If you connected surround back speakers, see also *Using surround back channel processing* on page 31.<sup>2</sup>

The following modes provide basic surround sound for stereo and multichannel sources.



- **While listening to a source, press STANDARD.**

If necessary, press repeatedly to select a listening mode.

- If the source is Dolby Digital, DTS, or Dolby Surround encoded, the proper decoding format will automatically be selected and shows in the display.<sup>3</sup>

With two channel sources, you can select from:

- **Pro Logic IIx MOVIE** – Up to 7.1 channel sound, especially suited to movie sources
- **Pro Logic IIx MUSIC** – Up to 7.1 channel sound, especially suited to music sources
- **Pro Logic IIx GAME** – Up to 7.1 channel sound, especially suited for video games
- **PRO LOGIC** – 4.1 channel surround sound (sound from the surround speakers is mono)
- **Neo:6 CINEMA** – 6.1 channel sound, especially suited to movie sources

### Note

<sup>1</sup> • Stereo surround (matrix) formats are decoded accordingly using **Neo:6 CINEMA** or **Pro Logic IIx MOVIE** (see *Listening in surround sound* above for more on these decoding formats).

• The Auto Surround feature is canceled if you connect headphones or select the multichannel analog inputs.

<sup>2</sup> If surround back processing (page 31) is switched to **OFF**, or the surround back speakers are set to **NO** (this happens automatically if the *Surround back speaker setting* on page 34 is set to anything but **Normal (SB)**), **Pro Logic IIx** becomes **Pro Logic II** (5.1 channel sound).

<sup>3</sup> If surround back processing (page 31) is switched to **OFF**, or the surround back speakers are set to **NO** (page 40), **Pro Logic IIx** becomes **Pro Logic II** (5.1 channel sound).



Setting	What it does	Options
<b>Center Image<sup>b</sup></b> (Applicable only when using a center speaker)	Adjusts the center image to create a wider stereo effect with vocals. Adjust the effect from <b>0</b> (all center channel sent to front right and left speakers) to <b>10</b> (center channel sent to the center speaker only).	0 to 10 Default: <b>3</b>
<b>Effect</b>	Sets the effect level for the currently selected Advanced Surround mode (each mode can be set separately).	10 to 90

a Only available with 2ch sources in Dolby Pro Logic II Music mode (also available with **DD Pro Logic II** 5.1sound).  
 b Only available with 2ch sources in Neo:6 Music mode.

## Listening in stereo

When you select **STEREO** or **DIRECT**, you will hear the source through just the front left and right speakers (and possibly your subwoofer depending on your speaker settings).

Dolby Digital and DTS multichannel sources are downmixed to stereo.



- **While listening to a source, press STEREO for stereo playback.**

Press repeatedly to switch between:

- **STEREO** – The audio is heard with your surround settings and you can still use the Midnight, Loudness, and Tone functions.
- **DIRECT** – Bypass all effects and surround settings so that the audio remains as close to the source audio signal as possible.<sup>1</sup>
- **AUTO SURR.** – See *Auto playback* on page 28 for more on this.

## Listening with Acoustic Calibration EQ

- Default setting: **OFF / ALL CH** (after the Auto MCACC Setup or EQ Auto Setting)

You can listen to sources using the Acoustic Calibration Equalization set in *Automatically setting up for surround sound (MCACC)* on page 9 or *Acoustic Calibration EQ* on page 37. Refer to these pages for more on Acoustic Calibration Equalization.



- **While listening to a source, press ACOUSTIC EQ.**

Press repeatedly to select between:

- **ALL CH** – No special weighting is given to any one channel.
- **F. ALIGN** – All speakers are heard in accordance with the front speaker settings.
- **CUSTOM 1/2** – Custom settings
- **EQ OFF** – Switches Acoustic Calibration EQ off.

The MCACC indicator on the front panel lights when Acoustic Calibration EQ is active.<sup>2</sup>

### Note

- 1 If you switch on Midnight listening, Loudness, Dialog Enhancement, the Sound Retriever or the tone controls when **DIRECT** is selected, the receiver automatically switches to **STEREO**.
- 2 • You can't use Acoustic Calibration EQ with **DVD 5.1ch**, WMA9 Pro or XM Surround, and it has no effect with headphones.
  - If you switch on Acoustic Calibration EQ when **DIRECT** is selected, the receiver automatically switches to **STEREO**.

## Using surround back channel processing

- Default setting: **SB ON**

You can have the receiver automatically use 6.1 decoding for 6.1 encoded sources (for example, Dolby Digital EX or DTS-ES), or you can choose to always use 6.1 decoding (for example, with 5.1 encoded material). With 5.1 encoded sources, a surround back channel will be generated, but the material may sound better in the 5.1 format for which it was originally encoded (in which case, you can simply switch surround back processing off).<sup>1</sup>

The table below indicates when you will hear the surround back channel (●=Sound plays through surround back speaker(s)).

- **Press SB ch (SB ch PROCESSING) to select a surround back channel option.**

Each press cycles through the following:

- **SB ON** – 6.1 decoding is always used (for example, a surround back channel will be generated for 5.1 encoded material)
- **SB AUTO** – Automatically switches to 6.1 decoding for 6.1 encoded sources (for example, Dolby Digital EX or DTS-ES)
- **SB OFF** – Maximum 5.1 playback

## Using Virtual Surround Back (VSB)

When you're not using surround back speakers, selecting this mode allows you to hear a virtual surround back channel through your surround speakers. You can choose to listen to sources with no surround back channel information, or if the material sounds better in the format (for example, 5.1) for which it was originally encoded, you can have the receiver only apply this effect to 6.1 encoded sources like Dolby Digital EX or DTS-ES.<sup>2</sup>

The table indicates when you will hear the virtual surround back channel (●=Sound plays through surround speaker(s)).

- **Press SB ch (SB ch PROCESSING) to select a virtual surround back channel option.**

Each press cycles through the following:

- **VSB ON** – Virtual Surround Back is always used (for example, on 5.1 encoded material)
- **VSB AUTO** – Virtual Surround Back is automatically applied to 6.1 encoded sources (for example, Dolby Digital EX or DTS-ES)
- **VSB OFF** – Virtual Surround Back mode is switched off

Type of source	SBCh Processing / Virtual SB mode	Multichannel sources	Standard			Advanced surround
			Stereo sources			
			Pro Logic II x	Pro Logic	Neo:6	
Analog 2-channel (stereo) sources	ON		● <sup>a</sup>	● <sup>b</sup>	●	●
	AUTO		● <sup>c</sup>		●	●

a Excluding WMA9 Pro format

b Only applicable when using the Virtual Surround Back mode.

c Not applicable when using the Virtual Surround Back mode.

## Using Midnight and Loudness

The Midnight listening feature allows you to hear effective surround sound of movies at low volume levels. The effect automatically adjusts according to the volume at which you're listening. The Loudness listening feature can be used to get good bass and treble from music sources at low volume levels.

- Press **MIDNIGHT/LOUDNESS** to switch between **MIDNIGHT, LOUDNESS, and OFF**.

## Using the Sound Retriever

When audio data is removed during the compression process, sound quality often suffers from an uneven sound image. The Sound Retriever feature employs new DSP technology that helps bring CD quality sound back to compressed 2-channel audio by restoring sound pressure and smoothing jagged artifacts left over after compression.<sup>1</sup>

- Press **S. RETRIEVER** to switch the sound retriever on or off.

## Enhancing dialog

- Default setting: **OFF**

The Dialog Enhancement feature localizes dialog in the center channel to make it stand out from other background sounds in a TV or movie soundtrack.

- Press **DIALOG E** to switch dialog enhancement on or off.

## Using the tone controls

Depending on what you are listening to, you may want to adjust the bass or treble using the front panel tone control.

- 1 Press **TONE** to select the frequency you want to adjust.

Press to switch between **BASS** and **TREBLE**.

- 2 Use the **MULTI JOG** dial to change the amount of bass or treble as necessary.

Wait about five seconds for your changes to be input automatically.

### Note

<sup>1</sup> The Sound Retriever is only applicable to 2-channel sources.



## Playing other sources

- 1 Turn on the power of the playback component.
- 2 Turn on the power of the receiver.
- 3 Select the source you want to playback.  
Use the input select buttons.<sup>1</sup>
- 4 Start playback of the component you selected in step 1.

## Choosing the input signal

- Default setting: **AUTO**

You need to hook up a component to both analog and digital inputs on the rear of the receiver to select between input signals.<sup>2</sup>

- Press **SIGNAL SEL (SIGNAL SELECT)** to select the input signal corresponding to the source component.

Each press cycles through the options as follows:

- **AUTO** – This is the default setting. The receiver selects the first available signal in the following order: **DIGITAL; ANALOG**.
- **ANALOG** – Selects an analog signal.
- **DIGITAL** – Selects an optical or coaxial digital signal.

When set to **DIGITAL** or **AUTO**, **DIGITAL** lights when a Dolby Digital signal is input, and **DTS** lights when a DTS signal is input.

### Note

<sup>1</sup> If your source is the TV's built-in tuner, switch to the channel you want to watch, otherwise make sure that the TV's video input is set to this receiver (For example, if you connected this receiver to the **VIDEO** jacks on your TV, make sure that the **VIDEO** input is selected). Turn down the volume of your TV so that all the sound is coming from the speakers connected to this receiver.

<sup>2</sup> • This receiver can only play back Dolby Digital, PCM (32 kHz to 96 kHz), DTS and WMA9 Pro digital signal formats. With other digital signal formats, set to **ANALOG**.

- You may get digital noise when a LD or CD player compatible with DTS is playing an analog signal. To prevent noise, make the proper digital connections (*Connecting other audio components* on page 15) and set the signal input to **DIGITAL**.

- Some DVD players don't output DTS signals. For more details, refer to the instruction manual supplied with your DVD player.
- 3 • During playback from the multichannel inputs, you can't use any of the sound features/modes and only the volume and channel levels can be set.

- You can't listen to your speaker B (Second Zone) system during playback from the multichannel inputs.

## Selecting the multichannel analog inputs

If you have connected a decoder or a DVD player with multichannel analog outputs to this receiver (page 14), you must select the analog multichannel inputs for surround sound.<sup>3</sup>

- 1 Make sure you have set the playback source to the proper output setting.

For example, you might need to set your DVD player to output multichannel analog audio.

- 2 Press **DVD/LD**.

- 3 Press **SIGNAL SELECT** to select the multichannel analog inputs. **DVD 5.1ch** shows in the display and the **ANALOG** indicator lights.

## Chapter 7:

# The System Setup menu

## Making receiver settings from the System Setup menu

The following section shows you how to make detailed settings to specify how you're using the receiver (for example, if you want to set up two speaker systems in separate rooms), and also explains how to fine-tune individual speaker system settings to your liking.

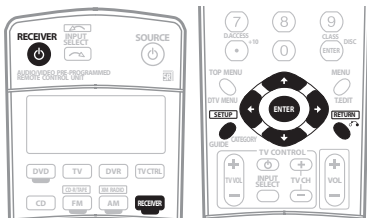

### 1 Switch on the receiver and your TV.

Use the **RECEIVER** button to switch on.<sup>1</sup>

### 2 Press RECEIVER on the remote control, then press the SETUP button.<sup>2</sup>

An on-screen display (OSD) appears on your TV. Use **↑/↓/←/→** and **ENTER** on the remote control to navigate through the screens and select menu items. Press **RETURN** to confirm and exit the current menu.

### 3 Select the setting you want to adjust.

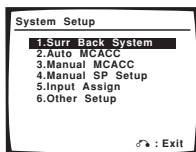

- **Surr Back System** – Specify how you are using your surround back speakers (see *Surround back speaker setting* below).
- **Auto MCACC** – This is a quick and effective automatic surround setup (see *Automatically setting up for surround sound (MCACC)* on page 9).
- **Manual MCACC** – Fine tune your speaker settings and customize the Acoustic Calibration EQ (see *Manual MCACC speaker setup* below).
- **Manual SP Setup** – Specify the size, number, distance and overall balance of the speakers you've connected (see *Manual speaker setup* on page 39).
- **Input Assign** – Specify what you've connected to the digital and component video inputs (see *The Input Assign menu* on page 58).
- **Other Setup** – Make customized settings to reflect how you are using the receiver (see *The Other Setup menu* on page 59).

## Surround back speaker setting

- Default setting: **Normal (SB)**

There are several ways you can use the surround back speaker channels with this system. In addition to a normal home theater setup where they are used for the surround back speakers, they can be used for bi-amping the front speakers or as a separate speaker system in another room.

### Note

- 1 If headphones are connected to the receiver, disconnect them.
- 2 • You can't use the System Setup menu when the XM Radio input is selected.
  - Press **SETUP** at any time to exit the System Setup menu.

## 1 Select 'Surr Back System' from the System Setup menu.

See *Making receiver settings from the System Setup menu* above if you're not already at this screen.

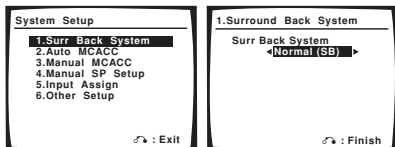

## 2 Select the surround back speaker setting.

- **Normal (SB)** – Select for normal home theater use with surround back speakers in your main (speaker system A) setup.
- **Second Zone** – Select to use the (surround back) B speaker terminals to listen to stereo playback in another room (see *Second Zone speaker B setup* on page 54).
- **Front Bi-Amp** – Select this setting if you're bi-amping your front speakers (see *Bi-amping your front speakers* on page 55).

## 3 When you're finished, press RETURN.

You return to the System Setup menu.

## Manual MCACC speaker setup

You can use the settings in the Manual MCACC setup menu to make detailed adjustments when you're more familiar with the system. Before making these settings, you should have already completed *Automatically setting up for surround sound (MCACC)* on page 9.

You only need to make these settings once (unless you change the placement of your current speaker system or add new speakers).



### Important

- For some of the settings below, you'll have to connect the setup microphone to the front panel and place it about ear level at your normal listening position. See

*Automatically setting up for surround sound (MCACC)* on page 9 if you're unsure how to do this. Also see *Other problems when using the Auto MCACC Setup* on page 11 for notes regarding background noise and other possible interference.

- If you're using a subwoofer, switch it on and turn up the volume as necessary.

## 1 Select 'Manual MCACC' from the System Setup menu.

See *Making receiver settings from the System Setup menu* above if you're not already at this screen.

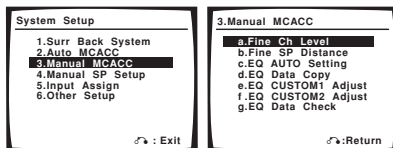

## 2 Select the setting you want to adjust.

If you're doing this for the first time, you might want to make these settings in order.

- **Fine Ch Level** – Make fine adjustments to the overall balance of your speaker system (see *Fine Channel Level* below).
- **Fine SP Distance** – Make precise delay settings for your speaker system (see *Fine Speaker Distance* on page 36).

The last five settings are specifically for customizing the parameters explained in *Acoustic Calibration EQ* below:

- **EQ AUTO Setting** – Measure the acoustic characteristics of your room and automatically adjust the frequency balance of your speaker system (see *Setting the Acoustic Calibration EQ automatically* below).
- **EQ Data Copy** – Copy Acoustic Calibration EQ settings for manual adjustment (see *Copying your Acoustic Calibration EQ settings* below).

- **EQ CUSTOM1/2 Adjust** – Make detailed manual adjustments to your custom Acoustic Calibration EQ settings (see *Setting the Acoustic Calibration EQ manually* on page 38).
- **EQ Data Check** – Check the **ALL CH ADJUST**, **FRONT ALIGN** and custom settings using the on-screen display (see *Checking your Acoustic Calibration EQ settings* on page 39).

## Fine Channel Level

- Default setting: **0dB** (all channels)

You can achieve better surround sound by properly adjusting the overall balance of your speaker system. The following setting can help you make detailed adjustments that you may not achieve using the *Manual speaker setup* on page 39.

### 1 Select 'Fine Ch Level' from the Manual MCACC setup menu.

You'll hear test tones from each speaker in turn. Since the left speaker is the main reference speaker, the level is fixed.



#### Caution

- The test tones used in the System Setup are output at high volume (the volume increases to **-18 dB** automatically).

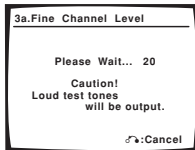
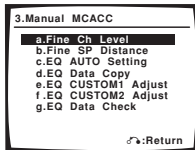

### 2 Select each channel in turn and adjust the levels (+/- 10dB) as necessary.

Use **←/→** to adjust the volume of the speaker you selected to match the reference speaker.

When it sounds like both tones are the same volume, press **ENTER** to confirm and continue to the next channel.

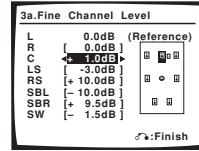

- For comparison purposes, the reference speaker will change depending on which speaker you select.
- If you want to go back and adjust a channel, simply use **↑/↓** to select it.

### 3 When you're finished, press RETURN.

You return to the Manual MCACC setup menu.

## Fine Speaker Distance

- Default setting: **10.0 ft** (all channels)

For proper sound depth and separation with your system, it is necessary to add a slight bit of delay to some speakers so that all sounds will arrive at the listening position at the same time. The following setting can help you make detailed adjustments that you may not achieve using the *Manual speaker setup* below.

### 1 Select 'Fine SP Distance' from the Manual MCACC setup menu.

The volume increases to the reference level.

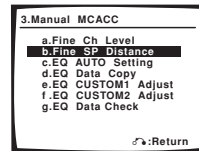

### 2 Adjust the distance of the left channel from the listening position.

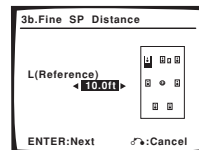

After pressing **ENTER**, test tones will be output.

### 3 Select each channel in turn and adjust the distance as necessary.

Use  $\leftarrow/\rightarrow$  to adjust the delay of the speaker you selected to match the reference speaker. The delay is measured in terms of speaker distance from **0.5 to 45.0** feet.

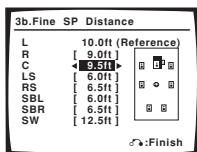

Listen to the reference speaker and use it to measure the target channel. From the listening position, face the two speakers with your arms outstretched pointing at each speaker. Try to make the two tones sound as if they are arriving simultaneously at a position slightly in front of you and between your arm span.

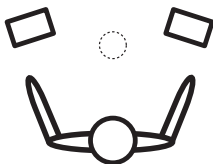

When it sounds like the delay settings are matched up, press **ENTER** to confirm and continue to the next channel.

- For comparison purposes, the reference speaker will change depending on which speaker you select.
- If you want to go back and adjust a channel, simply use  $\uparrow/\downarrow$  to select it.

### 4 When you're finished, press RETURN.

You return to the Manual MCACC setup menu.

## Acoustic Calibration EQ

Acoustic Calibration Equalization is a kind of room equalizer for your speakers (excluding the subwoofer). It works by measuring the acoustic characteristics of your room and neutralizing the ambient characteristics that

can color the original source material. This provides a 'flat' equalization setting. If you're not satisfied with the automatic adjustment, you can also adjust these settings manually to get a frequency balance that suits your tastes.

### Setting the Acoustic Calibration EQ automatically

If you have already completed *Automatically setting up for surround sound (MCACC)* on page 9, **ALL CH ADJUST** and **FRONT ALIGN** (below) should already be set. Therefore, if you want to adjust your settings manually, you can skip to *Setting the Acoustic Calibration EQ manually* below.

#### 1 Select 'EQ AUTO Setting' from the Manual MCACC setup menu.

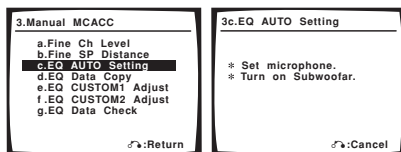

- Make sure the microphone is connected.
- If you're using a subwoofer, it is automatically detected every time you switch on the system. Make sure it is on and the volume is at the middle position.
- See *Other problems when using the Auto MCACC Setup* on page 11 for notes regarding high background noise levels and other possible interference.

#### 2 Wait for the Auto MCACC Setup to finish.

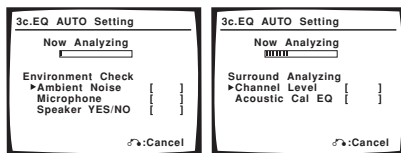

As the receiver outputs test tones, the frequency balance is adjusted automatically for the following settings:

- **ALL CH ADJUST** – A 'flat' setting where all the speakers are set individually so no special weighting is given to any one channel.
- **FRONT ALIGN** – All speakers are set in accordance with the front speaker settings (no equalization is applied to the front left and right channels).

You return to the Acoustic Cal EQ setup menu after the Acoustic Calibration Equalization is set.

### Copying your Acoustic Calibration EQ settings

If you want to manually adjust the Acoustic Calibration EQ (see *Setting the Acoustic Calibration EQ manually* below), we recommend copying the **ALL CH ADJUST** or the **FRONT ALIGN** settings from the **EQ AUTO** setup above (or from *Automatically setting up for surround sound (MCACC)* on page 9) to one of the custom settings. Instead of just a flat EQ curve, this will give you a reference point from which to start.

#### 1 Select 'EQ Data Copy' from the Manual MCACC setup menu.

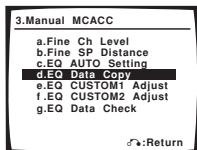

#### 2 Select CUSTOM1 or CUSTOM2 then use ←/→ to select the setting you want to copy.

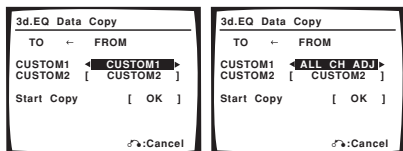

- You can also copy from one custom setting to another. For more on the **ALL CH ADJUST** and **FRONT ALIGN** settings, see *Setting the Acoustic Calibration EQ automatically* above.

#### 3 Select 'OK' to copy and confirm.

### Setting the Acoustic Calibration EQ manually

Before manually adjusting the Acoustic Calibration EQ, we recommend copying the **ALL CH ADJUST** or the **FRONT ALIGN** settings from the auto setup above (or from *Automatically setting up for surround sound (MCACC)* on page 9) to one of the custom settings. Instead of just a flat EQ curve, this will give you a reference point from which to start (see *Copying your Acoustic Calibration EQ settings* above for how to do this).

#### 1 Select 'EQ CUSTOM1 Adjust or EQ CUSTOM2 Adjust' from the Manual MCACC setup menu.

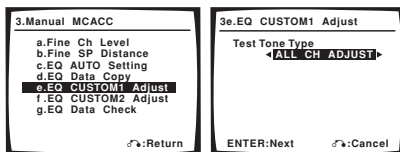

#### 2 Select which method you would like to use to adjust the overall frequency balance.

It is best to choose whichever one you copied to the custom setting in *Copying your Acoustic Calibration EQ settings* above.

- **ALL CH ADJUST** – All the speakers can be set independently so no special weighting is given to any one channel. When adjusting, test tones will sound for each individual channel.
- **FRONT ALIGN** – Speakers are set in accordance with the front speaker settings. The sound of the test tone will alternate between the left front (reference) speaker and the target speaker.

### 3 Select the channel(s) you want and adjust to your liking.

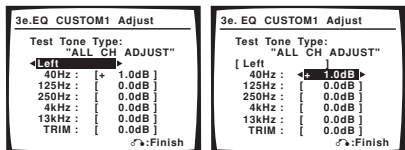

Use **←/→** to select the channel.

Use **↑/↓** to select the frequency and **←/→** to boost or cut the EQ. When you're finished, go back to the top of the screen and use **←/→** to select the next channel.

- The front speakers can't be adjusted if you selected **FRONT ALIGN**.
- The **OVER** indicator shows in the display if the frequency adjustment is too drastic and might distort. If this happens, bring the level down until **OVER** disappears from the display.

#### Tip

- Changing the frequency curve of one channel too drastically will affect the overall balance. If the speaker balance seems uneven, you can raise or lower channel levels using test tones with the **TRIM** feature. Use **↑/↓** to select **TRIM** then use **←/→** to raise or lower the channel level for the current speaker.

### 4 When you're finished, press RETURN.

You return to the Manual MCACC setup menu.

### Checking your Acoustic Calibration EQ settings

After you have completed an automatic or manual Acoustic Calibration EQ adjustment, you can check the **ALL CH ADJUST**, **FRONT ALIGN** and custom settings using the on-screen display.

### 1 Select 'EQ Data Check' from the Manual MCACC setup menu.

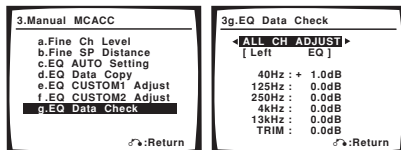

### 2 Select the setting you want to check.

- It is useful to do this while a source is playing so you can compare the different settings.

### 3 Select the channels you want, pressing ENTER when you're finished checking each one.

### 4 When you're finished, press RETURN.

You return to the Manual MCACC setup menu.

## Manual speaker setup

This receiver allows you to make detailed settings to optimize the surround sound performance. You only need to make these settings once (unless you change the placement of your current speaker system or add new speakers.).

These settings are designed to fine-tune your system, but if you're satisfied with the settings made in *Automatically setting up for surround sound (MCACC)* on page 9, it isn't necessary to make all of these settings.

#### Caution

- The test tones used in the System Setup are output at high volume (the volume increases to **-18 dB** automatically).

## 1 Select 'Manual SP Setup' then press ENTER.

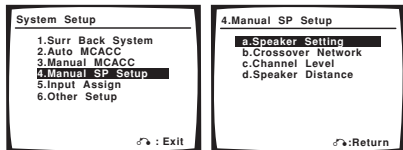

## 2 Select the setting you want to adjust.

If you are doing this for the first time, you may want to adjust these settings in order:

- **Speaker Setting** – Specify the size and number of speakers you've connected (page 40).
- **Crossover Network**– Specify which frequencies will be sent to the subwoofer (see *Crossover Network* below).
- **Channel Level** – Adjust the overall balance of your speaker system (page 41).
- **Speaker Distance** – Specify the distance of your speakers from the listening position (page 42).

## 3 Make the adjustments necessary for each setting, pressing RETURN to confirm after each screen.

### Speaker Setting

Use this setting to specify your speaker configuration (size, number of speakers). It is a good idea to make sure that the settings made in *Automatically setting up for surround sound (MCACC)* on page 9 are correct.

## 1 Select 'Speaker Setting' from the Manual SP Setup menu.

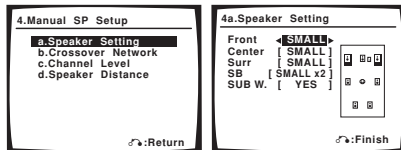

## 2 Choose the set of speakers that you want to set then select a speaker size.

Use  $\leftarrow/\rightarrow$  to select the size (and number) of each of the following speakers:

- **Front** – Select **LARGE** if your front speakers reproduce bass frequencies effectively, or if you didn't connect a subwoofer. Select **SMALL** to send the bass frequencies to the subwoofer.<sup>1</sup>
- **Center** – Select **LARGE** if your center speaker reproduces bass frequencies effectively, or select **SMALL** to send bass frequencies to the other speakers or subwoofer. If you didn't connect a center speaker, choose **NO** (the center channel is sent to the front speakers).
- **Surr** – Select **LARGE** if your surround speakers reproduce bass frequencies effectively. Select **SMALL** to send bass frequencies to the other speakers or subwoofer. If you didn't connect surround speakers choose **NO** (the sound of the surround channels is sent to the front speakers or a subwoofer).

### Note

<sup>1</sup> If you select **SMALL** for the front speakers the subwoofer will automatically be fixed to **YES**. Also, the center, surround, and surround back speakers can't be set to **LARGE** if the front speakers are set to **SMALL**. In this case, all bass frequencies are sent to the subwoofer.



- **SB** – Select the number of surround back speakers you have (one, two or none). Select **LARGE** if your surround back speakers reproduce bass frequencies effectively. Select **SMALL** to send bass frequencies to the other speakers or subwoofer. If you didn't connect surround back speakers choose **NO**.<sup>1</sup>
- **SUB W.** – LFE signals and bass frequencies of channels set to **SMALL** are output from the subwoofer when **YES** is selected (see notes below). Choose the **PLUS** setting if you want the subwoofer to output bass sound continuously or you want deeper bass (the bass frequencies that would normally come out the front and center speakers are also routed to the subwoofer). If you did not connect a subwoofer choose **NO** (the bass frequencies are output from other speakers).

**3 When you're finished, press RETURN.**  
You return to the Manual SP Setup menu.



**Tip**

- If you have a subwoofer and like lots of bass, it may seem logical to select **LARGE** for your front speakers and **PLUS** for the subwoofer. This may not, however, yield the best bass results. Depending on the speaker placement of your room you may actually experience a decrease in the amount of bass due to low frequency cancellations. In this case, try changing the position or direction of speakers. If you can't get good results, listen to the bass response with it set to **PLUS** and **YES** or the front speakers set to **LARGE** and **SMALL** alternatively and let your ears judge which

sounds best. If you're having problems, the easiest option is to route all the bass sounds to the subwoofer by selecting **SMALL** for the front speakers.

## Crossover Network

- Default setting: **100Hz**

This setting decides the cutoff between bass sounds playing back from the speakers selected as **LARGE**, or the subwoofer, and bass sounds playing back from those selected as **SMALL**. It also decides where the cutoff will be for bass sounds in the LFE channel.<sup>2</sup>

**1 Select 'Crossover Network' from the Manual SP Setup menu.**

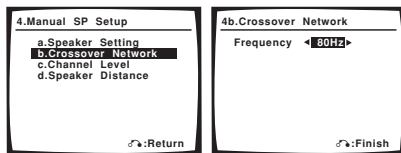

**2 Choose the frequency cutoff point.**

Frequencies below the cutoff point will be sent to the subwoofer (or **LARGE** speakers).

**3 When you're finished, press RETURN.**  
You return to the Manual SP Setup menu.

## Channel Level

Using the channel level settings, you can adjust the overall balance of your speaker system, an important factor when setting up a home theater system.

**Note**

- <sup>1</sup> • If the surround speakers are set to **NO**, the surround back speakers will automatically be set to **NO**.
- If you selected **Second Zone** or **Front Bi-Amp** (in *Surround back speaker setting* on page 34) you can't adjust the surround back settings.
  - If you select one surround back speaker only, make sure that speaker is hooked up to the left surround back terminal.
- <sup>2</sup> For more on selecting the speaker sizes, see *Speaker Setting* above.



## Chapter 8: Using the tuner

### Listening to the radio

The following steps show you how to tune in to FM and AM radio broadcasts using the automatic (search) and manual (step) tuning functions. If you already know the frequency of the station you want, see *Tuning directly to a station* below. Once you are tuned to a station you can memorize the frequency for recall later—see *Saving station presets* on the next page for more on how to do this.

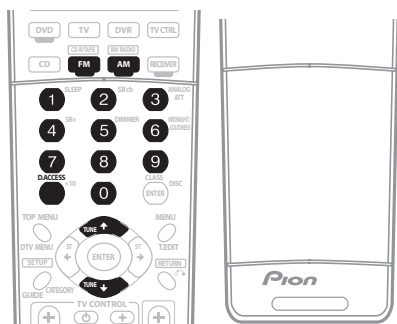

- 1 Press FM or AM to select the band.
- 2 Tune to a station.

There are three ways to do this:

#### Automatic tuning

To search for stations in the currently selected band, press and hold **TUNE**  $\uparrow/\downarrow$  for about a second. The receiver will start searching for the next station, stopping when it has found one. Repeat to search for other stations.

#### Manual tuning

To change the frequency one step at a time, press **TUNE**  $\uparrow/\downarrow$ .

#### High speed tuning

Press and hold **TUNE**  $\uparrow/\downarrow$  for high speed tuning. Release the button at the frequency you want.

#### Improving FM stereo sound

If the (tuned) or (stereo) indicators don't light when tuning to an FM station because the signal is weak, press the **MPX** button to switch the receiver into mono reception mode. This should improve the sound quality and allow you to enjoy the broadcast.

#### Tuning directly to a station

Sometimes, you'll already know the frequency of the station you want to listen to. In this case, you can simply enter the frequency directly using the number buttons on the remote control.

- 1 Press FM or AM to select the band.
- 2 Press **D.ACCESS** (Direct Access).

- 3 Use the number buttons to enter the frequency of the radio station.

For example, to tune to **106.00** (FM), press **1, 0, 6, 0, 0**.

If you make a mistake halfway through, press **D.ACCESS** twice to cancel the frequency and start over.

#### Saving station presets

If you often listen to a particular radio station, it's convenient to have the receiver store the frequency for easy recall whenever you want to listen to that station. This saves the effort of manually tuning in each time. This unit can

memorize up to 30 stations, stored in three banks, or classes, (A, B and C) of 10 stations each. When saving an FM frequency, the **MPX** setting (see previous page) is also stored.<sup>1</sup>

### 1 Tune to a station you want to memorize.

See *Listening to the radio* on the previous page for more on this.

### 2 Press T.EDIT (TUNER EDIT).

The display shows **ST. MEMORY**, then a blinking memory class.

### 3 Press CLASS to select one of the three classes then press ST ←/→ to select the station preset you want.

You can also use the number buttons or the **MULTI JOG** dial (front panel) to select a station preset.

### 4 Press ENTER.

After pressing **ENTER**, the preset class and number stop blinking and the receiver stores the station.

## Naming station presets

For easier identification, you can name your station presets.

### 1 Choose the station preset you want to name.

See *Listening to station presets* below for how to do this.

### 2 Press T.EDIT (TUNER EDIT).

The display shows **ST. NAME**, then a blinking cursor at the first character position.

### 3 Input the name you want.

Choose a name up to four characters long.

- Use the **MULTI JOG** dial (front panel) or the **ST ←/→** buttons (remote) to select characters.
- Press **ENTER** to confirm a character. If no character is input, a space is input.

- The name is stored when **ENTER** is pressed after choosing the fourth character.

### Tip

- To erase a station name, simply repeat steps 1-3 and input four spaces instead of a name.
- Once you have named a station preset, you can press **DISP** when listening to a station to switch the display between name and frequency.

## Listening to station presets

You will need to have some presets stored to do this. See *Saving station presets* above if you haven't done this already.

### 1 Press FM, then press CLASS to select the class in which the station is stored.

Press repeatedly to cycle through classes A, B and C.

### 2 Press ST ←/→ to select the station preset you want.

- You can also use the number buttons on the remote control to recall the station preset.

### Note

<sup>1</sup> If the receiver is left disconnected from the AC power outlet for over a month, the station memories will be lost and will have to be reprogrammed.

## Chapter 9: Making recordings

### Making an audio or a video recording

You can make an audio or a video recording from the built-in tuner, or from an audio or video source connected to the receiver (such as a CD player or TV).

Keep in mind you can't make a digital recording from an analog source or vice-versa, so make sure the components you are recording to/from are hooked up in the same way (see *Connecting up* on page 12 for more on connections).

If you want to record a video source, you also need to use the same type of connection for the source as for the recorder. For example, you can't record a component hooked up to S-video jacks with a recorder hooked up to the composite video outputs (see page 16 for more on video connections).

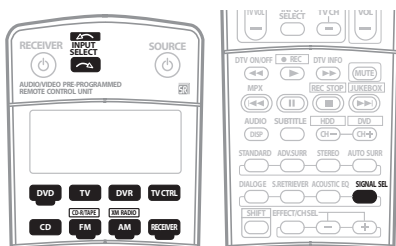

**1 Select the source you want to record.**  
Use the **MULTI CONTROL** buttons (or **INPUT SELECT**).

**2 Select the input signal (if necessary).**

Press **SIGNAL SEL** to select the input signal corresponding to the source component (see page 33 for more on this).

**3 Prepare the source you want to record.**

Tune to the radio station, load the CD, video, DVD etc.

**4 Prepare the recorder.**

Insert a blank tape, MD, video etc. into the recording device and set the recording levels.

Refer to the instructions that came with the recorder if you are unsure how to do this. Most video recorders set the audio recording level automatically—check the component's instruction manual if you're unsure.

**5 Start recording, then start playback of the source component.**<sup>1</sup>

**Note**

- <sup>1</sup> • The receiver's volume, balance, tone (bass, treble, loudness), and surround effects have no effect on the recorded signal.
- Some digital sources are copy-protected, and can only be recorded in analog.
- Some video sources are copy-protected. These cannot be recorded.
- Recording from XM Radio is not possible.

## Chapter 10:

# Controlling the rest of your system

## Operating other Pioneer components

Many Pioneer components have SR **CONTROL** jacks which can be used to link components together so that you can use just the remote sensor of one component. When you use a remote control, the control signal is passed along the chain to the appropriate component.<sup>1</sup>

Note that if you use this feature, *make sure that you also have at least one set of analog audio or video jacks connected to another component for grounding purposes.*

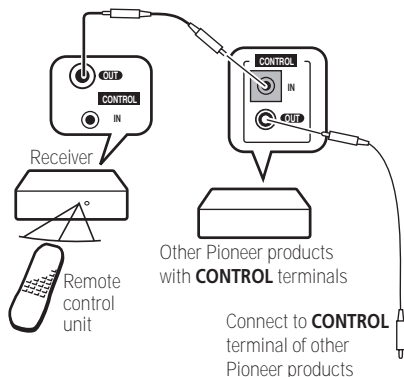

## Setting the remote to control other components

Most components can be assigned to one of the **MULTI CONTROL** buttons using the component's manufacturer preset code stored in the remote.

However, please note that there are cases where only certain functions may be controllable after assigning the proper preset code, or the codes for the manufacturer in the remote control will not work for the model that you are using.<sup>2</sup>

### Note

- You can cancel or exit any of the steps by pressing **RECEIVER**. To go back a step, press **RETURN**.
- After one minute of inactivity, the remote automatically exits the operation.

### Note

1 • If you want to control all your components using this receiver's remote control, refer to *Controlling the rest of your system* on page 46.

• If you have connected a remote control to the **CONTROL IN** jack (using a mini-plug cable), you won't be able to control this unit using the remote sensor.

2 • TV codes (for example, codes for TV, CATV, Satellite TV or DTV) can only be assigned to the **TV/SAT** or **TV CTRL** button.

• If you assign the **FM** or **AM** function to another component, you will have to reassign it to the Pioneer preset code to use this receiver's built-in tuner.

## Selecting preset codes directly

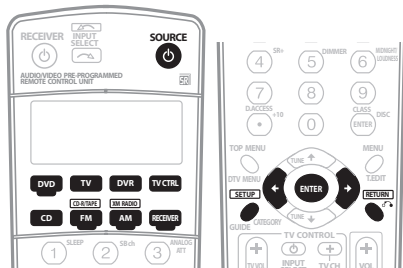

- 1 While pressing the **RECEIVER** button, press and hold the **SETUP** button.  
The remote LCD display shows **SETUP**.
- 2 Use **↑/↓** to select **PRESET** then press **ENTER**.
- 3 Press the **MULTI CONTROL** button for the component you want to control then press **ENTER**.  
The LCD on the remote displays the component you want to control.<sup>1</sup>
- 4 Use **↑/↓** to select the first letter of the brand name of your component then press **ENTER**.  
This should be the manufacturer's name (for example, **P** for Pioneer).
- 5 Use **↑/↓** to select the manufacturer's name from the list then press **ENTER**.
- 6 Use **↑/↓** to select the proper code from the list, then try using this remote control with your component.  
The code should start with the component type (for example, **DVD 009**). If there is more than one, start with the first one.  
To try out the remote control, switch the component on or off (into standby) by pressing **SOURCE** . If it doesn't seem to work, select the next code from the list (if there is one).

### Note

<sup>1</sup> You can't assign the **RECEIVER** button.

- 7 If your component is controlled successfully, press **ENTER** to confirm.  
The remote LCD display shows **OK**.

## Erasing one of the remote control button settings

This erases a control assigned to one of the buttons and restores it to the factory default.

- 1 While pressing the **RECEIVER** button, press and hold the **SETUP** button.  
The remote LCD display shows **SETUP**.
- 2 Use **↑/↓** to select **ERASE** then press **ENTER**.
- 3 Press the **MULTI CONTROL** button corresponding to the button setting to be erased then press **ENTER**.  
The LCD on the remote displays the component.
- 4 Press and hold the button to be erased for **two seconds**.  
The LCD display shows **OK** or **NO CODE** to confirm the button has been erased.
- 5 Repeat step 4 to erase other buttons.
- 6 Press the **RECEIVER** button when you're done.

## Erasing all of the remote control presets

This will erase all preset remote control preset codes.

- 1 While pressing the **RECEIVER** button, press and hold the **SETUP** button.  
The remote LCD display shows **SETUP**.
- 2 Use **↑/↓** to select **RESET** then press **ENTER**.

### 3 Press and hold ENTER for about two seconds.

The LCD shows **OK** to confirm the remote presets have been erased.

## Direct function

- Default setting: **ON**

You can use the direct function feature to control one component using the remote control while at the same time, using your receiver to playback a different component. This could let you, for example, use the remote control to set up and listen to a CD on the receiver and then use the remote control to rewind a tape in your VCR while you continue to listen to your CD player.

When direct function is on, any component you select (using the **MULTI CONTROL** buttons) will be selected by both the receiver and the remote control. When you turn direct function off, you can operate the remote control without affecting the receiver.<sup>1</sup>

### 1 While pressing the RECEIVER button, press and hold the SETUP button.

The remote LCD display shows **SETUP**.

### 2 Use ↑/↓ to select DIRECT F then press ENTER.

### 3 Press the MULTI CONTROL button for the component you want to control then press ENTER.

The LCD on the remote displays the component you want to control.

### 4 Use ↑/↓ to switch direct function ON or OFF then press ENTER.

The LCD shows **OK** to confirm the setting.

## Confirming preset codes

Use this feature to check which preset code is assigned to a **MULTI CONTROL** button.

### 1 While pressing the RECEIVER button, press and hold the SETUP button.

The remote LCD display shows **SETUP**.

### 2 Use ↑/↓ to select READ ID then press ENTER.

### 3 Press the MULTI CONTROL button of the component for which you want to check the preset code.

The brand name and preset code appears in the display for three seconds.

#### Note

<sup>1</sup> You can't use direct function with the **TV CTRL** function.



## Controls for TVs

This remote control can control components after entering the proper codes or teaching the receiver the commands (see *Operating other Pioneer components* on page 46 for more on this). Use the **MULTI CONTROL** buttons to select the component

- The **TV CONTROL** buttons on the remote control are dedicated to control the TV assigned to the **TV CTRL** button. If you have two TVs, assign the main TV to the **TV CTRL** button.

Button(s)	Function	Components
TV	Switches the DTV on or off.	DTV
	Switches the TV or CATV between standby and on.	Cable TV/Satellite TV/TV
<b>INPUT SELECT</b>	Switches the TV input. (Not possible with all models.)	TV
<b>TV CH +/-</b>	Selects channels.	Cable TV/Satellite TV/TV/DTV
<b>TV VOL +/-</b>	Adjust the TV volume.	Cable TV/Satellite TV/TV/DTV
<b>SOURCE</b>	Press to switch the component assigned to the <b>TV CTRL</b> button on or off.	Cable TV/Satellite TV/TV/DTV
	Switches the DTV on or off.	DTV
	Press to get information on DTV programs.	DTV
	Use to choose the BLUE commands on a DTV menu.	DTV
	Use to choose the YELLOW commands on a DTV menu.	DTV
	Use to choose the GREEN commands on a DTV menu.	DTV
	Use to choose the RED commands on a DTV menu.	DTV
<b>AUDIO</b>	Use to switch DTV audio tracks.	DTV
<b>DTV MENU</b>	Press to display the DTV menu.	DTV
<b>GUIDE</b>	Use as the <b>GUIDE</b> button for navigating.	Cable TV/Satellite TV/TV/DTV
<b>RETURN</b>	Use to select closed captioning with DTV.	DTV
Number Buttons	Use to select a specific TV channel.	Cable TV/Satellite TV/TV/DTV
<b>+10</b> button	Use to add a decimal points when selecting TV channels.	DTV
<b>ENTER/ DISC</b>	Use to enter a channel.	Cable TV/Satellite TV/TV/DTV

Button(s)	Function	Components
<b>MENU</b>	Select different menus from the DTV functions.	DTV
	Select the menu screen.	Cable TV/Satellite TV/TV
<b>←→↓↑ &amp; ENTER</b>	Press to select or adjust and navigate items on the menu screen.	Cable TV/Satellite TV/TV/DTV

## Controls for other components

This remote control can control these components after entering the proper codes or teaching the receiver the commands (see *Operating other Pioneer components* on page 46 for more on this). Use the **MULTI CONTROL** buttons to select the component.

Button (s)	Function	Components
<b>SOURCE</b> 	Press to switch the component between standby and on.	CD/MD/CD-R/VCR/DVD/LD/DVR player/Cassette deck
<b>◀◀</b>	Press to return to the start of the current track. Repeated presses skips to the start of previous tracks.	CD/MD/CD-R/DVD/LD player
	Go back channels (channel -).	DVR/VCR
<b>▶▶</b>	Press to advance to the start of the next track. Repeated presses skips to the start of following tracks.	CD/MD/CD-R/DVD/LD player
	Go forward channels (channel +).	VCR
<b>  </b>	Pause playback or recording.	CD/MD/CD-R/VCR/DVD/LD/DVR player/Cassette deck
<b>▶</b>	Start playback.	CD/MD/CD-R/VCR/DVD/LD/DVR player/Cassette deck
<b>▶▶▶</b>	Hold down for fast forward playback.	CD/MD/CD-R/VCR/DVD/LD/DVR player/Cassette deck
<b>◀◀◀</b>	Hold down for fast reverse playback.	CD/MD/CD-R/VCR/DVD/LD/DVR player/Cassette deck
<b>■</b>	Stops playback (on some models, pressing this when the disc is already stopped will cause the disc tray to open).	CD/MD/CD-R/VCR/DVD/LD/DVR player/Cassette deck
<b>● REC (SHIFT+▶)</b>	Starts recording. To prevent accidental recording, this button must be pressed twice to take effect.	MD/CD-R/VCR/ DVR player/ Cassette deck
<b>REC STOP (SHIFT+■)</b>	Stops recording.	DVR player

Button (s)	Function	Components
<b>JUKEBOX</b> (SHIFT+▶▶▶)	Switches to the Jukebox feature.	DVR player
Number buttons	Directly access tracks on a program source.	CD/MD/CD-R/VCR/LD player
	Use the number buttons to navigate the on-screen display.	DVD/DVR player
<b>+10</b> button	Selects tracks higher than 10. (For example, press <b>+10</b> then <b>3</b> to select track 13.)	CD/MD/CD-R/VCR/LD player
<b>ENTER/</b> <b>DISC</b>	Chooses the disc.	Multiple CD player
	Ejects the disc.	MD player
	Use as the <b>ENTER</b> button.	VCR
	Use as the <b>CLEAR</b> button.	DVD
	Displays the setup screen for DVR players.	DVR player
	Changes sides of the LD.	LD player
<b>TOP MENU</b>	Displays the disc 'top' menu of a DVD player.	DVD/DVR player
<b>MENU</b>	Displays menus for the current DVD or DVR you are using.	DVD/DVR player
<b>↑</b>	Pauses the tape.	Cassette deck
<b>↓</b>	Stops the tape.	Cassette deck
<b>ENTER</b>	Starts playback.	Cassette deck
<b>←/→</b>	Fast rewinds/fast forwards the tape.	Cassette deck
<b>←→↓↑ &amp;</b> <b>ENTER</b>	Navigates DVD menu/options.	DVD/DVR Player
<b>GUIDE</b>	Press to access the DVD player setup screen.	DVD/DVR Player
<b>CH +/-</b>	Selects channels.	VCR/DVD/DVR Player
	Selects tracks.	CD/MD/CD-R/Cassette deck
<b>AUDIO</b>	Changes the audio language or channel.	DVD/DVR Player
<b>SUBTITLE</b>	Displays/changes the subtitles on multilingual DVDs.	DVD/DVR Player
<b>HDD (SHIFT + CH-)</b>	Switches to the hard disk controls when using a DVD/ HDD recorder.	DVR Player
<b>DVD (SHIFT + CH+)</b>	Switches to the DVD controls when using a DVD/HDD recorder.	DVR Player

## Chapter 11: Other connections

### Caution

- Before making or changing the connections, switch off the power and disconnect the power cord from the power outlet. Plugging in components should be the last connection you make with your system.
- Do not allow any contact between speaker wires from different terminals.
- You can use speakers with a nominal impedance between 6–16Ω (please see *Switching the speaker impedance* on page 63 if you plan to use speakers with an impedance of less than 8Ω).

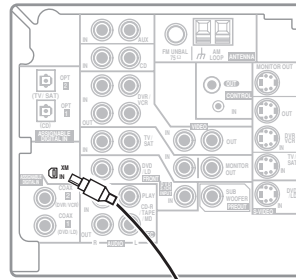

This receiver

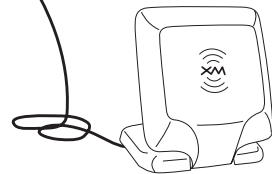

Connect-and-Play antenna

## Using XM Radio

XM is the leading provider of satellite radio service in the United States. Through two high-power satellites, *Rock and Roll*, XM Radio service offers over 150 channels of music, news, talk, sports and children's programming on a monthly subscription basis. XM Radio offers consumers clear sound quality from digital signal radios, an extensive variety of programming and nationwide coverage. Visit [www.xmradio.com](http://www.xmradio.com) for more details on this service.

### Connecting your XM Radio receiver

After purchasing a Connect-and-Play™ antenna (sold separately), you will also need to activate the XM Radio digital radio service to receive broadcasts.<sup>1</sup>

#### 1 Connect an XM Radio Connect-and-Play™ antenna to the XM Radio jack on the rear of this receiver.

You will also need to activate the XM Radio service.

#### 2 Press **XM RADIO (SHIFT+AM)** to switch to the XM RADIO input.

For best reception, you may need to move the Connect-and-Play™ antenna near a window (the southernmost window should produce the best results).

- If after pressing **XM RADIO** the display shows **Check Antenna**, try disconnecting the antenna and reconnecting.

### Note

<sup>1</sup> Hardware and required basic monthly subscription sold separately. Premium Channel available at additional monthly cost. Installation costs and other fees and taxes, including a one-time activation fee may apply. Subscription fee is consumer only. All fees and programming subject to change. Channels with frequent explicit language are indicated with an XL. Channel blocking is available for XM radio receivers by calling 1-800-XMRADIO. Subscriptions subject to Customer Agreement available at [xmradio.com](http://xmradio.com). Only available in the 48 contiguous United States.

## Listening to XM Radio

After connecting, you will be able to use this receiver to select channels and navigate categories using the on-screen display.<sup>1</sup> The information displayed is as follows:

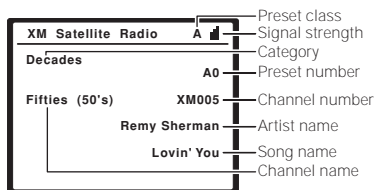

- You can press **DISP** to change XM Radio information in the front panel display.
- The currently selected channel is automatically chosen (without pressing **ENTER**) after 5 seconds.

## Selecting channels and browsing by genre

From the XM Channel Guide, you can browse XM Radio channels in the order that they appear, or you can narrow your channel search by genre.

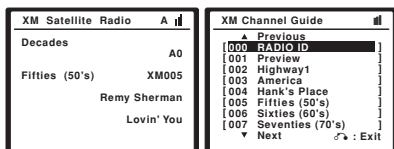

• Use **↑/↓** to display the XM Channel Guide screen, then use the **↑/↓/←/→** buttons followed by **ENTER** to select a channel to listen to the XM radio broadcast.

- To browse by genre, first press **CATEGORY**, use **↑/↓/←/→** to select a genre then press **ENTER**.<sup>2</sup>
- To cancel and exit any time, press **RETURN**.



### Tip

- You can select channels directly by pressing **D.ACCESS** then the three-digit channel number.

## Using XM Surround

XM Surround uses Neural Surround™ technology to achieve optimal surround sound from XM radio.

- **While listening to XM Radio, press AUTO SURR for XM Surround listening.** See *About Neural Surround™* below for more on this.

## About Neural Surround™

Neural Surround™ represents the latest advancement in surround technology and has been adopted by XM Satellite Radio for digital radio broadcasts of surround recordings and live events.

Neural Surround™ employs psychoacoustic frequency domain processing which allows delivery of a more detailed sound stage with superior localization of surround elements. System playback is scalable from stereo up to state-of-the-art multichannel surround.

*Neural Surround™ is trademark owned by Neural Audio Corporation.*

## Saving channel presets

This receiver can memorize up to 30 channels, stored in three banks, or classes, (A, B and C) of 10 stations each.

### 1 Select the channel you want to memorize.

See *Selecting channels and browsing by genre* above.

### 2 Press T.EDIT.

The display shows a blinking memory class.

## Note

<sup>1</sup> It's easiest if you have your TV switched on to take advantage of the OSDs. You can, however, use just the front panel display to do everything if you prefer.

<sup>2</sup> Select **XM000 (RADIO ID)** from the on-screen display to check the Radio ID of the Connect-and-Play antenna.

### 3 Press CLASS to select one of the three classes then press $\leftarrow/\rightarrow$ to select the channel preset you want.

You can also use the number buttons to select a preset.

- The default for all presets is **XM001**.

### 4 Press ENTER.

After pressing **ENTER**, the preset class and number stop blinking and the receiver stores the XM channel.

## Listening to channel presets

You will need to have some presets stored to do this.

### 1 Press CLASS to select the class in which the channel is stored.

Press repeatedly to cycle through classes A, B and C.

### 2 Press $\leftarrow/\rightarrow$ to select the channel preset you want.

- You can also use the number buttons on the remote control to recall the channel preset.

*Connect & Play™, XM-Ready® and The Ultimate Playlist are trademarks of XM Satellite Radio Inc. ©2005 XM Satellite Radio Inc. All rights reserved. All other trademarks are the property of their respective owners.*

## Second Zone speaker B setup

After selecting **Second Zone** in *Surround back speaker setting* on page 34, you can use the speakers connected to the (surround back) B speaker terminals on the rear panel to listen to stereo playback in a second listening zone.

### 1 Connect a pair of speakers to the surround back speaker terminals on the rear panel.

Connect them the same way you connected your speakers in *Connecting the speakers* on page 19. Make sure to review *Hints on speaker placement* on page 20 when placing the speakers in another room.

### 2 Select 'Second Zone' from the 'Surr Back System' menu.

See *Surround back speaker setting* on page 34 to do this.

## Switching the speaker system

If you selected **Second Zone** in *Surround back speaker setting* on page 34, three speaker system settings are possible using the **SPEAKERS** button. If you selected **Normal (SB)** or **Front Bi-Amp**, the speaker system is fixed as **SP▶A** or **SP▶AB** (respectively). The options below are for the **Second Zone** setting only.<sup>1</sup>

- Use the **SPEAKERS** button on the front panel to select a speaker system setting.

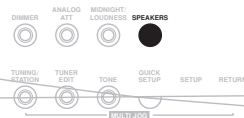

Press repeatedly to choose a speaker system option:

- **SP▶A** – Sound is output from the speakers connected to the A speaker terminals (multichannel playback is possible).
- **SP▶B** – Sound is output from the two speakers connected to speaker system B (only stereo playback is possible).

<sup>1</sup> If **SP▶B** is selected above, the speaker system may change.

- **SP►AB** – Sound is output from speaker system A (up to 5 channels, depending on the source), the two speakers in speaker system B, and the subwoofer. Multichannel sources (heard through speaker system A) are downmixed for stereo output from speaker system B.

## Bi-amping your front speakers

Bi-amping is when you connect the high frequency driver and low frequency driver of your speakers to different amplifiers (in this case, to both front and surround back terminals) for better crossover performance. Your speakers must be bi-ampable to do this (having separate terminals for high and low) and the sound improvement will depend on the kind of speakers you're using.

### 1 Connect your speakers as shown below.

This illustration below shows the connections for bi-amping your front left speaker. Hook up your front right speaker in the same way.

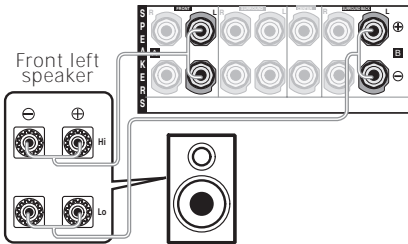

Since both front and surround back speaker terminals output the same audio, it doesn't matter which set (front or surround back) is powering which part (**Hi** or **Low**) of the speaker.

- Make sure that the + / - connections are properly inserted.

### 2 Select the 'Front Bi-Amp' setting from the 'Surr Back System' menu.

See *Surround back speaker setting* on page 34 to specify how you're using the surround back speaker terminals.

### ⚠ Caution

- Most speakers with both **Hi** and **Low** terminals have two metal plates that connect the **Hi** to the **Low** terminals. These must be removed when you are bi-amping the speakers or you could severely damage the amplifier. See your speaker manual for more information.
- If your speakers have a removable crossover network, make sure you do not remove it for bi-amping. Doing so may damage your speakers.

## Bi-wiring your speakers

The reasons for bi-wiring are basically the same as bi-amping, but additionally, interference effects within the wire could be reduced, producing better sound. Again, to do this your speakers must be bi-wireable (that is they must have separate terminals for the high and low frequencies). When bi-wiring, make sure you've selected **Normal (SB)** or **Second Zone** in *Surround back speaker setting* on page 34.

- **To bi-wire a speaker, connect two speaker cords to the speaker terminal on the receiver.** Using a banana plug for the second connection is recommended.

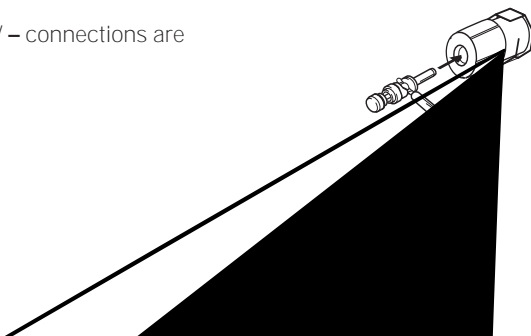



### Caution

- Make sure you use a parallel (not series, which are fairly uncommon) connection when bi-wiring your speakers.
- Don't connect different speakers from the same terminal in this way.

## Connecting additional amplifiers

This receiver has more than enough power for any home use, but it's possible to add additional amplifiers to every channel of your system using the pre-outs. Make the connections shown below to add amplifiers to power your speakers.<sup>1</sup>

- Before making or changing the connections, switch off the power and disconnect the power cord from the AC outlet.

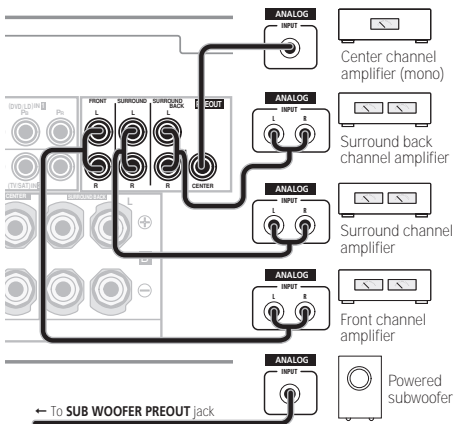

## Using this receiver with a Pioneer plasma display

If you have a Pioneer plasma display<sup>2</sup>, you can use an SR+ cable to connect it to this unit and take advantage of various convenient features, such as automatic video input switching of the plasma display when the input is changed.

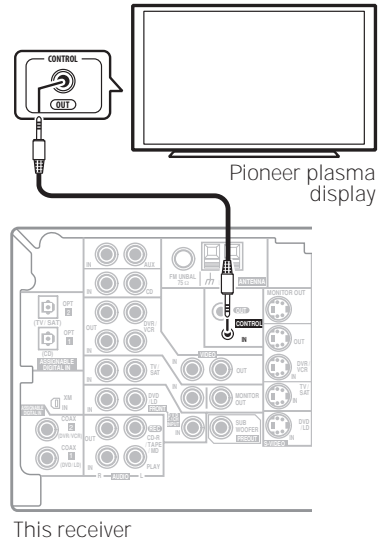

This receiver

### Note

- 1 You can use the additional amplifier on the surround back channel pre-outs for a single speaker as well. In this case plug the amplifier into the left (L (Single)) terminal only.
  - The sound you hear from the surround back terminals depends on the *Surround back speaker setting* on page 34.
  - To hear sound only from the pre-outs, simply disconnect any speakers that are connected directly to the receiver.
  - If you're not using a subwoofer, change the front speaker setting (see *Speaker Setting* on page 40) to large.
- 2 This receiver is compatible with all Pioneer plasma displays from 2003 onward.



## ons

### Plug SR+ cable<sup>1</sup> to the mini phone jack of this receiver of your plasma

If you want to use the extra SR+ features, you will need to connect the SR+ cable to the mini phone jack in the receiver. See the "Using SR+ cable" section in the *Plasma displays* on page 10 for more instructions.



This receiver

If you want to use most of the SR+ features, you will need to connect your source components (DVD player, etc.) in a slightly different way to that described in this chapter. For each source component, connect the video output directly to the plasma display, and just connect the audio (analog and/or digital) to this receiver.

## Using SR+ cable

When using SR+ cable, you will need to connect the SR+ cable to the mini phone jack in the receiver. See the "Using SR+ cable" section in the *Plasma displays* on page 10 for more instructions.

- 
- 
- 
- 

See the "Using SR+ cable" section in the *Plasma displays* on page 10 for more instructions.

## 1 Make sure the front panel of this receiver is connected to the plasma display.

See the "Using SR+ cable" section in the *Plasma displays* on page 10 for more instructions.

## 2 To switch the plasma display off, use the front panel of the plasma display.

The front panel of the plasma display is located on the right side of the display.

### Note

<sup>1</sup> The 3-ringed SR+ cable from Pioneer is commercially available under the part number PNC-001. For more information on obtaining an SR+ cable (you can also obtain a mini phone plug for the connection).

• If you connect to a Pioneer plasma display using an SR+ cable, you will need to point the play remote sensor to control the receiver. In this case, you won't be able to control the receiver with the remote control. To switch the plasma display off, use the front panel of the plasma display.

## Chapter 12: Other Settings

### The Input Assign menu

You only need to make settings in the Input Assign menu if you didn't hook up your digital equipment according to the default settings for the digital inputs, or if you have connected equipment using component video cables.

#### 1 Press RECEIVER on the remote control, then press the SETUP button.

An on-screen display (OSD) appears on your TV. Use **↑/↓/←/→** and **ENTER** on the remote control to navigate through the screens and select menu items. Press **RETURN** to confirm and exit the current menu.

#### 2 Select 'Input Assign' from the System Setup menu.

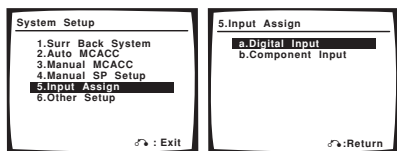

### Assigning the digital inputs

- Default settings:

**Coaxial - 1** – DVD

**Coaxial - 2** – DVR

**Optical - 1** – CD

**Optical - 2** – TV

You only need to do this if you didn't hook up your digital equipment according to the default settings for the digital inputs (see above). This setting tells the receiver what digital equipment is hooked up to which terminal so the buttons on the remote correspond to what you have hooked up.

#### 1 Select 'Digital Input' from the Input Assign menu.

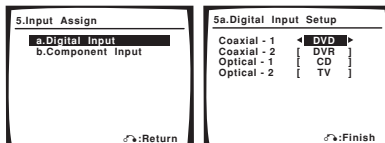

#### 2 Select the number of the digital input to which you've connected the digital component.

The numbers correspond with the numbers beside the inputs on the back of the receiver.

#### 3 Select the component that corresponds with the one you connected to that input.

Select between **DVD**, **TV**, **CD**, **CD-R**, **DVR** or **OFF**.

- Use **←/→** and **ENTER** to do this.
- If you assign a digital input to a certain function (for example, **DVD/LD**) then any digital inputs previously assigned to that function will automatically be switched off.

#### 4 When you're finished, press RETURN.

You return to the Input Assign menu.

### Assigning the component video inputs

- Default settings:

**Component 1** – DVD

**Component 2** – TV

**Component 3** – DVR

If you used component video cords to connect your video equipment you must tell the receiver which device it is, or else you may see the S-video or composite video input instead of the component video signal. For more on this, see *Using the component video jacks* on page 17.

#### 1 Select 'Component Input' from the Input Assign menu.

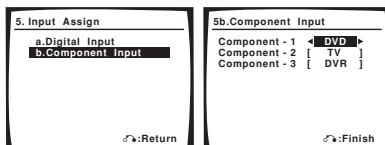

## 2 Select the number of the component video input to which you've connected your video component.

The numbers correspond with the numbers beside the inputs on the back of the receiver.

## 3 Select the component that corresponds with the one you connected to that input.

Select between **DVD**, **TV**, **DVR** or **OFF**.

- Use **←/→** and **ENTER** to do this.
- Make sure you have connected the audio from the component to the corresponding inputs on the rear of the receiver.
- If you connect any source component to the receiver using a component video input, you should also have your TV connected to this receiver's component video **MONITOR** output.

## 4 When you're finished, press RETURN.

You return to the Input Assign menu.

- **DRC Setup** – Specify the amount of dynamic range adjustment to Dolby Digital soundtracks (see *Dynamic Range Control Setup* below).
- **Dual Mono Setup** – Isolate one channel when listening to discs with dual mono encoding (see *Dual Mono Setup* below).
- **LFE ATT Setup** – Choose the attenuator level for the LFE channel (*LFE Attenuator Setup* on page 60).
- **SR+ Setup** – Specify how you want to control your Pioneer plasma display (*SR+ Setup for Pioneer plasma displays* on page 60).

## 4 Make the adjustments necessary for each setting, pressing RETURN to confirm after each screen.

### Dynamic Range Control Setup

- Default setting: **OFF**

This setting specifies the amount of dynamic range adjustment to Dolby Digital and DTS movie soundtracks. You may want to use this when listening to surround sound at low volumes.

## 1 Select 'DRC Setup' from the Other Setup menu.

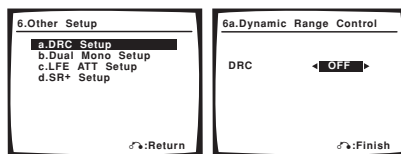

## The Other Setup menu

The Other Setup menu is where you can make customized settings to reflect how you are using the receiver.

## 1 Press RECEIVER on the remote control, then press the SETUP button.

An on-screen display (OSD) appears on your TV. Use **↑/↓/←/→** and **ENTER** on the remote control to navigate through the screens and select menu items. Press **RETURN** to confirm and exit the current menu.

## 2 Select 'Other Setup' then press ENTER.

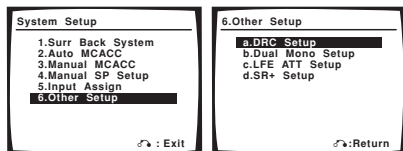

## 3 Select the setting you want to adjust.

If you are doing this for the first time, you may want to adjust these settings in order:

## 2 Choose the setting that you want.

- **MAX** – Dynamic range is reduced (loud sounds are reduced in volume while quieter sounds are increased).
- **MID** – Mid setting.
- **OFF** – No dynamic range adjustment (use when listening at higher volume).

## 3 When you're finished, press RETURN.

You return to the Other Setup menu.

## Dual Mono Setup

- Default setting: **CH1**

You can specify how dual mono encoded Dolby Digital and DTS soundtracks should be played. Dual mono is not widely used, but is sometimes necessary when two languages need to be sent to separate channels.

### 1 Select 'Dual Mono Setup' from the Other Setup menu.

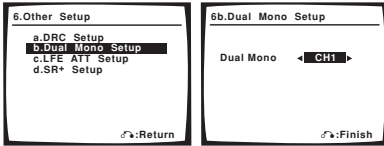

### 2 Choose the setting that you want.

- **CH2** – Only channel 2 is played
- **CH1 CH2** – Both channels are played through the front speakers
- **CH1** – Only channel 1 is played

### 3 When you're finished, press RETURN.

You return to the Other Setup menu.

## LFE Attenuator Setup

- Default setting: **ATT 0 dB**

Some Dolby Digital and DTS audio sources include ultra-low bass tones. Set the LFE attenuator as necessary to prevent the ultra-low bass tones from distorting the sound from the speakers.

### 1 Select 'LFE ATT Setup' from the Other Setup menu.

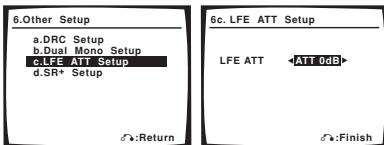

### 2 Choose the setting that you want.

- **ATT 0dB** – No limiting (recommended)
- **ATT 10dB** – 10dB of limiting
- **LFE OFF** – No sound from LFE channel

### 3 When you're finished, press RETURN.

You return to the Other Setup menu.

## SR+ Setup for Pioneer plasma displays

Make the following settings if you have connected a Pioneer plasma display to this receiver using an SR+ cable. Note that the number of settings available will depend on the plasma display you've connected.

See also *Using this receiver with a Pioneer plasma display* on page 56.

### 1 Select 'SR+ Setup' from the Other Setup menu.

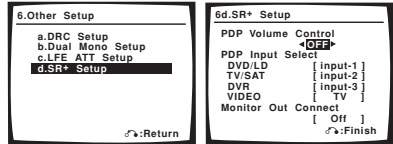

### 2 Select the 'PDP Volume Control' setting you want.

- **OFF** – The receiver does not control the volume of the plasma display
- **ON** – When the receiver is switched to one of the inputs that use the plasma display (DVD/LD, or another function below), the volume on the plasma display is muted so only sound from the receiver is heard.

### 3 Assign any input source connected to the plasma display to the corresponding input number.

This matches the receiver's input source with a numbered video input on the plasma display. For example, assign **DVD/LD** to **input-2** if you have connected your DVD video output to video input 2 on the plasma display.

- The **Monitor Out Connect** should be set to the input that you've used to connect this receiver to your plasma display.

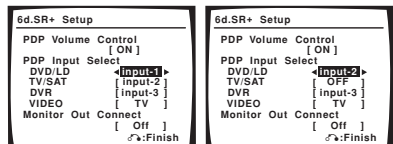

### 4 When you're finished, press RETURN.

You return to the Other Setup menu.

## Chapter 13:

# Additional information

### Troubleshooting

Incorrect operations are often mistaken for trouble and malfunctions. If you think that there is something wrong with this component, check the points below. Take a look at the other components and electrical appliances being used, because sometimes the problem may lie there. If the trouble isn't sorted out even after going through the checks below, ask your nearest Pioneer authorized independent service company to carry out repair work.

- If the unit does not operate normally due to external effects such as static electricity disconnect the power plug from the outlet and insert again to return to normal operating conditions.

Problem	Remedy
The power does not turn on.	<ul style="list-style-type: none"> <li>• Disconnect the power plug from the outlet, and insert again.</li> <li>• Make sure there are no loose strands of speaker wire touching the rear panel. This could cause the receiver to shut off automatically.</li> </ul>
The receiver suddenly switches off and the power indicator blinks.	<ul style="list-style-type: none"> <li>• After about a minute (you won't be able to switch the unit on during this time), switch the receiver back on. If the message persists, call a Pioneer authorized independent service company.</li> </ul>
No sound is output when a function is selected.	<ul style="list-style-type: none"> <li>• Make sure the component is connected correctly (refer to <i>Connecting up</i> on page 12).</li> <li>• Press <b>MUTE</b> on the remote control to turn muting off.</li> <li>• Press <b>SPEAKERS</b> to select the proper speaker set (see <i>Switching the speaker system</i> on page 54).</li> <li>• Press <b>SIGNAL SELECT</b> to select the proper input signal (see <i>Choosing the input signal</i> on page 33).</li> </ul>
No image is output when a function is selected.	<ul style="list-style-type: none"> <li>• Make sure the component is connected correctly (refer to <i>Connecting up</i> on page 12).</li> <li>• Select the correct component (use the input select buttons).</li> <li>• Check <i>Assigning the component video inputs</i> on page 58 to make sure you're assigned the correct input.</li> <li>• The video input selected on the TV monitor is incorrect. Refer to the instruction manual supplied with the TV.</li> </ul>
No sound from subwoofer.	<ul style="list-style-type: none"> <li>• Make sure the subwoofer is switched on.</li> <li>• If the subwoofer has a volume knob, make sure it's turned up.</li> <li>• The Dolby Digital or DTS source you are listening to may not have an LFE channel.</li> <li>• Switch the subwoofer setting in <i>Speaker Setting</i> on page 40 to <b>YES</b> or <b>PLUS</b>.</li> <li>• Switch the <i>LFE Attenuator Setup</i> on page 60 to <b>LFEATT 0</b> or <b>LFEATT 10</b>.</li> </ul>
No sound from surround or center speakers.	<ul style="list-style-type: none"> <li>• Connect the speakers properly (refer to page 19).</li> <li>• Refer to <i>Speaker Setting</i> on page 40 to check the speaker settings.</li> <li>• Refer to <i>Channel Level</i> on page 41 to check the speaker levels.</li> </ul>
No sound from surround back speakers.	<ul style="list-style-type: none"> <li>• Refer to <i>Speaker Setting</i> on page 40 to check the surround back speaker settings.</li> <li>• Refer to <i>Channel Level</i> on page 41 to check the speaker levels.</li> <li>• Refer to <i>Using surround back channel processing</i> on page 31 to make sure surround back processing and the sound mode are set for surround back sound.</li> </ul>

Problem	Remedy
Considerable noise in radio broadcasts.	<ul style="list-style-type: none"> <li>• Connect the antenna (page 18) and adjust the position for best reception.</li> <li>• Route any loose cables away from the antenna terminals and wires.</li> <li>• Fully extend the FM wire antenna, position for best reception, and secure to a wall (or connect an outdoor FM antenna).</li> <li>• Connect an additional internal or external AM antenna (page 18).</li> <li>• Turn off equipment causing interference or move it away from the receiver (or move antennas farther away from equipment causing noise).</li> </ul>
Broadcast stations cannot be selected automatically.	<ul style="list-style-type: none"> <li>• Connect an outdoor antenna (refer to page 18).</li> </ul>
Noise during playback of a cassette deck.	<ul style="list-style-type: none"> <li>• Move the cassette deck away from your receiver, until the noise disappears.</li> </ul>
Sound is produced from other components, but not from LD or DVD player.	<ul style="list-style-type: none"> <li>• Set the <b>SIGNAL SELECT</b> to <b>AUTO</b>, <b>DIGITAL</b> or <b>ANALOG</b> according to the type of connections made. (refer to page 33).</li> <li>• Set the digital input settings correctly (refer to page 58).</li> <li>• Make digital connections (refer to page 13) and set the <b>SIGNAL SELECT</b> to <b>DIGITAL</b> (refer to page 33).</li> <li>• Refer to the instruction manual supplied with the DVD player.</li> </ul>
No sound is output or a noise is output when software with DTS is played back.	<ul style="list-style-type: none"> <li>• Set the digital volume level of the player to full, or to the neutral position.</li> <li>• Make sure the player's settings are correct and/or the DTS signal out is on. Refer to the instruction manual supplied with the DVD player.</li> <li>• Set the input signal type to <b>DIGITAL</b> (see <i>Choosing the input signal</i> on page 33)</li> </ul>
During a playback search, noise is output from a DTS compatible CD player.	<ul style="list-style-type: none"> <li>• This is not a malfunction, but be sure to turn the volume down to prevent the output of loud noise from your speakers.</li> </ul>
Everything seems to be set up correctly, but the playback sound is odd.	Check that the positive/negative speaker terminals on the receiver are matched with the corresponding terminals on the speakers (see <i>Connecting the speakers</i> on page 19).
There seems to be a time lag between the speakers and the output of the subwoofer.	<ul style="list-style-type: none"> <li>• See <i>Automatically setting up for surround sound (MCACC)</i> on page 9 to set up your system again using MCACC (this will automatically compensate for a delay in the subwoofer output).</li> </ul>
After using the Auto MCACC Setup, the speaker size setting ( <b>LARGE</b> or <b>SMALL</b> ) is incorrect.	<ul style="list-style-type: none"> <li>• Low-frequency noise could have been caused by an air conditioner or motor. Switch off all appliances in the room and rerun the Auto MCACC Setup.</li> </ul>
Can't operate the remote control.	<ul style="list-style-type: none"> <li>• Replace the batteries (refer to page 6).</li> <li>• Operate within 23 ft. (7 m), 30° of the remote sensor (refer to page 27).</li> <li>• Remove the obstacle or operate from another position.</li> <li>• Avoid exposing the remote sensor on the front panel to direct light.</li> <li>• Unplug anything connected to the <b>CONTROL IN</b> jack and use remote normally (see <i>Operating other Pioneer components</i> on page 46).</li> </ul>
The SR cable is connected, but the connected components can't be operated with the remote.	<ul style="list-style-type: none"> <li>• Reinsert the SR cable, making sure it's connected to the right jack (see <i>Using this receiver with a Pioneer plasma display</i> on page 56).</li> <li>• Make sure an analog connection has been made between the units.</li> <li>• This feature only works with Pioneer products.</li> </ul>
The display is dark or off.	<ul style="list-style-type: none"> <li>• Press <b>DIMMER</b> on the control repeatedly to return to the default.</li> </ul>
The <b>System Setup</b> screen doesn't appear.	<ul style="list-style-type: none"> <li>• When the receiver is in standby, switch to <b>BURST.OFF</b> by holding down <b>ACOUSTIC EQ</b> (front panel) and pressing <b>⏻ STANDBY/ON</b> (the current setting is displayed).</li> </ul>

## XM radio messages

Symptom	Cause	Action
<b>Check Antenna</b>	The XM antenna is not connected.	Check that the XM antenna cable is attached securely.
<b>XM ANT ERR</b>	A short-circuit occurring in the antenna or surrounding antenna cable.	Make sure that there is nothing unusual with the antenna or antenna cable. Switch the power off then back on again.
<b>Updating</b>	The radio is being updated with the latest encryption code.	Wait until the encryption code has been updated. Channels 00 and 01 should function normally.
<b>No Signal</b>	The XM signal is too weak at the current location.	<i>n/a</i>
<b>Loading</b>	The receiver is acquiring audio or program information.	Wait until the information has been received.
<b>Off Air</b>	The channel currently selected has stopped broadcasting.	Select another channel.
<b>CH-- --</b>	You have selected a channel that does not exist, or that you have not subscribed to.	The receiver will automatically switch to channel 001 (or the last selected channel).
<b>-----</b>	There is no artist name/feature, song/program title, or channel category associated with the channel at this time.	No action needed.

## Resetting the main unit

Use this procedure to reset all the receiver's settings to the factory default. Use the front panel controls to do this.

- Switch the receiver into standby.**
- While holding down the TONE button, press and hold the  $\odot$  STANDBY/ON button for about three seconds.**
- When you see RESET? appear in the display, press ENTER.**  
OK? shows in the display.
- Press SETUP to confirm.**  
OK appears in the display to indicate that the receiver has been reset to the factory settings.

## Switching the speaker impedance

We recommend using speakers of 8 $\Omega$  with this system, but it is possible to switch the impedance setting if you plan to use speakers with a 6 $\Omega$  impedance rating.

- With the receiver in standby, press  $\odot$  STANDBY/ON while holding down the SPEAKERS button.**  
Each time you do this, you switch between the impedance settings:
  - SP 6 OHM** – Use this setting if your speakers are rated at 6 $\Omega$ .
  - SP 8 OHM** – Use this setting if your speakers are rated at 8 $\Omega$  or more.

## Specifications

### Amplifier section

- **Continuous power output (stereo)**  
Front . . . 110 W (20 to 20 000 Hz, THD 0.7 %, 8  $\Omega$ )<sup>1</sup>
- **Continuous power output (surround)**  
Front . . . . . 110 W per channel (1 kHz, 1.0 %, 8  $\Omega$ )  
Center . . . . . 110 W (1 kHz, 1.0 %, 8  $\Omega$ )  
Surround . . . . . 110 W per channel  
(1 kHz, 1.0 %, 8  $\Omega$ )  
Surround Back . . . . . 110 W per channel  
(1 kHz, 1.0 %, 8  $\Omega$ )

### Audio section

- **Input (Sensitivity/Impedance)**  
CD, DVR/VCR, CD-R/TAPE/MD,  
DVD/LD, TV/SAT . . . . . 200 mV/47 k $\Omega$
- **Frequency response**  
CD, DVR/VCR, CD-R/TAPE/MD, DVD/LD,  
TV/SAT . . . . . 5 Hz to 100 000 Hz  $\pm 3$  dB
- **Output (Level/Impedance)**  
DVR/VCR REC, CD-R/TAPE/  
MD REC . . . . . 200 mV/2.2 k $\Omega$
- **Tone control**  
Bass . . . . .  $\pm 6$  dB (100 Hz)  
Treble . . . . .  $\pm 6$  dB (10 kHz)  
Loudness . . . . . +10 dB/+5 dB (100 Hz/10 kHz)  
(at volume level -50 dB)
- **Signal-to-Noise Ratio (IHF, short circuited, A network)**  
CD, DVR/VCR, CD-R/TAPE/MD,  
DVD/LD, TV/SAT . . . . . 96 dB
- **Signal-to Noise Ratio [EIA, at 1 W (1 kHz)]**  
CD, DVR/VCR, CD-R/TAPE/MD,  
DVD/LD, TV/SAT . . . . . 79 dB

### Video Section

- **Input (Sensitivity/Impedance)**  
DVR/VCR, DVD/LD, TV/SAT. . . . . 1 Vp-p/75  $\Omega$
- **Output (Level/Impedance)**  
DVR/VCR, MONITOR OUT. . . . . 1 Vp-p/75  $\Omega$
- **Frequency response**  
DVR/VCR, DVD/LD,  
TV/SAT  $\Rightarrow$  MONITOR. . . . . 5 Hz to 7 MHz  $\pm 3$  dB  
Signal-to-Noise Ratio. . . . . 55 dB  
Crosstalk. . . . . 50 dB

### Component video section

- **Input (Sensitivity)**  
DVD/LD, TV/SAT, DVR/VCR. . . . . 1 Vp-p/75  $\Omega$
- **Output (Level/Impedance)**  
MONITOR OUT. . . . . 1 Vp-p/75  $\Omega$
- **Frequency response**  
DVD/LD, TV/SAT,  
DVR/VCR  $\Rightarrow$  MONITOR. . . . . 5 Hz to 40 MHz  $\pm 3$  dB  
Signal-to-Noise Ratio. . . . . 60 dB

### FM Tuner Section

- **Frequency Range**. . . . . 87.5 MHz to 108 MHz  
**Usable Sensitivity**. . . . . Mono: 13.2 dBf, IHF  
(1.3  $\mu$ V/ 75  $\Omega$ )  
50 dB Quieting Sensitivity. . . . . Mono: 20.2 dB  
Stereo: 38.6 dBf  
**Signal-to-Noise Ratio**. . . Mono: 73 dB (at 85 dBf)  
Stereo: 70 dB (at 85 dBf)  
**Distortion** . . . . . Stereo: 0.5 % (1 kHz)  
**Alternate Channel Selectivity** . . . . . 60 dB  
(400 kHz)  
**Stereo Separation** . . . . . 40 dB (1 kHz)  
**Frequency Response**. . . . . 30 Hz to 15 kHz  
( $\pm 1$  dB)  
**Antenna Input (DIN)** . . . . . 75  $\Omega$  unbalanced

#### Note

<sup>1</sup> Continuous average power output of 110 watts\* per channel, min., at 8ohms, from 20 Hz to 20 000 Hz with no more than 0.7 %\*\* total harmonic distortion (front).

\* Measured pursuant to the Federal Trade Commission's Trade Regulation rule on Power Output Claims for Amplifiers.

\*\* Measured by Audio Spectrum Analyzer.



## AM Tuner Section

Frequency Range. . . . . 530 kHz to 1700 kHz  
 Sensitivity (IHF, Loop antenna). . . . . 350  $\mu$ V/m  
 Signal-to-Noise Ratio. . . . . 50 dB  
 Antenna . . . . . Loop antenna

## Miscellaneous

Power requirements . . . . . AC 120V / 60Hz  
 Power consumption . . . . . 370 W / 480 VA  
     In standby. . . . . 0.5 W  
 Dimensions  
     . . . . . 16<sup>9</sup>/<sub>16</sub> (W) in. x 6<sup>1</sup>/<sub>4</sub> (H) in. x 13<sup>7</sup>/<sub>8</sub> (D) in.  
             420 (W) mm x 158 (H) mm x 352.5 (D) mm  
 Weight (without package). . . . . 20.3 lb (9.2 kg)

## Furnished Parts

Microphone (for Auto MCACC setup) . . . . . 1  
 Dry cell batteries (AA size IEC R6) . . . . . 2  
 Remote control . . . . . 1  
 AM loop antenna . . . . . 1  
 FM wire antenna . . . . . 1  
 These operating instructions

### Note

- Specifications and the design are subject to possible modifications without notice, due to improvements.

## Power cord caution

Handle the power cord by the plug. Do not pull out the plug by tugging the cord and never touch the power cord when your hands are wet as this could cause a short circuit or an electric shock. Do not place the unit, a piece of furniture, etc., on the power cord, or pinch the cord. Never make a knot in the cord or tie it with other cords. The power cords should be routed such that they are not likely to be stepped on. A damaged power cord can cause a fire or give you an electrical shock. Check the power cord once in a while. When you find it damaged, ask your nearest Pioneer authorized service center or your dealer for a replacement.

## Cleaning the unit

- Use a polishing cloth or dry cloth to wipe off dust and dirt.
- When the surface is dirty, wipe with a soft cloth dipped in some neutral cleanser diluted five or six times with water, and wrung out well, and then wipe again with a dry cloth. Do not use furniture wax or cleansers.
- Never use thinners, benzene, insecticide sprays or other chemicals on or near this unit, since these will corrode the surface.

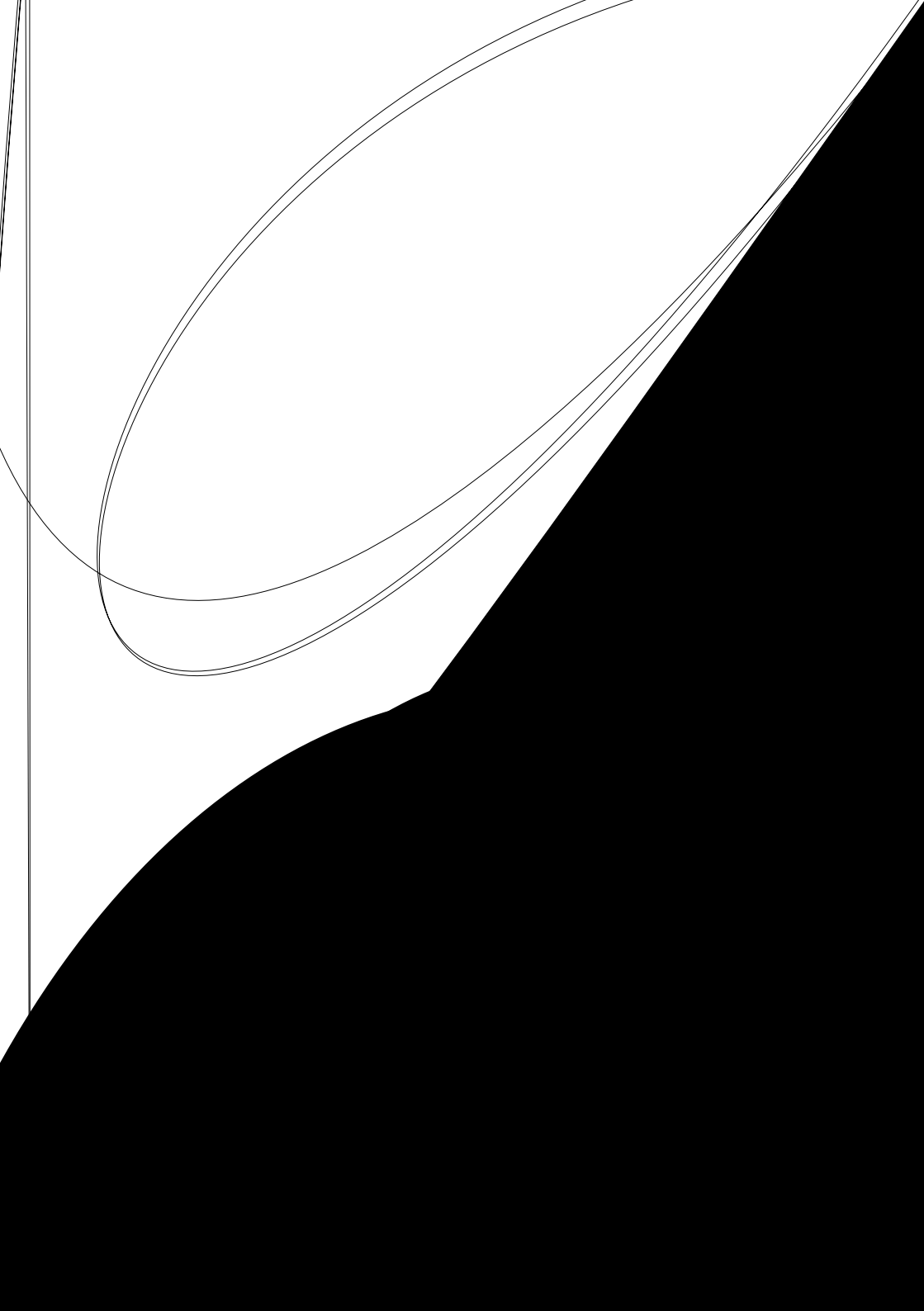



PIONEER ELECTRONICS (USA) INC.

PIONEER ELECTRONICS OF CANADA, INC.

LIMITED WARRANTY
WARRANTY VALID ONLY IN COUNTRY OF PRODUCT PURCHASE

WARRANTY

Pioneer Electronics (USA) Inc. (PUSA), and Pioneer Electronics Of Canada, Inc. (POC), warrant that products distributed by PUSA in the U.S.A., and by POC in Canada that fail to function properly under normal use due to a manufacturing defect when installed and operated according to the owner's manual enclosed with the unit will be repaired or replaced with a unit of comparable value, at the option of PUSA or POC, without charge to you for parts or actual repair work.

THIS LIMITED WARRANTY APPLIES TO THE ORIGINAL OR ANY SUBSEQUENT OWNER OF THIS PIONEER PRODUCT DURING THE WARRANTY PERIOD PROVIDED THE PRODUCT WAS PURCHASED FROM AN AUTHORIZED PIONEER DISTRIBUTOR/DEALER IN THE U.S.A. OR CANADA. YOU WILL BE REQUIRED TO PROVIDE A SALES RECEIPT OR OTHER VALID PROOF OF PURCHASE SHOWING THE DATE OF ORIGINAL PURCHASE OR, IF RENTED, YOUR RENTAL CONTRACT SHOWING THE PLACE AND DATE OF FIRST RENTAL. IN THE EVENT SERVICE IS REQUIRED, THE PRODUCT MUST BE DELIVERED WITHIN THE WARRANTY PERIOD, TRANSPORTATION PREPAID, ONLY FROM WITHIN THE COUNTRY OF PURCHASE AS EXPLAINED IN THIS DOCUMENT. YOU WILL BE RESPONSIBLE FOR REMOVAL AND INSTALLATION OF THE PRODUCT. PUSA OR POC, AS APPROPRIATE, WILL PAY TO RETURN THE REPAIRED OR REPLACEMENT PRODUCT TO YOU WITHIN THE COUNTRY OF PURCHASE.

PRODUCT WARRANTY PERIOD

Table with 2 columns: Product Category, Parts, Labor. Rows include Home Audio and Video, Microphones, Headphones, Phono Cartridges and Styluses.

Shorter limited warranty periods apply to some models. Please refer to the limited warranty document enclosed with the product for a definitive statement of the warranty period. The warranty period for retail customers who rent the product commences upon the date product is first put into use (a) during the rental period or (b) retail sale, whichever occurs first.

WHAT IS NOT COVERED

IF THIS PRODUCT WAS PURCHASED FROM AN UNAUTHORIZED DISTRIBUTOR, THERE ARE NO WARRANTIES, EXPRESS OR IMPLIED, INCLUDING THE IMPLIED WARRANTY OF MERCHANTABILITY AND THE IMPLIED WARRANTY OF FITNESS FOR A PARTICULAR PURPOSE AND THIS PRODUCT IS SOLD STRICTLY "AS IS" AND "WITH ALL FAULTS". PIONEER SHALL NOT BE LIABLE FOR ANY CONSEQUENTIAL AND/OR INCIDENTAL DAMAGES. PIONEER DOES NOT WARRANT ANY PRODUCT LISTED ABOVE WHEN IT IS USED IN A TRADE OR BUSINESS OR IN ANY INDUSTRIAL OR COMMERCIAL APPLICATION. THIS WARRANTY DOES NOT APPLY IF THE PRODUCT HAS BEEN SUBJECTED TO POWER IN EXCESS OF ITS PUBLISHED POWER RATING. THIS WARRANTY DOES NOT COVER TELEVISION OR DISPLAY SCREENS DAMAGED BY STATIC, NON-MOVING, IMAGES APPLIED FOR LENGTHY PERIODS (BURN-IN). THIS WARRANTY DOES NOT COVER THE CABINET OR ANY APPEARANCE ITEM, USER ATTACHED ANTENNA, ANY DAMAGE TO RECORDS OR RECORDING TAPES OR DISCS, ANY DAMAGE TO THE PRODUCT RESULTING FROM ALTERATIONS, MODIFICATIONS NOT AUTHORIZED IN WRITING BY PIONEER, ACCIDENT, MISUSE OR ABUSE, DAMAGE DUE TO LIGHTNING OR TO POWER SURGES, SUBSEQUENT DAMAGE FROM LEAKING, DAMAGE FROM INOPERATIVE BATTERIES, OR THE USE OF BATTERIES NOT CONFORMING TO THOSE SPECIFIED IN THE OWNER'S MANUAL. THIS WARRANTY DOES NOT COVER THE COST OF PARTS OR LABOR WHICH WOULD BE OTHERWISE PROVIDED WITHOUT CHARGE UNDER THIS WARRANTY OBTAINED FROM ANY SOURCE OTHER THAN A PIONEER AUTHORIZED SERVICE COMPANY OR OTHER DESIGNATED LOCATION. THIS WARRANTY DOES NOT COVER DEFECTS OR DAMAGE CAUSED BY THE USE OF UNAUTHORIZED PARTS OR LABOR OR FROM IMPROPER MAINTENANCE. ALTERED, DEFACED, OR REMOVED SERIAL NUMBERS VOID THIS ENTIRE WARRANTY

NO OTHER WARRANTIES

IN THE U.S.A. - PIONEER LIMITS ITS OBLIGATIONS UNDER ANY IMPLIED WARRANTIES INCLUDING, BUT NOT LIMITED TO, THE IMPLIED WARRANTIES OF MERCHANTABILITY AND FITNESS FOR A PARTICULAR PURPOSE, TO A PERIOD NOT TO EXCEED THE WARRANTY PERIOD. NO WARRANTIES SHALL APPLY AFTER THE WARRANTY PERIOD. SOME STATES DO NOT ALLOW LIMITATIONS ON HOW LONG AN IMPLIED WARRANTY LASTS AND SOME STATES DO NOT ALLOW THE EXCLUSIONS OR LIMITATIONS OF INCIDENTAL OR CONSEQUENTIAL DAMAGES, SO THE ABOVE LIMITATIONS OR EXCLUSIONS MAY NOT APPLY TO YOU. THIS WARRANTY GIVES YOU SPECIFIC LEGAL RIGHTS AND YOU MAY HAVE OTHER RIGHTS WHICH MAY VARY FROM STATE TO STATE.

IN CANADA - EXCEPT AS EXPRESSLY PROVIDED HEREIN, THERE ARE NO REPRESENTATIONS, WARRANTIES, OBLIGATIONS OR CONDITIONS, IMPLIED, STATUTORY OR OTHERWISE, APPLICABLE TO THIS PRODUCT.

TO OBTAIN SERVICE

PUSA and POC have appointed a number of Authorized Service Companies throughout the U.S.A. and Canada should your product require service. To receive warranty service you need to present your sales receipt or, if rented, your rental contract showing place and date of original owner's transaction. If shipping the unit you will need to package it carefully and send it, transportation prepaid by a traceable, insured method, to an Authorized Service Company. Package the product using adequate padding material to prevent damage in transit. The original container is ideal for this purpose. Include your name, address and telephone number where you can be reached during business hours. On all complaints and concerns in the U.S.A. call Customer Support at 1-800-421-1404, or, in Canada, call Customer Satisfaction at (905) 479-4411.

IN THE U.S.A.

For hook-up and operation of your unit or to locate an Authorized Service Company, please call or write:

CUSTOMER SUPPORT DIVISION
PIONEER ELECTRONICS (USA) INC.
P.O. BOX 1760
LONG BEACH, CALIFORNIA 90801
1-800-421-1404

http://www.pioneerelectronics.com

IN CANADA

For additional information on this warranty, please call or write:

CUSTOMER SATISFACTION GROUP
PIONEER ELECTRONICS OF CANADA, INC.
300 ALLSTATE PARKWAY
MARKHAM, ON L3R 0P2
(905) 479-4411
1-877-283-5901

http://www.pioneerelectronics.com

DISPUTE RESOLUTION

IN THE U.S.A. - Following our response to any initial request to Customer Support, should a dispute arise between you and Pioneer, Pioneer makes available its Complaint Resolution Program to resolve the dispute. The Complaint Resolution Program is available to you without charge. You are required to use the Complaint Resolution Program before you exercise any rights under, or seek any remedies, created by Title I of the Magnuson-Moss Warranty-Federal Trade Commission Improvement Act, 15 U.S.C. 2301 et seq. To use the Complaint Resolution Program call 1-800-421-1404 and explain to the customer service representative the problem you are experiencing, steps you have taken to have the product repaired during the warranty period and the name of the authorized Distributor/Dealer from whom the Pioneer product was purchased. After the complaint has been explained to the representative, a resolution number will be issued. Within 40 days of receiving your complaint, Pioneer will investigate the dispute and will either: (1) respond to your complaint in writing informing you what action Pioneer will take, and in what time period, to resolve the dispute; or (2) respond to your complaint in writing informing you why it will not take any action.

IN CANADA - Call the Customer Satisfaction Manager at 1-877-283-5901 to discuss your complaint and to obtain a prompt resolution.

RECORD THE PLACE AND DATE OF PURCHASE FOR FUTURE REFERENCE

Model No. \_\_\_\_\_ Serial No. \_\_\_\_\_ Purchase Date \_\_\_\_\_

Purchased From \_\_\_\_\_

KEEP THIS INFORMATION AND YOUR SALES RECEIPT IN A SAFE PLACE

Should this product require service in the U.S.A. and you wish to locate the nearest Pioneer Authorized Independent Service Company, or if you wish to purchase replacement parts, operating instructions, service manuals, or accessories, please call the number shown below.

8 0 0 - 4 2 1 - 1 4 0 4

Please do not ship your product to Pioneer without first calling the Customer Support Division at the above listed number for assistance.

Pioneer Electronics (USA) Inc.  
Customer Support Division  
P.O. BOX 1760, Long Beach,  
CA 90801-1760, U.S.A.

Should this product require service in Canada, please contact a Pioneer Canadian Authorized Dealer to locate the nearest Pioneer Authorized Service Company in Canada. Alternatively, please contact the Customer Satisfaction Department at the following address:

Pioneer Electronics of Canada, Inc.  
Customer Satisfaction Department  
300 Allstate Parkway, Markham, Ontario L3R OP2  
1(877)283-5901

Si ce produit doit être réparé au Canada, veuillez vous adresser à un distributeur autorisé Pioneer du Canada pour obtenir le nom du Centre de Service Autorisé Pioneer le plus près de chez-vous. Vous pouvez aussi contacter le Service à la clientèle de Pioneer:

Pioneer Électroniques du Canada, Inc.  
Service à la clientèle  
300, Allstate Parkway, Markham, Ontario L3R OP2  
1(877)283-5901

Pour obtenir des renseignements sur la garantie, veuillez vous reporter au feuillet sur la garantie restreinte qui accompagne le produit.

5018\_A\_EF

Published by Pioneer Corporation  
Copyright©2005 Pioneer Corporation  
All rights reserved

---

## **PIONEER CORPORATION**

4-1, Meguro 1-Chome, Meguro-ku, Tokyo 153-8654, Japan

### **PIONEER ELECTRONICS (USA) INC.**

P.O. BOX 1540, Long Beach, California 90810-1540, U.S.A. TEL: (800) 421-1404

### **PIONEER ELECTRONICS OF CANADA, INC.**

300 Allstate Parkway, Markham, Ontario L3R OP2, Canada TEL: 1-877-283-5901

### **PIONEER EUROPE NV**

Haven 1087, Keetberglaan 1, B-9120 Melsele, Belgium TEL: 03/570.05.11

### **PIONEER ELECTRONICS ASIACENTRE PTE. LTD.**

253 Alexandra Road, #04-01, Singapore 159936 TEL: 65-6472-7555

### **PIONEER ELECTRONICS AUSTRALIA PTY. LTD.**

178-184 Boundary Road, Braeside, Victoria 3195, Australia, TEL: (03) 9586-6300

### **PIONEER ELECTRONICS DE MEXICO S.A. DE C.V.**

Blvd.Manuel Avila Camacho 138 10 piso Col.Lomas de Chapultepec, Mexico,D.F. 11000 TEL: 55-9178-4270

K002\_A\_En

## Free Manuals Download Website

<http://myh66.com>

<http://usermanuals.us>

<http://www.somanuals.com>

<http://www.4manuals.cc>

<http://www.manual-lib.com>

<http://www.404manual.com>

<http://www.luxmanual.com>

<http://aubethermostatmanual.com>

Golf course search by state

<http://golfingnear.com>

Email search by domain

<http://emailbydomain.com>

Auto manuals search

<http://auto.somanuals.com>

TV manuals search

<http://tv.somanuals.com>