

Pioneer

**AUDIO/VIDEO
MULTI-CHANNEL RECEIVER**

**VSX-909RDS
VSX-909RDS-G**

Operating Instructions

IMPORTANT



The lightning flash with arrowhead symbol, within an equilateral triangle, is intended to alert the user to the presence of uninsulated "dangerous voltage" within the product's enclosure that may be of sufficient magnitude to constitute a risk of electric shock to persons.

CAUTION

**RISK OF ELECTRIC SHOCK
DO NOT OPEN**

CAUTION:
TO PREVENT THE RISK OF ELECTRIC SHOCK, DO NOT REMOVE COVER (OR BACK). NO USER-SERVICEABLE PARTS INSIDE. REFER SERVICING TO QUALIFIED SERVICE PERSONNEL.



The exclamation point within an equilateral triangle is intended to alert the user to the presence of important operating and maintenance (servicing) instructions in the literature accompanying the appliance.

IMPORTANT

FOR USE IN THE UNITED KINGDOM

The wires in this mains lead are coloured in accordance with the following code :

Blue : Neutral
Brown : Live

If the plug provided is unsuitable for your socket outlets, the plug must be cut off and a suitable plug fitted.

The cut-off plug should be disposed of and must not be inserted into any 13 amp socket as this can result in electric shock. The plug or adaptor or the distribution panel should be provided with 5 amp fuse. As the colours of the wires in the mains lead of this appliance may not correspond with coloured markings identifying the terminals in your plug, proceed as follows :

The wire which is coloured blue must be connected to the terminal which is marked with the letter N or coloured black. The wire which is coloured brown must be connected to the terminal which is marked with the letter L or coloured red.

Do not connect either wire to the earth terminal of a three - pin plug.

NOTE

After replacing or changing a fuse, the fuse cover in the plug must be replaced with a fuse cover which corresponds to the colour of the insert in the base of the plug or the word that is embossed on the base of the plug, and the appliance must not be used without a fuse cover. If lost replacement fuse covers can be obtained from: your dealer.

Only 5 A fuses approved by B.S.I. or A.S.T.A. to B.S. 1362 should be used.

Thank you for buying this Pioneer product. Please read through these operating instructions so you will know how to operate your model properly. After you have finished reading the instructions, put them away in a safe place for future reference.

In some countries or regions, the shape of the power plug and power outlet may sometimes differ from that shown in the explanatory drawings. However, the method of connecting and operating the unit is the same.

Power cord CAUTION

Handle the power cord by the plug. Do not pull out the plug by tugging the cord and never touch the power cord when your hands are wet as this could cause a short circuit or electric shock. Do not place the unit, a piece of furniture, etc., on the power cord, or pinch the cord. Never make a knot in the cord or tie it with other cords. The power cords should be routed such that they are not likely to be stepped on. A damaged power cord can cause a fire or give you an electrical shock. Check the power cord once in a while. When you find it damaged, ask your nearest PIONEER authorized service center or your dealer for a replacement.

[For European model]

If the socket outlets on the associated equipment are not suitable for the plug supplied with the product the plug must be removed and appropriate one fitted.

The cut-off plug must be disposed of as an electrical shock hazard could exist if connected to a socket outlet.

WARNING: TO PREVENT FIRE OR SHOCK HAZARD, DO NOT EXPOSE THIS APPLIANCE TO RAIN OR MOISTURE.

This product complies with the Low Voltage Directive (73/23/EEC), EMC Directives (89/336/EEC, 92/31/EEC) and CE Marking Directive (93/68/EEC).

THE ON/OFF BUTTON IS SECONDARY CONNECTED AND THEREFORE DOES NOT SEPARATE THE UNIT FROM MAINS POWER IN STANDBY POSITION.

Maintenance of External Surfaces

- Use a polishing cloth or dry cloth to wipe off dust and dirt.
- When the surfaces are dirty, wipe with a soft cloth dipped in some neutral cleanser diluted five or six times with water, and wrung out well, and then wipe again with a dry cloth. Do not use furniture wax or cleansers.
- Never use thinners, benzine, insecticide sprays or other chemicals on or near this unit, since these will corrode the surfaces.

Quick Start Guide

Before making or changing the connections, switch off the power and disconnect the power cord from the AC outlet.

This is a quick guide to setting up your new receiver so you can get home theater surround sound. For more details on any of the information presented here check the main section of the manual.

1 Hooking Up Your DVD Player & TV

In order to use Dolby Digital/DTS soundtracks which are at the heart of home theater you need to hook up your DVD player with digital audio connections. You can do this by either a coaxial or an optical connection, **you don't need to do both**. The quality of these two types of connections is the same but since some digital components only have one type of digital terminal you need to figure out which yours has and hook it up to the appropriate terminal on the receiver. In order to do this you will need the proper cable. For coaxial connections you can use a regular RCA stereo cord or the specially-made coaxial cords, they have the same type of plugs. For optical connections you will need a special optical cord which you can buy at your local stereo store. Also hook up the video connection of your DVD player, the analog audio (for recording the audio on DVDs, use regular RCA stereo cords), and your TV (it's easiest to use a regular composite RCA video cords) as shown below. It is important that you hook up your TV (or monitor) in order to see a video image as well as the on screen displays (OSDs) shown by this receiver (for more on p.16-17). We also recommend hooking up your all your digital components to analog audio jacks. For this you can use regular RCA stereo cords.

Coaxial Digital Connection

If your DVD player has a coaxial terminal (not a PCM-only output) for the audio out hook it up using this terminal. Follow the diagram below. This is the best scenario, as you will be able to follow the default settings of this receiver and won't need to assign the digital inputs.

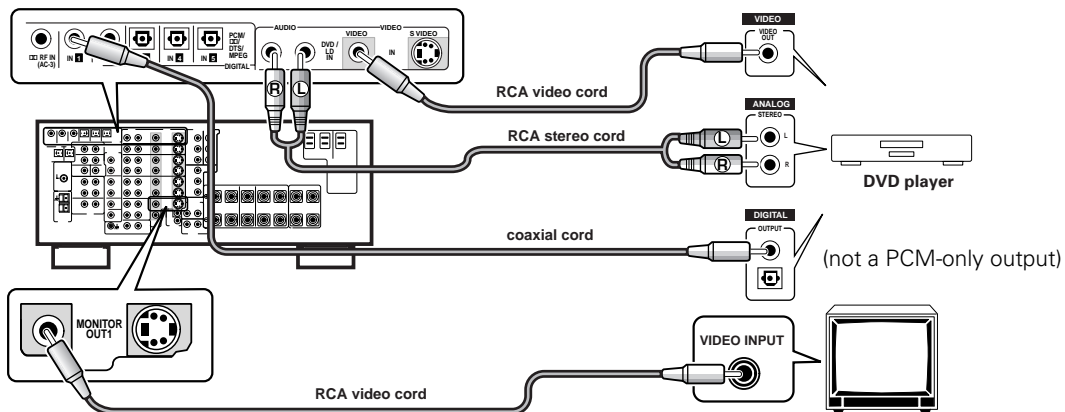

Optical Digital Connection

If your DVD player has an optical terminal (not a PCM-only output) for the audio out you can hook it up using this following the diagram below. You will need to assign the digital input (tell the receiver which input you put your DVD digital audio into). See page VI for this.

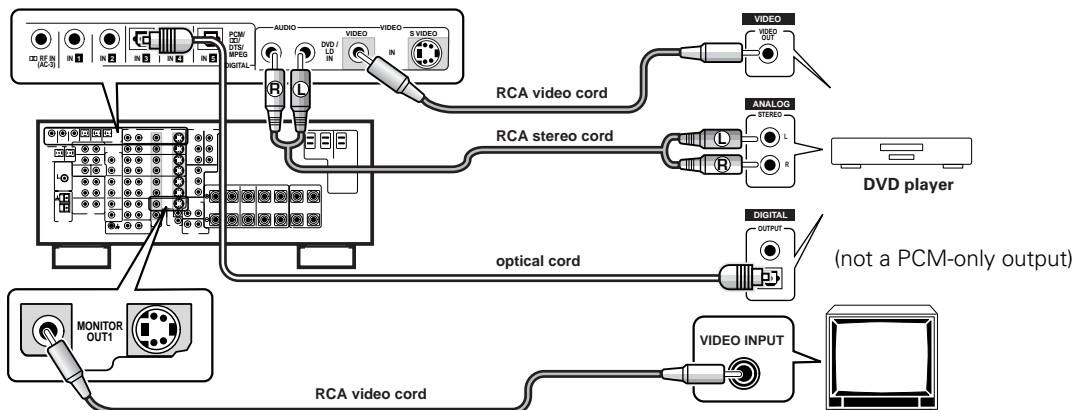

2 Speaker Connections

Home theater is designed to be setup with five, or seven speakers (front left & right; center; surround left & right; and, optimally, surround back left & right) and a subwoofer but you can use this receiver with fewer speakers. Hook up the speakers you have to the **(A)** speaker terminals on the back of the receiver. If you only have two speakers hook them up as "FRONT". If you have three hook up the single speaker as "CENTER". Follow the diagram on p.19 in order to hook up all your speakers. A center speaker is very important for watching films because the dialog comes from the center speaker in digital soundtracks. **If you do not have a CENTER speaker you must tell the receiver the CENTER channel is OFF or when you listen to digital soundtracks you won't hear any dialog.** Use the instructions on page 33-34 in order to do this.

Follow the diagram below to hook up an additional amplifier in order to use surround back speakers. These speakers are important to hear all the sound channels on new, eight channel home theater DVDs. The diagram below also explains how to hook up a subwoofer which provides realistic bass sounds.

Make sure you connect the speaker on the right to the right terminal and the speaker on the left to the left terminal. Also make sure the positive and negative (+/-) terminals on the amplifier match those on the speakers.

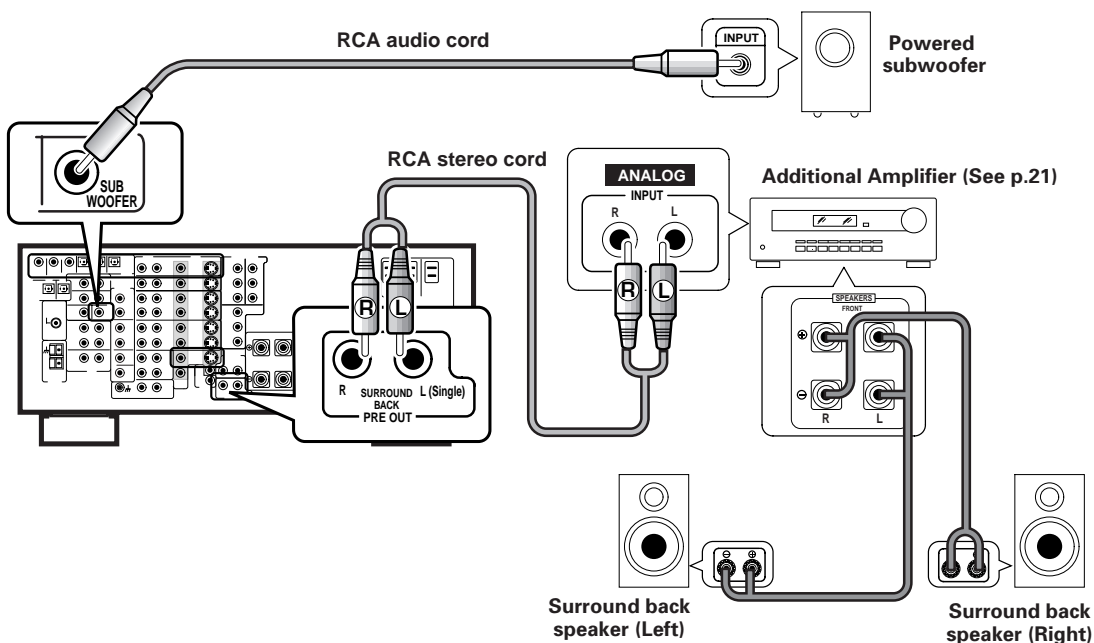

3 Setting up the Remote Control & Unit

- 1 Put the batteries in the remote control.
- 2 Plug the main unit into a wall outlet.
- 3 Press **ON/OFF** button and the **STANDBY/ON** button on the receiver to put the receiver in ON mode.

4 Digital Input Assignment

This is only necessary if you did not hook up your DVD to DIGITAL IN 1, as in the first diagram on p.III

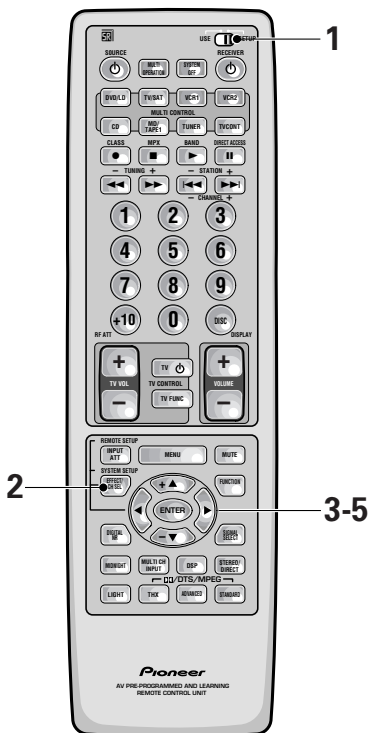

1 Set the remote control slide switch to **SETUP**.

Also make sure your TV is on and set to the receiver.

- When you're done setting up the receiver, remember to set the slide switch back to USE.

2 Press the **SYSTEM SETUP** button.

You should see the following display on your TV.

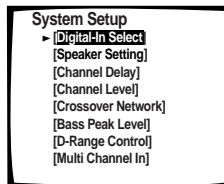

- You can escape from this screen at any time by pressing the SYSTEM SETUP button again. None of the settings you made will be entered in this case.
- If don't enter any settings the receiver will revert back to its previous state after three minutes.

3 Digital in Select should be selected (if it isn't use the ▲/▼ buttons to select it). Press **ENTER**.

You should see the following display on your TV.

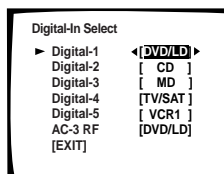

4 Choose the **Digital-3** you hooked up your DVD player to and assign "DVD/LD" to it.

Use the ◀ or ▶ buttons to choose the DVD/LD setting.

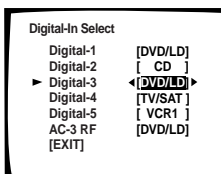

5 Select **EXIT** with ▲/▼ buttons and press **ENTER** to return to the **SYSTEM SETUP** MENU.

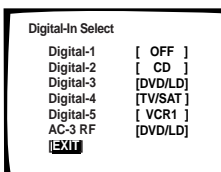

5 Playing a DVD with Surround Sound



Set the remote control slide switch to USE.

- 1 Turn on the receiver, your TV, and the DVD player.
- 2 Press the DVD/LD button on the remote control.
You should see "DVD/LD" in the display on the receiver.
- 3 Press the STANDARD button for the basic surround sound setting.
- 4 Play a DVD.

6 For Better Surround Sound

- 1 Go through the entire "system setup" procedures as outlined on pages 12-21 of this instruction manual.

If you don't hook up any other components with digital audio or do so following the default settings of the receiver (see page 14) you won't have to assign any more digital inputs, but many other adjustments will improve the sound tremendously.

- 2 Experiment with the different sound settings offered with the **DSP/DTS/MPEG** and **DSP** buttons.

For more information see pages 42-46.

- 3 As mentioned above you should go through the "speaker setup" instructions on pages 29-41 to set up your speakers properly. If you don't do this you, at least, need to make sure the **CENTER** channel is turned off if you don't have a center speaker. Use the instructions on pages 30-34.

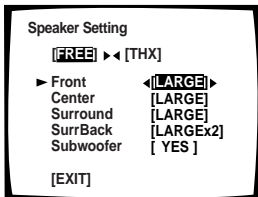

Table of Contents

Before You Start	9	Adjusting Bass and Treble	51
Checking the Supplied Accessories	9	MULTI CHANNEL IN Playback	52
How to Use This Manual	9	96kHz 24bit Performance	52
Preparing the Remote Control	9	Direct Playback	53
Loading the batteries	9	Adjusting the Brightness of the Display	53
Operating range of remote control unit	10	DUAL MONO Setting	54
Operating other PIONEER components	10	Using the Tuner	55
Installing the Receiver	11	Automatic and Manual Tuning	55
Ventilation	11	MPX mode	55
Opening the Front Panel	11	RF ATT mode	55
Connecting Your Equipment	12	Direct Access Tuning	56
Audio Components	12	Memorizing Frequently Used Stations	57
Cassette deck placement	12	Recalling Memorized Stations	58
Digital Connections	13	Using the remote control	58
Example Connection for a DVD/LD or LD player	14	Using the front panel	58
Digital Input Assignment	14	Memorizing a broadcast station name (Manual Station Name Memory)	59
Video Components	15	To erase and change the memorized station name	59
Satellite TV Components	16	An Introduction to RDS & EON	60
TV	17	Basics of EON	61
Multi Channel Input (External Decoder)	17	The receiver's internal Program Identification function	61
Connecting the Radio Antennas	18	RDS (Radio Data System) Broadcast Reception ...	62
Using external antennas	18	Displaying RDS data	62
Speakers	19	Searching for a program by program type (PTY)	63
Speaker impedance	20	Using EON search	64
Placing Your Speakers	20	Remote Control of Other Components ...	65
Speaker placement	20	Setting Up the Remote Control to Control Other Components	65
Connecting Additional Amplifiers	21	Recalling Preset Codes	65
Plugging In (Except for the U.K. model)	21	Learning Commands from Other Remote Controls	67
Displays & Controls	22	Using the Remote Control with Other Components	69
Display	22	Using Other Functions	76
Remote Control	24	Recording from Audio Components	76
Front Panel	26	Record monitor (TAPE 2 MONITOR)	76
Initial Set Up	29	Recording from Digital Audio Components	77
On Screen Display	29	Recording from Video Components	77
Switching video system between PAL and NTSC	29	Multi Operations	78
Setting Up for Surround Sound	30	Performing Multi Operations	79
Digital-In Select	32	System Off	80
Speaker Setting	33	Using the System Off Button	81
Channel Delay	35	Setting Up the Direct Function	81
Channel Level	36	Remote Back Light	82
Crossover Network	38	Resetting the Remote Control	82
Bass Peak Level	39	Erasing Multi Operations	82
Dynamic Range Control	40	Erasing Learned Remote Control Commands	83
Multi Channel In Setting	41	Erasing All Learned Commands and Preset Codes	83
Multi Channel In Setting Using the Main Unit ...	41	Video Select	84
Basic Playback	42	Techno Tidbits & Problem-solving	85
Sound Modes	42	Preset Code List	88
Selecting a Sound Mode	45	Troubleshooting	92
Playing Sources with Dolby Digital, DTS or MPEG	46	Specifications	95
Playing Stereo Sources	47		
Switching Analog and Digital Signal Input	48		
Reducing Noise During Playback	49		
Listening in Midnight Mode	50		
Using the Loudness Mode	50		

Features

Multi Channel Stereophonic Concept

The VSX-909RDS/909RDS-G receiver is constructed with Pioneer's industry-leading multi channel stereophonic concept. This well-developed approach to receiver circuitry takes the high level base technology that, up until now, has been only used for stereo equipment and applies it to multi-channel audio-visual receivers. The result is that the product, in addition to being expertly built, and gives you optimal sound reproduction of DVDs, other multi channel sources and stereo sources as well. This receiver is designed capture to a true reproduction of the intentions of a filmmaker or music producer at the time they were mastering the soundtrack in the studio. It incorporates 5 independent 110 watt built in power amplifiers, with high-performance Hex power Direct Power MOS FET output transistors. This construction provides improved linearity and accurate representation of each channel for true high fidelity reproduction from even the most demanding Dolby Digital and DTS program sources. In addition, the amplifier uses Direct Construction to give the purest sound available. All these elements consolidated in one receiver afford the listener a new surround sound experience in his or her home.

Universal Player Compatibility

This receiver incorporates the latest technology and is able to handle cutting edge audio formats, like DVD Audio, which are just hitting the market. Its high compatibility offers a variety of inputs to decode all types of sources at the highest possible quality. The receiver's multi channel in connections lets you hook up eight discrete channels of audio. It also has multi channel direct inputs and the ability to decode the cutting edge formats.

Decoding of Next Generation Digital Source Film Formats

Built into this receiver is the latest in film sound format technology. This technology includes the recent THX SURROUND EX and HOME THX CINEMA surround modes which employ special processing to allow you to enjoy movie soundtracks with the same level of power and realism you experience in well-designed movie theaters. The THX SURROUND EX mode has been especially designed to incorporate surround back channels that some new source material uses. This receiver has the ability to decode Dolby Digital, Dolby Pro Logic, MPEG and DTS (Digital Theater Systems) sources, which are the standards of home theater today. It also offers component video terminals for the sharpest video transmission available to the consumer.

Manufactured under license from Lucasfilm Ltd. U.S. patent numbers 5,043,970; 5,189,703; and/or 5,222,059. European patent number 0323830. Other U.S. and foreign patents pending. Lucasfilm and THX are registered trademarks of Lucasfilm Ltd. Surround EX is a trademark of Dolby Labs. Used under authorization.

The MPEG logo is a registered trademark of Royal Philips Electronics.

"DTS", "ES" and "DTS Digital Surround" are trademarks of Digital Theater Systems, Inc. Manufactured under licence from Digital Theater Systems, Inc.

Manufactured under license from Dolby Laboratories. "Dolby", "AC-3", "Pro Logic", and double-D symbol are trademarks of Dolby Laboratories. Confidential unpublished works. © 1992 - 1997 Dolby Laboratories. All rights reserved.

Advanced Theater Modes & DSP Surround Modes

Advanced Theater modes enhance the sound of either film or music so a more dramatic effect can be achieved. The four modes are each designed to accentuate specific sound qualities, giving the listener a wide range of possibilities. DSP (Digital Signal Processing) surround modes give you the capability of transforming your living room into seven different sonic environments when listening to music.

RDS (Radio Data System)

With the RDS system, FM station can send additional signals with their regular program signals. For example, the stations send their station names, and information about the type of programs they broadcast, such as news, sport or music. This unit receives three types of RDS signals: RT, PS, and PTY.

The Energy-saving Design

This unit is designed to use less than 1 W of energy when the receiver is in standby mode.

Before You Start

Checking the Supplied Accessories

Please check that you have received all of the following supplied accessories.



FM wire antenna



AM loop antenna

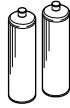

**"AA" IEC LR6
batteries x 2**

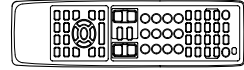

**Remote control unit
• Operating Instructions**

How to Use This Manual

This manual is for the VSX-909RDS/909RDS-G Audio/Video Multi-Channel Receiver.

This manual is divided into three main sections which will tell you how to setup and use the unit :

PREPARATION

First carry out the tasks below in this "Before You Start" section to prepare the remote control, then connect the receiver to your other components as described in "Connecting Your Equipment" (p.12). Take special care to connect your digital equipment like DVDs and LDs properly to be able to take advantage of the receiver's surround sound systems (p.13-14). To learn about a specific button, control, or indicator, see "Displays & Controls" starting on p.22.

SET UP

Performing the tasks in "Initial Set Up" (from p.29) is essential to get proper surround sound.

OPERATION

To play some music or soundtrack refer to "Basic Playback" on p.42. "Using the Tuner" (p.55) explains how to use the radio of this unit. Doing the operations in "Remote Control of Other Components" (p.65) is highly recommended so you can use this unit's remote control for all your components. "Using Other Functions" (p.76) explain the other possibilities of the receiver.

"Techno Tidbits & Problem-solving" (p.85) provide detailed technical information and a troubleshooting guide.

The following marks and symbols are used throughout the manual:



Provides additional information, precautions, and advice.



Indicates a blinking button, indicator, or display.



Indicates a steadily lit button, indicator, or display.

Preparing the Remote Control

Loading the batteries

Load the batteries into the remote control as shown below. Please use alkaline batteries. When you notice a decrease in the operating range of the remote control, replace all batteries with new ones.

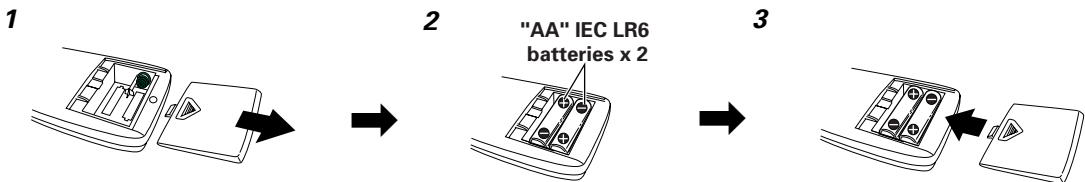

CAUTION!

Incorrect use of batteries may result in such hazards as leakage and bursting. Observe the following precautions.

- Never use new and old batteries together.
- Insert the plus and minus sides of the batteries properly according to the marks in the battery case.
- Batteries with the same shape may have different voltages. Do not use different batteries together.
- When disposing of used batteries, please comply with governmental regulations or environmental public institution's rules that apply in your country or area.

Before You Start

Operating range of remote control unit

The area in which you can use the remote control to operate the VSX-909RDS/909RDS-G is fairly large. To use, point the remote control toward the remote sensor on the front panel of this unit while within the range shown right.

Remote control may not function properly if:

- There are obstacles between the remote control and the remote sensor.
- Direct sunlight or fluorescent light is shining onto the remote sensor.
- The receiver located near a device emitting infrared rays.
- Operated simultaneously with another remote control which uses infrared rays.

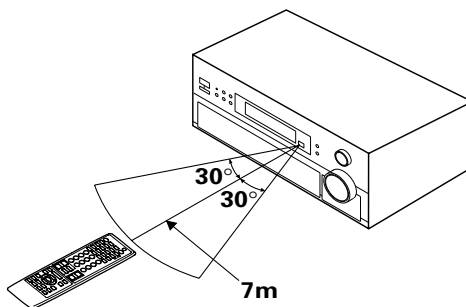

Operating other PIONEER components

Connecting an optional control cord allows you to operate other PIONEER components simply by pointing the receiver's remote control at the remote sensor on the front panel of the receiver. The receiver then sends the remote control signals to the other components via the CONTROL OUT terminal.

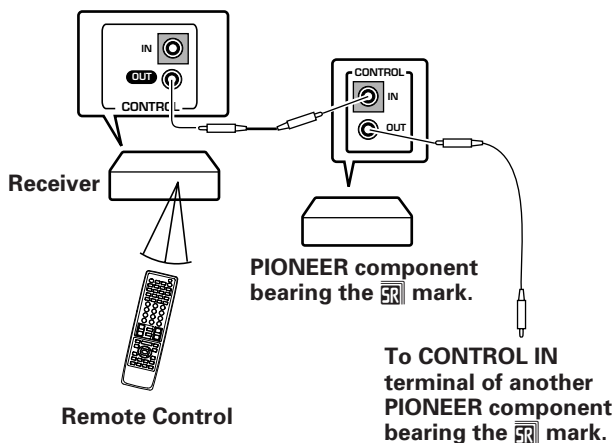

- You can also control PIONEER components (and those made by other manufacturers) by pointing the receiver's remote control directly at the respective components. This type of operation does not require control cords. All you have to do is recall the appropriate preset code (refer to "Recalling preset codes" on page 65).
- If you use a remote control hooked up via the CONTROL IN jack with a control cord, you won't be able to use this unit's remote control.

Installing the Receiver

Ventilation

- When installing this unit, make sure to leave space around the unit for ventilation to improve heat radiation (at least 60 cm at the top, 10 cm at the rear, and 30 cm at each side). If not enough space is provided between the unit and walls or other equipment, heat will build up inside, interfering with performance or causing malfunctions.
- Do not place on a thick carpet, bed, sofa or fabric having a thick pile. Do not cover with fabric or other covering. Anything that blocks ventilation will cause the internal temperature to rise, which may lead to breakdown or fire hazard.

Opening the Front Panel

To open the front panel push gently on the lower third of the panel with your finger.

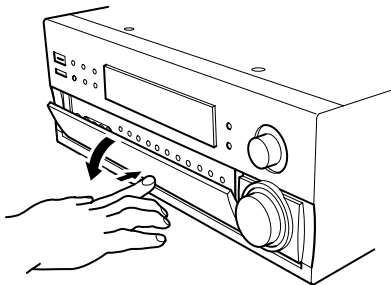

Connecting Your Equipment

Before making or changing the connections, switch off the power and disconnect the power cord from the AC outlet.

Audio Components

To begin set up connect your audio components to the jacks as shown below. These are all analog connections and your analog audio components (turntable, cassette deck) use these jacks. Remember that for components you want to record with you need to hook up four plugs (a set of stereo ins and a set of stereo outs), but for components that only play (like a turntable) you only need to hook up one set of stereo plugs (two plugs). To use DTS or Dolby Digital surround sound features you must hook up your digital components to the digital inputs (see p.13). We also recommend hooking up your digital components to analog audio jacks. If you want to record to/from digital components (like an MD) to/from analog components you must hook up your digital equipment with these analog connections. See p.13 & 14 for more on digital connections.

*The arrows indicate the direction of the audio signal.

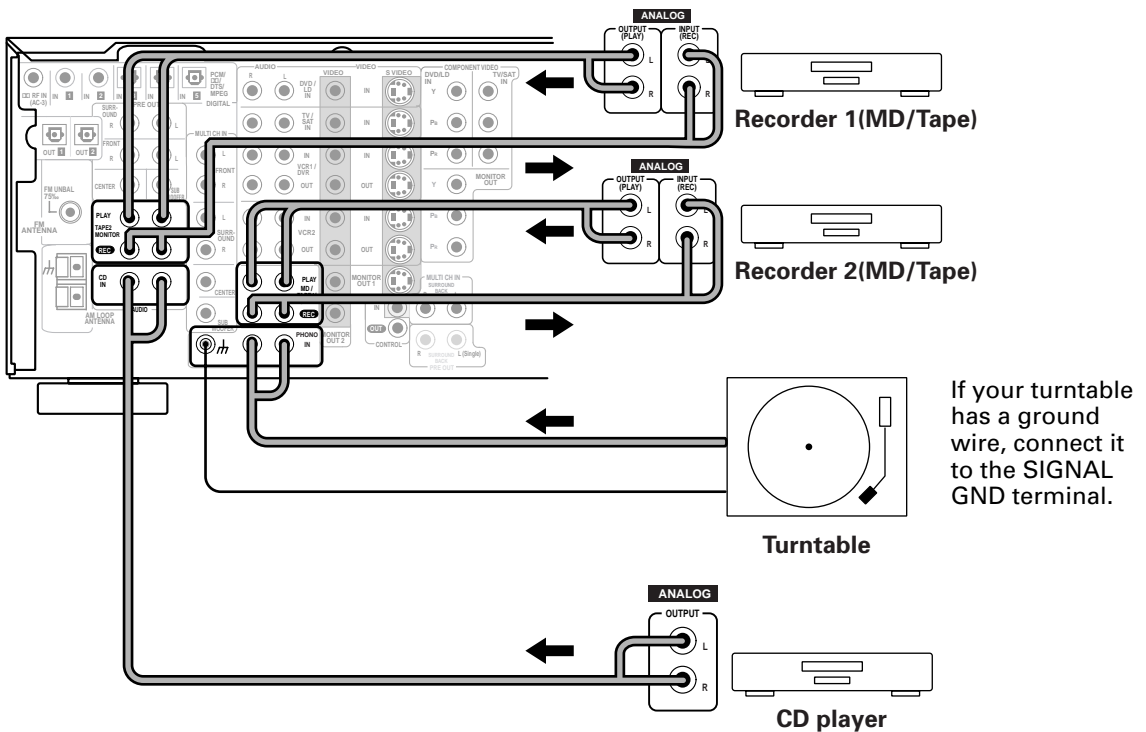

Please don't hook up any other component to the phono jacks other than a turntable. It could damage the equipment. If your turntable has a built-in amplifier please hook it up to an input other than PHONO.

■ Audio cords

Use audio cords (not supplied) to connect the audio components.

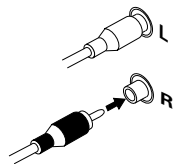

Connect red plugs to R (right) and white plugs to L (left).

Be sure to insert completely.

Cassette deck placement

Depending on where the cassette deck is placed, noise may occur during playback of your cassette deck which is caused by leakage flux from the transformer in the receiver. If you experience noise, move the cassette deck farther away from the receiver.

Digital Connections

In order to use Dolby Digital/DTS soundtracks which are at the heart of home theater you need to make digital audio connections. You can do this by either a coaxial or an optical connection (you don't need to do both). The quality of these two types of connections is the same but since some digital components only have one type of digital terminal, it is a matter of matching like with like (for example, the coaxial out from the component to coaxial in on the receiver). The receiver has two coaxial and three optical inputs for a total of five digital inputs. A DVD/LD player or LD player should be connected to a digital jack and the special **RF** jack (if the LD has one) as well as a pair of analog jacks (see the next page). If possible, hook up your digital equipment in accordance with this receiver's default settings. See "Digital Input Assignment" below left, in order to do this. We also recommend hooking up your digital components to analog audio jacks in order to make recording from some digital sources which may be copy protected. Connect your digital components as shown below.

There are two optical digital out jacks (the MD recorder is connected to one in the diagram below). If you connect this to the optical input on a digital recorder (currently these include MD, DAT and CD-R) you can make direct digital recordings with this unit.

Before making or changing the connections, switch off the power and disconnect the power cord from the AC outlet.

*The arrows indicate the direction of the audio signal.

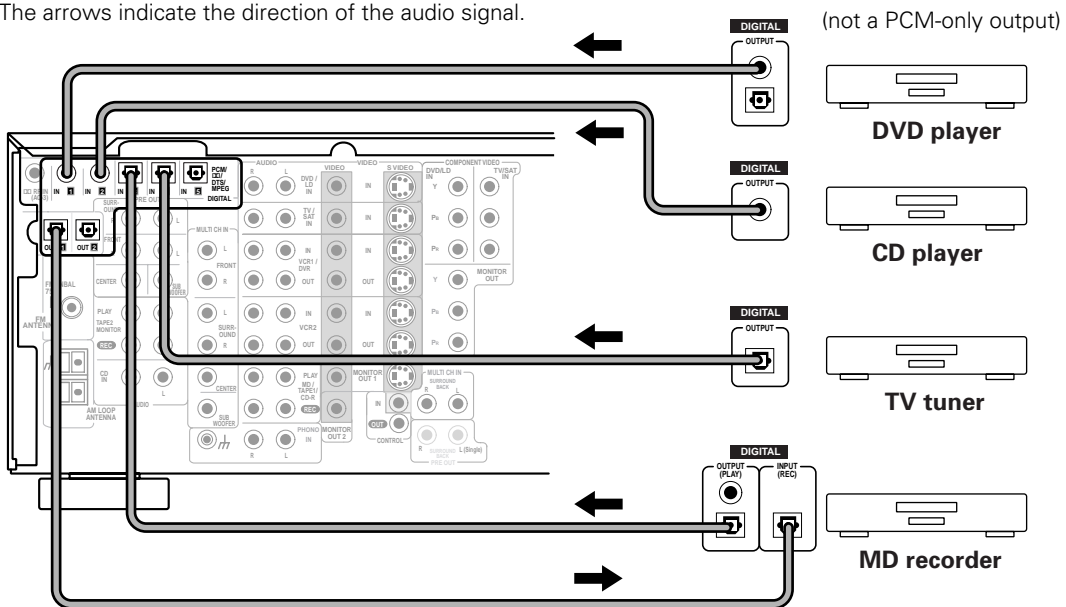

■ Coaxial cords/Optical cables

Commercially available digital audio coaxial cords (standard video cords can also be used) or optical cables (not supplied) are used to connect digital components to this receiver.

When you use optical digital input or output terminals, pull off the caps and insert the plugs. Be sure to insert completely.

Coaxial cord
(or standard video cord)

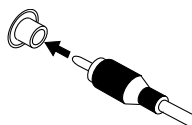

Optical cable

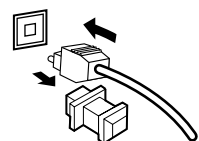

Example Connection for a DVD/LD or LD player

Make sure you connect your DVD/LD or LD players using both the **AC-3** RF jack and either a coaxial or optical (you don't need to do both of these) digital connections. If your player has an **AC-3** RF output this will ensure you can use all LDs (see p.15). We also recommend hooking up your digital components to analog audio jacks. Before making or changing the connections, switch off the power and disconnect the power cord from the AC outlet.

*The arrows indicate the direction of the audio signal.

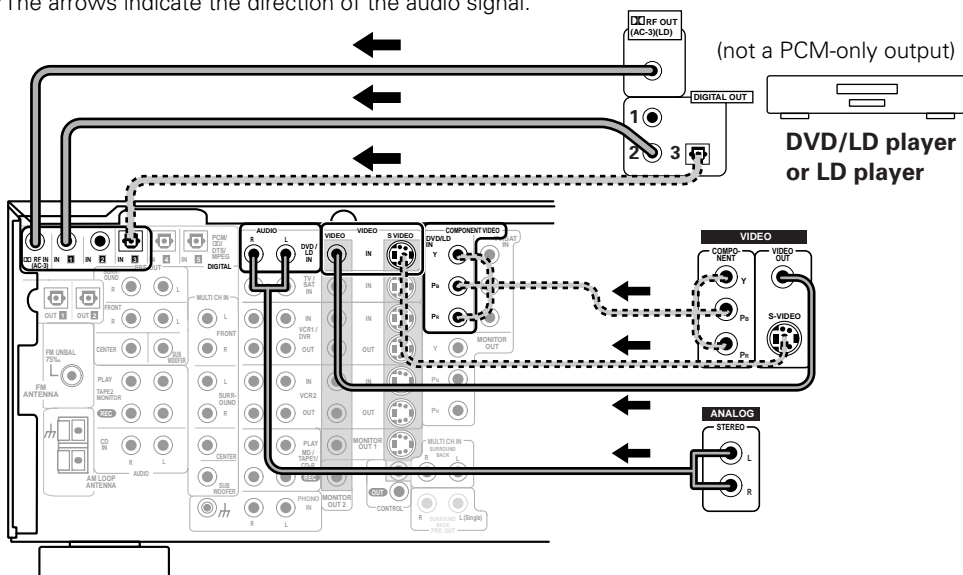

Be sure to make either a digital coaxial or digital optical connection (pictured as DIGITAL jack 1 or DIGITAL jack 3 in this diagram) as well, but you DON'T need to make both. Also, be sure to assign the jacks to the proper component(s) with the Digital-In Select procedure (see p.32) if necessary. See the explanation below for details.

Digital Input Assignment

Unlike analog connections, the jacks for digital connections are not dedicated to one type of component, they can be used freely. Thus you must tell the receiver what digital component in which jack so your components will be in sync with the the names on the remote control buttons and the like. To avoid having to assign the digital inputs you can hook up your equipment in accordance with the receiver's default settings.

The default settings are:

DIGITAL IN 1: DVD/LD

DIGITAL IN 2: CD

DIGITAL IN 3: MD

DIGITAL IN 4: TV/SAT

DIGITAL IN 5: VCR1

AC-3 RF: DVD/LD

You will notice that Digital IN 1, for example, is a coaxial jack. If your DVD/LD player only has an optical out jack on it then you won't be able to hook up your components in accordance with the VSX-909RDS/909RDS-G default setting. In this case you will need to assign the digital inputs. See Digital-In Select on p.32 in order to do this.

Video Components

Connect your video components to the jacks as shown below. Regarding a DVD there are two types of connections to make. Hook up your video signal with either component video, S-video, or composite video cords (the quality descends in this order) but remember, the video component you are watching and your TV must be hooked up with same type of video cord or you won't be able to see the picture. For the audio signal, order to use Dolby Digital/DTS you must hook up a digital input. It is also a good idea to hook up your DVD components with analog audio connections as well, since some DVDs may not have a digital audio track. To cover all possible laser discs a DVD/LD player or LD player requires an analog connection and two digital connections (a coaxial or optical and a specialized RF connection shown at the very top of the first diagram below). Before making or changing the connections, switch off the power and disconnect the power cord from the AC outlet.

*The arrows indicate the direction of the video signal.

Connecting DVD/LD players

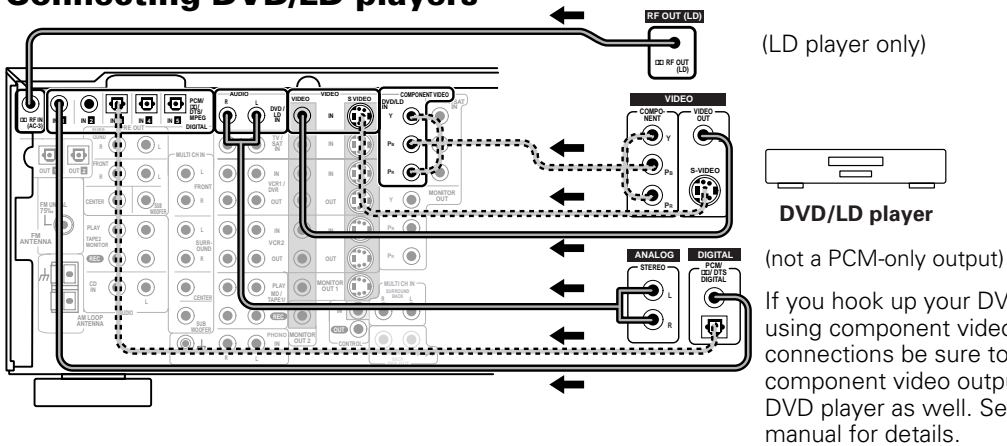

Connecting VCRs or DVRs

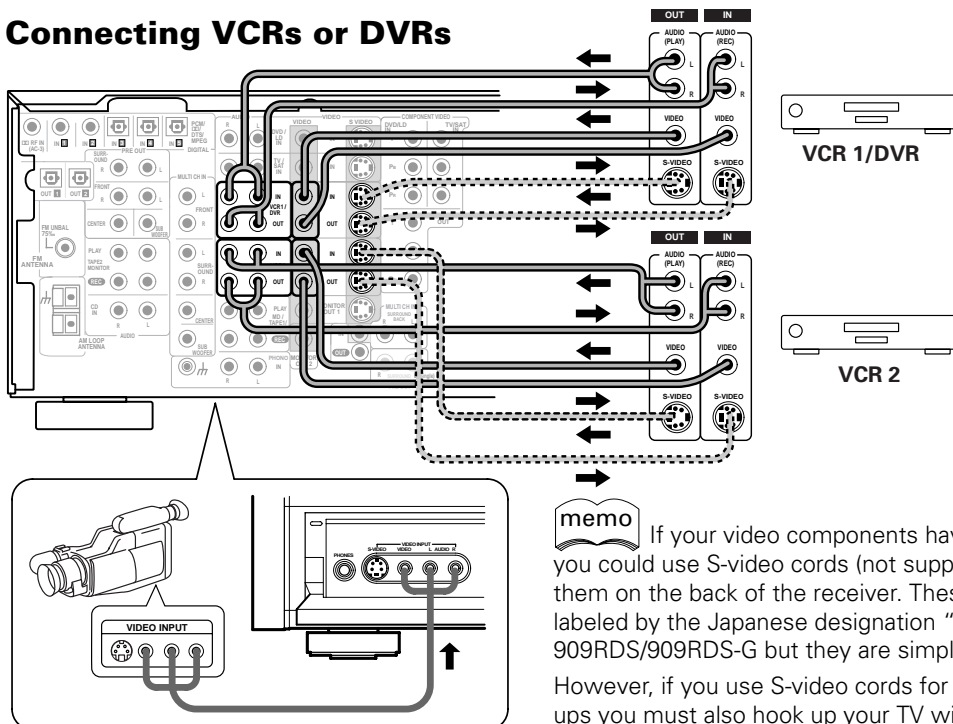

Front video connections are accessed via the front panel input selector as "VIDEO."

memo If your video components have S-video jacks, you could use S-video cords (not supplied) to connect them on the back of the receiver. These jacks are labeled by the Japanese designation "S2" on the VSX-909RDS/909RDS-G but they are simply S-video jacks. However, if you use S-video cords for your video hook ups you must also hook up your TV with S-video connections. Conversely, if you use regular composite video cords for video hook ups, you should use them for your TV as well.

Satellite TV Components

Connect your satellite TV components to the jacks as shown below. Hook up the video signal with either component video, S-video, or composite video cords (the quality descends in this order) but remember, the video component you are watching and your TV must be hooked up with same type of video cord or you won't be able to see the picture. For the audio signal, order to use digital soundtracks (sometimes broadcast over digital satellite TV) you must hook up a digital input. Use either a coaxial or optical cables, it doesn't matter which (you don't need to use both). It's also a good idea to hook up your audio with analog cables (see below). This connection is called STEREO AUDIO OUT in the diagram.

Before making or changing the connections, switch off the power and disconnect the power cord from the AC outlet.

*The arrows indicate the direction of the TV signal.

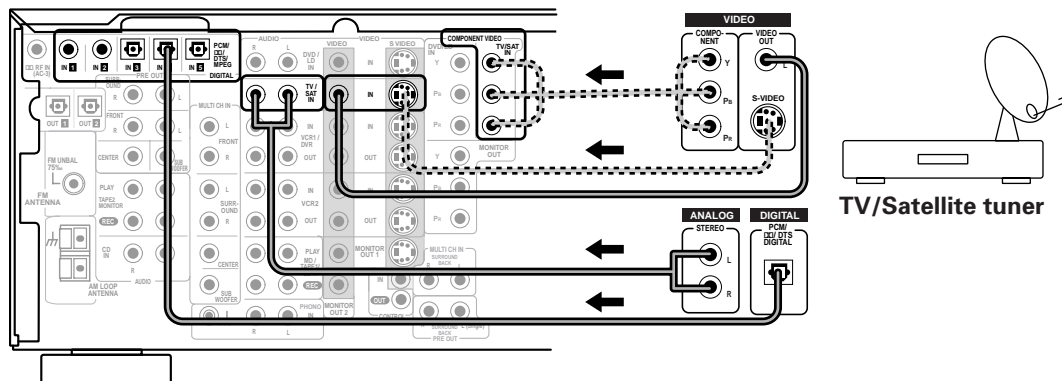

■ Analog audio/video cords

Use audio/video cords (not supplied) to connect the video components and a video cord to connect the monitor TV.

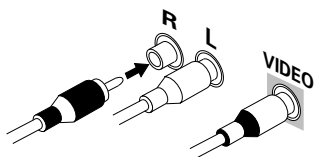

Connect red plugs to R (right), white plugs to L (left), and the yellow plugs to VIDEO.

Be sure to insert completely.

■ Digital audio coaxial cords/ Optical cables

Commercially available digital audio coaxial cords (standard video cords can also be used) or optical cables (not supplied) are used to connect digital components to this receiver.

When you use optical digital input or output terminals, pull off the caps and insert the plugs. Be sure to insert completely.

**Digital audio coaxial
cord
(or standard video
cord)**

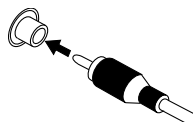

Optical cable

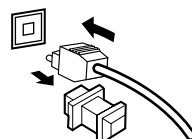

TV

Connect your TV to the jacks as shown below. Hook up the signal with either component video, S-video, or composite video cords (the quality descends in this order) but remember, the video component you are watching and your TV must be hooked up with same type of video cord or you won't be able to see the picture. Before making or changing the connections, switch off the power and disconnect the power cord from the AC outlet.

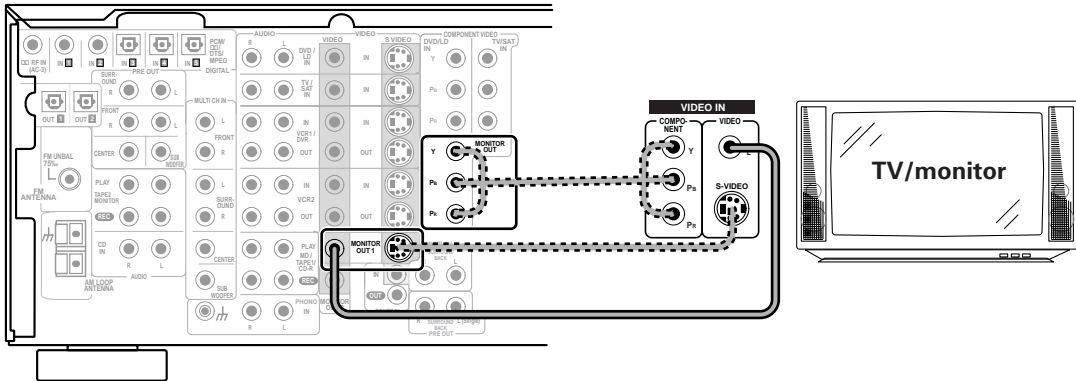

The COMPONENT VIDEO OUT jack can be used to get a TV picture but it doesn't show this receiver's on screen display (OSD).
If you use S video cords to hook up a component the OSDs from the receiver will only be able to be seen on the S video out terminals.

Multi Channel Input (External Decoder)

In some cases you may want to have your source material (DVD, etc) decoded externally. If you find you need a multi channel external decoder hook one up as shown below, but for most people this component is unnecessary (For more on this see p.52).

Before making or changing the connections, switch off the power and disconnect the power cord from the AC outlet.

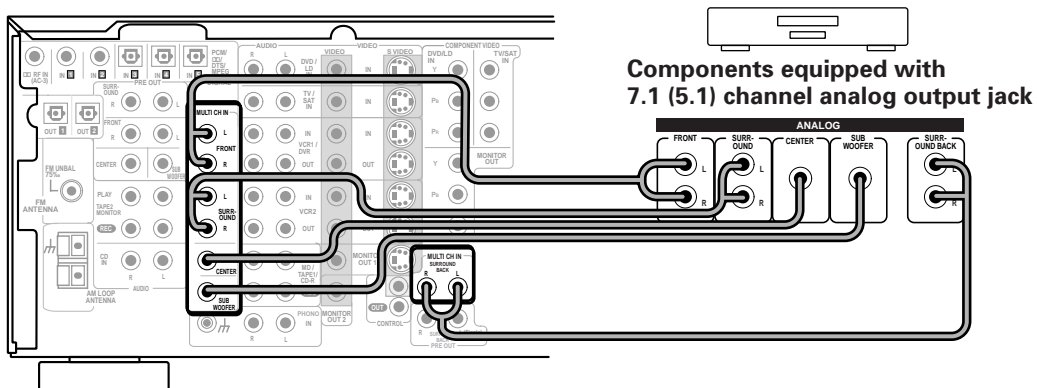

Connecting the Radio Antennas

Connect the supplied FM wire antenna and the AM loop antenna to the antenna terminals as shown below. These antennas should provide adequate reception quality in most cases, but connecting outdoor antennas should noticeably improve sound quality.

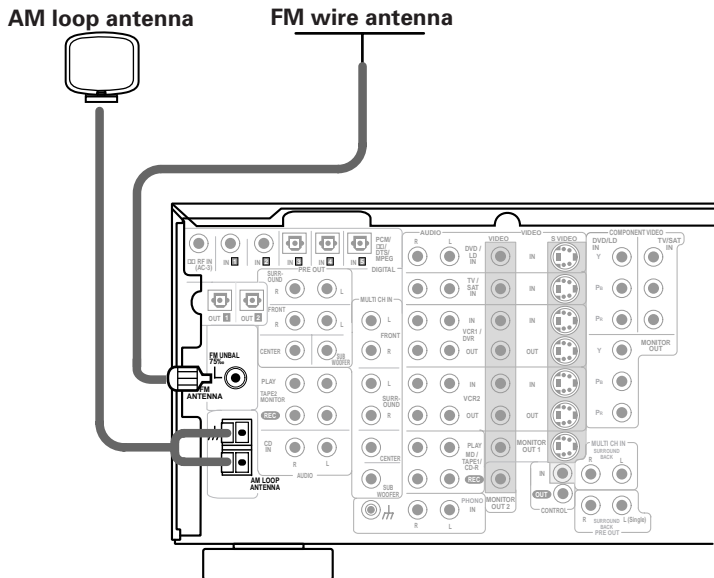

AM loop antenna

① Assemble the antenna.

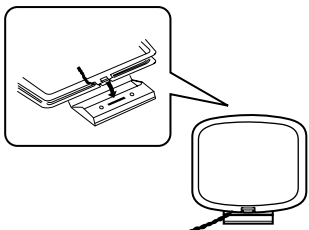

② Twist exposed wire strands together and insert.

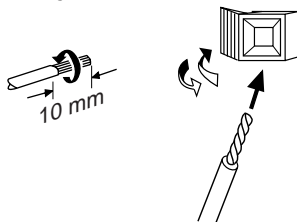

③ Attach to a wall, etc. (if desired) and face toward the direction providing the best reception.

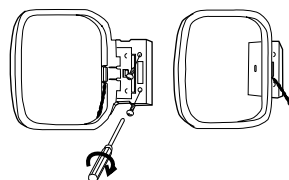

Using external antennas

To improve FM reception

Connect an external FM antenna.

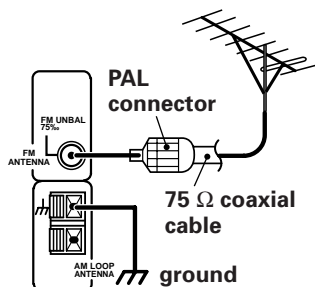

To improve AM reception

Connect a 5–6 meter length of vinyl-coated wire to the AM antenna terminal in addition to the supplied AM loop antenna. For the best possible reception, suspend horizontally outdoors.

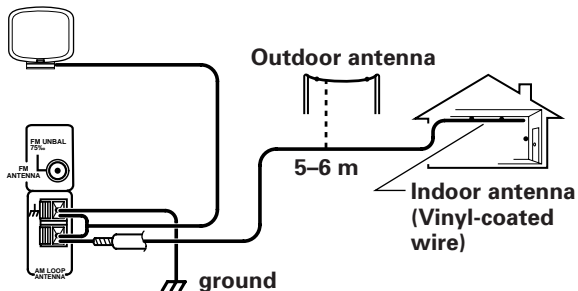

Speakers

A full complement of eight speakers is shown here but, naturally, everyone's home set up will vary. Simply connect the speakers you have in the manner described below. The receiver will work with just two stereo speakers (called "front" speakers in the diagram) but the receiver is designed to be used with at least three speakers.

One of the latest features of home theater is the use of SURROUND BACK speakers. These speakers add even greater realism in movie sound effects and new discs with soundtracks in Dolby Digital or DTS incorporates these channels. In order to be able to use these channels you must hook your SURROUND BACK speakers up to an external amplifier and then connect that to the VSX-909RDS/909RDS-G, as shown in the diagram below. If you only have one SURROUND BACK speaker hook it up to the SURROUND BACK L (SINGLE) terminal on the back of the receiver.

In general, make sure you connect the speaker on the right to the right terminal and the speaker on the left to the left terminal. Also make sure the positive and negative (+/-) terminals on the receiver match those on the speakers. Before making or changing the connections, switch off the power and disconnect the power cord from the AC outlet.



The receiver has two speaker systems, A & B. A is the main system supporting the full complement of surround sound speakers. If you switch on both A & B speaker systems, only front speakers and the subwoofer will be audible. No sound will come from the center or surround speakers but multi channel sources will be down-mixed to the active speakers so no sound will be lost. Similarly, if you choose just the B system you'll only hear the front speakers connected to the B system and multi channel sources will be down-mixed to these two speakers. Please use speakers with a nominal impedance rated 6Ω-16Ω.

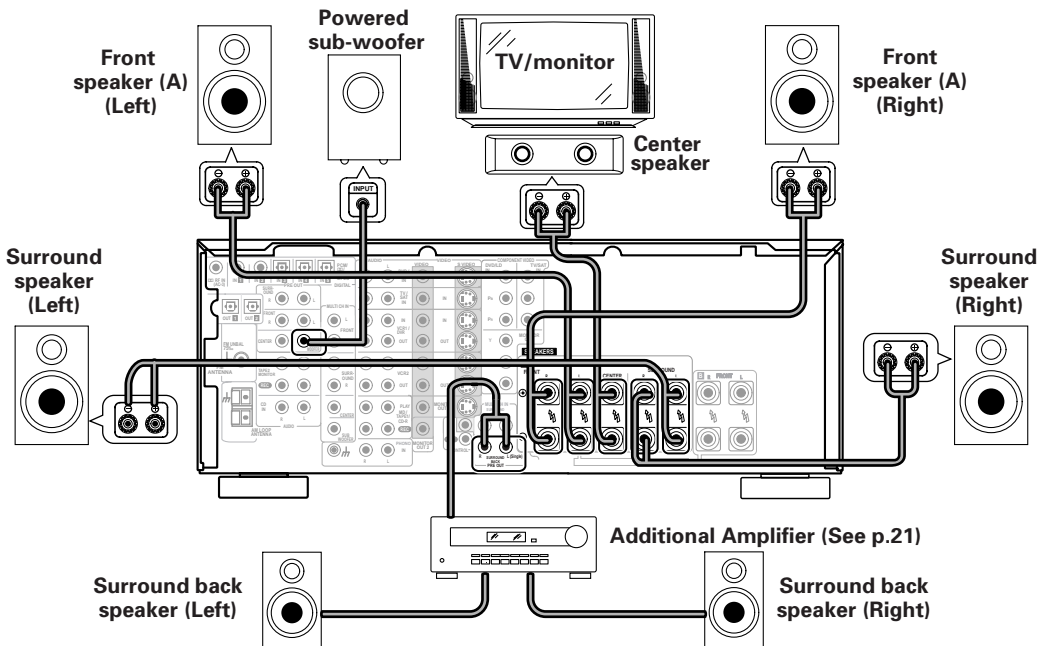

■ Speaker terminals

① Twist exposed wire strands together.

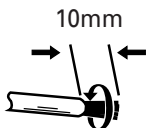

② Loosen speaker terminal and insert exposed wire.

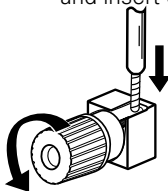

③ Tighten terminal.

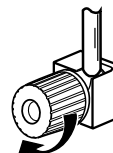

Connecting Your Equipment

Speaker impedance

You can change the speaker impedance to suit the kind of speakers you have in your home system. We recommend, however, using speakers with an impedance of 8 Ω -16 Ω (the default setting). If you are using 6 Ω –less than 8 Ω impedance speakers, you need to change the impedance setting.

⏻ STANDBY/ON

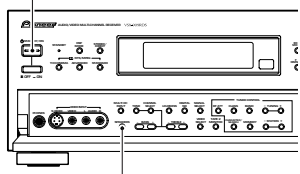

SPEAKERS



To check which impedance setting to hold down the SPEAKERS button for 2-3 seconds. You'll get a display like these telling you the speaker impedance setting.

Before operating the receiver, be sure to press the main power button on the front panel to turn the power ON (⏻).

First turn the receiver off, then press the ⏻ STANDBY/ON button while holding down the SPEAKERS button.

Choose the impedance setting by pressing the SPEAKERS button again. You can choose the 8 Ω -16 Ω setting or the 6 Ω -8 Ω setting.

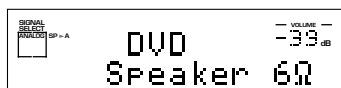

(This display indicates a 6 Ω -less than 8 Ω impedance setting.)

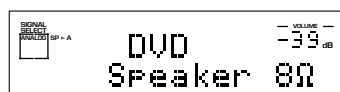

(This display indicates an 8 Ω -16 Ω impedance setting.)

Placing Your Speakers

Proper speaker placement is essential to realize the best sound from your system. The diagram and tips given here are just a rough guide; be sure to read the instructions that come with your speakers.

Speaker placement

If you have a multiple speaker arrangement the placement of the speakers is extremely important. To achieve the best possible surround sound, install your speakers as shown below. Make sure all speakers are installed securely to prevent accidents and improve sound quality. Be sure to consult your speaker manuals for the best placement of the speakers. Some speakers are designed to be floor-standing but others benefit greatly from speakers stands which raise them off the floor.

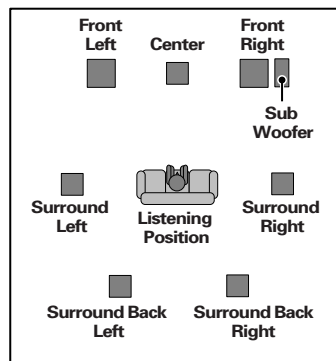

- Install the left and right front speakers at equal distances from the TV.
- When installing speakers near the TV, we recommend using magnetically shielded speakers to prevent possible interference such as distortion in the color of the TV screen. If you do not have magnetically shielded speakers and notice discoloration of the TV screen, place the speakers farther away from the TV.
- Install the center speaker above or below the TV so that the sound of the center channel is localized at the TV screen.

CAUTION:

When installing the center speaker on top of the TV, be sure to secure it with tape or some other suitable means. Otherwise, the speaker may fall from the TV due to external shocks such as earthquakes, and it may lead to endangering those nearby or damaging the speaker.

- If possible, install the surround speakers slightly above ear level.
- It may be difficult to obtain a cohesive surround effect if the surround speakers are installed farther away from the listening position than the front and center speakers.

Connecting Additional Amplifiers

To hook up surround back speakers you need to use an additional amplifier. Other than for that purpose this receiver has more than sufficient power for any home use, but it is possible to add additional amplifiers to every channel of your system. Make the connections shown below to add amplifiers to power your speakers. Before making or changing the connections, switch off the power and disconnect the power cord from the AC outlet.

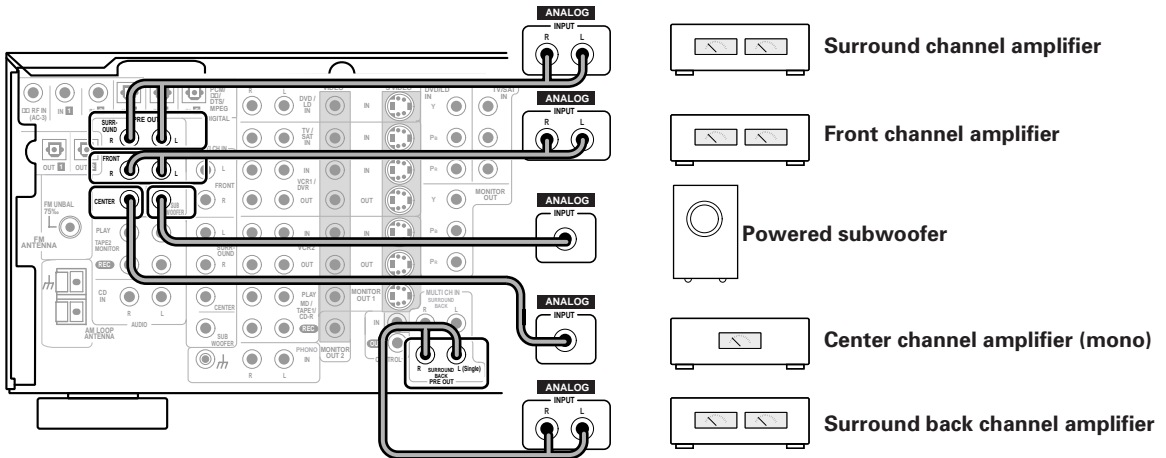

You can use the additional amplifier on the surround back channels for a single speaker as well. In this case plug the amplifier into the L (SINGLE) terminal only. We suggest using a Pioneer M-10X, A-509R amplifier as your additional amp.

Plugging In (Except for the U.K. model)

Up to three components can be powered from this receiver. Two of the outlets are switched, which means that power is switched on and off with the receiver. The third is unswitched, which means that power is delivered so long as the receiver is plugged in.

Before making or changing the connections, switch off the power and disconnect the power cord from the AC outlet.

After connecting all your components, plug the receiver's power cord into a standard wall power outlet.

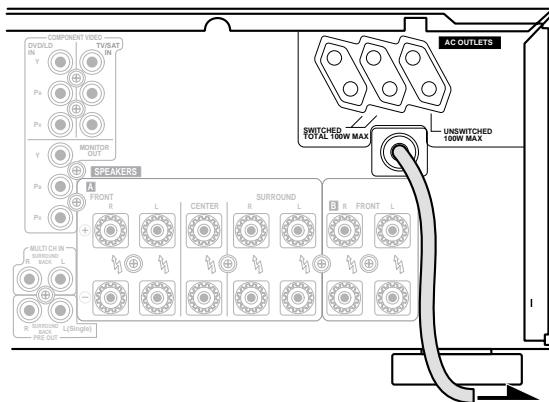

The illustration is not applicable to the U.K. model.

Caution!

Do not connect a monitor or TV to this unit's AC OUTLETS.

Caution!

Power consumption of any equipment connected to the **switched** power outlets should not exceed **100W (0.8A)**.

Power consumption of any equipment connected to the **unswitched** power outlet should not exceed **100W (0.8A)**.

To avoid overheating, fire risk and possible malfunction, do not connect high-wattage appliances such as heaters, irons, monitors or TV sets to this units AC outlets.

Disconnect the receiver from the power outlet when it's not in regular use, for example, when on vacation.

Displays & Controls

Display

All the display information is explained and/or referenced here.

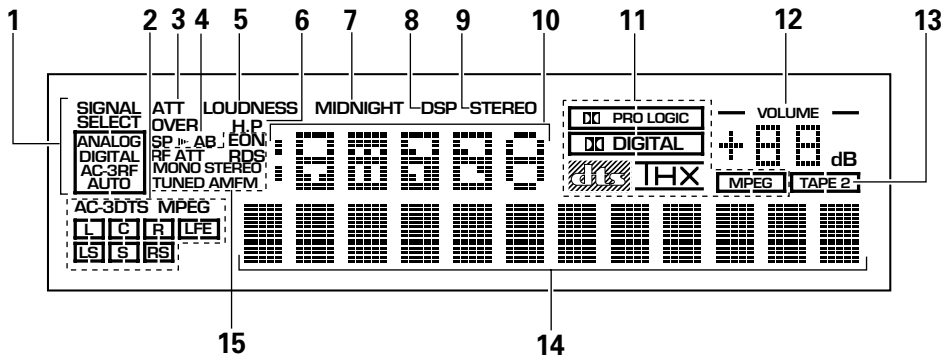

1 SIGNAL SELECT indicators

Light to indicate the input signal you selected.

ANALOG : Lights when analog signals are assigned.

DIGITAL : Lights when digital audio signals are selected.

AC-3 RF : Lights when AC-3 RF signals are assigned.

AUTO : Lights when the receiver is set to select the input signal automatically.

2 Program Format indicators

AC-3 : Lights when a source with Dolby Digital signals is played.

DTS: Lights when a source with DTS audio signals is played.

MPEG: Lights when a source with MPEG audio signals is played.

For Dolby Digital or DTS sources, these indicators change according to which channels are active in the source. When all three LS (left surround), S (surround) and RS (right surround) light at the same time it means a Source with Surround EX or DTS-ES flag is being used.

L – Left front channel.

C – Center channel.

R – Right front channel.

LS – Left surround channel.

S – Surround channel (mono).

RS – Right surround channel.

LFE – Low Frequency Effects channel.

3 Analog level indicators

OVER – When the source signal is analog, this lights if the signal is in danger of distorting. Press INPUT ATT on the remote control to lower the signal level.

ATT – Lights when INPUT ATT is used to reduce the level of the analog source signal.

4 Speaker indicators

Light to indicate the current speaker system, A and/or B.

5 LOUDNESS indicator (See p.50)

Lights when the LOUDNESS mode is on.

6 H.P (headphones)

Lights when headphones are connected to the PHONES jack (speakers systems A and B both turn off automatically).

7 MIDNIGHT indicator (See p.50)

Lights when the MIDNIGHT LISTENING mode is on.

8 DSP indicator (See p.42-46,48)

Light when a DSP or Advanced Theater modes are selected.

9 STEREO indicator

Lights when a STEREO mode is selected.

10 Function indicator

Displays the function.

11 /dts/MPEG mode indicators

DIGITAL : When the /dts/MPEG mode on the receiver is on, this indicator lights to indicate playback of a Dolby Digital signal. However, PRO LOGIC lights during 2 channel playback of Dolby Digital.

PRO LOGIC : When the /dts/MPEG mode on the receiver is on, this indicator lights during 2 channel playback.

dts : Lights when DTS signals are input.

THX: Lights when the HOME THX CINEMA mode is selected.

MPEG: Lights when MPEG signals are input.

12 MASTER VOLUME indication

Displays current volume level.

13 TAPE 2 indicator

Lights when the TAPE 2 monitor is on.

14 Character display

Displays sound modes, general information.

15 Tuner indicators

MONO: Lights when the tuner is set to receive FM broadcasts and when selected MPX mode.

STEREO: Lights when a FM stereo broadcast is received in the auto stereo mode.

TUNED: Lights when a broadcast is received.

AM/FM: Light to indicate the current band (FM or AM).

EON: Lights when an RDS stations transmitting the EON data service is being received.

RF ATT: Lights when the RF attenuator is on.

RDS: Lights when RDS broadcast is being received.

Remote Control

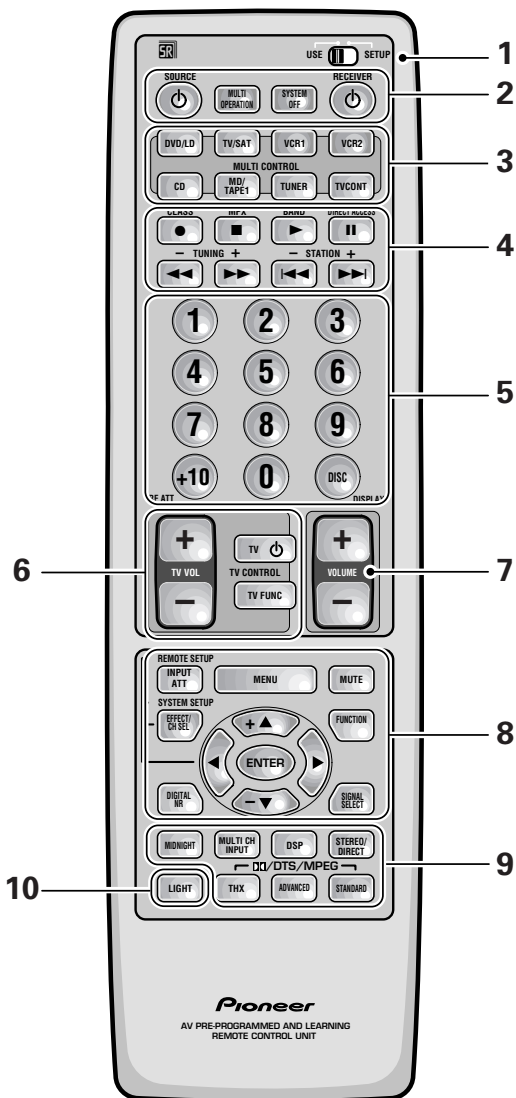

1 USE/SETUP slide switch

Use to put the remote into receiver SETUP, or receiver USE mode.

2 SOURCE button

Use to turn on the power of your other components after you have recalled or taught the signals to this remote control.

MULTI OPERATION button

Use this button to start the MULTI OPERATION mode. See page 78-79 for how to program and use the MULTI OPERATION mode.

SYSTEM OFF button

This button turns off components in two ways. First, when pressed it will turn off all PIONEER components. Secondly, any component that has programmed into the SYSTEM OFF settings will also be turned off (see p.80).

For example : If you programmed power on for your TV and VCR, pressing the SYSTEM OFF button will turn off these components even if they are not PIONEER products.

RECEIVER button

Press to turn power of the receiver on or to STANDBY (off).

3 MULTI CONTROL buttons

Use these to select a source and the corresponding remote operation mode.

For example, pressing TUNER selects the built in tuner and sets the remote operation to the tuner functions.

4 Component Control buttons

Use to control specific components, like a CD player or DVD player, after you have programmed the remote control to do these operations (see pages 65–68) and the remote is put in that operation mode.

5 Number buttons

These buttons can perform a variety of different functions depending on the remote operation mode. They are most useful for CD and tuner operations.

6 TV CONTROL buttons

The following buttons are used to control the TV only and can be used no matter what function the remote control is set to.

TV SOURCE button – Press to turn the power of the TV on/off.

TV FUNC button – Press TV FUNC to select the TV for remote control operation.

TV VOL +/- button – Use to adjust the TV volume.

7 MASTER VOLUME buttons

Use to raise or lower the volume of the receiver.

8 INPUT ATT button (when USE mode is selected)

Use to lower the input level of an analog signal that is too powerful, thus causing the sound to distort (the OVERLOAD indicator will light).

REMOTE SETUP button (when SETUP mode is selected)

Use to customize the remote control functions and the remote control itself. (See "Setting Up the Remote Control to Control Other Components" starting on p.65, "Multi Operation" starting on p.78)

MENU button

Use to get the various menus for your TV or DVD.

MUTE button

Press to mute or restore the volume.

EFFECT/CH SEL,▲(+)/▼(-) (when USE mode is selected) button (see memo on p.45)

EFFECT – Use these buttons to increase or decrease the amount of effect applied in a DSP or Advanced Theater mode. When the amount of effect is increased in a DSP/Advanced Theater mode the characteristics of that mode become stronger and more noticeable. The scale ranges from 10-90 with 70 as the default setting. First turn on the DSP/Advanced Theater you want (by pressing the DSP/Advanced Theater button until you get the mode) and then increase or decrease the amount of effect.

CH SEL – You may want to adjust the channels when listening to some sound sources. Use this button to select the channel you want to adjust.

SYSTEM SET UP button (when SETUP mode is selected)

Use to set up the speaker and sound systems. For more information see "Setting up for Surround Sound" starting on p.30.

FUNCTION button

Press to select a source. The button will cycle through all the possible sources.

▲(+)/▼(-)/◀/▶/ENTER buttons

Use to operate the on-screen menu on your TV screen and enter commands when setting up surround sound, speakers levels & settings, and other set up features see p.29–41). Specific use of these buttons is described in conjunction with the operations they perform. For more information see each individual section.

DIGITAL NR button

Press to switch Digital NR on or off. (See page 49)

SIGNAL SELECT button

Press SIGNAL SELECT repeatedly to select one of the following:

ANALOG – Analog signal.

DIGITAL – Digital signal (DVD/LD, TV/SAT, CD, MD/TAPE 1/CD-R, VCR 1/DVR, VCR 2, LINE).

AC-3 RF –  RF signal (DVD/LD, TV/SAT, VCR 1, VCR 2).

AUTO – This is the default. If there are both analog, digital,  RF input signals, the receiver automatically selects the best possible signal.

9 STEREO/DIRECT button (See p.44 & 53)

Switches the receiver into STEREO mode if it was in a different sound mode (like ADVANCED THEATER) or toggles between DIRECT and STEREO mode. For more on STEREO mode see p.53.

DIRECT playback bypasses the tone controls and channel level for the most accurate reproduction of a program source.

DSP button (See p.42-46, 48)

Press repeatedly to select a DSP sound mode.

 /DTS/MPEG buttons (See p.42-46)

Press these buttons to put the receiver in the selected sound mode. For more information on the sound modes see p.85&86.

MULTI CH INPUT button

Press to switch to MULTI CH IN mode.

MIDNIGHT button (See p.50)

Switches the MIDNIGHT mode on or off.

10 LIGHT button

Press to light the remote control buttons.

Front Panel

All the controls on the front panel are explained and/or referenced here. To open the front panel push gently on the lower third of the panel.

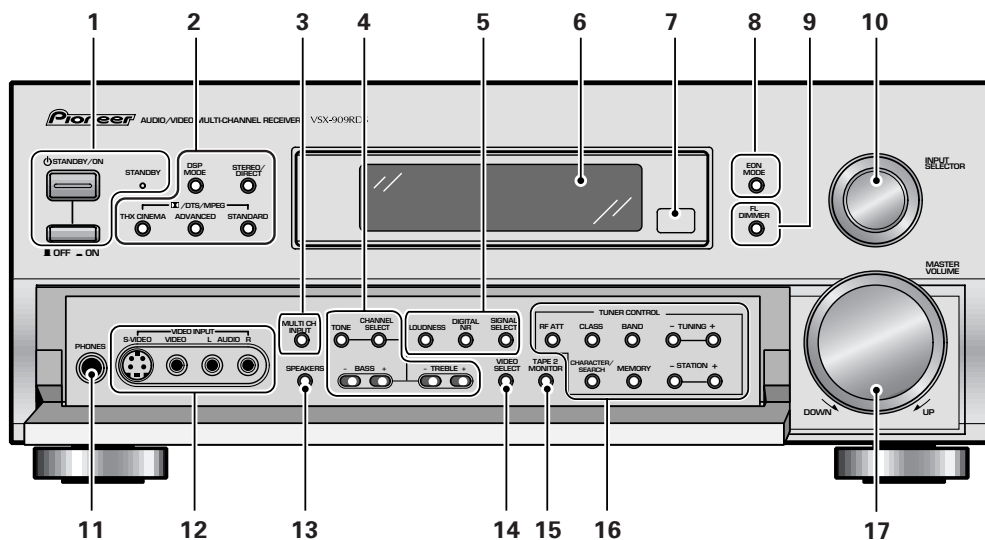

1 **STANDBY/ON button**

Press to switch the receiver ON or into STANDBY mode.

STANDBY indicator

Lights when the receiver is in STANDBY mode. (Please note that this receiver consumes a small amount of power [1.0 W] in the standby mode.)

ON/OFF button

If the button is OFF (■), the power of the receiver is shut off and the STANDBY/ON button on the receiver or the remote control do not function. Pressing the button again will turn the receiver ON (☐) and the receiver enters the standby mode. In the standby mode, you can turn on the receiver using the STANDBY/ON button on the receiver or the remote control.

2 **DSP MODE button (See p.44 & 45)**

Press repeatedly to select a DSP sound mode. (HALL 1, HALL 2, JAZZ, DANCE, THEATER 1, or THEATER 2, 5/7 CH STEREO). Use these modes to produce surround sound from standard (two channel) stereo sources and create different listening environments.

STEREO/DIRECT button (See p.44 & 53)

Switches the receiver into STEREO mode if it was in a different sound mode (like ADVANCED THEATER) or toggles between DIRECT and STEREO mode. For more on STEREO mode see p.44.

DIRECT playback bypasses the tone controls, DIGITAL NR, LOUDNESS, MIDNIGHT and channel level for the most accurate reproduction of a program source.

THX CINEMA – Cycles through the THX CINEMA, THX SURROUND EX or THX AUTO sound modes. If you have THX-certified speaker setup or want to re-create a THX-style sound environment. It is also appropriate for Dolby Digital, Dolby Pro Logic, DTS or MPEG sources. Those with surround back speakers can use all three THX modes, those without can only use the THX CINEMA mode.

ADVANCED – Use to select one of the four Advanced Theater modes. Use to create certain types of sound environments when listening to Dolby Digital, Dolby Pro Logic, DTS or MPEG sources.

STANDARD – Use for pure decoding of multi channel sources, especially Dolby Digital, Dolby Pro Logic, DTS or MPEG sources. Each press toggles between STANDARD and STANDARD 7.1 mode (for use with SURROUND BACK speakers) and STANDARD auto (the receiver chooses the appropriate STANDARD mode). Those with surround back speakers can use all three STANDARD modes, those without can only use the STANDARD mode.

STANDARD – Use for pure decoding of multi channel sources, especially Dolby Digital, Dolby Pro Logic, DTS or MPEG sources. Each press toggles between STANDARD and STANDARD 7.1 mode (for use with SURROUND BACK speakers) and STANDARD auto (the receiver chooses the appropriate STANDARD mode). Those with surround back speakers can use all three STANDARD modes, those without can only use the STANDARD mode.

3 MULTI CH INPUT (See p.41, 52)
Use to hook up an external component that can decode other types of signals and input them into the VSX-909RDS/909RDS-G.

4 TONE buttons
This button has two functions. Firstly, it switches between TONE ON and TONE BYPASS, which bypasses the tone circuitry. Secondly, you need to press the button before using the CHANNEL SELECT buttons to adjust the BASS & TREBLE (cannot be used in THX or MULTI CH IN modes).

CHANNEL SELECT button
Switches the tone adjust controls between the FRONT, CENTER, SURROUND and SURROUND BACK speakers. You can then use the BASS and TREBLE controls to adjust the sound.

BASS (-/+) buttons (See p.51)
Use to adjust low frequencies.

TREBLE (-/+) buttons (See p.51)
Use to adjust the high frequencies.

5 LOUDNESS button (See p.50)
Switches the LOUDNESS mode on or off (can not be used in THX and MULTI CH IN).



DIGITAL NR button (See p.49)
Switches the DIGITAL NR on or off (cannot be used in THX or MULTI CH IN mode).

SIGNAL SELECT button (See p.48)
Use to select the type of signal being input into the receiver. Press SIGNAL SELECT repeatedly to select one of the following:

ANALOG – To select an analog signal.

DIGITAL – To select a optical or coaxial digital signal.

AC-3 RF – To select an  RF signal.

AUTO – This is the default. If there are analog, digital and  RF signals input, the receiver automatically selects the  RF signal. If there are analog and digital signals input the digital will be selected.

6 Display (See page 22)

7 Remote sensor
Point the remote control toward the remote sensor to operate the receiver.

8 EON MODE button/indicator
Press to select the EON mode in the FM mode (see "Setting EON" on page 64). The indicator lights when the EON mode is selected.

9 FL DIMMER button (See p.53)
Use to adjust the brightness of the main display.

10 INPUT SELECTOR dial
Turn to select a source component.
DVD/LD – DVD player or Laser Disc player.
TV/SAT – TV or satellite tuner.
CD – Compact Disc player.
MD/TAPE1/CD-R – Tape deck, Mini Disc recorder or CD recorder connected to MD/TAPE 1/CD-R inputs/outputs.
TUNER – The built-in tuner.

PHONO – Turntable.

VIDEO – Video camera (etc.) connected to the VIDEO INPUT on the front panel.

VCR1/DVR – Video cassette recorder connected to VCR1/DVR inputs.

VCR 2 – Video cassette recorder or other component connected to VCR 2 inputs.

11 PHONES jack
Connect headphones for private listening (no sound will be heard through the speakers).

12 VIDEO INPUT jacks (See p.15)
S-VIDEO: Video input for connecting a video camera (etc.), that has an S-Video out.

VIDEO / AUDIO (L/R): Video input for connecting a video camera, etc. that has standard video/audio outputs.

13 SPEAKERS (A/B) button
Use to select the speaker system. A is the primary setting. It plays all speakers hooked up to the A system. A & B setting only plays the front speakers of both the A & B systems and the subwoofer. Multi channel sources will be down-mixed to these speakers so no sound will be lost. B setting only plays the front speakers connected to the B system and multi channel sources will be down-mixed to these two speakers. The button cycles through the speaker systems as follows: A⇒B⇒A&B⇒off.

14 VIDEO SELECT button
Switches the receiver between the various types of video input.

15 TAPE 2 MONITOR button (See p.76)
Selects the tape deck (MD recorder, etc.) connected to the TAPE 2 MONITOR inputs/outputs. Allows monitoring of a recording as it's being made.

16 TUNER CONTROL buttons (See p.55-63)

CLASS button – Press repeatedly to switch the preset station classes.

RF ATT button – Press to turn the RF attenuator on when receiving strong FM signals (nearby stations) to reduce sound distortion. Normally, set the RF attenuator to off. This button does not affect AM reception.

BAND button – Press to select the AM or FM band.

TUNING $-/+$ button – Use to manually tune to radio stations.

CHARACTER/ SEARCH button – Press to select the character input mode, or initiate an RDS PTY search (see "Memorizing a broadcast station name" on p.59 and "Searching for a program by program type (PTY)" on p.63).

MEMORY button – Press to start the memorization of a preset station.

STATION $-/+$ button – Use to choose programmed radio stations.

17 MASTER VOLUME

Adjusts the overall receiver volume.

Initial Set Up

On Screen Display

There are a number of possible ways to hook up the receiver to your video components, like a DVD player, and hook up to your receiver to your TV, but some of them will not allow you to use the on-screen display of this unit. To avoid this, you simply need to keep the following rules:

- ① Always use the same type of video cords to hook up your video components to the receiver as you use to hook up the receiver to your TV. For example, if you use composite video cords to hook up your DVD player to the receiver, use composite video cords to hook up the receiver to your TV. If you use S video cords to hook up your DVD player and the receiver, use S video cords to hook up the receiver to your TV.
- ② Always make sure your TV is set to the appropriate input channel (for example, video 1). Your TV may have a number of input channels and if you do not select the proper one, you will not be able to use this receiver's on-screen display, or, in fact see any picture from this receiver at all. If you are unsure how to choose an input channel for your TV, refer to the manual which came with your TV.

You might, for example, use both composite and S video cords to hook up your video components with this receiver and then use composite video cords to hook up this receiver to your TV. This arrangement would still NOT let you see the on-screen displays from this receiver on your TV. The best idea is just to use one type of video cords for all your video component and TV hook ups.

Switching video system between PAL and NTSC

This receiver is able to use two types of video systems for its OSD (on screen display) and you need to set the receiver to the type of video system you have, either PAL or NTSC. If you do not match the system on the receiver with your home system no OSD will appear on your TV. People with multi-system TVs do not need to worry about changing the setting. If necessary, follow the instructions below to switch the type of video system.

SET
UP

⏻ STANDBY/ON

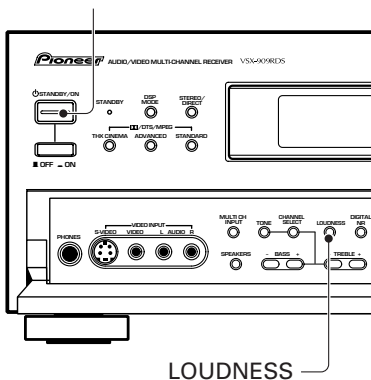

1 Put the receiver in the STANDBY mode.

2 While holding down the LOUDNESS button, press the ⏻ STANDBY/ON button.

The video system type will change depending on the state the receiver was previously in. The new type, either PAL or NTSC, will appear in the display. It will be shown for about seven seconds and then the receiver returns to normal operating mode.

To change the video system type again repeat steps 1 and 2.

Make sure you press the LOUDNESS button, using others buttons may change this receiver's settings.



When a PAL system is selected

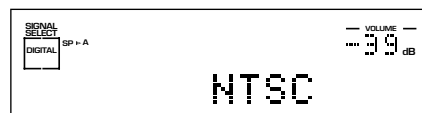

When a NTSC system is selected



When using the PAL setting the OSD does not get displayed in color.

Setting Up for Surround Sound

To ensure the best possible surround sound, be sure to complete the following setup operations. You only need to make these settings once (unless you change the placement of your current speaker system or add new speakers, etc.).

This receiver uses on-screen displays to make setting up your home cinema system easier. Switch on the receiver and your TV, and make sure that the receiver is selected as your TV's video input.

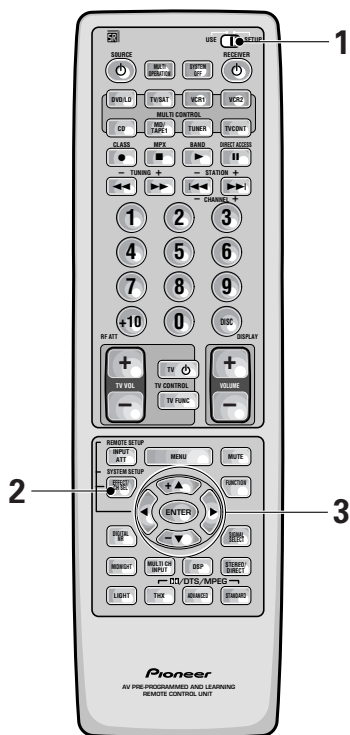

1 Set the slide switch to **SETUP**.

Also make sure your TV is on and set to the receiver.

- **When you're done setting up the receiver, remember to set the slide switch back to USE.**

2 Press the **SYSTEM SETUP** button.

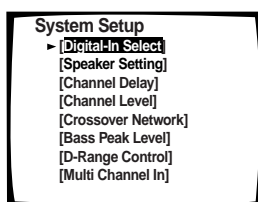

This display appears on the receiver.

- You can escape from this screen at any time by pressing the SYSTEM SETUP button again. None of the settings you made will be entered in this case.
- If you don't enter any settings the receiver will revert back to its previous state after three minutes.

3 Press the **▲** or **▼** arrow buttons to move the hand to the mode you want. Then press the **ENTER** button.

In each mode, the current settings are displayed automatically. We suggest you adjust all these settings when you first hook up the receiver. That gets them out of the way and you won't need to return to this setting mode unless you change your home set up by adding new speakers (etc.). The sound set up modes explained here are:

Digital In Select (See p.32)

In order to use your digital components you must match the numbered digital input settings with the numbered digital jacks used by your digital components.

Speaker Setting (See p.33-34)

Use to specify the type and number of speakers you connected.

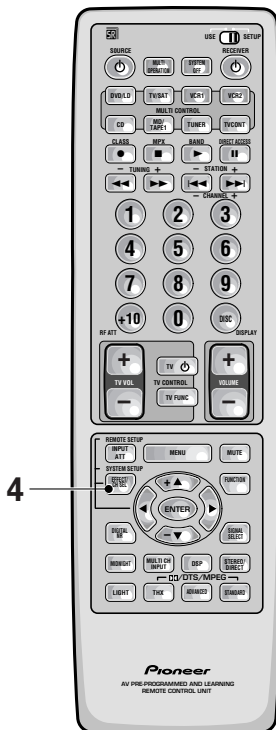

Channel Delay (See p.35)

Set up all your speakers for the most realistic surround sound. Adding a slight delay to some speakers enhances sound separation and is particularly important for achieving a surround sound effect. You need to figure out the distance from your listening position to your speakers to add the proper delay.

Channel Level (See p.36-37)

Use to balance the volumes of your different speakers.

Crossover Network (See p.38)

This feature lets you select which bass frequencies will be sent to the subwoofer or front speakers.

Bass Peak Level (See p.39)

Dolby Digital, DTS and MPEG audio sources include ultra-low bass tones. Set the bass peak level as needed to prevent the ultra-low bass tones from distorting the sound from the speakers.

Dynamic Range Control (See p.40)

This feature makes possible excellent surround sound effects when listening to Dolby Digital sources at low volumes.

Multi Channel In Setting (See p.41)

This feature lets you hook up a multi channel external decoder that may give a higher quality when decoding discs.

4 Go on to the next page to continue set up.

If you don't want to make any settings go can exit this setup. To exit the SYSTEM SETUP MENU and on-screen display press SYSTEM SETUP button again.



After you complete one of the SYSTEM SETUP menus and return to the basic SYSTEM SETUP screen the receiver automatically moves the cursor to the next SYSTEM SETUP menu. For example, if you've completed SPEAKER SETTINGS and returned to the basic SYSTEM SETUP screen, CHANNEL DELAY will be selected automatically. You can notice this on your TV screen.

Initial Set Up

Digital-In Select

In order to be able to use your digital equipment properly you need to assign digital inputs for each of the digital components you connected. Match the Digital 1-5 settings with the digital jacks 1-5 in accordance with what is connected to each digital jack. Check the digital jack numbers on the back of the receiver to make certain what component is in which jack (if necessary, see page 13 for more on digital connections). The last setting, the AC-3 RF setting, is specifically for a DVD/LD player or LD player with an **RF** output. If you connected one of these components match this button to the component. If continuing from the last page go to step 1. If starting fresh, complete steps 1-3 in "Setting Up for Surround Sound" (p.30) first.



1 DIGITAL IN SELECT should be selected (if it isn't use the ▲/▼ buttons to select it).

See "Setting Up for Surround Sound" on page 30 if you need more information.

Press the ENTER button.

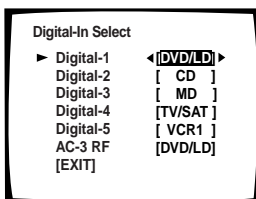

2 Choose a DIGITAL IN and assign it an input function.

Use ◀ or ▶ to choose the input function that matches the component hooked up to that digital terminal.

The possible choices include: DVD/LD, TV/SAT, CD, MD/TAPE1/CD-R, VCR 1/DVR, VCR 2. You cannot assign digital inputs to the TUNER, VIDEO, PHONO, and TAPE 2 MONITOR functions.

If you assign a function (for example DVD/LD) that was previously assigned to a different Digital In the second Digital In will automatically revert to an OFF setting. This is because one function cannot be assigned twice.

3 Select EXIT and press ENTER button to return to the SYSTEM SETUP MENU.

If you want to change a setting before proceeding simply use the arrow buttons to go back.

- For the Digital 1-5 setting you can choose between DVD/LD, CD, TV/SAT, MD/TAPE 1/CD-R, VCR 1/DVR and VCR 2 functions.
- For the AC-3 RF setting you can choose between DVD/LD, TV/SAT, VCR 1/DVR and VCR 2 functions.

Remember, if you have a DVD/LD player or LD player you should hook it up to the analog and digital jacks in addition to the **RF** connection described here.

Speaker Setting

The following steps show you how to specify the type of speakers you connected. Use the ▲/▼ and ◀/▶ buttons to make a selection from the on-screen menus, and use the ENTER button to register the information. If continuing from the previous page go to step 1. If starting fresh, complete steps 1-3 on p.30 first.



1 Select SPEAKER SETTING (if continuing from last set up, it will already be selected) with the ▲/▼ buttons then press the ENTER button.

See "Setting Up for Surround Sound" on page 30 if you are unsure how to do this.

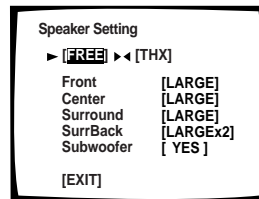

2 Select a speaker setting mode with the ◀/▶ buttons then press the ▼ button.

To specify each speaker individually select FREE.

If you connected a complete set of THX speakers select THX and skip the SURROUND BACK part of step 3.

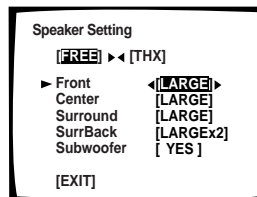

3 Specify the type of speakers you connected. See the explanations below for the meaning of each size.

- ① Press ◀ or ▶ to move the hand to LARGE (or LARGE X2), SMALL (or SMALL X2), or NO (you can't select NO for the FRONT speakers). For the subwoofer you can select YES, NO, or PLUS. See below for a detailed explanation of every speaker choice.
- ② Press ▼.
- ③ Repeat ① and ② for each speaker.

Depending on your choices the sound will be routed differently, as explained here.

FRONT (default setting is LARGE)

- Select SMALL to send bass frequencies to the subwoofer.
- Select LARGE if your speakers will reproduce bass frequencies effectively or if you did not connect a subwoofer.

(If you select SMALL for the front speakers the subwoofer will automatically be set to YES. Also, the center, surround and surround back speakers cannot be set to LARGE if the front speakers are set to SMALL. In this case, all bass frequencies are sent to the subwoofer.)

Initial Set Up



If you have a subwoofer and like lots of bass, it may seem logical to select LARGE for your FRONT speakers and leave the subwoofer selected. This may not, however, yield the best bass results. Depending on the size and shape of your room you may actually experience a decrease in the amount of bass due to what is called "low frequency cancellations." If you have a subwoofer, listen to the bass response with the FRONT speakers set to LARGE and SMALL alternatively and let your ears judge which sounds best.

If you have a subwoofer, the safest option is to route all the bass sounds to it by selecting SMALL for the FRONT speakers.

CENTER (default setting is LARGE)

- Select LARGE if your speaker will reproduce bass frequencies effectively.
- Select SMALL to send bass frequencies to the other speakers or the subwoofer.
- If you did not connect a center speaker, select NO. In this case, the center channel is output from the front speakers.

SURROUND (default setting is LARGE)

- Select LARGE if your speakers will reproduce bass frequencies effectively.
- Select SMALL to send bass frequencies to the other speakers or subwoofer.
- If you did not connect surround speakers select NO. In this case, the sound of the surround channels is output from the front and center speakers.
- If the SURROUND speakers are set to SMALL, the SURROUND BACK speakers will automatically be set to SMALL.

SUBWOOFER (default setting is YES)

- Select YES if you connected a subwoofer.
- If you did not connect a subwoofer select NO. In this case, the bass frequencies are output from the front or surround speakers.
- Choose the PLUS setting if you want stronger reproduction of deep bass sounds.
- If you select PLUS the bass frequencies that would normally come out the front and center speakers are all routed to the subwoofer.
- If you selected SMALL for the FRONT speakers the subwoofer will automatically be set to yes (you won't be able to choose no or PLUS).

SURROUND BACK (default setting is LARGE X2)

NOTE: In order to use SURROUND BACK speakers you need to hook them up through an external amplifier (see p. 19 & 21) for more on this.

- Select the number and size of SURROUND BACK speakers you have. You can choose one speaker, two or none.
- If the FRONT speakers or the SURROUND speakers are set to SMALL, the SURROUND BACK speakers will automatically be set to SMALL.
- If you chose THX in step 2 then the SURROUND BACK speakers can only be set to SMALL (or NO).
- Select LARGE if your speakers will reproduce bass frequencies effectively.
- Select SMALL to send bass frequencies to the other speakers or subwoofer.
- If you did not connect surround back speakers select NO.

4 Select EXIT with the ▲/▼ buttons and press ENTER button to return to the SYSTEM SETUP MENU.

Next, proceed to CHANNEL DELAY on the next page.

Channel Delay

Adding a slight delay to some speakers is necessary to achieve a surround sound effect. You need to figure out the distance from your listening position to your speakers to add the proper delay. The following steps show you how to set the delay time for each channel by specifying the distances from your listening position to each speaker. Once you specify the speaker distances, the receiver calculates the correct delay times automatically. If continuing from Speaker Setting go to step 1. If starting fresh, complete steps 1-3 in "Setting Up for Surround Sound" (p.30) first.



1-3

1 Select CHANNEL DELAY (if continuing from last set up, it will already be selected).

See "Setting Up for Surround Sound" on page 30 if you are unsure how to do this.

Press the ENTER button.

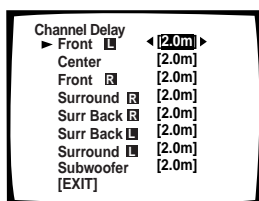

- The default setting is 2.0 m.

2 Use the ▲/▼ buttons to select a speaker. Specify the distance from your listening position to each speaker using the commands below.

- ① Press ◀ or ▶ to adjust the speaker distance in 10 centimeter increments from 0.1 to 9 meters.

The default setting is 2 meter.

- ② Use the ▲/▼ buttons to move to the next set of speakers.
 - ③ Repeat for each speaker.
- Sound takes about 1 millisecond to travel 30 centimeter.

3 Select EXIT with the ▲/▼ buttons and press ENTER button to return to the SYSTEM SETUP MENU.

Next, proceed to CHANNEL LEVEL on the next page.

If you want to change a setting before proceeding simply use the arrow buttons to go back.

Initial Set Up

Channel Level

The following steps show you how to balance the sound output level of your speakers. Proper speaker balance is essential for obtaining high quality surround sound. If continuing from Channel Delay go to step 1. If starting fresh, complete steps 1-3 in "Setting Up for Surround Sound" (p.30) first.



1 Select CHANNEL LEVEL (if continuing from CHANNEL DELAY, it will already be selected).

See "Setting Up for Surround Sound" on page 30 if you are unsure how to do this.

Press the ENTER button.

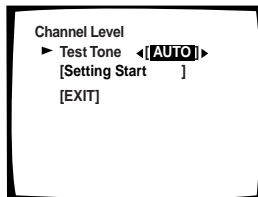

NOTE : Be prepared! The test tone is output at a high volume level.

2 Select a TEST TONE mode.

- 1 Press ◀ or ▶ to move the hand to AUTO or MANUAL.
- 2 Press ▼ button to select SETTING START.

AUTO (automatic TEST TONE)

This mode switches the test tone between each speaker automatically. Use this mode when balancing the speaker levels by ear.

The automatic test tone is output in the following order:

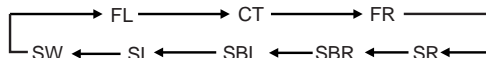

MANUAL (manual TEST TONE)

This mode lets you switch the test tone between each speaker manually. You can use this mode when you want to balance the speaker levels by ear at a more leisurely pace.

3 After selecting SETTING START with the ▼ button press ENTER button. Test tone will be output.

These settings will be displayed on your TV.

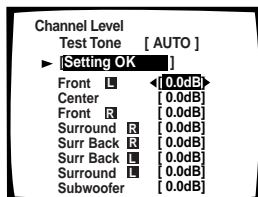

It takes a moment for the machine to set itself. MASTER VOLUME rotates to the reference position (0dB), and the test tone is output.

To exit before outputting the TEST TONE

Press the ENTER button.

To exit while outputting the TEST TONE

Press the SYSTEM SETUP button.

Download from [Www.Somanuals.com](http://www.Somanuals.com). All Manuals Search And Download.



A test tone will be output from the SURROUND BACK speakers but your external amplifier must be turned up at least a little in order to hear it. Be careful that it is not turned up too much because the test tone volume is quite loud.



4-6



Note that it is also possible to set channel levels temporarily. Then follow the same procedure as explained on this page. This function is designed to be used when you want to change the levels temporarily to raise the level of one channel. Using this method you can set speaker levels in different modes, such as, STEREO, and each DSP mode, independently. You should return the settings to their original state when done. Doing the set up procedures on this page will erase any temporary/independent level settings that have been made.

4 Adjust speaker levels so that you hear the test tone at the same volume from each speaker when seated in your main listening position.

Note: The volume of the subwoofer tends to sound lower than it actually is, you may need to raise its level after testing the sound with actual soundtracks.

In AUTO mode

- ① Press the ◀ or ▶ button to adjust the level of the speaker outputting the TEST TONE.

In MANUAL mode

- ① Press the ◀ or ▶ button to adjust the level of the first speaker.
- ② Press the ▲/▼ button to switch the TEST TONE to the next speaker.
- ③ Repeat ① and ② for each speaker.

If you are using a Sound Pressure Level (SPL) meter

Take the readings from your main listening position and adjust the level of each speaker to 75 dB SPL (C-weighted/slow mode).

5 When you have adjusted each speaker level, press ENTER button to return to the previous screen.

The MASTER VOLUME will return to its original position.

6 Select EXIT with the ▲/▼ buttons and press ENTER button to return to the SYSTEM SETUP MENU.

Next, proceed to CROSSOVER NETWORK on the next page.

If you want to change a setting before proceeding simply use the arrow buttons to go back.

Initial Set Up

Crossover Network

The following steps show you how to adjust the crossover network. The crossover network is the frequency at which the system divides the signal and sends the different parts to different speakers. Speaking precisely, this setting sets the cutoff point for the bass frequencies rerouted from your SMALL speakers to your subwoofer or speaker set to LARGE.

If continuing from Channel Level go to step 1. If starting fresh, complete steps 1-3 in "Setting Up for Surround Sound" (p.30) first.



1 Select CROSSOVER NETWORK (if continuing from CHANNEL LEVEL, it will already be selected).

See "Setting Up for Surround Sound" on page 30 if you are unsure how to do this.

Press the ENTER button.

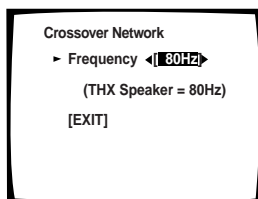

- The default setting is 80 Hz.

2 Specify the crossover frequency for your small speakers.

Setting speakers to SMALL in "SPEAKER SETTING" sends the respective channel's bass frequencies to the subwoofer (or LARGE speakers). The present function lets you determine which frequencies will be sent to the subwoofer or LARGE speakers.

- ① Use the ◀ or ▶ button to select 80 Hz, 100 Hz, or 150 Hz.
- ② Press the ▼ button.

80Hz

Sends bass frequencies below 80 Hz to the subwoofer (or LARGE speakers).

100 Hz

Sends bass frequencies below 100 Hz to the subwoofer (or LARGE speakers).

150 Hz

Sends bass frequencies below 150 Hz to the subwoofer (or LARGE speakers).

Experiment with the different settings to see which sounds best to you.

3 Select EXIT to return to the SYSTEM SETUP MENU.

Next, proceed to BASS PEAK LEVEL on the next page.

If you want to change a setting before proceeding select a new crossover frequency.

Bass Peak Level

The LFE (Low Frequency Effect) channel in Dolby Digital, DTS or MPEG program sources can produce heavy ultra-low bass tones that may exceed the capabilities of your speaker system. The following steps show you how to set a maximum output level for the LFE channel. If continuing from Crossover Network go to step 1. If starting fresh, complete steps 1-3 in "Setting Up for Surround Sound" (p.30) first.



1-3

1 Select BASS PEAK LEVEL (if continuing from CROSSOVER NETWORK it will already be selected).

See "Setting Up for Surround Sound" on page 30 if you are unsure how to do this.

Press the ENTER button.

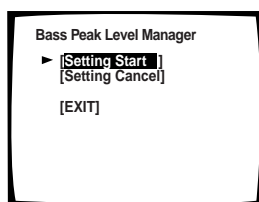

2 Output the test tone for the LFE channel and specify the peak level.

- ① If your subwoofer has a volume control, set it to the middle position before proceeding.
- ② Select SETTING START.
- ③ Press the ENTER button.

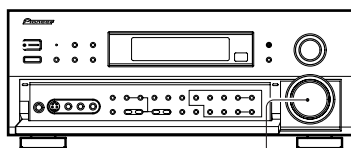
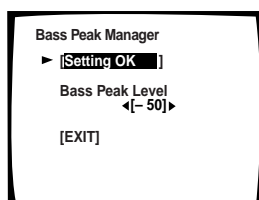

MASTER VOLUME



If you select SETTING CANCEL no settings are input to the receiver but the screen remains on the TV. To escape the screen you must select EXIT and press the ENTER button.

MASTER VOLUME rotates to MIN (—dB). Then the test tone is output to the subwoofer or front or surround speakers.

- ④ Use the 2 or 3 button arrows to gradually increase the level of the LFE channel until the test tone begins to distort. Then go back and leave the level setting at a point just before that. Press the ENTER button and the receiver will remember this bass output level.

To exit before outputting the TEST TONE select EXIT and press the ENTER button.

To exit while outputting the TEST TONE press the ENTER button.

3 Select EXIT and press the ENTER button to return to the SYSTEM SETUP MENU.

This completes the speaker setup.

Initial Set Up

Dynamic Range Control

This feature makes it possible to enjoy full surround sound effects on Dolby Digital sources even at low volumes. It does this by compressing the dynamic range. Dynamic range is the difference between the loudest and the softest sounds in any given signal. Compressing the range plays sounds so the quieter ones are audible and the louder ones don't get distorted or become overpowering. This feature only applies to Dolby Digital sources but the MIDNIGHT LISTENING mode accomplishes the same end for a variety of sources (see page 50). If continuing from Bass Peak Level go to step 1. If starting fresh, complete steps 1-3 in "Setting Up for Surround Sound" (p.30) first.



1 Select DYNAMIC RANGE CONTROL (if continuing from BASS PEAK LEVEL, it will already be selected).

See "Setting Up for Surround Sound" on page 30 if you are unsure how to do this.

Press the ENTER button.

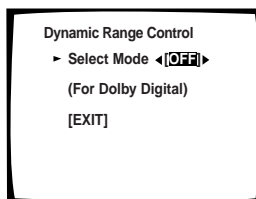

- The default setting is OFF.
- If listening at loud volumes we recommend turning the Dynamic Range Control OFF.

2 Use the ◀ or ▶ arrows to choose OFF, MID or MAX.

3 Select EXIT and press ENTER button to return to the SYSTEM SETUP MENU.

If you want to change a setting before proceeding Choose a new DYNAMIC RANGE CONTROL setting.

You may need to experiment with different Dolby Digital sources before you can use the DYNAMIC RANGE CONTROL setting to suit your low volume listening needs.

Multi Channel In Setting

If you have a Multi Channel external decoder you can choose whether to have the sound level set to BYPASS, in which case only the main volume can be controlled, or to ADJUST, which means the levels can be reduced in volume. If continuing from Dynamic Range Control go to step 1. If starting fresh, complete steps 1-3 in "Setting Up for Surround Sound" (p.30) first.



1 Use the ▲/▼ buttons to select MULTI CHANNEL IN.

See "Setting Up for Surround Sound" on page 30 if you need more information.

Press the ENTER button.

This information will be displayed on your TV.

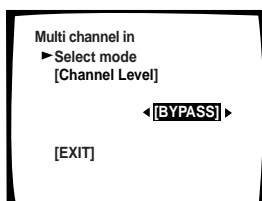

2 Use the ◀/▶ buttons to select the setting you want, BYPASS or ADJUST.

ADJUST: Use the ADJUST setting when you want to be able to control each channel level individually.

BYPASS: This setting is good for getting the cleanest possible signal. In this setting you won't be able to change each channel individually.

We recommend using BYPASS and the default setting is BYPASS.

3 Use the ▲/▼ buttons to select EXIT.

Press the ENTER button.

You will return to the SYSTEM SETUP mode.

Multi Channel In Setting Using the Main Unit

You can also use the main unit to change the sound level of the MULTI CH IN. Follow the step below.

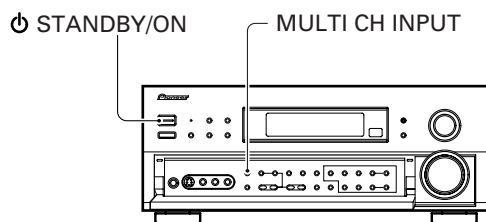

1 Put receiver in the STANDBY mode.

2 While holding down the MULTI CH INPUT button press the STANDBY/ON button.

The setting will change depending on what state the receiver was previously in. For a few seconds the display will show you which MULTI CH setting you are now in.



The default setting is BYPASS.

Basic Playback

Sound Modes

The five sound modes on the receiver are explained here. These can be turned on from the front panel or from the remote control.

There are three cinema modes: STANDARD, HOME THX CINEMA, and ADVANCED THEATER. These are designed to be used with multi channel surround sound audio/visual sources (like DVDs and LDs). Intrinsic to home theater, these modes can deliver realistic and powerful surround sound that recreates the movie theater experience. You may need to experiment with them to see which settings suit your home system and personal tastes.

The DSP and STEREO modes are designed to be used with music sources but some DSP modes are also suited for film soundtracks. Again, try different settings with various soundtracks to see which you like.

You must choose one of the three cinema modes or the DSP mode in order to get surround sound. In STEREO mode only the front two speakers, and sometimes the subwoofer (if you have one), are used.

STANDARD mode

This mode is for pure decoding of Dolby Digital, Dolby Pro Logic, DTS or MPEG sources. No special effects are added. It is good for enjoying regular movies/videos that have been recorded in Dolby Digital, Dolby Pro Logic, DTS or MPEG. STANDARD 7.1 is also the basic mode for enjoying sources with SURROUND BACK channels. For more detailed information see p.85-86. You will only be able to access the second two modes if you have hooked up SURROUND BACK speaker(s). For more detailed information see p.19, 33-34. The display will show you what kind of source (Dolby Digital, DTS, etc.) is being played.

STANDARD

Use this mode with sources that do not have SURROUND BACK channels. If you don't have SURROUND BACK speaker(s) switched on (see p.33-34) this is the only STANDARD mode you will be able to select on the receiver.

STANDARD 7.1

This mode is best for sources with SURROUND BACK channels. You will only be able to access this mode if you have set the SURROUND BACK speakers in the SPEAKER SETUP procedure (see p.33-34). Also, this mode will play 5.1 channels sources and other sources through all the speakers you have hooked up, routing some of the sound into your SURROUND BACK channel or channels. STANDARD 7.1 will appear in the display even if you only have one SURROUND BACK speaker hooked up. The display will change according to the source played.

STANDARD AUTO

In this mode the receiver will automatically select the appropriate STANDARD mode and use it to play the soundtrack. You will only be able to access this mode if you have set the SURROUND BACK speaker(s) in the SPEAKER SETUP procedure (see p.33-34). If the source has a Surround EX marker then the receiver will automatically go into STANDARD 7.1 mode. This mode is best if you are unsure which of the above STANDARD modes to use. The display will change according to the source played.

HOME THX CINEMA mode

THX is a set of technical standards created by Lucasfilm, Ltd. These standards were designed to emulate a film sound stage and thus reproduce, with the greatest possible accuracy, the soundtrack intended by the filmmakers. To get THX sound use one the three modes explained below. You will only be able to access the second two modes if you have hooked up SURROUND BACK speakers. For more detailed information see p.19, 33-34. The display will show you what kind of source (Dolby Digital, DTS, etc.) is being played.

THX CINEMA

Use this mode to get THX sound with sources that do not have SURROUND BACK channels. If you don't have SURROUND BACK speaker(s) switched on (see p.33-34) this is the only THX mode you will be able to select on the receiver.

THX SURROUND EX

This mode is specifically for using your SURROUND BACK channels with either SURROUND EX or 5.1 channel sources. You will only be able to access this mode if you have set the SURROUND BACK speakers in the SPEAKER SETTING procedure (see p.33-34). If the source you are using is a 5.1 source then this mode will route some of the sound to the SURROUND BACK channel(s). If the source does not have a SURROUND EX marker or is not a 5.1 source then the display will automatically change to THX CINEMA.

THX AUTO

In this mode the receiver will automatically select the appropriate THX mode and use it to play the soundtrack. You will only be able to access this mode if you have set the SURROUND BACK speaker(s) in the SPEAKER SETUP procedure (see p.33-34). If the source has a Surround EX marker then the receiver will automatically go into THX SURROUND EX mode. This mode is best if you are unsure which of the above THX modes to use.

ADVANCED THEATER modes

The Advanced Theater mode is a newly designed system for enhancing movie soundtracks and other audio-visual sources. It incorporates the use of DTS as well as Dolby Digital into its sound processing. These functions switch on automatically when the source you are playing is encoded with DTS, Dolby Digital or MPEG. There are four Advanced Theater settings that use DSP (Digital Signal Processing) to create different types of sound environments. If you have SURROUND BACK speakers or (even just one) speaker switched on (see p.33-34) then 7.1 will appear after the name of all of these modes in the display on the receiver. The display will show you what kind of source (Dolby Digital, DTS, etc.) is being played.

MUSICAL

This mode is primarily for music and adds a spacious feeling to the sound. A long delay time of reflected sounds, provides resonant tones which emulate a concert hall.

DRAMA

This mode is designed for movies with a lot of dialog. The elements of dialog are enhanced, making the characters seem more real. The mode also compresses the dynamic range somewhat so loud sounds do not overpower softer ones (compare this with the MIDNIGHT LISTENING mode explained on p.50).

ACTION

This mode is designed for action movies, which generally use lots of sound effects. The mode enriches the sound to make it more realistic and extends the parameters to pick up high and low sound effects.

5/7-D THEATER

This mode is especially designed to give sound depth to stereo sources. The overall effect builds a dynamic and broad sound space, allowing two-channel (stereo) signals to faithfully imitate a five speaker sound. The mode should be used in conjunction with Dolby Pro Logic for sources bearing the

 mark.



When a Dolby Digital soundtrack is played back the Dialog Normalization function of the receiver activates automatically. Dialog Normalization is a Dolby Digital function that establishes the average dialog level for the program source being played. If the receiver's level does not match the average dialog level, first you see "DIAL NORM" flash in the receiver's display and next "OFFSET +4 dB" (as an example) will appear. In this example, the number +4 dB is the difference between the receiver's gain structure and the Dolby Digital average dialog level. To match the average dialog level, subtract or add the OFFSET level. For example, if the OFFSET level is +4 dB, the amplifier's output is 4 dB over the average recorded level.

Basic Playback

DSP modes

The DSP (Digital Signal Processing) modes allow you to transform your living room into a variety of different sonic environments when playing either two-channel or multi-channel sources. If you have SURROUND BACK speaker(s) switched on (see p.33-34) then 7.1 will appear after the name of all of these modes in the display on the receiver.

HALL 1

Simulates the acoustic effects of a large concert hall. Suitable for classical music. A long delay time of reflected sounds, coupled with reverb effects, let the listener enjoy the dynamic and rich sounds characteristic of concert halls and powerful orchestral performances.

HALL 2

Simulates the acoustic environment of a very resonant concert hall. Rich reverberation and a full sound create the impression of a lively performance space.

JAZZ

Simulates the acoustic effects of a jazz club. Reflected sound is virtually below 100 msec so that the listener can enjoy a live band effect.

DANCE

Simulates the acoustic effects of a dance club. Features a strong bass sound. Reflected sound delay time is virtually below 50 msec, for the listener to enjoy the visceral power of dance music.

THEATER 1

Reproduces theater sound field effects without losing the localization of each channel. Theater effects can be enjoyed without losing Dolby Digital/ Pro Logic effects when used in combination those formats (with movies bearing the  DOLBY SURROUND trademark).

THEATER 2

Simulates the acoustic environment of a theater while maintaining proper localization of each channel.

5/7CH STEREO

Simulates the acoustic environment of a regular stereo while using all the speakers in the system to induce a rich, all-around sound. If you have SURROUND BACK speaker(s) switched on (see p.33-34) then the name of this mode will be 7CH SETREO in the display on the receiver. If the SURROUND BACK speakers are switched off, then the mode will appear as 5CH STEREO.

STEREO mode

Use the STEREO mode to enjoy standard (two-channel) stereo sound from the front left and right speakers. This mode is most like the sound reproduction you would get from a regular stereo receiver or amplifier that is not equipped to handle A/V formats as this one is. You might want to use this mode for listening to regular music sources (like CDs) but remember, you will only get sound from your front two speakers (and possibly subwoofer).

Before operating the receiver, be sure to press the **ON/OFF** button on the front panel to turn the power ON ().

Selecting a Sound Mode

To ensure the best possible surround sound, be sure to complete the set up procedures described in "Setting Up for Surround Sound" (starting on page 30) before using the sound modes. This is particularly important when using the **Dolby** (Dolby) Digital/MPEG or DTS sources. When using the sound modes, using SPEAKERS A will give the best results. If you use SPEAKERS B the sound will be down mixed to the two front B speakers and the surround sound effect will be lost.

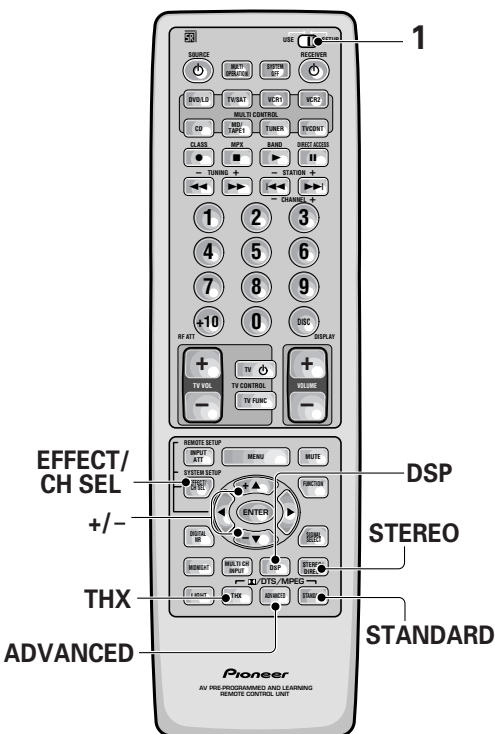

1 Put the remote control slide switch in USE.

2 Select the sound mode.

- For STANDARD → Press STANDARD
Each press changes the STANDARD mode as follows:



- For HOME THX CINEMA → Press THX(THX CINEMA)
Each press changes the THX mode as follows:

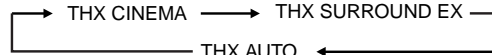

- For ADVANCED THEATER → Press ADVANCED
Each press changes the ADVANCED THEATER mode as follows:

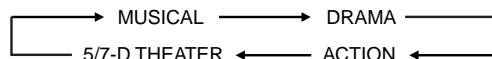

- For DSP modes → Press DSP(DSP MODE) repeatedly
Each press changes the DSP mode as follows:

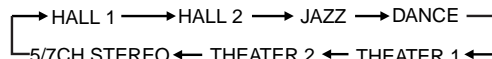

- For STEREO → Press STEREO/DIRECT
Each press changes the STEREO mode as follows:

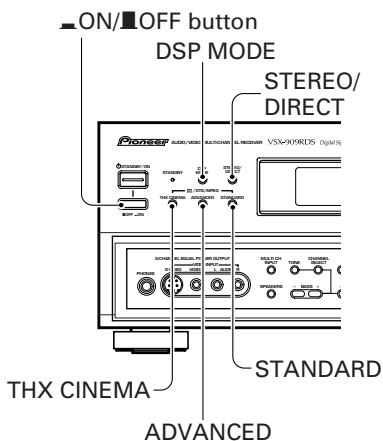
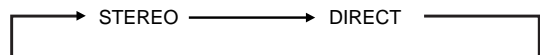

- If you have SURROUND BACK speakers switched on (see p.33-34) then 7-D THEATER and 7CH STEREO will appear as such in the display on the receiver. If these speakers are not switched on the above two modes will appear as 5-D THEATER and 5CH STEREO.
- The effects of ADVANCED THEATER mode can be adjusted in the range of 10 to 90 by pressing EFFECT +/- (The default setting is 70). Also, the effect level can be set in each ADVANCED THEATER mode by pressing the EFFECT(+/-) button.
- The amount of effect of each DSP mode can be adjusted in the range of 10 to 90 (the default setting value is 70) by pressing EFFECT +/-.
- 5/7CH STEREO modes cannot be changed.

Basic Playback

Before operating the receiver, be sure to press the **ON/OFF** button on the front panel to turn the power ON ().

Playing Sources with Dolby Digital, DTS or MPEG

The following instructions show you how to play Dolby Digital, DTS or MPEG sound sources with the VSX-909RDS/909RDS-G.

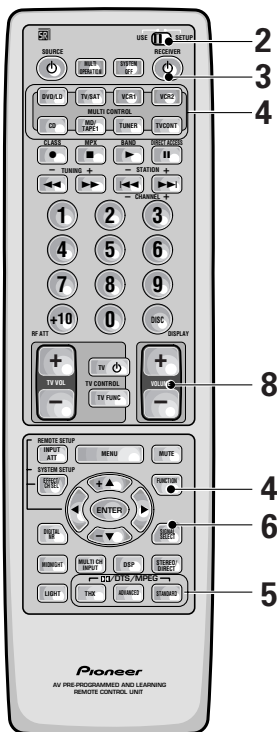

1 Turn on the power of the playback component.

2 Put the remote control slide switch in USE.

3 Press the **RECEIVER button to turn on the receiver.**

Be sure that the standby indicator turns off on the front panel.

4 Press the **MULTI CONTROL buttons or the **FUNCTION** button to select the source you want to playback.**

The **FUNCTION** button cycles through the sources in the following order:

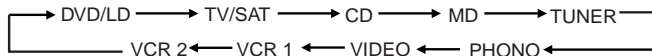

5 Choose a sound mode by pressing **THX, **ADVANCED** or **STANDARD**.**

The default setting is **STEREO**.

(For more see "Sound Modes" and "Selecting a Sound Mode" on pages 42-45.)

6 Press the **SIGNAL SELECT button to select the input signal. Set to **AUTO**.**

(See "Switching Analog and Digital Signal Input" on page 48.)

7 Start playback of the component you selected in step 1.

8 Adjust the volume by using the volume buttons on the remote control or the **MASTER VOLUME on the front panel.**

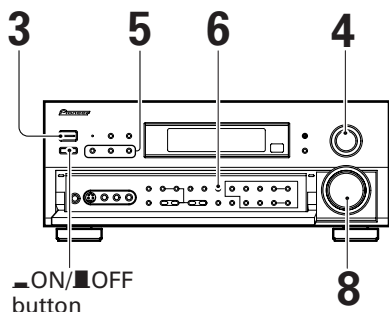

- We recommend using different modes for different types of DTS material. For watching movies, the **STANDARD**, **THX** or **ADVANCED THEATER** setting should provide the best results. For listening to music, the **STANDARD**, **DIRECT**, **STEREO**, or **DSP** modes should serve the listener best.
- Make sure you connect your DVD/LD or LD players using the **RF** jack. If your player has an **RF** output this will ensure you can use all LDs. Refer to p.14.

Before operating the receiver, be sure to press the **ON/OFF** button on the front panel to turn the power ON.

Playing Stereo Sources

The following instructions show you how to use the receiver for stereo audio or audio-visual.



If the TAPE 2 indicator is visible in the display, it means the TAPE 2 MONITOR is on. Press TAPE 2 MONITOR on the front panel to turn it off unless you want to listen to TAPE 2.

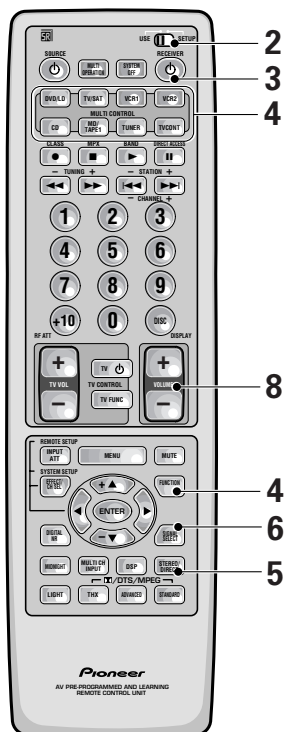

- 1 Turn on the power of the playback component.**
- 2 Put the remote control slide switch in USE.**
- 3 Press the **RECEIVER** button to turn on the receiver.**
Be sure that the standby indicator turns off on the front panel.

- 4 Press the **MULTI CONTROL** buttons or the **FUNCTION** button to select the source you want to playback.**
The FUNCTION button cycles through the sources in the following order:

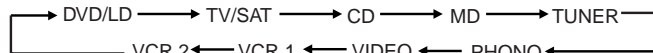

- 5 Press the **STEREO/DIRECT** button to select the stereo mode.**
The STEREO indicator lights on the display.
- 6 Press the **SIGNAL SELECT** button to select the input signal corresponding to the source component.**
(See "Switching Analog and Digital Signal Input" on page 48.)

- 7 Start playback of the component you selected in step 1.**

- 8 Adjust the volume by using the **VOLUME** buttons on the remote control or the **MASTER VOLUME** on the front panel.**

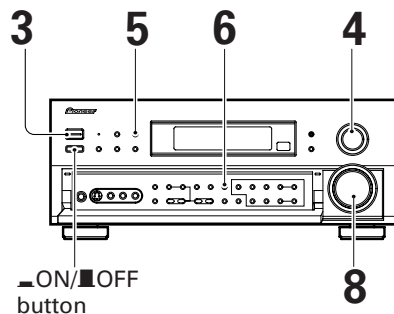

If you are not able to get sound from the receiver the problem may well lie with the SIGNAL SELECT switch. You need to make sure the input is set to the appropriate ANALOG or DIGITAL setting. Refer to page 48 for more on this.

Switching Analog and Digital Signal Input

This switch moves the input fed to the receiver between analog, digital and **RF** sources. You need to take special care to switch to the appropriate input, when necessary. For example, the switch would have to be on DIGITAL to use DOLBY DIGITAL, DTS or MPEG surround sound but it would have to be on ANALOG to record to the analog out jacks on the receiver. The default setting is AUTO (priority is given to a digital signal, if there is one).



1 Put the remote control slide switch in USE.

2 Press the SIGNAL SELECT button to select the input signal corresponding to the source component.

Each press switches the signal in the order below:

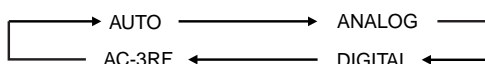

3 When SIGNAL SELECT is set to DIGITAL, AC-3 lights when a Dolby Digital signal is input, and DTS lights when a DTS signal is input.

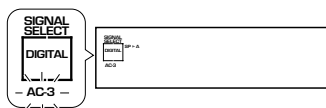

When a Dolby Digital signal is input.

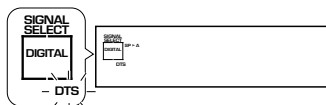

When a DTS signal is input.

memo

- In the AUTO setting, SIGNAL SELECT chooses the signal, based on availability, in the following order: AC-3 RF, DIGITAL, ANALOG.
- If all the Digital In Select (see p.32) choices are set to OFF, the SIGNAL SELECT will default to ANALOG.
- Because the audio from a karaoke microphone and LDs recorded with analog audio only is not output from the digital output, set SIGNAL SELECT to ANALOG to listen to these formats.
- This receiver can only play back Dolby Digital, PCM (32kHz, 44kHz, 48kHz, and 96kHz), and DTS and MPEG digital signal formats. It cannot play back digital signals other than these so for those kinds of formats you'll have to play them back in an analog manner (making sure your equipment is hooked up with analog connections and setting the SIGNAL SELECT to ANALOG).
- When an LD or CD with DTS is played back with the SIGNAL SELECT set in ANALOG, digital noise caused by playing back the DTS directly (with no decoding) is output. To prevent noise, you need to make digital connections (See p.13,14) and set SIGNAL SELECT to AUTO.
- Some DVD players don't output DTS and/or MPEG signals. For more details, refer to the instruction manual supplied with your DVD player.

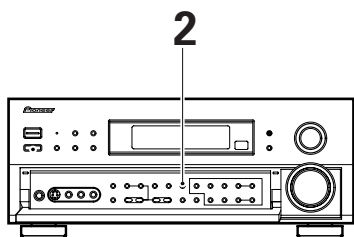

Reducing Noise During Playback

To reduce extraneous noise switch on DIGITAL NR. This noise reduction can be used with every mode except THX and MULTI CH IN.



1 Put the remote control slide switch in USE.

2 Press the DIGITAL NR button on the remote control or on the front panel.

Each press switches DIGITAL NR on or off.



- In cases described below, noises may not be reduced even if DIGITAL NR is on.
 - Sudden noise
 - Extremely loud noise
 - Signals that do not contain many high frequencies
- DIGITAL NR is effective at and above levels shown below for each source.
- STEREO (excluding 96 kHz)
 - analog input..... 10 -18 dB
 - digital input..... 10 -15 dB
 - AM/FM tuner 10 -15 dB
 - DSP/ADVANCED/STANDARD/96 kHz stereo..... 6 -10 dB
- Depending on the condition of the source, there may not be a noticeable improvement in the quality of the sound.

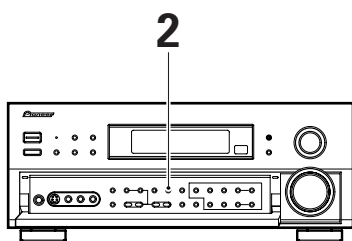

- You can't use the DIGITAL NR mode with the THX or MULTI CH IN modes.
- If you press DIGITAL NR when in DIRECT mode the receiver switches to STEREO mode.

Listening in Midnight Mode

This feature makes it possible to get excellent surround sound effects even when listening at low volumes. It can be used with a variety of surround sound sources and plays soundtracks so that the quieter sounds are audible while the noisier sounds don't become overly loud or distorted. It does this by bringing all the sounds in a given soundtrack closer together in volume. Compare this feature with the D-Range Control (only for Dolby Digital sources) on page 40.

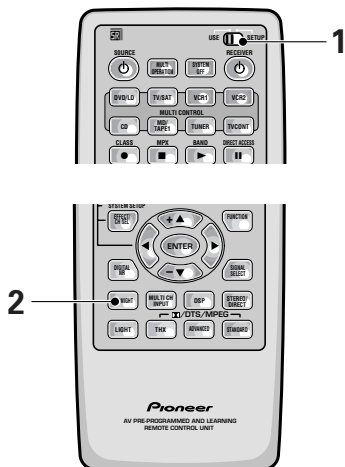

1 Put the remote control slide switch in USE.

2 Press the MIDNIGHT button.

Each press switches MIDNIGHT LISTENING mode on or off.



- The effect adjusts itself automatically in accordance with the volume level.
- You can't use the MIDNIGHT LISTENING mode with the THX or MULTI CH IN modes.
- If you use MIDNIGHT in DIRECT mode the receiver will switch to STEREO mode.

Listening the Loudness Mode

The LOUDNESS mode allows you to boost the bass and treble in a signal. It is useful for listening to music at low volumes.

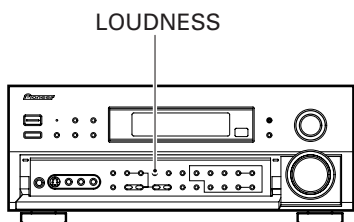

Press the LOUDNESS button.

Each press switches LOUDNESS mode between on and off.



- You can't use the LOUDNESS mode with the MULTI CH IN or THX modes.
- If you press LOUDNESS in DIRECT mode the receiver will switch to STEREO mode.

Adjusting Bass and Treble

You can use BASS +/- or TREBLE +/- buttons to adjust the low and high frequencies for each individual set of speakers. If the receiver is in STEREO mode you can only adjust the FRONT speakers. In a surround mode (STANDARD, ADVANCED THEATER, etc.) you can adjust the FRONT, CENTER, SURROUND and SURROUND BACK speakers. The TONE button can also be used to bypass the tone circuitry (see p.27).

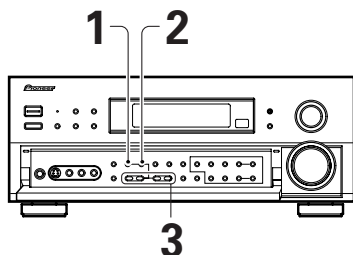

1 Press the TONE button on the front panel to put the receiver in tone on mode.

2 Press the CHANNEL SELECT button on the front panel to cycle through the different tone adjust modes.

The button cycles through the possibilities in the following order:

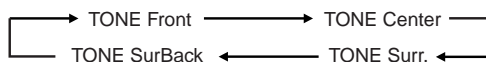

3 Use the BASS or TREBLE (+/-) buttons to adjust the low or high frequencies of each channel.

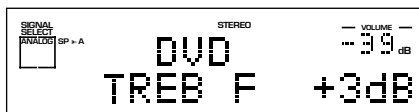

A few seconds after you finish adjusting the tone the receiver will revert to the sound mode it was in at the beginning of the process.



- The tone control can be adjusted in a range of ± 6 dB.
- The tone control cannot be adjusted in THX and MULTI CH IN modes.
- If the receiver is in DIRECT mode and you press the TONE button, TONE BYPASS will appear in the display, letting you know that you can't change the tone in DIRECT mode. Another press cancels DIRECT mode.

MULTI CHANNEL IN Playback

MULTI CH IN allows you to connect an external decoder to enjoy certain types of specialized discs. To use MULTI CH IN playback follow the instructions below.

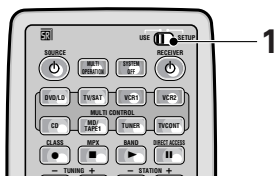

1 Put the remote control slide switch in USE.

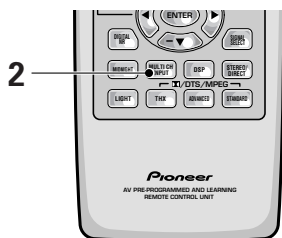

2 Press the MULTI CH INPUT button on the remote control or the front panel.

Each press switches the input between the previous mode and MULTI CH IN.

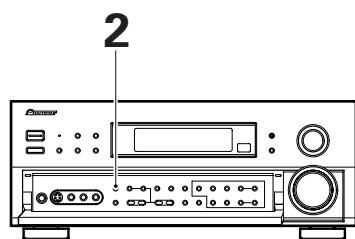

When MULTI CH IN is used in BYPASS mode only the volume level can be set. All of this unit's other features (DIGITAL NR etc.) cannot be used. Also, all speaker settings and other setup settings have no effect.

96kHz 24bit Performance

This receiver is capable of playing back advanced DVD discs which are recorded in 96 kHz/24 bit format (these are all stereo discs) and any source recorded in 96 kHz and up to 24 bit. The receiver will automatically read the format of the source and play accordingly (of course the SIGNAL SELECT will have to set to AUTO or DIGITAL to read the DVD soundtrack). When the receiver plays a 96 kHz disc "96 kHz" and whatever mode you're using (for example "STEREO," "DIRECT or "DNR") will appear in the display.

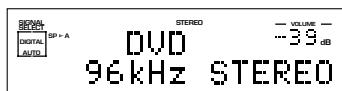

- When a 96 kHz/24 bit disc is played back the volume may be louder than that of a normal disc.
- Some DVD players cannot play 96 kHz/24 bit discs. Check the manual of your DVD player to make sure.
- During this playback the player enters the STEREO mode and you can use the controls available in STEREO mode (LOUDNESS, MIDNIGHT, TONE controls, etc., see p.50-51).
- With 96 kHz/24 bit discs you are able to use MULTI CH IN playback and the TAPE 2 MONITOR.
- In 96 kHz/24 bit mode you can't use the STANDARD, ADVANCED THEATER, THX, or DSP modes.

Direct Playback

This mode is for playing back a sound source in its purest form, no tone adjustments or other sound modes can be used.

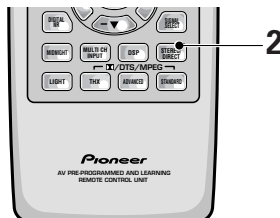

- 1 Put the remote control slide switch in USE.**
- 2 Use the STEREO/DIRECT button to alternate between STEREO or DIRECT mode (you can also use the STEREO/DIRECT button on the front panel).**

The DIRECT mode will give you the most accurate reproduction of two channel (stereo) sources but won't let you add any effects to the sound.



- None of the tone controls or other sound modes can be used with DIRECT playback.
- If the receiver is in a different mode than STEREO to start with the first push of the STEREO button will put it in STEREO mode. After that the button will toggle the receiver between STEREO and DIRECT mode.
- For more on this button see the explanation of STEREO mode on p.44, 45, 47.

STEREO/
DIRECT

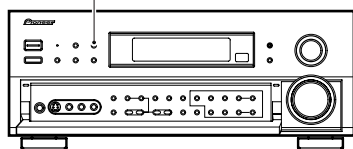

Adjusting the Brightness of the Display

Use the FL DIMMER button to adjust the brightness of the fluorescent display (FL=fluorescent display).

Press the FL DIMMER button.

Four levels of brightness ranging from very dim to very bright can be selected. Each press changes the brightness of the display. When rotating through the options, the default brightness can also be selected.

FL DIMMER

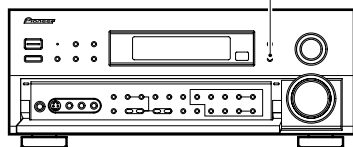

Please note: it is a feature of this unit that the fluorescent display will be brighter for a few seconds after you choose a function (like DVD/LD, CD, etc.) and then get softer. This will still happen when you adjust the brightness but the new setting will be the one the display softens to.

DUAL MONO Setting

The dual mono setting can only be used when listening to Dolby Digital discs that have dual mono software encoded in them. Dual mono software usually is used to put two different soundtracks on one DVD. With this setting you can choose which channel in the dual mono setting you want to listen to. Thus, it is useful for soundtracks that have one language on one channel and a different language on the other. Remember this setting is only applicable if you are using Dolby Digital software with dual mono and want to isolate one of the channels therein. Otherwise, just ignore this function.

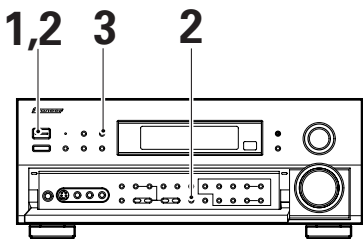

- 1 Put the receiver in **STANDBY** mode.
- 2 While holding down the **VIDEO SELECT** button press the **STANDBY/ON** button on the front panel.
- 3 You will see **DUAL** in the display for about five seconds. During this time use the **STEREO/DIRECT** button to cycle through the different **DUAL MONO** settings to find the one you want.

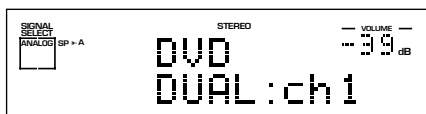

DUAL ch1 setting



DUAL ch2 setting

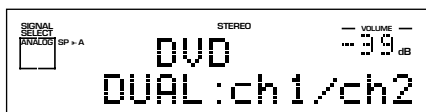

DUAL ch1/ch2 setting



When DUAL MONO is playing with ch 1 selected the L will Lights. When playing with ch 2 selected the R will Lights. When playing with ch 1/2 selected the L and R will Lights.

The different settings are: DUAL ch1, where you only hear channel 1; DUAL ch2, where you only hear channel 2; and DUAL ch1/ch2, where you hear both channels, but independently from different speakers.

The default setting is DUAL ch1.

Using the Tuner

Before operating the receiver, be sure to press the **ON/OFF** button on the front panel to turn the power ON.

Automatic and Manual Tuning

The following steps show you how to tune in FM and AM radio broadcasts using the automatic (search) and manual (step) tuning functions. If you already know the exact frequency of the station you desire, see "Direct Access Tuning" on the following page.

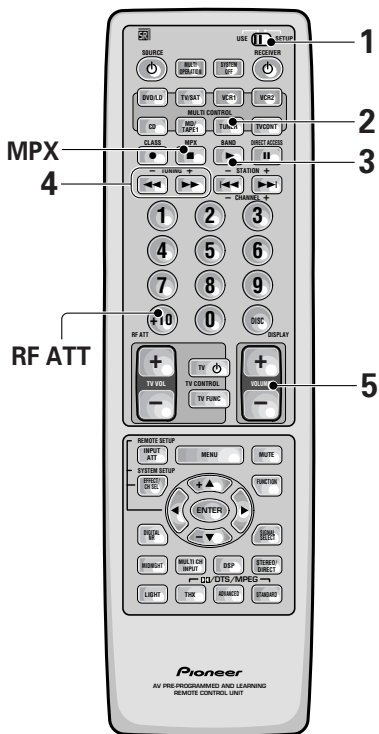

1 Put the remote control slide switch in USE.

2 Press the TUNER button.

On the remote, this selects the TUNER function on the receiver and sets the remote to the TUNER operation mode.



3 Press BAND button on the remote control or the front panel to select the band (FM or AM).

Each press switches the band: FM ↔ AM

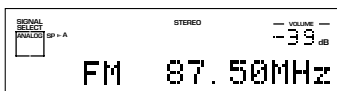

4 Tune in the station.

For Automatic Tuning

Press and hold TUNING +/- buttons for about one second, then release.

The tuner starts searching the selected band and stop automatically at the first station it locates. Repeat to locate other stations.

For Manual Tuning

- To change frequencies one step at a time, press TUNING +/- buttons repeatedly.
- To change frequencies quickly, hold down TUNING +/- buttons and release when you reach the frequency you desire.

5 Adjust the MASTER VOLUME buttons on the remote control or the MASTER VOLUME on the front panel.

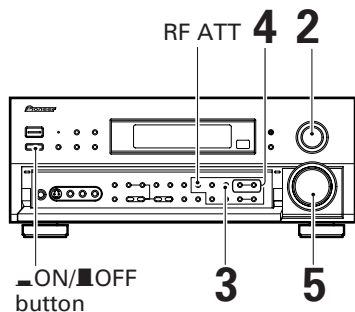

MPX Mode

If the TUNED or STEREO indicators do not light when tuning an FM station, because the station is too far away or the broadcast signal is weak, press MPX button on the remote control to switch to MONO reception. This should improve reception enough for you to enjoy the broadcast.

RF ATT Mode

Press the RF ATT button to turn the RF attenuator on to reduce sound distortion when receiving strong FM signals from nearby stations. Normally, this button should be set to off. This button does not affect AM reception.

Direct Access Tuning

The following steps show you how to tune directly to a specific frequency using the remote control.

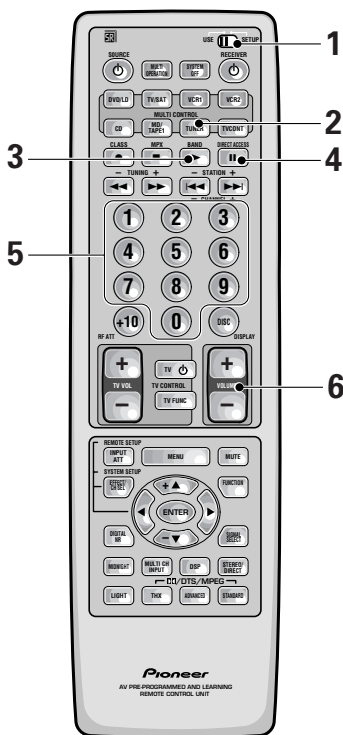

1 Put the remote control slide switch in USE.

2 Press the TUNER button.

This selects the TUNER function on the receiver and sets the remote to the TUNER operation mode.

3 Press the BAND button on the remote control or the front panel to select the band (FM or AM).

Each press switches the band : FM ↔ AM

4 Press DIRECT ACCESS button to activate the direct Access tuning mode.

The cursor blinks in the display on the front panel.



5 Use the number buttons to enter the frequency of the station you want.

Example:

To tune station 106.00 (FM), press:



To cancel before inputting the frequency

Press DIRECT ACCESS button, and enter the frequency again.

6 Adjust the MASTER VOLUME buttons on the remote control or the MASTER VOLUME on the front panel.

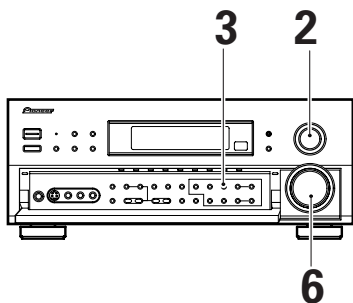

Memorizing Frequently Used Stations

The following steps show you how to memorize up to 30 radio stations in 3 classes (each holding 10 channels). When memorizing FM frequencies, the receiver also memorizes the MPX mode (STEREO or MONO and RF ATT).

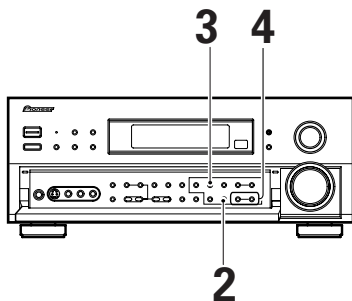

1 Tune in the desired station.

See "Automatic and Manual Tuning" or "Direct Access Tuning" on p.55 and 56.

2 Press the MEMORY button to activate the memory function.



3 Press the CLASS button repeatedly to select a class number.

Each press switches the display:

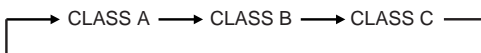

4 Press the STATION +/- buttons repeatedly to select a channel (0-9) within the respective class.

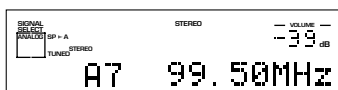

The station is memorized automatically after 5 seconds.

If you want to escape from MEMORY mode

Press the MEMORY button again.

Repeat steps 1 through 4 to memorize up to 30 stations.

Recalling Memorized Stations

Using the remote control

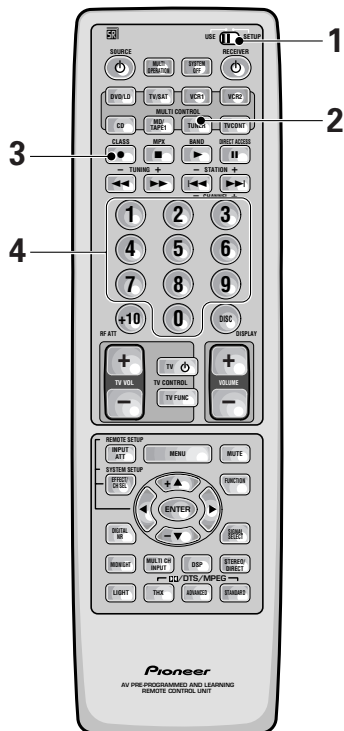

1 Put the remote control slide switch in USE.

2 Press the TUNER button.

This selects the TUNER function on the receiver and sets the remote to the TUNER operation mode.



3 Press the CLASS button repeatedly to select a class number.

Each press switches the display:

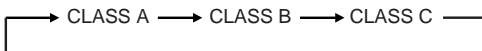

4 Use the number buttons to select the channel you want.

To select channel 7, press **7**.

For example : If 99.50 MHz (FM) was memorized in class A at channel 7.



To skip through each channel in order

Press STATION -/+ repeatedly.

Using the front panel

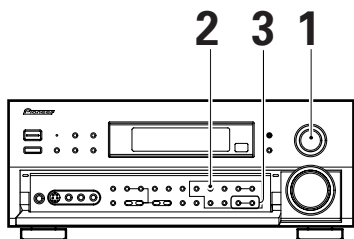

1 Select the TUNER function.

2 Press the CLASS button repeatedly to select a class number.

3 Press the STATION -/+ buttons repeatedly to select the channel you want.

Memorizing a broadcast station name (Manual Station Name Memory)



- You can input a name of up to four characters for each preset broadcast station (see pages 57).
- The memorized name takes priority over PS data.

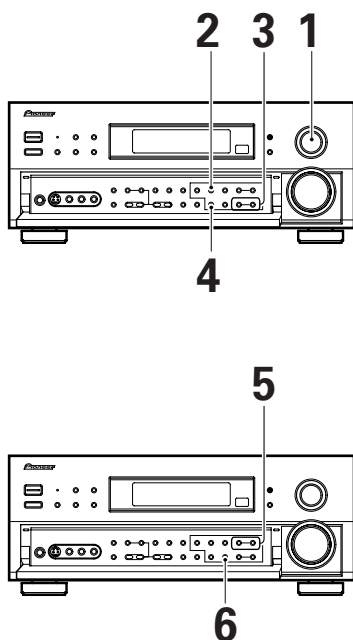

1 Select the TUNER function.

2 Press the CLASS button repeatedly to select a class.

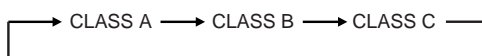

3 Press the STATION +/- buttons to select the preset channel.

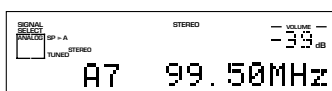

4 Press the CHARACTER/SEARCH button to select the character input mode.

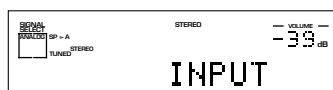

* When it is set to OFF, frequency being received will be displayed.

When FM is selected:

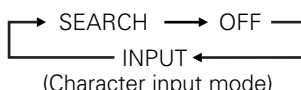

When AM is selected:

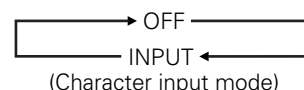

5 Press the TUNING +/- buttons to enter the broadcast station name.

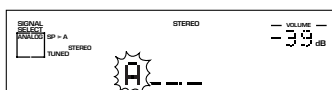

Refer to "Character display used for station name input" on p.87.

6 Press MEMORY to input the first of four characters. After four characters have been entered, the character input mode is exited.

Repeat steps 2 to 4 to memorize up to 30 broadcast station names.

To erase and change the memorized station name

Perform the procedures of "Memorizing a broadcast station name" and enter four spaces to erase the memorized station name.

When you want to change a memorized station name, input the new station name using the same procedure.



For greater convenience, record memorized station names in the STATION CALL button "memo" on p.87.

An Introduction to RDS & EON

Radio Data System, or RDS as it's usually known, is a system used by FM radio stations to provide listeners with various kinds of information—the name of the station and the kind of show they're broadcasting, for example. This information shows up as text on the display, and you can switch between the kind of information shown. Although you don't get RDS information from all FM radio stations, you do with most.

Probably the best feature of RDS is that you can search automatically by type of program. So, if you felt like listening to jazz, you could search for a station that's broadcasting a show with the program type, "JAZZ". There are around 30 such program types, including various genres of music, news, sport, talk shows, financial information, and so on.

The VSX-909RDS/909RDS-G receiver lets you display three different kinds of RDS information: Radio Text, Program Service Name, and Program Type.

Radio Text (**RT**) is messages sent by the radio station. These can be anything the broadcaster chooses—a talk radio station might give out its telephone number as RT, for example.

Program Service Name (**PS**) is the name of the radio station.

Program Type (**PTY**) indicates the kind of program currently being broadcast.

The VSX-909RDS can search for and display the following program types:

NEWS	
AFFAIRS	Current affairs
INFORMATION	General information
SPORT	
EDUCATION	Educational material
DRAMA	Radio plays or serials
CULTURE	
SCIENCE	Science and technology
VARIED	Usually talk-based material, such as quiz shows or interviews.
POP MUSIC	Pop music
ROCK MUSIC	Rock music
M.O.R. MUSIC	"Middle of the road" music
Light MUSIC	'Light' classical music
CLASSICAL	'Serious' classical music
Other MUSIC	Other music not fitting any of the above categories
WEATHER	
FINANCE	Stock market reports, commerce, trading, etc.
CHILDREN	Children's entertainment
SOC AFFAIRS	Social affairs
RELIGION	
PHONE IN	
TRAVEL	Holiday-type travel rather than traffic announcements.
LEISURE	Leisure interests and hobbies
JAZZ MUSIC	
COUNTRY M	Country music
NATIONAL M	Popular music in a language other than English
OLDIES MUSIC	Popular music from the '50s
FOLK MUSIC	Folk music
DOCUMENTARY	Documentaries

In addition, there is a program type, ALARM!, used for exceptional emergency announcements. You can't search for this, but the tuner will switch automatically to this RDS broadcast signal.

Basics of EON

EON (Enhanced Other Network information)

EON is a function that allows you to set the receiver to switch to a frequency automatically when a program featuring traffic information or news is being broadcast. It cannot be used in areas that EON information is not transmitted and when FM broadcast stations do not transmit PTY data. When the broadcast ends, the tuner returns to the original frequency or function.

There are two types of EON you can set the tuner to:

1. TA (Traffic Announcement)
This mode will set the tuner to pick up traffic information when it is broadcast.
2. NEWS
This mode will set the tuner to pick up news when it is broadcast.

Setting EON allows automated reception of TA/NEWS broadcasts

When EON is turned on, the receiver will automatically jump to those EON-linked broadcasts. Even if a receiver function other than the tuner is being used, the receiver function will switch to the FM station automatically when an EON-linked Traffic Information or News program begins. When the program ends, the original function will be restored. The EON function will not operate, however, when the tuner is on AM.

The receiver's internal Program Identification function

PI (Programma Identification)

This is an identifying marker the tuner automatically attaches to stations stored in your preset memory classes (see p.59). The marker distinguishes between stations which transmit RDS data and those that don't, so that the receiver knows which stations to look at when searching for RDS or EON transmissions. The code is not displayed on the receiver and you don't need to do anything in regards to setting the PI codes.

PI code registration and erasure

The receiver will automatically register a PI code for any station you input into the memory classes (see p.59) which can receive RDS or EON data. If you want to have a station preset in your memory banks but DON'T want the receiver to search this station for RDS information you can erase the PI code and then the receiver will ignore this station when searching for RDS transmissions.

To erase PI codes, follow this procedure:

1. When tuned to the station whose PI code you want to erase press the EON MODE button for two seconds or more.
"ERASE PI" will be displayed.
2. Press MEMORY button within 5 seconds.

RDS (Radio Data System) Broadcast Reception

Displaying RDS data

One of the most useful features of RDS is the ability to search for a particular kind of radio program. You can search for any of the program types listed on page 60—this covers all kinds of music, as well as news, weather forecasts, sports programs, and a variety of others.

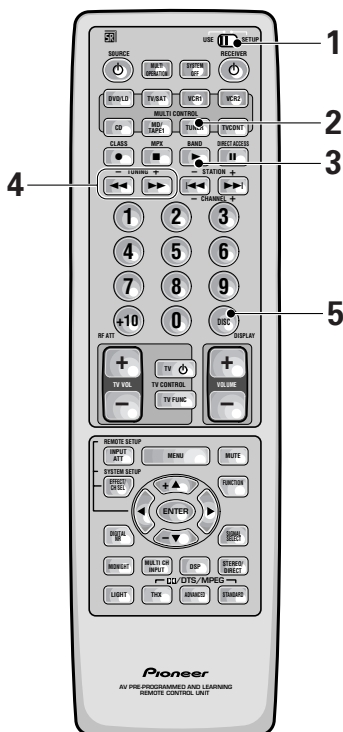

1 Put the remote control slide switch in USE.

2 Press the TUNER button.

This selects the TUNER function on the receiver and sets the remote control to the TUNER operation mode. The previously tuned station is received automatically.

3 Press the BAND button on the remote control or the front panel to select FM.

Each press switches the band: FM ↔ AM

4 Tune into a station.

Refer to “Automatic and Manual Tuning” or “Direct Access Tuning” on pages 55 and 56.

- If the received broadcast transmits RDS data, the RDS indicator lights, and the data of the display mode appears in the display.

5 Press the DISPLAY button to select a mode.

Each press changes the display as follows:

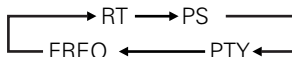

- In the RT mode, should any noise be picked up while displaying the RT scroll, some characters may temporarily be incorrectly displayed.
- In the RT mode, when no RT data is transmitted from a broadcast station, “NO RADIO TEXT DATA” is displayed once and after that the PS data is displayed.
- In the PTY mode, there are cases where “NO TYPE” is displayed. In this case, it will automatically switch to the PS mode after a few seconds.
- When reception conditions are strong, and RDS data is incorrectly displayed, press RF ATT.

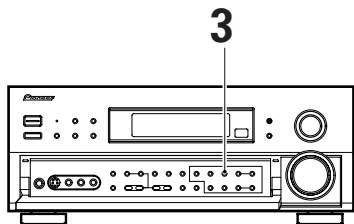

Searching for a program by program type (PTY)

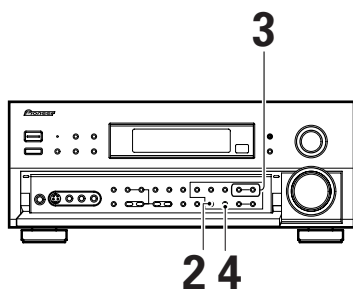
**1 Tune into an FM station.**

Refer to "Automatic and Manual Tuning" or "Direct Access Tuning" on p.55 and 56.

2 Press the CHARACTER/SEARCH button to select the PTY search mode.

* When it is set to OFF, the frequency being received is displayed.

When the **STATION** mode is selected:

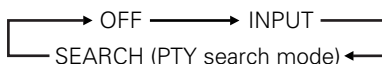

When the **FREQUENCY** mode is selected:

**3 Press the TUNING +/- buttons to select the desired program type.**

* Refer to page 60 for program types.

4 Press the MEMORY button to search for the selected program type.

This will search the preset stations for a station broadcasting the selected program type. Press the MEMORY button within 5 seconds after a program has been found. If the MEMORY button is not pressed, the function will begin to search for another station automatically.



This function searches RDS station preset in the 30ch memory. If this function is set when no stations have been preset, "NO PTY" will be displayed. If the desired PTY could not be found amongst the RDS stations in memory, the same display appears.

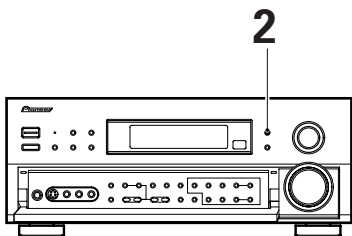

Refer to p.60 for more information about EON.

1 Tune into an EON FM station.

Refer to "Automatic and Manual Tuning" or "Direct Access Tuning" on p.55 and 56.

- Even if the EON mode is off, when an FM station is broadcasting a news or traffic information program, the EON indicator lights in the display to inform you that the currently tuned station carries the EON data service.

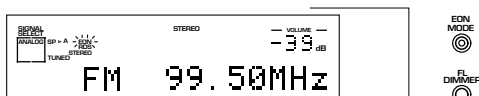

2 Press the EON MODE button to select the mode.

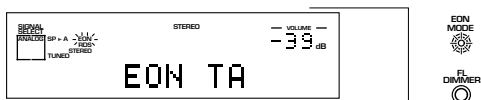

Each press changes the display as follows:



- When EON is set to OFF, the frequency being received will be displayed, and then the RDS data will be displayed in the present display mode.
- The EON mode is canceled if you switch to AM reception while setting EON. Start once again after you return to FM reception.
- Simultaneous requests for Traffic Information (TA) and News programs is not possible.
- You cannot operate the MEMORY and CHARACTER/SEARCH buttons while the EON MODE indicator on the button lights.
- Functions other than TUNER cannot be changed while the EON MODE indicator on the button blinks (while receiving EON broadcast). If you want to change to a source other than TUNER, press the EON MODE button and turn the EON mode off.
- When you are playing back TAPE 2 while setting EON, TAPE 2 will be canceled by reception of EON. The function returns once more to TAPE 2 after EON reception is finished.
- When EON is turned on and a function other than the tuner is selected, the function will switch to the FM station automatically when Traffic Information or News begins. When the program ends, the original function will be restored.
- When the EON mode is on, the EON MODE indicator on the button lights. During reception of the selected news or traffic information broadcast, the EON MODE indicator on the button blinks.

Remote Control of Other Components

Before operating the receiver, be sure to press the **ON/ OFF** button on the front panel to turn the power ON (ON).

Setting Up the Remote Control to Control Other Components

In addition to controlling the receiver, the supplied remote control can operate your other components (VCR, TV, LD, CD, etc.) after you program it to do so. In this way, instead of fumbling with many different controls and buttons, you only need to use one remote control. If your component(s) are listed in the remote control's memory, simply follow the steps below. If your component(s) are not listed, or if you want the remote to learn additional operations, you can use the learning mode to input the information from the remote controls supplied with your other components.

Recalling Preset Codes

The following steps show you how to recall preset codes stored in the remote control. Once a preset code is recalled and the component assigned, you can use this remote to easily operate the component. See "Preset Code List" on page 88-91 for the components and manufacturers available.

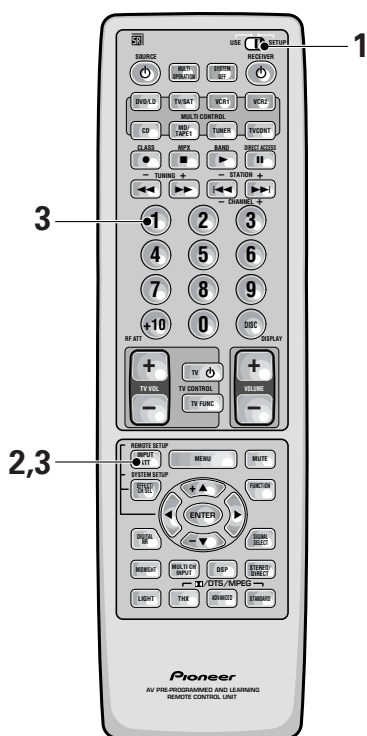

1 Set the remote control slide switch to **SETUP**.

Also make sure that your TV is on and set to the receiver.

2 Press the **REMOTE SETUP (INPUT ATT)** button.

The REMOTE SET UP menu appears on your TV screen.

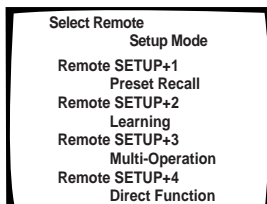

You have four setup options:

- ① Preset Recall
- ② Learning
- ③ Multi Operation (See p.78)
- ④ Direct Function (See p.81)

Preset Recall and Learning are the two modes that teach the remote control to operate your other components. It's easiest to start with Preset Recall and, if setup isn't possible for certain components, move on to the Learning mode.

3 Press the **REMOTE SETUP** button and ① at the same time to select the preset recall setup mode.

All the MULTI CONTROL buttons (except the TUNER button) start to blink.

To cancel the preset recall setup mode press **REMOTE SETUP**.

Remote Control of Other Components

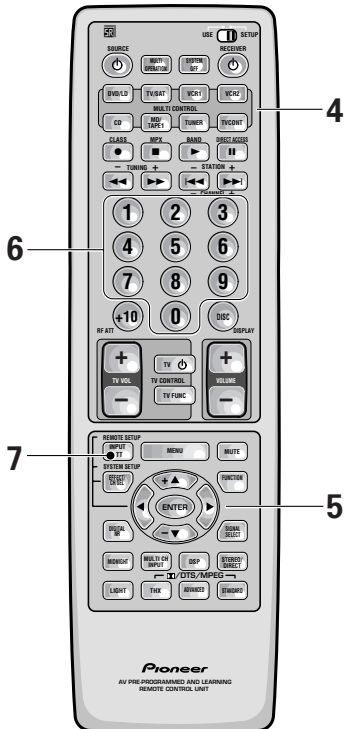

4 Press the **MULTI CONTROL** button for the component you want to control.

The selected button lights steadily and the first manufacturer (and preset code(s)) appear on your TV screen.

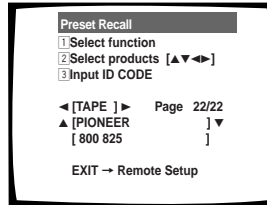

5 Press the **◀/▶** buttons to choose the function and then press the **▲/▼** buttons repeatedly to display the name of the component's manufacturer.

Most manufacturers have been programmed into the receiver, but if your component is made by a small or relatively unknown manufacturer you may not be able to find it.

6 Point the remote toward the component to be controlled, enter the 3 digit code.

If the component you are trying to control turns on/off, the set up for this component is complete, but components that don't have a standby mode can't respond in this way. To test if you've set it up properly work through step 7. Then try using selecting the function you just set up (for example a CD player) and using the controls on this remote control. If the component does not respond, try working through the procedure again and pressing number 2 instead this time. Continue this procedure until one of the commands works.

7 Press the **REMOTE SETUP** button to exit the preset recall setup mode.

The remote control and TV return to their previous operation modes.

- When you're done setting up, remember to set the slide switch back to USE.

Learning Commands from Other Remote Controls

If preset codes are not available for your component(s), or the available preset codes do not operate correctly, you can use this function to program in signals from the remote control(s) of your other component(s). This operation can also be used after recalling a preset code to program additional operations not covered in the preset codes.

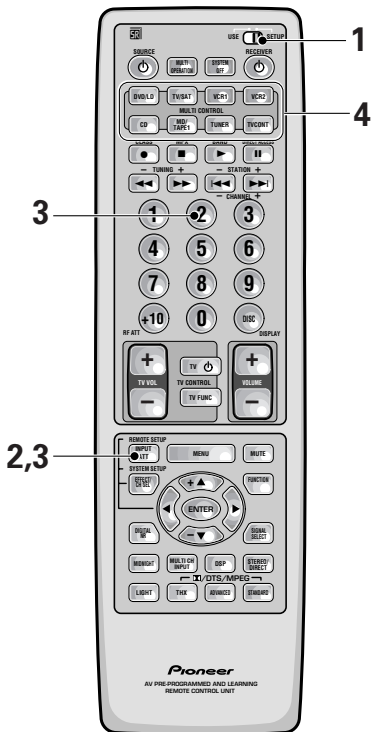

1 Set the remote control slide switch to **SETUP**.

Also make sure that your TV is on and set to the receiver.

2 Press the **REMOTE SETUP** button.

The REMOTE SET UP menu appears on your TV screen.

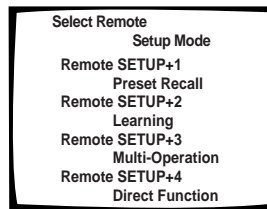

3 Press the **REMOTE SETUP** button and **2** at the same time to select the **Learning setup mode**.

All the MULTI CONTROL buttons (except the TUNER button) start to blink.

To cancel Learning setup mode, press the REMOTE SET UP button.

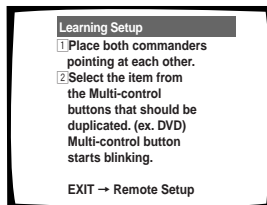

4 Press the **MULTI CONTROL** button for the component you want to control.

Each button can be set to control one of the following components

The selected button continues to blink.

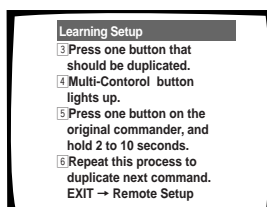

Remote Control of Other Components

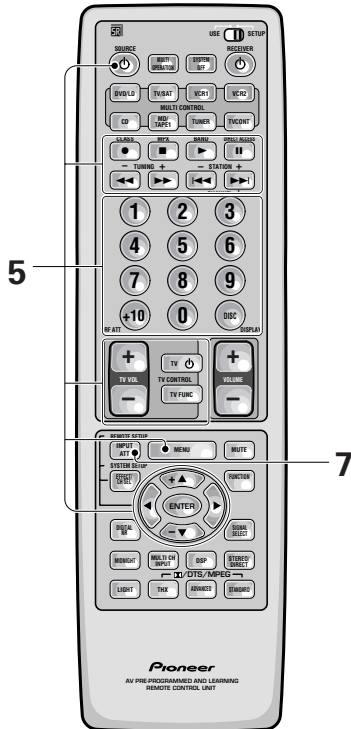

5 Press the button to be programmed.

The MULTI CONTROL button lights steadily.

- The TV POWER, TV FUNC and TV VOL +/- buttons are only available for learning when programming TV CONTROL operations.

6 Point the remote controls at each other and press the button on the other remote control for the operation you wish to program .

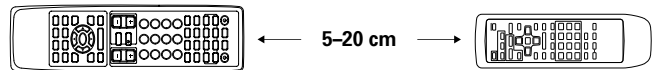

- ① Point the remote controls toward each other.
- ② Hold down the button on the other remote control corresponding to the operation you wish to program. Release when the MULTI CONTROL button on the receiver's remote control starts blinking.

(The MULTI CONTROL button blinks to indicate that the operation has been learned.)

To program additional operations for the current component, repeat steps 5 and 6.

To program operations for another component, repeat steps 4 through 6.

7 Press the REMOTE SETUP button to exit the learning setup mode.

The remote control and TV return to their previous operation modes.

- When you're done setting up, remember to set the slide switch back to USE.

Using the Remote Control with Other Components

DVD or LD Player Operations

- The following operations are available from the receiver's remote control after you program your DVD or LD player's preset code, but some operations may need to be learned by the receiver (see "Setting Up the Remote Control to Control Other Components," on pages 65–68).
- To perform these operations, press the **DVD/LD** button to set the remote to the DVD or LD operation mode.
- For more information on individual commands consult the manual that came with the component.

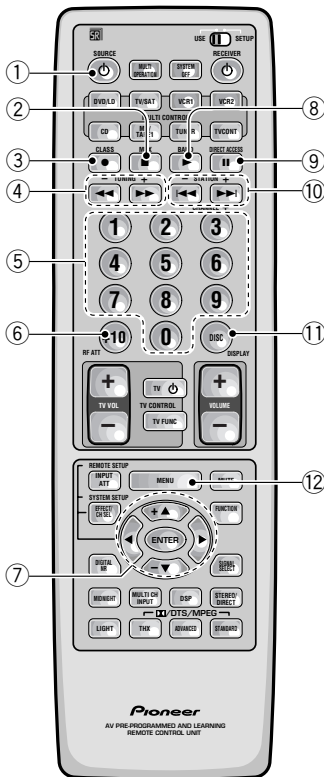

- 1 SOURCE**
Press to switch the DVD or LD player on or off (not possible with all models, especially those without a standby mode).
- 2 ■**
Press to stop playback.
- 3 ● (TOP MENU)**
Press to call up the menu programmed on the DVD (for DVD only).
- 4 ◀◀/▶▶**
◀◀ : Hold down for fast reverse playback.
▶▶ : Hold down for fast forward playback.
- 5 Number buttons**
Use to select chapters (tracks).
- 6 +10**
Use when selecting chapter (track) numbers higher than 10.
- 7 ▲/▼/◀/▶/ENTER**
▲/▼/◀/▶ : Use to navigate through options on menu screens and to change settings.
ENTER : Use to implement settings selected with the cursor buttons or to set items highlighted in a menu (for DVD only).
- 8 ▶**
Press to start playback.
- 9 ||**
Press to pause playback.
- 10 |◀◀/▶▶|**
|◀◀ : Press to return to the beginning of the current chapter (track). Press repeatedly to return to the beginning of previous chapters (tracks).
▶▶| : Press to advance to the beginning of the next chapter (track). Press repeatedly to advance to the beginning of following chapters (tracks).
- 11 DISC**
Use to change the LD between sides A and B (for LD only).
- 12 MENU**
Press to bring up the disc menu.

Remote Control of Other Components

VCR & DVD Recorder Operations

- The following operations are available from the receiver's remote control after you program your VCR or DVD video recorder's preset code, but some operations may need to be learned by the receiver (see "Setting Up the Remote Control to Control Other Components," on pages 65–68).
- To perform these operations, press the **VCR 1** or **VCR 2** button to set the remote to the VCR, DVD video recorder operation mode.
- For more information on individual commands consult the manual that came with the component.

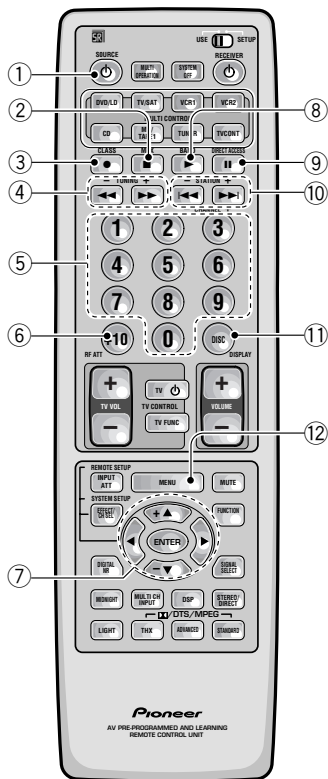

① **SOURCE**

Press to switch the VCR or DVD video recorder on or off (not possible with all models, especially those without a standby mode).

② **■**

Press to stop playback.

③ **●**

Press to start recording.

④ **◀◀/▶▶**

◀◀ : Hold down for fast reverse playback.

▶▶ : Hold down for fast forward playback.

⑤ **Number buttons**

Use to select channels.

⑥ **+10**

Use when selecting chapter (track) numbers higher than 10 (for DVD video recorder only).

⑦ **▲/▼/◀/▶/ENTER**

▲/▼/◀/▶ : Use to navigate through options on menu screens and to change settings.

ENTER : Use to implement settings selected with the cursor buttons or to set items highlighted in a menu (for DVD video recorder only).

⑧ **▶**

Press to start playback.

⑨ **||**

Press to pause playback.

⑩ **CHANNEL -/+**

Use to change channels on the VCR's tuner.

⑪ **DISC (TV/VCR)**

Use this button to switch the VCR between its tuner (for watching videos) and the TV.

Press to stop recording (for DVD video recorder only).

⑫ **MENU**

Use to display or close the title menu screen (for DVD video recorder only).

CD & CD-R Player Operations

- The following operations are available from the receiver's remote control after you program your CD player or CD-R's preset code, but some operations may need to be learned by the receiver (see "Setting Up the Remote Control to Control Other Components," on pages 65–68).
- To perform these operations, press the **CD** button to set the remote to the CD operation mode.
- For more information on individual commands consult the manual that came with the component.

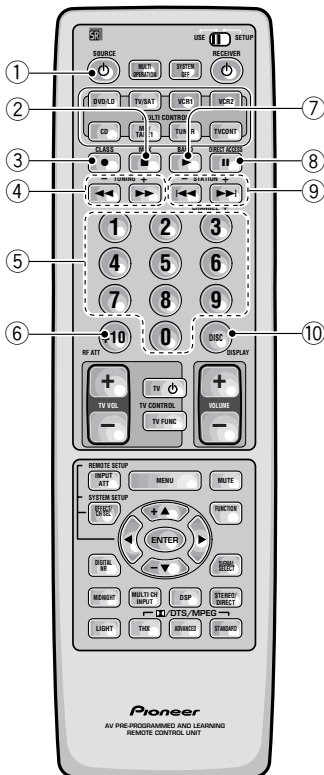

① **SOURCE**

Press to switch the CD player/recorder on or off (not possible with all models, especially those without a standby mode).

② **■**

Press to stop playback.

③ **●**

Press to start recording (CD-R only).

④ **◀◀/▶▶**

◀◀ : Hold down for fast reverse playback.

▶▶ : Hold down for fast forward playback.

⑤ **Number buttons**

Use to select channels.

⑥ **+10**

Use when selecting chapter (track) numbers higher than 10.

⑦ **▶**

Press to start playback.

⑧ **||**

Press to pause playback.

⑨ **◀◀/▶▶**

◀◀ : Press to return to the beginning of the current track. Press repeatedly to return to the beginning of previous tracks.

▶▶ : Press to advance to the beginning of the next track. Press repeatedly to advance to the beginning of following tracks.

⑩ **DISC**

Use to switch between discs in file type disc play.

Remote Control of Other Components

MD Operations

- The following operations are available from the receiver's remote control after you program your MD recorder's preset code, but some operations may need to be learned by the receiver (see "Setting up the Remote Control to Control Other Components," on pages 65–68).
- To perform these operations, press the **MD/TAPE 1** button to set the remote to the MD operation mode.
- For more information on individual commands consult the manual that came with the component.

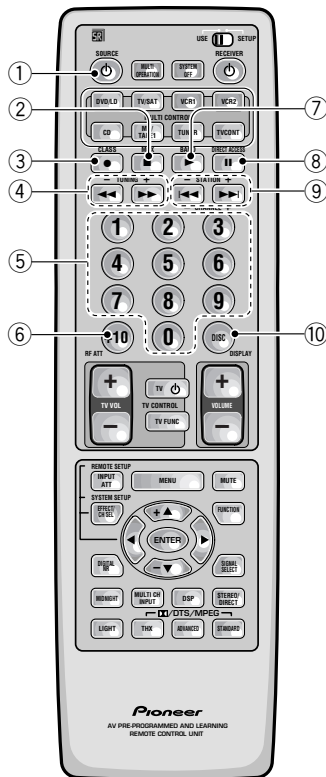

① **POWER**

Press to switch the MD player on or off (not possible with all models, especially those without a standby mode).

② **STOP**

Press to stop playback or recording.

③ **RECORD**

Press to start recording (may put some decks in REC PAUSE mode).

④ **FAST REVERSE / FAST FORWARD**

◀◀ : Hold down for fast reverse playback.

▶▶ : Hold down for fast forward playback.

⑤ **Number buttons**

Use to select tracks.

⑥ **+10**

You can also use this button when selecting track numbers higher than 10. It's especially used for track numbers 11-19.

⑦ **PLAY**

Press to start playback.

⑧ **PAUSE**

Press to pause playback.

⑨ **TRACK RETURN / TRACK ADVANCE**

◀◀ : Press to return to the beginning of the current track.

Press repeatedly to return to the beginning of previous tracks.

▶▶ : Press to advance to the beginning of the next track. Press repeatedly to advance to the beginning of following tracks.

⑩ **DISC (DISPLAY)**

Allows you to change the display mode of the MD.

STB (satellite tuner) Operations

- The following operations are available from the receiver's remote control after you program your satellite tuner's (or cable TV's) preset code, but some operations may need to be learned by the receiver (see "Setting Up the Remote Control to Control Other Components," on pages 65–68).
- To perform these operations, press the **TV/SAT** button to set the remote to the SAT operation mode.
- For more information on individual commands consult the manual that came with the component.

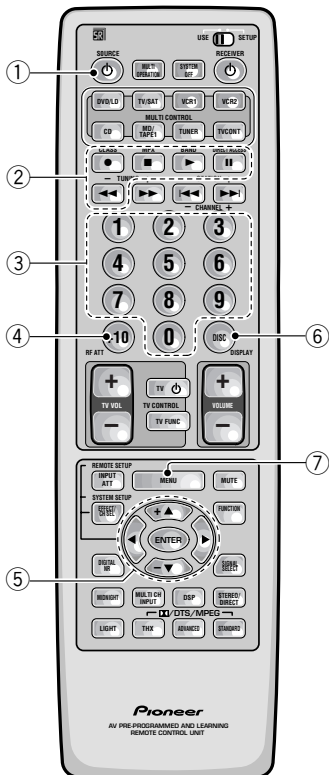

① **SOURCE**

Press to switch the satellite tuner on or off (not possible with all models, especially those without a standby mode).

② **●/■/▶/⏸/◀◀ (A/B/C/D/E)**

Use to make selections from Satellite functions.

③ **Number buttons**

Use to select satellite channels.

④ **GUIDE**

Use to turn the program information screen on or off.

⑤ **▲/▼/◀/▶/ENTER**

▲/▼/◀/▶ : Press the button to select items on the SAT GUIDE screen or SAT MENU screen.

ENTER : Press to activate the selected function.

⑥ **EXIT**

Press to exit the current setting of the SAT.

⑦ **MENU**

Use to turn the main menu on or off.

Remote Control of Other Components

TV Operations

- The following operations are available from the receiver's remote control after you program your TV's preset code, but some operations may need to be learned by the receiver (see "Setting Up the Remote Control to Control Other Components," on pages 65–68).
- To perform these operations, press the **TV/SAT** or **TV CONT** button to set the remote to the TV operation mode.
- For more information on individual commands consult the manual that came with your TV.

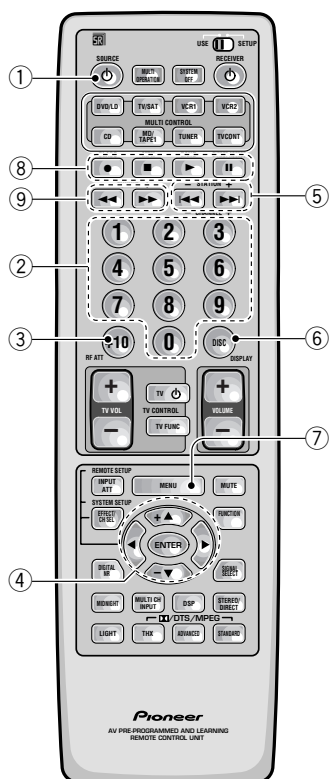

① **SOURCE**

Press to switch the TV on or off (not possible with all models, especially those without a standby mode).

② **Number buttons**

Use to select a specific TV channel.

③ **+10**

Use to select a specific TV channel.

④ **▲/▼/◀/▶/ENTER**

▲/▼/◀/▶/ : Press to select or adjust items on the menu screen.

ENTER : Press to activate the selected function.

⑤ **CHANNEL +/-**

Use to select a TV channel.

⑥ **DISC (CH ENTER)**

Use to select the channel specified with the number buttons (not all models require this step).

⑦ **MENU**

Press to select the TV menu.

For Digital TVs:

⑧ **●/■/▶/■/◀◀ (BLUE/GREEN/RED/YELLOW)**

Use to make selections from the DTV menu.

⑨ **◀◀/▶▶**

◀◀ : Press to DTV mode on or off.

▶▶ : Press to select the DTV menu.

Cassette Deck Operations

You can use this remote control to control most cassette decks, though with some models the functions may differ.

- The following operations are available from the receiver's remote control after you recall a cassette deck's preset code, but some operations may need to be learned by the receiver (see "Setting Up the Remote Control to Control Other Components," on pages 65–68).
- To perform these operations, press the **MD/TAPE 1** button to set the remote to the TAPE operation mode.
- For more information on individual commands consult the manual that came with the component.

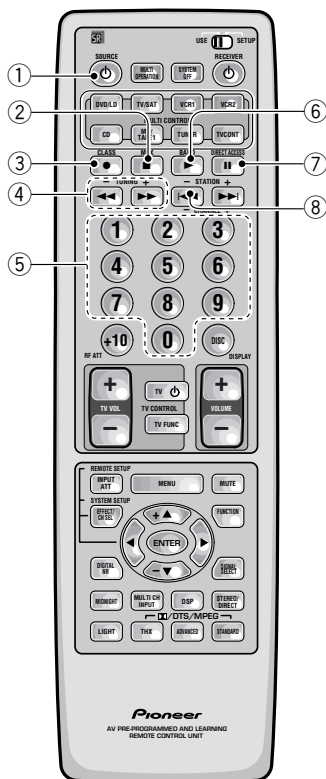

① **SOURCE**

Press to switch the cassette deck on or off (not possible with all models, especially those without a standby mode).

②

Press to stop playback or recording.

③

Press to start recording.

④

 : Press to rewind the tape.

 : Press to fast forward the tape.

⑤ **Number buttons (1-6)**

1 :  (Press to stop playback or recording.)

2 :  (Press to start playback of the side of the cassette which has been loaded as the front.)

3 :  (Press to pause playback or recording.)

4 :  (Press to rewind the tape.)

5 :  (Press to start reverse playback.)

6 :  (Press to fast forward the tape.)

⑥

Press to start playback of the side of the cassette which has been loaded as the front.

⑦

Press to pause playback or recording.

⑧

Press to start reverse playback (for auto reverse decks).

Using Other Functions

Recording from Audio Components

The following explanations show you how to record an analog or digital audio signal. Note that your analog components cannot record a player that is only connected digitally (and vice-versa). If you want to record from a digital component to an analog one (for example, a tape deck), or vice-versa, the digital component it must be connected via analog jacks and you need to set the SIGNAL SELECT switch to ANALOG. To make exact digital copies (of digital sources like CDs) both the source component and the recorder must be connected with digital connections. See p.12 for more on analog audio connections and p.13 for digital audio connections.



The receiver's volume, channel level, TONE, DIGITAL NR, MIDNIGHT, LOUDNESS and surround effects have no effect on the recorded signal and the MULTI CH IN cannot be recorded. In some cases, digital recordings have copy guard protections and making a digital copy is not possible. In this case you can only copy them in an analog manner.



1 Select the source component. Set SIGNAL SELECT according to the source component's signal (ANALOG or DIGITAL).

Press the SIGNAL SELECT button on the remote control (or use the button on the front panel) and choose ANALOG.

2 Start recording with a recorder.

3 Playback the source to be recorded.

Record monitor (TAPE 2 MONITOR)

If you connect a cassette deck with a record monitor function to the TAPE 2 MONITOR jacks, you can listen to the sound of an analog recording as it is being recorded.

Press TAPE 2 MONITOR to switch between the sound of the recording (TAPE 2 indicator on) and the sound of the source component (TAPE 2 indicator off).

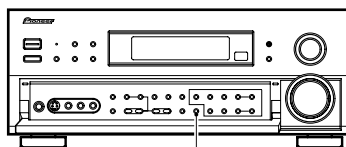

TAPE 2 MONITOR

Recording from Digital Audio Components

The following explanations show you how to record digital audio. Using this method you can make exact digital copies of sources like CDs or MDs. The only drawback is that you cannot switch between various recorders at the touch of a button like you can with analog recordings (see the previous page). If you look on the back of the receiver you will find 2 digital out jacks which are marked PCM/DIG/DTS/MPEG OUT (these are to the right of the digital in jacks in the upper left-hand corner). If you connect one of these to the optical input on a digital recorder (currently these include MD, DAT, and CD-R), you can make direct digital recordings with this unit. Of course, the digital components you want to record, all need to be connected to the receiver with digital inputs as well. See p.13 if you have not made these connections.



The receiver's volume, channel level, tone (BASS, TREBLE, and LOUDNESS), and surround effects have no effect on the recorded signal.

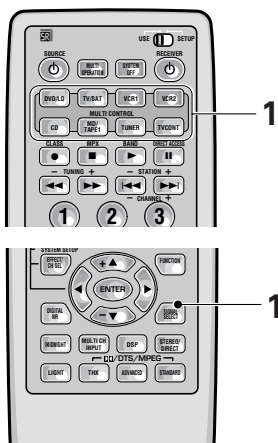

1 Prepare the source you want to record and put the receiver in that function. Set SIGNAL SELECT to DIGITAL.

Press the SIGNAL SELECT button on the remote control (or use the button on the front panel) and choose DIGITAL.

2 Start recording with a CD-R or MD (etc.).

3 Play back the source to be recorded.



In some cases, digital recordings have copy guard protections on them and making a digital copy is not possible. It is still possible to copy these digital sources if you have hooked the components up with analog connections (in this case, the copies will not be exact digital reproductions). Refer to the previous page in this case.

Recording from Video Components

The following operations show you how to record audio and video to the video tape recorder connected to the VCR 1/DVR or VCR 2 jacks. Note that all signals coming out of these jacks will be analog and it is not possible to record Dolby Digital/DTS soundtracks.



The receiver's volume, channel level, balance, TONE, DIGITAL NR, MIDNIGHT, LOUDNESS and surround effects have no effect on the recorded signal.

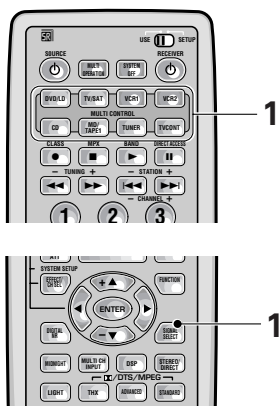

1 First, decide the component you'd like to record and put the receiver in that function. Set the SIGNAL SELECT to ANALOG.

Press the SIGNAL SELECT button on the remote control (or use the button on the front panel) and choose analog. Recording DIGITAL or DTS RF signals is not possible.

2 Start recording with VCR 1 or VCR 2 (etc.).

3 Playback the source to be recorded.

Multi Operations

A Multi Operation is a sequence of commands programmed into a single button to save you a lot of repetitive button pressing. Once setup, pressing the MULTI OPERATION button followed by one of the MULTI CONTROL buttons will switch on that component, the receiver and your TV, and switch the function of the receiver to that component. Up to five more commands can be programmed into a Multi Operation, such as changing the sound mode of the receiver and starting playback of the source.

Important: For Multi Operations to work with other non-Pioneer components, you must first setup the remote to control those other components—see pages 65-68 for more on this.

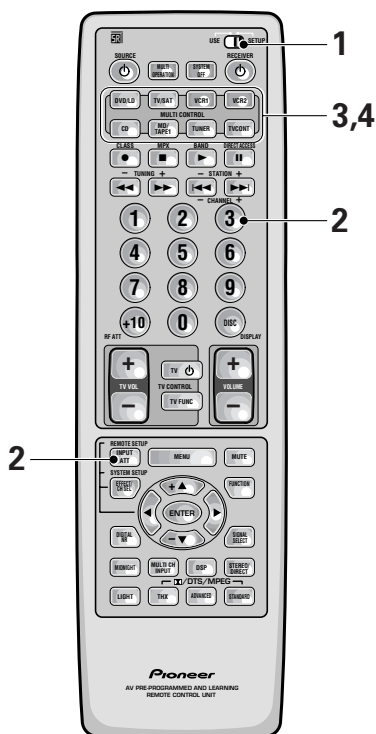

1 Set the remote control slide switch to SETUP.

Also make sure that your TV is on and set to the receiver.

2 Press the REMOTE SETUP button (INPUT ATT) and ③ at the same time to select the MULTI OPERATION SETUP mode.

The REMOTE SETUP menu appears on your TV screen. The MULTI CONTROL and the SYSTEM OFF buttons start to blink (see the following page for more on the SYSTEM OFF button).

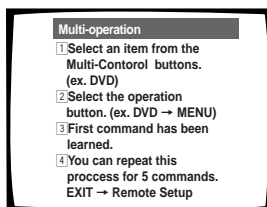

- To cancel here, press REMOTE SETUP.

3 Select a MULTI CONTROL button for this MULTI OPERATION.

Each MULTI CONTROL button can be used for one Multi Operation. If a Multi Operation relates to using a DVD player, for example, it makes sense to select the DVD/LD button.

After pressing a MULTI CONTROL button, just that button will remain blinking.

4 Select the MULTI CONTROL button for a source component.

For example, if you want this Multi Operation to switch on your DVD player press the DVD/LD.

After pressing a MULTI CONTROL button, that button stays lit.

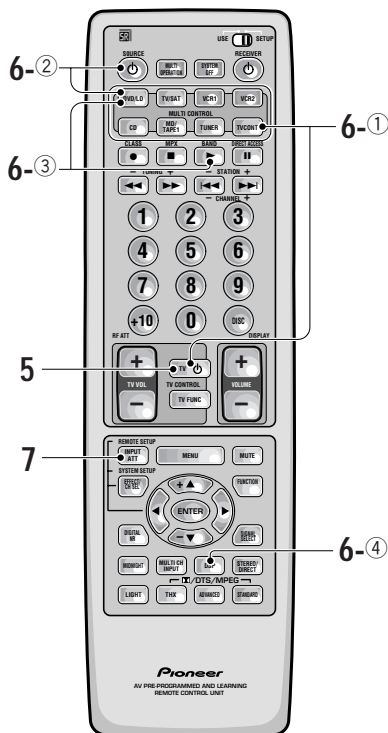

5 Press the operation button, for example TV (POWER), you want to input.

6 Repeat steps 4 and 5 to input MULTI OPERATIONS to the MULTI CONTROL button you pressed in step 3. You can also tell the receiver to go into a specific sound mode (THX, ADVANCED, STANDARD, MULTI CH IN, MIDNIGHT, DSP, DNR or STEREO) by inputting that command (for example, see operation 4 below).

You can repeat this process for up to five commands.

For example : you could enter the following four operations using the preceding steps 4 and 5.

- ① Press the TV CONTROL button and TV (POWER) to turn on your TV (as explained above).
- ② Press the DVD/LD button then (POWER) to turn on your DVD player (if it is not a PIONEER product).
- ③ Press the DVD/LD button then ► (play) to start playing the DVD player.
- ④ Press the ADVANCED button to put the receiver in that sound mode.

When you employ MULTI OPERATIONS (see below), these four tasks will be performed in the same order.

7 Press the REMOTE SETUP button to exit the Multi-operation setup mode.

The remote control and TV return to their previous operation modes.

Performing Multi Operations

Once you've programmed a Multi Operation, here's how to use it.

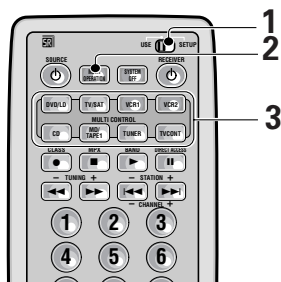

1 Set the remote control slide switch to USE.

2 Press the MULTI OPERATION button on the remote control.

The MULTI CONTROL buttons start to blink.

3 Press the MULTI CONTROL button to activate that Multi Operation.

The remote sends the Multi Operation commands you programmed.

System Off

The SYSTEM OFF feature allows you to tell the receiver and your other components to stop and turn off with the push of only one button on the remote control (**this feature will only work with components that have a standby mode**). For example, you can program the unit to stop your DVD, turn off your TV, turn off your DVD player and turn off the receiver itself. You don't need to program in other the power for PIONEER components, they will go off automatically in this mode. The receiver itself will go off automatically as well.

The steps below show you how to program a string of up to 5 different SYSTEM OFF operations based on eight possible components.



Be sure to recall or teach the remote control commands for each component before attempting MULTI OPERATIONS (see "Setting Up the Remote Control to Control Other Components," page 65-68).

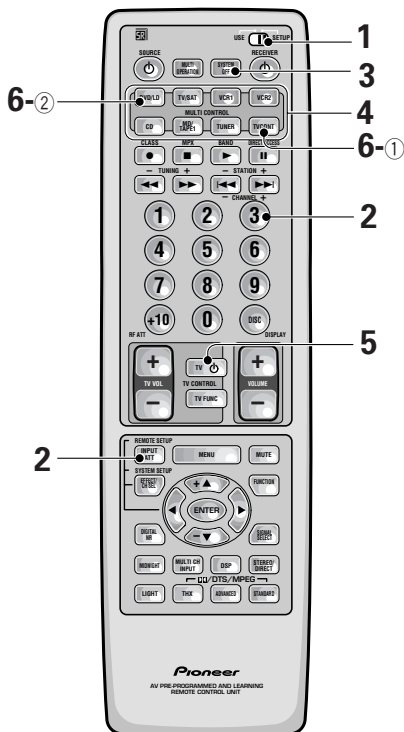

1 Set the remote control slide switch to **SETUP**.

Also make sure that your TV is on and set to the receiver.

2 Press the **REMOTE SETUP (INPUT ATT)** button and **3** at the same time to select the **MULTI OPERATION SETUP** mode.

The REMOTE SETUP menu appears on your TV screen. The MULTI CONTROL and the SYSTEM OFF buttons start to blink.

To cancel MULTI OPERATION SETUP mode, press REMOTE SETUP.

3 Press the **SYSTEM OFF** button.

The SYSTEM OFF button will blink.



4 Press the **MULTI CONTROL** button for the component whose operation you want to start **SYSTEM OFF** with (for example, **TV CONT** button).

The selected button will light steadily.

5 Press the operation, for example **TV** , you want to input.

6 Repeat steps 3 and 4 to program a sequence of up to five stop or power off commands you want to input. You can repeat this process for up to five commands.

For example : you could enter the following two operations using the proceeding steps 3 and 4.

- ① Press TV CONT button & TV  (POWER) to turn off your TV (as explained above).
- ② Press DVD/LD then  (POWER) to turn off your DVD player (if it is not a PIONEER product).

When you employ SYSTEM OFF (see below), these two tasks will be performed in the same order.

- To exit SYSTEM OFF SETUP mode, press REMOTE SETUP.
- When you're done setting up, remember to set the slide switch back to USE.

Using the System Off Button

This button will turn off the receiver and any component that has programmed into the SYSTEM OFF settings (see above) as well as turn off all PIONEER components regardless of whether they have been programmed into SYSTEM OFF. If you use this feature when a DVD is playing, the player will stop the play mode before switching off.

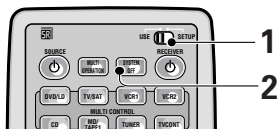

1 Set the remote control slide switch to USE.

2 Press the SYSTEM OFF button on the remote control.

Setting Up the Direct Function

The DIRECT FUNCTION is designed in case you have an external video source connected to your TV (a video source that is not going through the receiver). For this explanation we'll call this the "external video deck." You'd like to control the external video deck with this unit's remote control so you've assigned it a function button (for example purposes, the VCR 2 button). Yet, if you put the receiver in VCR 2 mode you'll get no picture on your TV because the external video deck signal is not going through the receiver. To get around this problem you set the DIRECT FUNCTION for VCR 2 to OFF. Now when you press VCR 2 function button you can control the external video deck with the remote but the receiver does not go into VCR 2 mode.

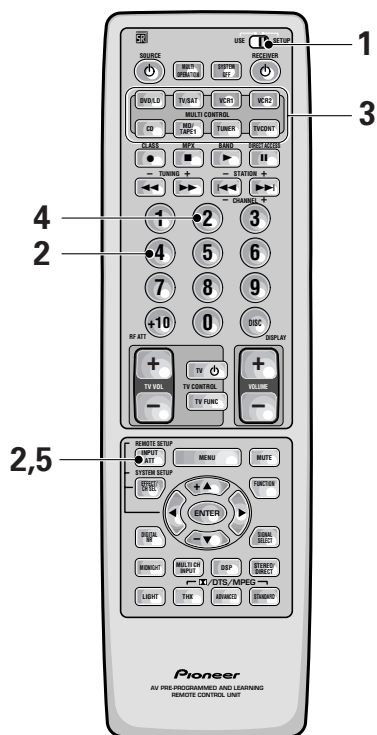

1 Set the remote control slide switch to SETUP.

Also make sure that your TV is on and set to the receiver.

2 Press the REMOTE SETUP (INPUT ATT) button and 4 at the same time to select the DIRECT FUNCTION mode.

The MULTI CONTROL buttons DVD/LD, TV/SAT, VCR 1, VCR 2, CD, and MD/TAPE 1 start to blink.

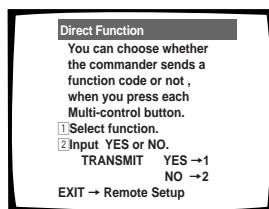

3 Select a component by pressing its MULTI CONTROL button.

4 Set the DIRECT FUNCTION of each external source to NO by pressing 2.

5 Press the REMOTE SETUP button to exit the DIRECT FUNCTION mode.

- When you're done setting up, remember to set the slide switch back to USE.



The default setting is all YES. If you have turned a DIRECT FUNCTION to NO and want to turn it back to YES, follow the directions above and press 1 in step 3.

Remote Back Light

When you press any button on the remote all the buttons light for a few seconds. You can change the strength of this light here. The default backlighting mode is Mid, Max is the strongest. Mid is slightly weaker. There's also the option to switch off backlighting altogether. This extends battery life considerably.

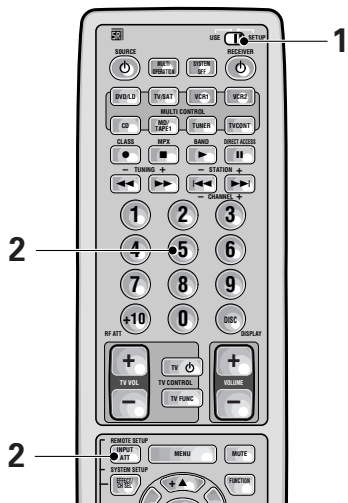

1 Set the remote control slide switch to SETUP.

2 Press and hold both the REMOTE SETUP (INPUT ATT) button and 5.

The remote back light options cycle in the following order:



The default setting is MID.

- When you're done setting up, remember to set the slide switch back to USE.

Resetting the Remote Control

The following operations allow you to erase the settings stored in the remote control.

Erasing Multi Operations

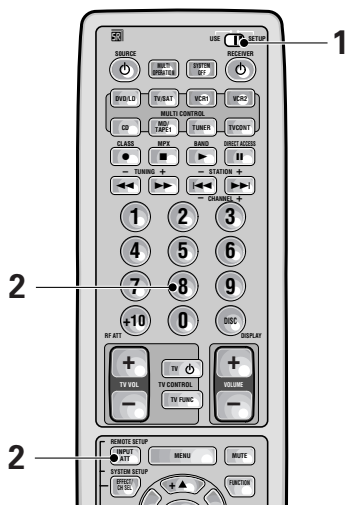

1 Set the remote control slide switch to SETUP.

2 Press and hold both the REMOTE SETUP (INPUT ATT) button and 8 for more than 3 seconds.

The MULTI CONTROL buttons will blink 3 times and all multi operation settings will be erased.

- When you're done setting up, remember to set the slide switch back to USE.

Erasing Learned Remote Control Commands

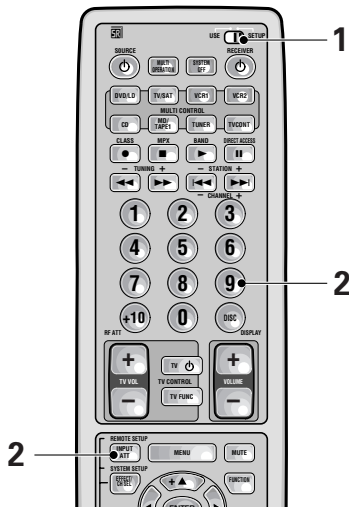

1 Set the remote control slide switch to SETUP.

2 Press and hold both the REMOTE SETUP (INPUT ATT) button and 9 for more than 3 seconds.

The MULTI CONTROL buttons will blink 3 times and all signals which have been learned from other remote controls will be erased.

- When you're done setting up, remember to set the slide switch back to USE.

Erasing All Learned Commands and Preset Codes

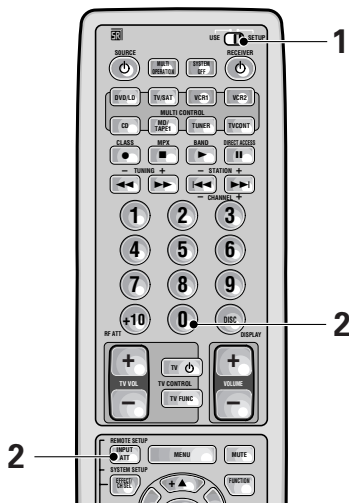

1 Set the remote control slide switch to SETUP.

2 Press and hold both the REMOTE SETUP (INPUT ATT) button and 0 for more than 3 seconds.

The MULTI CONTROL buttons, SYSTEM OFF button, and MULTI OPERATION button will blink 3 times and all preset and learned codes will be erased.

- When you're done setting up, remember to set the slide switch back to USE.

Video Select

This function allows you to listen to one sound source while you watch a different video source on your TV. The sound source is set in the normal fashion as is explained on p.45-46. You then alter the video input with the VIDEO SELECT button.

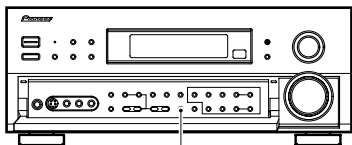

VIDEO SELECT

Press the VIDEO SELECT button on the front panel to cycle through the different possible video inputs.

The first press shows the video input you are currently using. After that pressing VIDEO SELECT cycles through the possibilities in the following order:

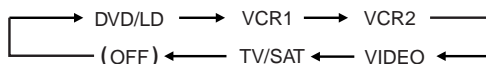

The OFF setting means the AUDIO and VIDEO source are the same. (Also, if one of the MD/TAPE 1, CD, TUNER, or PHONO functions are selected the VIDEO SELECT will be set to OFF.)

After choosing a video input the display on the receiver will show that input for about 5 seconds and then revert to showing the sound mode the receiver is in.

The VIDEO SELECT remains set to the input you chose until you change the audio input.

If you change audio functions the receiver will reset itself to make the video and audio inputs correspond.

Also, if you switch the power of the receiver OFF when you turn it back on the video and audio inputs will reset so that they correspond.

Techno Tidbits & Problem-solving

Dolby Digital

Dolby Digital is a compression format which records the sound of 6 channels of the theater surround system (Dolby Digital) on the movie film digital track. Of the 6 channels, the sub woofer channel is intended for bass only, and because the frequency range is smaller than the main channel, it is expressed as 5.1 channel.

Dolby Digital is the name of the Dolby surround multi-channel digital system that was developed after the Dolby Surround System and Dolby Pro Logic Surround System.

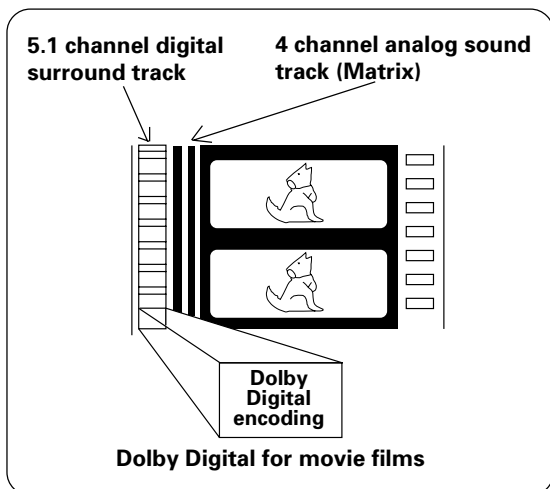

The number of movies made using Dolby Digital since 1992 has exceeded 300 and continues to increase. For compact disc players and laser disc digital sounds, 16 bits are used to sample the original analog audio waveform and sampling is carried out 44,100 times every second. However because an enormous amount of recording signal data is required for the multi channel system with this method, Dolby Digital is used to compress the data.

In reproducing audio signals, the smaller the bit number used, the lower the sound quality. With Dolby Digital, drop in auditory sound quality is prevented by using masking technology and digital filtering technology based on the human auditory characteristics.

MPEG Audio Multichannel

MPEG is an audio encoding system which delivers high quality audio for music and movies. By removing frequencies which are out of the human hearing range, the sound is then compressed to enable the transmission of mono, stereo, or multichannel (5.1 and 7.1) audio in a single bitstream which is why it has become a standard audio format for DVD and personal computers. The composition and versatility of MPEG audio also ensures that the presentation of a multichannel soundtrack will sound appropriate on everything from a 7.1 channel surround sound home theater setup to a mono television set. Above all, MPEG audio is designed to be compatible with past and future MPEG audio versions, which means that future versions of MPEG audio will be compatible with decoders currently being produced (the signal is merely reconfigured to fit the number of channels available in a system).

Laser disc format

Laser discs are now available on the market in large numbers. This means that the recording of different format audio signals on the laser disc raises the important question of compatibility with existing laser discs. Dolby Digital tracks on laser discs record signals using the space of one analog audio channel so it will maintain compatibility with existing discs and players. As shown in the following figure, the digital audio sounds of Dolby Digital discs can be played back as currently done. Analog sounds are played back by using the other channel without the Dolby Digital signals for monaural audio signals.

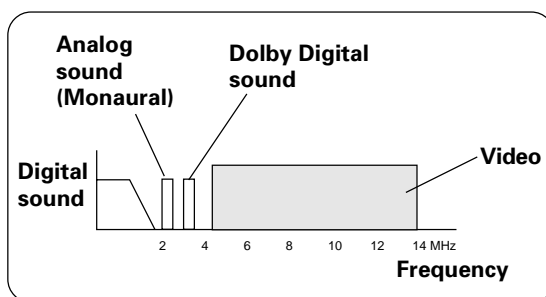

Comparison with Dolby Pro Logic Surround

Dolby Digital is also known as the 5.1 channel system. It is equipped with 5 channels (front left, front right, center, surround left, surround right) in the frequency range from 20 Hz to 20 kHz and an independent Low Frequency Effect (LFE) channel. The subwoofer channel is also called Low Frequency Effect (LFE). The subwoofer channel can be used as desired to enjoy strong bass sounds.

DTS



DTS has been adopted as a sound recording format in the latest movie theaters since the release of "JURASSIC PARK" in 1993, and has a good reputation for high quality sound and dynamic surround effects.

In this system, 6 channels of digital sound are recorded on CD-ROM, rather than on the film. DTS adopts a simultaneous playback format. With a low rate of compression of sound signals and a high rate of transmittance, a higher sound quality format is produced. Also, unlike the process of recording digital sounds on film directly, the only components required are a CD-ROM player as might be used with a personal computer and a DTS processor, and therefore less investment is required than with other formats. For this reason, the format is being introduced in more and more movie theaters, and is being adopted in home movie software (DVD, LD) and music software (5.1 channel CD). DTS has recently added a third surround channel to its system. This has come to be known as DTS Extended Surround or simply DTS-ES.

THX



THX is a Lucasfilm, Ltd. program dedicated to maximum accuracy in movie presentation. Movie sound tracks are recorded in large movie dubbing stages using movie theater equipment. For a sound track to be presented accurately in your home, special technologies are required. In your home the room is much smaller and has a bright sound, the speakers are very different and there are only six-eight of them, plus, you sit much closer to each one of those speakers. Because of these differences we often miss the power and emotion that thrills us in a good movie. Now Pioneer and THX have teamed up to bring the full glory of accurate cinema sound to the comfort and convenience of your home.

Re-Equalization™ : In a theater the room is very large and dead sounding, you sit a long way back from the speakers and the speakers themselves are very specialized. Because a sound track recorded in this dead sounding space when it is played at home it sounds overbright. THX Re-Equalization adjusts for this difference in a very precise way.

Adaptive Decorrelation™ : When a sound track sends mono sound to the surround speakers it often seems to be coming from one side instead of from all around you as it would in a theater. Adaptive Decorrelation helps to correct this inaccuracy.

Timbre Matching™ : When recording a sound track it is very important that the surround sounds move smoothly and seamlessly around the theater. It is very distracting when sounds seem to jump from speaker to speaker. Timbre Matching helps to smooth the movement of the surround sounds even though you are using only two speakers.

Bass Peak Level Manager™ : Some Dolby Digital sound tracks can produce bass peaks that are undesirable in a home theater environment. The Bass Peak Level Manager allows you to set the maximum peak levels appropriate to your system. (Set this function according to the **Bass Peak Level** instructions on page 39.)

Loudspeaker Position Time Synchronization™ : This feature allows you to adjust for the difference in the distance from each individual loudspeaker to the listening position. Doing this ensures that all the speakers operate in precise synchronization improving the seamless nature of the soundfield. (Set this function according to the **Channel Delay** instructions on p.35.)

THX Surround EX™ : THX Surround EX–Dolby Digital Surround EX is a joint development of Dolby Laboratories and the THX division of Lucasfilm Ltd.

In a movie theater, film soundtracks that have been encoded with Dolby Digital Surround EX technology are able to reproduce an extra channel which has been added during the mixing of the program. This channel, called Surround Back, places sounds behind the listener in addition to the currently available front left, front center, front right, surround right, surround left and subwoofer channels. This additional channel provides the opportunity for more detailed imaging behind the listener and brings more depth, spacious ambience and sound localization than ever before.

Movies that were created using the Dolby Digital Surround EX technology, when released into the home consumer market may exhibit a Dolby Digital Surround EX logo on the packaging. A list of movies created using this technology can be found on the Dolby web site at <http://www.dolby.com>.

Only receiver and controller products bearing the THX Surround EX logo, when in the THX Surround EX mode, faithfully reproduce this new technology in the home.

This product may also engage the "THX Surround EX" mode during the playback of 5.1 channel material that is not Dolby Digital Surround EX encoded. In such case the information delivered to the Surround Back channel will be program dependent and may or may not be very pleasing depending on the particular soundtrack and the tastes of the individual listener.

STATION CALL button “memo”

It is recommended that you make a note of the preset stations.

CLASS A	Station No.	*1	*2	*3	*4	*5
	Station Name					
	Frequency					
	Station No.	*6	*7	*8	*9	*0
	Station Name					
	Frequency					
CLASS B	Station No.	*1	*2	*3	*4	*5
	Station Name					
	Frequency					
	Station No.	*6	*7	*8	*9	*0
	Station Name					
	Frequency					
CLASS C	Station No.	*1	*2	*3	*4	*5
	Station Name					
	Frequency					
	Station No.	*6	*7	*8	*9	*0
	Station Name					
	Frequency					

Character display used for station name input:

Character	A	B	C	D	E	F	G	H	I	J	K	L	M	N	O	P	Q
Display indications	A	B	C	D	E	F	G	H	I	J	K	L	M	N	O	P	Q
Character	R	S	T	U	V	W	X	Y	Z	[\]	_	!	0	1	2
Display indications	R	S	T	U	V	W	X	Y	Z	[\]	_	!	0	1	2
Character	3	4	5	6	7	8	9	"	%	&	'	()	*	+	,	-
Display indications	3	4	5	6	7	8	9	"	%	&	'	()	*	+	,	-
Character	.	/	:	=	?	@											
Display indications	.	/	:	=	?	@											

Warning about DTS test mode

The receiver has a mode for PIONEER repairmen to test the DTS sound quality. You will never need to access this mode. Rather, you should be careful NOT to put the receiver in this mode because doing so will erase all your setup parameters like speaker settings, delay settings, channel settings, etc.

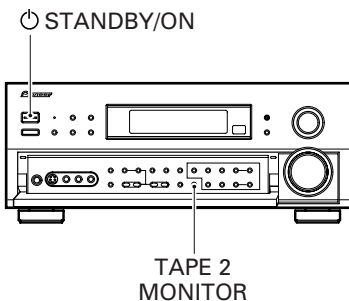

In STANDBY mode, holding the TAPE 2 MONITOR button and pressing the \odot STANDBY/ON button will put the receiver in DTS test mode. Be careful NOT to do this.

The above described method is similar to choosing either PAL or NTSC video setting and choosing 8 Ω or 6 Ω setting so be particularly careful when performing these operations not to accidentally put the receiver in DTS test mode.



If you accidentally put the receiver in DTS test mode, repeat the same procedure (as above) to put the receiver back in a usable mode. After this you will need to reset your setup parameters (speaker settings, delay settings, channel settings, etc.).

Preset Code List

Device	Manufacturer	Code	Device	Manufacturer	Code
DVD	TOSHIBA	001	VCR	CROWN	448, 452, 453
	SONY	002		DAEWOO	448, 452
	PANASONIC	003		DANSAI	453
	JVC	004		DE GRAAF	406
	SAMSUNG	005		DECCA	414,441
	SHARP	006		DUAL	417
	AKAI	007		DUMONT	444, 414, 441
RCA	009	ELCATECH		453	
PIONEER	000, 008	FIDELITY		441	
LD	DENON	110		FINLANDIA	444, 414
	HITACHI	109		FINLUX	406, 444, 414, 441
	PHILIPS	108		FIRSTLINE	405, 409, 411, 424, 453
	RADIOLA	108		FISHER	444
	SONY	101, 102		FRONTECH	452
	TELEFUNKEN	100		FUNAI	441
PIONEER	100, 111	GBC		414	
STB(SAT)	PIONEER	200, 204		GENERAL	452
STB(CATV)	PIONEER	208		GOLDSTAR	411
VCR	PHILIPS	414, 428		GOODMANS	411, 448, 441, 452, 453
	PANASONIC	432, 408		GRAETZ	444, 417
	THOMSON	417, 449, 428		GRANADA	444, 414
	SONY	416, 417, 457, 458, 459		GRANDIENTE	441
	JVC	407, 417, 428		GRANDIN	411, 441, 453
	GRUNDIG	408, 414, 441, 453, 454, 455		HCM	453, 454
	AKAI	442, 417		HINARI	445, 446, 453, 454
	HITACHI	406, 417, 441		HYPSON	453
	TOSHIBA	405, 409, 414, 417, 428		IMPERIAL	441
	MITSUBISHI	407, 409, 414		INTERFUNK	414
	SHARP	402		ITT	442, 444, 417, 428
	ORION	445, 446, 424		ITV	411, 448
	SANYO	444	KAISUI	453	
	FERGUSON	417, 449, 450	KENDO	444, 424	
	BLAUPUNKT	432, 408, 417, 455	KORPEL	453	
	NOKIA	442, 444, 417	LEYCO	453	
	SELECO	417	LOEWE	411, 414	
	AIWA	446, 441	LUXOR	442, 409, 444	
	AKIBA	453	M-ELECTRONIC	441	
	ALBA	446, 447, 448, 452, 424	MANESTH	405, 453	
	AMBASSADOR	452	MARANTZ	414	
	AMSTRAD	441	MATSUI	445, 446, 424	
	ANITECH	453	MEMOREX	444, 411, 441	
	ASA	411, 414	MEMPHIS	453	
	BAIRD	444, 417, 441, 450	METZ	432, 455	
	BASIC LINE	448, 452, 453	MINERVA	455	
	BRANDT	449, 451	MULTITECH	441, 453	
	BRANDT	417	MURPHY	441	
	ELECTRONIQUE		NBC	407, 417	
	BUSH	446, 447, 448, 424, 453	NECKERMANN	414	
	CATRON	452	NESCO	453	
	CGB	441	NORDMENDE	417, 428	
	CIMLINE	453	OCEANIC	417, 441	
	CLATRONIC	452	OSAKI	411, 441, 453	
	CONDOR	452	OTTO VERSAND	414	
			PALLADIUM	411, 417, 453	
			PATHE MARCONI	417	
			PENTAX	406	
			PERDIO	441	

Techno Tidbits & Problem-solving

Device	Manufacturer	Code	Device	Manufacturer	Code
VCR	PHONOLA	414	CD	AKAI	335
	PORTLAND	452		ARCAM	336
	PROLINE	441, 454		ASUKA	337
	PYE	414		AUDIO TON	336
	QUELLE	414		BUSH	332
	RADIOLA	414		CALIFORNIA	304
	REX	417, 428		AUDIO LAB	
	ROADSTAR	411, 448, 453		CYRUS	336
	SABA	417, 449, 428		DENON	309
	SAISHO	445, 424		DUAL	337, 319
	SALORA	442, 409		FISHER	340
	SANSUI	407, 417		GOLDSTAR	330
	SBR	414		GRUNDIG	336
	SCHAUB LORENZ	417, 441		HITACHI	334
	SCHNEIDER	414, 441, 453		INTER SOUND	337
	SEI	414		JVC	331
	SENTRA	452		KENWOOD	310, 311
	SHINTOM	453		KODAK	322
	SIEMENS	444, 411, 455		LINN	336
	SINGER	405		LUXMAN	341
	SINUDYNE	414		M ELECTRONIC	344
	SOLAVOX	452		MARANTZ	304, 336
	SUNSTAR	441		MATSUI	336
	SUNTRONIC	441		MCS	304
	TASHIKO	441		MEMOREX	300
	TATUNG	414, 417, 441		MERIDIAN	336
	TEC	452		MITSUBISHI	335
	TELEAVIA	417		NAD	316
	TELEFUNKEN	417, 449, 451, 428		NAIM	336
TENOSAL	453	ONKYO	342		
TENSAI	441	PANASONIC	304		
THORN	444, 417	PHILIPS	336, 322		
UNIVERSUM	442, 411, 414, 441, 455	QUAD	336		
YAMISHI	453	QUASER	304		
YOKAN	453	ROADSTAR	344		
YOKO	452	ROTEL	336		
PIONEER	400, 443, 407, 414	SABA	319		
		SANYO	340		
		SHARP	343		
DVD Recorder	PIONEER	456		SONY	329, 316
TAPE	AKAI	829		TECHNICS	304, 333
	ARCAM	810		TELEFUNKEN	319
	DENON	810, 827		THOMSON	319
	FISHER	813		UNIVERSUM	336
	GRUNDIG	821		YAMAHA	338, 339
	JVC	802		PIONEER	300
	KENWOOD	804, 807, 822	CD-R	PHILIPS	346
	LUXMAN	815		PIONEER	345
	MARANTZ	821	TV	PHILIPS	631, 607, 634, 656
	MEMOREX	825		SONY	604
	MITSUBISHI	829		GRUNDIG	631, 653
	NAKAMICHI	816		PANASONIC	631, 608, 642, 622
	ONKYO	817, 819		TOSHIBA	605, 653
	PHILIPS	821		TELEFUNKEN	636, 637, 652
	SANSUI	824		SHARP	602
	SHERWOOD	818		SAMSUNG	607, 638, 644, 646
	SONY	814, 823		HITACHI	631, 633, 634, 636, 642, 643, 654, 606
	TANDBERG	820		SABA	631, 636, 642, 651
	TECHNICS	803		BRANDT	636
	TOSHIBA	826, 828		SANYO	635, 645, 648
	YAMAHA	811, 822			
	PIONEER	800, 825			

Techno Tidbits & Problem-solving

Device	Manufacturer	Code	Device	Manufacturer	Code
TV	THOMSON	636, 651, 652	TV	FORMENTI	632, 607, 642
	FERGUSON	607, 636, 651		FRONTECH	631, 642, 646
	NOKIA	632, 642, 652		FRONTECH/ PROTECH	632
	MITSUBISHI	631, 609		FUJITSU	648
	SCHNEIDER	607, 641, 647		FUNAI	640, 646
	GOLDSTAR	607, 650		GBC	632, 642
	BLAUPUNKT	631		GEC	607, 634, 648
	NORDMENDE	632, 636, 651, 652		GELOSO	632, 644
	RADIOLA	607		GENEXXA	631, 641
	JVC	613		GOODMANS	607, 639, 647, 648, 656
	DAEWOO	607, 644, 656		GORENJE	638
	ORION	632, 607, 639, 640		GPM	641
	SIEMENS	631		GRAETZ	631, 642
	ACURA	644		GRANADA	607, 635, 642, 643, 648
	ADMIRAL	631		GRANDIENTE	657
	AKAI	632, 635, 642		GRANDIN	618
	AKURA	641		HANSEATIC	607, 642
	ALBA	607, 639, 641, 644		HCM	618, 644
	AMSTRAD	642, 644, 647		HINARI	607, 641, 644
	ANITECH	644		HISAWA	618
	ASA	645		HUANYU	656
	ASUKA	641		HYPSON	607, 618, 646
	AUDIOGONIC	607, 636		ICE	646, 647
	BASIC LINE	641, 644		IMPERIAL	638, 642
	BAUR	631, 607, 642		INDIANA	607
	BEKO	638		INGELEN	631
	BEON	607		INTERFUNK	631, 632, 607, 642
	BLUE SKY	641		INTERVISION	646, 649
	BLUE STAR	618		ISUKAI	641
	BPL	618		ITC	642
	BTC	641		ITT	631, 632, 642
	BUSH	607, 641, 642, 644, 647, 656		JEC	605
	CASCADE	644		KAISUI	618, 641, 644
	CATHAY	607		KAPSCH	631
	CENTURION	607		KENDO	642
	CGB	642		KENNEDY	632, 642
	CIMLINE	644		KORPEL	607
	CLARIVOX	607		KOYODA	644
	CLATRONIC	638		LEYCO	607, 640, 646, 648
	CONDOR	638		LIESENK&TTER	607
	CONTEC	644		LUXOR	632, 642, 643
	CROSLEY	632		M ELECTRONIC	631, 644, 645, 654, 655, 656
	CROWN	638, 644		M-ELECTRONIC	607, 636, 651
	CRYSTAL	642		MAGNADYNE	632, 649
	CYBERTRON	641		MAGNAFON	649
	DAINICHI	641		MANESTH	639, 646
	DANSAI	607		MARANTZ	607
	DAYTON	644		MARK	607
	DECCA	607, 648		MATSUI	607, 639, 640, 642, 644, 647, 648
	DIXI	607, 644		MCMICHAEL	634
	DUMONT	653		MEDIATOR	607
	ELIN	607		MEMOREX	644
ELITE	641	METZ	631		
ELTA	644	MINERVA	631, 653		
EMERSON	642	MULTITECH	644, 649		
ERRES	607	NECKERMANN	631, 607		
FINLANDIA	635, 643, 655				
FINLUX	632, 607, 645, 648, 653, 654, 655				
FIRSTLINE	640, 644				
FISHER	632, 635, 638, 645				

Techno Tidbits & Problem-solving

Device	Manufacturer	Code	Device	Manufacturer	Code	
TV	NEI	607, 642	TV	SONOLOR	631, 635	
	NIKKAI	605, 607, 641, 646, 648		SONTEC	607	
	NOBLIKO	649		SOUNDWAVE	607	
	OCEANIC	631, 632, 642		STANDARD	641, 644	
	OSAKI	641, 646, 648		STERN	631	
	OSO	641		SUSUMU	641	
	OSUME	648		SYSLINE	607	
	OTTO VERSAND	631, 632, 607, 642		TANDY	631, 641, 648	
	PALLADIUM	638		TASHIKO	634	
	PANAMA	646		TATUNG	607, 648	
	PATHO CINEMA	642		TEC	642	
	PAUSA	644		TELEAVIA	636	
	PHILCO	632, 642		TELETECH	644	
	PHOENIX	632		TENSAI	640, 641	
	PHONOLA	607		THORN	631, 607, 642, 645, 648	
	PROFEX	642, 644		TOMASHI	618	
	PROTECH	607, 642, 644, 646, 649		TOWADA	642	
	QUELLE	631, 632, 607, 642, 645, 653		ULTRAVOX	632, 642, 649	
	R-LINE	607		UNIVERSUM	631, 607, 638, 642, 645, 646, 654, 655	
	RBM	653		VESTEL	607	
	REDIFFUSION	632, 642		VOXSON	631	
	REX	631, 646		WALTHAM	643	
	ROADSTAR	641, 644, 646		WATSON	607	
	SAISHO	639, 644, 646		WATT RADIO	632, 642, 649	
	SALORA	631, 632, 642, 643		WHITE	607	
	SAMBERS	649		WESTINGHOUSE		
	SBR	607, 634		YOKO	607, 642, 646	
	SCHAUB	642		PIONEER	672, 631, 632, 607, 636, 642, 651	
	LORENZ					
	SEG	642, 646		MD	SONY	901
	SEI	632, 640, 649			KENWOOD	903
	SELECO	631, 642			SHARP	902
	SIAREM	632, 649			TEAC	904
SINUDYNE	632, 639, 640, 649		ONKYO	905		
SKANTIC	643		DENON	906		
SOLAVOX	631		PIONEER	900, 902, 907(DAT)		
SONOKO	607, 644	TUNER	PIONEER	500		

Troubleshooting

Incorrect operations are often mistaken for trouble and malfunctions. If you think that there is something wrong with this component, check the points below. Sometimes the trouble may lie in another component. Investigate the other components and electrical appliances being used. If the trouble cannot be rectified even after exercising the checks listed below, ask your nearest PIONEER authorized service center or your dealer to carry out repair work.

Symptom	Cause	Remedy
The power does not turn ON.	<ul style="list-style-type: none"> The power plug is disconnected. The protection circuit may have been activated. 	<ul style="list-style-type: none"> Connect the power plug to the wall outlet. Disconnect the power plug from the outlet, and insert again.
The unit does not respond when the buttons are pressed.	<ul style="list-style-type: none"> Static electricity caused by dry air. 	<ul style="list-style-type: none"> Disconnect the power plug from the outlet, and insert again.
No sound is output when a function is selected.	<ul style="list-style-type: none"> Improper connections. Sound is muted. The volume is turned down. The TAPE 2 MONITOR is ON. Speakers are turned OFF. DIGITAL/ANALOG switch is set incorrectly. 	<ul style="list-style-type: none"> Make sure the component is connected correctly (see p.12-21). Press MUTE on the remote control. Adjust MASTER VOLUME. Press the TAPE 2 MONITOR button. Press SPEAKERS (A/B) to select the speakers you connected. Set SIGNAL SELECT (see p.48).
No image is output when a function is selected.	<ul style="list-style-type: none"> Improper connections. The input source is not properly selected. 	<ul style="list-style-type: none"> Make sure the component is connected correctly (see p.15-18). Press the correct function button.
Considerable noise in radio broadcasts.	<ul style="list-style-type: none"> Incorrect frequency. The antenna is not connected. RF and/or digital cables are near the antenna terminals and wires. 	<ul style="list-style-type: none"> Tune in the correct frequency. Connect the antenna (see p.18). Route RF and digital cables away from the antenna terminals and wires.
	<p>FM broadcasts</p> <ul style="list-style-type: none"> The FM antenna is not fully extended or is poorly positioned. Weak radio signals. 	<ul style="list-style-type: none"> Fully extend the FM wire antenna, position for best reception, and secure to a wall. Connect an outdoor FM antenna (see p.18).
	<p>AM broadcasts</p> <ul style="list-style-type: none"> The AM antenna is poorly positioned. Weak radio signals. Interference caused by other equipment (fluorescent lamp, motor, etc.). 	<ul style="list-style-type: none"> Adjust the direction and position for best reception. Connect an additional internal or external AM antenna (see p.18). Turn off the equipment causing the noise or move it away from the receiver. Place the antenna farther away from the equipment causing the noise.
Broadcast stations cannot be selected automatically.	<ul style="list-style-type: none"> Weak radio signals. 	<ul style="list-style-type: none"> Connect an outdoor antenna (see p.18).
Subwoofer output is very low.	<ul style="list-style-type: none"> Settings route signal away from sub woofer. 	<ul style="list-style-type: none"> To get more signal to the subwoofer set it to PLUS or choose SMALL for the FRONT speakers (see p.33-34).
When playing an LD the SIGNAL SELECT is on RF but there is still no sound.	<ul style="list-style-type: none"> The LD is not a Dolby Digital compatible disc. 	<ul style="list-style-type: none"> Set the SIGNAL SELECT to analog (make sure your LD player is hooked up with analog connections in addition to digital and RF connections, see p.14).
When playing a Dolby Digital / DTS source the 5.1 Channel indicator doesn't light.	<ul style="list-style-type: none"> The Dolby Digital / DTS source is not 5 channels. 	<ul style="list-style-type: none"> There is no problem with the receiver but if you want 5 channel sound you must play a 5 channel source.

Techno Tidbits & Problem-solving

Symptom	Cause	Remedy
No sound from surround or center speakers.	<ul style="list-style-type: none"> • Speaker settings are incorrect. • The rear and/or center levels are turned down. • The surround and/or center speakers are disconnected. 	<ul style="list-style-type: none"> • See "SPEAKER SETTING" on p.33-34 to check the speaker settings. • See "CHANNEL LEVEL" p.36-37 to check the speaker levels. • Connect the speakers (see p.19).
Sound is produced from some components, but not from digital components.	<ul style="list-style-type: none"> • SIGNAL SELECT is set incorrectly. • The digital inputs are assigned incorrectly, or not at all. 	<ul style="list-style-type: none"> • Set SIGNAL SELECT to "AUTO" or according to the type of connections made (see p.48). • Set the digital input settings correctly (see p.32).
No sound is output or a noise is output when software with DTS is played back.	<ul style="list-style-type: none"> • SIGNAL SELECT is set to "ANALOG". • A DVD player not compatible with DTS is used, or the setting of the DVD player is incorrect. • The digital output level has been turned down on a CD player or other component equipped with digital output level adjustment capability. (The DTS signal has been altered by the player, and cannot be read.) • The speakers are turned OFF. 	<ul style="list-style-type: none"> • Make digital connections (see p.13) and set SIGNAL SELECT to "AUTO" (see p.48). • Refer to the instruction manual supplied with the DVD player. • Set the digital volume level of the player to full, or to the neutral position. • Turn the speakers ON.
The sound is output intermittently when software with DTS is played back.	<ul style="list-style-type: none"> • Disc being played back has a huge amount of information on it. 	<ul style="list-style-type: none"> • Use the STANDARD mode to get the best results (see p.45).
When a search is performed by a DTS compatible CD player during playback, noise is output.	<ul style="list-style-type: none"> • The search function performed by the player interferes with the reading of digital information. 	<ul style="list-style-type: none"> • This is not a malfunction, but be sure to turn the volume down to prevent the output of loud noise from your speakers.
Cannot be remote controlled.	<ul style="list-style-type: none"> • The remote control batteries have worn out. • Too far away or bad angle of operation. • There is an obstacle between the receiver and the remote control. • Strong light such as fluorescent light is shining onto the unit's remote control signal light-receiving window. • A cord is connected to the CONTROL IN terminal on this unit. • The IR -Receiver type is mismatched with the setting. 	<ul style="list-style-type: none"> • Replace the batteries (see p.9). • Operate within 7 m, 30° of the remote sensor on the front panel (see p.10). • Remove the obstacle or operate from another position. • Avoid exposing the remote sensor on the front panel to direct light. • Connect cord to the correct jack. • Disconnect the IR Receiver from the rear panel, and set to the other IR Receiver type using the remote control.
The display is dark.	<ul style="list-style-type: none"> • The FL DIMMER button is pushed. 	<ul style="list-style-type: none"> • Press FL DIMMER on the front panel repeatedly to return to the default setting (see p.53).
The OVER indicator is constantly lit.	<ul style="list-style-type: none"> • If you are using an analog source, the signal is too strong. 	<ul style="list-style-type: none"> • Press the INPUT ATT button (see p.22).
When playing a Dolby Digital / DTS format LD there is noise audible on the soundtrack.	<ul style="list-style-type: none"> • If you are using a digital source, there is too much information for the receiver to handle. • The SIGNAL SELECT is on ANALOG. 	<ul style="list-style-type: none"> • For DD/DTS sources put the receiver in STANDARD mode (see p.45). • Set the SIGNAL SELECT to DIGITAL.

Techno Tidbits & Problem-solving

Symptom	Cause	Remedy
You can't get DIGITAL to come up when using the SIGNAL SELECT button.	<ul style="list-style-type: none"> • Either the digital connections or the DIGITAL IN SELECT choices are incorrect. • The TAPE2 MONITOR mode is ON. 	<ul style="list-style-type: none"> • Make sure the digital connections and the DIGITAL IN SELECT choices are done correctly. • Press the TAPE2 MONITOR button so it goes into the OFF setting.
When using THX AUTO mode the receiver is not playing in the EX mode.	<ul style="list-style-type: none"> • You are not using a source with Surround EX flag. 	<ul style="list-style-type: none"> • There is no problem with your receiver but if you want to hear 7 channel sound use an Surround EX source.
The Dolby Digital / DTS indicator doesn't light up even when playing a Dolby Digital / DTS source.	<ul style="list-style-type: none"> • The player is paused or stopped. • There is a mistake in the player settings for audio output. • Although it's a Dolby Digital / DTS source there is a possibility the present track is not Dolby Digital / DTS. 	<ul style="list-style-type: none"> • Play the source. • Fix the audio settings (check the manual that came with your DVD player). • There is no problem. The indicator won't light when the track is not a Dolby Digital / DTS track.

If the unit does not operate normally due to external effects such as static electricity

Disconnect the power plug from the outlet and insert again to return to normal operating conditions.

Specifications

Amplifier Section

Continuous Power Output (STEREO MODE)
FRONT 110 W + 110 W (DIN 1 kHz, THD 1 %, 8 Ω)
Continuous Power Output (SURROUND MODE)
FRONT 110 W + 110 W (DIN 1 kHz, THD 1 %, 8 Ω)
CENTER 110 W (DIN 1 kHz, THD 1 %, 8 Ω)
SURROUND 110 W + 110 W
(DIN 1 kHz, THD 1 %, 8 Ω)
Rated Power Output 100 W + 100 W
(20 Hz to 20 kHz, THD 0.09 %, 8 Ω)

- Above specifications are applicable when the power supply is 230V.

Audio Section

Input (Sensitivity/Impedance)
PHONO MM 4.7 mV/47 k Ω
VCR 1/DVR, VCR 2, DVD/LD, TV/SAT, VIDEO, CD,
MD/TAPE 1/CD-R, TAPE 2 335 mV/47 k Ω
Frequency Response
PHONO MM 20 Hz to 20 kHz \pm 0.3 dB
VCR 1/DVR, VCR 2, DVD/LD, TV/SAT, VIDEO, CD,
MD/TAPE 1/CD-R, TAPE 2 5 Hz to 100,000 Hz \pm ₃⁰ dB
Output (Level/Impedance)
VCR 1/DVR REC, VCR 2 REC, MD/TAPE 1/CD-R REC,
TAPE 2 REC 335 mV/1 k Ω
Tone Control
BASS \pm 6 dB (100 Hz)
TREBLE \pm 6 dB (10 kHz)
LOUDNESS +10 dB (100 Hz/10 kHz)
Signal-to-Noise Ratio (IHF, short circuited, A network)
PHONO MM 80 dB
VCR 1/DVR, VCR 2, DVD/LD, TV/SAT, VIDEO, CD,
MD/TAPE 1/CD-R, TAPE 2 101 dB
Signal-to-Noise Ratio [DIN Rated/50mW]
PHONO MM 68/61 dB
VCR 1/DVR, VCR 2, DVD/LD, TV/SAT, VIDEO, CD,
MD/TAPE 1/CD-R, TAPE 2 92/65 dB
Phono Overload Level (T.H.D. 0.1%, 1 kHz)
PHONO MM 120 mV

Video Section

Input (Sensitivity/Impedance) 1 V_{p-p}/75 Ω
Output (Level/Impedance) 1 V_{p-p}/75 Ω
Signal-to-Noise Ratio 65 dB
Frequency Response 5 Hz to 10 MHz \pm ₃⁰ dB

Component Video Section

Input (Sensitivity) 1 V_{p-p}/75 Ω
Output (Level/Impedance) 1 V_{p-p}/75 Ω
Signal-to-Noise Ratio 65 dB

FM Tuner Section

Frequency Range 87.5 MHz to 108 MHz
Usable Sensitivity Mono: 15.2 dBf, IHF (1.6 μ V/75 Ω)
50 dB Quieting Sensitivity Mono: 20.2 dBf
Stereo: 41.2 dBf
Sensitivity (DIN) Mono: 1.1 μ V (S/N 26 dB)
Stereo: 50 μ V (S/N 46 dB)
Signal-to-Noise Ratio Mono: 76 dB (at 85 dBf)
Stereo: 72 dB (at 85 dBf)
Signal-to-Noise Ratio (DIN) Mono: 62 dB
Stereo: 58 dB
Distortion Stereo: 0.6 % (1 kHz)
Alternate Channel Selectivity 70 dB (400 kHz)
Stereo Separation 40 dB (1 kHz)
Frequency Response 30 Hz to 15 kHz (\pm 1dB)
Antenna Input 75 Ω unbalanced

AM Tuner Section

Frequency Range 531 kHz to 1.602 kHz
Sensitivity (IHF, Loop antenna) 350 μ V/m
Selectivity 30 dB
Signal-to-Noise Ratio 50 dB
Antenna Loop antenna

Miscellaneous

Power Requirements
UK model AC 230 V, 50/60 Hz
European model AC 220 - 230 V, 50/60 Hz
Power Consumption 400 W
Power Consumption in Standby mode 1.0 W
AC Outlets (except for the UK model)
SWITCHED (\times 2) Total 100 W MAX.
UNSWITCHED 100 W MAX.
Dimensions 420 (W) \times 173 (H) \times 470 (D) mm
Weight (without package) 16.2 kg

Furnished Parts

FM wire antenna 1
AM loop antenna 1
"AA" IEC LR6 batteries 2
Remote control unit 1
Operating Instructions 1

NOTE:

Specifications and the design are subject to possible modifications without notice, due to improvements.



Published by Pioneer Corporation.
Copyright © 2000 Pioneer Corporation.
All rights reserved.

PIONEER CORPORATION 4-1, Meguro 1-Chome, Meguro-ku, Tokyo 153-8654, Japan
PIONEER ELECTRONICS [USA] INC. P.O. BOX 1540, Long Beach, California 90801-1540, U.S.A.
PIONEER ELECTRONICS OF CANADA, INC. 300 Allstate Parkway, Markham, Ontario L3R 0P2, Canada
PIONEER EUROPE NV Haven 1087, Keetberglaan 1, B-9120 Melsele, Belgium TEL: 03/570.05.11
PIONEER ELECTRONICS AUSTRALIA PTY. LTD. 178-184 Boundary Road, Braeside, Victoria 3195, Australia, TEL: [03] 9586-6300
PIONEER ELECTRONICS DE MEXICO S.A. DE C.V. San Lorenzo 1009 3er Piso Desp. 302 Col. Del Valle Mexico D.F. C.P. 03100
TEL: 5-688-52-90

Free Manuals Download Website

<http://myh66.com>

<http://usermanuals.us>

<http://www.somanuals.com>

<http://www.4manuals.cc>

<http://www.manual-lib.com>

<http://www.404manual.com>

<http://www.luxmanual.com>

<http://aubethermostatmanual.com>

Golf course search by state

<http://golfingnear.com>

Email search by domain

<http://emailbydomain.com>

Auto manuals search

<http://auto.somanuals.com>

TV manuals search

<http://tv.somanuals.com>