

**Pioneer** *sound.vision.soul*

**AUDIO/VIDEO MULTI-CHANNEL  
RECEIVER**

**VSX-D2011-S**

**VSX-D2011-G**

Operating Instructions

## IMPORTANT



The lightning flash with arrowhead symbol, within an equilateral triangle, is intended to alert the user to the presence of uninsulated "dangerous voltage" within the product's enclosure that may be of sufficient magnitude to constitute a risk of electric shock to persons.

### CAUTION

**RISK OF ELECTRIC SHOCK  
DO NOT OPEN**

#### CAUTION:

TO PREVENT THE RISK OF ELECTRIC SHOCK, DO NOT REMOVE COVER (OR BACK). NO USER-SERVICEABLE PARTS INSIDE. REFER SERVICING TO QUALIFIED SERVICE PERSONNEL.



The exclamation point within an equilateral triangle is intended to alert the user to the presence of important operating and maintenance (servicing) instructions in the literature accompanying the appliance. **H002\_En**

**NOTE:** THE NO USER-SERVICEABLE PARTS COMPARTMENT WARNING IS LOCATED ON THE APPLIANCE BONNET

Thank you for buying this Pioneer product. Please read through these operating instructions so you will know how to operate your model properly. After you have finished reading the instructions, put them away in a safe place for future reference.

**WARNING:** THE APPARATUS IS NOT WATERPROOF, TO PREVENT FIRE OR SHOCK HAZARD, DO NOT EXPOSE THIS APPLIANCE TO RAIN OR MOISTURE AND DO NOT PUT ANY WATER SOURCE NEAR THIS APPARATUS, SUCH AS VASE, FLOWER POT, COSMETICS CONTAINER AND MEDICINE BOTTLE ETC. **H001A\_En**

**WARNING:** BEFORE PLUGGING IN THE UNIT FOR THE FIRST TIME, READ THE FOLLOWING SECTION CAREFULLY. THE VOLTAGE OF THE AVAILABLE POWER SUPPLY DIFFERS ACCORDING TO COUNTRY OR REGION, BE SURE THAT THE POWER SUPPLY VOLTAGE OF THE AREA WHERE THIS UNIT WILL BE USED MEETS THE REQUIRED VOLTAGE (E.G., 230V OR 120V) WRITTEN ON THE REAR PANEL. **H041\_En**

**WARNING:** NO NAKED FLAME SOURCES, SUCH AS LIGHTED CANDLE, SHOULD BE PLACED ON THE APPARATUS. IF NAKED FLAME SOURCES ACCIDENTALLY FALL DOWN, FIRE SPREAD OVER THE APPARATUS THEN MAY CAUSE FIRE. **H044\_En**

This product is for general household purposes. Any failure due to use for other than household purposes (such as long-term use for business purposes in a restaurant or use in a car or ship) and which requires repair will be charged for even during the warranty period. **K041\_En**

#### CAUTION:

THE **OFF** / **ON** BUTTON IS SECONDARY CONNECTED AND THEREFORE DOES NOT SEPARATE THE UNIT FROM MAINS POWER IN **OFF** POSITION. THEREFORE INSTALL THE UNIT SUITABLE PLACES EASY TO DISCONNECT THE MAINS PLUG IN CASE OF THE ACCIDENT. THE MAINS PLUG OF UNIT SHOULD BE UNPLUGGED FROM THE WALL SOCKET WHEN LEFT UNUSED FOR A LONG PERIOD OF TIME. **H017B\_En**

### POWER-CORD CAUTION

S002 En

Handle the power cord by the plug. Do not pull out the plug by tugging the cord and never touch the power cord when your hands are wet as this could cause a short circuit or electric shock. Do not place the unit, a piece of furniture, etc., on the power cord, or pinch the cord. Never make a knot in the cord or tie it with other cords. The power cords should be routed such that they are not likely to be stepped on. A damaged power cord can cause a fire or give you an electrical shock. Check the power cord once in a while. When you find it damaged, ask your nearest PIONEER authorized service center or your dealer for a replacement.

*This product complies with the Low Voltage Directive (73/23/EEC, amended by 93/68/EEC), EMC Directives (89/336/EEC, amended by 92/31/EEC and 93/68/EEC).* **H015A\_En**

## Installing the Receiver

**VENTILATION:** When installing this unit, make sure to leave space around the unit for ventilation to improve heat radiation (at least 60 cm at top, 10 cm at rear, and 30 cm at each side).

**WARNING:** Slot and openings in the cabinet are provided for ventilation and to ensure reliable operation of the product and to protect it from overheating, to prevent fire hazard, the openings should never be blocked and covered with items, such as newspapers, tablecloths, curtains, etc. Also do not put the apparatus on the thick carpet, bed, sofa, or fabric having a thick pile. **H040\_En**

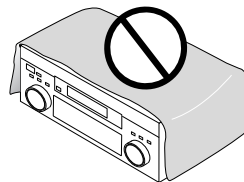

# TWO VOLTAGE SELECTOR SWITCHES (multi-voltage model only)

Only multi-voltage model is provided with these switches. Mains voltages in Saudi Arabia are 127 V and 220 V only. Never use this model with the 110 V setting in Saudi Arabia.

Only multi-voltage model is provided with this(these) switch(es). European models are not provided with these switches.

The line voltage selector switches are on the rear panel. Check that they are set properly before plugging the power cord into the household wall socket. If the voltage is not properly set or if you move to an area where the voltage requirements differ, adjust the selector switches as follows.

1. Use a medium-size screwdriver.
2. First, insert the screwdriver in the groove of the larger voltage selector, and adjust so that the tip of the groove points to the voltage value of your area.
3. Next, insert the screwdriver in the groove of the smaller voltage selector and adjust until the voltage is the same as at the larger one.

## TWO VOLTAGE SELECTORS

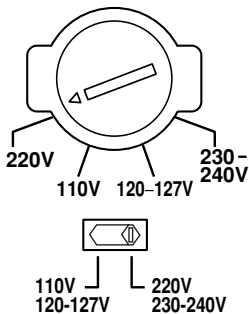

**CAUTION 220 V**  
Power source voltage is factory adjusted 220 volts. If your area is different, change voltage selectors settings.

## Operating Environment

Operating environment temperature and humidity: +5°C – +35°C (+41°F – +95°F); less than 85%RH (cooling vents not blocked)

Do not install in the following locations

- Location exposed to direct sunlight or strong artificial light
- Location exposed to high humidity, or poorly ventilated location

H045 En

### [For European model]

If the socket outlets on the associated equipment are not suitable for the plug supplied with the product, the plug must be removed and an appropriate one fitted. Replacement and mounting of an AC plug on the power supply cord of this unit should be performed only by qualified service personnel. The cut-off plug must be disposed of as an electrical shock hazard could exist if connected to a socket outlet.

H022AEn

**NOTE:** This equipment has been tested and found to comply with the limits for a Class B digital device, pursuant to Part 15 of the FCC Rules. These limits are designed to provide reasonable protection against harmful interference in a residential installation. This equipment generates, uses, and can radiate radio frequency energy and, if not installed and used in accordance with the instructions, may cause harmful interference to radio communications. However, there is no guarantee that interference will not occur in a particular installation. If this equipment does cause harmful interference to radio or television reception, which can be determined by turning the equipment off and on, the user is encouraged to try to correct the interference by one or more of the following measures:

- Reorient or relocate the receiving antenna.
- Increase the separation between the equipment and receiver.
- Connect the equipment into an outlet on a circuit different from that to which the receiver is connected.
- Consult the dealer or an experienced radio/TV technician for help.

H010 En

### Information to User

Alteration or modifications carried out without appropriate authorization may invalidate the user's right to operate the equipment.

H011 En

### CAUTION:

This product satisfies FCC regulations when shielded cables and connectors are used to connect the unit to other equipment. To prevent electromagnetic interference with electric appliances such as radios and televisions, use shielded cables and connectors for connections.

H012 En

# Table of Contents

<b>Features .....</b>	<b>6</b>	<b>Displays &amp; Controls .....</b>	<b>28</b>
<b>Before You Start .....</b>	<b>7</b>	Front Panel .....	28
Checking the Supplied Accessories .....	7	Remote Control .....	30
Preparing the Remote Control .....	7	Display .....	33
Loading the batteries .....	7	Back Panel .....	34
Remote Control Battery Indicator .....	7	<b>Setting Up for Surround Sound .....</b>	<b>36</b>
Operating range of remote control unit .....	8	SURRBACK SYSTEM (Surround Back System) .....	37
Installing the Receiver .....	8	QUICK setup .....	38
Opening the Front Panel .....	8	NORMAL setup .....	39
Switching video system between PAL and NTSC (if necessary) .....	8	SPEAKER SETTING .....	40
		CHANNEL LEVEL (channel balance) .....	42
		CHANNEL DELAY .....	43
<b>Easy Setup Guide Part 1 .....</b>	<b>9</b>	<b>Basic Operation .....</b>	<b>44</b>
Home Theater: The Basics .....	9	Stereo and Multichannel Playback .....	44
1) Your Home System .....	9	Switching ANALOG/DIGITAL Signal Input .....	45
2) The Source Material .....	9	Listening Modes .....	46
3) The Listening Modes .....	9	STEREO modes .....	46
Conclusion .....	9	MOVIE modes (SURROUND mode) .....	47
1 Hooking Up Your DVD Player & TV .....	10	MUSIC modes (SURROUND mode) .....	48
Digital Connections .....	10	Adjusting the Effect of a Listening Mode .....	49
2 Speaker Connections .....	11	Adding/Adjusting the Effect in	
3 Setting up the Main Unit .....	12	Dolby Pro Logic II Music Mode .....	49
4 Assigning the Digital Inputs .....	12	Listening with ACOUSTIC CALIBRATION EQ .....	50
		Reducing Noise During Playback	
		(DIGITAL NR Function) .....	50
		Listening in MIDNIGHT Mode .....	51
		Listening in LOUDNESS Mode .....	51
		Adjusting Bass and Treble (TONE CONTROL) .....	52
		Listening in HI-BIT/SAMPLING mode .....	53
		DVD-Audio/MULTI CHANNEL IN Playback .....	53
		SB CH MODE button .....	54
		SB CH MODE .....	54
		VIRTUAL SURROUND BACK Mode .....	54
		DUAL MONO setting and Playback .....	55
		Using Headphones .....	55
		Video Select .....	56
		Adjusting the Brightness of the Display	
		(DIMMER) .....	56
<b>Easy Setup Guide Part 2 .....</b>	<b>13</b>	<b>Using the Tuner .....</b>	<b>57</b>
1 Auto Surround Sound Setup .....	13	Automatic and Manual Tuning .....	57
2 Playing a DVD with Surround Sound .....	15	MPX Mode .....	57
		RF ATT Mode (European model only) .....	57
		Channel Step Setting (multi-voltage model only) ...	58
		To Change Channel Steps	
		(multi-voltage model only) .....	58
		Direct Access Tuning .....	58
		Memorizing Frequently Used Stations .....	59
		Naming Memorized Stations .....	60
		Recalling Memorized Stations .....	61
<b>Connecting Your Equipment .....</b>	<b>16</b>		
Connecting your TV .....	16		
Component Video Input Default Settings .....	16		
Connecting Video Components .....	17		
Connecting a DVD player .....	17		
Connecting VCRs or DVRs .....	18		
Connecting a Video Component			
to the Front Panel .....	18		
Connecting Satellite TV(SAT) Components .....	19		
Connecting Analog Audio Components .....	20		
Connecting to the Multi Channel Analog Inputs			
(DVD-Audio or Super Audio CD (SACD) compatible			
player) .....	21		
Connecting Digital Audio Components .....	22		
Digital Input Default Settings .....	23		
Connecting the Radio Antennas .....	24		
Using outdoor antennas .....	24		
Connecting Speakers .....	25		
Speaker impedance .....	26		
Placing Your Speakers .....	27		
Speaker placement .....	27		
AC Power Cord .....	27		
AC Outlet [switched 100W max]			
(European model only) .....	27		

An introduction to RDS (European model only) ..... 62  
 Using the RDS display ..... 62  
 Searching for RDS programs  
 (European model only) ..... 63  
 Basics of EON (Enhanced Other Network  
 information) (European model only) ..... 64  
 Using EON (European model only) ..... 64  
 Clearing all stations from  
 the RDS or EON search (European model only) ..... 65

**Remote Control of Other  
 Components ..... 66**

Setting Up the Remote Control to Control Other  
 Components ..... 66  
 Recalling Settings Stored in the  
 Remote Control ..... 66  
 Programming Signals from Other Remote  
 Controls (LEARNING Mode) ..... 68  
 Using Remote Control with Other Components .... 70  
 CD/MD/CD-R/VCR/DVD/LD/DVD recorder/ Cassette  
 Deck operations ..... 70  
 Cable TV/Satellite TV/ Digital TV/ TV operations  
 ..... 71  
 Setting up the DIRECT FUNCTION ..... 72

**Using Other Functions ..... 73**

Recording from Audio/Video Components ..... 73  
 SECOND ZONE (Speaker System B)  
 /FRONT BI-AMP Setup ..... 74  
 Stereo playback in another room  
 (SECOND ZONE) ..... 74  
 Bi-amping the front speakers  
 (FRONT BI-AMP) ..... 74  
 A/B Speaker Button ..... 75  
 Setting up and Using the USB Audio Connection .... 76  
 Connecting Additional Amplifiers ..... 78  
 The PIONEER SR System: Operating other PIONEER  
 components ..... 79  
 Multi Operations ..... 80  
 Performing multi operations ..... 81  
 SYSTEM OFF ..... 82  
 Using SYSTEM OFF ..... 83  
 Editing Remote Control Display Names ..... 84  
 Editing Buttons Names (KEY LABEL) ..... 85  
 Adjusting the Light on the Remote Control ..... 86  
 Clearing Remote Control Settings You Have Input .. 87  
 Resetting the Main Unit ..... 88

**Fine Tuning Your System ..... 89**

Other System Settings ..... 89  
 THX CINEMA Setup ..... 90  
 Assigning the Digital Inputs ..... 91  
 Assigning the Component Video Inputs ..... 92  
 FUNCTION RENAME ..... 93  
 PHONO/LINE Setup ..... 94  
 Expert Setup ..... 95  
 CROSSOVER NETWORK ..... 96  
 FINE CHANNEL LEVEL ..... 97  
 FINE CHANNEL DELAY ..... 98  
 ACOUSTIC CAL EQ ..... 99  
 BASS PEAK LEVEL ..... 102  
 DYNAMIC RANGE CONTROL ..... 103

**Techno Tidbits & Problem-solving... 104**

Dolby ..... 104  
 Dolby Digital ..... 104  
 Dolby Pro Logic II ..... 104  
 Dolby Digital Surround EX ..... 105  
 DTS ..... 105  
 DTS ..... 105  
 DTS-ES ..... 105  
 DTS Neo:6 ..... 105  
 DTS 96/24 ..... 105  
 THX ..... 106  
 Schemata of Setup Screens ..... 107  
 Speaker Placement Information ..... 108  
 Troubleshooting ..... 110  
 Preset Code Brands ..... 115  
 Specifications (European model) ..... 117  
 Specifications (multi-voltage model) ..... 118

# Features

## High Quality, Balanced Multichannel Design

The VSX-D2011 receiver is constructed with Pioneer's industry-leading advanced and well balanced multichannel Features concept. This means it is designed to reproduce music and movie soundtracks as close as possible to the intentions of the producer during mastering. The receiver uses a revolutionary 3-D Frame Construction technique and a Symmetrical Power Train Design, with high-performance Advanced Direct Energy MOS-FET output devices, generating 100 watts of power for 7 independent channels.

## Multichannel Acoustic Calibration EQ System (MCACC)

In order to make setting up as easy as possible for users we have created the MCACC system. This unique and convenient way of getting good surround sound from the receiver makes trouble-free set up a snap. With the microphone plugged into the front panel the MCACC system creates a monitoring environment to establish the parameters of the sound for the specific room you are using. The MCACC system adjusts the parameters to establish excellent surround sound effects and offer you the best in home theater for the minimum of effort.

## Dolby Digital EX, DTS-ES, DTS 96/24 and the Latest Audio and Video Formats

The VSX-D2011 is equipped with Dolby Digital EX decoding, the very latest Dolby Digital contribution to home theater with surround back speakers in addition to surround speakers. These additional speakers make home theater even more realistic and powerful. Naturally, you can also play all existing audio formats, including the recently developed Dolby Pro Logic II and DTS-ES Extended Surround formats on the VSX-D2011 as well. On the video side, the component video output is fully compatible with high definition, progressive-scan digital video (720p).

*Lucasfilm and THX are trademarks or registered trademarks of Lucasfilm, Ltd. & TM. Surround EX is a jointly developed technology of THX and Dolby Laboratories, and is a trademark of Dolby Laboratories. All rights reserved. Used under authorization.*

*Manufactured under license from Dolby Laboratories. "Dolby", "Pro Logic", "Surround EX" and double-D symbol are trademarks of Dolby Laboratories.*

*"DTS", "DTS-ES Extended Surround" and "Neo:6" are trademarks of Digital Theater Systems, Inc.*

## Universal Player Compatibility (DVD Audio/Super Audio CD [SACD])

This receiver incorporates the latest technology and is able to handle cutting edge audio formats, like DVD Audio and Super Audio CD (SACD) which are just hitting the market. Its high compatibility offers a variety of inputs to decode all types of sources at the highest possible quality. The receiver's multichannel input connections lets you hook up eight discrete channels of audio.

## USB Audio Hooks up

The USB Audio port is a future-oriented connector that allows you to hook a USB-compatible PC to the receiver.

## Audio Scaler (HI BIT/HI SAMPLING)

This new technology enables the user to hear CD and DVD, as well as other soundtracks at a wider dynamic range, allowing for finer audio reproduction. This Audio Scaler approximates the audio of high end formats just becoming available now.

## LCD Illuminated Remote Control

This self-illuminating remote control simplifies operation even in a darkened home theater room. Preset codes for other equipment and a learning function make it possible to use the remote control to operate products from other manufacturers. The full range of receiver functions can be controlled using the remote.

## The Energy-saving Design

The European model is designed to use 0.7 W of energy when the receiver is in standby mode, while the multi-voltage model is designed to use 0.9 W.

# Before You Start

## Checking the Supplied Accessories

Please check that you have received all of the following supplied accessories.



AM Loop Antenna



FM Wire Antenna

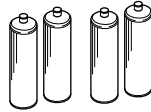

"AA" IEC LR6  
batteries x 4

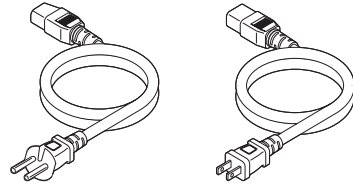

AC Power Cord x 2  
(multi-voltage model only)



Remote Control Unit

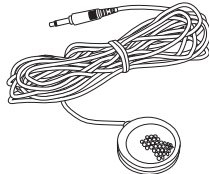

Microphone for Auto  
Surround Sound Setup

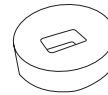

Microphone Stand for Auto  
Surround Sound Setup

Operating  
Instructions



Multi-voltage model has two power cords. These accessories will be different depending on the country of purchase. Please use the correct cord for your country.

## Preparing the Remote Control

### Loading the batteries

Load the batteries into the remote control as shown below. Please use alkaline batteries. When you notice a decrease in the operating range, replace all batteries with new ones.

1

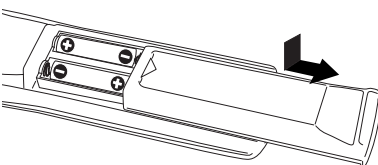

2

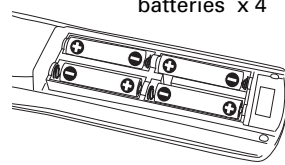

"AA" IEC LR6  
batteries x 4

3

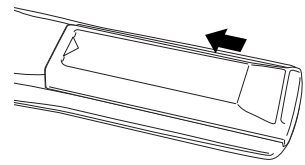

### CAUTION!

Incorrect use of batteries may result in such hazards as leakage and bursting. Observe the following precautions.

- Never use new and old batteries together.
- Insert the plus and minus sides of the batteries properly according to the marks in the battery case.
- Batteries with the same shape may have different voltages. Do not use different batteries together.
- When disposing of used batteries, please comply with governmental regulations or environmental public institution's rules that apply in your country or area.

### Remote Control Battery Indicator

When the batteries get too weak to operate the remote control properly an indicator warning screen will appear on the remote. Change the batteries as shown above. This must be done within five minutes or all your remote control settings will be cleared.

Shows when the batteries are getting weak

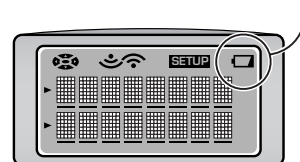

## Before You Start

### Operating range of remote control unit

The area in which you can use the remote control to operate the VSX-D2011 is fairly large. To use, point the remote control toward the remote sensor on the front panel of this unit while within the range shown below.

Remote control may not function properly if:

- There are obstacles between the remote control and the remote sensor.
- Direct sunlight or fluorescent light is shining onto the remote sensor.
- The receiver located near a device emitting infrared rays.
- Operated simultaneously with another remote control which uses infrared rays.

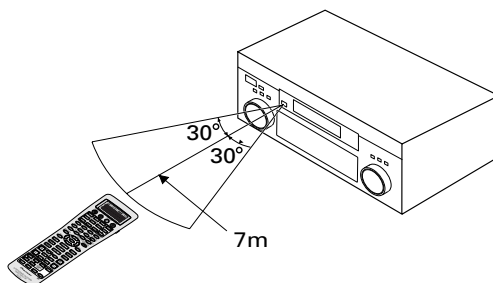

## Installing the Receiver

### CAUTION!

- Do not cover this unit in any way, for example with a sheet or piece of cloth. This would prevent proper heat dispersal.
- Do not place any object directly on top of this unit. This also would prevent proper heat dispersal.

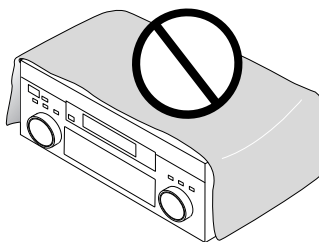

## Opening the Front Panel

To open the front panel push gently on the lower third of the panel with your finger.

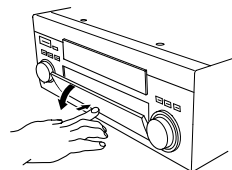

## Switching video system between PAL and NTSC (if necessary)

This receiver is able to use two types of video systems for its OSD (on screen display) either PAL or NTSC. If you don't match the system on the amplifier with your home system no OSD will appear on your TV. The default setting is PAL. If you use this system you don't need to make any settings here. People with multi-system TVs don't need to worry about changing the setting either. If necessary, follow the instructions below to switch the type of video system.

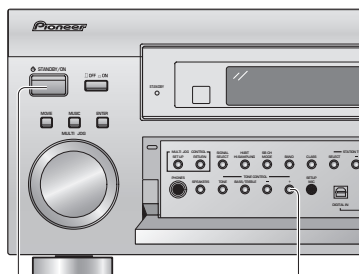

### 1 Put the receiver in the STANDBY mode.

### 2 While holding down the TONE + button press the STANDBY/ON button.

The video system type will change depending on the state the receiver was previously in. The new type, either PAL or NTSC, will appear in the display. It will be shown for about seven seconds and then the receiver returns to normal operating mode.

To change the video system type again repeat steps 1 and 2.



# Easy Setup Guide Part1

## Home Theater: The Basics

Most consumers are used to using stereo equipment to listen to music but many people are not used to home theater systems that give you many more options when listening to soundtracks. In fact, home theater is not really complicated and this little guide should give you an understanding of the basics. Home theater refers to the use of multiple audio tracks combined with multiple speakers to create a surround sound effect.

There are three different factors involved in getting surround sound. Each contribute to what kind of sound you get.

These factors are:

- 1) The equipment you are using for your home theater setup. Particularly important is the number of speakers you are using. We call this your speaker configuration.
- 2) The source material you are using. This is the actual product (like a DVD) or broadcast (like cable TV) you are listening to/watching. We call this the source.
- 3) The last factor is the listening mode you choose on the VSX-D2011 receiver. These are explained below and in subsequent chapters but most likely the PRO LOGIC II MOVIE for movies and the PRO LOGIC II MUSIC for music will be fine.

Let's start with the home theater setup you have in your home.

### 1) Your Home System

The heart of your system is the VSX-D2011 receiver and it is very flexible in getting you theater-like surround sound. You can use this receiver with anywhere from two to seven speakers (front left, front right, center, surround left and right, and surround back left and right) and a subwoofer to get home theater surround sound. We recommend you use seven speakers and a subwoofer. If this is not possible follow the instructions in "Auto Surround Setup" in the "Easy Setup Guide Part 2" and you will still be able to get good surround sound. Also, a DVD player is essential for home theater and you can also hook up satellite or cable TV tuner to this receiver and get a more home theater-like sound from these sources.

### 2) The Source Material

DVDs have become the basic source material for home theater because they are convenient to use and offer excellent sound and picture quality as well as allow users to enjoy home theater soundtracks with more than two channels of audio. For example, Dolby Pro Logic plays back four channels (front left, front right, center and a single channel for both surround speakers), Dolby Digital and DTS sources usually have six discrete channels (front left, front right, center, surround left and right and a channel that powers the subwoofer) of sound. Since the subwoofer channel is only for bass sounds it is expressed as .1 of a channel and this multichannel setup has been named 5.1 channel sound.

It is important you consult the manual that came with your DVD player as well to make sure the player is outputting a surround soundtrack and all the other settings are appropriate for your home theater.

### 3) The Listening Modes

This receiver has many different listening modes and they are designed to cover all the speaker configurations and types of sources you might be using. In general, the PRO LOGIC II MOVIE listening mode is the easiest way to get realistic surround sound for movies. For music the basic listening mode for music is PRO LOGIC II MUSIC.

To listen to music in stereo simply choose the STEREO listening mode. Other possibilities (like listening to a stereo CD with all seven speakers or taking a stereo source and getting multichannel home theater-like sound) are explained in listening modes (pages 46-48).

### Conclusion

These are the three basic factors that contribute to your home theater sound. The easiest thing is to hook up seven speakers and a subwoofer and simply play your DVDs with PRO LOGIC II MOVIE listening mode. This will give you realistic and enjoyable home theater sound. First hook up your equipment, like your DVD player, TV and speakers. Then follow the Easy Setup Guide instructions to set up your system for surround sound. It is very important you do one of the surround sound setups to get optimal sound from your receiver.

For more details on any of the information presented here check the main section of the manual.

## Easy Setup Guide Part 1

Before making or changing the connections, switch off the power and disconnect the power cord from the AC outlet.

### 1 Hooking Up Your DVD Player & TV

In order to use Dolby Digital/DTS soundtracks, which are at the heart of home theater, you need to hook up your DVD player with digital audio connections. You can do this by either a coaxial or an optical connection, **you don't need to do both**. The quality of these two types of connections is the same but since some DVD players only have one type of digital terminal you need to figure out which yours has and hook it up to the appropriate terminal on the receiver. In order to do this you will need the proper cable. For coaxial connections you can use a regular RCA video cord or the specially-made coaxial cords, they have the same type of plugs. For optical connections you will need a special optical cable which you can buy at your local stereo store. For more information on cords and cables see page 23. You should also hook up your DVD player with analog audio connections. Use regular RCA stereo cords for these connections. Also hook up the video connection on your DVD player, and your TV to this receiver. For your TV it's easiest to use a regular composite (RCA) video cord, as shown below. It is important that you hook up your TV (or monitor) in order to see a video image as well as the on screen displays (OSDs) shown by this receiver (for more on this see page16).

#### Digital Connections

Some DVD players have both coaxial and optical terminals, but there is no need to connect both. If your DVD player has a coaxial terminal (not a PCM-only output) for the audio out hook it up using this terminal. Follow the diagram below. This is the best scenario, as you will be able to follow the default settings of this receiver and won't need to assign the digital inputs (you should use DIGITAL IN 3).

If your DVD player only has an optical terminal for the audio output you can hook it up using one of the DIGITAL IN terminals between 1-2 (for example, DIGITAL IN 2). In this case, you will need to assign the digital input (which means tell the receiver which input you used for your DVD digital audio). See page 12 for this.

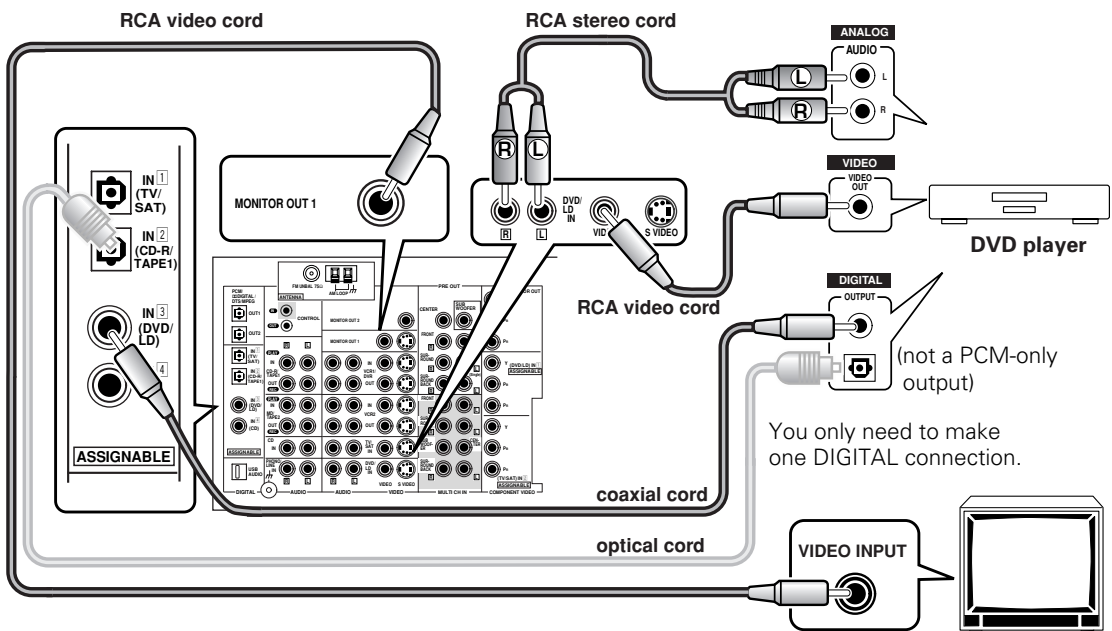

## 2 Speaker Connections

Home theater is designed to be setup with five, or seven speakers (front left & right; center; surround left & right; and, optimally, surround back left & right) and a subwoofer, but you can use this receiver with fewer speakers. Hook up the speakers you have to the A speaker terminals on the back of the receiver. If you only have two speakers hook them up as FRONT. If you have three hook up the single speaker as CENTER. Follow the diagram below in order to hook up all your speakers. A center speaker is very important for watching films because in digital soundtracks the dialog comes from the center speaker. If you do not have a center speaker you must tell the receiver the center channel is off or when you listen to digital soundtracks you won't hear any dialog. This can be done automatically by following the AUTO SURROUND SOUND SETUP instructions from page 13 in this Easy Setup Guide.

If possible, use surround back speakers. These speakers are important to take full advantage of all the sound channels on new, eight channel home theater DVDs. The diagram below also explains how to hook up a subwoofer which provides realistic bass sounds. For the subwoofer use a mono (single plug) RCA cord and for the other speakers use regular speaker cords. **See pages 108–109 for advice on speaker placement.** Make sure you connect the speaker on the right to the R terminal and the speaker on the left to the L terminal. Also make sure the positive and negative (+/-) terminals on the receiver match those on the speakers.

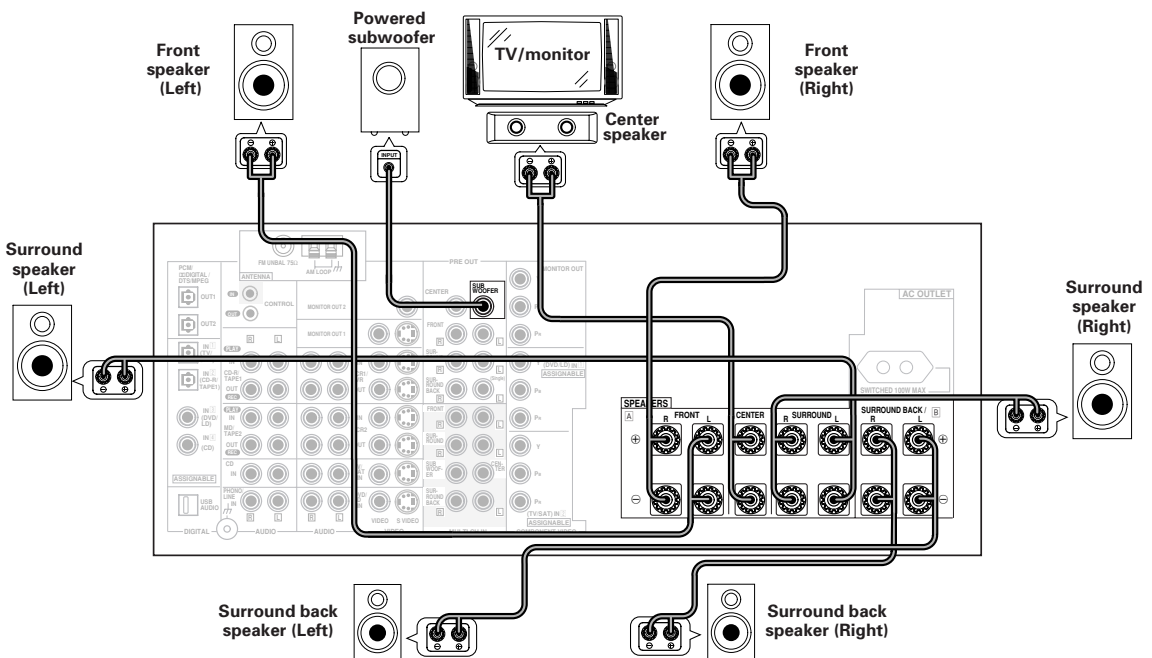

- We recommend speakers with a nominal impedance rated 8 Ω-16 Ω, but you can change the speaker impedance setting of the receiver (see page 26).
- If you only have one surround back speaker hook it up to the left surround back terminal.
- If you use a THX certified subwoofer use the THX INPUT jack on the subwoofer (if your subwoofer has one) or switch the filter position to THX on your subwoofer.
- When you attached your speaker wire to the speaker terminal make sure that not even one strand of wire touches the back of the receiver. If this happens it could short out the receiver.

### ■ Speaker terminals

- ① Twist exposed wire strands together tightly.
- ② Loosen speaker terminal and insert exposed wire.
- ③ Tighten terminal.

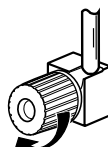
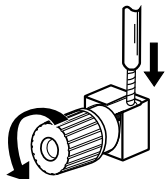
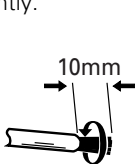

### 3 Setting up the Main Unit

- 1 Plug the AC power cord into a wall outlet.
- 2 Press the **OFF/ON** button to put the receiver in ON mode.
- 3 Press the **STANDBY/ON** button to switch the receiver ON.

### 4 Assigning the Digital Inputs

This is only necessary if you did not hook up your DVD player to DIGITAL IN [3] using a coaxial cable but rather connected it to one of the optical digital inputs. The following example shows how to assign the DIGITAL IN [2] jack to DVD. Use the arrow buttons (▲▼) and the ENTER button on the remote control to navigate the on-screen display (OSD) on your TV. Conversely, you can use the MULIT JOG dial and ENTER button, and look at the display, on the Front Panel.

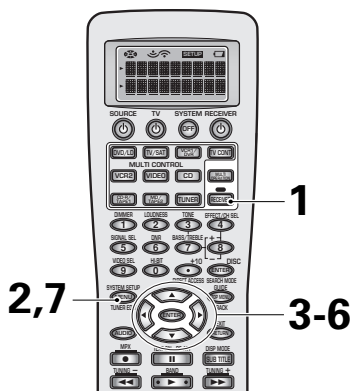

**1 Turn on the receiver and your TV, press the RECEIVER button on the remote control.**

**2 Press the SYSTEM SETUP button.**

The SYSTEM SETUP menu appears on your TV (if it doesn't, refer to page 10 to make sure you have properly connected the receiver to your TV).

**3 Looking at the on-screen display on your TV, use the ▲▼ buttons to select INPUT ASSIGN. Press the ENTER button.**

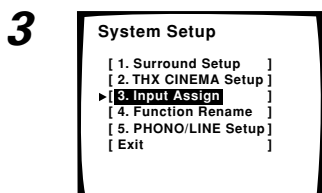

**4 DIGITAL IN-SELECT should be selected, if not use the ▲▼ buttons to select it. Press the ENTER button.**

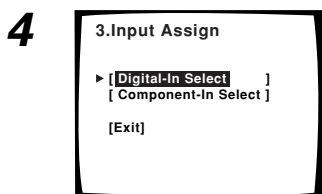

**5 Use the ▲▼ buttons to select DIGITAL-2 and press ENTER.**

The default setting for the DIGITAL-2 jack is CD-R.

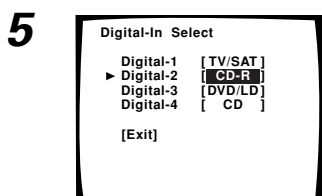

**6 Use the ▲▼ buttons to select DVD/LD and press ENTER.**

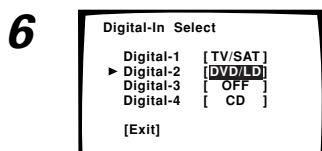

**7 Press the SYSTEM SETUP button.**

The receiver exits the setup process.

## 1 AUTO SURROUND SOUND SETUP

If setting up your surround sound speakers seems like it's going to be an involved task you only need to use this quick, automatic method, known as the MCACC system, to achieve good surround sound. You'll need to hook up the microphone so that the receiver can hear and judge the distance, size, sound character and sound pressure level of the speakers and thus know what settings to make. First turn the volume down, then plug the microphone into the SETUP MIC jack on the front panel of the receiver and put the microphone into its stand. If you have a tripod you can affix the mic stand to it. Follow the step-by-step guide to setting up your surround sound below. This will customize the surround sound for your listening environment. If you want to personalize your surround sound setups by making the settings manually go to "Setting up for Surround Sound" (starting on page 36) and "Expert setup" (starting on page 95). Make sure all the components you need, especially speakers, have been properly connected before you do the steps described here. Use the arrow buttons (▲▼) and the ENTER button on the remote control to navigate the on-screen display (OSD) on your TV. Conversely, you can use the MULTI JOG dial and ENTER button, and look at the display, on the Front Panel.

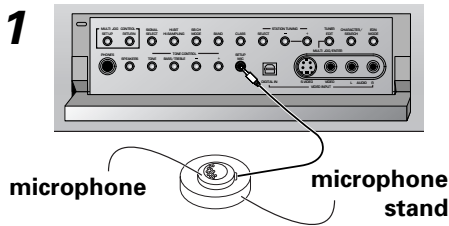

**1 Hook up the microphone to the SETUP MIC jack on the Front Panel.**

**2 Place the microphone at your normal listening position.**

Use a table, chair or something else to put the microphone at the same height as you usually listen to your system from.

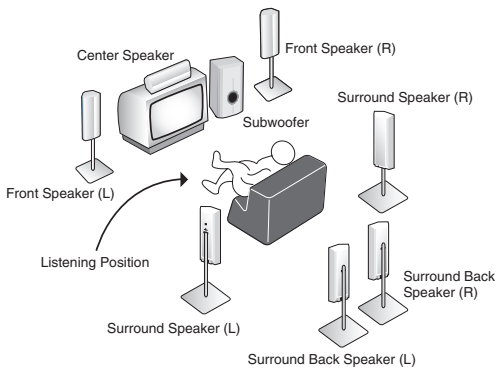

**3 Switch on the receiver and your TV.**

Make sure your TV is set to this receiver as you will use the on-screen displays (OSDs) on your TV to follow these instructions.

**4 If you have a subwoofer turn it on.**

**5 Press the RECEIVER button on the remote control.**

**6 Press the SYSTEM SETUP button and use the on-screen display (OSD) that appears on your TV.**

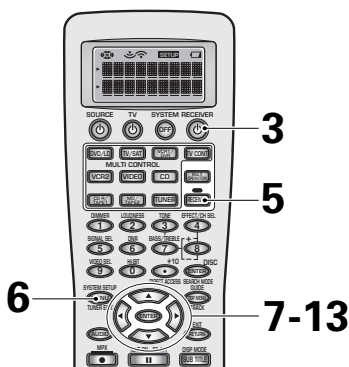

**7 The arrow should be pointing at SURROUND SETUP, press ENTER.**

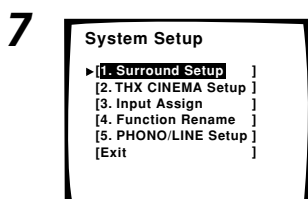

8

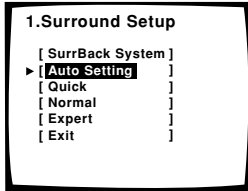

10

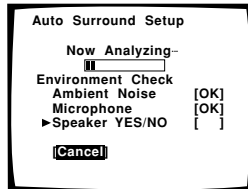
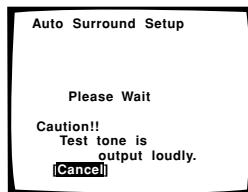
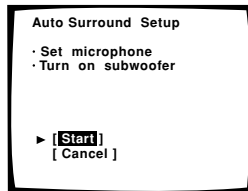

11

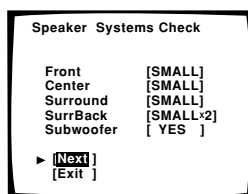
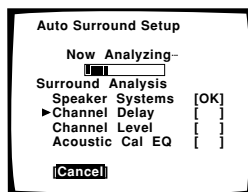
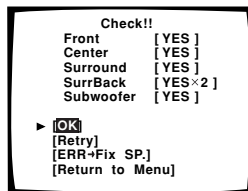

8 Select **AUTO SETTING** with the ▲▼ buttons and press **ENTER**.

9 Some auto setup instructions will be listed, make sure to follow them.

Make sure you have: hooked up the microphone and moved obstacles to the speakers out of the way. If you have a subwoofer make sure it is turned on and has the volume turned up.

**WARNING:** The test tones are very loud!! Make sure there are no infants or small children in the room and that no one who will be scared, upset or injured by loud noise is present. You yourself may want to wear earplugs. It is possible to lower the volume of test tones, but this could result in incorrect speaker settings.

10 If you have followed all setup instructions and warnings above make sure that the arrow is pointed to **START** and press **ENTER**. Be prepared for loud test tones.

Try to be as quiet as possible after hitting **ENTER**. The test tones may take up to 30 seconds.

The volume automatically increases to 0 dB, then the system will output some test tones and establish ambient noise levels, the microphone status, and what speakers you hooked up.

11 Check the speaker settings on the OSD

If they match your speaker configuration make sure **OK** is selected and press **ENTER**. The test tones will be output loudly again. The test tones may take up to 5 minutes this time.

After it has finished, you see the **SPEAKER SYSTEMS CHECK** screen. If you want to view the settings select **NEXT** and press **ENTER** repeatedly. If not, simply go to step 13.

If they do not match the speaker configuration you hooked up and you want to try again select **RETRY** with ▲▼ buttons and press **ENTER**. Follow the instructions above from step 10.

If you get an error message instructing you to do something, follow the instructions and **RETRY** with ▲▼ buttons and press **ENTER**.

If the speaker settings do not match the speaker configuration you connected and you want to input the settings manually select **ERR→FIX SP** with the ▲▼ buttons, press **ENTER**. Go to step 12.

If you see an **ERR** message in the right side column, there may be a problem with the speaker connection. If selecting **RETRY** doesn't fix the problem, turn off the power and check the speaker connections.



- Make sure the room environment follows the guidelines displayed on the OSD during auto setup. If the room environment is not optimal for auto setup (too much ambient noise, obstacles blocking the speakers from the microphone, etc.) the final settings may be incorrect. Check for household appliances (air conditioner, fridge, fan, etc.) that may be affecting the environment and switch them off if necessary.
- Screens will turn off after three minutes and the receiver will automatically exit from the setup process.
- If you leave CHECK!! or other error message on the screen for three minutes, or you choose CANCEL at anytime during the setup, the settings made up to that point will be cleared.
- After completing the AUTO SURROUND SOUND SETUP, ACOUSTIC CAL EQ ON (ALL CH ADJUST) is set automatically.
- Some older TVs may interfere with the operation of the mic. If this is the case turn the TV off when doing AUTO SURROUND SOUND SETUP.

## 12 Use the ▼▲ buttons to select a speaker press ENTER. Then use the ▼▲ buttons to select the size of each speaker individually. Press ENTER. Use the ▼▲ buttons to select OK and press ENTER.

The system will output another series of test tones to establish the proper channel level, channel delay and acoustic calibration EQ. Again, be prepared for loud test tones.

After it has finished, you see the SPEAKER SYSTEMS CHECK screen. If you want to view the settings select **NEXT** and press **ENTER** repeatedly. If not, simply go to the next step.

## 13 Select RETURN and press ENTER to go back to the SYSTEM SETUP menu. Then choose EXIT to complete the auto surround sound setup and return to normal use.

You should now have settings that will give you good surround sound. The MCACC indicator will light and the surround sound settings are complete.

## 2 Playing a DVD with Surround Sound

### 1 Make sure the receiver, your TV, your subwoofer and your DVD player are switched ON.

### 2 Press the DVD/LD button on the remote control.

You should see DVD/LD in the display on the receiver.

### 3 Play a DVD then adjust the MASTER VOLUME.



To get a more refined sound, make the sound settings in "Expert setup" (see page 95).

If you're having trouble getting surround sound playback look at this Frequently Asked Questions (FAQ) guide:

**Q1:** Even though I'm playing a DVD I'm not getting 5.1 channel playback.

**A1:** Either the DVD is not set for digital output, or the Dolby Digital/DTS output settings are not correct.

Set the DVD player to output a digital signal and set the Dolby Digital and DTS output properly. If you are unsure how to do this check the DVD initial setup in the manual that came with your DVD player.

**Q2:** There is no sound from the subwoofer or it is very low.

**A2:** There is a good possibility you haven't reached a part of the DVD that has an LFE channel (which feeds the subwoofer) yet. The LFE channel only appears in selected parts of the soundtrack. Continue playing and listen for the subwoofer.

If you want to hear more sound from the subwoofer set it to PLUS (see page 40 for more information and consult the memo on page 41).

# Connecting Your Equipment

## Connecting your TV

Before making or changing the connections, switch off the power and disconnect the power cord from the AC outlet.

Connect your TV to the jacks as shown below. Hook up with either component video, S video, or composite video cords (the quality descends in this order) **but you must use the same type of video cords to hook up your DVD player (and all other video components) as you use to hook up your TV.** If you plan to hook up your DVD player with component video cords hook up your TV with them as well but in this case you must also hook up your TV with composite video or S video cords because you won't be able to see the receiver's on-screen displays with a component video hook up. Composite video cords, which look just like regular RCA audio cords (see page 20) but have only one cable are the most common.

In order to set up the receiver use MONITOR OUT 1 so that you can see the on-screen displays.

\*The arrows indicate the direction of the signal.

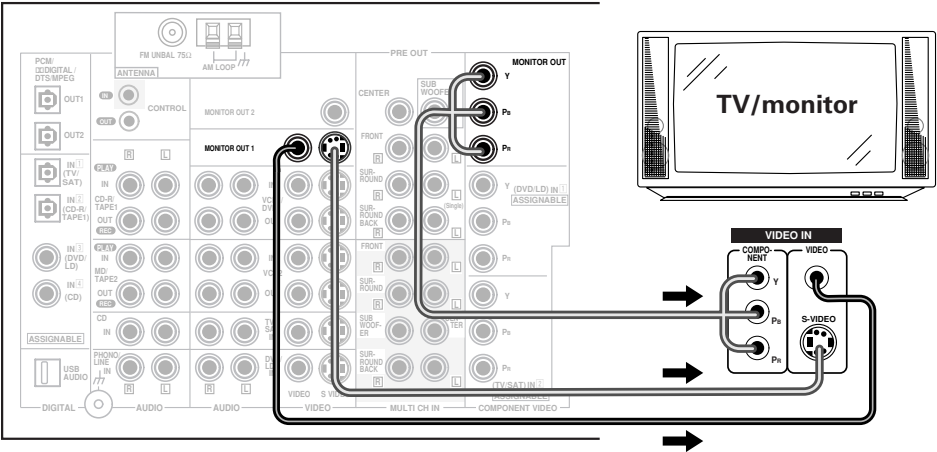

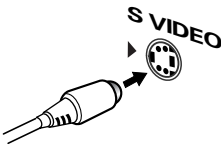
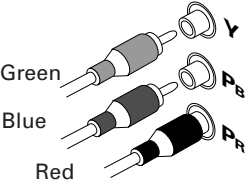
S Video	Component video
 <p>S video cables produce clearer picture reproduction by sending separate signals for the luminance and the color.</p>	 <p>The video signal is divided into the luminance (Y) signal and the color (PB and PR) signals. In this way, interference between the signals is avoided.</p>

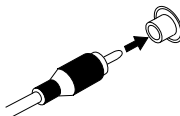
Composite Video
 <p>Composite video cords are the most common or standard video cord but also the lowest quality. The color on the connector is yellow to distinguish it from regular RCA audio cords which have white and red connectors (see page 20). It is important to use a true composite video cord and not an audio cord (though they look exactly the same) because the impedance is different and this will affect the picture quality.</p>

### Component Video Input Default Settings

If you use component video cords to hook up your video equipment it is easiest to do so following the default settings, which are listed below. Remember you must use component video cords from your video source (for example, a DVD player) to the receiver and from the receiver to your TV (or monitor). If you don't follow the default settings below you must assign the inputs you used with the "Assigning the Component Video Inputs" procedure. See page 92 to do this.

- The default settings are:
- COMPONENT VIDEO IN 1: DVD/LD
- COMPONENT VIDEO IN 2: TV/SAT



## Connecting Video Components

Before making or changing the connections, switch off the power and disconnect the power cord from the AC outlet.

Connect your video components as shown on this and the following page. For video components (for example, a DVD player) there are two types of connections to make, video and audio.

**Hook up your video signal with either component video, S video or composite video cords (the quality descends in this order) but you must use the same type of cord as you used to hook up your TV.**

For the audio signal, in order to use digital soundtracks like Dolby Digital or DTS you must hook up a digital input, with either a coaxial or optical cord (see pages 22 & 23). It is also a good idea to hook up your components with analog audio connections as well.

If you want to record from your DVD player composite (or S video) cord connections and analog audio connections are necessary.

### Connecting a DVD player

Before making or changing the connections, switch off the power and disconnect the power cord from the AC outlet.

Hook up your audio signal with either a coaxial or optical digital cords (you don't need to do both). If you hook up your DVD/LD player using component video cable connections you might need to setup your DVD player for component video output as well. See your DVD manual for details. If you have a DVD-Audio or Super Audio CD (SACD) compatible player, see "Connecting to the Multi Channel Analog Inputs" on page 21.

You need to hook up your audio with analog connections as well.

\*The arrows indicate the direction of the signal.

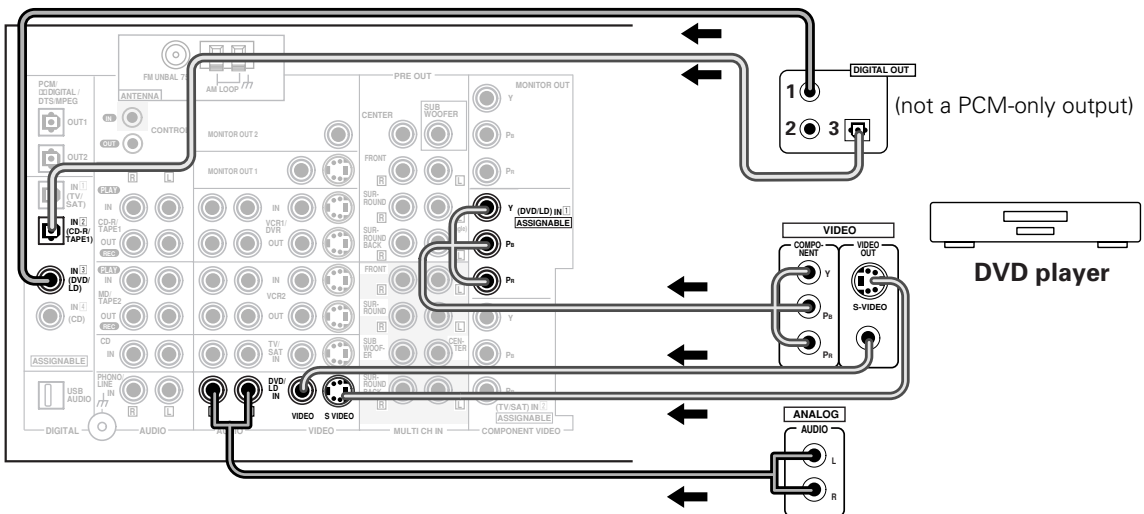

- Be sure to make either a digital coaxial or digital optical connection (pictured as DIGITAL jack 3 or DIGITAL jack 2 in this diagram) but you don't need to make both.
- If your digital connections are different than the default settings you will need to assign the digital jacks to the proper component(s) with the "Assigning the Digital Inputs" procedure. See page 91 to do this.
- If your component video connections are different from the default settings, you will need to assign them with "Assigning the Component Video Inputs". See page 92 to do this.

## Connecting Your Equipment

### Connecting VCRs or DVRs

Before making or changing the connections, switch off the power and disconnect the power cord from the AC outlet.

Connect the video out of your VCR/DVR using either S video or composite video cords, depending on how you connected the receiver to your TV (see page 16). Use analog audio cords for the audio signal. To record, you also need to connect a set of audio/video outputs from the receiver to the audio/video inputs on your VCR/DVR. Note that to record video from a source component, the video connection from the source to the receiver and from the receiver to the recorder must be the same type.

\*The arrows indicate the direction of the signal.

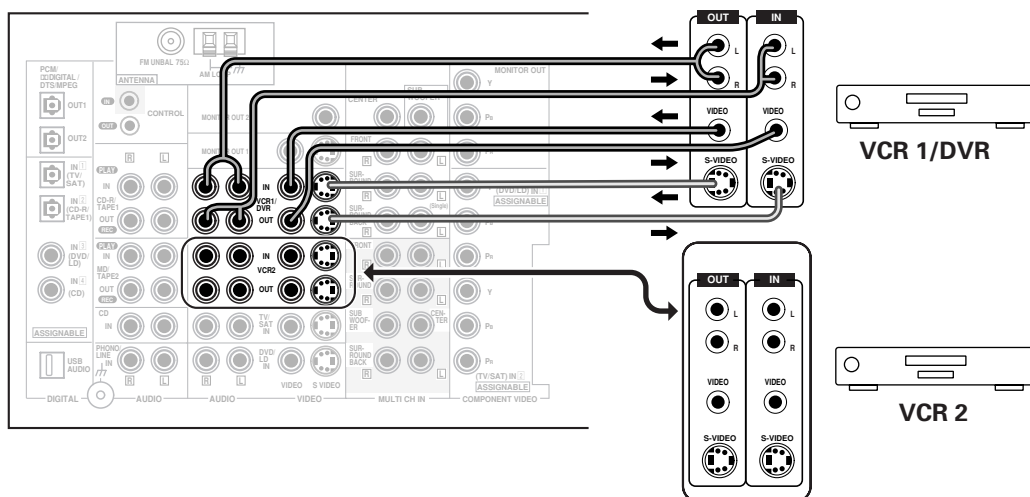

### Connecting a Video Component to the Front Panel

Connect a portable DVD player, video game console or any video component to the front panel as show here. Front video connections are accessed via the front panel input selector as VIDEO.

\*The arrows indicate the direction of the signal.

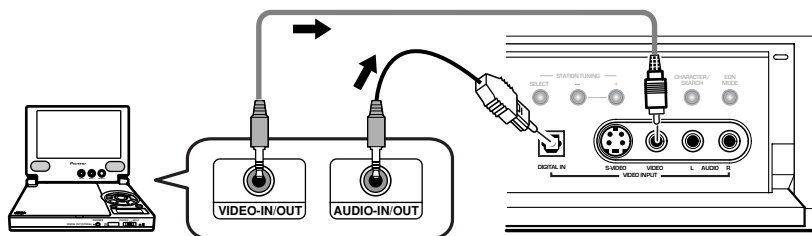

Be careful! For portable DVD players you will need a specialized optical cord (for the audio) that has a mini optical plug on one end and a regular optical plug on the other.



You cannot assign the digital input on the front panel. If you want to learn more about this process see "Assigning the Digital Inputs" on page 91.

## Connecting Satellite TV (SAT) Components

Before making or changing the connections, switch off the power and disconnect the power cord from the AC outlet.

Hook up the video signal with either component video, S video, or composite video cords, depending on how you connected the receiver to your TV (see page 16).

For the audio signal, in order to use digital soundtracks broadcast you must hook up a digital input. Use either a coaxial or optical cable, it doesn't matter which (see pages 22-23). We recommend hooking up your audio with analog cables as well (see below).

\*The arrows indicate the direction of the TV signal.

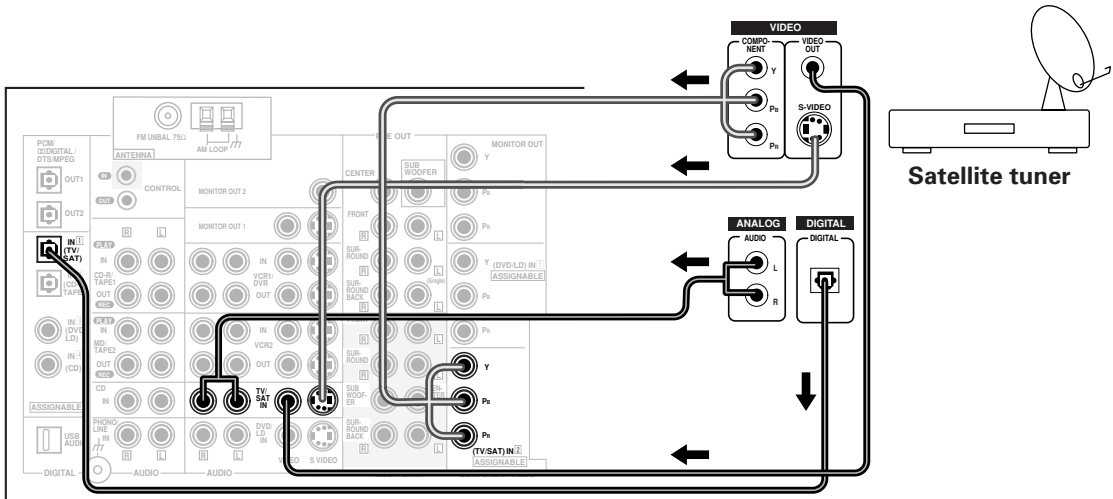

- If your component video connections are different from the default settings, you will need to assign them with "Assigning the Component Video Inputs". See page 92 to do this.
- If your digital connections are different than the default settings you will need to assign the digital jacks to the proper component(s) with the "Assigning the Digital Inputs" procedure. See page 91 to do this.

# Connecting Analog Audio Components

Before making or changing the connections, switch off the power and disconnect the power cord from the AC outlet.

Connect your audio components to the jacks as shown below. These are all analog connections and your analog audio components (turntable, cassette deck) use these jacks. Remember that for components you want to record with you need to hook up four plugs (a set of stereo ins and a set of stereo outs), but for components that only play (like a turntable) you only need to hook up one set of stereo plugs (two plugs). If you want to record to/from digital components (like a CD-R) to/from analog components you must hook up your digital equipment with these analog connections.

\*The arrows indicate the direction of the audio signal.

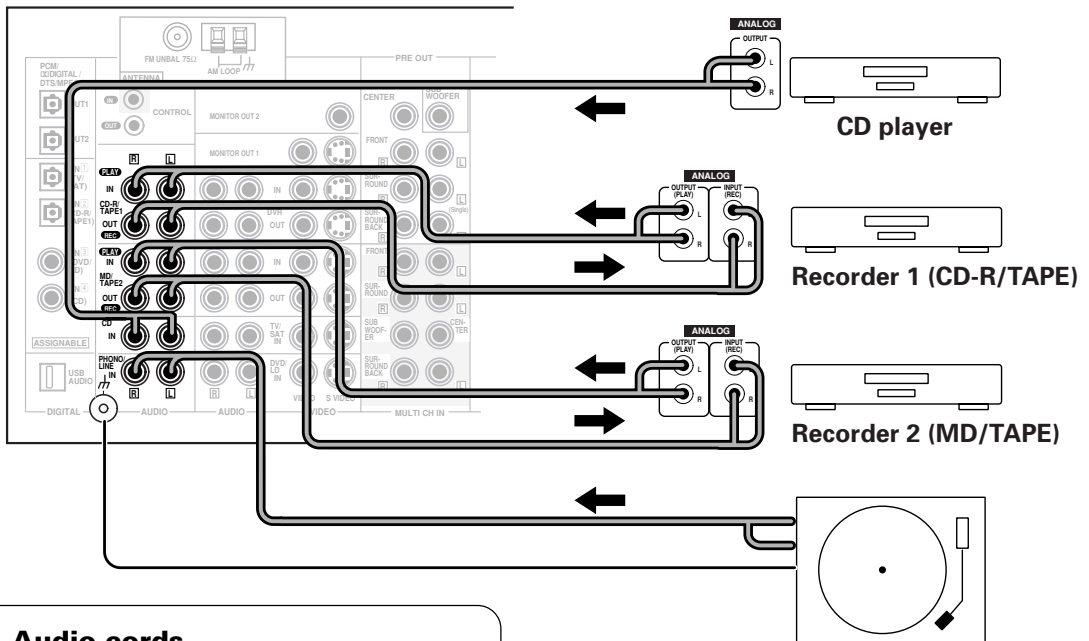

### ■ Audio cords

Use (RCA) audio cords (not supplied) to connect the audio components.

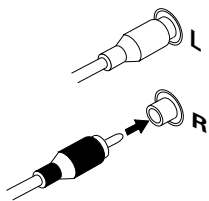

Connect red plugs to R (right) and white plugs to L (left).  
Be sure to insert completely.

### Turntable

If your turntable has a ground wire, connect it to the signal ground terminal (⚡).



- If you want to hook up any equipment other than a turntable to the PHONO/LINE jack please go to the PHONO/LINE Setup (see page 94) and choose the LINE setting. If your turntable has a phono pre-amplifier (most do not) please choose the LINE setting as well.
- Depending on where the cassette deck is placed, noise may occur during playback of your cassette deck which is caused by leakage flux from the transformer in the receiver. If you experience noise, move the cassette deck farther away from the receiver.

## Connecting to the Multi Channel Analog Inputs (DVD-Audio or Super Audio CD (SACD) compatible player)

Before making or changing the connections, switch off the power and disconnect the power cord from the AC outlet.

If you have a DVD-Audio or Super Audio CD (SACD) compatible player, or are using an external Dolby Digital/DTS decoder, connect it to the multichannel analog inputs as shown below.

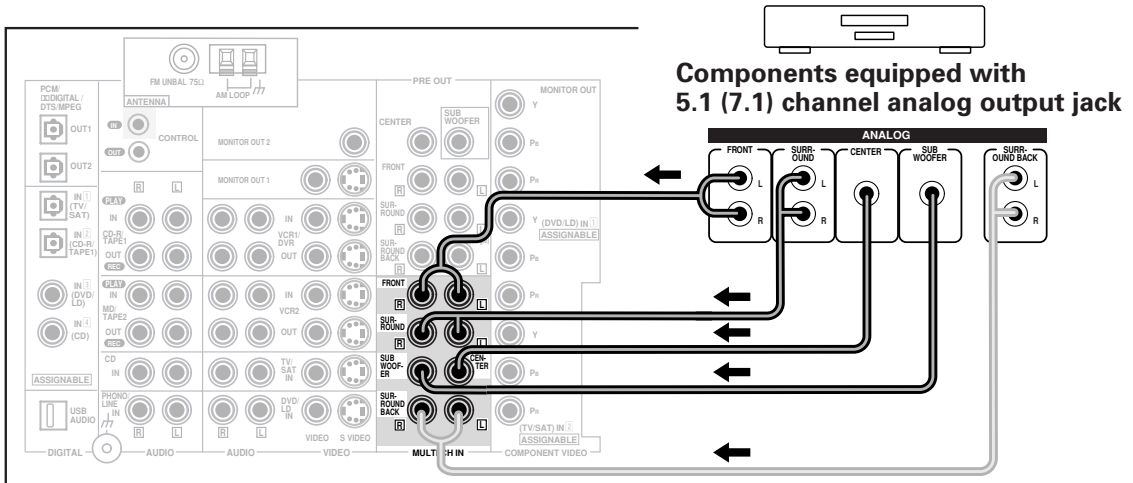

PREPARATION



If you use only one surround back input, be sure to hook up to the SURROUND BACK **L** jack.

# Connecting Digital Audio Components

Before making or changing the connections, switch off the power and disconnect the power cord from the AC outlet.

Connect your digital components as shown below. The VSX-D2011 has two coaxial and two optical inputs on the rear panel plus one digital input on the front panel. In order to use digital soundtracks like Dolby Digital or DTS (among others) you need to make digital audio connections. You can do this by either a coaxial or an optical connection (you don't need to do both). The quality of these two types of connections is the same but since some digital components only have one type of digital terminal, it is a matter of matching like with like (for example, the coaxial out from the component to coaxial in on the receiver).

Hook up your digital equipment in accordance with this receiver's default settings (see next page) unless you want to, or need to, change them. To do this see "Assigning the Digital Inputs" on page 91.

There are two optical digital out jacks (the CD recorder is connected to one in the diagram below). If you connect this to the optical input on a digital recorder (currently these include MD, DAT and CD-R) you can make direct digital recordings with this unit.

We also recommend hooking up your digital components to analog audio jacks (see page 20) in order to make recordings (some digital sources may be protected against making digital copies).

\*The arrows indicate the direction of the audio signal.

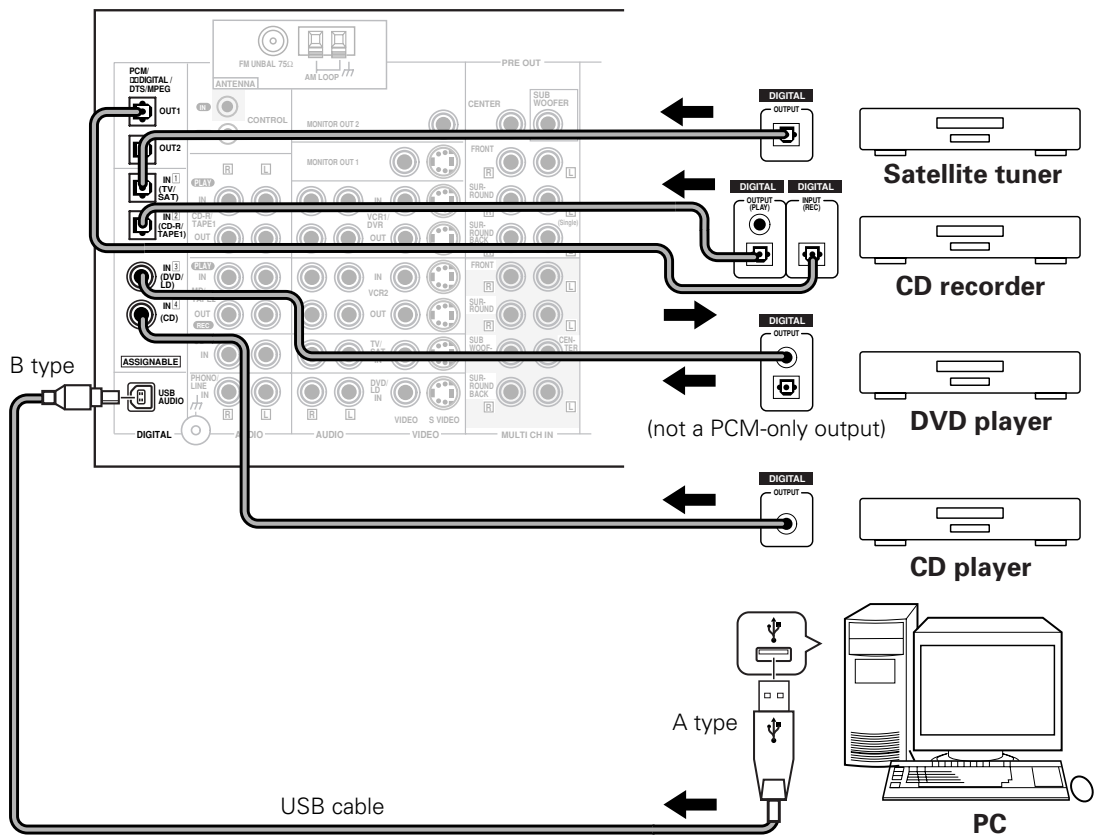

### ■ Coaxial cords/Optical cables

Commercially available digital audio coaxial cords (standard video cords can also be used) or optical cables (not supplied) are used to connect digital components to this receiver.

Be sure to insert completely and in the case of the optical cable, right-side up. If it is inserted improperly it can break the shutter on the optical terminal (this won't, however, affect the connection or insertion of an optical cable).

**Coaxial cord  
(or standard [composite]  
video cord)**

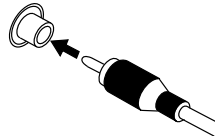

**Optical cable**

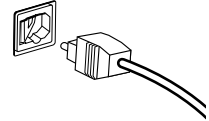

### Digital Input Default Settings

Unlike analog connections, the jacks for digital connections are not dedicated to one type of component, they can be used freely. Thus you must tell the receiver what digital component is connected to which jack so your components will be in sync with the names on the remote control buttons and the like. To avoid having to assign the digital inputs you can hook up your equipment in accordance with the receiver's default settings.

The default settings are:

DIGITAL IN **1** (optical): TV/SAT

DIGITAL IN **2** (optical): CD-R/TAPE1

DIGITAL IN **3** (coaxial): DVD/LD

DIGITAL IN **4** (coaxial): CD

See "Assigning the Digital Inputs" on page 91 if the way you hook up your equipment is different from the default settings listed here.

# Connecting the Radio Antennas

Before making or changing the connections, switch off the power and disconnect the power cord from the AC outlet.

Connect the supplied FM wire antenna and the AM loop antenna to the ANTENNA terminals as shown below. These antennas should provide adequate reception quality in most cases, but connecting outdoor antennas should noticeably improve sound quality.

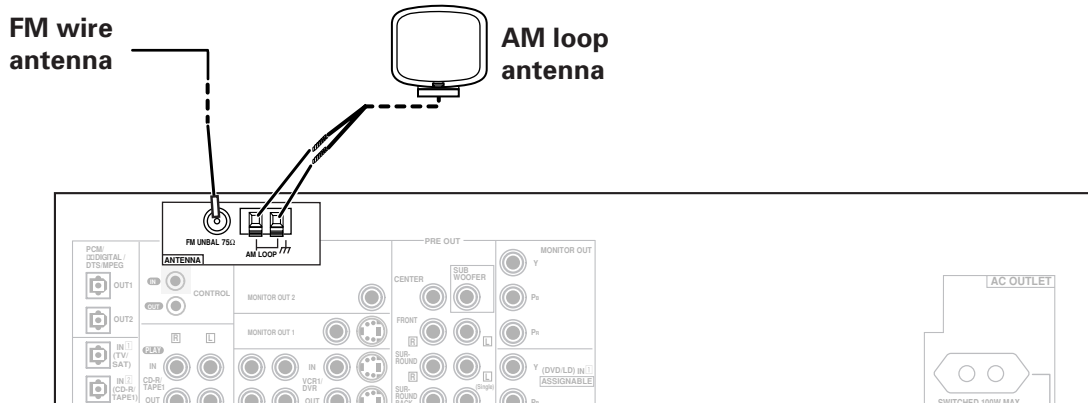

### ■ AM loop antenna

- 1 Assemble the antenna.
- 2 Twist exposed wire strands together and insert.
- 3 Attach to a wall, etc. (if desired) and face toward the direction providing the best reception.

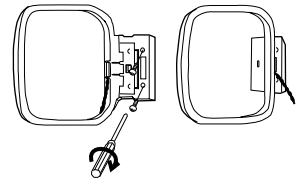
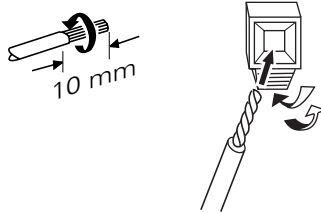
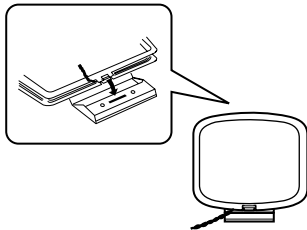

## Using outdoor antennas

### ■ To improve FM reception

Connect an external FM antenna.

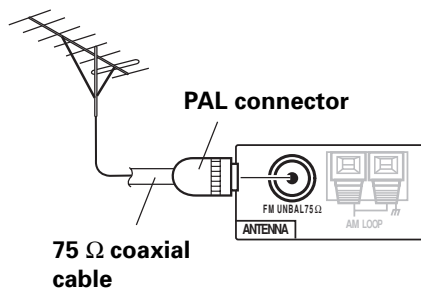

### ■ To improve AM reception

Connect a 5 – 6 meter length of vinyl-coated wire to the AM LOOP ANTENNA terminal in addition to the supplied AM loop antenna.

For best possible reception, suspend horizontally outdoors.

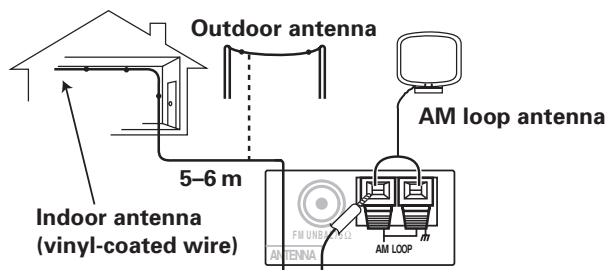



## Connecting Speakers

Before making or changing the connections, switch off the power and disconnect the power cord from the AC outlet.

We recommend a full complement of seven speakers and a subwoofer as shown here but, naturally, everyone's home setup will vary. Simply connect the speakers you have in the manner described below.

One of the latest features of home theater is the use of surround back speakers. These speakers add even greater realism in movie sound effects and some new discs with soundtracks in Dolby Digital or DTS incorporate these channels. See page 27 for speaker placement.

In general, make sure you connect the speaker on the right to the R terminal and the speaker on the left to the L terminal. Also make sure the positive and negative (+/-) terminals on the receiver match those on the speakers.



- We recommend speakers with a nominal impedance rated 8 Ω-16 Ω, but you can change the speaker impedance setting of the receiver (see page 26).
- If you only have one surround back speaker hook it up to the left surround back terminal.
- If you use a THX certified subwoofer use the THX INPUT jack on the subwoofer (if your subwoofer has one) or switch the filter position to THX on your subwoofer.

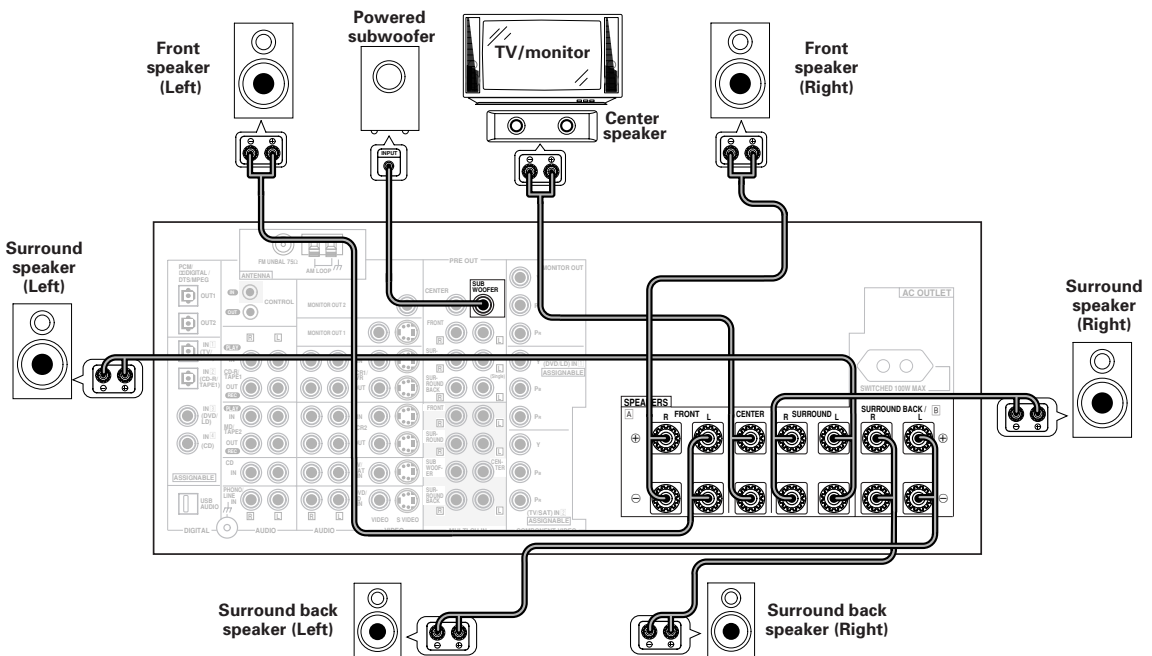

### ■ Speaker terminals

- ① Twist exposed wire strands tightly together.
- ② Loosen speaker terminal and insert exposed wire.
- ③ Tighten terminal.

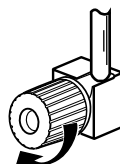
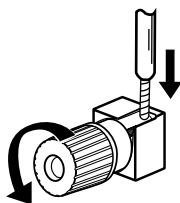
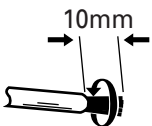

## Connecting Your Equipment

### Speaker impedance

You can change the speaker impedance for VSX-D2011 but we recommend using speakers with an impedance of 8  $\Omega$ -16  $\Omega$  (the default setting). If you are using 6  $\Omega$ - less than 8  $\Omega$  impedance speakers, you need to change the impedance setting. Use any speaker rated between 6  $\Omega$ -16  $\Omega$ .

 STANDBY/ON

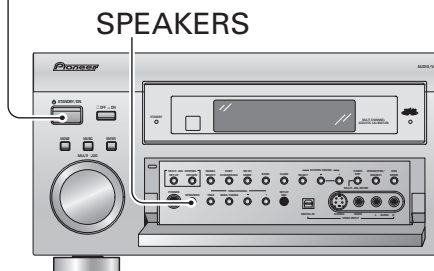

**First put the receiver in STANDBY mode, then press the power button while holding down the SPEAKERS button.**

The receiver will re-set to the new impedance setting. With this method you can choose the 8  $\Omega$ -16  $\Omega$  setting or the 6  $\Omega$ -8  $\Omega$  setting.

To check which impedance setting to hold down the SPEAKERS button for 2-3 seconds. You'll get a display like these telling you the speaker impedance setting.

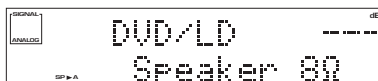

(This display indicates an 8 $\Omega$ -16 $\Omega$  impedance setting.)

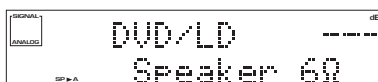

(This display indicates a 6 $\Omega$ -less than 8 $\Omega$  impedance setting.)

## Placing Your Speakers

Proper speaker placement is essential to realize the best sound from your system. The diagram and tips given here are just a rough guide, for more information see pages 108 & 109. Also, it is very important for speaker placement to read the instructions that come with your speakers so please be sure to do so.

### Speaker placement

If you have a multiple speaker arrangement the placement of the speakers is extremely important. To achieve the best possible surround sound, install your speakers as shown below. Make sure all speakers are installed securely to prevent accidents and improve sound quality. Some speakers are designed to be floor-standing but others benefit greatly from speaker stands which raise them off the floor. Be sure to read your speaker manuals for the best placement of the speakers.

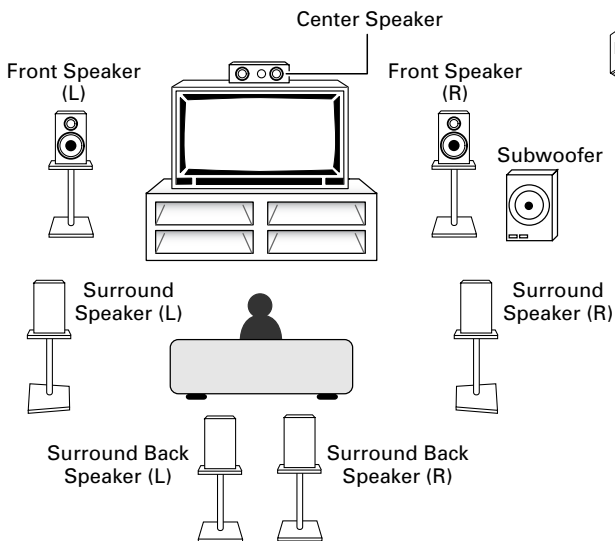

- When installing speakers near the TV, we recommend using magnetically shielded speakers to prevent distortion in the color of the TV screen. If you do not have magnetically shielded speakers and notice discoloration of the TV screen, place the speakers farther away from the TV.
- Install the center speaker above or below the TV so that the sound of the center channel is localized at the TV screen.
- THX recommends that if you have two surround back speakers place them close together.

#### CAUTION:

When installing the center speaker on top of the TV, be sure to secure it with suitable means.

## AC Power Cord

Plug in the power cord to a wall outlet after you have finished hooking up the rest of your equipment.

#### CAUTION!

- Do not use any other power cord than the one supplied with this unit. (multi-voltage model only)
- The equipment should be disconnected by removing the mains plug from the wall socket when not in regular use, e.g. when on vacation.

## AC Outlet [switched 100 W max] (European model only)

Power supplied through this outlet is turned on and off by this unit's STANDBY/ON button. Total electrical power consumption of connected equipment should not exceed 100 W.

#### CAUTION!

- Do not connect appliances with high power consumption such as heaters, irons, or television sets to the AC OUTLET in order to avoid overheating or fire risk. This can cause the unit to malfunction.
- **DO NOT CONNECT A MONITOR OR TV SET TO THIS UNIT'S AC OUTLET.**

# Displays & Controls

## Front Panel

All the controls on the front panel are explained and/or referenced here. To open the front panel push gently on the lower third of the panel.

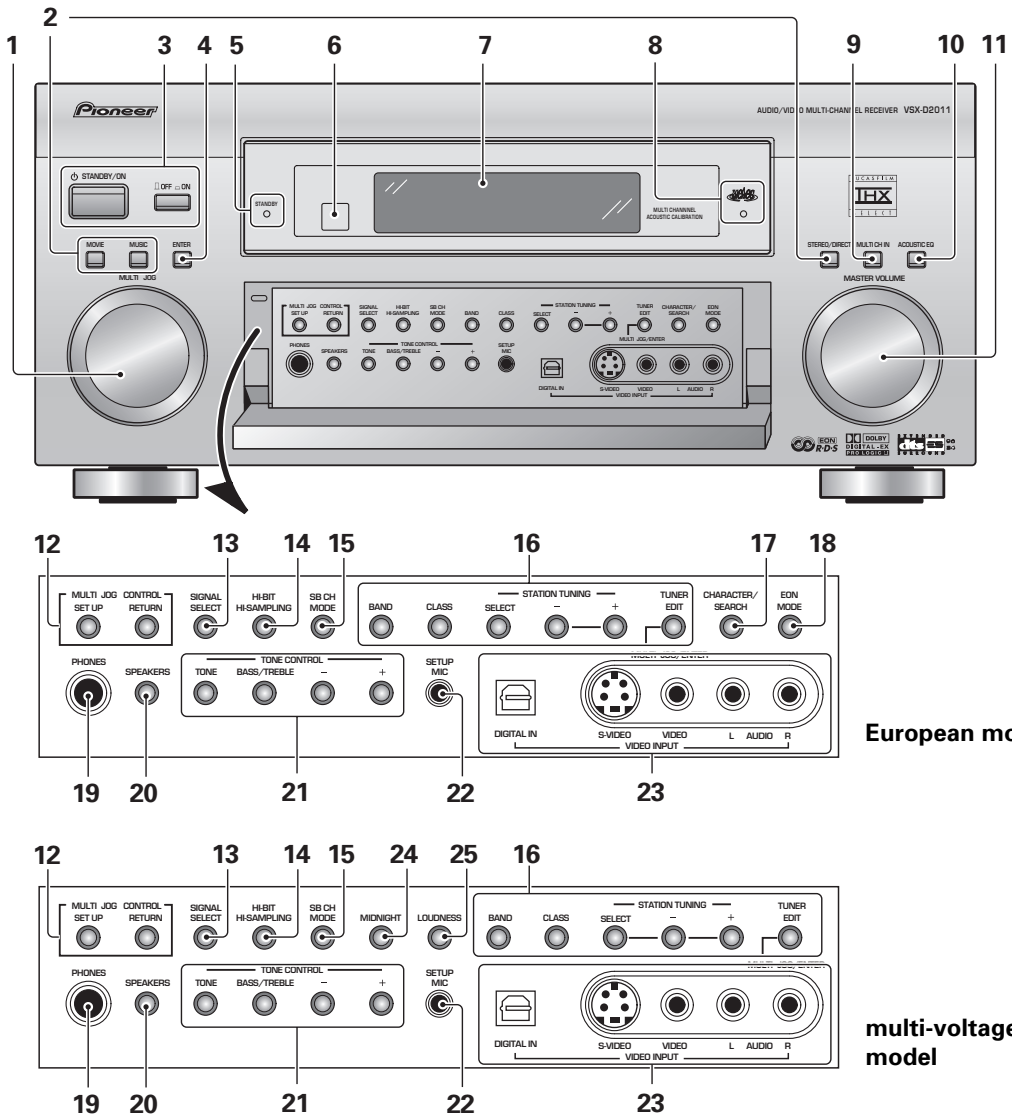

European model

multi-voltage model

### 1 MULTI JOG dial

You can use this dial for many purposes. When you press the SET UP button (12), you can use it to perform SYSTEM SETUP operations; select a function (like a DVD) or a listening mode (like Dolby Pro logic II) or do TUNER EDIT functions (in TUNER mode).

### 2 Listening mode buttons (see page 46-48)

There are two types of SURROUND modes:

**MOVIE:** Press to put the receiver into MOVIE listening mode (see page 47).

**MUSIC:** Press to put the receiver into MUSIC listening mode (see page 48).

**STEREO/DIRECT (see page 46):** Switches the receiver into STEREO mode if it was in a different sound mode or toggles between DIRECT and STEREO mode.

DIRECT playback bypasses the tone controls and channel level for the most accurate reproduction of a program source.

### 3 OFF ON button

Press to switch the receiver between OFF and STANDBY mode or ON.

### STANDBY/ON button

Press to switch the receiver between ON and STANDBY mode.

### 4 ENTER button

Use this button to enter information concerning the SYSTEM SETUP, listening mode or the tuner.

### 5 STANDBY indicator

Lights when the receiver is in STANDBY mode. (Please note that this receiver consumes a small amount of power [0.7 W for the European model and 0.9 W for the multi-voltage model] in the standby mode.)

### 6 Remote sensor

Receives the signals from the remote control.

### 7 Display (See page 33)

### 8 MCACC indicator (see pages 13-15, 50)

Lights when the ACOUSTIC CAL EQ is on. (After the AUTO SURROUND SOUND SETUP has been completed the ACOUSTIC CAL EQ is set on and this display will light.)

### 9 MULTI CH IN button

Use this button to select the component you have hooked up to the MULTI CH IN terminals (for example, a DVD-Audio player).

### 10 ACOUSTIC EQ button (see page 50, 99-101)

Press to switch on/off and select the type of acoustic calibration EQ.

### 11 MASTER VOLUME dial

Use to raise or lower the volume of the receiver.

### 12 MULTI JOG CONTROL buttons

#### SET UP

Press to switch the SYSTEM SETUP mode.

#### RETURN

Press to move back one step in the SYSTEM SETUP process.

### 13 SIGNAL SELECT button (see page 45)

Press SIGNAL SELECT repeatedly to select one of the following:

**AUTO** – If there are analog and digital signals input, the receiver automatically selects the digital signal.

**DIGITAL** – To select an optical or coaxial digital signal.

**ANALOG** – To select an analog signal.

### 14 HI-BIT HI-SAMPLING button (see page 53)

Use this button to switch the HI-BIT HI-SAMPLING mode on or off. Use to hear CD and DVD, as well as other digital soundtracks at a wider dynamic range, allowing for finer audio reproduction.

### 15 SB CH MODE button (see pages 54)

Use this button to turn the surround back channels ON/OFF/AUTO or switch the VIRTUAL SURROUND BACK mode between ON/OFF/AUTO.

### 16 TUNER CONTROL buttons (See pages 57-65)

#### BAND

Press to select the AM or FM band.

#### CLASS

Press repeatedly to switch the preset station classes.

#### SELECT

Switches the  $-/+$  buttons between station memory and frequency select modes.

#### $-/+$

Selects station memories or frequencies when using the tuner.

#### TUNER EDIT

Press to memorize and name a station for recall using the MULTI JOG and ENTER buttons.

### 17 CHARACTER/SEARCH button (See pages 62-65)

Use to search for different program types in RDS mode.

### 18 EON MODE button (see pages 64-65)

Use to search for different programs that are transmitting traffic or news information (this search method is called EON).

### 19 PHONES jack

Connect headphones for private listening (no sound will be heard through the speakers).

### 20 SPEAKERS (A/B) button

The use of this button depends on how the SURRBACK SYSTEM (see page 37) is set. If NORMAL SYSTEM is chosen this button toggles between A and OFF. If FRON Bi-AMP is chosen this button toggles between A+B and OFF. If SECOND ZONE is chosen this button toggles between A, B, A+B and OFF.

### 21 TONE control buttons (see page 52)

#### TONE button

This button switches between TONE ON and TONE BYPASS, which bypasses the tone circuitry.

#### BASS/TREBLE button

Use to select whether the bass or treble will be adjusted.

#### $-/+$ buttons

Use to adjust the frequency levels.

### 22 SET UP MIC jack (see page 13)

Plug in the set up mic here. This is very important in order to set up your system and get proper surround sound.

## Displays & Controls

### 23 VIDEO INPUT jacks (see page 18)

#### DIGITAL IN

Digital input for connecting a game console, DVD player, video camera (etc.), that has an optical digital connection.

#### S-VIDEO

Video input for connecting a portable DVD player, video camera (etc.), that has an S video out.

#### RCA VIDEO / AUDIO (L/R)

Video input for connecting a portable DVD player, video camera, etc. That has standard RCA video/audio outputs.

### 24 MIDNIGHT button (see page 51)

Switches the MIDNIGHT listening mode on or off (for all modes except THX CINEMA and MULTI CH IN).

### 25 LOUDNESS button (see page 51)

Switches the LOUDNESS mode on or off (for all modes except THX CINEMA and MULTI CH IN).

## Remote Control

This page describes the buttons on the remote control used to operate the receiver.

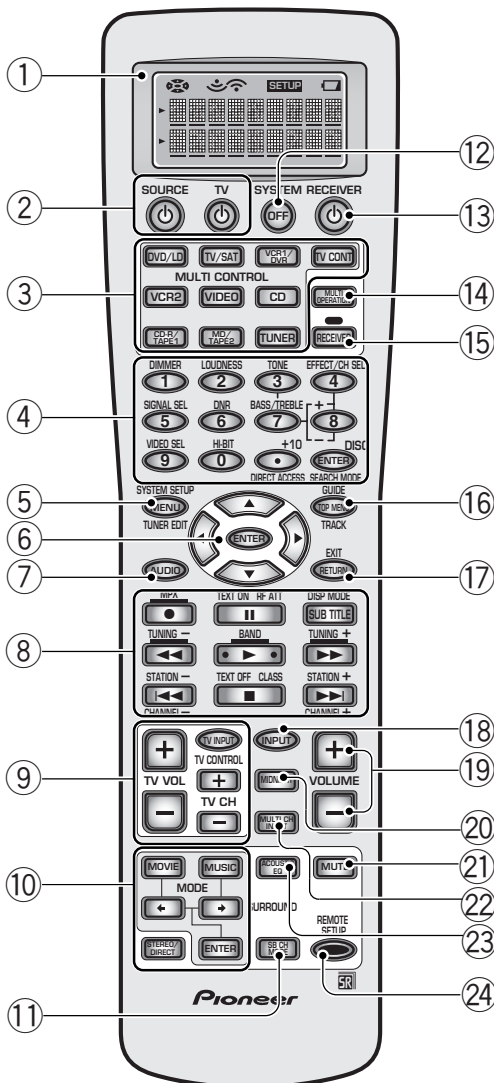

### ① Remote Control Display Screen

### ② SOURCE button

Use this button to turn on/off other components. You must input the preset code in order to use this function (see page 66-67).

### TV button

This is a dedicated TV button. Use it to turn on/off your TV.

### ③ MULTI CONTROL buttons

These buttons are the basic controls that switch the mode of the receiver and the remote control, which allows you to control your other components.

**TV CONT:** Press so that the remote control can operate the TV control commands.

### ④ Number buttons

These can be used for many purposes depending on the mode of the remote control.

When in receiver mode the buttons operate as below:

### DIMMER button (see page 56)

Use to adjust the brightness of the receiver's display.

### LOUDNESS button (see page 51)

Switches the LOUDNESS mode on or off (for all modes except THX CINEMA and MULTI CH IN).

### TONE button (see page 52)

This button switches between TONE ON and TONE BYPASS, which bypasses the tone circuitry.

### BASS/TREBLE buttons (see page 52)

Use to select whether the bass or treble will be adjusted.

**(+/-) buttons (see page 52)**

Use to adjust the TONE level, effect level and channel level as well as make Dolby Pro Logic II MUSIC parameter settings.

**EFFECT/CH SEL. button**

Switches between the different channels so you can add volume individually to each channel with the + and - buttons. Also selects EFFECT mode of PIONEER original sound modes and Dolby Pro Logic II MUSIC parameter settings. You can then use the + and - buttons to make these adjustments.

**SIGNAL SELECT button (see page 45)**

Press SIGNAL SELECT repeatedly to select one of the following:

**AUTO** – If there are analog and digital signals input, the receiver automatically selects the digital signal.

**DIGITAL** – To select an optical or coaxial digital signal.

**ANALOG** – To select an analog signal.

**DIGITAL NR (DNR) button (see page 50)**

Switches the DIGITAL NR on or off.

**VIDEO SELECT button (see page 56)**

Use to toggle between the different video input possibilities.

**HI-BIT button (see page 53)**

Use this button to switch the HI-BIT HI-SAMPLING on or off. Use to hear CD and DVD, as well as other digital soundtracks at a wider dynamic range, allowing for finer audio reproduction.

**⑤ SYSTEM SETUP button**

Use for all system setups, including the speaker and sound systems. For more information see. "Setting up for Surround Sound" starting on page 36. For a DVD player use this button to bring up the DVD menu and for a tuner use this button in the same way as the TUNER EDIT button.

**⑥ ▲/▼/◀/▶/ENTER buttons**

These buttons can be used for a variety of operations in the SYSTEM SETUP menu.

These buttons are used to control the menus for other components when in those modes (DVD, digital TV tuner, satellite tuner, cable tuner, etc.). In TUNER mode, they can select a station and/or a frequency.

**⑦ AUDIO button**

Use to switch the audio tracks of a DVD when in DVD mode.

**⑧ Command button for other components (see pages 70-71)**

Use these buttons to control other components you selected with the MULTI CONTROL buttons. You must input the preset code in order use this function (see page 66-67).

**⑨ TV CONTROL buttons**

The following buttons are used to control the TV only and can be used once they are preset to control your TV.

**TV INPUT:** Press to select the input source for the TV.

**TV CH +/- :** Use these buttons to change the channel of the TV.

**TV VOL +/- :** Press to control the volume of the TV.

**⑩ Listening mode buttons (see page 46-48)**

**SURROUND buttons (MOVIE, MUSIC, ◀ ▶ & ENTER):**

**MOVIE:** Press to put the receiver into MOVIE listening mode (see page 47).

**MUSIC:** Press to put the receiver into MUSIC listening mode (see page 48).

**◀ ▶:** Use to select the MOVIE or MUSIC listening mode.

**ENTER:** Use this button to enter information concerning the listening modes.

**STEREO/DIRECT:** Switches the receiver into STEREO mode if it was in a different sound mode or toggles between DIRECT and STEREO mode.

DIRECT playback bypasses the tone controls and channel level for the most accurate reproduction of a program source.

**⑪ SB CH MODE button (see pages 54)**

Use this button to turn the surround back channels ON/OFF/AUTO or switch the VIRTUAL SURROUND BACK mode between ON/OFF/AUTO.

**⑫ SYSTEM OFF button (see pages 82-83)**

This button turns off components in two ways. First, when pressed it will turn off all PIONEER components. Secondly, any component that has programmed into the SYSTEM OFF settings will be turned off.

**For example:** If you programmed power off in the SYSTEM OFF settings for your TV and VCR, pressing the SYSTEM OFF button will turn off these components even if they are not PIONEER products.

**⑬ ⏻ RECEIVER (STANDBY/ON) button**

Press to turn power of the receiver on or to standby (off).

## Displays & Controls

- ⑭ **MULTI OPERATION button**  
Use this button to start the MULTI OPERATION mode. See page 80-81 for how to program and use the MULTI OPERATION mode.
- ⑮ **RECEIVER button**  
Use this button to switch the remote control into receiver mode in order to get certain receiver functions or do receiver setups.
- ⑯ **TOP MENU/GUIDE button**  
Use to find stations or menus on a digital TV tuner. For a DVD player use this button to bring up the DVD menu.
- ⑰ **RETURN button**  
When you are in a receiver setup operation this button will go back one step in the SYSTEM SETUP procedure. When you are using your DVD menu screen this button acts the same as the DVD player's "RETURN" button. When you are using cable tuners, satellite tuners or digital TV tuners this button will either exit you from the menu screen or act like a "RETURN" button above, depending on the maker of the unit.
- ⑱ **INPUT button**  
Press to select an input source. The button will cycle through all the possible sources.
- ⑲ **VOLUME (+/-) buttons**  
Use to raise or lower the volume of the receiver.
- ⑳ **MIDNIGHT button (see page 51)**  
Switches the MIDNIGHT listening mode on or off (for all modes except THX CINEMA and MULTI CH IN).
- ㉑ **MUTE button**  
Press to mute or restore the volume.
- ㉒ **MULTI CH INPUT button (see page 53)**  
Use this button to select the component you have hooked up to the MULTI CH IN terminals (for example, a DVD-Audio player).
- ㉓ **ACOUSTIC EQ button (see pages 99-101)**  
Press to switch on/off and select the type of acoustic calibration EQ.
- ㉔ **REMOTE SETUP button.**  
Use to customize the remote control functions and the remote control itself. (See "Setting Up the Remote Control to Control Other Components" starting on page 66).



# Display

All the display information is explained and/or referenced here.

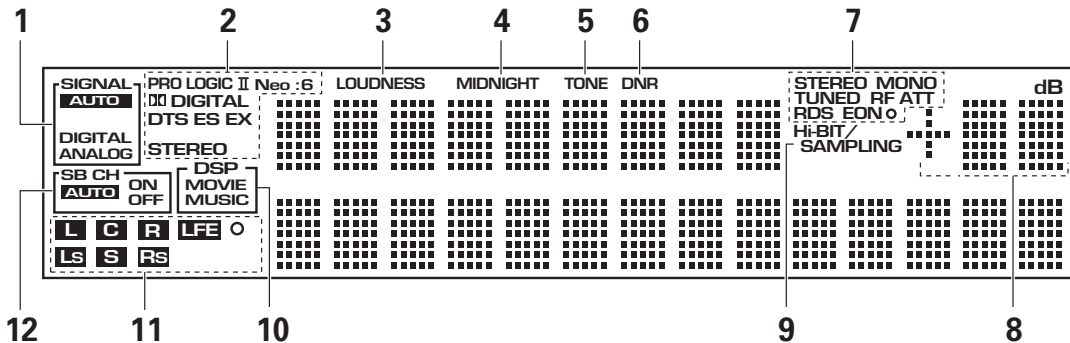

## 1 SIGNAL SELECT indicators

Light to indicate the input signal you selected.

- AUTO:** Lights when the receiver is set to select the input signal automatically.
- DIGITAL:** Lights when digital audio signals are selected.
- ANALOG:** Lights when analog signals are selected.

## 2 Digital format indicators

- PRO LOGIC II:** Lights during Dolby Pro Logic II processing.
- NEO:6:** Lights during NEO:6 processing.
- DIGITAL:** Lights when a Dolby Digital signal is detected.
- DTS:** Lights when a DTS signal is detected.
- ES:** Lights when playing back a DTS ES signal.
- EX:** Lights when playing back a Dolby Digital EX signal.
- STEREO:** Lights during two-channel playback.

## 3 LOUDNESS indicator

Lights when LOUDNESS is on.

## 4 MIDNIGHT indicator

Lights when MIDNIGHT is on.

## 5 TONE indicator

Lights when the TONE control is on.

## 6 DNR indicator

Lights when DIGITAL NR is on.

## 7 TUNER indicators

- STEREO:** Lights when an FM stereo broadcast is received in the auto stereo mode.
- MONO:** Lights when the tuner is set to receive FM broadcasts and when MPX mode is selected.
- TUNED:** Lights when a broadcast is received.
- RF ATT (European model only):** Lights when the RF ATT is on (see p.57).
- RDS (European model only):** Lights when an RDS broadcast is received.
- EON o (European model only):** EON lights when it has been set. The dot indicator next to

it lights when the station you are currently tuned to carries the EON data service.

## 8 Volume level indicator

## 9 Hi-BIT/SAMPLING indicator

Lights when a HI-BIT/SAMPLING mode is on.

## 10 DSP indicators

- MOVIE:** Lights when a MOVIE mode is selected. When a DSP MOVIE mode is selected DSP will light with a box around it.
- MUSIC:** Lights when a MUSIC mode is selected. When a DSP MUSIC mode is selected DSP will light with a box around it.

## 11 Program Format indicators

**For Dolby Digital or DTS sources:** These indicators change according to which channels are active in the source. When all three **LS** (left surround), **S** (surround) and **RS** (right surround) light at the same time it means a source with a 6.1 channel playback flag is being used.

- L** – Left front channel.
- C** – Center channel.
- R** – Right front channel.
- LS** – Left surround channel.
- S** – Surround channel or Surround back channel.
- RS** – Right surround channel.
- LFE** – Low Frequency Effects channel.
- O** – Lights when LFE signal is input.

## 12 SB CH indicators

- Light to indicate the status of the surround back channels.
- AUTO** – Lights when the SB CH MODE or VIRTUAL SURROUND BACK mode is set to AUTO.
- ON** – Lights when the SB CH MODE or VIRTUAL SURROUND BACK mode is set to ON.
- OFF** – Lights when the SB CH MODE or VIRTUAL SURROUND BACK mode is set to OFF.

## Back Panel

All the terminals on the back panel are explained and/or referenced here.

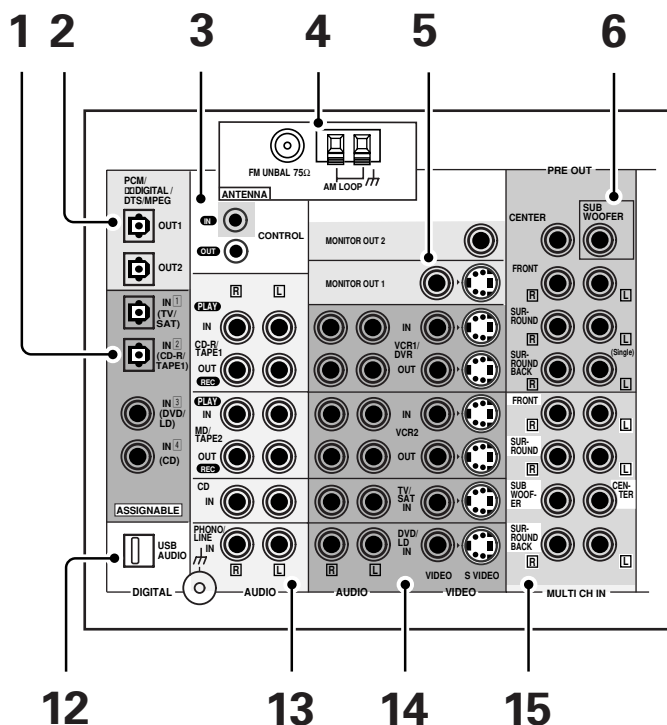

### 1 DIGITAL IN terminals (see page 22)

Use these terminals to input the signal from a DVD, CD player or any other kind of digital player. To be able to play Dolby Digital and other surround soundtracks you need to make digital connections. To do this use the digital terminals here. If you don't connect as per the default settings (see page 23) you need to complete "Assigning the Digital Inputs" (see page 91).

### 2 DIGITAL OUT terminals (see page 22)

Use these terminals to output a digital signal to a DVD-R, CD-R, MD recorder or any other kind of digital recorder.

### 3 CONTROL IN/OUT terminal (see page 79)

You can use this jack to hook up other PIONEER equipment, that has a CONTROL terminal, so that you can control them all by pointing the remote control(s) at one remote sensor.

### 4 Radio antenna terminals (see page 24)

Hook up antennas for the radio tuner built into the receiver here.

### 5 MONITOR OUT 1 & 2 terminals (connect a TV or monitor here, see page 16)

Use either of these terminals to output the video signal to your TV(s), video projector(s) or monitor(s). The on-screen displays to setup the receiver will only be output through MONITOR OUT 1.

### 6 PRE OUT analog terminals (connect an amplifier here, see page 78)

Use these terminals to output the audio signal from this amplifier to a different amplifier if that's how you choose to set up your system.

### 7 COMPONENT VIDEO MONITOR OUT terminals

Use these terminals to output the video signal from the COMPONENT VIDEO IN terminals to your TV. See #16 for more information.

### 8 SPEAKERS terminals (see page 25)

Use these terminals to connect speakers to the receiver. The FRONT, CENTER and SURROUND terminals are for the main speaker system and the SURROUND BACK speakers can be set to either the main system or the SECOND ZONE. See page 37 to set the SURROUND BACK speakers.

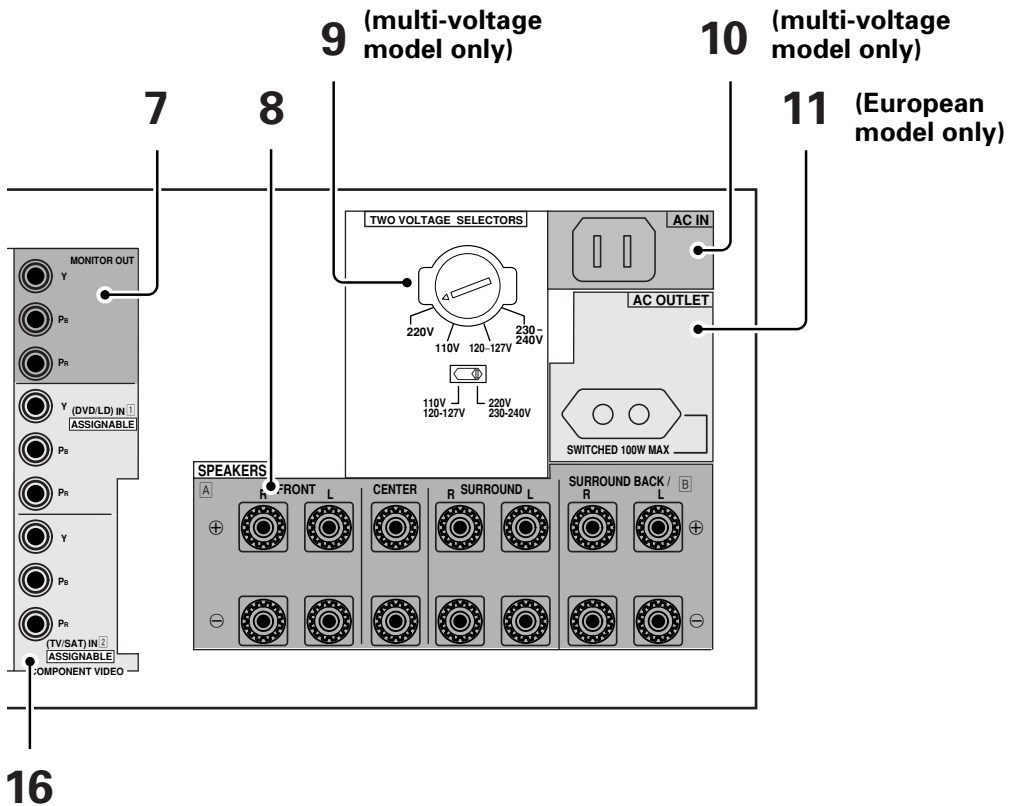

**9 Voltage Selector (multi-voltage model only)**

Use to match the voltage coming into the receiver with the voltage in your country or region (see page 3).

**10 AC IN (multi-voltage model only)**

Hook up the power cord to this terminal.

**11 AC OUTLET (European model only) (switched, 100 W max)**

Hook up an external component to the power supply of this receiver. Only do this with audio or video components being used in this system and never hook up heavy equipment (like TVs, heaters, air conditioners, refrigerators, etc.) to this receiver.

**12 USB AUDIO IN terminal**

Use this terminal to connect a PC to this receiver (see pages 76-77).

**13 Audio input/output terminals (connect analog components here, see page 20)**

Use these terminals to input/output the audio signal from analog components (like a cassette deck or turntable). These are analog jacks.

**14 Video components input/output terminals**

Input/output signals from your video components (DVD, VCR, TV tuners, SAT tuners, etc.) here. (see pages 17-19).

**15 MULTI CH IN terminals (see page 21)**

Use these terminals to input a multichannel surround signal (for example, a DVD-Audio signal) in an analog fashion. These are analog jacks.

**16 COMPONENT VIDEO IN terminals (see pages 16-17)**

Use these terminals to hook up the video connections of your video components with this high quality method. Your components will have to have the terminals as well to take advantage of this kind of connection. If you don't connect as per the default settings (see page 16) you need to complete "Assigning the Component Video Inputs" (see page 92).

# Setting Up for Surround Sound

To ensure the best possible surround sound, complete the following setup operations. Some of these are the same (and take precedence over) the settings you made in the Easy Setup Guide, so consider if the ones you made at that time were adequate. If you feel they were, move on to the next setting in this section. These setup operations use on-screen displays (OSDs) on your TV to display the settings and choices so be sure your TV and receiver are properly hooked up and that your TV is set to this receiver. You need to connect the setup mic to the front panel of the receiver so that it can measure the sound and ensure the proper settings. For more information on the mic hookup see page 13. Use the arrow buttons (▲▼) and the ENTER button on the remote control to navigate the OSDs on your TV. Conversely, you can use the MULTI JOG dial and ENTER button, and look at the display, on the Front Panel.

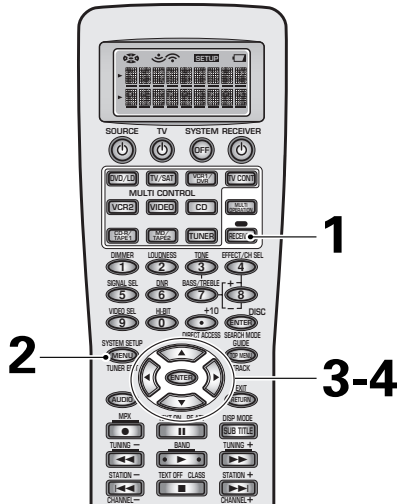

## 1 Turn on the receiver and your TV. Press the RECEIVER button on the remote control.

Make sure your TV is connected and set to the video input the receiver is using.

## 2 Press the SYSTEM SETUP button.

The menu possibilities appear on your TV.

## 3 SURROUND SETUP should be selected. If it isn't use the ▲▼ buttons to select it. Press the ENTER button.

## 4 Use the ▲▼ buttons to navigate through the menus. When you have the setting you want in a particular menu, press ENTER.

In each mode, the current settings are displayed. We suggest you do a basic system setup for surround sound when you first hook up the receiver. That gets it out of the way and you won't need to do it again unless you change your home set up (by adding new speakers, etc.). To do a basic setup use the SURRBACK menu if necessary and then choose either the AUTO SETTING, QUICK or NORMAL setup procedure and complete that. You don't need to do all three as they accomplish the same ends and we recommend the AUTO SETTING method.

To do a more advanced setup for surround sound see EXPERT setup starting on page 95.

### SURRBACK (Surround Back) SYSTEM (See page 37)

Use to choose options for your surround back speakers.

### AUTO SETTING (See page 13-15)

See the Easy Setup Guide Part 2 for an explanation of this setup.

### QUICK setup (See page 38)

Use to setup your surround sound system in the minimum amount of time.

### NORMAL setup (See page 39)

Use this method to manually adjust all the surround sound functions.

### EXPERT setup (See pages 95-103)

Use these settings to fine tune your surround sound and make it more personalized.

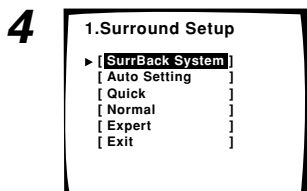
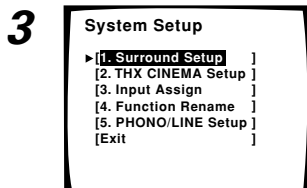
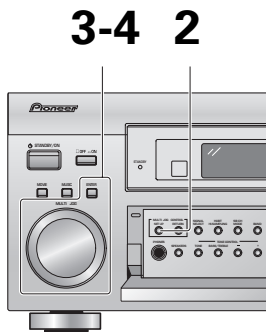

## SURRBACK SYSTEM (Surround Back System)

This setup selects how your surround back system will be used. If you want to use it for surround back speakers in your main speaker system choose NORMAL SYSTEM. In this case you won't have any B (or secondary) speaker system as these speakers fill that role also for the VSX-D2011. If you want to use your surround back speakers in a different room choose SECOND ZONE. Alternatively, you can choose the FRONT BI-AMP setting, in order to deliver more power to the front speakers. If starting fresh, complete steps 1-3 in page 36.

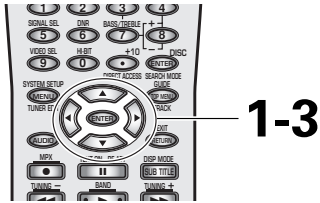

1-3

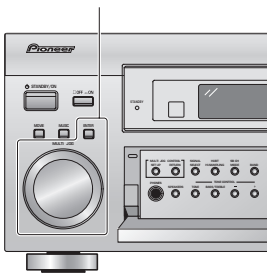

**1 SURRBACK SYSTEM should be selected. If it isn't use the ▲▼ buttons to select it. Press the ENTER button.**

The setup possibilities appear on your TV.

**2 Use the ▲▼ buttons to select the surround back system setting. Press the ENTER button.**

Choose from:

**NORMAL SYSTEM:** if you want to use these speaker terminals for your surround back speakers in your main speaker system (referred to as the A speaker system).

**SECOND ZONE:** if you want to use the these speaker terminals for an independent speaker system (referred to as speaker system B).

**FRONT BI-AMP:** Choose this setting if you want to deliver more power to your front speakers. This setting will use your surround back speaker terminals so you will only be able to get 5.1 channel playback. Also, you will have to bi-wire your speakers to do this (see page 74).

**3 EXIT should be selected. Press the ENTER button.**

You will return to the SURROUND SETUP menu display. Next, proceed to either AUTO SETTING (see page 13), QUICK (on the next page) or NORMAL (see page 39). **If you want to change a setting before proceeding start over from step 1.**

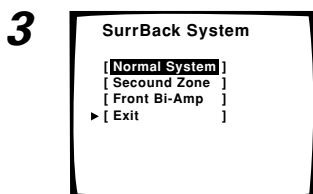
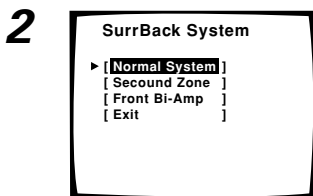
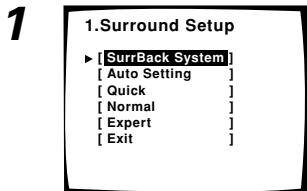

## QUICK setup

This simple and quick setup method allows you to make all the necessary settings manually with the minimum of hassle. If you did the AUTO SURROUND SOUND SETUP method on pages 13-15 you don't need to do this setup. You must have front and surround speakers hooked up to use this setup.

You only need to do these settings once (unless you change the placement of your current speaker system or add new speakers, etc.). If starting fresh, complete steps 1-3 in page 36.



1-4

1-4

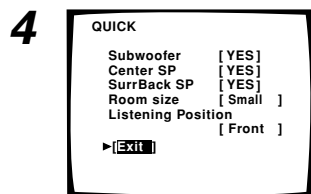
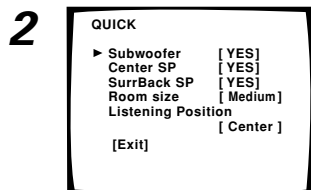
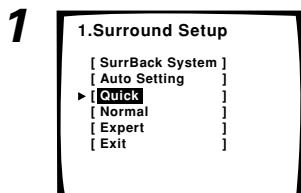
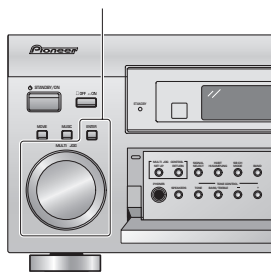

**1 Use the ▲▼ buttons to select QUICK. Press the ENTER button.**

The setup possibilities appear on your TV.

**2 Use the ▲▼ buttons to navigate through the QUICK setup menus. When you get a menu you want to adjust press ENTER.**

**3 In a menu use the ▲▼ buttons to select the different settings. When you have the setting you want in a particular menu, press ENTER.**

Make the adjustments that match your home setup using the buttons described above.

**SUBWOOFER setting:**

If you connected a subwoofer select YES, if you didn't select NO.

**CENTER SP setting:**

If you connected a CENTER speaker select YES, if you didn't select NO.

**SURRBACK SP setting:**

If you connected a SURROUND speaker(s) select YES, if you didn't select NO.

**ROOM SIZE setting:**

Tell the receiver your room size so it can equalize the speakers properly. Use the chart below for an approximate definition of the settings.

**SMALL:** 2.5 m by 3.5 m

**MEDIUM:** 4 m by 5 m

**LARGE:** 5.5 m by 7.5 m

**LISTENING POSITION setting:**

This setting establishes where your ideal listening position is. Choose from the three possibilities following the guide below.

**FRONT:** your listening position is closer to the front speakers.

**CENTER:** your listening position is equidistant to the front and surround speakers.

**REAR:** your listening position is closer to the surround speakers.

**4 Use the ▲▼ buttons to select the EXIT. Press the ENTER button.**

You will return to the SURROUND SETUP menu display. **If you want to change a setting before proceeding start over from step 1.**



If you do the QUICK setup after the AUTO SURROUND SOUND SETUP the former will replace the latter.

## NORMAL setup

This is the manual method to setup your sound parameters for surround sound. It is more exact than the QUICK setup and should give you finer surround sound. You don't need to do this, however, if you did the AUTO SURROUND SOUND SETUP method on pages 13-15. If you feel the settings in the AUTO SURROUND SOUND SETUP do not suit your personal tastes, the settings you input here will override them and allow you to adjust the parameters manually. AUTO SURROUND SOUND SETUP with the microphone may not properly assess the size of your speakers if there is background noise, from an air conditioner or refrigerator, for example. If necessary try different possible settings here.

You only need to do these settings once (unless you change the placement of your current speaker system or add new speakers, etc.). If starting fresh, complete steps 1-3 in page 36.

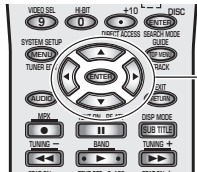

1-2

### 1 Use the ▲▼ buttons to select NORMAL. Press the ENTER button.

The setup possibilities appear on your TV.

### 2 Use the ▲▼ buttons to navigate through the NORMAL setup menus. When you have the setting you want in a particular menu, press ENTER.

In each mode, the current settings are displayed. We suggest you adjust all these settings when you first hook up the receiver. That gets them out of the way and you won't need to return to this setting mode unless you change your home set up by adding new speakers (etc.).

#### SPEAKER SETTING (See pages 40-41)

Use to specify the type and number of speakers you connected.

#### CHANNEL LEVEL (See page 42)

Use to balance the volumes of your different speakers. This is also necessary for the most realistic surround sound.

#### CHANNEL DELAY (See page 43)

Use to select the distance settings for each set of speakers. You must add distance settings to all your speakers for the most realistic surround sound. Adding a slight delay to some speakers enhances sound separation and is particularly important for achieving a surround sound effect. You need to figure out the distance from your listening position to your speakers to add the proper delay.

See the next four pages for more information on these settings.

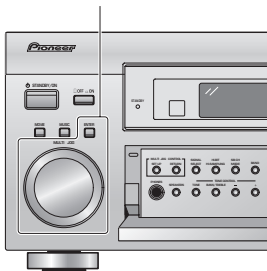

1-2

1

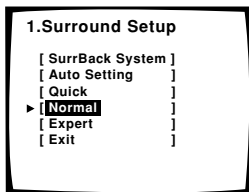

2

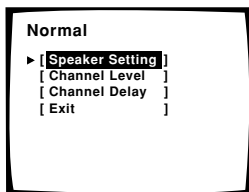

## Setting Up for Surround Sound

### SPEAKER SETTING

The information below shows you how to select the correct settings for the type and number of speakers you connected. Most importantly, you need to decide how to route the sound for all the speakers you connected. To do this select the size of the front, center, surround and surround back speakers (if you hooked them up). It is important to make these settings as accurately as possible or, in some cases, you may not get the full soundtrack from a disc.

Use the information below to complete the steps that follow and set up the receiver to match the speakers you have hooked up.

If starting fresh, complete steps 1-2 in page 39.

#### **FRONT (default setting is SMALL)**

Select SMALL to send bass frequencies to the subwoofer. Select LARGE if your speakers will reproduce bass frequencies effectively or if you did not connect a subwoofer. (If you select SMALL for the front speakers the subwoofer will automatically be switched YES. Also, the center and surround speakers cannot be set to LARGE if the front speakers are set to SMALL. In this case, all bass frequencies are sent to the subwoofer.)

#### **CENTER (default setting is SMALL)**

- Select LARGE if your speaker will reproduce bass frequencies effectively.
- Select SMALL to send bass frequencies to the other speakers or subwoofer.
- If you did not connect a center speaker, choose NO. In this case, the center channel is output from the front speakers.

#### **SURROUND (default setting is SMALL)**

- Select LARGE if your speakers will reproduce bass frequencies effectively.
- Select SMALL to send bass frequencies to the other speakers or subwoofer.
- If you did not connect surround speakers choose NO. In this case, the sound of the surround channels is output from the front and center speakers.
- If the front speakers are set to SMALL, the surround speakers will automatically be set to SMALL.

#### **SURROUND BACK (default setting is SMALL X2)**

**If you chose SECOND ZONE or FRONT BI-AMP in SURRBACK SYSTEM on page 37, or if you chose NO for SURROUND SPEAKERS, you won't be able to choose this setting.**

- Select the number of surround back speakers you have. You can choose one speaker, two, or none.
- If you select one speaker, make sure to hook it up to the **left** surround back terminal.
- Select LARGE if your speakers will reproduce bass frequencies effectively.
- Select SMALL to send bass frequencies to the other speakers or subwoofer.
- If you did not connect surround back speakers choose NO.
- If the front speakers or the surround speakers are set to SMALL, the surround back speakers will automatically be set to SMALL.
- If you choose THX in step 2 then the surround back speakers can only be set to SMALL (X1 or X2), or NO.

#### **SUBWOOFER (default setting is YES)**

- Leave it selected if you connected a subwoofer.
- If you selected SMALL for the front speakers the subwoofer will automatically be set to on (you won't be able to choose NO or PLUS).
- If you did not connect a subwoofer choose NO. In this case, the bass frequencies are output from the front or surround speakers.
- Choose the PLUS setting if you want stronger reproduction of deep bass sounds.
- If you select PLUS the bass frequencies that would normally come out the front and center speakers are all routed to the subwoofer.



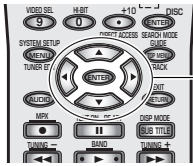

1-6

1-6

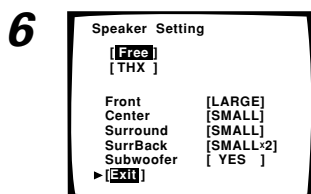
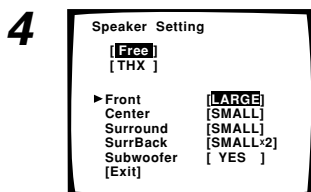
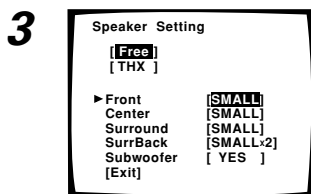
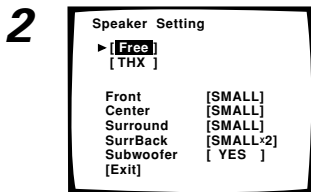
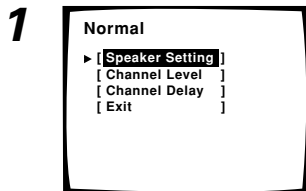
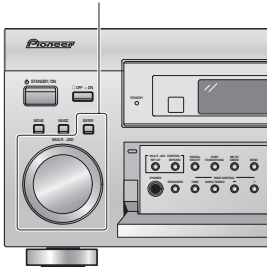

**1 SPEAKER SETTING should be selected. If it isn't use the ▲▼ buttons to select it. Press the ENTER button.**

The setup possibilities appear on your TV.

**2 Use the ▲▼ buttons to select the speaker system setting.**

Choose from:

**FREE:** to sets all the speakers

**THX:** All speakers are set to SMALL and the SUBWOOFER to YES. You can select the number of surround back speakers.

**For FREE,** select it and press ENTER. Then go to step 3.

**For THX,** select it and press ENTER. Then go to step 4 but you only need to set the number of surround back speakers.

**3 With the ▲▼ buttons choose the speakers that you want to set. Press the ENTER button.**

The setup possibilities appear on your TV.

**4 Use the ▲▼ buttons to choose the number (YES or NO, X1 or X2) and the size (LARGE or SMALL) for each set of speakers. Press ENTER.**

PLUS is also a possibility for the SUBWOOFER.

If you selected THX in step 2, you only need to set the number of surround back speakers (X1, X2, or NO).

**5 Repeat steps 3 & 4 for all speakers channels.**

**6 Use the ▲▼ buttons to select EXIT and press ENTER.**

Next, proceed to CHANNEL LEVEL next page.

**If you want to change a setting before proceeding** start over from step 1.



If you have a subwoofer and like lots of bass, it may seem logical to select LARGE for your front speakers and leave the subwoofer selected. This may not, however, yield the best bass results. Depending on the size and shape of your room you may actually experience a decrease in the amount of bass due to what is called low frequency cancellations. If you have a subwoofer, listen to the bass response with the front speakers set to LARGE and SMALL alternately and let your ears judge which sounds best.

The safest option is to route all the bass sounds to the subwoofer by selecting SMALL for the front speakers.

# Setting Up for Surround Sound

## CHANNEL LEVEL (channel balance)

The following steps show you how to balance the sound output level of your speakers. Proper speaker balance is essential for obtaining high quality surround sound. If continuing from SPEAKER SETTING go to step 1. If starting fresh, complete steps 1-2 on page 39.



1-5

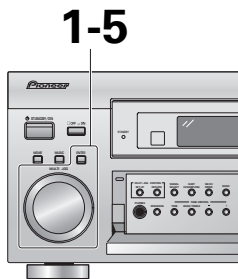

1-5

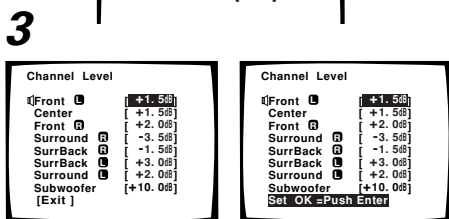
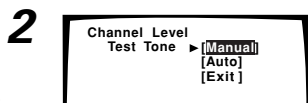
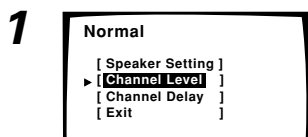

in MANUAL setting

in AUTO setting

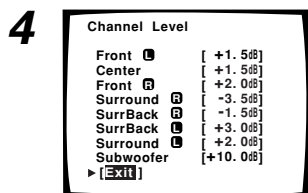

- If your subwoofer has a volume control, set it to the middle position before doing these operations.
- If you are using a Sound Pressure Level (SPL) meter take the readings from your main listening position and adjust the level of each speaker to 75dB SPL (C-weighting/ slow reading).
- The volume of the subwoofer test tone tends to sound lower than it actually is. You may need to adjust the level after testing your system with an actual soundtrack.

**1 CHANNEL LEVEL should be selected. If it isn't use the ▲▼ buttons to select and press ENTER.**

**2 There are two ways to set the CHANNEL LEVEL: MANUAL or AUTO. Select a setting mode with the ▲▼ buttons and press ENTER.**

Test tones will be output.

**WARNING : Be prepared! The test tones are output at a high volume level.**

MASTER VOLUME rotates to the reference position (0 dB) and the display on the receiver flashes TEST TONE. After a few seconds the test tone is output.

**MANUAL:** move the test tone manually and adjust the channel level.

**AUTO:** the test tone moves by itself and you adjust the levels.

**3 Adjust the speaker level with the below instructions for the method you chose.**

Adjust the channel level from -10 dB to +10 dB in 0.5 dB increments.

The default setting is 0 dB.

**In MANUAL (manual test tone) mode**

To switch the test tone between each speaker use the ▲▼ buttons and push ENTER. Adjust the level of each speaker using the ▲▼ buttons and ENTER. When done go to step 4.

**In AUTO (automatic test tone) mode**

This mode switches the test tone between each speaker automatically. The test tone output cycles through the speakers in the following order:

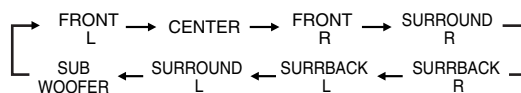

Adjust the level of each speaker using the ▲▼ buttons as the test tone is emitted and wait for it to move to the next speaker. When done go to step 5.

**If you want to change a setting before proceeding** you need to complete the procedure and start over from step 1.

**4 When you have the levels you want press ENTER. EXIT should be selected (if it isn't select it with the ▲▼ buttons).**

**5 Press ENTER.**

Next, proceed to CHANNEL DELAY next page.  
Download from [www.Somanuals.com](http://www.Somanuals.com). All Manuals Search And Download.

## CHANNEL DELAY

Adding a slight delay to some speakers is necessary to achieve proper sound depth, separation as well as an effective surround sound effect. You need to figure out the distance from your listening position to your speakers to add the proper delay. The following steps show you how to set the delay time for each channel by specifying the distances from your listening position to each speaker. Once you specify the speaker distances (or it is done automatically in the Easy Setup Guide Part 2), the receiver calculates the correct delay times automatically. If continuing from CHANNEL LEVEL go to step 1. If starting fresh, complete steps 1-2 on page 39.

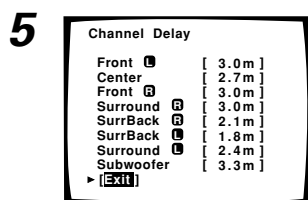
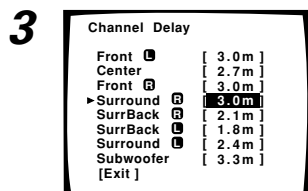
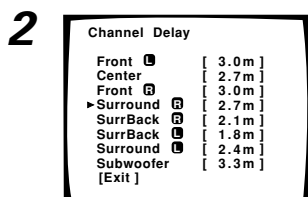
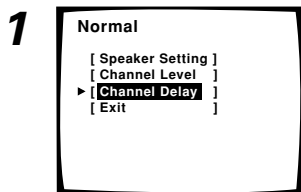
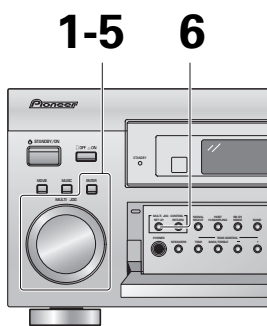
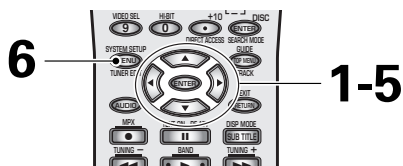

**1 The CHANNEL DELAY should be selected. If it isn't use the ▲▼ buttons to select it. Press the ENTER button.**

The setup possibilities appear on your TV

**2 Select each speaker channel with the ▲▼ buttons and press ENTER.**

**3 Use the ▲▼ buttons to add or subtract the distance in feet that the speaker is from your normal listening position. Press the ENTER button.**

Adjust the speaker distance in 0.1 m increments from 0.1 to 9.0 m.

The default setting is 2.0 m.

**4 Repeat steps 2 & 3 for all speaker channels.**

**5 Use the ▲▼ buttons to select EXIT and press ENTER.**

If you want to change a setting before proceeding start over from step 1.

**6 Press the SYSTEM SETUP button to leave the SYSTEM SETUP mode.**

# Basic Operation



## Stereo and Multichannel Playback

The following instructions show you how to play sound sources with the VSX-D2011.

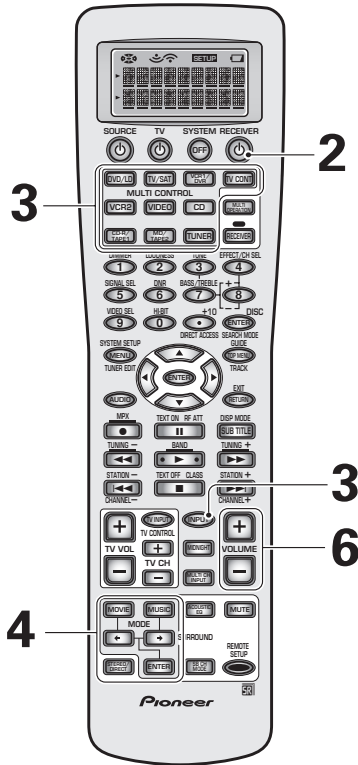
Before doing so be sure to complete the setup procedures described in the "Easy Setup Guide Part 2" (starting on page 13) or "Setting Up for Surround Sound" (starting on page 36). This is particularly important to achieve a surround sound effect with Dolby Digital or DTS sources.



**1 Turn on the power of the playback component.**

**2 Press the  OFF  ON button to put the receiver in ON mode. Press the  STANDBY/ON button to turn on the receiver.**

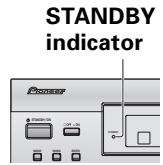

Be sure that the STANDBY indicator turns off on the front panel.



**3 Press the MULTI CONTROL (or INPUT) on the remote control to select the source you want to playback.**

Choose the type of signal input with the SIGNAL SELECT button. See the next page for more details, if necessary.

**4 Choose a LISTENING MODE one of two ways.**

For SURROUND modes: press MOVIE or MUSIC, use the   buttons to select the mode you want and press ENTER.

For STEREO/DIRECT: for press the button for that mode.

On the front panel, use the MOVIE or MUSIC buttons and the MULTI JOG dial. Press the button of the mode type you want and then use the dial to cycle through the possibilities. Press ENTER.

See "SURROUND Modes," on pages 47–48 for details on which modes are available and in which situations they are designed to be used.

**5 Start playback of the component you selected in step 3.**

**6 Adjust the volume by using the VOLUME buttons on the remote control. On the front panel use the MASTER VOLUME dial.**

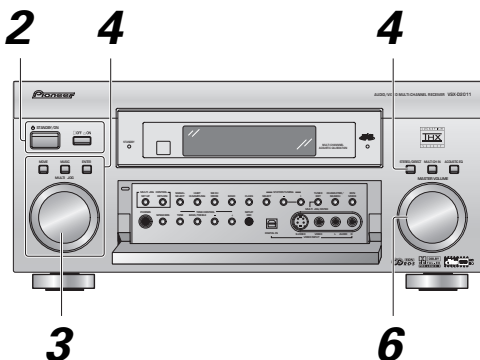

## Switching ANALOG/DIGITAL Signal Input

This button selects the type of input signal, ANALOG or DIGITAL, sent to the receiver. You need to take special care to switch to the appropriate input when necessary. For example, the switch would have to be on DIGITAL to hear digital sources like Dolby Digital or DTS but it would have to be on analog to record from the ANALOG out jacks on the receiver. The default setting is AUTO (which chooses digital over analog when both are available but goes with whatever is available) for: DVD/LD, TV/SAT, VIDEO, CD, CDR/TAPE1. The default setting is ANALOG for: VCR1/DVR, VCR2, MD/TAPE2, TUNER, PHONO. The default setting is DIGITAL for USB.

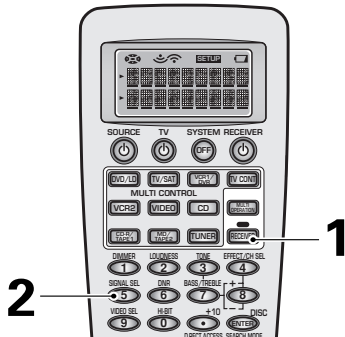

### 1 Press RECEIVER.

### 2 Press the SIGNAL SEL (SIGNAL SELECT on the front panel) button to select the input signal corresponding to the format of the source component.

Each press switches the signal in the order below:

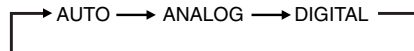

2



- When DIGITAL signal is selected, **DD** DIGITAL lights when a Dolby Digital signal is input; DTS lights when a DTS signal is input.
- If no digital inputs are assigned (see page 91) you can only choose ANALOG in the SIGNAL SELECT.
- Because the audio signal from a karaoke microphone and LDs are recorded with analog audio only, they are not output from the digital outputs. Set SIGNAL SELECT to ANALOG to listen to these formats.
- When an LD with DTS is played back with the SIGNAL SELECT set in ANALOG, digital noise caused by playing back the DTS signal directly (with no decoding) is output. To prevent noise, you need to make digital connections (See pages 22 & 23) and set SIGNAL SELECT to AUTO or DIGITAL.
- Some DVD players don't output DTS signals. For more details, refer to the instruction manual supplied with your DVD player.
- This receiver can only play back Dolby Digital, PCM (32kHz, 44.1kHz, 48kHz, 88.2kHz and 96kHz sampling frequency), and DTS digital signal formats. If your source is not one of these select ANALOG for playback.

# Listening Modes

The three listening mode types on the receiver are explained here (to select listening modes see page 44). The kind of playback you can get in the three modes depends on what kind of a source (DVD, etc.) you are using. The basic distinction is between 2 channel sources and multichannel sources. The MOVIE and MUSIC modes that are available to you will also differ according to your source and which SB CH MODE you choose. This is explained below as well.

For home theater the MOVIE and MUSIC listening modes are designed to deliver realistic and powerful multichannel surround sound that recreates the movie theater or concert experience. The first four MOVIE modes (THX CINEMA, DOLBY PRO LOGIC II (MOVIE), DOLBY PRO LOGIC, NEO:6 CINEMA) and first two MUSIC modes (DOLBY PRO LOGIC II MUSIC, NEO:6 MUSIC) incorporate pure decoding of the signal. That is they present it as it was recorded in the sound studio. The other modes are DSP modes. They add some type of effect to the signal. You may need to experiment with these modes to see which suit your home system and personal tastes. The MUSIC and STEREO modes are designed to be used with music sources but some MUSIC modes are also suitable for film soundtracks. Again, try different modes with various soundtracks to see which you like but you must choose one of the MOVIE and MUSIC listening modes in order to get surround sound. Depending on your setup, in STEREO mode only the front two speakers, and sometimes the subwoofer (if you have one), are used.

## STEREO modes

When a source is played in this mode, it plays through just the front left and right speakers (and possibly your subwoofer depending on your speaker settings). Dolby Digital and DTS multichannel sources are downmixed to stereo.

### STEREO

In STEREO mode the audio plays according to the surround setup settings and you can still use ACOUSTIC CALIBRATION EQ, DIGITAL NR, MIDNIGHT, LOUDNESS, HI-BIT HI-SAMPLING mode, and TONE Control functions.

### DIRECT

In DIRECT mode, the audio bypasses all types of signal processing to remain as close to the source audio quality as possible.



If you switch on ACOUSTIC CALIBRATION EQ, DIGITAL NR, MIDNIGHT, LOUDNESS, HI-BIT HI-SAMPLING mode, and TONE Control when DIRECT is selected, the receiver automatically switches to STEREO.

## MOVIE modes (SURROUND mode)

The MOVIE mode is a newly designed system for enhancing movie soundtracks and other audio-visual sources that optimizes its effects in accordance with your source, SB CH MODE and speaker configuration. The first four modes (THX CINEMA, DOLBY PRO LOGIC II MOVIE, DOLBY PRO LOGIC, NEO:6 CINEMA) are for pure decoding of multichannel sound sources (for example, Dolby Digital or DTS). With these modes the receiver will automatically employ the format of the sound source (for example, Dolby Digital or DTS) and display it on receiver. With two channel sources these first four modes will create surround channels. Next, there are six PIONEER original sound modes that use DSP (Digital Signal Processing) to create different types of sound environments as described below.

### THX CINEMA

THX is a set of technical standards created by Lucasfilm Ltd. These standards were designed to emulate a film sound stage and thus reproduce, with the greatest possible accuracy, the soundtrack intended by the filmmakers.

### DOLBY II MOVIE (DOLBY PRO LOGIC II MOVIE)\*

This mode gives 5.1 channel surround sound. It is suitable for movies, especially those recorded in Dolby Surround. The channel separation and movement of surround effects is comparable to Dolby Digital 5.1. With sources other than stereo (5.1, etc.) the display will automatically show the type of decoding being employed (Dolby Digital, DTS-ES, etc.).

### DOLBY PRO LOGIC\*

This mode gives 4.1 channel surround sound. It is less sensitive to the quality of the source material, so may be useful when DOLBY PRO LOGIC II MOVIE or DOLBY PRO LOGIC II MUSIC modes do not give good results. With sources other than stereo (5.1, etc.) the display will automatically show the type of decoding being employed (Dolby Digital, DTS-ES, etc.).

### NEO:6 CINEMA\*

This mode gives 6.1 channel surround sound and is suitable for movies. The NEO:6 Cinema mode delivers good channel separation for movie soundtracks. With sources other than stereo (5.1, etc.) the display will automatically show the type of decoding being employed (Dolby Digital, DTS-ES, etc.).

### ACTION

This mode is designed for action movies, which generally use lots of sound effects. The mode enriches the sound to make it more realistic and extends the parameters to pick up high and low sound effects.

### SCI-FI

This mode is designed for science fiction movies. It creates a broad sound space, separating dialog from sound effects to heighten the overall impact of the soundtrack.

### DRAMA

This mode is designed for movies with a lot of dialog. The elements of dialog are enhanced, making the characters seem more real. The mode also compresses the dynamic range somewhat so loud sounds do not overpower softer ones (compare this with the MIDNIGHT listening mode explained on page 50).

### MUSICAL

This mode is primarily for music and adds a spacious feeling to the sound. A long delay time of reflected sounds provides resonant tones which emulate a concert hall.

### MONOFILM

This mode is designed for older movies which are recorded with mono soundtracks. The special sound processing of this mode will allow you to experience these movies in surround sound even though they were not recorded that way originally.

### 5/7-D THEATER

This mode is especially designed to give sound depth to stereo sources. The overall effect builds a dynamic and broad sound space, allowing two-channel (stereo) signals to faithfully imitate a five speaker sound. The mode should be used in conjunction with Dolby Pro Logic for sources bearing the  mark. The display will show either 5-D THEATER or 7-D THEATER according to the source, SB CH MODE and speaker configuration.

\* When you input a multichannel signal the decoding is done automatically so you cannot choose these modes.

### MUSIC modes (SURROUND mode)

The MUSIC modes allow you to transform your living room into a variety of different sonic environments when playing either two-channel or multichannel sources. It optimizes its effects in accordance with your source, SB CH MODE and speaker configuration. The first two modes (DOLBY PRO LOGIC II MUSIC, NEO:6 MUSIC) for pure decoding of multichannel sound sources (for example, Dolby Digital or DTS). With these modes the receiver will automatically employ the format of the sound source (for example, Dolby Digital or DTS) and display it on receiver. With two channel sources these first two modes will create surround channels. Then there are five PIONEER original sound modes that use DSP (Digital Signal Processing) to create different types of sound environments as described below. Lastly, the 5/7-CH STEREO mode simply outputs a stereo signal through all of your speakers.

#### **DOLBY PRO LOGIC II MUSIC\***

This mode gives 5.1 channel surround sound and is suitable for music. Compared to the Movie Mode PRO LOGIC, the surround effect is more enveloping. With sources other than stereo (5.1, etc.) the display will automatically show the type of decoding being employed (Dolby Digital, DTS-ES, etc.).

#### **NEO:6 MUSIC\***

This mode gives 6.1 channel surround sound and is suitable for music. The NEO:6 Music mode plays the stereo source as is through the front left/right speakers, and generates a natural, ambient surround and center sound. With sources other than stereo (5.1, etc.) the display will automatically show the type of decoding being employed (Dolby Digital, DTS-ES, etc.).

#### **CLASSICAL**

Simulates the acoustic effects of a large concert hall. Suitable for classical music. A long delay time of reflected sounds, coupled with reverb effects, let the listener experience the dynamic and rich sounds characteristic of concert halls and powerful orchestral performances.

#### **CHAMBER**

Simulates the acoustic environment of a very resonant concert hall. Rich reverberation and a full sound create the impression of a lively performance space.

#### **JAZZ**

Simulates the acoustic effects of a jazz club. Reflected sound is virtually below 100 msec so that the listener can experience a live band effect.

#### **ROCK**

Simulates the acoustic effects of a mid-sized concert hall. The listener can experience a live band effect with good separation of the instruments, a strong bass and the vivid feeling of a live performance.

#### **DANCE**

Simulates the acoustic effects of a dance club. Features a strong bass sound. Reflected sound delay time is virtually below 50 msec, for the listener to experience the visceral power of dance music.

#### **5/7-CH STEREO**

Simulates the acoustic environment of a regular stereo while using all the speakers in the system to induce a rich, all-around sound. The display will change to 5-CH STEREO or 7-CH STEREO according to the SB CH MODE and speaker configuration.

\*When you input a multichannel signal the decoding is done automatically so you cannot choose these modes.



## Adjusting the Effect of a Listening Mode

The DSP (Digital Signal Processing) listening modes have sound processing added to accentuate a certain kind of atmosphere or effect (see the preceding pages for explanation). You can choose if you want to strengthen or weaken this effect in the given mode. The DSP MOVIE modes are: ACTION, SCI-FI, DRAMA, MUSICAL, MONOFILM, 5/7-D THEATER. The DSP MUSIC modes are: CLASSICAL, CHAMBER, JAZZ, ROCK, DANCE. The following instructions show you how to adjust the amount of effect.

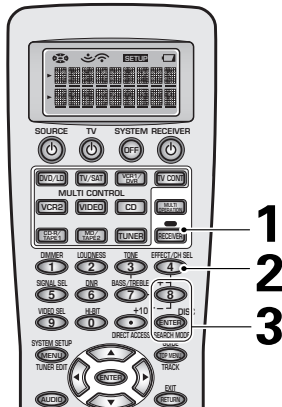

**1 Press RECEIVER.**

**2 Press the EFFECT/CH SEL button repeatedly until you see EFFECT in the receiver's display.**

**3 Use the +/- buttons to add or subtract the amount of effect.**



- The amount of effect can be adjusted ranging from 10 to 90 (the default setting value is 50) by pressing +/-.

## Adding/Adjusting the Effect in Dolby Pro Logic II MUSIC Mode

The Dolby Pro Logic II MUSIC mode has three settings you can choose from which adjust the spatial feeling of the surround sound. These settings are best matched to each individual source instead of one setting being left on for all sources. The three settings and how to apply them are explained here. To start this setup select Dolby Pro Logic II (if necessary) with the MUSIC button.

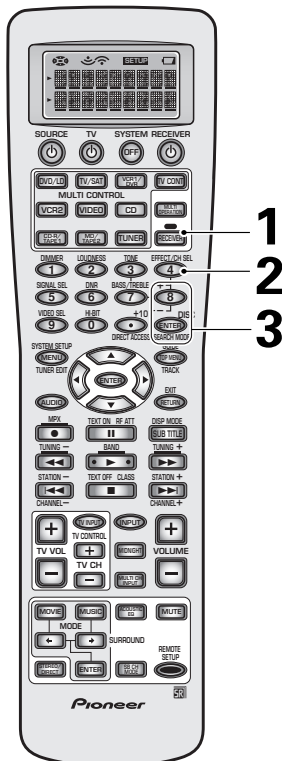

**1 Press RECEIVER.**

**2 Press the EFFECT/CH SEL button repeatedly and select the setting you want. They appear in the receiver's display.**

**CENTER WIDTH :** With Pro Logic decoding center channel signals can come only from the center speaker. If no center speaker is present this channel is split between the two front speakers, creating a "phantom" channel. The CENTER WIDTH feature lets you adjust the center channel so it can be heard only from the center speaker, only as a "phantom" channel or in varying degrees of both.

**DIMENSION:** This allows you to adjust the soundfield towards the front or towards the rear of your room.

**PANORAMA:** This gives the music a wraparound surround feel.

**3 Use the +/- buttons to add or subtract the amount of effect or turn on/off.**

**CENTER WIDTH :** Strengthen or weaken the effect between 0-7. The default is 3.

**DIMENSION:** Move soundfield backward or forward with -3 being the furthest back and +3 being the furthest forward. The default is 0.

**PANORAMA:** Turn on or off. The default is off.

## Listening with ACOUSTIC CALIBRATION EQ

You can listen to the soundtrack with the ACOUSTIC CALIBRATION EQ you set automatically when you did the AUTO SURROUND SETUP (see page 13) or you set manually on page 99–101. To do so follow the instructions below.

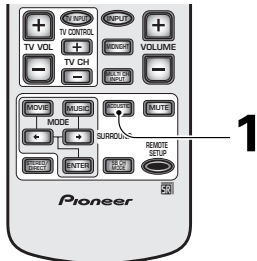

### 1 Press the ACOUSTIC EQ button.

Each press switches ACOUSTIC CALIBRATION EQ between ALL CH ADJUST, FRONT ALIGN, CUSTOM 1, CUSTOM 2 and OFF. When ACOUSTIC EQ is being applied the MCACC indicator lights.

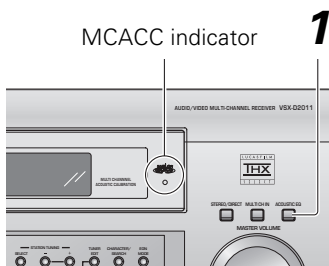
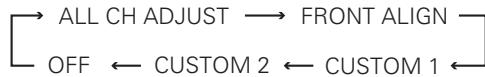

- After completing the AUTO SURROUND SETUP (page 13) ACOUSTIC EQ ON (ALL CH ADJUST) is set automatically.
- You can't turn on ACOUSTIC EQ on in MULTI CH IN mode.
- If you turn ACOUSTIC EQ on in DIRECT mode, the receiver automatically switches to STEREO mode.

## Reducing Noise During Playback (DIGITAL NR Function)

To reduce extraneous noise switch on DIGITAL NR. This feature is effective with sources containing a lot of background noise like cassette and video tape

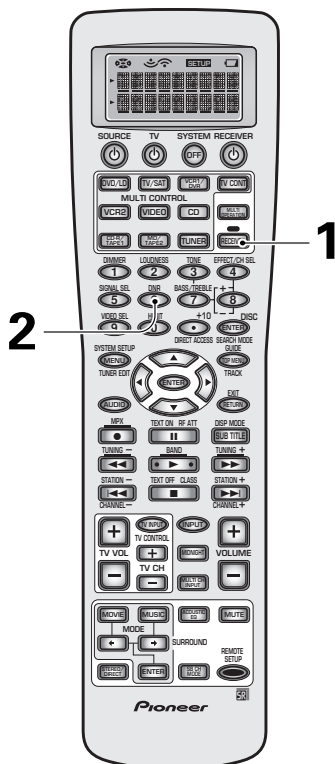

### 1 Press RECEIVER.

### 2 Press the DNR button on the remote control.

Each press switches DIGITAL NR on or off. When on, DNR lights in the display.



- In cases described below, noise may not be reduced even if DIGITAL NR is on.
  - Sudden noise
  - Extremely loud noise
  - Signals that contain too many high frequencies
  - Signals which are very clean to begin with.
- DIGITAL NR is effective at levels shown below for each source.
 

STEREO	
• Analog input	10-18 dB
• Digital input	10-15 dB
• AM/FM tuner	10-15 dB
MOVIE/MUSIC	6-10 dB
- Depending on the condition of the source, there may not be a noticeable improvement in the quality of the sound.
- You can't use the DIGITAL NR mode with the THX CINEMA or MULTI CH IN modes, or a 96 kHz signal.
- If you set the DIGITAL NR on in DIRECT mode the receiver will switch to STEREO mode.

## Listening in MIDNIGHT Mode

This useful feature makes it possible to get excellent surround sound effects even when listening at low volumes. It can be used with any surround sound source and play soundtracks so that the quieter sounds are audible even while playing a soundtrack at low volumes. This feature is applicable only when the master volume is under  $-20$  dB.

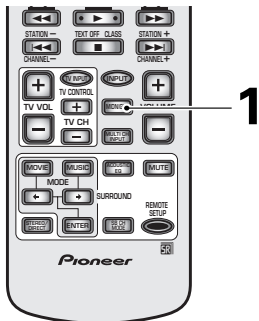

### 1 Press the MIDNIGHT button on the remote control.

Each press switches MIDNIGHT mode on or off. When on, MIDNIGHT lights in the display.



- The surround effect adjusts itself automatically in accordance with the volume level.
- You can't use the MIDNIGHT mode with the THX CINEMA, MULTI CH IN modes.
- If you set MIDNIGHT on when in DIRECT mode the receiver switches to STEREO mode.

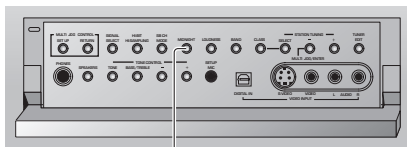

multi-voltage model only

1

## Listening in LOUDNESS Mode

The LOUDNESS mode boosts the bass and treble in a signal. It is useful for listening to music at low volumes. This feature is applicable only when the master volume is under  $-20$  dB.

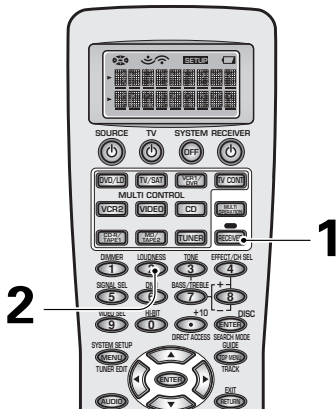

### 1 Press RECEIVER.

### 2 Press the LOUDNESS button on the remote control.

Each press switches LOUDNESS mode on or off. When on, LOUDNESS lights in the display.



- You can't use the LOUDNESS mode with the THX CINEMA, MULTI CH IN modes.
- If you set LOUDNESS on in DIRECT mode the receiver will switch to STEREO mode.

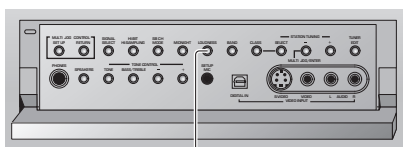

multi-voltage model only

1

## Adjusting Bass and Treble (TONE CONTROL)

You can adjust the low (bass) and high (treble) frequencies. The TONE button can also be used to bypass the tone circuitry.

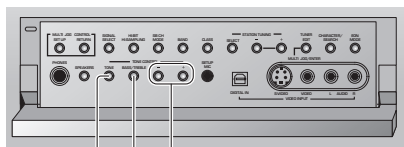
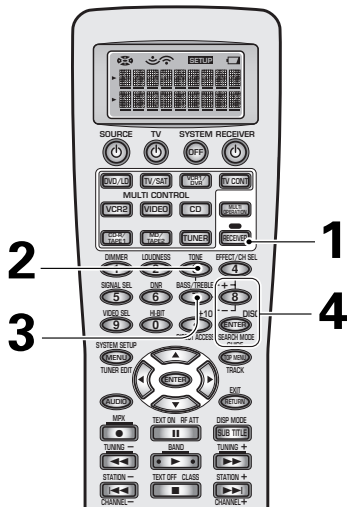

2 3 4

### 1 Press RECEIVER.

### 2 Press the TONE button on the remote control or the front panel to put the receiver in tone adjust mode.

There are two tone modes TONE: ON and TONE: BYPASS. The first means the tone functions are active and also lets you adjust these functions. The second means the tone controls are being bypassed, and thus have no effect on the sound.

### 3 Press the BASS/TREBLE button repeatedly to select BASS or TREBLE.

If TONE: BYPASS appears, press the TONE button to get TONE: ON.

### 4 Use the +/- buttons to adjust the low or high frequency levels.

A few seconds after you finish adjusting the tone the receiver will revert to the sound mode it was in at the beginning of the process.



- The TONE CONTROL can be adjusted in a range of  $\pm 6$  dB.
- The TONE CONTROL cannot be set on in THX CINEMA, MULTI CH IN modes.
- If you set TONE CONTROL on in DIRECT mode the receiver will switch to STEREO mode.

## Listening in HI-BIT/SAMPLING mode

Use to hear CD and DVD, as well as other digital soundtracks, at a wider dynamic range, allowing for finer audio reproduction.

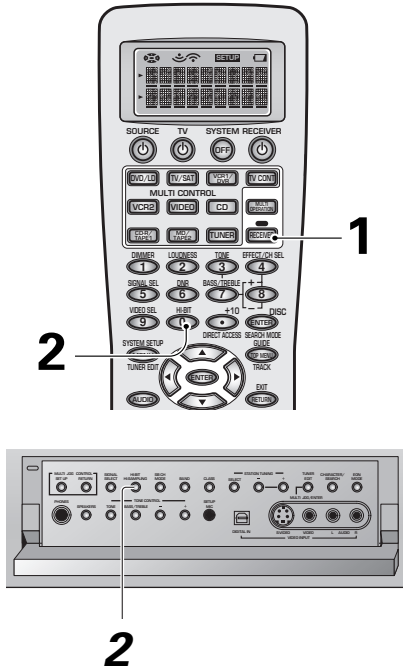

**1 Press RECEIVER.**

**2 Press the HI-BIT button on the remote control or HI-BIT HI-SAMPLING button on the front panel.**

Each press switches HI-BIT/SAMPLING mode on or off. HI-BIT/SAMPLING lights in the display.



- HI-BIT mode cannot be set on MULTI CH IN mode.
- If the receiver is in DIRECT mode and you press the HI-BIT button the receiver will switch to STEREO mode.
- This feature can't be used with 96 kHz and 88.2 kHz sources.

## DVD-Audio/MULTI CHANNEL IN Playback

MULTI CH IN allows you to connect a DVD-Audio player or an external decoder to enjoy certain multichannel discs. To use MULTI CH playback follow the instructions below.

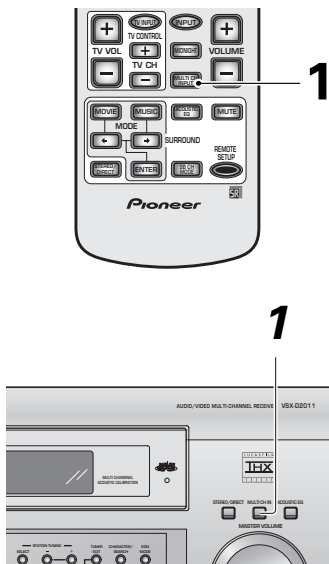

**1 Press the MULTI CH INPUT button on the remote control or the MULTI CH IN button on the front panel.**

Each press switches the input between the previous mode and MULTI CH IN.

**ON:** This is a true playback of the signal from the MULTI CH INPUT terminals, output without digital processing. You can only control each channel level.

**OFF:** Cancels the MULTI CH IN modes.



- You can't use any kind of sound processing with MULTI CH IN. Selecting a listening mode, or switching these modes, cancels the MULTI CH IN.
- If any speakers are set to NO the signal for that (those) channel(s) won't get output at all.
- You cannot set sound features (page 50-52) on, in MULTI CH IN mode.
- You cannot listen to the SECOND ZONE in MULTI CH IN mode.
- If you're listening to DVD-Audio but can only get stereo sound set your DVD player's 5.1 channel analog playback to on.

## SB CH MODE button

### SB CH MODE

The SB CH MODE makes available surround back channels through your surround back speakers. You must have chosen NORMAL SYSTEM in the SURRBACK SYSTEM setting (see page 37) and have SURROUND and SURROUND BACK speakers set to something other than NO (see pages 40–41) to use this feature. To accomplish the same settings, you could have had the AUTO SURROUND SETUP automatically set the SURROUND and the SURROUND BACK speakers on (see pages 13–15).

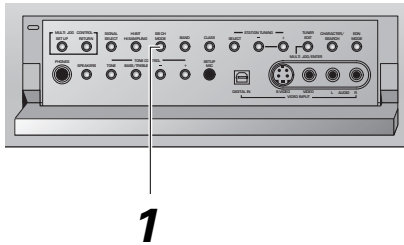
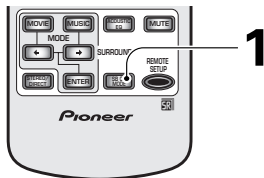

#### 1 Press the SB CH MODE button on the remote control.

Each press switches between ON, OFF and AUTO.



For each choice you can create SURROUND BACK channels under the conditions listed below.

**ON:** surround back channels are available with all SURROUND modes;

**AUTO:** same as above except whether SURROUND BACK channels are available with any of the PRO LOGIC II (or PRO LOGIC) modes depends on whether the source has an EX or ES flag or not.

With the NEO:6 modes surround back channels will always be available.

**OFF:** SURROUND BACK channels will not be heard.



- You can't use the SB CH MODE with MULTI CH IN or STEREO/DIRECT modes.

### VIRTUAL SURROUND BACK Mode

The VIRTUAL SURROUND BACK mode emulates surround back channels through your surround speakers. You must have chosen NORMAL SYSTEM in the SURRBACK SYSTEM setting (see page 37); have SURROUND speakers set to something other than NO, and have chosen NO for the SURROUND BACK speakers in SPEAKER SETTING (see page 40-41) to use this mode. To accomplish the same settings, you could have had the AUTO SURROUND SETUP automatically set the SURROUND speakers on and the SURROUND BACK speakers off (see pages 13-15) to use this mode.

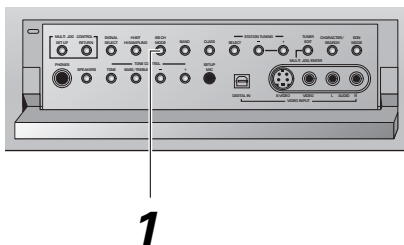
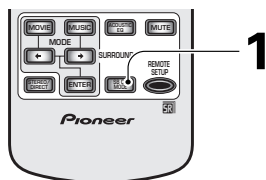

#### 1 Press the SB CH MODE button on the remote control.

Each press switches between VIRT SB ON, VIRT SB OFF and VIRT SB AUTO.

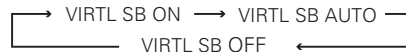

For each choice you can create VIRTUAL SURROUND BACK channels under the conditions listed below.

**VIRT SB ON:** virtual surround back sound is available with all SURROUND modes except THX CINEMA; for a stereo signal you must choose the NEO:6 MOVIE/MUSIC SURROUND mode or a Pioneer original sound mode (see pages 47–48).

**VIRT SB AUTO:** same as above except whether virtual surround back sound is available with any of the PRO LOGIC II (or PRO LOGIC) modes depends on whether the source has an EX or ES flag or not.

With the NEO:6 modes virtual surround back sound will always be available.

**VIRT SB OFF:** virtual surround back sound will not be heard.



- You can't use the VIRTUAL SURROUND BACK mode with the THX CINEMA, MULTI CH IN, STEREO/DIRECT modes.

## DUAL MONO setting and playback

The dual mono setting can only be used when listening to Dolby Digital or homemade discs that have dual mono software encoded in them. Dual mono software usually is used to put two different mono soundtracks, that you have the capability of listening to at the same time, on one DVD. With this setting you can choose which dual mono setting you want to listen to. Remember this setting is only applicable if you are using Dolby Digital software with dual mono and want to isolate one of the channels therein.



**1**

### 1 Press the RETURN button for more than three seconds to put the receiver in DUAL MONO mode.

Hold down the RETURN button to cycle through the different DUAL MONO settings. When you find the one you want release the button. The L (ch1) and R (ch2) indicators in the display light to indicate the playback channel.

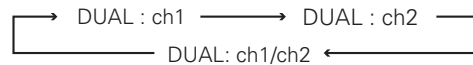

The different settings are: DUAL ch1, where you only hear channel 1; DUAL ch2, where you only hear channel 2; and DUAL ch1/ch2, where you hear both channels, but independently from different speakers.



- The default setting is DUAL ch1.
- You can only use this function with Dolby Digital sources that have this function

## Using Headphones

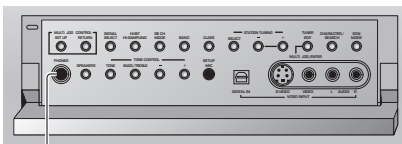

**1 PHONES jack**

### 1 Plug headphones into the PHONES jack on the front of the receiver.

No sound will be audible from the speakers when headphones are plugged in except in MULTI CH IN mode or when using the pre-outs. In MULTI CH IN mode the subwoofer will be audible even if the headphones are plugged in.



- All SURROUND modes will be downmixed to 2 channels.
- If you're listening to a 2 channel source there will be no matrix decoding (i.e. you will not be able to get surround sound decoding).
- For MULTI CH IN mode, only the signal input from the MULTI CH IN FRONT L and R channels can be heard.

## Video Select

This function allows you to listen to one sound source while you watch a different video source on your TV. The sound source is set in the normal fashion as explained on page 44. You then change the video input with the VIDEO SEL button.

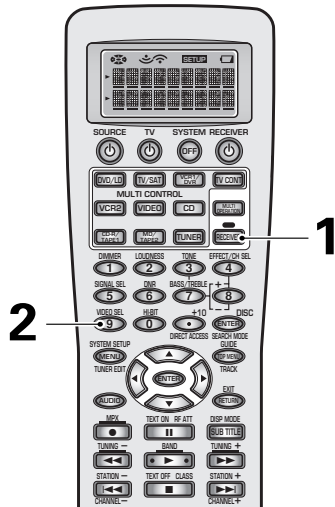

### 1 Press RECEIVER.

### 2 Press the VIDEO SEL button on the remote control to cycle through the different possible video inputs.

The first press shows the video input you are currently using. After that pressing VIDEO SELECT cycles through the possibilities in the following order:

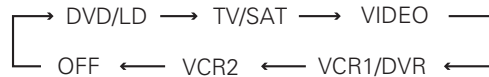

The OFF setting means you are listening without a video signal. (Also, when you select CD, CD-R/TAPE1, MD/TAPE2, TUNER, PHONO, USB or functions the VIDEO SELECT will be set to off.)

After choosing a video input the display on the receiver will show that input for about 5 seconds and then revert to showing the listening mode the receiver is in.



- The VIDEO SELECT remains set to the input you chose until you change the audio input.
- If you change audio functions the receiver will reset itself to make the video and audio inputs correspond. Also, if you switch the power of the receiver off when you turn it back on the video and audio inputs will reset so that they correspond.

## Adjusting the Brightness of the Display (DIMMER)

Use the display DIMMER button to adjust the brightness of the fluorescent display.

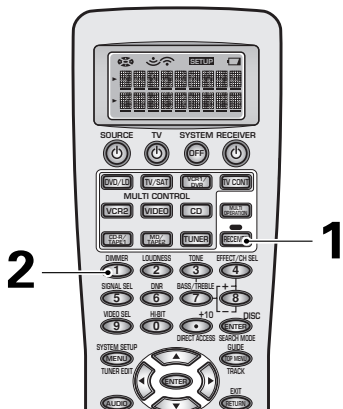

### 1 Press RECEIVER.

### 2 Use the display DIMMER button on the remote control to alternate between the different levels of brightness for the display.

Four levels of brightness ranging from very dim to very bright can be selected. Each press changes the brightness of the display. When cycling through the options, the default brightness can also be selected.



- It is a feature of this unit that the fluorescent display will be brighter for a few seconds after you choose a function (like DVD/LD, CD, etc.) and then get softer. This will still happen when you adjust the brightness but the new setting will be the one the display softens to.



# Using the Tuner

## Automatic and Manual Tuning

The following steps show you how to tune in FM and AM radio broadcasts using the automatic (search) and manual (step) tuning functions. If you already know the exact frequency of the station you want, see "Direct Access Tuning" on the following page.

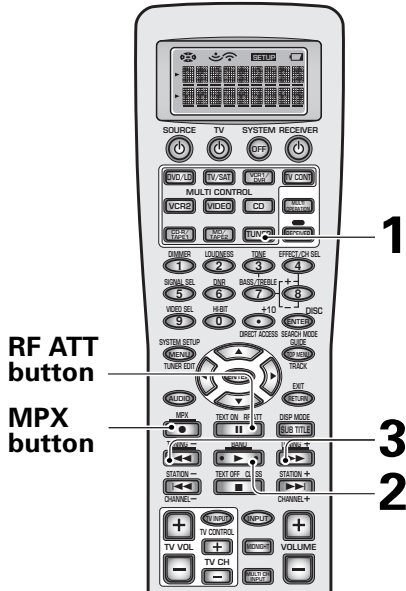

### 1 Press the TUNER button.

On the remote, this selects the tuner function on the receiver and sets the remote to the tuner operation mode.



### 2 Press the BAND button to select the band (FM or AM).

Each press switches the band: FM ↔ AM

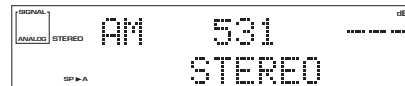

### 3 Tune in the station.

#### For Automatic Tuning

Press and hold TUNING  $-/+$  for about one second, then release.

The tuner starts searching the selected band and stop automatically at the first station it locates. Repeat to locate other stations.

#### For Manual Tuning

- To change frequencies one step at a time, press TUNING  $-/+$  repeatedly.
- To change frequencies quickly, hold down TUNING  $-/+$  and release when you reach the frequency you desire.

European model

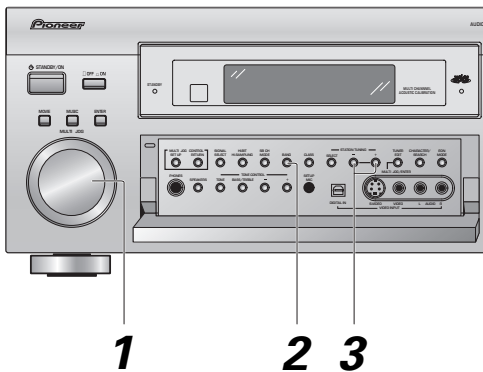

multi-voltage model

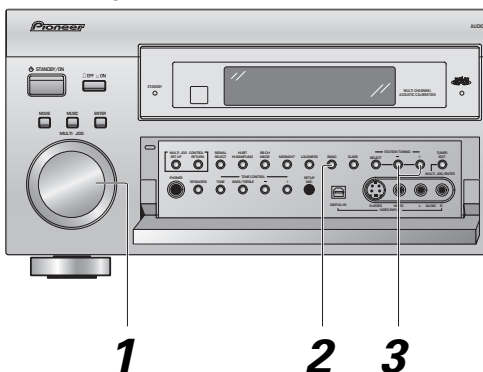

### MPX Mode

If the TUNED or STEREO indicators do not light when tuning an FM station, because the station is too far away or the broadcast signal is weak, press MPX on the remote control to switch to MONO reception. This should improve reception enough for you to enjoy the broadcast.

### RF ATT Mode (European model only)

If the radio signal is too strong and/or the sound is distorting press the RF ATT button to attenuate (lower) the radio signal input and reduce the distortion (for FM stations only). When on, RF ATT lights in the display.

# Channel Step Setting (multi-voltage model only)

The unit has been factory preset to the channel allocation value for the area in which it is to be sold. If this value is set incorrectly, the tunes in frequency may be wrong, or sound may be distorted, resulting in an inability to reproduce reception signals at their proper sound quality. For this reason, be sure to confirm that the values are set correctly before first using the unit.

### FM 50 kHz, AM 9 kHz:

Set to this position, for areas with an FM reception step of 50 kHz and AM 9 kHz.

### FM 100 kHz, AM 10 kHz:

Set to this position for areas with an FM reception step of 100 kHz and AM 10 kHz.



When unsure about the channel allocation for your area, consult your dealer for correct information.

## To Change Channel Steps

- 1 Turn the power off (standby mode).
- 2 While holding down the TONE – button press the STANDBY/ON button.
- 3 When you see **STEP 9K/50K** or **STEP 10K/100K** appear in the display. To change channel steps again repeat steps 1 and 2.

## Direct Access Tuning

The following steps show you how to tune directly to a specific frequency using the remote control.

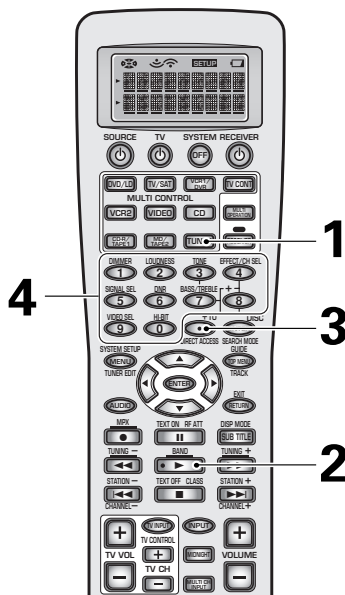

### 1 Press the TUNER button.

This selects the tuner function on the receiver and sets the remote to the tuner operation mode.

### 2 Press the BAND button to select the band (FM or AM).

Each press switches the band : FM ↔ AM

### 3 Press the DIRECT ACCESS button to activate the direct access tuning mode.

The cursor blinks in the display on the front panel.



### 4 Use the number buttons to enter the frequency of the station you want.

#### Example:

To tune station 106.00 (FM), press: ① → ⑥ → ⑥ → ① → ①

#### To cancel before inputting the frequency

Press DIRECT ACCESS, and enter the frequency again.

# Memorizing Frequently Used Stations

The following steps show you how to memorize up to 30 radio stations in 3 classes (each holding 10 stations). When memorizing FM frequencies, the receiver also memorizes the MPX mode (STEREO or MONO) and the RF ATT mode (European model only).

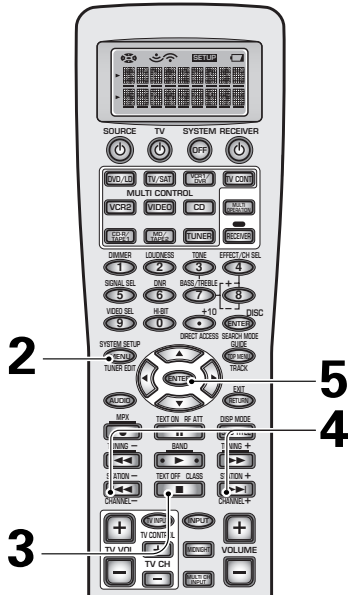

## 1 Tune in the station you want.

See "Automatic and Manual Tuning" or "Direct Access Tuning" on page 57 and 58.

## 2 Press the TUNER EDIT button to activate the memory function.



## 3 Press the TEXT OFF CLASS button repeatedly to select a class number.

Each press switches the display:

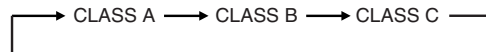

## 4 Press the STATION +/- buttons repeatedly (or use the MULTI JOG) to select a channel (0-9) within the respective class.

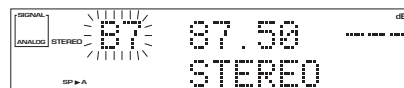

## 5 Press the ENTER button to input your choice.

European model

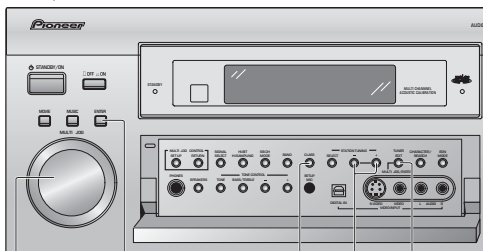

(3-4) 5                      3 4 2

multi-voltage model

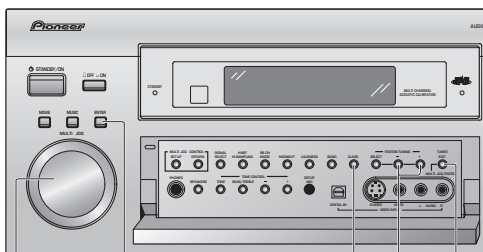

(3-4) 5                      3 4 2

## Naming Memorized Stations

You can input a name of up to four characters for each preset station in the receiver's memory (see the previous page). This name can be anything you choose. For example, you could input JAZZ for that station and when you listen to it the name, rather than the frequency number, will appear on your display.

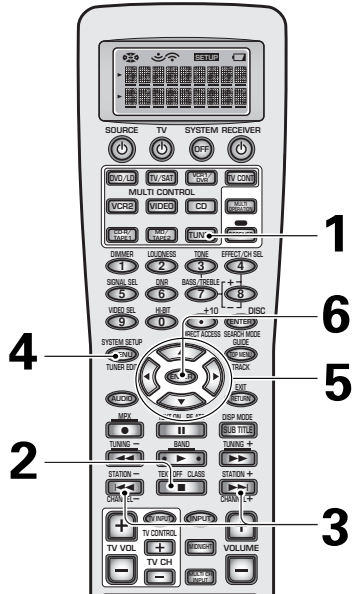

**1 Press the TUNER button on the remote control.**

**2 Press TEXT OFF CLASS repeatedly to select the class.**

Repeatedly pressing this button cycles through the three available classes, A, B and C.

**3 Press STATION + or STATION - to select the preset channel.**

**4 Press TUNER EDIT to select the station name mode.**



European model

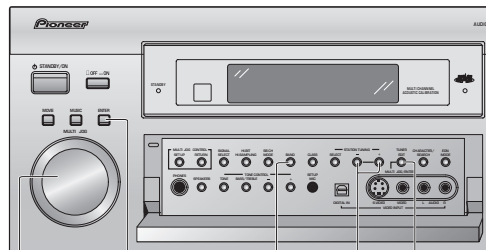

1,5 5,6 2 3,5 4

multi-voltage model

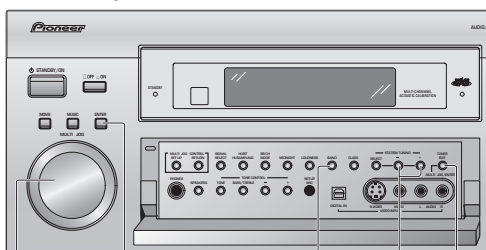

1,5 5,6 2 3,5 4

**5 Enter the station name you want.**

Names can be up to four characters long.

- On the front panel use the MULTI JOG dial or the +/- buttons. On the remote control use the STATION +/- buttons or the ◀ ▶ buttons to select characters.
- Press ENTER to confirm a character. If no character is input, a space is input.

To erase a station name, simply repeat steps 1-4 and input four spaces instead of a name.

The possible selections are shown below.

```

ABCDEFGHIJKLMNOPQRSTUVWXYZ
abcdefghijklmnopqrstuvwxyz
0123456789
!"#$%&'()*+,-./:;<=>?@[ \ ] _ {} [space]
    
```

**6 Press ENTER when you have got the characters you want to enter.**

Repeat steps 2 to 5 to memorize up to 30 preset broadcast station names.



To change a station name, enter a new name over the top of the existing one.

# Recalling Memorized Stations

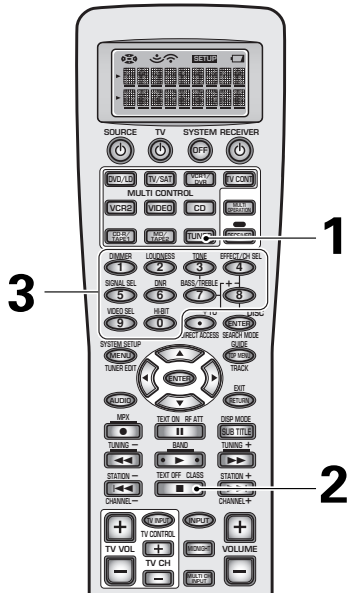

## 1 Press the TUNER button.

This selects the TUNER function on the receiver and sets the remote to the TUNER operation mode.



## 2 Press the TEXT OFF CLASS button repeatedly to select a class number.

Each press switches the display:

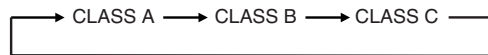

## 3 Use the number buttons to select the channel you desire.

To select channel 7, press 7.

To select channel 0, press 0.

**For example :** If 99.50 MHz (FM) was memorized in class B at channel 7.



## To step through each channel in order

Press the STATION +/- buttons repeatedly.

European model

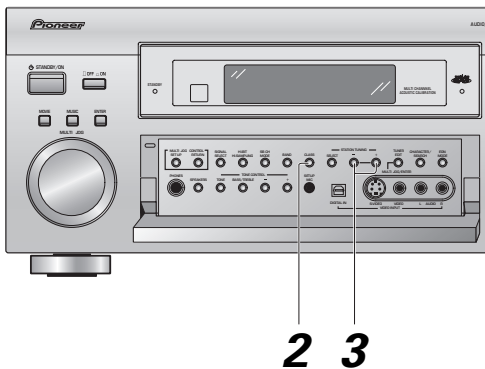

multi-voltage model

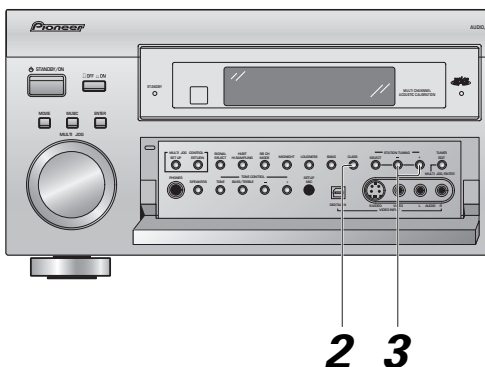

# An introduction to RDS (European model only)

Radio Data System, or RDS as it's usually known, is a system used by FM radio stations to provide listeners with various kinds of information—the name of the station and the kind of show they're broadcasting, for example. This information shows up as text on the display, and you can switch between the kind of information shown. Although you don't get RDS information from all FM radio stations, you do with most.

Probably the best feature of RDS is that you can search automatically by type of program. So, if you felt like listening to jazz, you could search for a station that's broadcasting a show with the program type, JAZZ. There are around 30 such program types, including various genres of music, news, sport, talk shows, financial information, and so on.

The receiver lets you display three different kinds of RDS information: Radio Text, Program Service Name, and Program Type.

Radio Text (**RT**) is messages sent by the radio station. These can be anything the broadcaster chooses—a talk radio station might give out its telephone number as RT, for example.

Program Service Name (**PS**) is the name of the radio station.

Program Type (**PTY**) indicates the kind of program currently being broadcast.

The receiver can search for and display the following program types:

<b>NEWS</b>	News
<b>AFFAIRS</b>	Current affairs
<b>INFO</b>	General information
<b>SPORT</b>	Sports
<b>EDUCATE</b>	Educational material
<b>DRAMA</b>	Radio drama
<b>CULTURE</b>	Arts and culture
<b>SCIENCE</b>	Science and technology
<b>VARIED</b>	Usually talk-based material, such as quiz shows or interviews.
<b>POP M</b>	Pop music
<b>ROCK M</b>	Rock music
<b>EASY M</b>	"Middle of the road" music
<b>LIGHT M</b>	'Light' classical music
<b>CLASSICS</b>	'Serious' classical music
<b>OTHER M</b>	Other music not fitting any of the above categories
<b>WEATHER</b>	Weather reports
<b>FINANCE</b>	Finance and business
<b>CHILDREN</b>	Children's entertainment
<b>SOCIAL</b>	Social affairs
<b>RELIGION</b>	Religious programming
<b>PHONE IN</b>	Phone-in talk shows
<b>TRAVEL</b>	Travel
<b>LEISURE</b>	Leisure interests and hobbies
<b>JAZZ</b>	Jazz music
<b>COUNTRY</b>	Country music
<b>NATION M</b>	Popular music in a language other than English
<b>OLDIES</b>	Popular music from the '50s
<b>FOLK M</b>	Folk music
<b>DOCUMENT</b>	Documentaries

In addition, there is a program type called **ALARM**, used for exceptional emergency announcements. You can't search for this, but the tuner will switch automatically to this RDS broadcast signal.

## Using the RDS display

To display the different types of **RDS** information available, press TUNER button on the remote control and use the DISPMODE button to cycle through the types of RDS information.

Each press changes the display as follows:

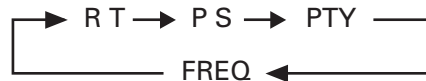

- If any noise is picked up while displaying the RT scroll, some characters may be displayed incorrectly.
- If you see NO RADIO TEXT DATA in the RT display, it means no RT data is being transmitted from the broadcast station. If you have entered a name for the station, it is displayed instead of RT data. If you haven't, the display will automatically switch to the PS data display. If no PS data is transmitted from the station, the frequency will be displayed.
- In the PTY display, there are cases where NO DATA or NO TYPE is shown. If this happens, the PS display is shown after a few seconds.
- This unit converts lower case characters transmitted by broadcast station to upper case characters.

## Searching for RDS programs (European model only)

One of the most useful features of RDS is the ability to search for a particular kind of radio program. You can search for any of the program types (listed on page 62).

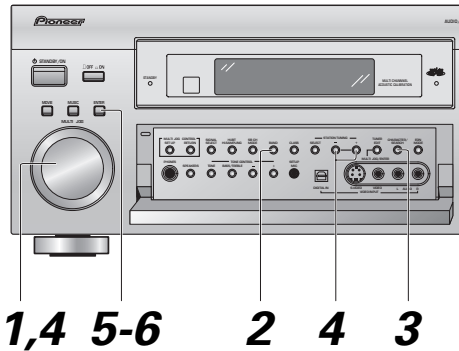

### 1 Tune into an FM station.

Refer to "Automatic and Manual Tuning" or "Direct Access Tuning" on p. 57 and 58.

### 2 Use the BAND button to select the FM band.

RDS is only broadcast on FM.

### 3 Press the SEARCH MODE button.

SEARCH shows in the display.

### 4 Press the +/- buttons or use the MULTI JOG dial to select the program type you want to hear.

### 5 Press ENTER to search for the program type.

The system starts searching through the station presets for a match. When it finds one, the search stops and the station plays for five seconds.

### 6 If you want to keep listening to the station, press ENTER within the 5 seconds.

If you don't press ENTER, searching resumes. If NO PTY is displayed it means the tuner couldn't find that program type at the time of the search.



- RDS searches memorized stations only. If no stations have been (see page 59 to do this), NO PTY is displayed.
- FINISH means the search is complete.

# Basics of EON (Enhanced Other Network information) (European model only)

When EON is turned on, the receiver jumps to an EON-linked broadcast when it begins, even if a receiver function other than the tuner is being used. It cannot be used in areas that EON information is not transmitted and when FM broadcast stations do not transmit PTY data. When the broadcast ends, the tuner returns to the original frequency or function.

There are two types of EON you can set:

1 **TA** (Traffic Announcement)

This mode will set the tuner to pick up traffic information when it's broadcast.

2 **NEWS**

This mode will set the tuner to pick up news when it is broadcast.



EON does not work when the tuner is in the AM band.

## Using EON (European model only)

Use the front panel controls to do this.

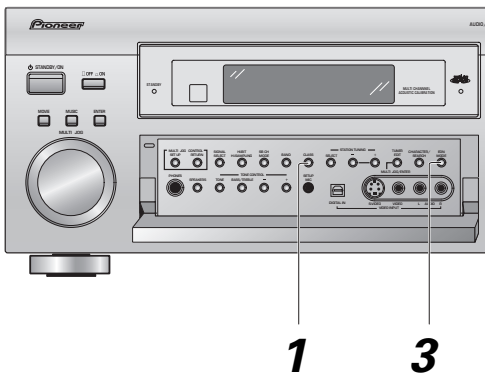

**1 Press the BAND button to select the FM band.**

EON is only broadcast on FM.

**2 Tune into an EON FM station.**

The indicator lights to inform you that the currently tuned station carries the EON data service. See pages 57–58 for more on tuning into radio broadcasts.

**3 Press the EON MODE button to select the mode you want.**

These modes are explained above.

Each press changes the display as follows:



If EON information is being transmitted, the receiver jumps to the type of broadcast you selected. When the EON mode is set, the EON indicator lights, but during actual reception of an EON broadcast the EON indicator will flash.



- The EON mode is canceled if you switch to AM reception while setting EON. It starts once again when you return to FM reception.
- You can't search for traffic announcements and news at the same time.
- You can't operate the TUNER EDIT and CHARACTER SEARCH buttons while the EON indicator is lit.
- If you want to change to a function other than the tuner, press the EON MODE button and turn the EON mode off.



## Clearing all stations from the RDS or EON search (European model only)

The receiver will automatically register an identifying marker (called a PI code) for any station you input into the memory classes which can receive RDS or EON data. If you want to remove the currently memorized stations from RDS and EON searches, you can do it by erasing the PI codes.

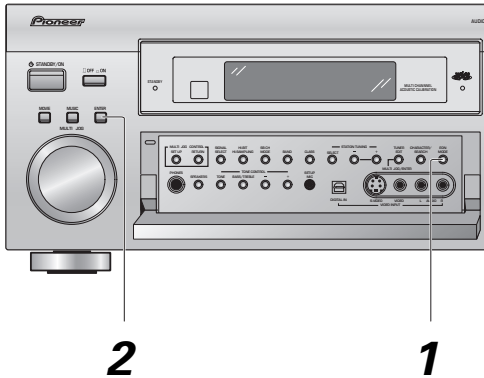

### 1 Press and hold EON MODE (front panel) for about two seconds.

ERASE PI will be displayed.

### 2 Press ENTER.

ERASE PI flashes for two seconds to indicate the PI codes have been erased.

# Remote Control of Other Components

## Setting Up the Remote Control to Control Other Components

In addition to controlling the receiver, the supplied remote control can operate your other components (VCR, TV, DVD, CD, etc.) after you program it to do so. In this way, instead of fumbling with many different controls and buttons, you only need to use one remote control. If your component(s) are listed in the remote control's memory, simply follow the steps below. If your component(s) are not listed, or if you want the remote to learn additional operations, you can use the learning mode to input the information from the remote controls supplied with your other components.

### Recalling Settings Stored in the Remote Control

The following steps show you how to recall the setting stored in the remote control. Once a setting is recalled and the component assigned, you can use this remote to easily operate the component.



- **To exit from the remote control setup mode at any time, press REMOTE SETUP.**
- See "Using Remote Control with Other Components" on pages 70 and 71 to operate your other components.
- The display will disappear after one minute or so if no new commands are entered. Press any button to wake up the remote and continue the process.

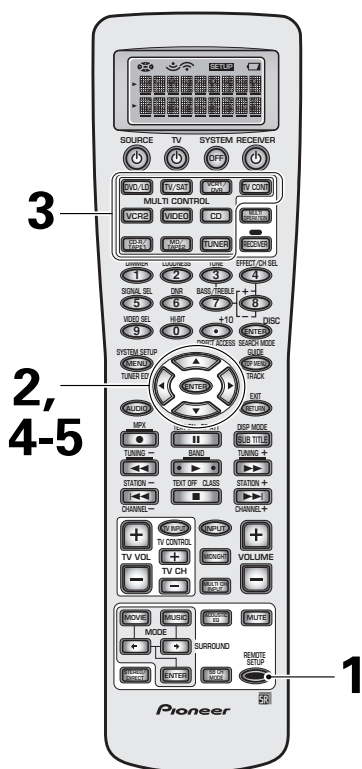

#### 1 Press the REMOTE SETUP button for three seconds.

The REMOTE SETUP menu appears on the remote display.

#### 2 PRESET should be selected (if it isn't use the ▲▼ buttons to select it) and press ENTER.

SELECT FUNCTION blinks in the display.

#### 3 Press the MULTI CONTROL button (for example, DVD/LD) you want to set.

#### 4 Use the ▲▼ buttons to select the component you want to set up. Press ENTER.

MAKER appears in the remote control display.

#### 5 Use the ▲▼ buttons to select the name of the company that makes your component. (see pages 115-116)

The company names appear in the remote control display. If there is more than one component type for that company that makes your component then -1, -2, etc., will appear in the display. Choose one of the types and see if that works.



The TUNER button cannot be assigned.

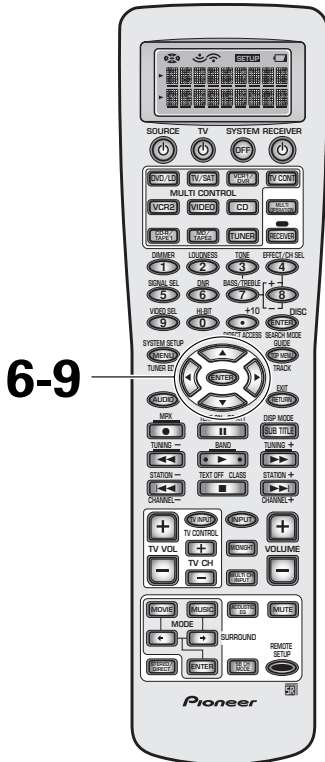

### 6 Point the remote control at the component you want set and press ENTER.

OK? will appear in the remote control display.

If the component you are trying to control turns on/off you have set it correctly. Use the ▲▼ buttons to select YES and go on to step 7.

If the component you are trying to control does not turn on/off the correct preset code has not been selected. In this case, use the ▲▼ buttons to select NO, press ENTER and go back to step 5. Try another preset code for that maker. (If the component you are trying to setup doesn't have a standby/on mode it won't turn on even if the correct preset code is entered. In this case select YES and go on to step 7.)

If you can't seem to get the component you are trying to set to turn on or off you can still set up your remote control by using the LEARNING mode (on the next page).

### 7 Press ENTER. The preset code has been entered.

COMPLETE will appear in the display.

Naturally it's easiest and most logical to assign the button that has the same name as the component you are setting up (for example, choose the DVD/LD button for your DVD player).

You may find you have components which do not correspond to the name on any MULTI CONTROL button (for example a cable TV tuner) or you have two components where only one button is provided (for example, CD-R/TAPE 1). In this case, use step 3 to assign any available MULTI CONTROL button to the component you want to remote control.

For example, you may have both a CD-R and a tape deck in your system but only one video deck. It would make sense to assign the CD-R/TAPE 1 MULTI CONTROL button to the CD-R and the VCR 2 MULTI CONTROL button to your tape deck. To do this choose VCR 2 in step 3 when you want to set up the tape deck. Then choose TAPE in step 4 and proceed as above. The only practical difference in this method is that you have to remember the VCR 2 MULTI CONTROL button is actually your tape deck.

In this case, you would need to hook up your tape deck to the input jacks marked VCR 2 on the back of the receiver.

This method should help you customize the remote control for your system and let you control all of your components with the remote control for the VSX-D2011.

### 8 Repeat the process from step 2 for all of your components.

### 9 Select EXIT and press ENTER.

## Remote Control of Other Components

### Programming Signals from Other Remote Controls (LEARNING Mode)

If preset codes are not available for your component(s), or the available preset codes do not operate correctly, you can use this procedure to program in signals from the remote control(s) of your other component(s). These steps can also be used to add further operations to the remote control that were successfully set with the stored settings (see pages 66–67).



- **To exit from the remote control setup mode at any time, press REMOTE SETUP.**
- You can also program the ▲/▼/◀/▶ and ENTER buttons with the LEARNING mode.
- The TUNER button cannot be assigned.
- The display will disappear after one minute or so if no new commands are entered. Press any button to wake up the remote and continue the process.

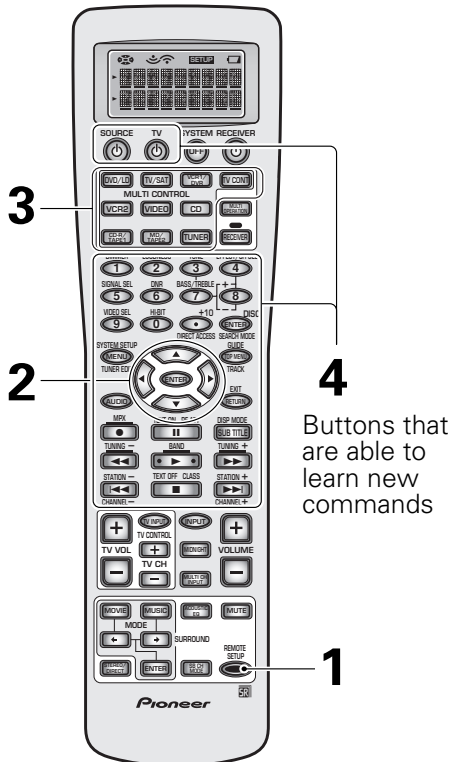

#### 1 Press the REMOTE SETUP button for three seconds.

The REMOTE SETUP menu appears on the remote display.

#### 2 Use the ▲▼ buttons to select LEARNING and press ENTER.

SELECT FUNCTION blinks on the remote control.

#### 3 Press the MULTI CONTROL button for the component you want to control.

For example: DVD/LD

SELECT KEY flashes in the display.

#### 4 Choose the command you want to teach the remote control and press the corresponding button. The word LEARN will blink in the remote control display.

For example, choose the ► (play) button to program this remote control to play your DVD player.

- The TV POWER, TV FUNC, TV CH +/- and VOL +/- buttons are only available for learning when programming TV CONT button.

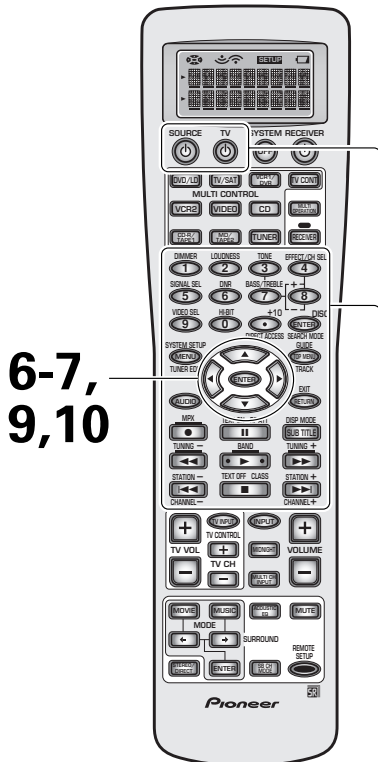

Buttons that are able to learn new commands

- 5 While LEARN continues to flash, point the two remote controls toward each other. Press the button on the other remote control corresponding to the operation you want to program.

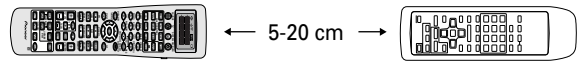

After the process is complete and the command has been learned, OK will appear in the remote control display. If NG (no good) appears, it means that for some reason the command was not learned. In this case, repeat steps 4 and 5. CONTINUE? appears in the remote's display. If SELECT KEY is flashing go back to step 4.

- 6 If you want to program in more commands use the ▲▼ buttons to select YES. Press ENTER.

Repeat steps 4 and 5 to teach the remote control of the VSX-D2011 all the commands from the other remote control.

- 7 If you want to program in commands for another MULTI CONTROL button use the ▲▼ buttons to select NO. Press ENTER.

- 8 Repeat the process from step 2 for all of your components.

Start again to program other components in this manner.

- 9 When you're done use the ▲▼ buttons to select EXIT.

You will return to the REMOTE SETUP menu.

- 10 Select EXIT and press ENTER.



- If FULL appears in step 5 it means that there isn't enough capacity to learn this command. If you want to clear other buttons to make room for this one follow the procedure on page 87.
- If there isn't enough capacity, an incorrect signal has been sent or, in some cases, the command from another remote control simply cannot be learned, NG (no good) will appear in the display in step 5.
- In some NG cases the remotes just need to be moved closer together or farther apart.

## Remote Control of Other Components

# Using Remote Control with Other Components

### CD/MD/CD-R/VCR/DVD/LD/DVD recorder/Cassette Deck operations



- The following operations are available from the receiver's remote control after you program it (see "Setting Up the Remote Control to Control Other Components," pages 66–69).
- To perform these operations, press the **MULTI CONTROL** button for the component you want to control.
- For more information on individual commands consult the manual that came with the component.

Button(s)	Function	Components
SOURCE	Press to switch the components between <b>STANDBY</b> and <b>ON</b> .	CD/MD/CD-R/VCR/DVD/LD/ DVD recorder/Cassette deck
	Press to return to the start of the current track or chapter. Repeated presses skips to the start of previous tracks or chapter.	CD/MD/CD-R/DVD/LD/
	Go back channels (channel –).	VCR/DVD recorder
	Play the reverse side of the tape on a reversible deck.	Cassette deck
	Press to advance to the start of the next track or chapter. Repeated presses skips to the start of following tracks or chapter.	CD/MD/CD-R/DVD/LD/
	Go forward channels (channel +).	VCR/DVD recorder
	Pause playback or recording.	CD/MD/CD-R/VCR/DVD/LD/ DVD recorder/Cassette deck
	Hold down for fast forward playback.	CD/MD/CD-R/VCR/DVD/LD/ DVD recorder/Cassette deck
	Hold down for fast reverse playback.	CD/MD/CD-R/VCR/DVD/LD/ DVD recorder/Cassette deck
	Start playback.	CD/MD/CD-R/VCR/DVD/LD/ DVD recorder/Cassette deck
	Stop playback (on some models, pressing this when the disc is already stopped will cause the disc tray to open).	CD/MD/CD-R/VCR/DVD/LD/ DVD recorder/Cassette deck
	Starts recording.	MD/CD-R/VCR/DVD recorder/ Cassette deck
SUBTITLE/ DISP MODE Button	Displays/changes the subtitles on multilingual DVDs.	DVD/DVD recorder
	Change the display mode.	CD/MD/CD-R/VCR/LD
Number Buttons	Directly access tracks on a program source.	CD/MD/CD-R/LD
	Directly access chapter on a program source.	DVD/DVD recorder
	Directly select a channel.	VCR/DVD recorder
+10 Button	Select tracks or chapter higher than 10. Press this button and the remaining number to get the track or chapter (+10 Button + 3= track or chapter 13). Some components may operate differently.	CD/MD/CD-R/DVD/LD/ DVD recorder
ENTER/DISC Button	Press to start Search mode.	DVD
	Takes you to the disc navigator.	DVD recorder
	Changes between sides A & B of the disc.	LD
	Press to enter the selected channel.	VCR
	Selects a disc in a multi-disc CD player.	CD
MENU	Displays menus concerning the current DVD, DVR or VCR you are using.	DVD/DVD recorder/VCR
AUDIO	Changes the audio track of discs with more than one audio track.	DVD/LD/DVD recorder
	Changes between the tuner in the TV and the tuner in the VCR.	VCR
	Play the reverse side of the tape on a reversible cassette deck.	Double cassette 2nd deck
TOP MENU /GUIDE button	Displays the top menu of the current DVD, LD or DVR you are using.	DVD/LD/DVD recorder
	Takes you to the guide menu of that system.	VCR
	Press to select a track	CD
RETURN/ EXIT button	Takes you to the previous menu.	DVD/LD/VCR/DVD recorder
& ENTER	Navigate menus/options.	DVD/LD/DVD recorder/VCR
	Basic playback options.	Double cassette 2nd deck

## Remote Control of Other Components

### Cable TV/Satellite TV/TVoperations



- The following operations are available from the receiver's remote control after you program it (see "Setting Up the Remote Control to Control Other Components," pages 66–69).
- To perform these operations, press the **MULTI CONTROL** button for the component you want to control.
- For more information on individual commands consult the manual that came with the component.

Button(s)	Function	Components
TV	Press to switch the TV, Satellite TV or Cable TV between <b>STANDBY</b> and <b>ON</b> .	Cable TV/ Satellite TV/ TV
TV INPUT	Press to switch the TV input.	TV
TV CH (+/-)	Select channels.	Cable TV/ Satellite TV/ TV
TV VOL (+/-)	Adjust the TV volume.	TV
MENU	Takes you to the TV menu of that system.	Cable TV/ Satellite TV/ TV
GUIDE	Takes you to the guide menu of that system.	Cable TV/ Satellite TV/ TV
RETURN	Exits the menu you are viewing.	Cable TV/ Satellite TV/ TV
●	A/Cyan	Satellite TV/ TV
	B/Press to switch the TEXT ON.	Satellite TV/ TV
◀◀	C/RED	Satellite TV/ TV
	Use to move back a page in the menu.	Cable TV
▶▶	D/GREEN	Satellite TV/ TV
▶▶▶	E/YELLOW	Satellite TV/ TV
	Use to move forward a page in the menu.	Cable TV
◀◀◀	Use to move back channels.	TV/ Cable TV
	Use to move back a page in the menu.	Satellite TV
▶▶▶	Use to move forward channels.	TV/ Cable TV
	Use to move forward a page in the menu.	Satellite TV
■	Press to switch the TEXT OFF.	TV
Number Buttons	Use to select a specific TV channel.	Cable TV/ Satellite TV/ TV
ENTER/DISC button	Use this button to immediately enter a new channel.	Cable TV/ TV
◀▶▲▼ & ENTER	Press to select or adjust and navigate items on the menu screen.	Cable TV/ Satellite TV/ TV



- The first four buttons are dedicated to control the TV assigned to the TV CONT button. Thus if you only have one TV hooked up to this system, assign it to the TV CONT button. If you have two TVs, assign the main TV to the TV CONT button. If you hook up your system this way, the first four TV controls will always be accessible. For example, if you connect your TV to TV monitor, then use TV CONT for your TV. If you connect your TV to input source then use TV.
- Depending on the maker and individual model, there are some buttons that may not be able operate some equipment or may operate it in a different way.

# Setting up the DIRECT FUNCTION

The direct function will not be necessary for most users. It is designed in case you have an external video source connected to your TV (a video source that is not going through the VSX-D2011). For this explanation we'll call this the external video deck. You'd like to control external video deck with this unit's remote control so you've assigned it a function button (for example purposes, the VCR 2 button). Yet, if you put the receiver in VCR 2 mode you'll get no picture on your TV because the external video deck signal is not going through the VSX-D2011. To get around this problem you set the DIRECT FUNCTION for VCR 2 to OFF. Now when you press VCR 2 function button you can control the external video deck with the remote but the receiver does not go into VCR 2 mode.

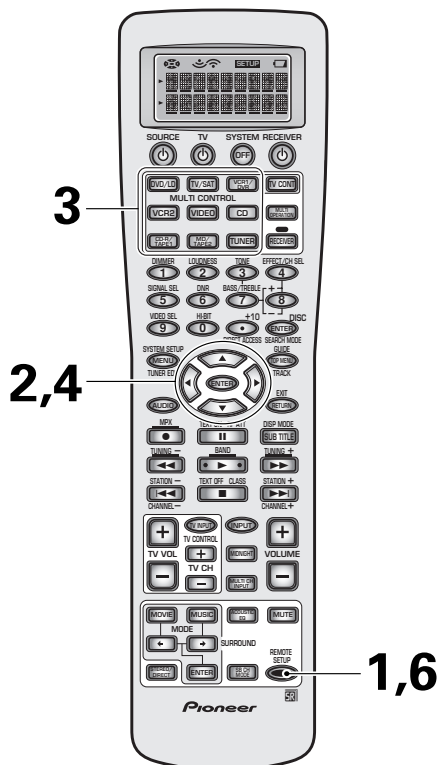

### 1 Press the REMOTE SETUP button for three seconds.

The REMOTE SETUP menu appears on the remote display.

### 2 Use the ▲▼ buttons to select DIRCTFNC and press ENTER.

SELECT FUNCTION will flash in the remote control display.

### 3 Press the MULTI CONTROL button of the component whose direct function you want to turn on or off.

DIRECTFUNC appears on the remote control display.

### 4 Use the ▲▼ buttons to select ON, OFF, or EXIT and press ENTER.

**ON:** The direct function is on.

**OFF:** The direct function is off.

**EXIT:** Leaves the DIRECT FUNCTION settings and returns you to the REMOTE SETUP menu.

After you press ENTER, if you chose one of the first two settings, COMPLETE will appear in the display.

### 5 Repeat steps 2–4 to set the direct function for as many components as you want.

### 6 Press the REMOTE SETUP button to return to the previous mode.



- To exit from the remote control setup mode at any time, press **REMOTE SETUP**.
- The default setting for all DIRECT FUNCTIONS is ON.



# Using Other Functions

## Recording from Audio/Video Components

The following explanations show you how make a recording from one component to another connected to this receiver. Note that an analog recorder (such as a VCR) cannot record from a source that is connected using only a digital connection. Likewise, a digital recorder (such as a CD-R) cannot record digitally from a component that is connected using only analog connections. In both of these cases, make sure that the digital component also has analog connections to the receiver, and that the SIGNAL SELECT is set to ANALOG.

When recording from one digital component to another, bear in mind that the digital signal output from this receiver mirrors the input from the source. So if the input is, say, Dolby Digital, the output will also be Dolby Digital. Before recording, make sure that the recorder is compatible with the source digital audio format.

See page 20 for more on analog audio connections and pages 22–23 for digital audio connections.



- The receiver's volume, channel level, balance, TONE, DIGITAL NR, MIDNIGHT, LOUDNESS, ACOUSTIC EQ and surround effects have no effect on the recorded signal, except in PHONO. Thus when recording in PHONO function DIRECT is best used.
- In some cases, digital recordings have copy guard protections and making a digital copy is not possible. In this case you can only copy them in an analog manner.
- Some video recordings are copy-protected; these sources cannot be recorded.
- When recording video, the source must be connected to the receiver using the same type of video cord (composite, or S video) as you used to connect the recorder to the receiver.

### Functions that can be recorded

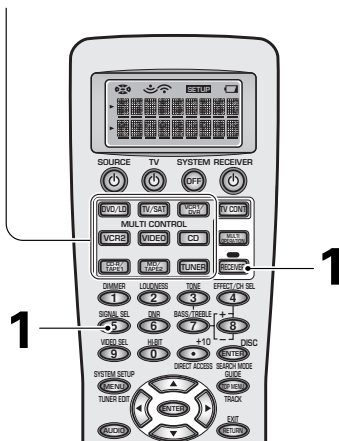

**1 Select the source component. Set SIGNAL SELECT according to the source component's signal (ANALOG or DIGITAL).**

**2 Start recording (tape deck, CD recorder, VCR, etc.)**

**3 Playback the source to be recorded.**

## SECOND ZONE (Speaker System B)/FRONT BI-AMP Setup

### Stereo playback in another room (SECOND ZONE)

This setup enables you to listen to a pair of stereo speakers independently of the main speaker system hooked up to the receiver. You can choose SECOND ZONE, and use the speakers hooked up to the surround back terminals as a B speaker system, that is, playing the same source as the main speaker system but from independent stereo speakers.

**1 Connect a pair of speakers to the surround back speaker terminals.**

**2 Select SECOND ZONE in the SURRBACK SYSTEM setup (see page 37) setup.**



Please use speakers with a nominal impedance rated 8 Ω-16 Ω.

### Bi-amping the front speakers (FRONT BI-AMP)

For bi-amp playback you can connect both the A and B speaker terminals to your front speakers. To do this your speakers must be bi-wireable (that is they must have separate terminals for the high and low frequencies).

Bi-amping delivers more power to the front speakers, but disables the surround back speakers, so you will be limited to 5.1 channel playback.

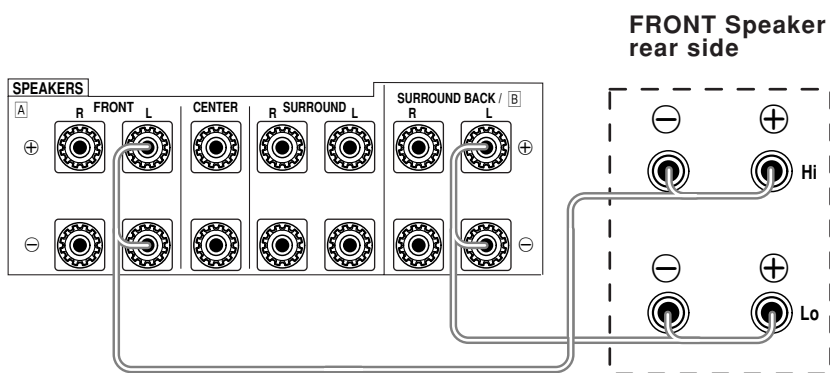

#### Caution!

Most speakers with both HI and LOW terminals have two metal plates that connect the HI to the LOW terminals. These must be removed when you are bi-amping the speakers or you could severely damage the amplifier. See your speaker manual for more information.

#### Caution!

Do not allow any speaker wire from any terminal to touch a wire from a different terminal.

**1 Connect your speakers as shown.**

Since both Front A and B speaker terminals output the same audio, it doesn't matter which set (A or B) is powering which part (HI or LOW) of the speaker.

**2 Select FRONT BI-AMP in the SURRBACK SYSTEM setup (see page 37).**

The surround back channel amplifier is now used to power the B set of speaker terminals and the A+B (SP▶AB) speaker setting is automatically selected. The speaker setting in this case can only be A+B or OFF.

## A/B Speaker Button

If you selected NORMAL SYSTEM in the SURRBACK SYSTEM setup (see page 37) your surround back speakers will be used as part of your of main speaker systems and this button will simply switch if off or on. If you selected SECOND ZONE in the SURRBACK SYSTEM setup (see page 37) this button will cycle through the A (main) speaker system, the B speaker system (the surround back speakers acting as a separate second zone), both speaker systems, and off.

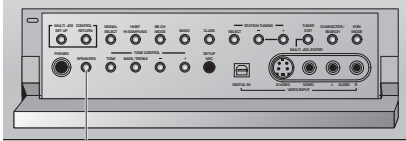

**1**

**1 Press the SPEAKERS button (on the front panel) to switch speakers on/off or cycle through the different speaker systems if SECOND ZONE or FRONT BI-AMP has been selected in the SURRBACK SYSTEM setup.**

- A(SP►A): Sound is output from speaker system A and the same signal is output from the pre out terminals.
- B(SP►B): Sound is output from the two speakers in speaker system B (the surround back speakers). Multichannel sources will be downmixed to these two speakers.
- A&B(SP►AB): Sound is output from speaker system A speakers and the B speakers. Also, for FRONT BI-AMP playback.
- OFF(SP► ): No sound is output from the speakers. Depending on the input signal and settings in SPEAKER SETTING sound may be output from the subwoofer. The same sound is output from the pre out terminals as when selecting speaker system A (above).



- What is output from the subwoofer depends on the SPEAKER SETTING and the type of source.
- Depending on the settings in SPEAKER SETTING and the MULTI CH IN SELECT, output from the SURROUND BACK PRE OUT terminals may change.
- When using headphones the speakers are switched off.
- Please use speakers with a nominal impedance rated 8 Ω-16 Ω.

## Setting up and Using the USB Audio Connection

The USB Audio Connection feature allows you hook up a PC to this receiver. In this way you can hear soundtracks from your computer. To use this feature follow the steps below. A few points to remember when hooking up this receiver to a computer: the USB drive is bus powered, which means a power current is inherent in the connection. Thus you don't need to have the receiver on when doing the setup below (you can if you want). The USB port can only receive 2 channel soundtracks. USB device controls on the computer (such as volume) may or may not work. In either case, we recommend leaving all volume controls on max and controlling the volume from the receiver. For explanation purposes we will use Windows® XP operating system (OS) but the USB drive can also be use with Windows® 2000, Windows® Me, Windows® 98 SE, and Windows® 98. The specific setups of those operating systems will be slightly different than that of XP.

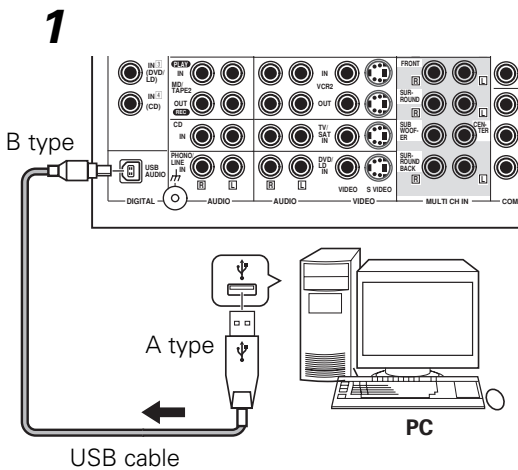

### 4 (This illustration is for Windows® XP OS.)

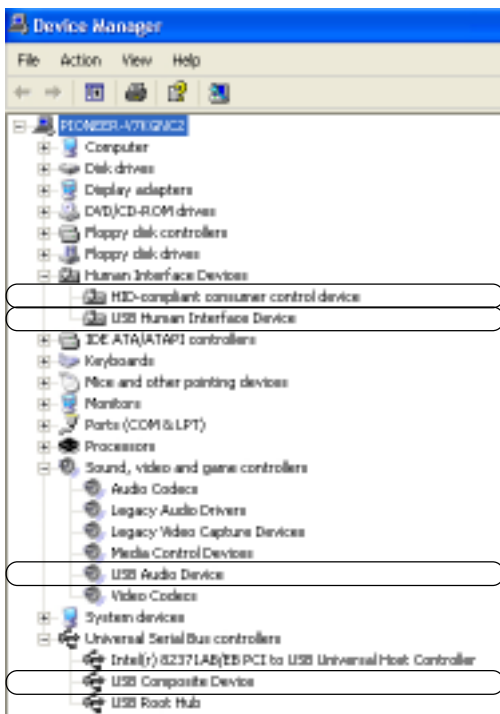

### 1 Connect your PC to the USB terminal.

You need to use a full speed USB cable (not supplied) for this connection.

### 2 Turn on your PC and start up your OS.

Some operating systems may or may not work with this USB port. If the computer was previously running quit all applications.

### 3 Install the USB drivers by following the instructions on your PC monitor.

Your PC should automatically recognize the new USB connection and a dialog box concerning USB devices should open on your computer. For some operating systems you may need to load the system CD-ROM and install the USB driver.

Follow the directions in the dialog box to install the USB driver.

For Windows® XP the USB driver will install automatically and no dialog box will appear.

For all operating systems do step 4 to make sure installation was done properly.

### 4 Check to see if the drivers are correctly installed.

If the installation was successful "USB Audio Device" will appear in three computer menus, 1) in Sound, Video & Game Controllers, 2) in Universal Serial Bus Controllers and 3) in USB Compatible Device. To find these menus follow the path below (assuming none of these standard OS menus have been moved or deleted).

• For Windows® XP check by opening:

Start → Settings → Control Panel → Performance & Maintenance → System → Hardware → Device Manager → Sound, Video & Game Controllers → USB Audio Device

For other OS the path will be slightly different but nearly the same.

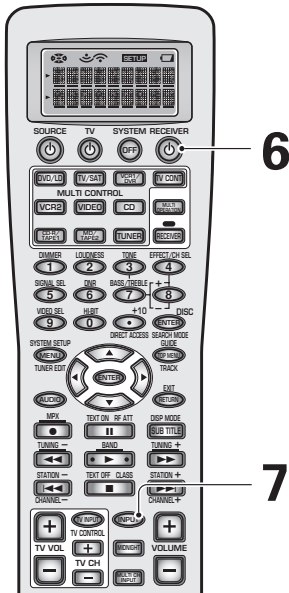

### 5 Change the PC audio setting (if necessary).

You may need to change the audio setting on your computer to hear a soundtrack through the USB port. If so, follow the path below.

- **For Windows® XP:**  
Start → Settings → Control Panel. Click on Multimedia Properties, select USB Audio Device [1] for Playback of Audio. Close window. For other OS the path will be slightly different but nearly the same.

### 6 Switch on the receiver.

### 7 Use the INPUT button on the remote control or the MULTI JOG dial on the front panel to select the USB input.

### 8 Play back a music file on your PC.

The volume on both the computer and the receiver is turned up.

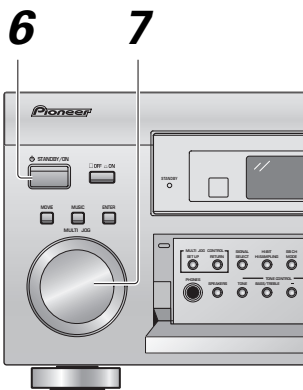

- Do not disconnect the USB cable while installing the drivers. Also, do not turn off the receiver or disconnect the USB cable while the your PC is recognizing the receiver, which takes a few seconds every time you turn on your PC and it is hooked up the receiver.
- If your PC does not recognize the receiver try disconnecting the USB cable and connecting it again. If it still does not recognize it restart the computer.
- Do not disconnect the USB cable while playing a soundtrack from the computer.
- The sound may be interrupted, degraded or played back incorrectly due to your PC settings and PC specifications. Consult your PC manual concerning USB devices.
- Windows® 95 and other older operating systems will not work.
- Don't use USB hub connectors.
- Some software may be incompatible with this configuration.
- This configuration cannot be upgraded.
- The maximum power for the USB connection is 100 mA.
- Pioneer cannot be held responsible for damage to your computer system, software crashes or failures or any other possible computer problems due to this configuration.
- This USB connection only supports 2 channel sound.
- When listening to your PC through this USB connection you will also hear computer alert sounds through the receiver.
- You cannot control your PC with any controls on the receiver. The connection is only from the PC to the receiver.
- When you're using the USB connection no signal will be output from the DIGITAL OUT 1 & 2.
- Don't use other applications on your computer when playing back through this USB connection.

Microsoft Windows® 98, Windows® 2000, Windows® Me and Windows® XP are registered trademarks of the Microsoft Corporation.

## Connecting Additional Amplifiers

This receiver has more than sufficient power for any home use, but it is possible to add additional amplifiers to every channel of your system. Make the connections shown below to add amplifiers to power your speakers. Before making or changing the connections, switch off the power and disconnect the power cord from the AC outlet.

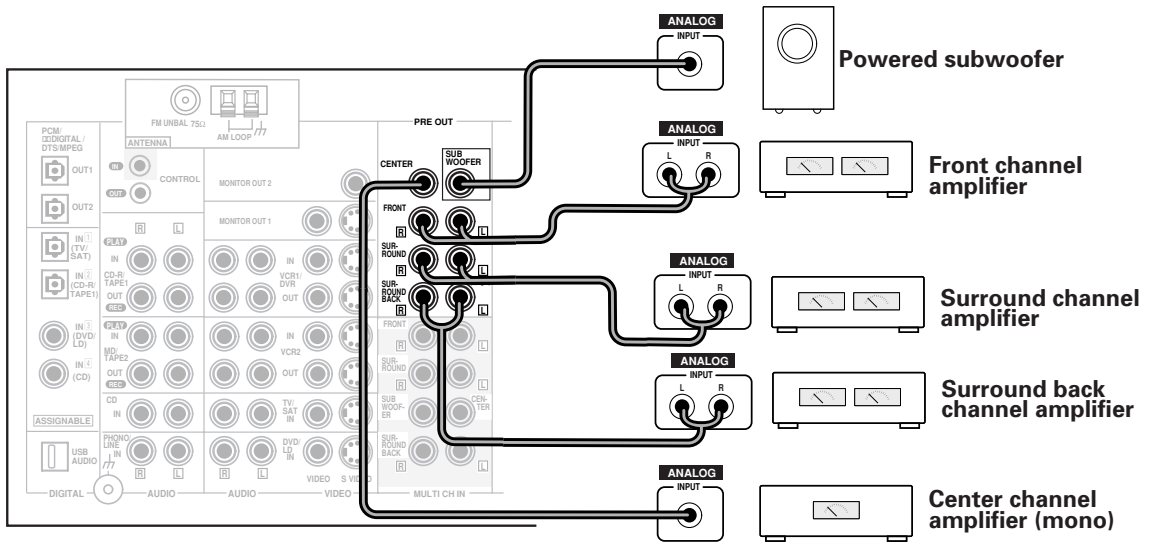

- You can use the additional amplifier on the surround back channels for a single speaker as well. In this case plug the amplifier into the L (SINGLE) terminal only.
- The sound from the surround back terminals will depend on how you have set up the SURRBACK SYSTEM (see page 37).

## The PIONEER SR System: Operating other PIONEER components

Connecting an optional control cord allows you to operate other PIONEER components simply by pointing the receiver's remote control at the remote sensor on the front panel of the receiver. The receiver then sends the remote control signals to the other devices via the CONTROL OUT terminal.

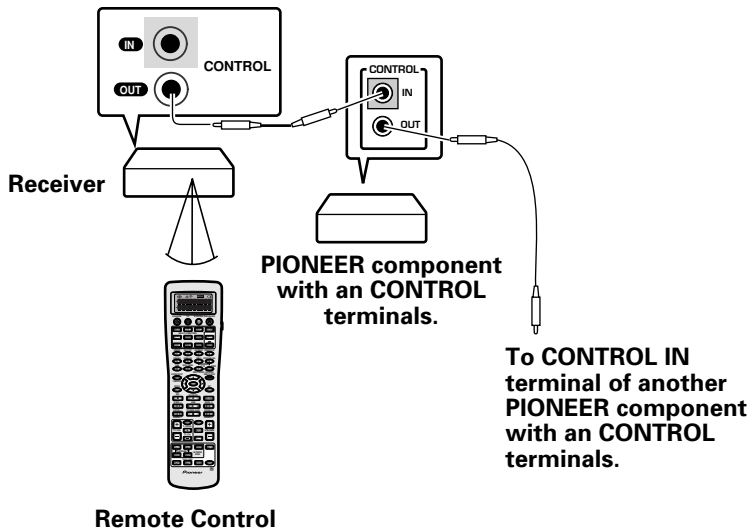

- You can also control PIONEER components (and those made by other manufacturers) by pointing the receiver's remote control directly at the respective component. This type of operation does not require control cords. All you have to do is recall the appropriate stored settings (see pages 66–67).
- If you use a remote control hooked up via the CONTROL IN jack with a control cord, you won't be able to use this unit's remote control.
- If you use this feature make sure an analog (audio and/or video) connection has been made between the units.

## Multi Operations

Multi operations allow you to tell the receiver and your other components to do a number of things with the push of only two buttons on the remote control (see "Performing Multi Operations" on the next page). For example, you can program the unit to turn on your TV, turn on your DVD player and start playing the loaded DVD. This allows you to freely decide which operations you want performed as well as the order in which you want them performed. The steps below show you how to program a string of up to 5 different operations for each MULTI CONTROL button. You don't need to program the power of this receiver (or any PIONEER component used) to go on, it (or they) will do so automatically when multi operations are performed.



**Be sure to set up each component before programming multi operations (see "Setting Up the Remote Control to Control Other Components", pages 66-69).**

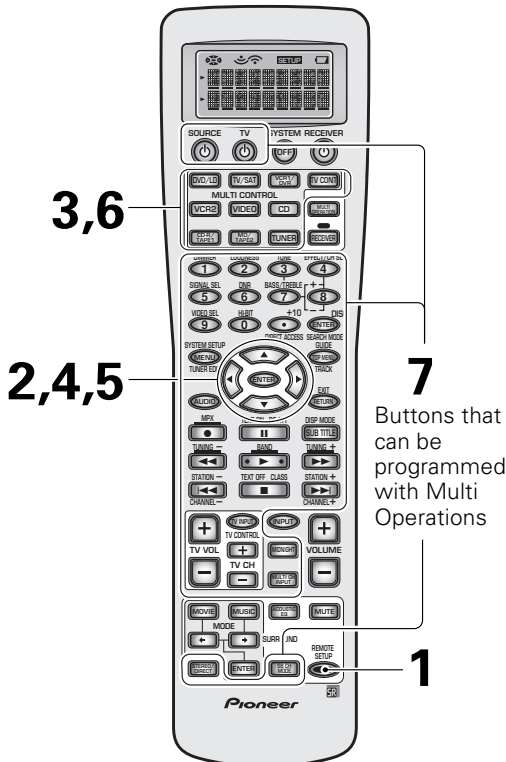

### 1 Press the REMOTE SETUP button for more than three seconds.

The REMOTE SETUP menu appears on the remote display.

### 2 Use the ▲▼ buttons to select MULTI OPE and press ENTER.

SELECT FUNCTION blinks on the remote display.

### 3 Press the MULTI CONTROL button for the component you want to start the Multi Operations with. MULTI OPE appears in the display.

For example, DVD/LD

### 4 Use the ▲▼ buttons to select first command. "1st Cmmnd" appears in the display. Press ENTER.

This tells the receiver this will be the first command.

#### To erase a command

Select CLEAR and press ENTER. Then go to step 8.

#### To go back one step

Select EXIT and press ENTER.

### 5 To setup a command select CHANGE and press ENTER.

FUNCTION flashes in the display,

### 6 Select the component whose command you want to input (for example, a DVD player), and press the MULTI CONTROL button for it.

KEY will flash in the display.

### 7 Select a button for the command you want to input (for example, ► [play]).

COMPLETE appears in the display.

### 8 Repeat steps 4-7 to program a sequence of up to five commands.

You can assign Multi Operations for up to 5 commands for each MULTI CONTROL button.



- To exit from the REMOTE SETUP mode at anytime press the REMOTE SETUP button.
- The display will disappear after one minute or so if no new commands are entered. Press any button to wake up the remote and continue the process.



**9 When done select EXIT and press ENTER.**

You will return to the REMOTE SETUP menu. Start again from step 2 if you want to set do another MULTI CONTROL button.

**10 Select EXIT and press ENTER again.**

You will exit the REMOTE SETUP menu and return to normal operation.



You don't need to program power on for PIONEER components (except for the first generation of Pioneer DVRs), they will go on automatically if a command for that unit is entered in the Multi Operations settings. Also, your TV will go on automatically if a TV related command is entered in the Multi Operations.

9-10

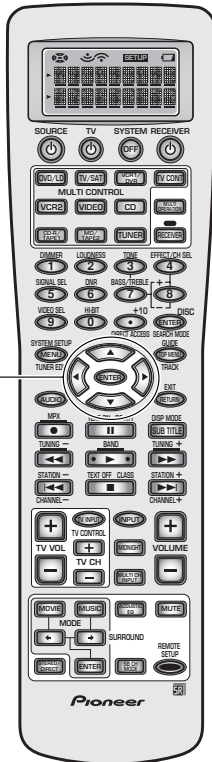

**Performing Multi Operations**

Do the following to use the Multi Operations.

**1 Press the MULTI OPERATION button.**

SELECT FUNCTION flashes in the display,

**2 Press the MULTI CONTROL button for the component that has been set up with multi operations.**

The power of the receiver (and any Pioneer components use in the program) goes on and the programmed multi operations are performed automatically.

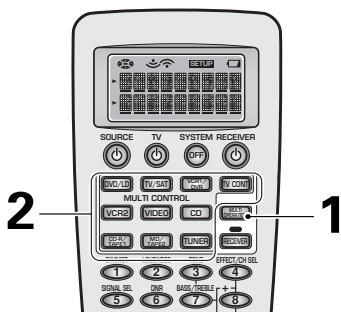

## SYSTEM OFF

The SYSTEM OFF feature allows you to tell the receiver and your other components to stop and/or turn off with the push of only one button on the remote control. For example, you can program the unit to stop your DVD, turn off your TV and turn off your DVD player. You don't need to program power off for PIONEER components, they will go off automatically in this mode. The receiver itself will go off automatically as well. The steps below show you how to program a string of up to 5 different SYSTEM OFF operations.



**Be sure to set up each component before programming the SYSTEM OFF function (see "Setting Up the Remote Control to Control Other Components", pages 66-69).**

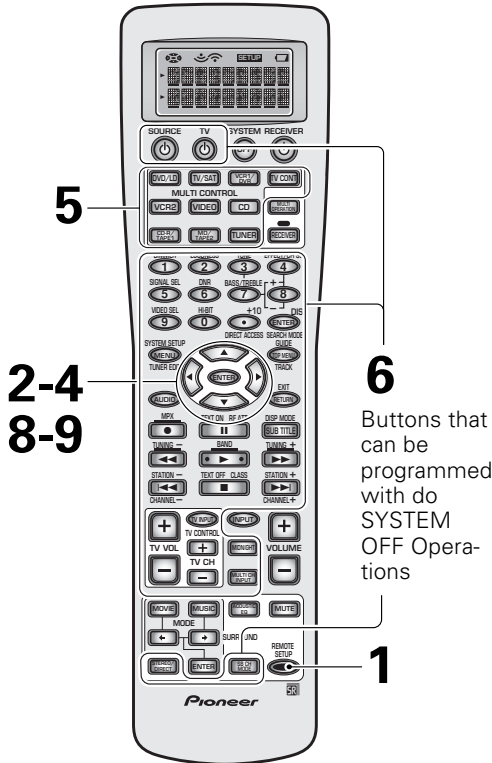

- To exit from the REMOTE SETUP mode at anytime press the REMOTE SETUP button.
- The display will disappear after one minute or so if no new commands are entered. Press any button to wake up the remote and continue the process.

### 1 Press the REMOTE SETUP button for more than three seconds.

The REMOTE SETUP menu appears on the remote display.

### 2 Use the ▲▼ buttons to select SYS OFF and press ENTER.

SYSTEM OFF appears in the remote display.

### 3 Use the ▲▼ buttons to select first command. "1st Cmmnd" appears in the display. Press ENTER.

This tells the receiver this will be the first command.

#### To erase a command

Select CLEAR and press ENTER. Then go to step 7.

#### To go back one step

Select EXIT and press ENTER.

### 4 To setup a command select CHANGE and press ENTER.

FUNCTION flashes in the display,

### 5 Select the component whose command you want to input (for example, a DVD player), and press the MULTI CONTROL button for it.

KEY will flash in the display.

### 6 Select a button for the command you want to input (for example, ■ [stop]).

COMPLETE appears in the display.

### 7 Repeat steps 3-6 to program a sequence of up to five commands.

You can assign SYSTEM OFF information for up to 5 commands.

### 8 When done select EXIT and press ENTER.

You will return to the REMOTE SETUP menu.

### 9 Select EXIT and press ENTER again.

You will exit the REMOTE SETUP menu and return to normal operation.

## Using SYSTEM OFF

Do the following to use the SYSTEM OFF function.

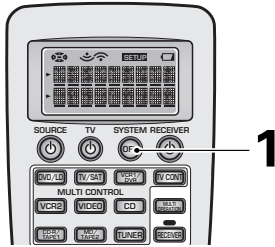

### 1 Press the **SYSTEM OFF** button.

The remote control must be on to be able to use this command but it can be in any mode.

All the components programmed into the SYSTEM OFF mode will stop and/or go off. The receiver and Pioneer components will go off as well.

## Editing Remote Control Display Names

Use this capability to rename the display on the remote control for different MULTI CONTROL buttons (DVD/LD, etc.). For example, you could change TV to DVD2. In this way you can personalize your system. This is similar to the feature on page 93 but that feature changes the display on the receiver.

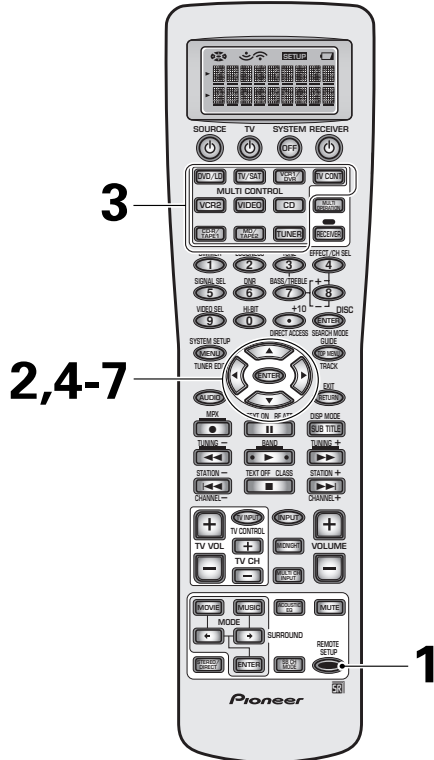

**1 Press the REMOTE SETUP for more than three seconds.**

The REMOTE SETUP menu appears on the remote display.

**2 Use the ▲▼ buttons to select FUNCNAME and press ENTER.**

SELECT FUNCTION will flash in the display.

**3 Press the MULTI CONTROL button for the component you want to rename.**

For example, TV

**4 Use the ▲▼ buttons to select the letters and/or numbers you want to enter and use the ◀▶ buttons to move the cursor to the next position.**

Here are the possible letters/numbers.

```

ABCDEFGHIJKLMNOPQRSTUVWXYZ
abcdefghijklmnopqrstuvwxyz
0123456789
!#%&'()*+,-./:;<=>?
@[\\^_`{|}~▶◀◻◼◽◾◿◐◑◒◓◔◕◖◗◘◙◚◛◜◝◞◟◠◡◢◣◤◥◦◧◨◩◪◫◬◭◮◯◰◱◲◳◴◵◶◷◸◹◺◻◼◽◾◿◐◑◒◓◔◕◖◗◘◙◚◛◜◝◞◟◠◡◢◣◤◥◦◧◨◩◪◫◬◭◮◯◰◱◲◳◴◵◶◷◸◹◺◻◼◽◾◿◐◑◒◓◔◕◖◗◘◙◚◛◜◝◞◟◠◡◢◣◤◥◦◧◨◩◪◫◬◭◮◯◰◱◲◳◴◵◶◷◸◹◺
    
```

You can input up to eight letter/numbers.

**5 When you're finished press ENTER, END will blink, press ENTER again.**

The COMPLETE appears in the display.

**6 Go back to step 2 to input as many function names as you want.**

**7 Select EXIT and press ENTER.**

You will exit the REMOTE SETUP menu and return to normal operation.



- To exit from the remote setup mode at any time press the REMOTE SETUP button.
- The display will disappear after one minute or so if no new commands are entered. Press any button to wake up the remote and continue the process.

## Editing Button Names (KEY LABEL)

Use the KEY LABEL capability to rename the display on the remote control for different buttons (keys). You would want to do this if you taught a specific button a new operation.

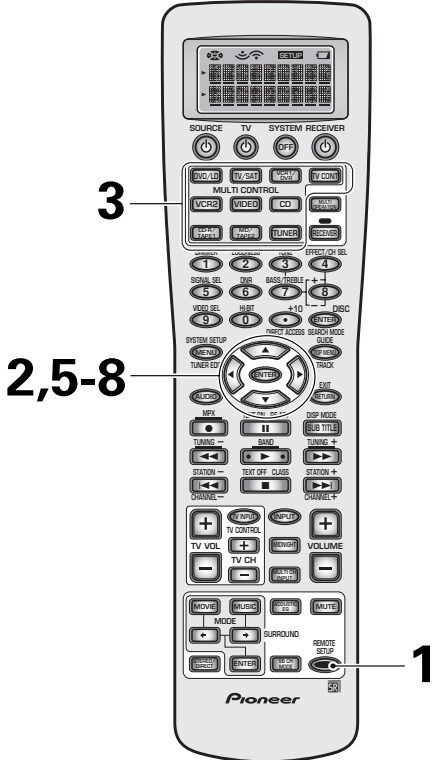

### 1 Press the REMOTE SETUP for more than three seconds.

The REMOTE SETUP menu appears on the remote display.

### 2 Use the ▲▼ buttons to select KEY LABEL and press ENTER.

SELECT FUNCTION will flash in the display.

### 3 Press the MULTI CONTROL button for the component whose button you want to rename.

For example DVD/LD  
SELECT KEY flashes in the display.

### 4 Press the buttons whose name you want to change.

For example, ►  
The name-changing screen appears in the display.

### 5 Use the ▲▼ buttons to select the letters and/or numbers you want to enter and use the ◀▶ buttons to move the cursor to the next position.

Here are the possible letters/numbers.

ABCDEFGHIJKLMNOPQRSTUVWXYZ  
 abcdefghijklmnopqrstuvwxyz  
 0123456789  
 !#%&'()\*+,-./:;<=>?  
 @[\\^\_`{|}~▶◀■●○☺☹☼☽☾☿☽☿☽☿(space)

You can input up to eight letter/numbers.

### 6 When you're finished press ENTER, END will blink, press ENTER again.

COMPLETE appears in the display.

### 7 Go back to step 2 to input as many button names as you want.

### 8 Select EXIT and press ENTER.

You will exit the REMOTE SETUP menu and return to normal operation.



- To exit from the remote setup mode at anytime press the REMOTE SETUP button.
- The display will disappear after one minute or so if no new commands are entered. Press any button to wake up the remote and continue the process.

# Adjusting the Light on the Remote Control

This feature allows you to adjust the brightness of the light on the remote control.

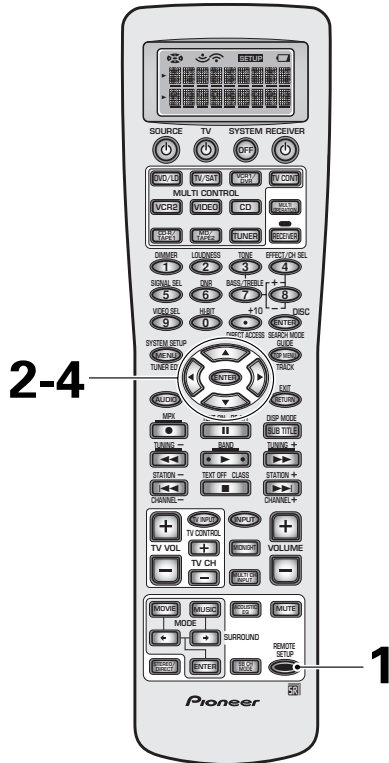

### 1 Press the **REMOTE SETUP** button for three seconds.

The **REMOTE SETUP** menu appears on the remote display.

### 2 Use the **▲▼** buttons to select **LIGHT** and press **ENTER**.

### 3 Use the **▲▼** buttons to select **HIGH**, **LOW**, or **EXIT** and press **ENTER**.

**HIGH**: The brightest setting

**LOW**: A dimmer setting

**OFF**: Turns the remote control light off.

**EXIT**: Leaves the **LIGHT** setting and returns you to the **REMOTE SETUP** menu.

After pressing **ENTER** in the first three cases, **COMPLETE** will appear in the display and you will be returned to the **REMOTE SETUP** menu.

### 4 Select **EXIT** and press **ENTER**.

You will exit the **REMOTE SETUP** menu and return to normal operation.



- To exit from the remote setup mode at any time press the **REMOTE SETUP** button.
- The display will disappear after one minute or so if no new commands are entered. Press any button to wake up the remote and continue the process.

## Clearing Remote Control Settings You Have Input

This feature allows you to clear a particular setting, or all of the settings from a function in the REMOTE SETUP menu.

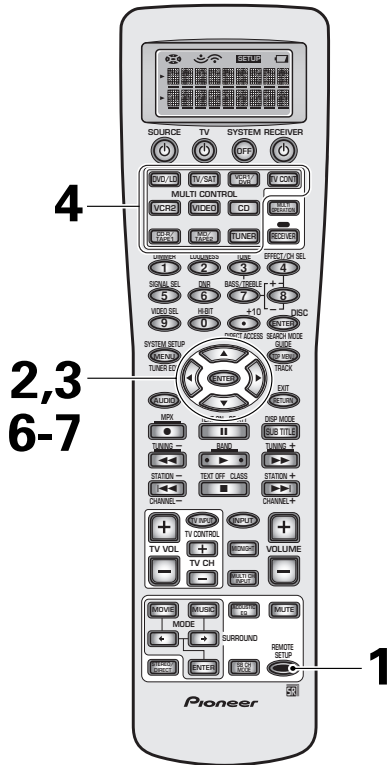

### 1 Press the REMOTE SETUP button for three seconds.

The REMOTE SETUP menu appears on the remote display.

### 2 Use the ▲▼ buttons to select CLEAR and press ENTER.

CLEAR appears in the display.

### 3 Use the ▲▼ buttons to select one setting, or all of the settings, and press ENTER.

The choices in this feature include:

**LEARNING CLEAR:** allows you to clear one command you have set in the LEARNING function. After pressing ENTER SELECT FUNCTION flashes in the display. Go to step 4.

**KEYLABEL CLEAR:** allows you to clear one button name you have set in the KEYLABEL function. After pressing ENTER SELECT FUNCTION flashes in the display. Go to step 4.

**ALL CLEAR:** Allows you to clear all the REMOTE SETUP settings. After pressing ENTER, CLEAR? appears in the display. Go to step 6.

**EXIT:** Returns you to the REMOTE SETUP menu.

### 4 Press the MULTI CONTROL button for the component whose command or key label you want to clear.

SELECT KEY flashes in the display.

### 5 Press the button you want to clear.

The button chosen will appear in the display. CLEAR? will appear in the display.

### 6 Use the ▲▼ buttons to select YES, NO or EXIT and press ENTER.

**YES:** clears the setting.

**NO** and **EXIT:** leaves the setting as is and returns you to the REMOTE SETUP menu.

If you select YES and press ENTER then COMPLETE appears in the display and you are returned to the REMOTE SETUP menu.

### 7 Select EXIT and press ENTER.

You will exit the REMOTE SETUP menu and return to normal operation.

#### memo

- To exit from the remote setup mode at any time press the REMOTE SETUP button.
- The display will disappear after one minute or so if no new commands are entered. Press any button to wake up the remote and continue the process.

# Resetting the Main Unit

The following operations allow you to reset the unit to the default settings.

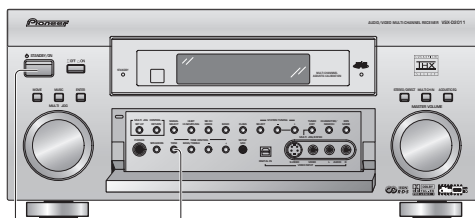

**1**      **1**

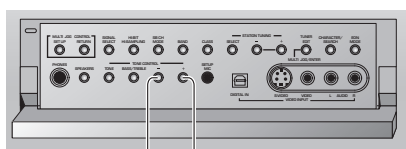

**2**   **2**

**1** While holding down the **TONE** button press the **STANDBY/ON** button for about three seconds.

**2** When you see **RESET?** appear in the display, press the **TONE -** button. **OK?** appears in the display, press **TONE +**.

When **OK** appears in the display all the settings, including the speaker, surround sound settings and tuner settings, will be reset in the unit to the default settings.



If the receiver is disconnected from a power source, or the main power is turned off, for about a month or longer it will reset to the default settings.



# Fine Tuning Your System

## Other System Settings

These settings are more advanced. Some could add depth or listenability to your sound (like the THX CINEMA setup) and others are for your convenience (like the FUNCTION RENAME). You can decide if you want to make these settings or not. They are not crucial to good surround sound. You only need to make these settings once (unless you change the placement of your current speaker system, add new speakers or components to your system, etc.). These setup operations use your TV to display the settings and choices so be sure your TV and receiver are properly hooked up. Use the arrow buttons (▲▼) and the ENTER button on the remote control to navigate the OSDs on your TV. Conversely, you can use the MULTI JOG dial and ENTER button, and look at the display, on the Front Panel.

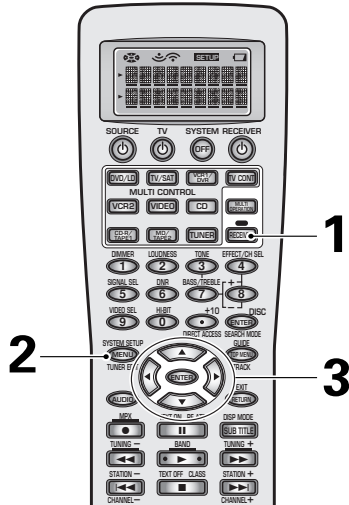

### 1 Turn on the receiver and your TV, press RECEIVER on the remote control.

Make sure your TV is set to the receiver.

### 2 Press the SYSTEM SETUP button.

The menu possibilities appear on your TV.

### 3 Follow the order below to make advance settings. Use the ▲▼ buttons to choose a menu. When you have the setup you want press ENTER.

In each mode, the current settings are displayed automatically.

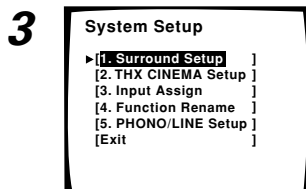
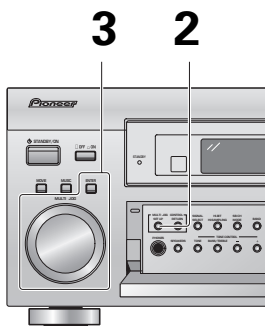

#### THX CINEMA Setup (page 90)

This setup lets you choose which decoding method the receiver will use for THX CINEMA.

#### INPUT ASSIGN (pages 91-92)

If you hook up your digital components in a different way than the default settings you need to tell the receiver how you hooked them up so the names on the remote control and front panel match your home setup. Do this with the DIGITAL-IN SELECT setup. Also, if you hooked up video devices with component video cable you need to tell the receiver which devices are hook up in this way. Do this with the COMPONENT-IN SELECT setup.

#### FUNCTION RENAME (page 93)

This feature allows you to change the names that appear in the receiver display to reflect what you have connected.

#### PHONO/LINE Setup (page 94)

This feature allows you to hook up either a turntable or a line level component (like a CD player) to the same terminal. Use this setup to tell the receiver which you hooked up.

# THX CINEMA Setup

This setup lets you choose which decoding method for 2 channel sources the receiver will use for THX CINEMA. For more information on the decoding (playback) formats see "Techno Tidbits" starting on page 104.

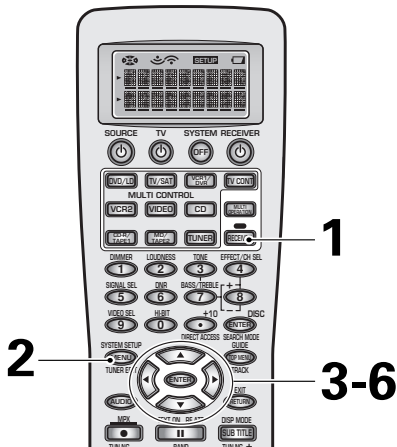

(If you are continuing from page 89 you can skip the first two steps.)

**1 Turn on the receiver and your TV, press RECEIVER on the remote control.**

**2 Press the SYSTEM SETUP button.**

**3 Looking at the on-screen display on your TV, use the ▲▼ buttons to select THX CINEMA SETUP. Press the ENTER button.**

**4 Use the ▲▼ buttons to choose either PRO LOGIC II MOVIE, PRO LOGIC or NEO:6 CINEMA as the decoding method. Press the ENTER button.**

The default is PRO LOGIC II MOVIE.

**5 EXIT should be selected (if not, use the ▲▼ buttons to select it). Press ENTER.**

**6 Use the ▲▼ buttons to select EXIT and press ENTER, again.**

This exits the SYSTEM SETUP mode and returns to normal operation.

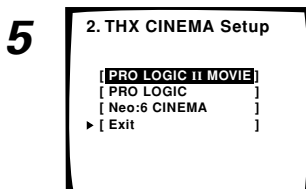
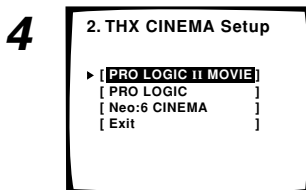
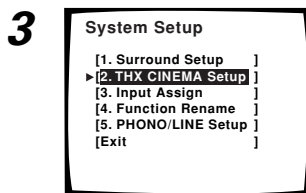
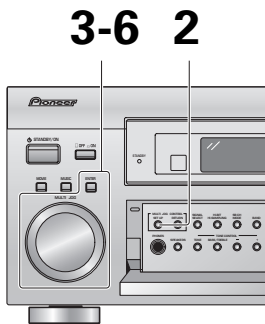

## Assigning the Digital Inputs

If you did not hook up your digital equipment in accordance with the default settings for the digital inputs (see pages 17, 19 & 22-23) you need to complete the procedure below. You have to do this in order to tell the receiver what digital equipment is hooked up to which terminal so the buttons on the remote correspond to what you have hooked up.

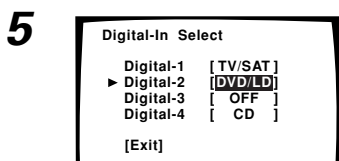
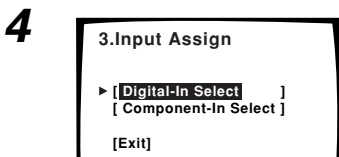
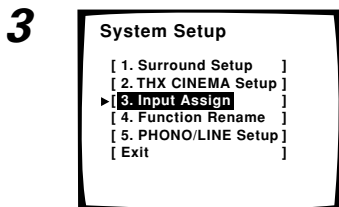
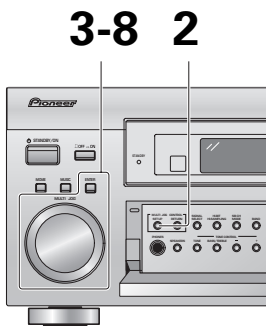
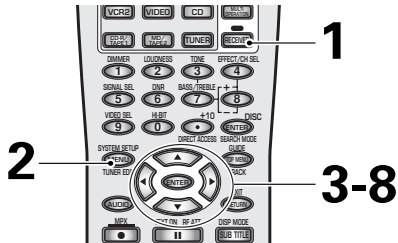

(If you are continuing from page 89 you can skip the first two steps.)

- 1 Turn on the receiver and your TV, press RECEIVER on the remote control.**
- 2 Press the SYSTEM SETUP button.**
- 3 Looking at the on-screen display on your TV, use the ▲▼ buttons to select INPUT ASSIGN. Press the ENTER button.**
- 4 DIGITAL-IN SELECT should be selected, if not use the ▲▼ buttons to select it. Press the ENTER button.**
- 5 Use the ▲▼ buttons to move through the different digital inputs and press the ENTER button.**
- 6 Use the ▲▼ buttons select the component that you hooked up to that digital in. Press the ENTER button.**  
If you're not sure which component is connected to which digital in, look on the back of the receiver and check the cables you connected.
- 7 When you're finished use the ▲▼ buttons to select EXIT and press ENTER.**  
This exits the DIGITAL-IN SELECT mode.
- 8 Use the ▲▼ buttons to select EXIT and press ENTER. Then, use the ▲▼ buttons to select EXIT and press ENTER again.**  
This exits the SYSTEM SETUP mode and returns to normal operation.



- The possible digital inputs that can be assigned are: DVD/LD, TV/SAT, VCR1, VCR2, CD, CD-R, MD.
- If you assign a digital input to a certain function (for example DVD/LD) then any digital inputs previously assigned to that function will automatically be set to OFF. This is because one function cannot be assigned to two different places.

## Assigning the Component Video Inputs

This receiver has two component video inputs. Their default settings are video inputs for the DVD/LD (COMPONENT VIDEO IN [1]) and TV/SAT (COMPONENT VIDEO IN [2]) functions, but you can reassign them if you want to use them as video inputs for other receiver functions (for example a VCR).

See pages 16–19 for more on connecting equipment using component video cords.

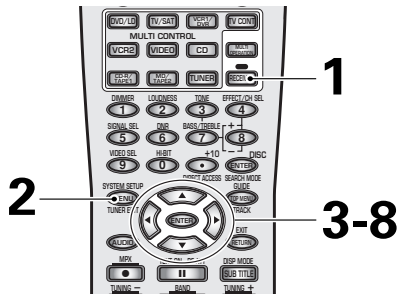

(If you are continuing from page 89 you can skip the first two steps.)

- 1 Turn on the receiver and your TV, press RECEIVER on the remote control.
- 2 Press the SYSTEM SETUP button.
- 3 Looking at the on-screen display on your TV, use the ▲▼ buttons to select INPUT ASSIGN. Press the ENTER button.
- 4 Use the ▲▼ buttons to select COMPONENT-IN SELECT then press ENTER.
- 5 Use the ▲▼ buttons to select the component video input you want to reassign. Press the ENTER button.

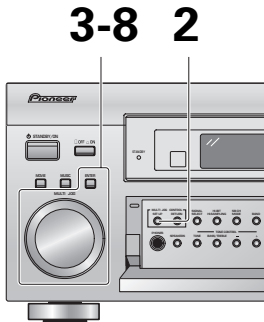

- 4 Use the ▲▼ buttons to select COMPONENT-IN SELECT then press ENTER.
- 5 Use the ▲▼ buttons to select the component video input you want to reassign. Press the ENTER button.
- 6 Use the ▲▼ buttons to assign a receiver function.  
Choose between DVD/LD, TV/SAT, VCR1 and VCR2.

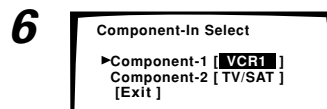
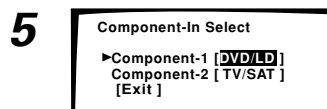
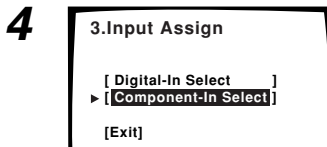
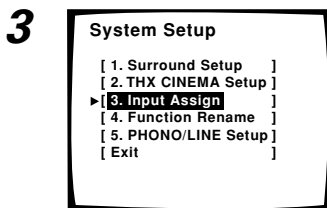

- 7 When you're finished use the ▲▼ buttons to select EXIT and press ENTER.  
You will leave the COMPONENT-IN SELECT mode.

- 8 Use the ▲▼ buttons to select EXIT and press ENTER. Then, use the ▲▼ buttons to select EXIT and press ENTER again.  
This exits the SYSTEM SETUP mode and returns to normal operation.



If you connect any source component to the receiver using a component video input, you should also have your TV connected to this receiver's component video output.

# FUNCTION RENAME

Use the FUNCTION RENAME capability to rename the display on the receiver and your OSD for different functions (DVD, etc.). For example, you could rename VCR1/DVR as DVR-7000. For this particular setup using the controls on the front panel is more convenient than using the remote control. Use the MULTI JOG dial instead of the ▲▼ buttons and use the ENTER button on the front panel. You can also use the display on the front panel as opposed to the OSD.

## 3-9 2 RETURN button

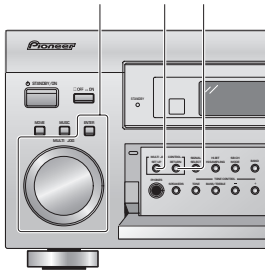

(If you are continuing from page 89 you can skip the first two steps.)

**1 Turn on the receiver and your TV. (If you want to use the remote control for this setup, press the RECEIVER button.)**

**2 Press the SET UP button.**

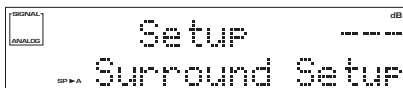

This display appears on the receiver.

**3 Looking at the display on your receiver, use the MULTI JOG to select FUNCTION RENAME. Press the ENTER button.**

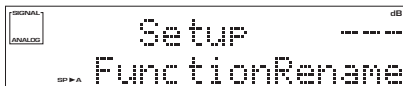

**4 Use the MULTI JOG to select the name of the function (for example, DVD/LD) you want to change. Press ENTER.**



Either the cursor underline bar or a character (depending on which is selected) will blink.

The functions are divided into three different on-screen displays so you may have to move through them to find the function you want to rename.

**5 Use the MULTI JOG to cycle the cursor through the letters, numbers and symbols. Use the ENTER button to enter one of the possibilities or move forward a space.**



The possible selections are shown below.

```

ABCDEFGHIJKLMNOPQRSTUVWXYZ
abcdefghijklmnopqrstuvwxyz
0123456789
!"#$%&'()*+,-./:;<=>?@[ \ ]_{} [space]
    
```

**6 Repeat step 5 until you get the name as you want it.**



You can input up to ten characters.

**7 Press ENTER repeatedly to exit the name. The new function name is set.**

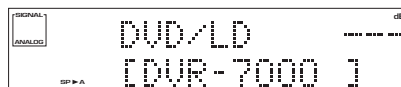

**8 Repeat steps 4-7 to change other function names. Use the MULTI JOG to select EXIT and press ENTER.**

**9 Use the MULTI JOG to select EXIT and press ENTER.**

This exits the SYSTEM SETUP mode and returns to normal operation.



Use the RETURN button to move the cursor back one character when entering a name.

# PHONO/LINE Setup

The PHONO/LINE setup allows you to decide whether you'll hook up a turntable or a line level component (most components, like CD players and DVD players, are line level).

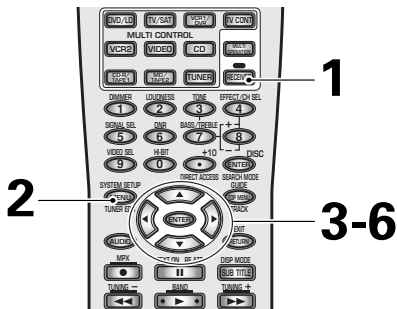

(If you are continuing from page 89 you can skip the first two steps.)

**1 Turn on the receiver and your TV, press RECEIVER on the remote control.**

**2 Press the SYSTEM SETUP button.**

**3 Looking at the on-screen display on your TV, use the ▲▼ buttons to select PHONO/LINE SETUP. Press the ENTER button.**

**4 Use the ▲▼ buttons to select the PHONO or LINE. Press ENTER.**

PHONO: Use this setting for turntables (without a built-in equalizer or pre-amplifier).

LINE: Use this setting for all audio components other than a turntable and for turntables with a built-in phono equalizer.

**5 EXIT should be selected (if not, use the ▲▼ buttons to select it). Press ENTER.**

**6 Use the ▲▼ buttons to select EXIT and press ENTER, again.**

This exits the SYSTEM SETUP mode and returns to normal operation.

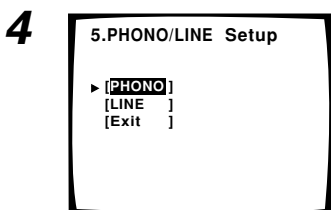
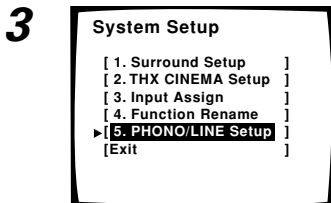
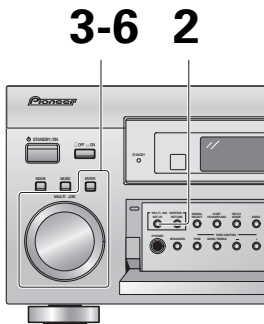

The default is PHONO.

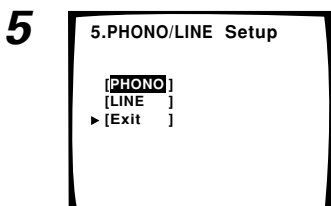

## Expert Setup

The settings here can only be done if you've performed the more basic preliminary setups. Thus, before doing these settings do either AUTO setup (page 13–15), QUICK setup (page 38) or NORMAL setup (page 39–43). These settings are to further heighten your surround sound. They are not absolutely necessary but may give more defined and enjoyable surround sound. You can decide if you want to make these settings or not. You only need to make these settings once (unless you change the placement of your current speaker system, add new speakers or components to your system, etc.). These setup operations use your TV to display the settings and choices so be sure your TV and receiver are properly hooked up. Use the arrow buttons (▲▼) and the ENTER button on the remote control to navigate the OSDs on your TV. Conversely, you can use the MULTI JOG dial and ENTER button, and look at the display, on the Front Panel.

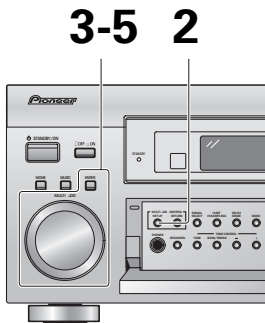
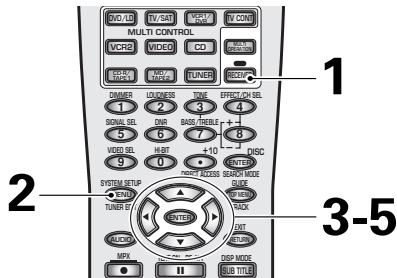

### 1 Turn on the receiver and your TV, press RECEIVER on the remote control.

Make sure your TV is set to the receiver.

### 2 Press the SYSTEM SETUP button.

The menu possibilities appear on your TV.

### 3 SURROUND SETUP should be selected (if it's not use the ▲▼ buttons to select it). Press the ENTER button.

### 4 Select EXPERT with the ▲▼ buttons. Press the ENTER button.

### 5 Follow the order below to make expert settings. Use the ▲▼ buttons to navigate through the menus. When you have the setting you want in particular menu, press ENTER.

In each mode, the current settings are displayed on the screen.

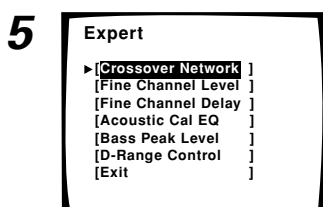
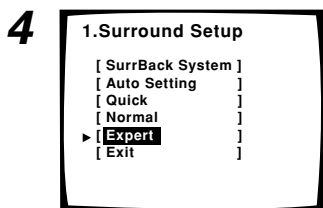
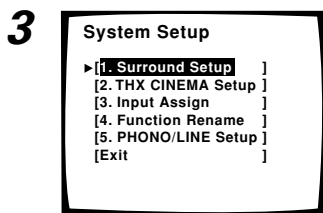

#### CROSSOVER NETWORK (page 96)

This feature determines which frequencies will be sent to the subwoofer (or large speakers).

#### FINE CHANNEL LEVEL (page 97)

This feature balances the sound output level of your speakers more finely than in the NORMAL setup.

#### FINE CHANNEL DELAY (page 98)

This feature adjusts the delay level of your speakers more finely than in the NORMAL setup.

#### ACOUSTIC CAL EQ (pages 99–101)

This feature allows you to adjust the amount of a certain frequency in a soundtrack, acting as a kind of room equalizer for your speakers.

#### BASS PEAK LEVEL (page 102)

Dolby Digital and DTS audio sources include ultra-low bass tones. Set the bass peak level as needed to prevent the ultra-low bass tones from distorting the sound from the speakers.

#### DYNAMIC RANGE CONTROL (page 103)

This feature makes possible excellent surround sound effects when listening to Dolby Digital and DTS sources at low volumes.

## Fine Tuning Your System

### CROSSOVER NETWORK

Crossover frequency is the point where the receiver divides the high and low sounds (the frequencies) between the speakers. Certain bass sounds will play back from the subwoofer if you selected it as YES (or PLUS) or from the front speakers if you selected them as LARGE. This setting decides where the cutoff will be between those bass sounds playing back from the speaker selected as above and the bass sounds for the entire soundtrack, which play back from all speakers used.

If all speakers are set to LARGE (see pages 40–41) this setup is unnecessary.

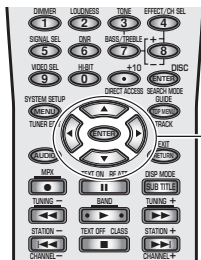

1-3

1-3

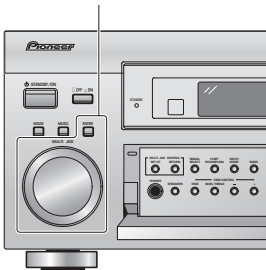

Follow steps 1-5 on page 95, if necessary, to get to the starting point mentioned here.

**1 Crossover Network should be selected, if it isn't use the ▲▼ buttons to select and press ENTER.**

**2 Use the ▲▼ buttons to select frequency cut off point. Press ENTER.**

Frequencies below the cut off point will be sent to the subwoofer (or large speakers). For example, choosing 50 Hz sends bass frequencies below 50 Hz to the subwoofer (or large speakers).

**3 EXIT should be selected (if it's not use the ▲▼ buttons to select it). Press ENTER.**

Next, proceed to FINE CHANNEL LEVEL.

**If you want to change a setting before proceeding start over from step 1.**

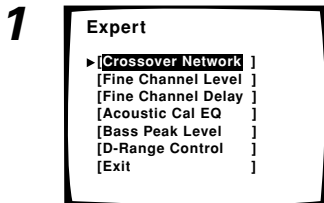

The default is 80Hz.

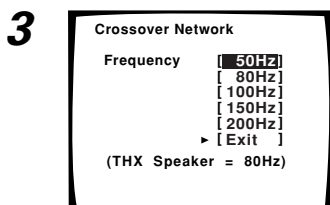
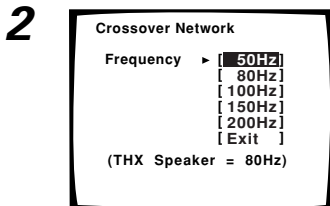



**FINE CHANNEL LEVEL**

The following steps show you how to balance the sound output level of your speakers more finely than in the NORMAL setup (see page 42). Proper speaker balance is essential for obtaining high quality surround sound and the better the speaker balance the better surround sound you can get. Do this procedure if you want to try and get even finer surround sound.

The main difference with this setup method and the CHANNEL LEVEL setup method in NORMAL setup is that here the test tone alternates between the front left speaker (which is used as the reference channel) and the target speaker (that is, the speaker whose level you want to adjust). Listen to the two tones and try to make them the same volume.

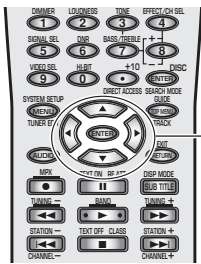

1-5

Follow steps 1-5 on page 95, if necessary, to get to the starting point mentioned here.

**1 FINE CHANNEL LEVEL should be selected, if it isn't use the ▲▼ buttons to select and press ENTER.**

**2 Use the ▲▼ buttons to select the channel you want to adjust. Press ENTER.**

Test tones will be output.

**WARNING : Be prepared! The test tones are output at a high volume level.**

MASTER VOLUME rotates to the reference position (0 dB) and the display on the receiver flashes TEST TONE. After a few seconds the test tone is output.

**3 Adjust the level of the channel using the ▲▼ buttons.**

Try to get the volume level of the target speaker to match that of the front left speaker, which is the reference in this setup. The levels can be set within a range of -10 dB to +10 dB in 0.5 dB steps.

When you press ENTER you will automatically go to the next channel.

**4 Press ENTER to select a new channel. Repeat step 3 for every channel.**

**If you want to change a setting before proceeding**

Use the ▲▼ buttons to go back to the channel you want to adjust and press ENTER. Then follow step 3.

**5 When done select EXIT (if it's not already selected) and press ENTER.**

Next, if you want, proceed to FINE CHANNEL DELAY.

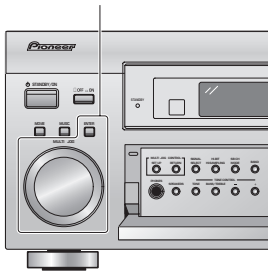

1-5

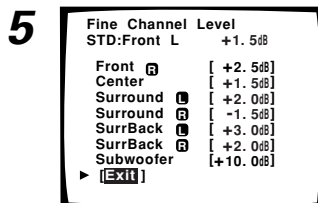
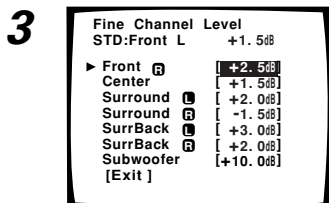
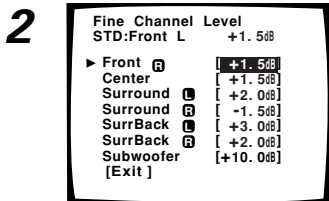
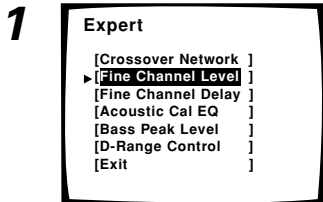

## FINE CHANNEL DELAY

The following steps show you how to adjust the delay level of your speakers more finely than in the NORMAL setup (see page 43). Adding a slight delay to some speakers is necessary to achieve proper sound depth, separation as well as an effective surround sound effect. Do this procedure if you want to try and get even finer surround sound.

The main difference with this setup method and the CHANNEL DELAY setup method in NORMAL setup is that here the test tone sounds from a reference channel and you use that to measure the target speaker (that is, the speaker whose level you want to adjust).

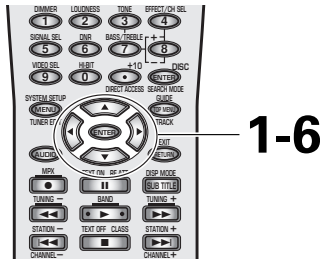

Follow steps 1-5 on page 95, if necessary, to get to the starting point mentioned here.

**1 FINE CHANNEL DELAY should be selected, if it isn't use the ▲▼ buttons to select and press ENTER.**

**2 Use the ▲▼ buttons to adjust the distance of the FRONT L channel. Press ENTER.**

Test tones will be output.  
This channel will be the target reference which you use to measure the other channels.

**3 Use the ▲▼ buttons to select the channel you want to adjust. Press ENTER.**

Test tones will be output for the channel you want to adjust and a reference channel.  
Listen to the reference channel and use to measure the target channel.

**4 Adjust the distance of each channel using the ▲▼ buttons.**

Listen to the reference channel and use it to measure the target channel. Stand facing the two speakers with your arms outstretched pointing at each speaker. Try to make the two tones sound as if they are arriving simultaneously at a position slightly in front of you and between your arm span. The distance can be set within a range of 0.1 m to 9.0 m in 0.1 m steps.  
When you press ENTER you will automatically go to the next channel.

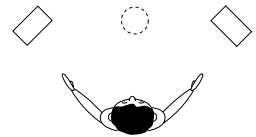

**5 Press ENTER to select a new channel. Repeat step 4 for every channel.**

If you want to change a setting before proceeding Use the ▲▼ buttons to go back to the channel you want to adjust and press ENTER. Then follow step 3.

**6 When done select EXIT (if it's not already selected) and press ENTER.**

Next, if you want, proceed to ACOUSTIC CAL EQ.

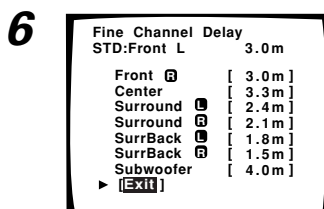
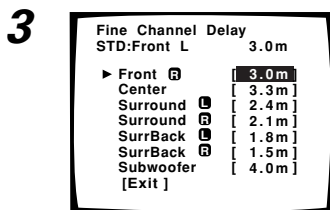
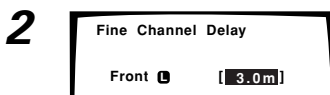
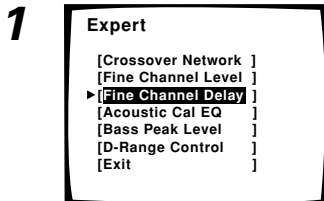
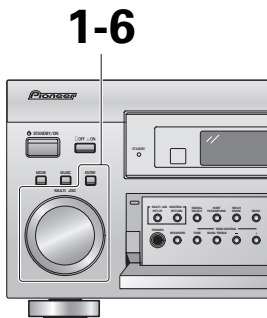

## ACOUSTIC CAL EQ

This setting is a kind of room equalizer for your speakers and is set automatically if you did the AUTO SURROUND SOUND SETUP (see pages 13–15), which we strongly recommend. It balances the frequency response between your speakers. In order to follow the instructions in this section you should have done AUTO SURROUND SOUND SETUP on pages 13–15.

This receiver lets you choose between two types of ACOUSTIC CAL EQ equalizer curves: ALL CH ADJUST and FRONT ALIGN, with the former equalizing the speakers individually and the latter equalizing the speakers in accordance with the front speakers. Features here allow you to put in your own equalizer preferences. To do this use the DATA COPY feature to copy the settings in ALL CH ADJUST and FRONT ALIGN modes and paste them into CUSTOM 1 or CUSTOM 2. You then choose between the ALL CH ADJUST and FRONT ALIGN types of curves and increase the amount of a certain frequency in each speaker in accordance with your preferences. When you playback a source you can choose CUSTOM 1 or CUSTOM 2 to apply your preferences to playback. When setting up using the ALL CH ADJUST mode you can adjust each speaker individually. With the FRONT ALIGN mode the front speakers will serve as the reference so you cannot adjust them. The DATA CHECK feature allows you to see how the settings in ALL CH ADJUST and FRONT ALIGN currently stand.

When you use ACOUSTIC CAL EQ function (see page 50) you can toggle between the two basic settings, ALL CH ADJUST and FRONT ALIGN, and the variations you set yourself, CUSTOM 1 and CUSTOM 2.



1-5

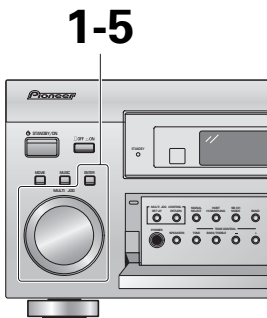

1-5

To start the process use **DATA COPY** to paste the **ALL CH ADJUST** or **FRONT ALIGN** settings into **CUSTOM 1** or **CUSTOM 2**. Follow steps 1-5 on page 95, if necessary, to get to the starting point mentioned here.

**1 ACOUSTIC CAL EQ should be selected, if it isn't use the ▲▼ buttons to select and press ENTER.**

**2 Use the ▲▼ buttons to select DATA COPY. Press ENTER.**

**3 Use the ▲▼ buttons to select CUSTOM 1 or CUSTOM 2 as the destination you want to copy the data to. Press ENTER.**

**4 Use the ▲▼ buttons to select ALL CH ADJUST or FRONT ALIGN as the type of curve you want to copy. Press ENTER.**

When you press ENTER the data is copied to the destination you chose. After you have done this process once you can also copy data in CUSTOM 1 or CUSTOM 2.

**5 When done select EXIT (if it's not already selected) and press ENTER.**

You can now adjust the settings in CUSTOM 1 or CUSTOM 2.

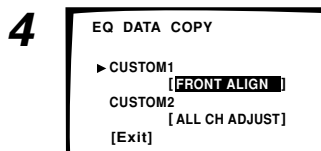
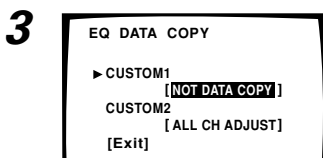
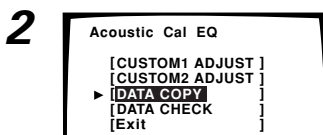
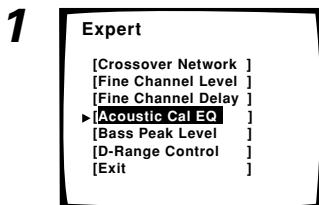

For explanation purposes the illustrations use ALL CH ADJUST.

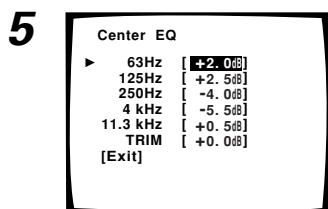
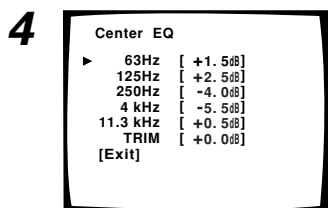
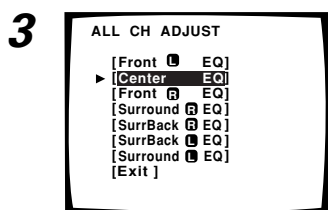
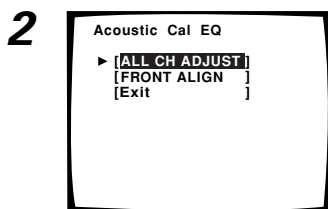
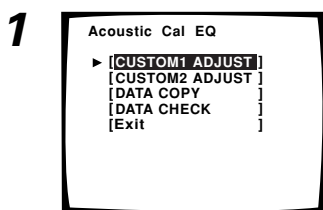

This explanation is for CUSTOM 1 or CUSTOM 2.

**1 The four possibilities should be on the OSD. Use the ▲▼ buttons to select CUSTOM 1 or CUSTOM 2. Press ENTER.**

**2 Use the ▲▼ buttons to select ALL CH ADJUST or FRONT ALIGN and press ENTER.**

The test tones will sound.

**WARNING: the test tones are very loud!!** Make sure there are no infants or small children in the room and that no one who will be scared, upset or damaged by loud noise is present. You yourself may want to wear earplugs.

Here the terms ALL CH ADJUST and FRONT ALIGN represent two types of equalizer methods that emphasize different characteristics of the sound.

**ALL CH ADJUST:** In this method all the speakers (except for the subwoofer) are independent. The settings that were input when you did the AUTO SURROUND SOUND SETUP (see pages 13-15) will be present but you can adjust each speaker individually to suit your taste. The test tones for each channel will sound individually.

**FRONT ALIGN:** In this method all speakers (except for the subwoofer) are set in accordance with the settings of the FRONT speakers. The settings that were input when you did the AUTO SURROUND SOUND SETUP (see pages 13-15) will be present but you can adjust each speaker individually to suit your taste. This setting allows the listener to enjoy a sound balance defined by the front speakers. The front left speaker will serve as the reference tone. The front left tone and the target speaker (the one you are trying to adjust) will sound in turns, so you can judge which needs to be louder.

**3 Use the ▲▼ buttons to select the channel that you want to adjust. Press ENTER.**

For FRONT ALIGN you won't be able to adjust the FRONT speakers.

**4 Use the ▲▼ buttons to select the frequency you want to adjust. Press ENTER.**

For the speakers you set to SMALL (see page 41) you won't be able to adjust the 63 Hz setting.

**5 Use the ▲▼ buttons to adjust the frequency. When you have it at the level you want press ENTER.**

Set the frequencies within the -6 dB to +6 dB range in steps of 0.5 dB. If OVER appears in the display you have set the levels too high. Reduce them until OVER disappears.

**6 The cursor automatically goes to the next frequency. Press ENTER and repeat steps 4 & 5 to adjust all the frequencies.**

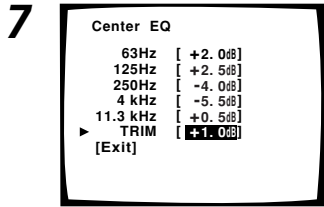

7 TRIM should be selected (if it isn't use the ▲▼ buttons to select it) and press ENTER.

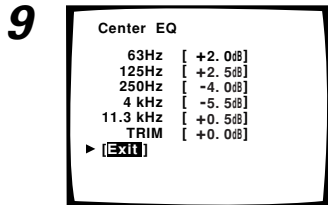

8 Use the ▲▼ buttons to adjust the TRIM and press ENTER.

TRIM will balance the volume level of each frequency in the overall volume of that speaker.

9 EXIT should be selected (if it isn't use the ▲▼ buttons to select it) and press ENTER.

10 The cursor automatically goes to the next channel. Press ENTER and repeat steps 3 – 8 to adjust all the channels.

11 EXIT should be selected (if it isn't use the ▲▼ buttons to select it) and press ENTER.

Leave the setup by using the ▲▼ buttons to select EXIT and pressing ENTER. You can now go to DATA CHECK or leave the ACOUSTIC CAL EQ setting by using the ▲▼ buttons to select EXIT and pressing ENTER.

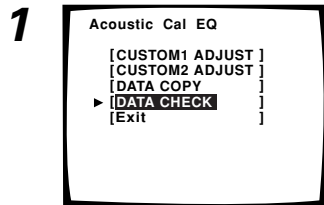

To use the DATA CHECK feature follow the steps here.

1 Use the ▲▼ buttons to select DATA CHECK. Press ENTER.

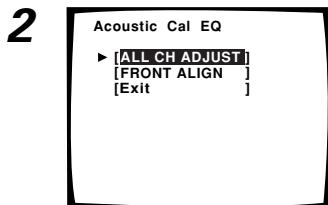

2 Select either ALL CH ADJUST or FRONT ALIGN as the data you want to check. Press ENTER.

3 Use the ▲▼ buttons to select the channel that you want to check. Press ENTER.

That channel appears so you can check the setting.

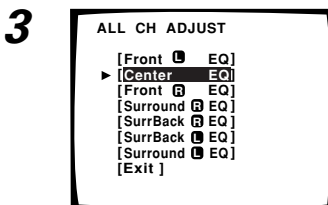

4 When that channel has been checked, use the ▲▼ buttons to select the EXIT and press ENTER.

5 Repeat step 3 & 4 to check all the channels.

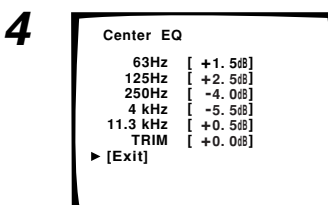

6 When all channels have been checked select EXIT (if it's not already selected) and press ENTER.

Leave the setup by using the ▲▼ buttons to select EXIT and pressing ENTER. You can now go to another ACOUSTIC CAL EQ setting by using the ▲▼ buttons and pressing ENTER.

### BASS PEAK LEVEL

The LFE (Low Frequency Effect) channel in Dolby Digital and DTS program sources can produce heavily concentrated ultra-low bass tones that may exceed the capabilities of your speaker system. The following steps show you how to limit the peak level for the LFE channel. If continuing from the preceding page the BASS PEAK LEVEL should be selected.

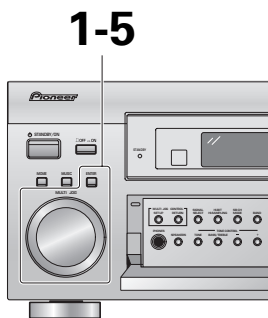
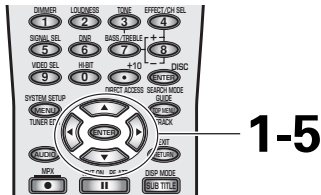

Follow steps 1-5 on page 95, if necessary, to get to the starting point mentioned here.

**1 BASS PEAK LEVEL should be selected, if it isn't use the ▲▼ buttons to select and press ENTER.**

**2 Use the ▲▼ buttons to select SETTING START or SETTING CANCEL. Press ENTER.**

**SETTING START:** The MASTER VOLUME is set to MIN (---dB), a test tone plays back and you make the setting (go to step 3).

**SETTING CANCEL:** This setting won't limit the peak level of the LFE channel.

If you selected **SETTING CANCEL** go to step 4.

**3 Use the ▲▼ buttons to adjust the test tone and specify the bass peak level.**

① Raise the level gradually.

② Set the bass peak level at the point just before the tone starts to distort.

**Be careful! Test tones play back at loud volumes . Make sure there are no infants or small children in the room.**

**You can leave this setup any time by pressing ENTER.**

If the YES or PLUS setting on the subwoofer is selected the test tone will only play back from the subwoofer. If not, the test tone will play back from all speakers set to LARGE except for the subwoofer.

**4 Press ENTER.**

The display on the receiver will show FADE and then RESUME while the MASTER VOLUME returns to its original position.

**5 EXIT should be selected (if it isn't use the ▲▼ buttons to select it), press ENTER.**

**If you want to change a setting before proceeding** Start over from step 1.

Next, if you want, proceed to DYNAMIC RANGE CONTROL

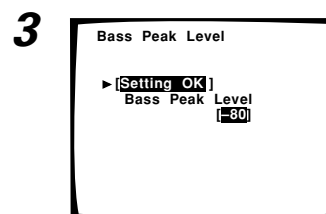
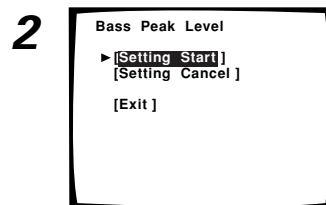
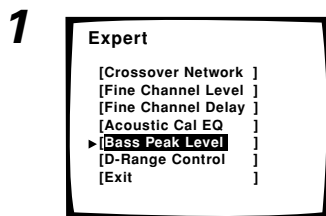

If you set this level before the receiver will have that level input but it will not appear on this setup screen. (The screen will always open with the level showing [- - -].)

## DYNAMIC RANGE CONTROL

This feature makes it possible to enjoy full surround sound effects on Dolby Digital and DTS sources even at low volumes. It does this by compressing the dynamic range. Dynamic range is the difference between the loudest and the softest sounds in any given signal. Compressing the range plays sounds so the quieter ones are audible and the louder ones don't get distorted or become overpowering. This feature only applies to Dolby Digital and DTS sources but the MIDNIGHT mode (explained on page 51) accomplishes the same end for a variety of sources. If continuing from BASS PEAK LEVEL, DYNAMIC RANGE CONTROL should be selected.

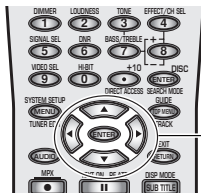

1-6

1-6

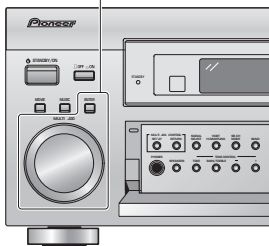

Follow steps 1-5 on page 95, if necessary, to get to the starting point mentioned here.

**1 D-RANGE CONTROL should be selected, if it isn't use the ▲▼ buttons to select and press ENTER.**

**2 Use the ▲▼ buttons to choose either OFF, MID or MAX. Press ENTER.**

Dynamic Range Control is set.

OFF: No Dynamic Range Control.

MID: A moderate amount of Dynamic Range Control is applied.

MAX: The most Dynamic Range Control available is applied.

**3 EXIT should be selected (if it isn't use the ▲▼ buttons to select it), press ENTER.**

If you want to change a setting before proceeding Start over from step 1.

**4 You are now finished with EXPERT SETUP, EXIT should be selected (if it isn't use the ▲▼ buttons to select it), press ENTER.**

**5 EXIT in SURROUND SETUP menu should be selected (if it isn't use the ▲▼ buttons to select it), press ENTER.**

**6 Use the ▲▼ buttons to select EXIT in the SYSTEM SETUP menu, press ENTER.**

The receiver returns to normal operation.

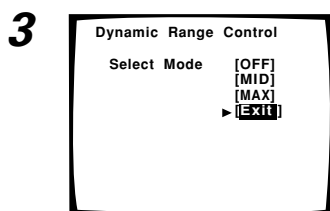
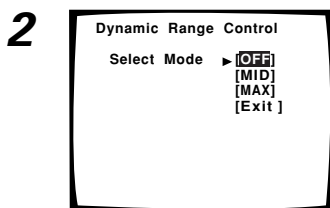
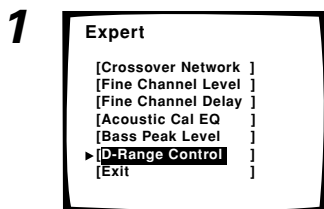

The default is OFF.

# Techno Tidbits & Problem-solving

## Dolby



### Dolby Digital

Dolby Digital is a discrete digital surround format used for multichannel surround sound. It was developed after the Dolby Surround system and Dolby Pro Logic Surround system. Dolby Digital is a high quality digital sound format that is used by many theatrical film releases.

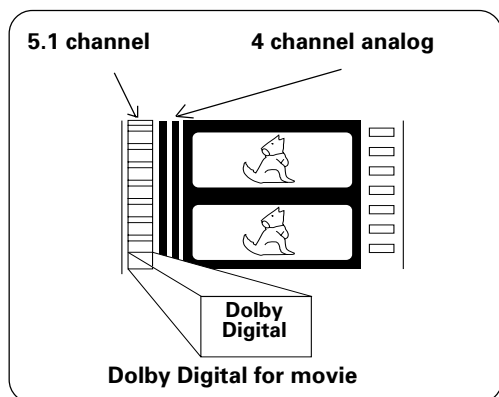

Soundtracks using linear PCM audio generate too much data for multichannel use. Dolby Digital technology was developed in response to the need for efficient multichannel digital sound. It uses masking technology and Adaptive Transform Coding, resulting in no audible loss of sound quality. In the present age of digital sound Dolby Digital is a standard audio format for DVD and has been adopted by HDTV broadcasts throughout the USA.

Other features include:

- 1) Downmixing on playback for compatibility with mono, stereo, Dolby Pro Logic and 5.1 channel audio.
- 2) A wide range of bitrates and channels.
- 3) Decoding dynamic range information and adjusting the dialog level in the soundtrack (called Dialog Normalization, see below for more information).

The advantages of the Dolby Digital system of encoding allow it to maintain its high quality sound while at the same time being very flexible, with the ability to handle many different types of soundtracks.

### Dialog Normalization

When a Dolby Digital soundtrack is played back the Dialog Normalization function of the receiver activates automatically. Dialog Normalization is a Dolby Digital function that establishes the average dialog level for the program source being played. If the receiver's level does not match the average dialog level, first you see "DIAL NORM" and "OFFSET +4 dB" (as an example) appear in the receiver's display. In this example, the number +4 dB is the difference between the receiver's gain structure and the Dolby Digital average dialog level. To match the average dialog level, subtract or add the OFFSET level. For example, if the OFFSET level is +4 dB, the amplifier's output is 4 dB over the average recorded level.

### Dolby Pro Logic II

Dolby Pro Logic II is an improved version of Dolby Pro Logic technology with extended matrix decoding technology that can create 5.1 channel sound from two channel sources. Dolby Pro Logic II creates basic 5 channel sound by using the innovative "steering logic" circuit. Therefore when listening to typical two-channel sources like CD, the listener can enjoy a richer spatial effect. When using software encoded with Dolby Surround, this decoding system affords the listener an improved surround experience with greater sound detail.

### Chart Comparing Dolby Pro Logic and Dolby Pro Logic II

	Pro Logic	Pro Logic II
Effective sound source	Dolby Surround encoded sources	All two channel stereo sources
Surround Sound	Mono	Stereo
Frequency Range	Surround within 7 kHz	All Channels/Full Range

This unit has a three Dolby Pro Logic II functions. The first is "MOVIE Mode" (suitable for film soundtracks); "MUSIC Mode" (suitable for music); "Pro Logic Mode" (this mode is less sensitive to the quality of the source material, so may be useful when MOVIE Mode or MUSIC Mode do not give good results). One can select one of them depending on your soundtrack of choice.





### Dolby Digital Surround EX

This new recording technology is able to play 6.1 channel sound and was developed in a collaboration between Dolby Laboratories and Lucasfilm, Ltd. for the film "Stars Wars: The First Episode", the first movie ever to be made with Dolby Digital Surround EX technology. In a movie theater this format affords the listener vivid surround sound experience replete with the effect of sounds flying overhead, even for those seated towards the sides of the theater.

Dolby Digital Surround EX contains surround back channels which are dubbed into the soundtrack in studio. The channels are encoded into the left and right channels of the soundtrack so this format can be compatible with Dolby Digital 5.1 channel decoding. For a list of movies that contain Dolby Digital Surround EX soundtracks see Dolby website at: <http://www.dolby.com>

THX Surround EX technology was developed for movie theater use originally but has been extended for home theater use and consumers can no benefit from this excellent, realistic sound format. (For more details see "THX Surround EX" on the next page.) This unit is equipped with a THX Surround EX decoder.

### DTS



#### DTS

DTS has been adopted as a sound recording format in the movie theaters since the release of "JURASSIC PARK" in 1993, and has a good reputation for high quality sound and dynamic surround effects. In this system, 6 channels of digital sound are recorded on CD-ROM. DTS adopts a simultaneous playback format. With a low rate of compression of sound signals and a high rate of transmittance, a higher sound quality format is produced. For this reason, the format is being introduced in more and more movie theaters, and is being adopted for home use as DTS Digital Surround. When used with movies it's called DTS-LD DVD and for music software (5.1 channel CD) as DTS-CD .

#### DTS-ES

DTS launched a new surround format in November 2000. This has come to be known as DTS Extended Surround or simply DTS-ES. The technology has been advanced to include two new home formats DTS-ES Discrete 6.1 format, and DTS-ES Matrix 6.1 ch format, both are able to playback discrete, 6.1-channel content from DVDs and CDs. Both of these formats are compatible with a conventional DTS 5.1 ch decoder. In this system each channel is encoded and decoded individually, adding to the separation of the channels. Since DTS adds a third surround channel, the surround back channel, the realism and all-encompassing nature of the sound reaches levels not seen before in home theater. This unit is equipped with a DTS-ES decoder.

#### DTS Neo:6

This is a matrix decoding technology that transforms two-channel sources into 6.0 channel surround sound. There are two modes, CINEMA MODE and MUSIC MODE.

#### DTS 96/24

This high-quality format will be used for software which will be available from November, 2001. For compatibility with equipment that was produced before this format was made, DVD players can play this software using a conventional DTS 5.1ch decoder. This unit is equipped with a DTS 96 kHz/24 bit decoder to take advantage of the higher sound quality available.

# THX<sup>®</sup>



THX is a Lucasfilm, Ltd. program dedicated to maximum accuracy in movie presentation. Movie sound tracks are recorded in large movie dubbing stages using movie theater equipment. For a sound track to be presented accurately in your home, special technologies are required. In your home the room is much smaller and has a bright sound, the speakers are very different and there are only six-eight of them, plus, you sit much closer to each one of those speakers. Because of these differences we often miss the power and emotion that thrills us in a good movie. Now Pioneer and THX have teamed up to bring the full glory of accurate cinema sound to the comfort and convenience of your home.

**Re-Equalization™** : In a theater the room is very large and dead sounding, you sit a long way back from the speakers and the speakers themselves are very specialized. Because a sound track recorded in this dead sounding space when it is played at home it sounds overbright. THX Re-Equalization adjusts for this difference in a very precise way.

**Adaptive Decorrelation™** : When a sound track sends mono sound to the surround speakers it often seems to be coming from one side instead of from all around you as it would in a theater. Adaptive Decorrelation helps to correct this inaccuracy.

**Timbre Matching™** : When recording a sound track it is very important that the surround sounds move smoothly and seamlessly around the theater. It is very distracting when sounds seem to jump from speaker to speaker. Timbre Matching helps to smooth the movement of the surround sounds even though you are using only two speakers.

**Bass Peak Level Manager™** : Some Dolby Digital sound tracks can produce bass peaks that are undesirable in a home theater environment. The Bass Peak Level Manager allows you to set the maximum peak levels appropriate to your system. (Set this function according to the **Bass Peak Level** instructions on page 102.)

**Loudspeaker Position Time Synchronization™** : This feature allows you to adjust for the difference in the distance from each individual loudspeaker to the listening position. Doing this ensures that all the speakers operate in precise synchronization improving the seamless nature of the soundfield. (Set this function according to the **Channel Delay** or **Fine Channel Delay** instructions on pages 43 and 98, respectively.)

**THX Surround EX™** : THX Surround EX–Dolby Digital Surround EX is a joint development of Dolby Laboratories and the THX division of Lucasfilm Ltd.

In a movie theater, film soundtracks that have been encoded with Dolby Digital Surround EX technology are able to reproduce an extra channel which has been added during the mixing of the program. This channel, called Surround Back, places sounds behind the listener in addition to the currently available front left, front center, front right, surround right, surround left and subwoofer channels. This additional channel provides the opportunity for more detailed imaging behind the listener and brings more depth, spacious ambience and sound localization than ever before.

When released to the home consumer market, movies that were created using the Dolby Digital Surround EX technology, may have a note to that effect on the packaging. A list of movies created using this technology can be found on the Dolby web site at <http://www.dolby.com>.

Only receiver and controller products bearing the THX Surround EX logo, when in the THX Surround EX mode, faithfully reproduce this new technology in the home.

This product may also engage the "THX Surround EX" mode during the playback of 5.1 channel material that is not Dolby Digital Surround EX encoded. In such case the information delivered to the Surround Back channel will be program dependent and may or may not be very pleasing depending on the particular soundtrack and the tastes of the individual listener.

# Schemata of Setup Screens

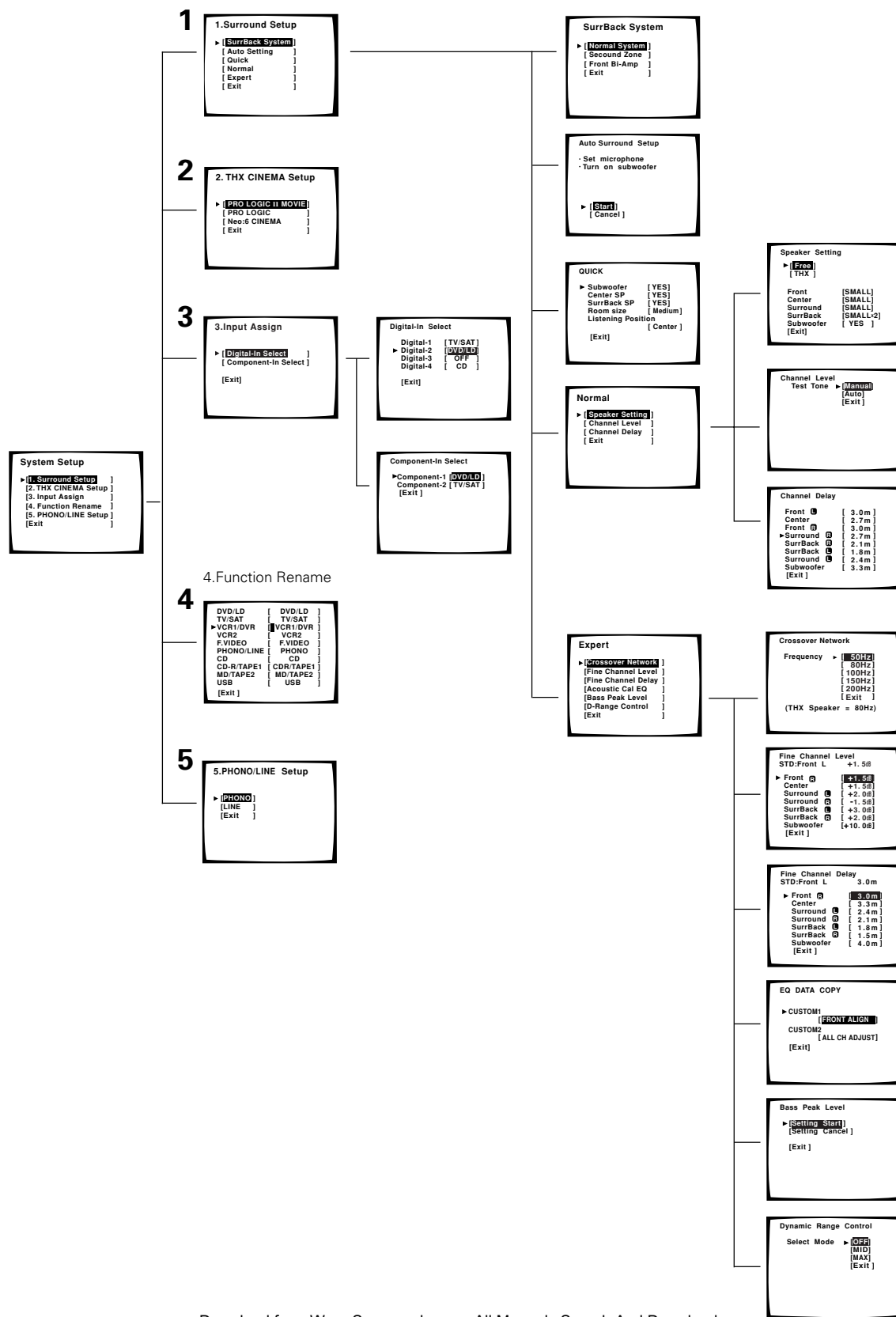

EXPERT

## Speaker Placement Information

Placement of your speakers is a crucial aspect of attaining accurate and realistic surround sound. Certain pointers concerning speakers stands, direction, angle and distance of speakers will be useful in this regard.

Firstly, it is best not to put your speakers directly on the floor. If you do this some of the sound vibration (especially bass) will go directly into the flooring and be lost. Instead we recommend using extremely hard objects (like cinder blocks) or designated speaker stands to support your speakers. Avoid placing the speakers on soft (like cushions or sofas) as these will also lead to sound loss and unstable surfaces (like flimsy shelving) as they may cause speaker accidents. In order to achieve a surround sound effect, make sure the speakers are a reasonable distance from your main listening position. Follow the diagrams and instructions below for optimum placement of each set of speakers.

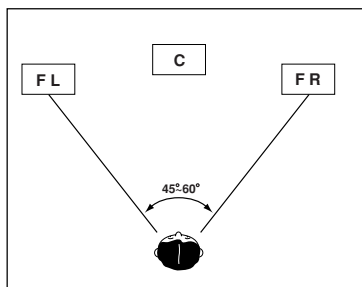

If you're using a CENTER speaker set the FRONT speakers to a wider angle. If not, set them to a narrower angle.

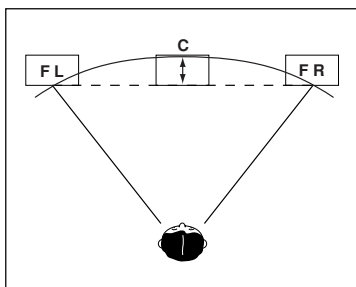

Make sure the CENTER speaker does not cross the forward plane of the FRONT speakers.

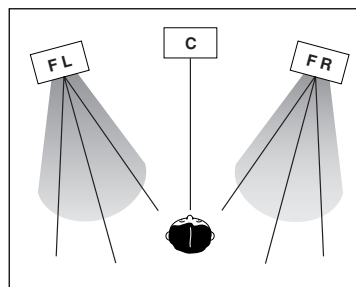

It is best to angle the speakers towards the listening position. The angle depends on the size of the room. Use less angle for bigger rooms.

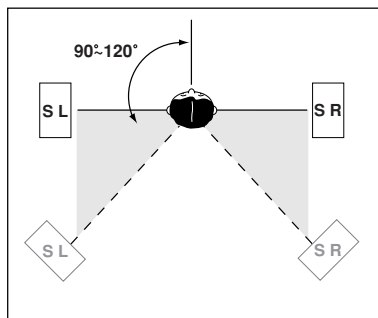

Surround speakers should be positioned 45 cm–90 cm higher than your ears and titled slight downward. Make sure the speakers don't face each other. For DVD Audio the speakers should be more directly behind the listener than for home theater playback.

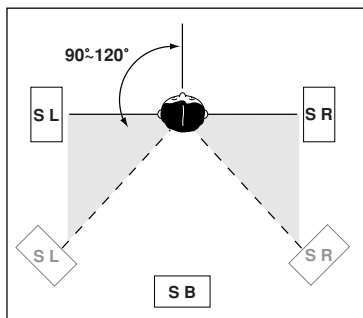

Surround back speakers should also be positioned 45 cm–90 cm higher than your ears and titled slight downward. Make sure the speakers don't face each other. For DVD Audio the speakers should be more directly behind the listener than for home theater playback.

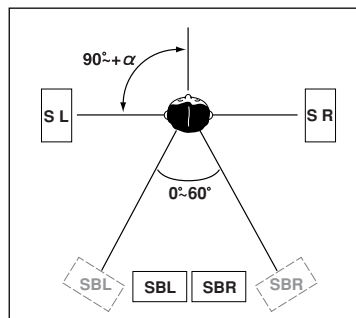

### Speaker Placement for a Complete THX Speaker System

If you have a complete THX Speaker System set (LucasFilm authorized), follow the diagram below to place your speakers.

Notice the surround speakers should output at an angle parallel to the listener. Also, notice the angle of the front speakers.

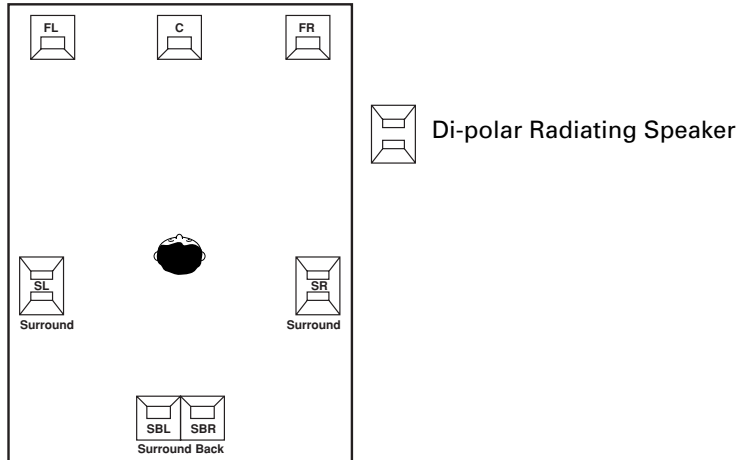

### Speaker Placement for DVD-Audio (etc.) Sources

The best speaker placement for DVD-Audio (and other multichannel music sources) may be different than for regular DVD discs. For these formats follow the diagram at right as opposed to the home theater setups of the preceding pages.

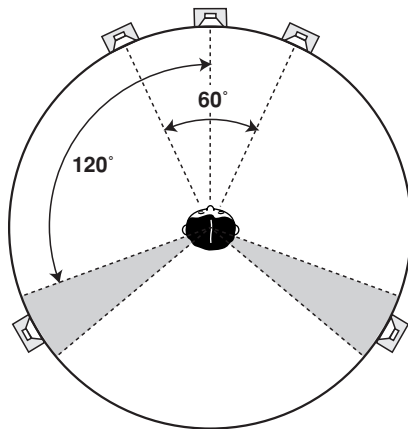

# Troubleshooting

Incorrect operations are often mistaken for trouble and malfunctions. If you think that there is something wrong with this component, check the points below. Sometimes the trouble may lie in another component. Investigate the other components and electrical appliances being used. If the trouble cannot be rectified even after exercising the checks listed below, ask your nearest PIONEER authorized service center or your dealer to carry out repair work.

Symptom	Cause	Remedy
<b>Power</b>		
<b>The power does not turn on.</b>	<ul style="list-style-type: none"> <li>The power plug is disconnected.</li> <li>The protection circuit may have been activated.</li> </ul>	<ul style="list-style-type: none"> <li>Connect the power plug to the wall outlet.</li> <li>Disconnect the power plug from the outlet, and insert again.</li> </ul>
<b>During loud playback the power suddenly switches off.</b>	<ul style="list-style-type: none"> <li>The protection circuit has been activated because the lowest actual impedance of the speakers (as opposed to the speakers' rated impedance) is dangerously low.</li> </ul>	<ul style="list-style-type: none"> <li>Turn down the volume.</li> <li>When it's convenient go to ACOUSTIC CALIBRATION EQ (pages 99–101) and lower the 63 Hz and 125 Hz equalizer levels using MANUAL setting.</li> </ul>
<b>The unit does not respond when the buttons are pressed.</b>	<ul style="list-style-type: none"> <li>Static electricity caused by dry air.</li> </ul>	<ul style="list-style-type: none"> <li>Switch the unit off, then on again.</li> <li>Disconnect the power plug from the outlet, and insert again.</li> </ul>
<b>During operation, the unit suddenly switches off.</b>	<ul style="list-style-type: none"> <li>The speaker wires are frayed or sticking out of the jack, and are touching the back of the receiver or another set of wires.</li> </ul>	<ul style="list-style-type: none"> <li>Reinsert the speaker wires, making sure there are no stray strands of wire and that they are inserted fully (see page 25).</li> </ul>
<b>AMP ERR blinks in the display and the unit turns off. The STANDBY indicator will blink and the unit cannot be turned on.</b>	<ul style="list-style-type: none"> <li>The receiver probably has a serious problem.</li> </ul>	<ul style="list-style-type: none"> <li>Don't try to turn on the receiver. Call a Pioneer-accredited repair center to look at the problem.</li> </ul>
<b>FAN STOP blinks in the display and the unit turns off.</b>	<ul style="list-style-type: none"> <li>Something is stuck in the fan and/or the fan is broken.</li> </ul>	<ul style="list-style-type: none"> <li>Remove the foreign object from the fan. If you can't do this and/or the fan is broken call a Pioneer-accredited repair center to look at the problem.</li> </ul>
<b>OVERHEAT blinks in the display and no sound is output.</b>	<ul style="list-style-type: none"> <li>The receiver has gotten too hot.</li> </ul>	<ul style="list-style-type: none"> <li>Turn the receiver off and allow it to cool down with good ventilation. It is very likely that you have a heat dispersal and ventilation problem so please follow the instructions in "Installing the Receiver" (page 8) carefully.</li> </ul>
<b>THDCT NG blinks in the display and the unit turns off.</b>	<ul style="list-style-type: none"> <li>The thermistor (temperature sensor) is broken.</li> </ul>	<ul style="list-style-type: none"> <li>Turn the receiver off, unplug from wall and call a Pioneer-accredited repair center to look at the problem.</li> </ul>
<b>Setup</b>		
<b>The setup screen doesn't appear.</b>	<ul style="list-style-type: none"> <li>The output jacks haven't been connected properly.</li> <li>The TV hasn't been connected to the MONITOR OUT 1 jack.</li> <li>You connected your TV to the MONITOR OUT 2 jack instead of the MONITOR OUT 1 jack.</li> <li>The PAL/NTSC setting is incorrect.</li> </ul>	<ul style="list-style-type: none"> <li>Check all connections (see pages 16-23).</li> <li>Connect the TV to the MONITOR OUT 1 jacks (see page 16).</li> <li>Connect the TV to the MONITOR OUT 1 jacks (see page 16).</li> <li>Select the correct PAL/NTSC setting (see page 8).</li> </ul>
<b>Every time AUTO SURROUND SOUND SETUP is attempted, there is some kind of error, or the settings seem incorrect.</b>	<ul style="list-style-type: none"> <li>The room environment is not optimal for auto setup (too much ambient noise; obstacles blocking the speakers from the microphone; the monitor noise is interfering with the setup; etc.).</li> </ul>	<ul style="list-style-type: none"> <li>Make sure the room environment is in line with the guidelines for auto setup in this manual (see pages 13–14, memos on page 15).</li> </ul>
<b>The LARGE and SMALL settings for speakers after the AUTO SURROUND SOUND SETUP are incorrect.</b>	<ul style="list-style-type: none"> <li>There are other frequencies in the room that are affecting the auto setup.</li> </ul>	<ul style="list-style-type: none"> <li>Check for household appliances (air conditioner, fan, etc.) that may be affecting the environment and switch them off if necessary.</li> </ul>

Symptom	Cause	Remedy
<b>After the proper settings have been made, there still seems to be something wrong with the sound.</b>	<ul style="list-style-type: none"> <li>The speakers have been incorrectly connected (left and right connections are reversed).</li> </ul>	<ul style="list-style-type: none"> <li>Check all connections. Be sure match the right channel on the speaker with the right channel on the speaker terminals (see page 25).</li> </ul>
<b>No audio</b>		
<b>No sound is output when a function is selected.</b>	<ul style="list-style-type: none"> <li>Improper connections.</li> <li>Sound is muted.</li> <li>The volume is turned down.</li> <li>Speakers are turned off.</li> <li>DIGITAL/ANALOG setting is incorrect.</li> <li>MULTI CH IN mode is on.</li> </ul>	<ul style="list-style-type: none"> <li>Make sure the component is connected correctly (see pages 16-26).</li> <li>Press MUTE on the remote control.</li> <li>Adjust MASTER VOLUME.</li> <li>Press SPEAKERS (A/B) to select the speakers you connected (see page 75).</li> <li>Select the proper signal with the SIGNAL SELECT button (see page 45).</li> <li>Turn MULTI CH IN mode off (see page 53).</li> </ul>
<b>No sound output from the front speakers.</b>	<ul style="list-style-type: none"> <li>The front speakers aren't connected properly.</li> </ul>	<ul style="list-style-type: none"> <li>Check all connections. (see page 25).</li> </ul>
<b>No sound output from surround or center speakers.</b>	<ul style="list-style-type: none"> <li>Speaker settings are incorrect.</li> <li>The surround or center speakers aren't connected properly.</li> <li>The listening mode is STEREO.</li> </ul>	<ul style="list-style-type: none"> <li>See SPEAKER SETTING on pages 40-41 to check the speaker settings.</li> <li>Check all connections (see page 25).</li> <li>Choose a surround listening mode (see page 44).</li> </ul>
<b>No sound output from the subwoofer.</b>	<ul style="list-style-type: none"> <li>The subwoofer setting is NO.</li> <li>The subwoofer output setting is too low.</li> <li>The bass peak level setting is too low.</li> <li>There is very little low frequency information in your source.</li> <li>The crossover frequency is set too low.</li> <li>There is a problem with the subwoofer.</li> <li>The subwoofer isn't connected properly.</li> </ul>	<ul style="list-style-type: none"> <li>Change the setting to YES or PLUS (see pages 40-41).</li> <li>Adjust the output setting to the level you want (see pages 43,97).</li> <li>Adjust the peak level setting to the level you want (see page 102).</li> <li>Change your subwoofer setting to one of the following (see pages 40-41): Front: SMALL Subwoofer: YES Front: LARGE Subwoofer: PLUS</li> <li>Raise the frequency level to match your speakers' characteristics (see page 96)</li> <li>Check the three following points: <ul style="list-style-type: none"> <li>Check the power.</li> <li>Check the subwoofer volume control .</li> <li>Check the subwoofer hasn't automatically switched to standby mode (check the subwoofer manual)</li> </ul> </li> <li>Check all connections (see page 25).</li> </ul>
<b>No sound output from the surround back speakers.</b>	<ul style="list-style-type: none"> <li>The SB CH MODE is set to OFF.</li> <li>The source is not a 6.1 channel playback source.</li> <li>The surround back speakers aren't connected properly.</li> <li>The surround back channel is set to 1 speaker setting only, and the speaker is connected to the right channel output.</li> </ul>	<ul style="list-style-type: none"> <li>Set the SB CH MODE to ON or AUTO (see page 54).</li> <li>Set the SB CH MODE to ON or AUTO and choose one of the SURROUND listening modes (see pages 54, 47-48).</li> <li>Check all connections (see pages 25).</li> <li>Connect the speaker to the surround back left channel output (see page 25).</li> </ul>
<b>No sound output from one (set of) speaker(s).</b>	<ul style="list-style-type: none"> <li>The speaker system setting is NO.</li> <li>The speaker isn't connected properly.</li> <li>The source has no sound output for that channel.</li> <li>The speaker output level is set too small.</li> </ul>	<ul style="list-style-type: none"> <li>Change the speaker setting to YES (see pages 40-41).</li> <li>Check all connections (see page 25).</li> <li>If you choose one of the SURROUND listening modes, a channel may be created for the speaker (see page 44).</li> <li>Increase the speaker output level.</li> </ul>

## Techno Tidbits & Problem-solving

Symptom	Cause	Remedy
<b>Sound is produced from some components, but not from digital components.</b>	<ul style="list-style-type: none"> <li>• SIGNAL SELECT is set incorrectly.</li> <li>• The digital inputs are assigned incorrectly, or not at all.</li> <li>• The digital components aren't connected properly.</li> <li>• The player is not compatible with the source you're using, or the player settings are incorrect.</li> <li>• The MULTI CH IN mode has been selected.</li> <li>• The digital output level has been turned down on a CD player or other component equipped with digital output level adjustment capability.</li> </ul>	<ul style="list-style-type: none"> <li>• Set SIGNAL SELECT to AUTO or according to the type of connections made (see page 45).</li> <li>• Set the digital input settings correctly (see pages 12, 23, and especially 91).</li> <li>• Check all connections.</li> <li>• Choose a compatible source, or check the player's manual for the correct settings.</li> <li>• Choose one of the listening modes (see pages 46-48). The MULTI CH IN switches off automatically.</li> <li>• Set the digital volume level of the player to full, or to the neutral position.</li> </ul>
<b>Other audio problems</b>		
<b>Subwoofer output is very low.</b>	<ul style="list-style-type: none"> <li>• Settings route signal away from subwoofer.</li> </ul>	<ul style="list-style-type: none"> <li>• To get more signal to the subwoofer set it to PLUS or choose SMALL for the front speakers (see pages 40-41).</li> </ul>
<b>During multichannel playback, there is no sound output from one speaker.</b>	<ul style="list-style-type: none"> <li>• That speaker is set to NO.</li> </ul>	<ul style="list-style-type: none"> <li>• Set the speaker to YES.</li> </ul>
<b>A multi channel DVD source appears to be downmixed from 2 channels during playback.</b>	<ul style="list-style-type: none"> <li>• The source is coming from something other than the MULTI CH IN jacks (for example, digital PCM output, etc.)</li> </ul>	<ul style="list-style-type: none"> <li>• Check the MULTI CH IN connection (see page 22) and select the type of playback with the MULTI CH IN button (see page 53).</li> </ul>
<b>Considerable noise in radio broadcasts.</b>	<ul style="list-style-type: none"> <li>• Incorrect frequency.</li> <li>• The antenna is not connected.</li> <li>• Digital cables are near the antenna terminals and wires.</li> </ul>	<ul style="list-style-type: none"> <li>• Tune in the correct frequency.</li> <li>• Connect the antenna (see page 24).</li> <li>• Route digital cables away from the antenna terminals and wires.</li> </ul>
<b>Broadcast stations cannot be selected.</b>	<ul style="list-style-type: none"> <li>• The channel step interval doesn't match that of your country or region. (multi-voltage model only)</li> </ul>	<ul style="list-style-type: none"> <li>• Match the channel step interval with that of your country or region (see page 58).</li> </ul>
<b>Broadcast stations cannot be selected automatically.</b>	<ul style="list-style-type: none"> <li>• The antenna is poorly positioned.</li> <li>• Interference caused by other equipment (fluorescent lamp, motor, etc.).</li> <li>• Weak radio signals.</li> </ul>	<ul style="list-style-type: none"> <li>• Adjust the direction and position for best reception.</li> <li>• Turn off the equipment causing the noise or move it away from the receiver.</li> <li>• Place the antenna farther away from the equipment causing the noise.</li> <li>• Connect an outdoor AM or FM antenna (see page 24).</li> </ul>
<b>Noise or hum can be heard even when there is no sound being input.</b>	<ul style="list-style-type: none"> <li>• There is electrical interference from another component or appliance.</li> </ul>	<ul style="list-style-type: none"> <li>• Check that personal computers or other digital components connected to the same power source are not causing interference.</li> </ul>
<b>When a search is performed by a DTS compatible CD player during playback, noise is output.</b>	<ul style="list-style-type: none"> <li>• The search function performed by the player interferes with the reading of digital information.</li> </ul>	<ul style="list-style-type: none"> <li>• This is not a malfunction, but be sure to turn the volume down to prevent the output of loud noise from your speakers.</li> </ul>
<b>When playing a DTS format LD there is noise audible on the soundtrack.</b>	<ul style="list-style-type: none"> <li>• The SIGNAL SELECT is on ANALOG.</li> </ul>	<ul style="list-style-type: none"> <li>• Set the SIGNAL SELECT to DIGITAL (see page 45).</li> </ul>



Symptom	Cause	Remedy
<b>Audio doesn't record (in some cases, even if video does).</b>	<ul style="list-style-type: none"> <li>You are trying to make an analog recording from a digital signal, or a digital recording of an analog source.</li> <li>The digital source is copy protected.</li> <li>The jacks for recording have not been connected properly.</li> </ul>	<ul style="list-style-type: none"> <li>You can only record analog to analog, or digital to digital. Make sure the playback and recording components are hooked up with the same kind of connections.</li> <li>You can't record digital sources that have been copy protected.</li> <li>Check connections (see pages 20 &amp; 22).</li> </ul>
<b>Video</b>		
<b>No image is output when a function is selected.</b>	<ul style="list-style-type: none"> <li>Improper connections.</li> <li>The input source is not properly selected.</li> <li>The video input selected on the TV monitor is incorrect.</li> <li>The TV or monitor is hooked up with cord that is different than that used for the video player.</li> <li>The component video setting is incorrect.</li> </ul>	<ul style="list-style-type: none"> <li>Make sure the component is connected correctly (see pages 16, 17-19).</li> <li>Press the correct function button.</li> <li>Please read the TV monitor manual and change the settings accordingly.</li> <li>Use the same cable to connect to your TV and all your video equipment (see pages 16-23).</li> <li>Select the correct COMPONENT IN SELECT setting (see page 93).</li> </ul>
<b>There is no image coming from the selected component video jacks.</b>	<ul style="list-style-type: none"> <li>The type of cord connected to the TV doesn't match your video input settings.</li> </ul>	<ul style="list-style-type: none"> <li>Change the settings to match the cord connected (see page 16).</li> </ul>
<b>Can't record video.</b>	<ul style="list-style-type: none"> <li>The source is copy protected.</li> <li>You are trying to record a source connected to the component video jacks.</li> <li>The recorder's video input is hooked up using a different type of cord to the source video output.</li> </ul>	<ul style="list-style-type: none"> <li>You can't record sources that have been copy protected.</li> <li>Connect the component with S video or composite video cords (see pages 16).</li> <li>Hook up the source and the recorder using the same type of video cord.</li> </ul>
<b>Input/display</b>		
<b>The display is dark.</b>	<ul style="list-style-type: none"> <li>The display DIMMER button is pushed.</li> </ul>	<ul style="list-style-type: none"> <li>Press DIMMER on the remote control repeatedly to return to the default setting (see page 56).</li> </ul>
<b>You can't get DIGITAL to come up when using the SIGNAL SELECT button.</b>	<ul style="list-style-type: none"> <li>Either the digital connections or the DIGITAL-IN SELECT is incorrect.</li> <li>MULTI CH IN mode is on.</li> </ul>	<ul style="list-style-type: none"> <li>Make sure the digital connections (see pages 17-19 &amp; 22-23) and the DIGITAL IN SELECT (see page 91) are done correctly.</li> <li>Turn MULTI CH IN mode off (see page 54).</li> </ul>
<b>The digital format indicator doesn't light up even when playing a non-PCM digital source.</b>	<ul style="list-style-type: none"> <li>The player is paused or stopped.</li> <li>There is a mistake in the player settings for audio output.</li> </ul>	<ul style="list-style-type: none"> <li>Play the source.</li> <li>Fix the audio settings (check the manual that came with your DVD player).</li> </ul>
<b>A compressed digital source is being played, but the digital format indicators don't light up.</b>	<ul style="list-style-type: none"> <li>Although it's a non-PCM digital source there is a possibility the present track is not the proper format (5.1, 6.1, or 7.1 channel).</li> </ul>	<ul style="list-style-type: none"> <li>There is no problem. The indicator won't light when the track is not a compressed digital source.</li> </ul>
<b>During playback of a compressed digital source, the PRO LOGIC II or NEO:6 indicators show in the display.</b>	<ul style="list-style-type: none"> <li>The digital signal is not being sent with the source.</li> <li>The audio is in two channel format.</li> <li>It has already been Dolby Surround encoded.</li> </ul>	<ul style="list-style-type: none"> <li>Choose DIGITAL or AUTO with the signal select button (see page 45).</li> <li>This is not a malfunction. Check the manufacturer information for the source.</li> </ul>

## Techno Tidbits & Problem-solving

Symptom	Cause	Remedy
<b>During playback of a Surround EX or DTS ES source on the AUTO setting, the EX and ES indicators won't light.</b>	<ul style="list-style-type: none"> <li>The source may be 6.1 playback compatible, but there is no signal from the source to indicate this.</li> </ul>	<ul style="list-style-type: none"> <li>Switch the SB CH MODE to ON (see page 54).</li> </ul>
<b>During playback of a DVD audio source, the player shows a transfer rate of 96 kHz, but the receiver does not.</b>	<ul style="list-style-type: none"> <li>The multichannel connections are analog, so there is no digital transfer.</li> </ul>	<ul style="list-style-type: none"> <li>This is not a malfunction. See the player's manual for more details.</li> </ul>
<b>During playback of a 96 kHz source, the display doesn't show 96 kHz</b>	<ul style="list-style-type: none"> <li>SIGNAL SELECT is set to ANALOG</li> </ul>	<ul style="list-style-type: none"> <li>SET the SIGNAL SELECT to AUTO (see page 45).</li> </ul>
<b>Remote control</b>		
<b>Cannot be remote controlled.</b>	<ul style="list-style-type: none"> <li>The remote control batteries have worn out.</li> <li>Too far away or improper angle of operation.</li> <li>There is an obstacle between the receiver and the remote control.</li> <li>Strong light such as fluorescent light is shining onto the unit's remote control signal light-receiving window.</li> <li>A cord is connected to the CONTROL IN terminal on this unit.</li> <li>The IR Receiver type is mismatched with the setting.</li> </ul>	<ul style="list-style-type: none"> <li>Replace the batteries (see page 7).</li> <li>Operate within 7 m and a 30° angle of the remote sensor on the front panel (see page 8).</li> <li>Remove the obstacle or operate from another position (see page 8).</li> <li>Avoid exposing the remote sensor on the front panel to direct light.</li> <li>Connect cord to the correct jack.</li> <li>Disconnect the IR Receiver from the rear panel, and set to the other IR Receiver type using the remote control.</li> </ul>
<b>Other components can't be operated with the system remote.</b>	<ul style="list-style-type: none"> <li>The preset code settings are wrong.</li> <li>The batteries wore out and the system settings were cleared.</li> </ul>	<ul style="list-style-type: none"> <li>Input the correct preset code.</li> <li>Reset the proper system settings.</li> </ul>
<b>The SR cable is connected, but the connected components can't be operated with the remote.</b>	<ul style="list-style-type: none"> <li>The SR cable hasn't been connected properly.</li> <li>The rest of the component connection have not been made.</li> <li>The component you have hooked up is not SR compatible.</li> </ul>	<ul style="list-style-type: none"> <li>Reinsert the SR cable, making sure it is the right jack (see page 79).</li> <li>Make sure an analog connection has been made between the units.</li> <li>This is not a malfunction.</li> </ul>

### If the unit does not operate normally due to external effects such as static electricity

Disconnect the power plug from the outlet and insert again to return to normal operating conditions.

#### Maintenance of External Surfaces

- Use a polishing cloth or dry cloth to wipe off dust and dirt.
- When the surfaces are dirty, wipe with a soft cloth dipped in some neutral cleanser diluted five or six times with water, and wrung out well, and then wipe again with a dry cloth. Do not use furniture wax or cleaners.
- Never use thinners, benzine, insecticide sprays or other chemicals on or near this unit, since these will corrode the surfaces.

## Preset Code Brands

You should have no problem controlling a component if you find the manufacturer in this list, but you can only set these code brands for the button that is assigned to that component. So, for example, the TV codes can only be set to the TV or TVCONT button. Please note that there are cases where only certain functions may be controllable after assigning the proper preset code, or the code brands for the manufacturer in the list will not work for the model that you are using. If you can't find a preset code brands that matches the component you want to control, you can still teach the remote individual commands from another remote control (see pages 68-69).

### DVD

**Brand**  
 PIONEER  
 DENON  
 JVC  
 PHILIPS  
 PANASONIC  
 RCA  
 SAMSUNG  
 SONY  
 TOSHIBA  
 YAMAHA

### LD

**Brand**  
 PIONEER  
 DENON  
 KENWOOD  
 PANASONIC  
 PHILIPS  
 SONY  
 YAMAHA

### CD-R

**Brand**  
 PIONEER  
 DENON  
 JVC  
 KENWOOD  
 PHILIPS  
 SONY

### DVR

**Brand**  
 PIONEER

### MD

**Brand**  
 PIONEER  
 DENON  
 JVC  
 KENWOOD  
 SONY  
 YAMAHA

### CD

**Brand**  
 PIONEER  
 DENON  
 FISHER  
 JVC  
 KENWOOD  
 MAGNAVOX  
 MARANTZ  
 ONKYO  
 PANASONIC  
 PHILIPS  
 RCA  
 SANYO  
 SHARP  
 SONY  
 TEAC  
 TECHNICS  
 YAMAHA

### STB (SATELLITE/ CATV)

**Brand**  
 PIONEER  
 BLAUPUNKT  
 GENERAL INSTRUMENT  
 GOLDSTAR  
 GRUNDIG  
 HAMLIN  
 HNS/HUGHES  
 HITACHI  
 ITT/NOKIA  
 JERROLD  
 NEC  
 OAK  
 PANASONIC  
 PHILIPS  
 RADIO SHACK  
 RCA  
 SAMSUNG  
 SCIENTIFIC ATLANTA  
 SIEMENS  
 SONY  
 TOSHIBA  
 TOCOM  
 ZENITH

### TAPE

**Brand**  
 PIONEER  
 DENON  
 FISHER  
 JVC  
 KENWOOD  
 NAKAMICHI  
 ONKYO  
 PHILIPS  
 SONY  
 TEAC  
 TECHNICS  
 YAMAHA

### TUNER

**Brand**  
 PIONEER

### VCR

**Brand**  
 PIONEER  
 ADMIRAL  
 AIWA  
 AKAI  
 ALBA  
 AUDIO DYNAMIC  
 BELL&HOWELL  
 BLAUPUNKT  
 BROCSONIC  
 BUSH  
 CANON  
 CGM  
 CITIZEN  
 CLATRONIC  
 CRAIG  
 CURTIS MATHIS  
 DAEWOO  
 DBX  
 DIMENSIA  
 EMERSON  
 FERGUSON  
 FISHER  
 FUNAI  
 GE  
 GOLDSTAR  
 GOODMAN  
 GRUNDIG  
 HITACHI  
 INSTANT REPLAY  
 ITT/NOKIA  
 JC PENNY  
 JVC  
 KENDO

KENWOOD  
 LOEWE  
 LUXOR  
 LXI  
 MAGNAVOX  
 MARANTZ  
 MARTA  
 MATSUI  
 MEMOREX  
 MINOLTA  
 MITSUBISHI  
 MULTITECH  
 NEC  
 NOKIA OCEANIC  
 NOKIA  
 NORDMENDE  
 OKANO  
 OLYMPIC  
 ORION  
 PANASONIC  
 PENTAX  
 PHILCO  
 PHILIPS  
 PHONOLA  
 QUASAR  
 RCA/PROSCAN  
 REALISTIC  
 SABA  
 SAMSUNG  
 SANSUI  
 SANYO  
 SCHNEIDER  
 SCOTT  
 SEG  
 SELECO  
 SHARP  
 SIEMENS  
 SIGNATURE  
 SONY  
 SYLVANIA  
 SYMPHONIC  
 TANDBERG  
 TASHIRO  
 TATUNG  
 TEAC  
 TECHNICS  
 TELEFUNKEN  
 THORN  
 TOSHIBA  
 UNIVERSUM  
 W.WHOUSE  
 WARDS  
 YAMAHA  
 ZENITH

### TV

#### Brand

PIONEER  
ADMIRAL  
AIWA  
AKAI  
ALBA  
AOC  
BESTAR  
BLAUPUNKT  
BLUE SKY  
BRANDT  
BROCSONIC  
BUSH  
CLATRONIC  
CRAIG  
CROSLEX  
CURTIS MATHIS  
DAEWOO  
DAYTRON  
DUAL  
EMERSON  
FERGUSON  
FIRST  
FISHER  
FUJITSU  
FUNAI  
GE  
GOLDSTAR  
GOODMANS  
GRANDIENTE  
GRUNDIG  
HITACHI  
ICE  
IRRADIO  
ITT/NOKIA  
JC PENNY  
JVC  
KENDO  
KTV  
LOEWE  
LXI  
MAGNAVOX  
MARK  
MATSUI  
MATSUSHITA  
MEDION  
MITSUBISHI  
MIVAR  
NEC  
NOKIA OCEANIC  
NORDMENDE  
OKANO  
ONWA

PANASONIC  
PHILCO  
PHILIPS  
PHONOLA  
PORTLAND  
PROSCAN  
QUASAR  
RADIO  
RADIO SHACK  
RADIOLA  
RCA/PROSCAN  
SABA  
SAMSUNG  
SANYO  
SCHNEIDER  
SCOTT  
SHARP  
SIEMENS  
SIGNATURE  
SONY  
SYLVANIA  
SYMPHONIC  
TATUNG  
TELEFUNKEN  
THOMSON  
THORN  
TOSHIBA  
UNIVERSUM  
VIDECH  
W.WHOUSE  
WARDS  
WATSON  
ZENITH

## Specifications (European model)

### Amplifier Section

Continuous Power Output (DIN)	
FRONT .....	100 W + 100 W (DIN 1 kHz, THD 1 %, 8 $\Omega$ )
CENTER .....	100 W (DIN 1 kHz, THD 1 %, 8 $\Omega$ )
SURROUND .....	100 W + 100 W (DIN 1 kHz, THD 1 %, 8 $\Omega$ )
SURROUND BACK .....	100 W + 100 W (DIN 1 kHz, THD 1 %, 8 $\Omega$ )
Rated Power Output .....	100 W + 100 W (20 Hz – 20 kHz, 0.09 %, 8 $\Omega$ )

### Input (Sensitivity/Impedance)

PHONO MM .....	4.7 mV/47 k $\Omega$
VCR 1/DVR, VCR 2, DVD/LD, TV/SAT, VIDEO, CD, CD-R/TAPE 1, MD/TAPE 2 .....	335 mV/47 k $\Omega$

### Frequency Response

PHONO MM .....	20 Hz to 20,000 Hz $\pm$ 0.3 dB
VCR 1/DVR, VCR 2, DVD/LD, TV/SAT, VIDEO, CD, CD-R/TAPE 1, MD/TAPE 2 .....	5 Hz to 100,000 Hz $^{+0}_{-3}$ dB

### Output (Level/Impedance)

VCR 1/DVR REC, VCR 2 REC, CD-R/TAPE 1 REC, MD/TAPE 2 REC .....	335 mV/2.2 k $\Omega$
---	-----------------------

### Tone Control

BASS .....	$\pm$ 6 dB (100 Hz)
TREBLE .....	$\pm$ 6 dB (10 kHz)
LOUDNESS .....	+4/+2 dB (100 Hz/10 kHz) (at volume position -40dB)

### Signal-to-Noise Ratio (IHF, short circuited, A network)

VCR 1/DVR, VCR 2, DVD/LD, TV/SAT, VIDEO, CD, CD-R/TAPE 1, MD/TAPE 2, MULTI CH IN .....	101 dB
---	--------

### Signal-to-Noise Ratio

[DIN (Continuous rated power output/50 mW)]	
VCR 1/DVR, VCR 2, DVD/LD, TV/SAT, VIDEO, CD, CD-R/TAPE 1, MD/TAPE 2 .....	92/65 dB

### VIDEO Section (S jack)

#### Input (Sensitivity/Impedance)

VCR 1/DVR, VCR 2, VIDEO, DVD/LD, TV/SAT	
Luminance signal (Y) .....	1 V <sub>p-p</sub> /75 $\Omega$
Chrominance signal (C) .....	0.286 V <sub>p-p</sub> /75 $\Omega$

#### Output (Level/Impedance)

VCR 1/DVR, VCR 2, MONITOR OUT	
Luminance signal (Y) .....	1 V <sub>p-p</sub> /75 $\Omega$
Chrominance signal (C) .....	0.286 V <sub>p-p</sub> /75 $\Omega$

#### Frequency Response

VCR 1/DVR, VCR 2, VIDEO, DVD/LD, TV/SAT	
Luminance signal (Y) .....	5 Hz to 10 MHz $^{+0}_{-3}$ dB

#### Signal-to-Noise Ratio

Luminance signal (Y) .....	65 dB
----------------------------	-------

### Component Video Section

#### Input (Sensitivity)

Y .....	1 V <sub>p-p</sub> /75 $\Omega$
P <sub>B</sub> /P <sub>R</sub> .....	0.7 V/75 $\Omega$

#### Output (Level/Impedance)

Y .....	1 V <sub>p-p</sub> /75 $\Omega$
P <sub>B</sub> /P <sub>R</sub> .....	0.7 V/75 $\Omega$

#### Frequency Response

Y .....	5 Hz to 40 MHz $^{+0}_{-3}$ dB
P <sub>B</sub> /P <sub>R</sub> .....	5 Hz to 40 MHz $^{+0}_{-3}$ dB

### VIDEO Section (Composite)

#### Input (Sensitivity/Impedance)

VCR 1/DVR, VCR 2, VIDEO, DVD/LD, TV/SAT .....	1 V <sub>p-p</sub> /75 $\Omega$
--	---------------------------------

#### Output (Level/Impedance)

VCR 1/DVR, VCR 2, MONITOR OUT, MONITOR OUT2 .....	1 V <sub>p-p</sub> /75 $\Omega$
--	---------------------------------

#### Frequency Response

VCR 1/DVR, VCR 2, TV/SAT, DVD/LD VIDEO $\rightarrow$ MONITOR OUT, .....	5 Hz to 10 MHz $^{+0}_{-3}$ dB
Signal-to-Noise Ratio .....	65 dB

### FM Tuner Section

#### Frequency Range .....

87.5 MHz to 108 MHz

#### Usable Sensitivity .....

Mono: 13.2 dBf, IHF (1.3  $\mu$ V/75  $\Omega$ )

#### 50 dB Quieting Sensitivity .....

Mono: 20.2 dBf

#### Signal-to-Noise Ratio .....

Stereo: 38.6 dBf

#### Distortion .....

Stereo: 70 dB (at 85 dBf)

#### Alternate Channel Selectivity .....

Stereo: 0.5 % (1 kHz)

#### Stereo Separation .....

60 dB (400 kHz)

#### Frequency Response .....

40 dB (1 kHz)

#### Antenna Input .....

30 Hz to 15 kHz ( $\pm$  1 dB)

#### Antenna .....

75  $\Omega$  unbalanced

### AM Tuner Section

#### Frequency Range .....

531 kHz to 1,602 kHz

#### Sensitivity (IHF, Loop antenna) .....

350  $\mu$ V/m

#### Selectivity .....

25 dB

#### Signal-to-Noise Ratio .....

50 dB

#### Antenna .....

Loop antenna

### Miscellaneous

#### Power Requirements .....

AC 220 - 230 V, 50/60 Hz

#### Power Consumption .....

600 W

#### Power Consumption in Standby mode .....

0.7 W

#### AC Outlets

#### SWITCHED .....

100 W (0.8A) MAX.

#### Dimensions .....

420 (W)  $\times$  188 (H)  $\times$  464 (D) mm

#### Weight (without package) .....

19.6 kg

### Furnished Parts

#### FM Wire Antenna .....

1

#### AM Loop Antenna .....

1

#### "AA" IEC LR6 batteries .....

4

#### Remote Control Unit .....

1

#### Microphone for Auto Surround Sound Setup .....

1

#### Microphone Stand for Auto Surround Sound Setup .....

1

#### Operating Instructions .....

1

### NOTE:

Specifications and the design are subject to possible modifications without notice, due to improvements.

## Specifications (multi-voltage model)

### Amplifier Section

Maximum Output Power ..... 130 W/channel  
(1 kHz, THD 10.0 %, 8 Ω)

Continuous Power Output (DIN)

FRONT ..... 100 W + 100 W (DIN 1 kHz, THD 1 %, 8 Ω)

CENTER ..... 100 W (DIN 1 kHz, THD 1 %, 8 Ω)

SURROUND ..... 100 W + 100 W

(DIN 1 kHz, THD 1 %, 8 Ω)

SURROUND BACK ..... 100 W + 100 W

(DIN 1 kHz, THD 1 %, 8 Ω)

Rated Power Output ..... 100 W + 100 W  
(20 Hz-20 kHz, 0.09 %, 8 Ω)

Input (Sensitivity/Impedance)

PHONO MM ..... 4.7 mV/47 kΩ

VCR 1/DVR, VCR 2, DVD/LD, TV/SAT, VIDEO, CD,

CD-R/TAPE 1, MD/TAPE 2 ..... 335 mV/47 kΩ

Phono Overload level (T.H.D.0.1 %, 1kHz)

PHONO MM ..... 120 mV

Frequency Response

PHONO MM ..... 20 Hz to 20,000 Hz ± 0.3 dB

VCR 1/DVR, VCR 2, DVD/LD, TV/SAT, VIDEO, CD,

CD-R/TAPE 1, MD/TAPE 2 ..... 5 Hz to 100,000 Hz <sup>+0</sup><sub>-3</sub> dB

Output (Level/Impedance)

LINE ..... 335 mV/2.2 kΩ

Tone Control

BASS ..... ± 6 dB (100 Hz)

TREBLE ..... ± 6 dB (10 kHz)

LOUDNESS ..... +10 dB (100 Hz/10 kHz)

Signal-to-Noise Ratio (IHF, short circuited, A network)

VCR 1/DVR, VCR 2, DVD/LD, TV/SAT, VIDEO, CD,

CD-R/TAPE 1, MD/TAPE 2, MULTI CH IN ..... 101 dB

Signal-to-Noise Ratio

[DIN (Continuous rated power output/50 mW)]

VCR 1/DVR, VCR 2, DVD/LD, TV/SAT, VIDEO, CD,

CD-R/TAPE 1/MD, MD/TAPE 2 ..... 92/65 dB

Signal-to Noise Ratio [EIA, at 1 W (1 kHz)]

VCR 1/DVR, VCR 2, DVD/LD, TV/SAT, VIDEO, CD,

CD-R/TAPE 1/MD, MD/TAPE 2 ..... 93 dB

### VIDEO Section (S jack)

Input (Sensitivity/Impedance)

VCR 1/DVR, VCR 2, VIDEO, DVD/LD, TV/SAT

Luminance signal (Y) ..... 1 V<sub>p-p</sub>/75 Ω

Chrominance signal (C) ..... 0.286 V<sub>p-p</sub>/75 Ω

Output (Level/Impedance)

VCR 1/DVR, VCR 2, MONITOR OUT

Luminance signal (Y) ..... 1 V<sub>p-p</sub>/75 Ω

Chrominance signal (C) ..... 0.286 V<sub>p-p</sub>/75 Ω

Frequency Response

VCR 1/DVR, VCR 2, VIDEO, DVD/LD, TV/SAT

Luminance signal (Y) ..... 5 Hz to 10 MHz <sup>+0</sup><sub>-3</sub> dB

Signal-to-Noise Ratio

Luminance signal (Y) ..... 65 dB

### Component Video Section

Input (Sensitivity)

Y ..... 1 V<sub>p-p</sub>/75 Ω

P<sub>B</sub>/P<sub>R</sub> ..... 0.7 V/75 Ω

Output (Level/Impedance)

Y ..... 1 V<sub>p-p</sub>/75 Ω

P<sub>B</sub>/P<sub>R</sub> ..... 0.7 V/75 Ω

Frequency Response

Y ..... 5 Hz to 40 MHz <sup>+0</sup><sub>-3</sub> dB

P<sub>B</sub>/P<sub>R</sub> ..... 5 Hz to 40 MHz <sup>+0</sup><sub>-3</sub> dB

### VIDEO Section (Composite)

Input (Sensitivity/Impedance)

VCR 1/DVR, VCR 2, VIDEO, DVD/LD,

TV/SAT ..... 1 V<sub>p-p</sub>/75 Ω

Output (Level/Impedance)

VCR 1/DVR, VCR 2, MONITOR OUT,

MONITOR OUT2 ..... 1 V<sub>p-p</sub>/75 Ω

Frequency Response

VCR 1/DVR, VCR 2, TV/SAT, DVD/LD

VIDEO→MONITOR OUT, ..... 5 Hz to 10 MHz <sup>+0</sup><sub>-3</sub> dB

Signal-to-Noise Ratio ..... 65 dB

### FM Tuner Section

Frequency Range ..... 87.5 MHz to 108 MHz

Usable Sensitivity ..... Mono:13.2 dBf, IHF (1.3 μV/ 75 Ω)

50 dB Quieting Sensitivity ..... Mono: 20.2 dBf

..... Stereo: 38.6 dBf

Signal-to-Noise Ratio ..... Mono: 73 dB (at 85 dBf)

..... Stereo: 70 dB (at 85 dBf)

Distortion ..... Stereo: 0.5 % (1 kHz)

Alternate Channel Selectivity ..... 60 dB (400 kHz)

Stereo Separation ..... 40 dB (1 kHz)

Frequency Response ..... 30 Hz to 15 kHz (± 1 dB)

Antenna Input ..... 75 Ω unbalanced

### AM Tuner Section

Frequency Range ..... 531 kHz to 1,602 kHz (9 kHz step)

..... 530 kHz to 1,700 kHz (10 kHz step)

Sensitivity (IHF, Loop antenna) ..... 350 μV/m

Selectivity ..... 25 dB

Signal-to-Noise Ratio ..... 50 dB

Antenna ..... Loop antenna

**Miscellaneous**

Power Requirements ..... AC 110/120-127/220/230-240 V, 50/60 Hz  
 Power Consumption ..... 600 W  
 Power Consumption in Standby mode ..... 0.9 W  
 Dimensions ..... 420 (W) × 188 (H) × 464 (D) mm  
 Weight (without package) ..... 19.6 kg

**Furnished Parts**

FM Wire Antenna ..... 1  
 AM Loop Antenna ..... 1  
 "AA" IEC LR6 batteries ..... 4  
 Remote Control Unit ..... 1  
 Microphone for Auto Surround Sound Setup ..... 1  
 Microphone Stand for Auto Surround Sound Setup ..... 1  
 AC Power Cord ..... 2  
 Operating Instructions ..... 1

**NOTE:**

*Specifications and the design are subject to possible modifications without notice, due to improvements.*

Published by Pioneer Corporation.  
Copyright © 2002 Pioneer Corporation.  
All rights reserved.

---

**PIONEER CORPORATION** 4-1, Meguro 1-Chome, Meguro-ku, Tokyo 153-8654, Japan  
**PIONEER ELECTRONICS [USA] INC.** P.O. BOX 1540, Long Beach, California 90801-1540, U.S.A.  
**PIONEER ELECTRONICS OF CANADA, INC.** 300 Allstate Parkway, Markham, Ontario L3R 0P2, Canada  
**PIONEER EUROPE NV** Haven 1087, Keetberglaan 1, B-9120 Melsele, Belgium TEL: 03/570.05.11  
**PIONEER ELECTRONICS AUSTRALIA PTY. LTD.** 178-184 Boundary Road, Braeside, Victoria 3195, Australia, TEL: [03] 9586-6300  
**PIONEER ELECTRONICS DE MEXICO S.A. DE C.V.** San Lorenzo 1009 3er Piso Desp. 302 Col. Del Valle Mexico D.F. C.P. 03100  
TEL: 55-5688-5290

<TNGZF/02F00001>

Printed in

<ARB7263-A>



## Free Manuals Download Website

<http://myh66.com>

<http://usermanuals.us>

<http://www.somanuals.com>

<http://www.4manuals.cc>

<http://www.manual-lib.com>

<http://www.404manual.com>

<http://www.luxmanual.com>

<http://aubethermostatmanual.com>

Golf course search by state

<http://golfingnear.com>

Email search by domain

<http://emailbydomain.com>

Auto manuals search

<http://auto.somanuals.com>

TV manuals search

<http://tv.somanuals.com>