

Pioneer

FILE-TYPE COMPACT DISC PLAYER

PD-F1039

Operating Instructions



WARNING: TO PREVENT FIRE OR SHOCK HAZARD, DO NOT EXPOSE THIS APPLIANCE TO RAIN OR MOISTURE.

IMPORTANT NOTICE

The serial number for this equipment is located on the rear panel. Please write this serial number on your enclosed warranty card and keep it in a secure area. This is for your security.

IMPORTANT



The lightning flash with arrowhead symbol, within an equilateral triangle, is intended to alert the user to the presence of uninsulated "dangerous voltage" within the product's enclosure that may be of sufficient magnitude to constitute a risk of electric shock to persons.

CAUTION

**RISK OF ELECTRIC SHOCK
DO NOT OPEN**

CAUTION:

TO PREVENT THE RISK OF ELECTRIC SHOCK, DO NOT REMOVE COVER (OR BACK). NO USER-SERVICEABLE PARTS INSIDE. REFER SERVICING TO QUALIFIED SERVICE PERSONNEL.



The exclamation point within an equilateral triangle is intended to alert the user to the presence of important operating and maintenance (servicing) instructions in the literature accompanying the appliance.

IMPORTANT SAFETY INSTRUCTIONS

READ INSTRUCTIONS — All the safety and operating instructions should be read before the product is operated.

RETAIN INSTRUCTIONS — The safety and operating instructions should be retained for future reference.

HEED WARNINGS — All warnings on the product and in the operating instructions should be adhered to.

FOLLOW INSTRUCTIONS — All operating and use instructions should be followed.

CLEANING — Unplug this product from the wall outlet before cleaning. The product should be cleaned only with a polishing cloth or a soft dry cloth. Never clean with furniture wax, benzine, insecticides or other volatile liquids since they may corrode the cabinet.

ATTACHMENTS — Do not use attachments not recommended by the product manufacturer as they may cause hazards.

WATER AND MOISTURE — Do not use this product near water — for example, near a bathtub, wash bowl, kitchen sink, or laundry tub; in a wet basement; or near a swimming pool; and the like.

ACCESSORIES — Do not place this product on an unstable cart, stand, tripod, bracket, or table. The product may fall, causing serious injury to a child or adult, and serious damage to the product. Use only with a cart, stand, tripod, bracket, or table recommended by the manufacturer, or sold with the product. Any mounting of the product should follow the manufacturer's instructions, and should use a mounting accessory recommended by the manufacturer.

CART — A product and cart combination should be moved with care. Quick stops, excessive force, and uneven surfaces may cause the product and cart combination to overturn.



VENTILATION — Slots and openings in the cabinet are provided for ventilation and to ensure reliable operation of the product and to protect it from overheating, and these openings must not be blocked or covered. The openings should never be blocked by placing the product on a bed, sofa, rug, or other similar surface. This product should not be placed in a built-in installation such as a bookcase or rack unless proper ventilation is provided or the manufacturer's instructions have been adhered to.

POWER SOURCES — This product should be operated only from the type of power source indicated on the marking label. If you are not sure of the type of power supply to your home, consult your product dealer or local power company.

LOCATION — The appliance should be installed in a stable location.

NONUSE PERIODS — The power cord of the appliance should be unplugged from the outlet when left unused for a long period of time.

GROUNDING OR POLARIZATION

- If this product is equipped with a polarized alternating current line plug (a plug having one blade wider than the other), it will fit into the outlet only one way. This is a safety feature. If you are unable to insert the plug fully into the outlet, try reversing the plug. If the plug should still fail to fit, contact your electrician to replace your obsolete outlet. Do not defeat the safety purpose of the polarized plug.
- If this product is equipped with a three-wire grounding type plug, a plug having a third (grounding) pin, it will only fit into a grounding type power outlet. This is a safety feature. If you are unable to insert the plug into the outlet, contact your electrician to replace your obsolete outlet. Do not defeat the safety purpose of the grounding type plug.

POWER-CORD PROTECTION — Power-supply cords should be routed so that they are not likely to be walked on or pinched by items placed upon or against them, paying particular attention to cords at plugs, convenience receptacles, and the point where they exit from the product.

OUTDOOR ANTENNA GROUNDING — If an outside antenna or cable system is connected to the product, be sure the antenna or cable system is grounded so as to provide some protection against voltage surges and built-up static charges. Article 810 of the National Electrical Code, ANSI/NFPA 70, provides information with regard to proper grounding of the mast and supporting structure, grounding of the lead-in wire to an antenna discharge unit, size of grounding conductors, location of antenna-discharge unit, connection to grounding electrodes, and requirements for the grounding electrode. See Figure A.

LIGHTNING — For added protection for this product during a lightning storm, or when it is left unattended and unused for long periods of time, unplug it from the wall outlet and disconnect the antenna or cable system. This will prevent damage to the product due to lightning and power-line surges.

POWER LINES — An outside antenna system should not be located in the vicinity of overhead power lines or other electric light or power circuits, or where it can fall into such power lines or circuits. When installing an outside antenna system, extreme care should be taken to keep from touching such power lines or circuits as contact with them might be fatal.

OVERLOADING — Do not overload wall outlets, extension cords, or integral convenience receptacles as this can result in a risk of fire or electric shock.

OBJECT AND LIQUID ENTRY — Never push objects of any kind into this product through openings as they may touch dangerous voltage points or short-out parts that could result in a fire or electric shock. Never spill liquid of any kind on the product.

SERVICING — Do not attempt to service this product yourself as opening or removing covers may expose you to dangerous voltage or other hazards. Refer all servicing to qualified service personnel.

DAMAGE REQUIRING SERVICE — Unplug this product from the wall outlet and refer servicing to qualified service personnel under the following conditions:

- When the power-supply cord or plug is damaged.
- If liquid has been spilled, or objects have fallen into the product.
- If the product has been exposed to rain or water.
- If the product does not operate normally by following the operating instructions. Adjust only those controls that are covered by the operating instructions as an improper adjustment of other controls may result in damage and will often require extensive work by a qualified technician to restore the product to its normal operation.
- If the product has been dropped or damaged in any way.
- When the product exhibits a distinct change in performance — this indicates a need for service.

REPLACEMENT PARTS — When replacement parts are required, be sure the service technician has used replacement parts specified by the manufacturer or have the same characteristics as the original part. Unauthorized substitutions may result in fire, electric shock, or other hazards.

SAFETY CHECK — Upon completion of any service or repairs to this product, ask the service technician to perform safety checks to determine that the product is in proper operating condition.

WALL OR CEILING MOUNTING — The product should not be mounted to a wall or ceiling.

HEAT — The product should be situated away from heat sources such as radiators, heat registers, stoves, or other products (including amplifiers) that produce heat.

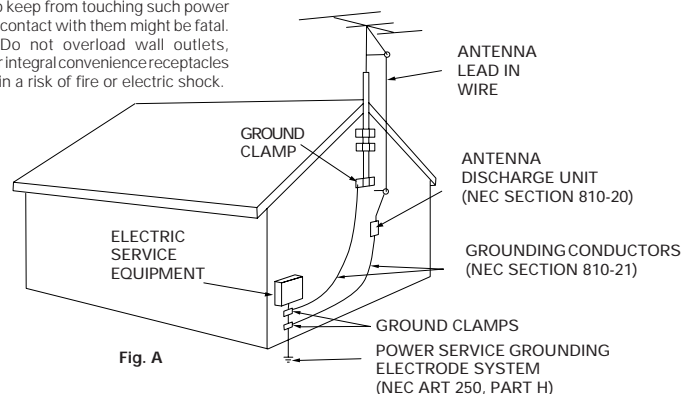

Fig. A

NEC — NATIONAL ELECTRICAL CODE

CAUTION

- Use of controls or adjustments or performance of procedures other than those specified herein may result in hazardous radiation exposure.
- The use of optical instruments with this product will increase eye hazard.

This equipment has been tested and found to comply with the limits for a Class B digital device, pursuant to Part 15 of the FCC Rules. These limits are designed to provide reasonable protection against harmful interference in a residential installation. This equipment generates, uses, and can radiate radio frequency energy and, if not installed and used in accordance with the instructions, may cause harmful interference to radio communications. However, there is no guarantee that interference will not occur in a particular installation. If this equipment does cause harmful interference to radio or television reception, which can be determined by turning the equipment off and on, the user is encouraged to try to correct the interference by one or more of the following measures:

- Reorient or relocate the receiving antenna.
- Increase the separation between the equipment and receiver.
- Connect the equipment into an outlet on a circuit different from that to which the receiver is connected.
- Consult the dealer or an experienced radio/TV technician for help.

Information to User

Alteration or modifications carried out without appropriate authorization may invalidate the user's right to operate the equipment.

[For Canadian model]

CAUTION: TO PREVENT ELECTRIC SHOCK DO NOT USE THIS (POLARIZED) PLUG WITH AN EXTENSION CORD, RECEPTACLE OR OTHER OUTLET UNLESS THE BLADES CAN BE FULLY INSERTED TO PREVENT BLADE EXPOSURE.

ATTENTION: POUR PREVENIR LES CHOCS ELECTRIQUES NE PAS UTILISER CETTE FICHE POLARISEE AVEC UN PROLONGATEUR, UNE PRISE DE COURANT OU UNE AUTRE SORTIE DE COURANT, SAUF SI LES LAMES PEUVENT ETRE INSEREES A FOND SANS EN LAISSER AUCUNE PARTIE A DECOUVERT.

CAUTION

This product satisfies FCC regulations when shielded cables and connectors are used to connect the unit to other equipment. To prevent electromagnetic interference with electric appliances such as radios and televisions, use shielded cables and connectors for connections.

[For Canadian model]

This Class B digital apparatus complies with Canadian ICES-003.

[Pour le modèle Canadien]

Cet appareil numérique de la classe B est conforme à la norme NMB-003 du Canada.

This player is for consumer use. If the player is used in a business (for example, used for a long period at a restaurant), the player will not be covered under warranty. CD video, VIDEO CD, CD graphics and CD-ROM discs can not be played with this player.

Location

Install the player in a well-ventilated location where it will not be exposed to high temperatures or humidity.

Do not install the player in a location which is exposed to direct rays of the sun, or near stoves or radiators. Excessive heat can adversely affect the cabinet and internal components. Installation of the player in a damp or dusty environment may also result in a malfunction or an accident. (Avoid installation near cookers etc., where the player may be exposed to oily smoke, steam or heat.) Do not install the player on a tottered stand nor in an unstable or inclined place.

Thank you for buying this Pioneer product.

Please read through these operating instructions so you will know how to operate your model properly. After you have finished reading the instructions, put them away in a safe place for future reference.

CONTENTS

BEFORE YOU USE THE PLAYER	4
CAUTIONS REGARDING HANDLING	5
CONNECTIONS	6
NAMES OF PARTS	8
HOW TO LOAD THE DISCS	10

BASIC OPERATIONS

To listen in order from the first track	11
To select the disc and track	11
To select a play mode	11
Playing a disc that is not loaded in the rack	12
To play a track you want to hear	12
To start playback from a specific disc	12
Opening or closing the hood during playback	12

VARIOUS OPERATIONS

To program and play only the discs you want to hear ...	13
To repeat playback	14
To store your favorite tracks	14
To find out which discs you've listened to recently	15
To playback tracks/discs at random	15
To program tracks/discs in a desired order	16
To scan quickly through tracks on a disc	18
To use the TIME/CHARA button	18
Title Input	19
Input title of CUSTOM groups	22
Correcting a title that has already been input	22
Displaying titles or artist's name	23
Finding the desired CD by the disc title or artist's name	23

TROUBLESHOOTING	24
SPECIFICATIONS	25

Condensation

When this unit is brought into a warm room from previously cold surroundings or when the room temperature rises sharply, condensation may form inside, and the unit may not be able to attain its full performance. If this occurs, allow the unit to stand for about an hour or raise the room temperature gradually.

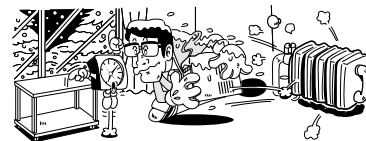



BEFORE YOU USE THE PLAYER

HERE'S WHAT YOU CAN DO!

- ❑ **301 CD giga changer for the compact 16 inch width**
The new roulette-type mechanism allows for a capacity of 301 CDs.
- ❑ **Connectable to another 301 CD player and playback 602 discs**
Another PD-1039 (301-disc CD changer) can be connected to create a 602-disc changer. Control is possible even with more CDs.
- ❑ **One-disc jump-in playback thanks to a single loader slot**
The PD-F1039 is equipped with a single loader that lets you easily play a disc that is not loaded in the rack. What's more, a priority key makes for excellent operability of the jump-in play function.
- ❑ **Compatible with recordable CDs**
As well as regular CDs, this unit can play CD-R and CD-RW discs.
- ❑ **CD Text compatibility for automatically storing and displaying disc titles**
In addition to the title input function, the PD-F1039 is also CD Text compatible. Furthermore, the use of a dot matrix FL makes it easy to manage discs.
- ❑ **Titles can be input using an IBM-compatible PC keyboard as well as with the provided remote control unit.**
- ❑ **Many handy functions for taking maximum advantage of the changer**
The PD-F1039 is equipped with three listening modes (ALL, SINGLE and CUSTOM) with 10 custom files, as well as a direct button for even greater operability. What's more, a jog dial on the main unit makes it even easier to select discs, input titles and so on.
- ❑ **Disc detection function**
When the hood is closed, the set automatically detects whether or not a disc is loaded.
- ❑ **Energy-saving design**
This unit is designed to use 1W of energy when this player is in standby mode.

CONFIRM SUPPLIED ACCESSORIES

Remote control unit x 1

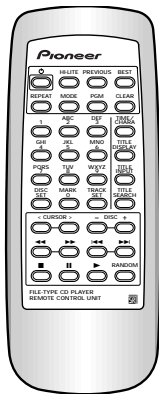

Audio cable x 1

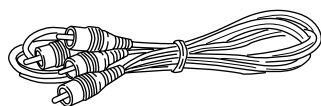

Control cable x 1



Size AA/R6 dry cell batteries x 2

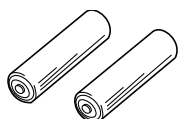

Other included items

- Warranty card
- Operating Instructions (this manual)

PUT BATTERIES INTO THE REMOTE CONTROL UNIT

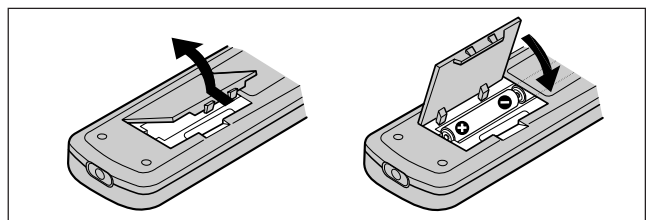

Open the lid of the battery compartment on the rear of the remote control unit, and insert the batteries, taking care to align the ⊕ and ⊖ polarities correctly.

Notes!!

- In order to prevent battery leakage, remove the batteries when not using the remote control unit for an extended period (one month or more). If leakage occurs, carefully wipe away any battery fluid inside the compartment, and replace the batteries with new ones.
- Do not allow books or other objects to rest on top of the remote control unit, since the buttons may be depressed, causing faster exhaustion of the batteries.

Incorrect use of batteries may cause leakage or rupture. Always be sure to follow these guidelines:

- A. Always insert batteries into the battery compartment correctly matching the positive ⊕ and negative ⊖ polarities, as shown by the display inside the compartment.
- B. Never mix new and used batteries.
- C. Batteries of the same size may have different voltages, depending on brand. Do not mix different brands of batteries.



CAUTIONS REGARDING HANDLING

Precautions regarding installation

- Placing and using the compact disc player for long periods on heat-generating sources such as amplifiers will affect performance. Avoid placing the player on heat-generating sources.
- Install this compact disc player as far as possible from tuners and TV sets. A compact disc player installed in close proximity to such equipment may cause noise or degradation of the picture.
- Such noise may be particularly noticeable when an indoor antenna is used. In such cases, make use of an outdoor antenna, or turn off power to the compact disc player.
- **Please place this unit on a level surface.**



Cleaning the player

To clean the PLAYER, wipe with a soft, dry cloth. For stubborn dirt, wet a soft cloth with a mild detergent solution made by diluting one part detergent to 5 or 6 parts water, wring well, then wipe off the dirt. Also use a dry cloth to wipe the surface dry. Do not use volatile liquids such as benzene and thinner which are harmful to the unit.

Storing discs

- Discs are made of the same kinds of plastic used for conventional analog audio records. Be careful not to allow discs to warp; always store discs in their cases vertically, avoiding locations with high heat or humidity, or extremely low temperatures. Avoid leaving discs in cars, since the seat of a car in direct sunlight can become unbelievably hot.
- Always read and abide by the precautionary notes listed on disc labels.

CD lens cleaner

The player's pickup lens should not become dirty in normal use, but if for some reason it should malfunction due to soiling, consult your nearest PIONEER authorized service center. Lens cleaners for CD players are commercially available, but special care should be exercised in their use since some may cause damage to the lens.

Cleaning and handling compact discs

- The presence of fingerprints or smudges on the surface of the disc will not directly affect the recorded signals, but depending on the degree of contamination, the brightness of the light reflected from the signal surfaces may be reduced, causing degradation of sound quality. Always keep your discs clean by wiping them gently with a soft cloth from the inner edge toward the outer periphery.

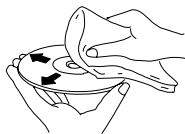

- If a disc becomes very dirty, dip a soft cloth in water, and after wringing it out well, wipe the dirt away gently, and then remove any water drops with another soft, dry cloth.
- Do not use record cleaning sprays or anti-static agents on discs. Also, never clean discs with benzene, thinner, or other volatile solvents, since damage to the disc surface may result.



With this player, use discs which display these marks shown below. (Optical audio digital discs.)



Playing CD-R and CD-RW discs in this CD changer

- This unit can play CD-R and CD-RW discs. However, it may not be possible to play unfinalized discs* which have very little recording time left on them.

* What is finalization?

Finalizing a CD-R or CD-RW disc means making a recorded disc playable on an ordinary CD player. In the case of CD-RWs, the player must be specifically compatible with CD-RW discs for it to play them.

- When holding discs, do not touch their signal surfaces. Hold by the edges, or by one edge and the center hole.
- Do not affix gummed labels or tape to the label surfaces. Also, do not scratch or damage the label.
- Discs rotate at high speed inside the player. Do not use damaged (cracked or warped) discs.
- Do not play a CD with a special shape (having other shape than a circular disc, such as a heart shaped disc). Otherwise malfunction may occur.
- The CD accessories (stabilizer protection sheet, protection ring, etc.) which are marketed for improving the sound quality or protecting discs as well as the disc cleaner should not be used with this system because they may cause malfunction.

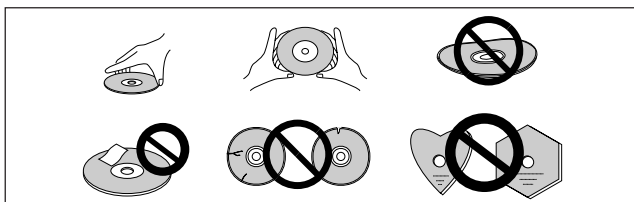

Re-transporting

When transporting this unit in the future, remove all discs from the rack. Turn off the STANDBY/ON switch, wait for "OFF" to go out from the display. Then unplug the power cord.

Precautions concerning use of optical fiber cables

- Fully insert the optical fiber cable plugs all the way into the jacks.
- Be careful not to fold or crimp the cable. When coiling an optical fiber cable for storage, make sure the diameter of the coil is 15 cm (5-15/16 in.) or larger.
- Use an optical fiber cable with a length of 3 m (10 ft.) or less.
- Protect the optical fiber cable plugs from scratches and dust.
- When the unit is not connected using an optical fiber cable, be sure to keep the protective dust cap plugged into the optical digital output jack at all times.

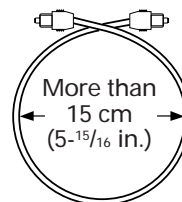



CONNECTIONS

Before making or changing the connections, switch off the power and disconnect the power cord from the AC outlet.

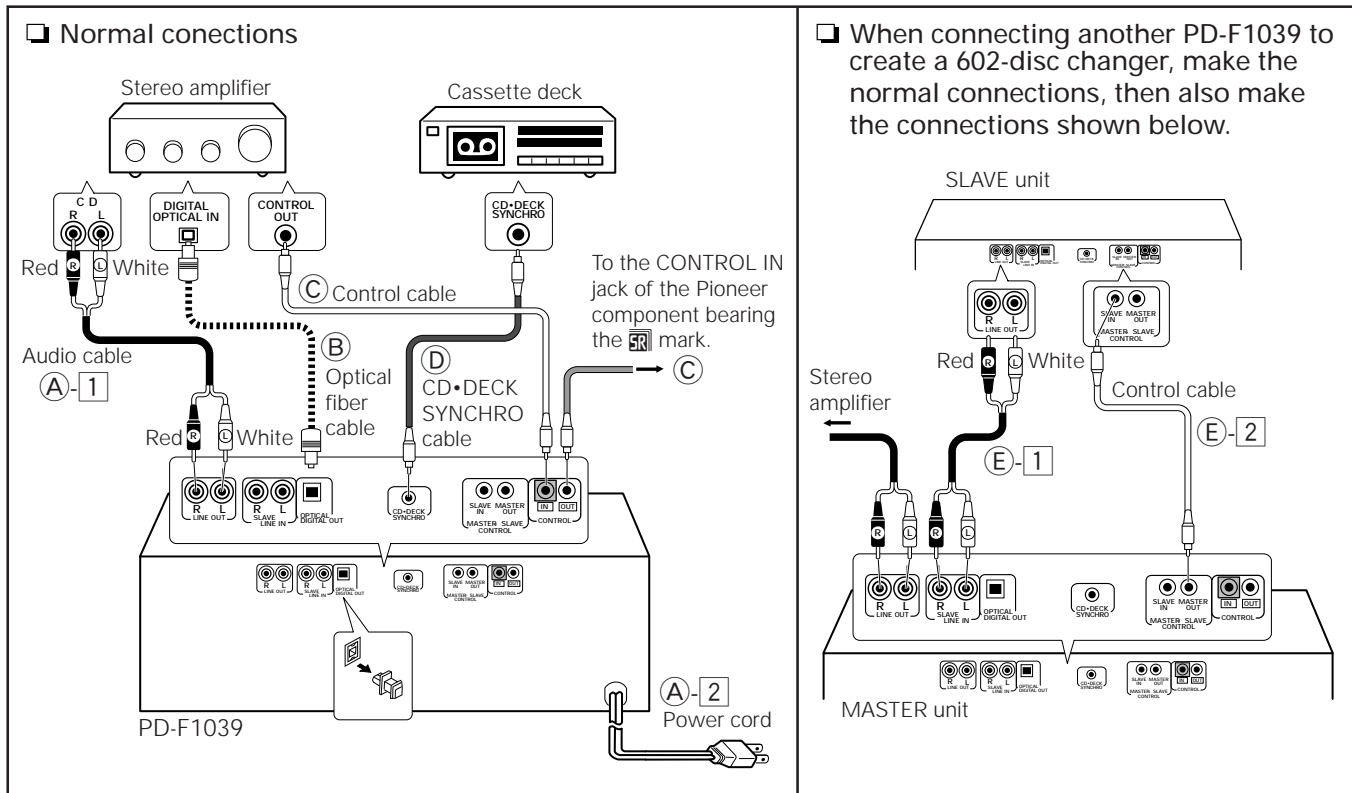

A Making connections

- 1 Connect the **LINE OUT** jacks of this unit to the input jacks (CD or AUX) of the amplifier. Make sure that the white plugs are connected to the left (L) jacks and the red plugs to the right (R) jacks.
 - Be sure not to connect this unit to the amplifier's **PHONO** jacks, as sound will be distorted and normal playback will not be possible.
- 2 Connect the power cord to a household AC wall outlet.
 - Make sure plugs are inserted fully into the wall outlet.

Note!!

If you connect the power cord to a "SWITCHED" AC outlet on an amplifier, you will not be able to use this unit's memory function.

B Connecting the OPTICAL FIBER CABLE

CD can be played using the digital output. This unit can be connected to an amplifier equipped with an optical digital jack.

1. Remove the protective dust cap from this unit's **OPTICAL DIGITAL OUT** jack.
2. Use an optical fiber cable to connect the **OPTICAL DIGITAL OUT** jack of this unit to the optical input jack of the amplifier.
 - Align the plug of the optical fiber cable with the optical digital jack and fully insert the plug to make a secure connection.
 Use a separately sold optical fiber cable for the optical digital jack connections.

C System remote control with a Pioneer stereo amplifier that has the mark

When a Pioneer stereo amplifier bearing the  mark is used, connect the **CONTROL IN** jack on the rear panel of the CD player to the **CONTROL OUT** jack of the amplifier. This will enable the CD player to be controlled using the remote control unit supplied with the stereo amplifier. If you do not plan to use this feature, it is not necessary to connect the **CONTROL IN/OUT** jacks.

When connecting another PD-F1039 to create a 602-disc changer, make the normal connections, then also make the connections shown below.

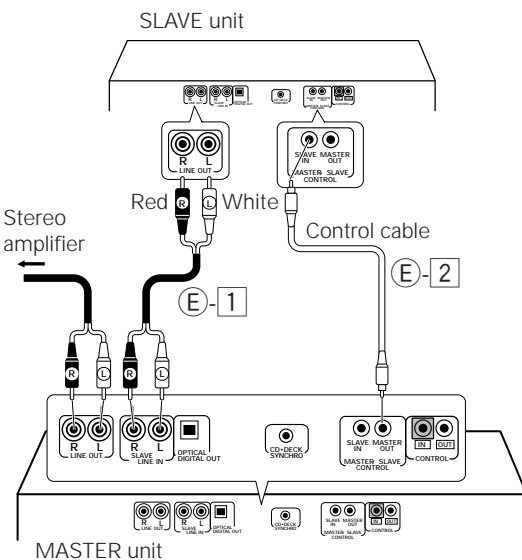

- The remote control unit supplied with the amplifier can be used to control Play, Stop, Pause, Track/Disc Search and Disc Change operations.
- For instructions regarding connections and operation, refer to the operating instructions provided with your stereo amplifier.

Notes!!

- When a control cable is connected to the player's **CONTROL IN** jack, direct control of the player with the remote control unit is not possible. Operate the player with the remote control unit by aiming it at the amplifier.
- Be sure to connect both of the control cable's plugs securely to the **CONTROL IN** and **CONTROL OUT** jacks. Do not connect only one end of the cable.
- Be sure to turn off the power of the amplifier before connecting the power cord and output cable.
- When only the digital output is connected, the remote sensor of the amplifier does not function. To operate it, connect the output cable to the stereo amplifier as well as connecting the digital output.

D CD-Deck synchro function

If you have a Pioneer cassette deck provided with the CD-Deck synchro function, connect the **CD-DECK SYNCHRO** jacks of the CD player and cassette deck. With this function, synchro recording can be carried out between the player and deck.

- For details on connections and operation, refer to the operating instructions supplied with the cassette deck.
- The **CD-DECK SYNCHRO** cable is not supplied with the CD player.
- When CD-Deck synchro recording is carried out on several discs, use the program playback function. (Refer to page 16 for details of program playback.)

Note!!

In order to enable the **CD-DECK SYNCHRO** recording function, the output cable must be connected to the stereo amplifier.



E Connecting another PD-F1039

With these connections, the audio signals are output from one PD-F1039 (MASTER unit) to the other PD-F1039 (SLAVE unit), and the CDs loaded in the SLAVE unit are numbered from 301 to 600, so the whole can be operated as a single 602-disc CD changer. Operation is possible from a single remote control unit.

- 1 Use an audio cable to connect the SLAVE LINE IN jack on the MASTER unit (first PD-F1039) to the LINE OUT jack on the SLAVE unit (second PD-F1039).
- 2 Use a control cable to connect the MASTER OUT jack on the MASTER unit (first PD-F1039) to the SLAVE IN jack on the SLAVE unit (second PD-F1039).

Notes:

- Operation of the single loader function on the SLAVE unit can not be done with the MASTER unit or the remote control unit. When operating the SLAVE unit's single loader function, please use the SLAVE unit.
- When connecting 2 PD-F1039 units, connect system remote control and CD•Deck synchro to the MASTER unit only.
- When using 2 connected PD-F1039 units, make sure that the power of both units is ON.
- When not connecting a SLAVE unit, be sure to unplug the cable.

Notes when 2 PD-F1039 units are connected

For usage

- Always turn the power of both units on.
- Make Optical digital out connection to both the master unit and slave unit.
- Make CONTROL IN/OUT jack and CD•DECK SYNCHRO connection to the MASTER unit.

For the remote control unit

- SLAVE unit single loader slot operation can not be done with the remote control unit. Operate using the SLAVE unit.
- The remote control's DISC (-/+), ◀◀, ▶▶, ◀◀▶▶, ■, ■■, ▶ buttons will function for the corresponding unit that is operating.

For operation

- Operation of a program spanning 2 connected units is not possible.
- When 2 units are connected, disc numbers will be from 1 to 300 on the MASTER unit and from 301 to 600 on the SLAVE unit. Custom file numbers will be from 1 to 10 on the MASTER unit and from 11 to 20 on the SLAVE unit.

Relay playback (Playback continues on the SLAVE unit after playback has finished on the MASTER unit)

	ALL play	SINGLE play	CUSTOM play	RANDOM play	PROGRAM play	BEST play	PREVIOUS play	HI-LITE scan	ALL REPEAT
Relay playback	○	×	×	○	×	○	○	○	×

Connecting a keyboard

The connection terminal of this unit is designed for a U.S.-English Keyboard. Take care when using keyboards from other regions as the keys are different.

- The keyboard connection jack is a six-pin mini DIN-type. When purchasing a keyboard, make sure that it accepts this type of connector.

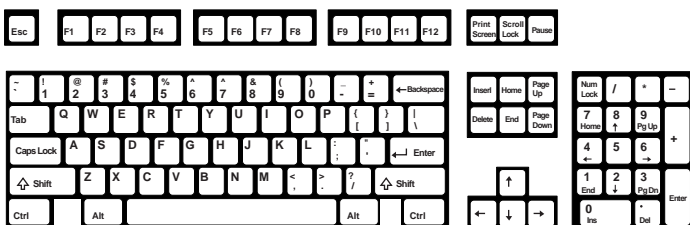

<U. S. -English keyboard>



DIN-Connector

- 1 +KBD DATA
- 2 Reserved
- 3 Ground
- 4 +5.0 Vdc
- 5 +KBD CLK
- 6 Reserved
- Shield Frame Ground



NAMES OF PARTS

FRONT PANEL

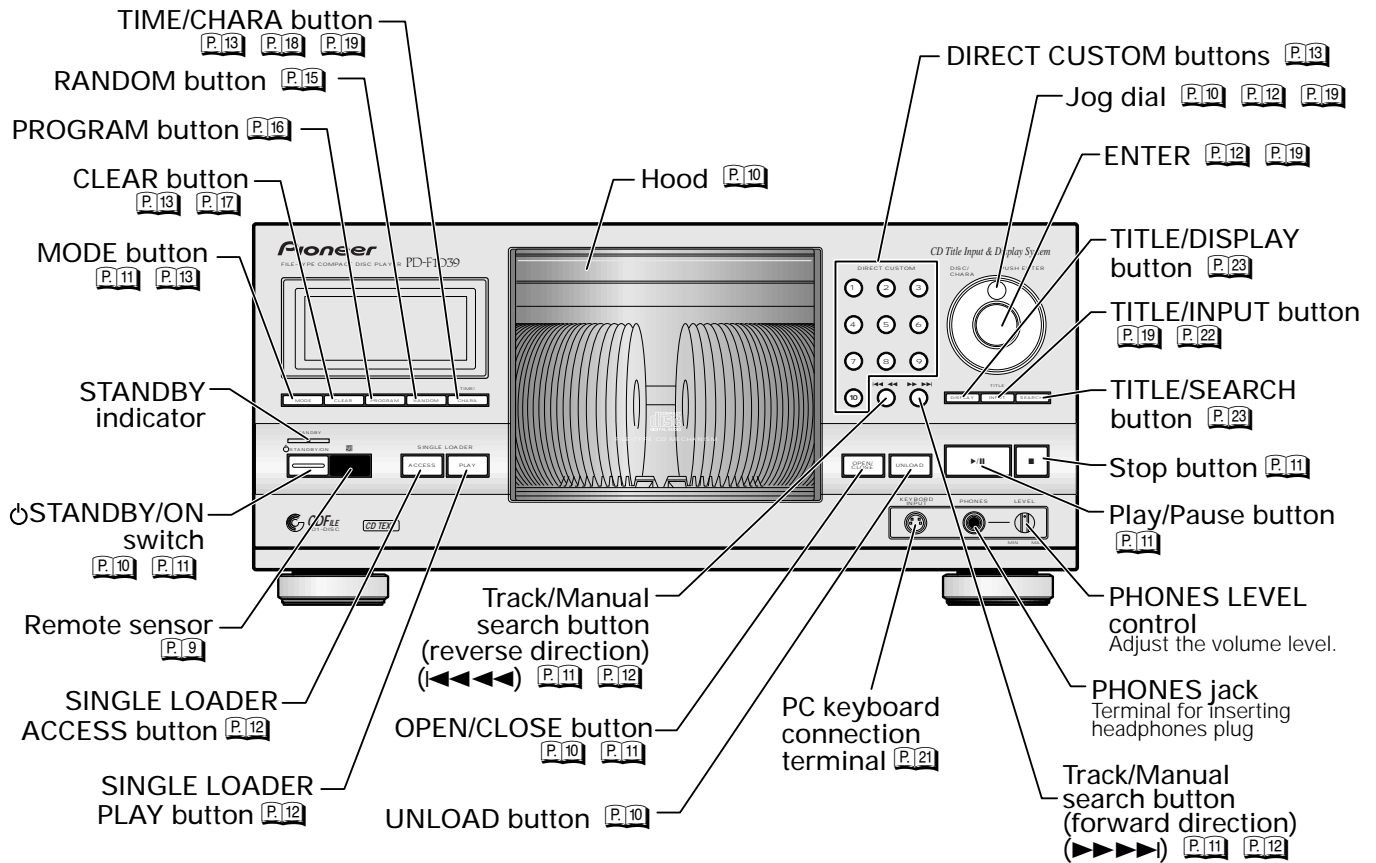

DISPLAY

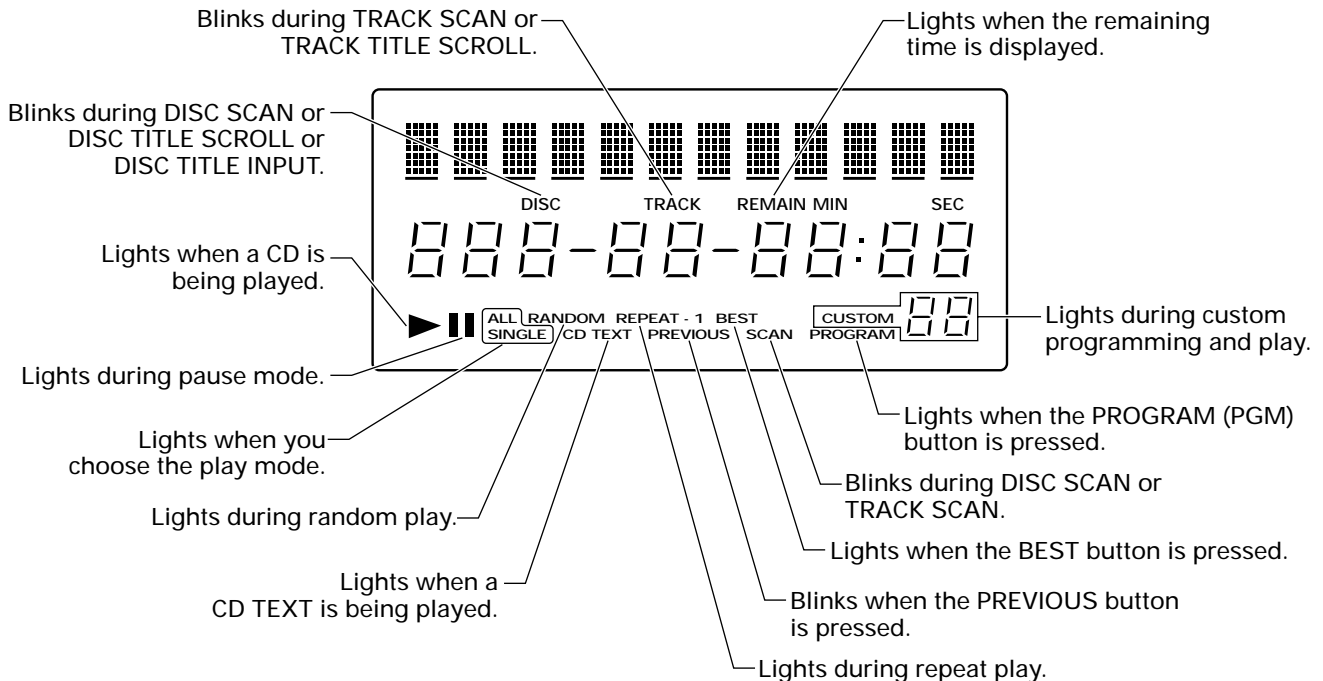



NAMES OF PARTS

REMOTE CONTROL UNIT

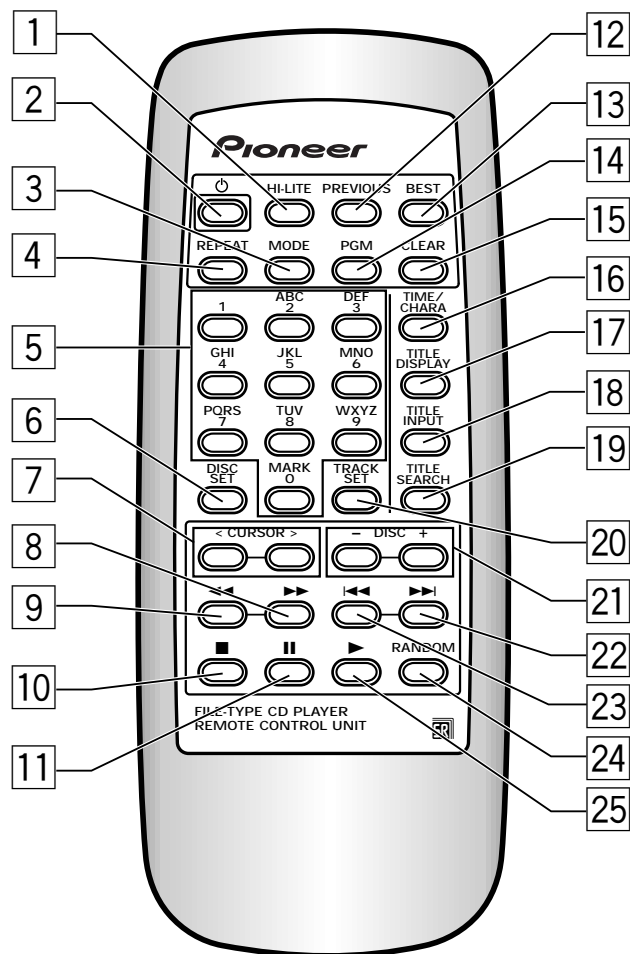

- 1 HI-LITE button [P.18](#)
- 2 STANDBY/ON ϕ button [P.10](#) [P.11](#)
- 3 MODE button [P.11](#) [P.13](#)
- 4 REPEAT button [P.14](#)
- 5 Digit buttons [P.11](#) [P.20](#)
- 6 DISC SET button [P.11](#) [P.16](#)
- 7 CURSOR buttons [P.22](#)
- 8 Fast forward (\gg) button [P.11](#)
- 9 Fast reverse (\ll) button [P.11](#)
- 10 Stop (\blacksquare) button [P.11](#) [P.15](#)
- 11 Pause ($\|\|$) button [P.11](#)
- 12 PREVIOUS button [P.15](#)
- 13 BEST button [P.14](#)
- 14 PGM button [P.16](#)
- 15 CLEAR button [P.13](#) [P.17](#)
- 16 TIME/CHARA button [P.13](#) [P.18](#) [P.19](#)
- 17 TITLE/DISPLAY button [P.23](#)
- 18 TITLE/INPUT button [P.20](#) [P.22](#)
- 19 TITLE/SEARCH button [P.23](#)
- 20 TRACK SET button [P.11](#) [P.16](#)
- 21 DISC (-/+ buttons) [P.13](#) [P.23](#)
- 22 Skip (forward) (\gg) button [P.11](#) [P.12](#)
- 23 Skip (reverse) (\ll) button [P.11](#) [P.12](#)
- 24 RANDOM button [P.15](#)
- 25 Play (\blacktriangleright) button [P.11](#)

BEFORE
OPERATING

REMOTE CONTROL OPERATIONS

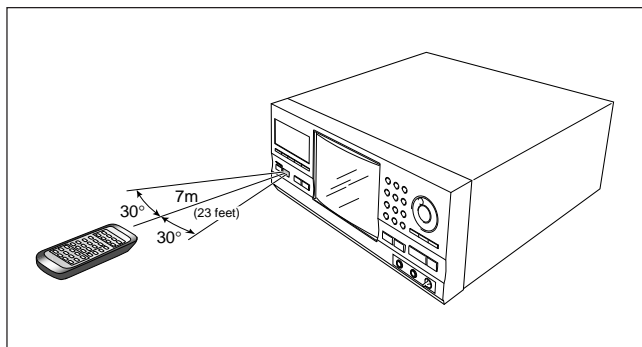

When operating the remote control unit, point the unit's infrared signal transmitter at the remote control receiver (Remote Sensor) on the front panel of the player. The remote control unit can be used within a range of about 7 meters (23 feet) from the remote sensor, and within angles of up to about 30 degrees.

Notes!!

- If the remote control sensor window is in a position where it receives strong light such as sunlight or fluorescent light, control may not be possible.
- When another PD-F1039 (SLAVE) is connected to create a 602-disc changer, only the remote sensor on the first PD-F1039 (MASTER) will work.



HOW TO LOAD THE DISCS (Be sure to read this before operation)

Loading discs into the rack

- You can load up to **300 discs** in the rack. The numbers marked on the rack are used as the disc numbers. These are marked in a clockwise order from **1 to 300**.
- The following procedure describes how to load discs from disc No. 1.

1

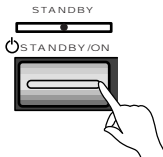

Press **STANDBY/ON**.

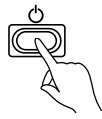

2

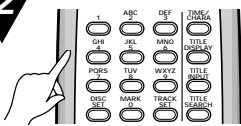

Ensure that the disc No. shown on the display is "1".

If disc number "1" is not displayed, press digit button 1.

(Carry out step 3 within 5 seconds.)

3



Press **UNLOAD**.

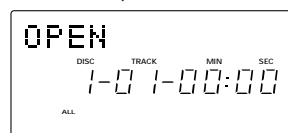
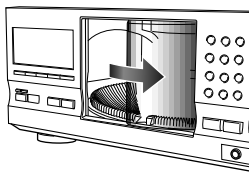

The hood will open. When **UNLOAD** is pressed, the hood opens to the disc corresponding to the disc No. displayed on the front of the unit.

4

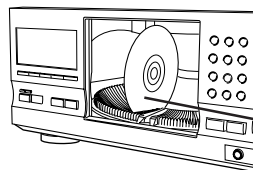

Load the disc into the rack with the label side (printed surface) facing to the right.

Label side faces right.
(Side to be played faces left.)

Note!!

- Inserting more than one disc into the slot will damage the discs and cause the unit to malfunction.

5

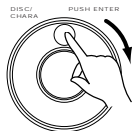

Turn the jog dial clockwise to rotate the rack.

When the jog dial is turned clockwise, the rack turns in the direction in which the disc number increases (1, 2, 3 ...). When turned counterclockwise, the rack turns in the opposite direction.

6

Load other discs into the rack by repeating steps 4 and 5 for each of them.

7



Press **OPEN/CLOSE**.

The hood will close. When the hood closes, the rack is revolved once for disc detection (disc loaded/not loaded detection function).

Tip:

Difference between **OPEN/CLOSE** and **UNLOAD**

OPEN/CLOSE: The hood is simply opened or closed.

UNLOAD: The slot corresponding to the disc No. being displayed rotates to the center position then the hood is opened.

Notes!!

- Do not attempt to open the hood with your hand.
- Be careful not to pinch your fingers when opening and closing the hood.
- If **PLAY** operation (**PLAY**, **BEST**, **Hi-LITE**, **PREVIOUS**) is carried out before disc detection finishes, **PLAY** operation will proceed to without detection. In this case, detection will operate after **PLAY** is finished. Detection may not function properly depending on the color or shape etc., of the disc.

WARNING:

Do not put your hand or any other object inside the rack, otherwise injury or part damage may result.

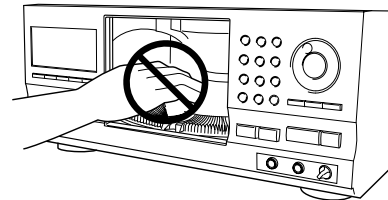

- While changing or inserting discs, be careful not to press any buttons on the main unit or the remote control. The rack may move suddenly, and then your fingers may be caught between discs and the side of door.
- When changing or inserting discs, make sure the rack is stopped. Do not attempt to put a disc in when the rack is moving.
- Do not put anything other than CDs inside the rack.
- Load only one disc into each disc slot.
- Do not apply force to the rack. This can cause a malfunction.
- 8-cm (3-in.) discs cannot be played as they are. First attach the 8-cm (3-in.) disc adapter to each 8-cm (3-in.) disc and load them together in the player.
- Never start playback by placing the 8-cm (3-in.) disc adapter alone, without attaching it to a disc.
- The unit will not operate if the hood is opened during playback. Be sure to close the hood before attempting any operation.
- To load or remove a disc in or from the slot which is seen through the hood, press **OPEN/CLOSE**. The hood is opened, "HOLD" is displayed and the disc can be loaded in or ejected from the slot seen through the hood. Even while "HOLD" is being displayed, the rack can be rotated by pressing **DISC (-/+)**.

To remove the discs...

1 Press **UNLOAD**.

2 Select the number of the disc you want to unload by turning the jog dial or pressing **DISC (-/+)** on the remote control unit.

- The rack rotates until the selected disc comes to the front of the unit.

3 Remove from the rack.

4 Press **OPEN/CLOSE**.

- The hood will close.



BASIC OPERATIONS

- You can also use the remote control.

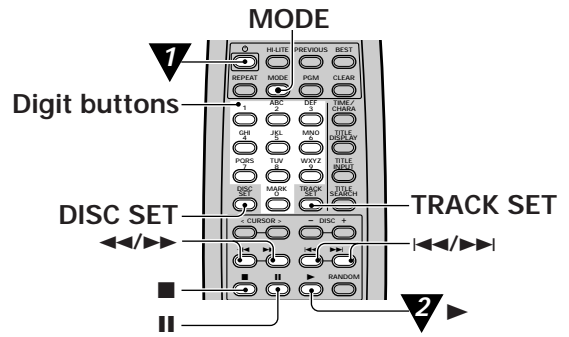
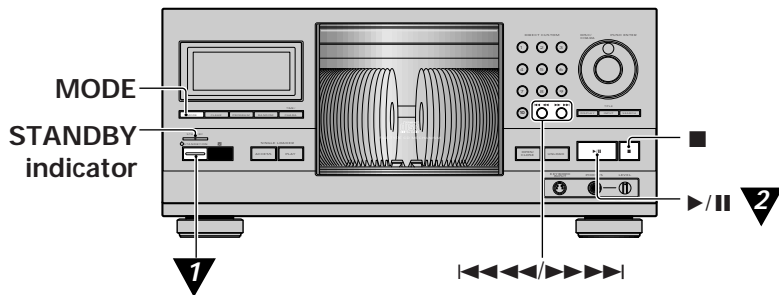

To listen in order from the first track

1

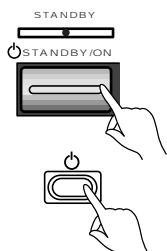

Press **STANDBY/ON**.

To turn the power off ...
Press **STANDBY/ON** again.

2

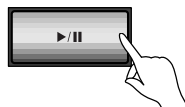

Press **▶/||** (or **▶**).

The tracks are played in order starting from the first track on the disc with the lowest disc No.

- If you choose a play mode beforehand, the tracks/discs are played back according to the respective play mode.

Tips:

- If you play a CD TEXT, the disc titles can be entered automatically in the memory. During the playback of a disc, the title of the disc and that of the track being played are shown on the display.
- During CD TEXT disc playback, the display can be changed by pressing **TITLE/DISPLAY**.

To stop play



Press **■**.

To pause play



Press **▶/||** (or **||**).

To start playback again, press **▶/||**.

To skip to another track



Tap **◀◀◀/▶▶▶** (or **◀/▶**) on the remote control unit).

To fast forward/reverse.

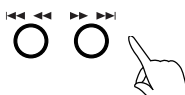

Hold-down **◀◀◀/▶▶▶** (or **◀/▶**) on the remote control unit).

To select the disc and track

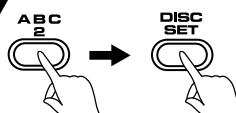

Use the digit buttons to select the disc, then press **DISC SET**.

When two PD-F1039 units are connected, the MASTER unit will be set up DISC 1 to 300 and the SLAVE unit will be set up for DISC 301 to 600.

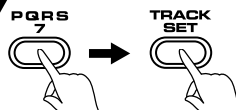

Use the digit buttons to select the track, and press **TRACK SET**.

To select a play mode

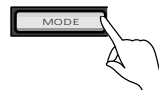

Press **MODE** during play or stop mode.

Press a few times to choose the mode you desire.
Playback occurs according to the chosen mode.

- ALL** :All discs are played back.
- SINGLE** :One disc is played back.
- CUSTOM** :Only discs stored in the CUSTOM file are played back (1 to 10) (see pages 13 to create a custom file).

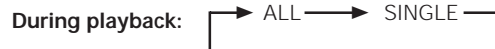

- When you select **SINGLE** during playback, only the current disc will be played.
- If you press **MODE** during program mode, the program contents will be erased.

Notes!!

- When you turn the power ON, playback starts according to the last selected play mode.
- If you did not select a play mode, playback starts in **ALL**.
- SINGLE** is selected automatically when playing the disc loaded in the Single Loader slot.

<Last disc memory>

When you press **■** or turn the power OFF, the unit memorizes the disc that was being played. The next time you press **▶/||**, playback will start from that same disc. (This feature is available except in the PROGRAM play, BEST play, PREVIOUS scan, HI-LITE scan and RANDOM play modes.)



BASIC OPERATIONS

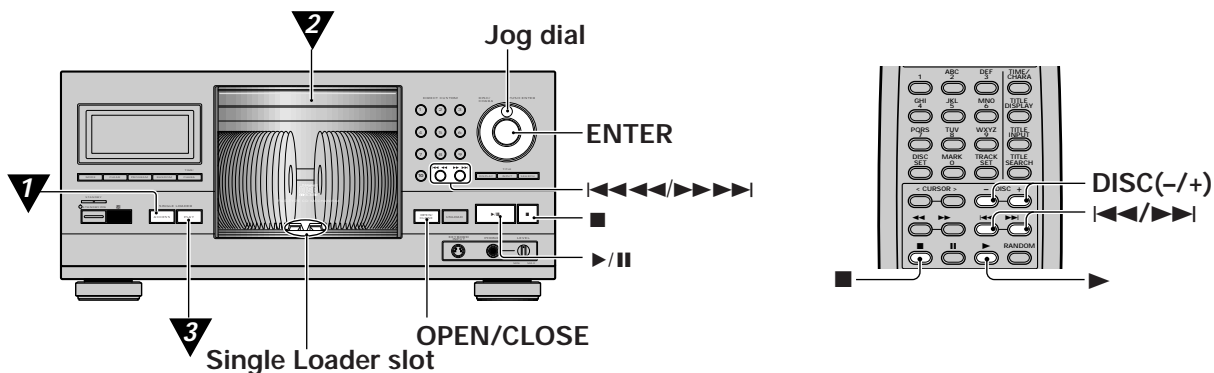

Playing a disc that is not loaded in the rack

Use the single loader slot to play discs that are not loaded in the rack.

1

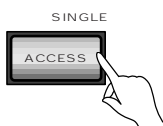

Press **SINGLE LOADER ACCESS**.

The hood will open with the single loader slot located in the front of the unit.

2

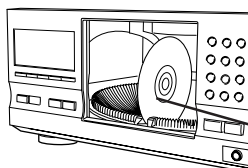

Loading the disc into the Single Loader slot with the label side (printed surface) facing to the right.

Label side faces right
(Side to be played faces left)

3

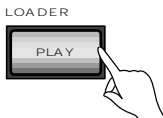

Press **SINGLE LOADER PLAY**.

The play mode is set to SINGLE.

Tips:

- The disc in the single loader slot can also be selected with the **jog dial**. Use the **jog dial** to select the spot after disc number 300 and before disc number 0 (where "P0" is displayed).
- If a disc has been loaded in the Single Loader slot, pressing **SINGLE LOADER PLAY** allows you to play it anytime, even during playback of a disc stored in the rack.
- To play the disc in the Single Loader slot using the remote control unit, press "0" and **DISC**.
- When another PD-F1039 is connected to create a 602-disc changer, the CDs loaded in the SLAVE unit (second PD-F1039) are numbered from 301 to 600. When using the SLAVE unit's single loader slot, operate using the buttons on the SLAVE unit itself.

To play a track you want to hear

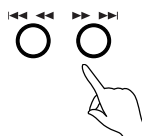

Press **DISC (-/+)** during play or pause to choose the track number you desire (or press **DISC (-/+)** on the remote control). During pause, press **PAUSE** after choosing the track.

To start playback from a specific disc

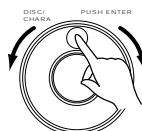

In the player pause, turn the jog dial to select the disc number. During pause, press **PAUSE** or **ENTER** (▶ on the remote control unit) after choosing the disc.

(To perform this operation from the remote control unit, use the **DISC (-/+)** buttons to select the disc number.)

- Playback starts from the first track of the chosen disc.

Opening or closing the hood during playback

To open the hood during playback



Press the **OPEN/CLOSE** button and hold it in for about 2 seconds.

- "HOLD" is displayed after opening the hood. In this case, the rack does not rotate.
- When the playback of the current disc has completed, the unit enters stop mode. The next disc is played after the hood has been closed.



To close the hood, press **OPEN/CLOSE** again.

Note!!

If the hood is opened during play, **UNLOAD** and **SINGLE LOADER ACCESS** function are defeated.



VARIOUS OPERATIONS

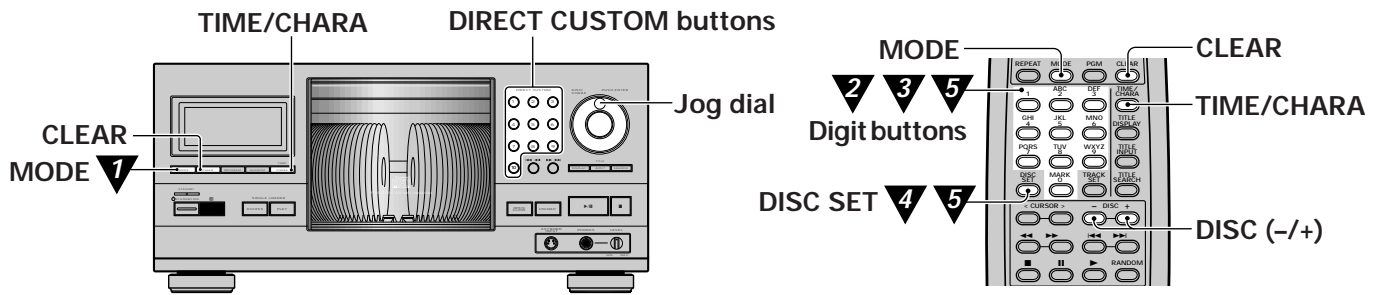

To program and play only the discs you want to hear (CUSTOM play)

This unit lets you program up to 300 of your favorite discs. For example, you can store all the discs of your favorite artist, or some other group of personal selections, and play only those discs. You can even add other discs to the custom later on. Also, there are 10 programmable custom files in which you can program any discs you like.

Operation example : Programming discs 3 and 12 in custom file 5

1

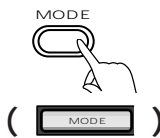

In the stop mode, press the **MODE** button several times to set the custom mode.

2

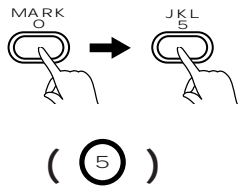

Select the custom number with the remote control unit's digit buttons.



- If some disc number appears, press **CLEAR**.
- To perform this operation on the main unit, Press direct custom button 5.

3

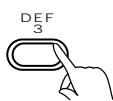

Select the disc number with the remote control unit's digit buttons.

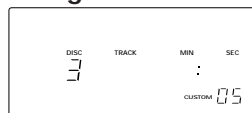

- The disc number can also be selected with **DISC (-/+)** or the main unit's jog dial. In this case, because custom registration will function after approx. 2 seconds, step 4 is not necessary.

4



Press **DISC SET**.

5

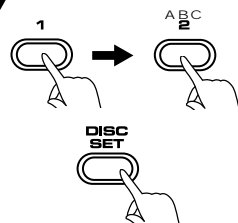

Repeat steps 3 and 4 to store other discs.

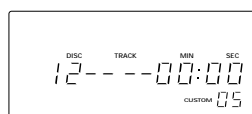

To start playback

DIRECT CUSTOM

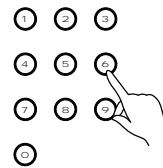

Press **DIRECT CUSTOM** buttons.

Playback starts from the lowest disc No.

Tips:

- Pressing the direct custom buttons during playback will carry out custom registration of that disc.

Checking the numbers of the stored discs.

Remote control unit operation.

Press **TIME/CHARA** repeatedly (3 times) during stop mode so that the display changes as shown below. Press **DISC(-/+)**. Each time you press **DISC(-/+)**, a disc number stored in the CUSTOM file is displayed. When all the disc numbers have been displayed, the disc number changes to a blank. (To perform this operation on the main unit, turn the jog dial clockwise.)

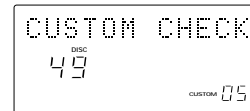

Pressing the front panel's CLEAR button during the custom mode will cancel the displayed disc number from the custom file.

- When the **jog dial** is used during custom playback, only the discs stored in the custom file can be selected.
- If you use the **digit** buttons and **DISC** during CUSTOM playback to choose a disc not stored in the CUSTOM file, "NO DISC" will be displayed for approximately 3 seconds.
- When a disc appointed to the CUSTOM file is not loaded in the rack, "NO DISC" is displayed for approximately 3 seconds, the disc is erased from memory, and CUSTOM searches for the next disc.
- The discs stored in the CUSTOM file will not be erased when you turn off the power.
- When another PD-F1039 is connected to create a 602-disc changer, 20 custom files can be programmed. Note however that only discs loaded in the first PD-F1039 can be programmed in custom files 1 to 10, and only discs loaded in the second PD-F1039 can be programmed in custom files 11 to 20.

(Memory Back-Up Function)

Memorized data will be stored in memory for approx. 1 month even if the power cord is unplugged. However, this period may be shortened somewhat, depending on the amount of memory used.



VARIOUS OPERATIONS

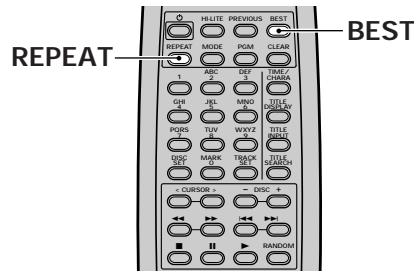

To repeat playback (REPEAT play)

The operation is available only from the remote control unit.



Press the **REPEAT** button during playback. Each time you press the button, the repeat mode changes as follows.



(One track repeat)

Repeats the current or a selected track during play operations other than HI-LITE scan and PREVIOUS scan.

(ALL repeat)

Repeats in one of the following 3 ways according to the play mode.

ALL : Repeats all the tracks on all the discs (1 - 300).

SINGLE : Repeats all the tracks on the selected disc.

CUSTOM : All of the discs classified under one of the 10 CUSTOM banks are played repeatedly.

(OFF)

Cancels repeat play and returns the unit to normal play mode.

- To stop repeat playback, press ■.
- During ALL repeat mode, if the ALL, SINGLE or CUSTOM play mode is not displayed, the currently playing program mode (i.e. PROGRAM play, BEST play, PREVIOUS scan or HI-LITE scan) will be repeated.

To store your favorite tracks (BEST play)

To use the one-touch memory, just press the **BEST** button while playing a track you like. You can store up to 50 tracks.

- The operation is available only from the remote control unit.
- These operations can not be performed on the CD inserted into the SINGLE LOADER SLOT.



Press **BEST** while playing a track you like.

The BEST indicator blinks and the disc and track number are stored in memory.



Blink

<To listen to the memorized tracks>



Press **BEST** during stop mode.

The BEST indicator lights and playback starts from the most recently memorized track.

- If you press **CLEAR** during Best playback, the current track is erased and the next track starts to play.
- You cannot memorize a track twice by pressing **BEST** during Best playback.
- If you press **BEST** to memorize a track when 20 tracks are already memorized, the oldest track is erased from memory and the new track is memorized.
- The memorized contents are stored, even when the power is turned off.

(Memory Back-Up Function)

Memorized data will be stored in memory for approx. 1 month even if the power cord is unplugged. However, this period may be shortened somewhat, depending on the amount of memory used.



VARIOUS OPERATIONS

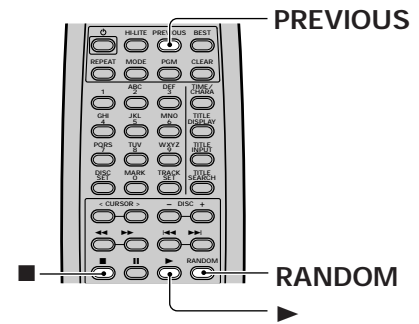
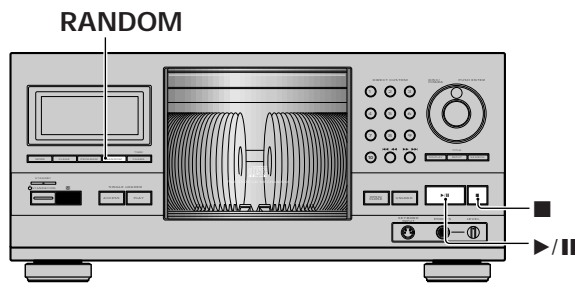

To find out which discs you've listened to recently (PREVIOUS scan)

- This function scans the discs in reverse order, starting from the last disc you played.
- It can remember up to 20 discs. If the total number of discs exceeds 20, the oldest disc will be erased to make room for the new disc.
- The operation is available only from the remote control unit.
- These operations can not be performed on the CD inserted into the SINGLE LOADER SLOT.

Example: If you played discs 1, 2, 9, 12 and 13 in order.

PREVIOUS



Press the PREVIOUS button.

The unit plays a 10 second portion located one minute into the first track of each disc, starting from the last disc you played: 13, 12, 9, 2, 1.

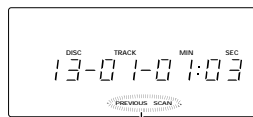

Blink

Press ► (►/II) when you reach the disc you want to hear.

Previous disc scan is canceled and normal play resumes.



- To cancel the scanning, press ■.
- Discs played during random, program, HI-LITE scan, Best and Single Loader playback are not included in the PREVIOUS scan.
- If the first track is less than 1 minute long, the first 10 seconds of the track the beginning will be played. If the first track is less than 10 seconds long, the entire track will be played.

(Memory Back-Up Function)

Memorized data will be stored in memory for approx. 1 month even if the power cord is unplugged. However, this period may be shortened somewhat, depending on the amount of memory used.

To playback tracks/discs at random (RANDOM play)

RANDOM selects tracks at random from the disc(s) in the current play mode and plays each track once. The selected play mode stops after its contents are played back. (Refer to chart below.)

Play mode selected	Play contents
ALL	Plays all tracks in all discs in a random order.
SINGLE	Plays all the tracks from a single disc at random.
CUSTOM	Plays all tracks in the discs stored in the CUSTOM file in a random order.

RANDOM



Press RANDOM during either play or stop mode.

The RANDOM indicator lights up and random play according to the current play mode starts.



To stop random play, press ■.

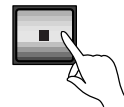

Notes!!

- Random play cannot be activated during the program mode. (If you press **RANDOM** during program play or best play, the program contents will be erased and the unit will start to play tracks at random from all the discs.)
- If you press **REPEAT** during random play, the contents of the random mode are repeated. (RANDOM REPEAT)
- If you press **MODE** during random play, random play is switched to the ALL or SINGLE play.
- If all discs contain no more than 25 tracks, random play can play every track in the discs once.
If any of the discs contain more than 25 tracks, random play plays the same number of tracks as the total number of tracks in the discs, but the tracks with track number 26 or more are not always played once.
- If disc detection has not finished, random play will begin after it has detection has finished.
- When the all random mode is set while another PD-F1039 is connected to create a 602-disc changer, the discs on the first PD-F1039 are first played in random order, then the discs on the second PD-F1039 are played in random order.



VARIOUS OPERATIONS

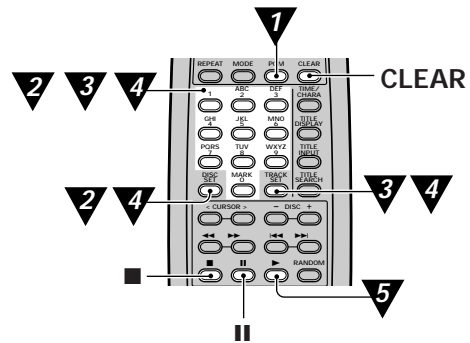
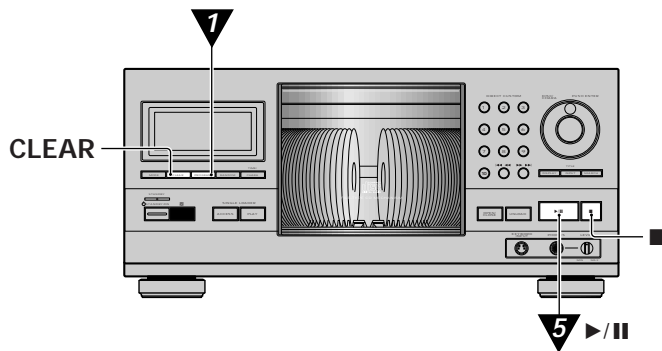

To program tracks/discs in a desired order (PROGRAM play)

- The remote control is the most convenient way to perform these operations.
- You can program up to 36 steps.
- The same operation is possible by pressing the button indicated between parentheses.

Operation example : Programming disc 2, track 7 as step 1, and disc 5, track 3 as step 2.

1

Press PGM during stop mode.
(To perform this operation on the main unit, press the **PROGRAM**.)

2

Use the digit buttons to select the disc, then press DISC SET.
(Use **DISC(-/+)** or **Jog dial** to select the disc number, press **PGM**.)

The **PROGRAM** indicator starts to blink.

3

Use the digit buttons to select the track, and press TRACK SET.
(Use **◀◀◀/▶▶▶▶▶** to select the disc number, press **PGM**.)

4

Repeat steps 2 and 3 to program additional discs and tracks.
Once the track times have been added, the **PGM** indicator stops blinking and the following display appears (Total Time).

5

Press ▶.
The program play starts from the track that was programmed first.

The following operations can only be performed during normal play, HI-LITE scan or PREVIOUS scan

<Programming tracks during normal play> (Direct program)

1. Press **PROGRAM**.
 - Program mode is activated.
2. Press **PROGRAM** during playback.
 - The current track is programmed.

<Programming during normal playback> (Preprogramming)

You can program during normal playback.

(⇒ Operation example 1 2 3 4)

- The player changes to program play when the current track finishes playing back.
- To change to program mode directly, press ▶.



The following operations can only be performed during stop mode

<Programming an entire disc as one step>
(Disc all program)

If you skip step 3 of the operation example, disc 2 is programmed as step 4.

<Programming a pause (remote control only)>
(Pause program)

If you press II at step 4, you can program a pause. When you press II, "PA" appears in the display instead of the disc number.

- For example, when making a program for recording both sides of a cassette tape, press II to insert a pause after programming the tracks for one side. After turning the tape over, press II to resume recording.

Notes!!

- You cannot program a pause as the first step, nor program two pauses in a row.
- When you program a pause, it counts as 1 step and reduces the total number of tracks you can program.

To erase a program...

Press ■ twice during playback (or once in stop mode). You can also erase the program by pressing **MODE**, **RANDOM**, **PREVIOUS**, or **SINGLE LOADER PLAY** in either play or stop mode (or by pressing **BEST** in stop mode).

To cancel a program step

In stop mode, each time you press **CLEAR**, the last step in the program is erased.

- If a programmed disc is missing or inserted backwards during program play, "NO DISC" appears in the display, the step is automatically erased, and playback proceeds to the next step.
- Program contents are stored in memory even when the power is turned off.
- Press the **TIME/CHARA** twice to check the number of steps that have been programmed.

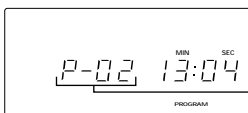

This indicates the number of programmed steps.

(Memory Back-Up Function)

Memorized data will be stored in memory for approx. 1 month even if the power cord is unplugged. However, this period may be shortened somewhat, depending on the amount of memory used.

Notes!!

- If step 5 is carried out before the accumulated time is displayed, the program play starts and the time is not displayed.
- When UNLOAD is pressed while a program has been entered, the disc for the 1st program step comes on the center position and the hood opens.
- The display is not shown if the total time of the program is 100 minutes or more.
- When another PD-F1039 is connected to create a 602-disc changer, only the discs loaded in one of the PD-F1039's can be programmed. It is not possible to program discs from both of the PD-F1039s.
- The following restrictions apply to programming when 2 PD-F1039 units are connected.
 - When inputting program data with the remote control unit, when the 1st disc number is P0 or between 1 and 300, program input will be on the MASTER unit. When between 301-600, program input will be on the SLAVE unit.
 - Carry out programming of the SLAVE unit's P0 using the controls on the SLAVE unit.
 - When programs are input on both the MASTER unit and SLAVE unit, program playback will start from the unit that PLAY is pressed on. After playback has finished, pressing PLAY on the other unit will start playback on that unit. (RELAY PROGRAM play is not possible.) When PLAY is pressed on the remote control unit, the program on the MASTER unit will playback.



VARIOUS OPERATIONS

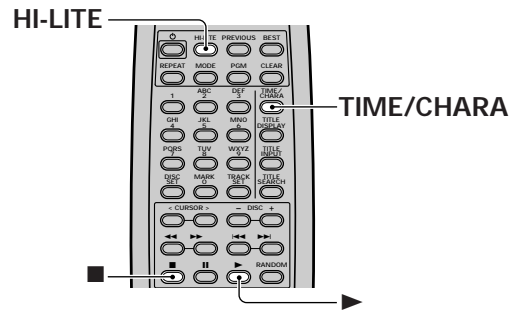
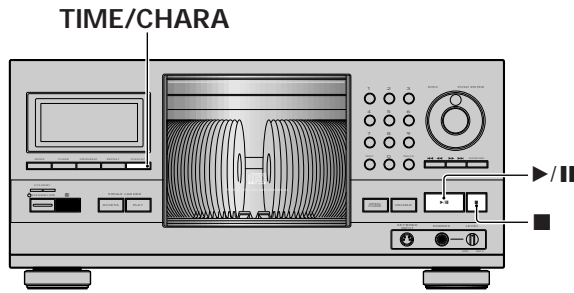

To scan quickly through tracks on a disc (HI-LITE scan)

- The operation is available only from the remote control unit.

This function plays a 10 second portion located 1 minute from the start of each track on all the discs in the current play mode.

<Disc scan>



Press once

Press HI-LITE during either play or stop mode.

- The unit plays a 10 second portion located 1 minute into the first track of each CD, starting from the first CD.

The "DISC" and "SCAN" indicator blinks.

<Track scan>



Press twice

Press HI-LITE twice during either play or stop mode.

- The unit plays a 10 second portion located 1 minute into each track of each CD, starting from the first CD.

The "TRACK" and "SCAN" indicator blinks.

<Program scan> Press HI-LITE during program mode.



Press once

- The unit plays a 10 second portion located 1 minute into each track in the program.

The "TRACK" and "SCAN" indicator blinks.

<Best selection memory scan>



Press once

Press HI-LITE during best selection memory playback.

- The unit plays a 10 second portion located 1 minute into each track in the best selection memory.

The "TRACK" and "SCAN" indicator blinks.

<To return to normal playback>

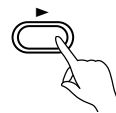

Press ► (or ►/II) when you reach the track you want to hear.

HI-LITE scan is canceled and normal play resumes.

- To cancel HI-LITE scan, press ■.

Notes!!

- You can use ◀◀▶▶ to skip to another track during track scan.
- If the player is in ALL REPEAT mode, the HI-LITE scan will repeat.
- If the track is less than 1 minute long, the first 10 seconds of the track will be played. If the track is less than 10 seconds long, the entire track will be played.

To use the TIME/CHARA button

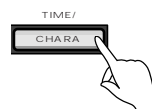

Press TIME/CHARA during playback.

Each time you press TIME/CHARA, the display changes as follows.



Disc number, Track number and Elapsed Time.
↓
Remaining time (TRACK)
↓
Remaining time (DISC)
↓
Total time (TOTAL)

Notes!!

- Time remaining on the track may not be displayed for tracks numbered greater than 24.
- Time remaining on the disc is not displayed during RANDOM, PROGRAM or BEST play.
- During PROGRAM play

Disc number, Track number and Elapsed Time.
↓
Remaining time (TRACK)
↓
Total program time and number of steps (TOTAL)

- During BEST play

Disc number, Track number and Elapsed Time.
↓
Remaining time (TRACK)
↓
Total number of steps memorized in BEST (TOTAL)

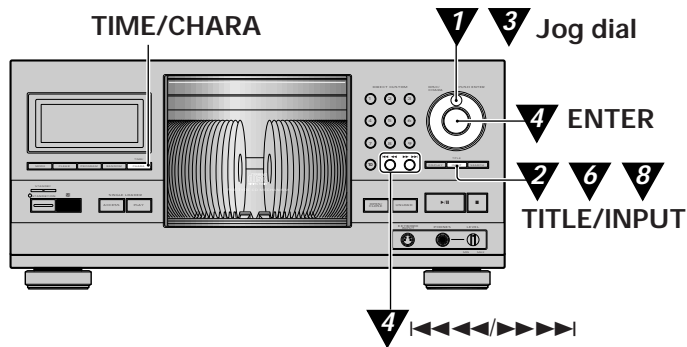

Title Input

Disc titles and artist's name can be given to discs loaded in the rack. The titles can have up to 12 characters, including letters (A to Z and a to z), numbers and symbols. Characters can be input either using the jog dial on the main unit or the digit buttons on the remote control unit.

- Inputting characters using the jog dial on the main unit

Operation example : To give CD number 17 the title "BEST"

1 Turn the jog dial to select the number of the CD to which you want to give a title.

2 In the play or stop mode, press the TITLE/INPUT button.

3 Turn the jog dial to select the desired character. (To perform this operation from the remote control unit, use the DISC "-" and "+" buttons.)

Blink

"B" is displayed as the first character in the disc title.

- A...Z (letters)
- ↓
- 1...9, 0 (numbers)
- ↓
- Symbols

Symbols:

! " # \$ % & ' () * + , - . / : ; < = > ? @ [\] ^ _ ` { | } ~ ■ (Space)

Press the **TIME/CHARA** to switch between capital and small letters. (This operation is only possible when letters are displayed.)

4 Press ENTER on the center of the jog dial, or press the ►►►► button to move the blinking section on the display to the right.

(To perform this operation from the remote control unit, press the ►►► button.)



5 Repeat steps **3** and **4** to input all the characters of the disc title.

6 Once all the characters of the disc title have been input, press the TITLE/INPUT button.

"DISC" will blink during disc title input.

7 Repeat steps **3** and **4** to input all the characters of the artist's name.

8 Once all the characters of the artist's name have been input, press the TITLE/INPUT button.



VARIOUS OPERATIONS

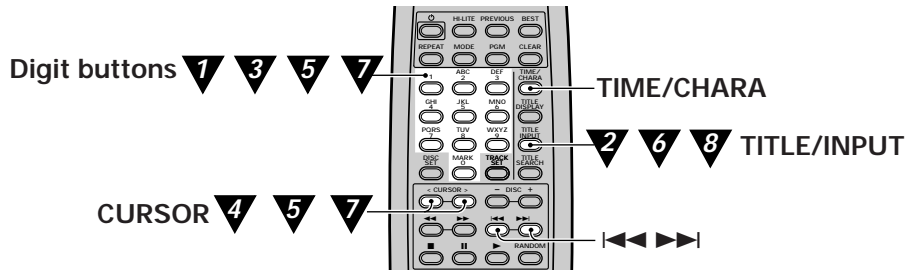

- Inputting characters using the remote control unit's digit buttons

- 1** Use the digit buttons to select the number of the CD to which you want to give a title.
 - 2** Press the TITLE/INPUT button. Pressing this button during playback will input the title on the disc playing back. In the custom play mode, the custom title input mode is set rather than the disc title input mode.
 - 3** Select each character to be entered by pressing a digit button. The character which can be entered varies every time the button is pressed.
 - 4** Press the CURSOR button to move the flashing cursor on the display to the right.
- If the next character to be entered belong to a different digit button from the previous character, it is not required to press the >>> button.
- 5** Repeat steps 3 and 4.
 - 6** Once all the characters of the disc title have been input, press the TITLE/INPUT button.
 - 7** Repeat steps 3 and 4 to input all the characters of the artist's name.
 - 8** Once all the characters of the artist's name have been input, press the TITLE/INPUT button.

[Example: To input "PIONEER"]

Operation	Title display
1 Press .	
2 Press twice.	
3 Press 4 times.	
4 Press 4 times.	
5 Press .	
6 Press 3 times.	
7 Press 3 times.	
8 Press .	
9 Press 3 times.	
10 Press 4 times.	
11 Press .	

- Pressing the stop button (■) during the title input operation returns to the condition before the input operation 1.

Symbols available with the MARK button ()

! " # \$ % & ' () * + , - . / : ; < = > ? @ [\] ^ _ ` { | } ~ ■ (Space)

TIME/CHARA button () switches the uppercase and lowercase letters.

- For discs equipped with CD Text, the first 12 characters of the disc title are automatically stored in the memory, and the 12-character title is displayed each time that disc is selected.
- To give your own title to a disc equipped with CD Text, input a space at the first character, then start your title from the second character. Once this is done, the title will no longer switch automatically when that disc is selected.
- When inputting titles with the SLAVE unit, use only the TITLE/INPUT button on either the unit itself, or the remote control unit.

Notes!!

- Disc titles cannot be given to discs in the single loader slot.
- Disc titles cannot be given to discs equipped with CD Text during playback. Press the stop button to set the stop mode before doing so.



VARIOUS OPERATIONS

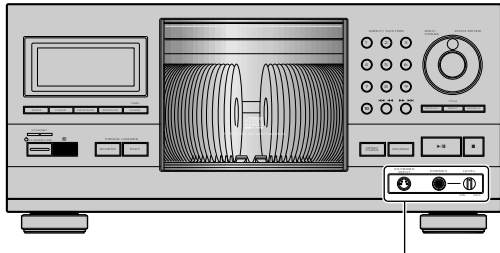

PC keyboard connection terminal

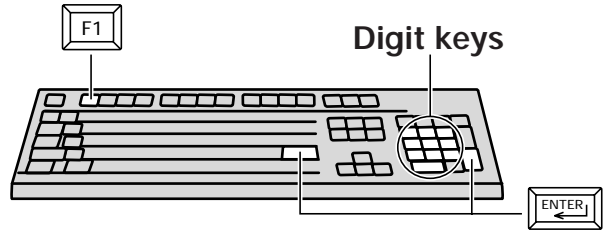

- Enter characters using the keyboard.

PC keyboard connection terminal Connect the IBM-compatible PC keyboard through the PC keyboard connection terminal.

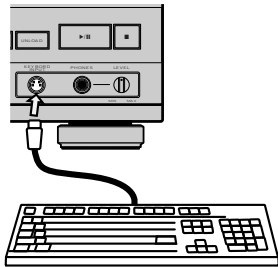

Operation example : To give CD number 17 the title "BEST"

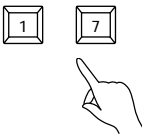
1  Input "1" and "7" using the keyboard's numeric keypad.

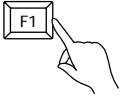
2  Press the F1 key of PC keyboard.

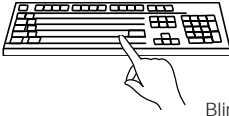

3  Enter characters using the keyboard.

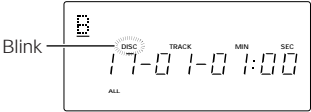

"B" is displayed as the first character in the disc title.

Press the **SHIFT** or **CAPS** key to switch between capital and small letters.
(This operation is only possible when letters are displayed.)

- 4** Repeat step **3** to input all the characters of the disc title.

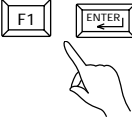

- 5**  Press the F1 or ENTER key of PC keyboard.

- 6** Repeat step **3** to input all the characters of the artist's name.

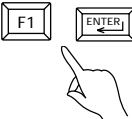
- 7**  Press the F1 or ENTER key of PC keyboard.

Keys used for character input

Character keys : A-Z,a-z,0-9

Symbols : ! " # \$ % & ' () * + , - . / : ; < = > ? @ [\] ^ _ ` { } ~ ■ (Space)

Note!!

- When two sets are connected, use the slave set to input characters and to perform other slave set operations.



VARIOUS OPERATIONS

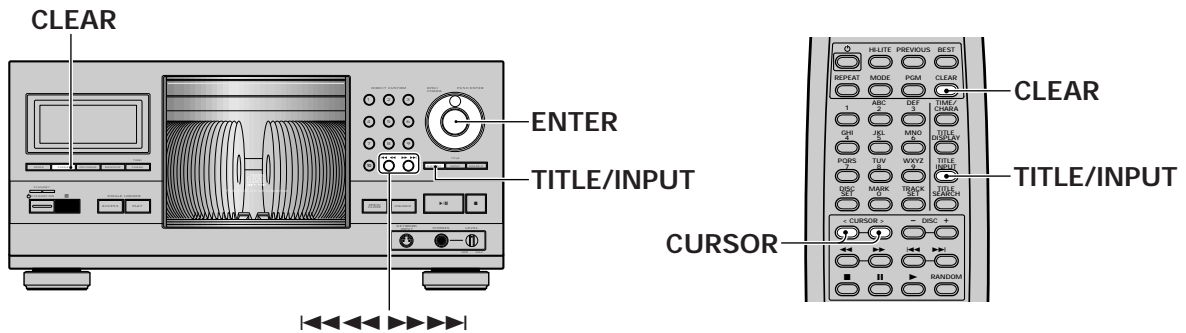

Input title of CUSTOM groups

During the custom mode, custom titles can be input by pressing the TITLE/INPUT button. Refer to "Title input" for the input method.

Custom group titles are displayed when the custom mode is set and when custom playback is started.

Correcting a title that has already been input

Titles that have already been input can be corrected (characters can be cleared or added).

• Clearing a character input by accident

Operation example: To change "BAEST" to "BEST"

- 1** Set the character input mode.
Perform steps **1** and **2** on page 19.

- 2** Use the or button to move the flashing cursor on the display under the character you want to clear.

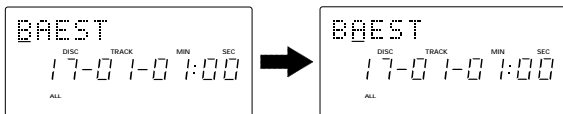

- 3** Press the CLEAR button to clear that character.

- 4** Press the TITLE/INPUT button.

• Adding characters

Operation example: To change "BET" to "BEST"

- 1** Set the character input mode.
Perform steps **1** and **2** on page 19.

- 2** Use the to move the flashing cursor on the display to the position at which you want to add a character.

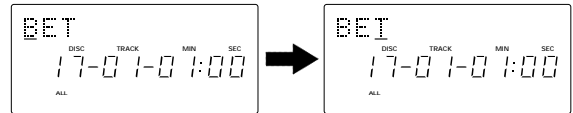

- 3** Select the character to be added.
For instructions on inputting characters, refer to "Title input" on page 19.

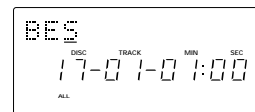

- 4** Press the TITLE/INPUT button.



VARIOUS OPERATIONS

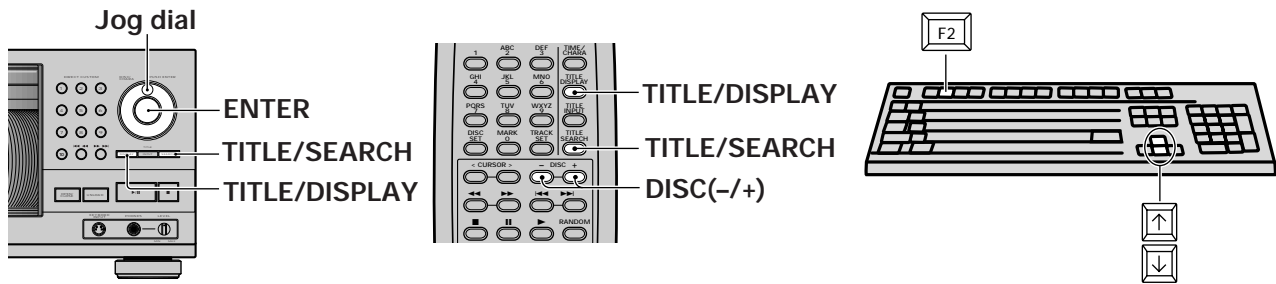

Displaying titles or artist's name

• For discs equipped with CD Text

When playback starts, the track title is displayed. After several seconds, the display starts scrolling. Display can be switched as shown below by pressing the TITLE/DISPLAY button.

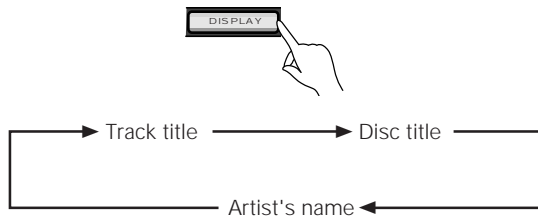

- Some CD TEXT data does not include "Artist's name".
- When scroll display of Track title, Disc title and Name of artist has finished, the display will return to Track title.

• For discs not equipped with CD Text

If the title input function has been used to input a disc title and artist's name, the display switches as shown below each time the TITLE/DISPLAY button is pressed.

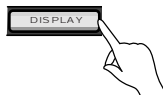

When a disc title and Artist's name have been input.

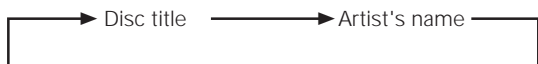

- When scroll display of Disc title and Name of Artist has finished, the display will return to Disc title.

Finding the desired CD by the disc title or artist's name

You can search for a specific CD using the first letter of the disc title or name of the artist.

Searching by using the disc title is called "title search", and searching by using the artist's name is called "artist search".

1



Press the TITLE/SEARCH button.

Title search
Press the TITLE/SEARCH button once.

Artist search
Press the TITLE/SEARCH button twice.

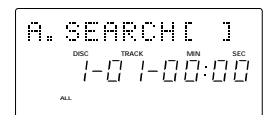
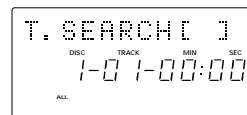

2

Input the first letter of the desired disc title (or artist's name).

For instructions on inputting characters, refer to "Title input" on page 19.

3



Press the TITLE/SEARCH button.

(The same operation is possible by pressing the jog dial.)

4

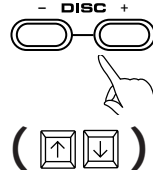

A different search result is displayed each time one of the DISC (-/+) buttons is pressed.

(The same operation is possible by turning the jog dial.)

- When the desired disc has been found and is displayed, press ► or **ENTER** to start playing that disc.
- The title (artist) search mode is canceled if no operation is performed for 5 seconds.
- The title (artist) search operation can also be performed during playback.
- When a space has been input before the first letter of the Disc title or Name of artist, the letter after that space will be detected.
- When detection is carried out at a space, the disc will be detected as a disc without title input.



TROUBLESHOOTING

Incorrect operations are often mistaken for trouble and malfunctions. If you think that there is something wrong with this component, check the points below. Sometimes the trouble may lie in another component. Investigate the other components and electrical appliances being used. If the trouble cannot be rectified even after exercising the checks listed below, ask your nearest PIONEER authorized service center or your dealer to carry out repair work.

Symptom	Cause	Remedy
No sound	<ul style="list-style-type: none"> Output cables are connected incorrectly or loosely. Incorrect operation of stereo amplifier. Pin plugs and/or amplifier terminals are dirty. Player is in pause mode. The disc is loaded with the label side leftward. 	<ul style="list-style-type: none"> Connect properly. Check the settings of amplifier switches and sound volume controls. Clean away dirt. Press ► or II. Reload the disc with the label side rightward.
When playback is started, it stops immediately. Pauses or stops during playback.	<ul style="list-style-type: none"> Disc is inserted in the wrong way. Smudges, etc., on the disc. 	<ul style="list-style-type: none"> Insert the disc correctly with the label side leftward. Clean the smudges from the disc and then play it again.
Remote control will not function.	<ul style="list-style-type: none"> Dead batteries. Obstruction between player and remote control unit. 	<ul style="list-style-type: none"> Replace batteries. Relocate remote control unit or remove obstruction.
SLAVE unit does not operate when 2 units are connected.	<ul style="list-style-type: none"> Incorrect connection. 	<ul style="list-style-type: none"> Refer to "Connecting another PD-F1039" on page 6, 7 and reconnect the 2 units.

Abnormal functioning of this unit may be caused by static electricity, or other external interference. To restore normal operation unplug the AC power cord and then plug it in again.

SELF-DIAGNOSTICS FUNCTION

The unit incorporates the self-diagnostic function.

When an abnormality is detected during operation of the unit, an error message (service No.) appears on the unit's display automatically. Treat the error by following the instructions in "Countermeasures".

Display on the unit

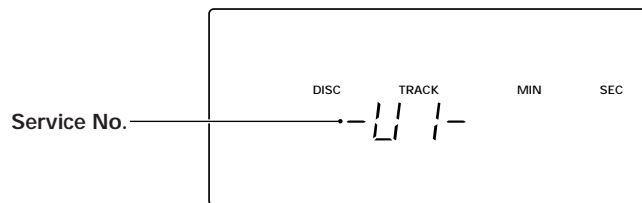

Service No.	Unit Status	Countermeasures
U1	The disc may not be loaded properly in the rack.	<ul style="list-style-type: none"> Reload the discs properly. (Insert only one disc in a slot.) Check if there is a foreign object attached onto the disc. Check if there is a foreign object in the rack.
U2	There is an operation error in the mechanical section.	<ul style="list-style-type: none"> Check if there is a foreign object in the rack. Unplug the power cord then plug it in again.
U3	There is an error related to the hood.	<ul style="list-style-type: none"> Check if the hood is caught by anything. Unplug the power cord then plug it in again.

If the same display appears again, there may be an error in the mechanical section. When requesting servicing, please also let us know the service number displayed on the unit.



SPECIFICATIONS

1. General

Type Compact disc digital audio system
 Power requirements AC 120V, 60 Hz
 Power consumption 15 W
 Power consumption in standby mode 1 W
 Operating temperature +5°C - +35°C
 (+41°F - +95°F)
 Weight (without package) 7.5 kg (16 lb 9 oz.)
 External dimensions 420(W) X 433(D) X 193(H) mm
 (16-9/16(W) X 17-1/16(D) X 7-5/8(H) in.)

2. Audio section

Frequency response 2 Hz - 20 kHz
 S/N ratio 98 dB or more (EIAJ)
 Dynamic range 96 dB or more (EIAJ)
 Harmonic distortion 0.003 % or less (EIAJ)
 Level difference between channels 1.0 dB or less (EIAJ)
 Output voltage 2 Vrms (EIAJ)
 Wow and flutter less than ±0.001 % (W.PEAK)
 (below measurable level) (EIAJ)
 Channels 2-channel (stereo)

3. Input/Output terminal

Audio line output jack
 Control input/output jacks
 CD•DECK SYNCHRO jack
 Optical digital output jack
 Headphone jack with volume control
 MASTER/SLAVE Control input/output jacks
 SLAVE Audio input jack
 PC keyboard input jack

4. Accessories

- Remote control unit 1
- Size AA/R6 dry cell batteries 2
- Audio cable 1
- Control cable 1
- Warranty card 1
- Operating instructions 1

Note!!

Specifications and design subject to possible modification without notice, due to improvements.

POWER-CORD CAUTION

Handle the power cord by the plug. Do not pull out the plug by tugging the cord and never touch the power cord when your hands are wet as this could cause a short circuit or an electric shock. Do not place the unit, a piece of furniture, etc., on the power cord, or pinch the cord. Never make a knot in the cord or tie it with other cords. The power cords should be routed such that they are not likely to be stepped on. A damaged power cord can cause a fire or give you an electrical shock. Check the power cord once in a while. When you find it damaged, ask your nearest PIONEER authorized service center or your dealer for a replacement.



Dear Customer:

Selecting fine audio equipment such as the unit you've just purchased is only the start of your musical enjoyment. Now it's time to consider how you can maximize the fun and excitement your equipment offers. This manufacturer and the Electronic Industries Association's Consumer Electronics Group want you to get the most out of your equipment by playing it at a safe level. One that lets the sound come through loud and clear without annoying blaring or distortion-and, most importantly, without affecting your sensitive hearing.

Sound can be deceiving. Over time your hearing "comfort level" adapts to higher volumes of sound. So what sounds "normal" can actually be loud and harmful to your hearing. Guard against this by setting your equipment at a safe level BEFORE your hearing adapts.

To establish a safe level:

- Start your volume control at a low setting.
- Slowly increase the sound until you can hear it comfortably and clearly, and without distortion.

Once you have established a comfortable sound level:

- Set the dial and leave it there.

Taking a minute to do this now will help to prevent hearing damage or loss in the future. After all, we want you listening for a lifetime.

We Want You Listening For A Lifetime

Used wisely, your new sound equipment will provide a lifetime of fun and enjoyment. Since hearing damage from loud noise is often undetectable until it is too late, this manufacturer and the Electronic Industries Association's Consumer Electronics Group recommend you avoid prolonged exposure to excessive noise. This list of sound levels is included for your protection.

Decibel

Level	Example
30	Quiet library, soft whispers
40	Living room, refrigerator, bedroom away from traffic
50	Light traffic, normal conversation, quiet office
60	Air conditioner at 20 feet, sewing machine
70	Vacuum cleaner, hair dryer, noisy restaurant
80	Average city traffic, garbage disposals, alarm clock at two feet.

THE FOLLOWING NOISES CAN BE DANGEROUS UNDER CONSTANT EXPOSURE

90	Subway, motorcycle, truck traffic, lawn mower
100	Garbage truck, chain saw, pneumatic drill
120	Rock band concert in front of speakers, thunderclap
140	Gunshot blast, jet plane
180	Rocket launching pad

Information courtesy of the Deafness Research Foundation.



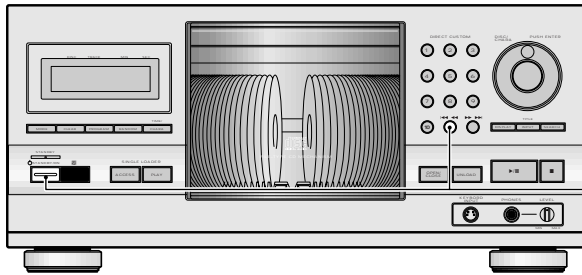

POWER ON DEMO display

POWER ON DEMO display mode allows you to see variations of the display. To enter the POWER ON DEMO display mode, press POWER and then ◀◀◀ within 1 second after turning on the power.
To cancel the POWER ON DEMO display mode, press any button.

Should this product require service in the U.S.A. and you wish to locate the nearest Pioneer Authorized Independent Service Company, or if you wish to purchase replacement parts, operating instructions, service manuals, or accessories, please call the number shown below.

8 0 0 - 4 2 1 - 1 4 0 4

Please do not ship your product to Pioneer without first calling the Customer Service Department at the above listed number for assistance.

PIONEER ELECTRONICS SERVICE, INC.
CUSTOMER SERVICE DEPARTMENT
P.O. BOX 1760, LONG BEACH,
CA 90801-1760, U.S.A.

For warranty information please see the Limited Warranty sheet included with your product.

Should this product require service in Canada, please contact a Pioneer Canadian Authorized Dealer to locate the nearest Pioneer Authorized Service Company in Canada.

Alternatively, please contact the Customer Service Department at the following address:

Pioneer Electronics of Canada, Inc.
Customer Service Department
300 Allstate Parkway, Markham, Ontario L3R OP2
(905) 479-4411
1-877-283-5901

For warranty information please see the Limited Warranty sheet included with your product.

Si ce produit doit être réparé au Canada, veuillez vous adresser à un distributeur autorisée Pioneer au Canada pour obtenir le nom de la Société de Service Autorisée Pioneer le plus près de chez vous. Ou encore, veuillez communiquer avec le Service de Clientèle de Pioneer:

Pioneer électroniques du Canada, Inc.
Département de service aux consommateurs
300 Allstate Parkway, Markham, Ontario L3R OP2
(905) 479-4411
1-877-283-5901

Pour obtenir des renseignements sur la garantie, veuillez vous reporter au feuillet sur la Garantie Limitée qui accompagne le produit.

S018 2L

Published by Pioneer Corporation.
Copyright © 1999 Pioneer Corporation.
All rights reserved.

PIONEER CORPORATION 4-1, Meguro 1-Chome, Meguro-ku, Tokyo 153-8654, Japan
PIONEER ELECTRONICS [USA] INC. P.O. BOX 1540, Long Beach, California 90801-1540, U.S.A.
PIONEER ELECTRONICS OF CANADA, INC. 300 Allstate Parkway, Markham, Ontario L3R OP2, Canada
PIONEER ELECTRONIC [EUROPE] N.V. Haven 1087, Keetberglaan 1, 9120 Melsele, Belgium TEL: 03/570.05.11
PIONEER ELECTRONICS AUSTRALIA PTY. LTD. 178-184 Boundary Road, Braeside, Victoria 3195, Australia, TEL: [03] 9586-6300
PIONEER ELECTRONICS DE MEXICO S.A. DE C.V. San Lorenzo Num 1009 3er piso Desp. 302 Col. Del Valle, Mexico D.F. C.P. 03100 TEL: 5-688-52-90

Free Manuals Download Website

<http://myh66.com>

<http://usermanuals.us>

<http://www.somanuals.com>

<http://www.4manuals.cc>

<http://www.manual-lib.com>

<http://www.404manual.com>

<http://www.luxmanual.com>

<http://aubethermostatmanual.com>

Golf course search by state

<http://golfingnear.com>

Email search by domain

<http://emailbydomain.com>

Auto manuals search

<http://auto.somanuals.com>

TV manuals search

<http://tv.somanuals.com>