

Pioneer *sound.vision.soul*

**AUDIO/VIDEO MULTI-CHANNEL
RECEIVER**

VSX-47TX

ELITE

Operating Instructions

Thank you for buying this Pioneer product. Please read through these operating instructions so you will know how to operate your model properly. After you have finished reading the instructions, put them away in a safe place for future reference.

IMPORTANT NOTICE

H006AEn

The serial number for this equipment is located in the rear panel. Please write this serial number on your enclosed warranty card and keep it in a secure area. This is for your security.

Information to User

Alteration or modifications carried out without appropriate authorization may invalidate the user's right to operate the equipment.

H011En

POWER-CORD CAUTION

S002 En

Handle the power cord by the plug. Do not pull out the plug by tugging the cord and never touch the power cord when your hands are wet as this could cause a short circuit or electric shock. Do not place the unit, a piece of furniture, etc., on the power cord, or pinch the cord. Never make a knot in the cord or tie it with other cords. The power cords should be routed such that they are not likely to be stepped on. A damaged power cord can cause a fire or give you an electrical shock. Check the power cord once in a while. When you find it damaged, ask your nearest PIONEER authorized service center or your dealer for a replacement.

WARNING: THE APPARATUS IS NOT WATERPROOFS, TO PREVENT FIRE OR SHOCK HAZARD, DO NOT EXPOSE THIS APPLIANCE TO RAIN OR MOISTURE AND DO NOT PUT ANY WATER SOURCE NEAR THIS APPARATUS, SUCH AS VASE, FLOWER POT, COSMETICS CONTAINER AND MEDICINE BOTTLE ETC.

H001AEn

If the socket outlets on the associated equipment are not suitable for the plug supplied with the product, the plug must be removed and an appropriate one fitted. Replacement and mounting of an AC plug on the power supply cord of this unit should be performed only by qualified service personnel. The cut-off plug must be disposed of as an electrical shock hazard could exist if connected to a socket outlet.

H022AEn

[For U.S. model]



ENERGY STAR® and the ENERGY STAR certification mark are registered US marks.

K001A_En

CAUTION:

THE STANDBY/ON BUTTON IS SECONDARY CONNECTED AND THEREFORE DOES NOT SEPARATE THE UNIT FROM MAINS POWER IN STANDBY POSITION. THEREFORE INSTALL THE UNIT SUITABLE PLACES EASY TO DISCONNECT THE MAINS PLUG IN CASE OF THE ACCIDENT. THE MAINS PLUG OF UNIT SHOULD BE UNPLUGGED FROM THE WALL SOCKET WHEN LEFT UNUSED FOR A LONG PERIOD OF TIME.

H017BEn

NOTE: This equipment has been tested and found to comply with the limits for a Class B digital device, pursuant to Part 15 of the FCC Rules. These limits are designed to provide reasonable protection against harmful interference in a residential installation. This equipment generates, uses, and can radiate radio frequency energy and, if not installed and used in accordance with the instructions, may cause harmful interference to radio communications. However, there is no guarantee that interference will not occur in a particular installation. If this equipment does cause harmful interference to radio or television reception, which can be determined by turning the equipment off and on, the user is encouraged to try to correct the interference by one or more of the following measures:

- Reorient or relocate the receiving antenna.
- Increase the separation between the equipment and receiver.
- Connect the equipment into an outlet on a circuit different from that to which the receiver is connected.
- Consult the dealer or an experienced radio/TV technician for help.

H010 En

[For Canadian model]

CAUTION: TO PREVENT ELECTRIC SHOCK, DO NOT USE THIS (POLARIZED) PLUG WITH AN EXTENSION CORD, RECEPTACLE OR OTHER OUTLET UNLESS THE BLADES CAN BE FULLY INSERTED TO PREVENT BLADE EXPOSURE.

ATTENTION: POUR PREVENIR LES CHOCS ELECTRIQUES NE PAS UTILISER CETTE FICHE POLARISEE AVEC UN PROLONGATEUR UNE PRISE DE COURANT OU UNE AUTRE SORTIE DE COURANT, SAUF SI LES LAMES PEUVENT ETRE INSEREES A FOND SANS EN LAISSER AUCUNE PARTIE A DECOUVERT.

H007A2L

[For Canadian model]

This Class B digital apparatus complies with Canadian ICES-003.

[Pour le modèle Canadien]

Cet appareil numérique de la classe B est conforme à la norme NMB-003 du Canada.

H009 2L

CAUTION:

This product satisfies FCC regulations when shielded cables and connectors are used to connect the unit to other equipment. To prevent electromagnetic interference with electric appliances such as radios and televisions, use shielded cables and connectors for connections.

H012 En

IMPORTANT



The lightning flash with arrowhead symbol, within an equilateral triangle, is intended to alert the user to the presence of uninsulated "dangerous voltage" within the product's enclosure that may be of sufficient magnitude to constitute a risk of electric shock to persons.



CAUTION:
TO PREVENT THE RISK OF ELECTRIC SHOCK, DO NOT REMOVE COVER (OR BACK). NO USER-SERVICEABLE PARTS INSIDE. REFER SERVICING TO QUALIFIED SERVICE PERSONNEL.



The exclamation point within an equilateral triangle is intended to alert the user to the presence of important operating and maintenance (servicing) instructions in the literature accompanying the appliance.

IMPORTANT SAFETY INSTRUCTIONS

H003 En

READ INSTRUCTIONS — All the safety and operating instructions should be read before the product is operated.

RETAIN INSTRUCTIONS — The safety and operating instructions should be retained for future reference.

HEED WARNINGS — All warnings on the product and in the operating instructions should be adhered to.

FOLLOW INSTRUCTIONS — All operating and use instructions should be followed.

CLEANING — Unplug this product from the wall outlet before cleaning. The product should be cleaned only with a polishing cloth or a soft dry cloth. Never clean with furniture wax, benzene, insecticides or other volatile liquids since they may corrode the cabinet.

ATTACHMENTS — Do not use attachments not recommended by the product manufacturer as they may cause hazards.

WATER AND MOISTURE — Do not use this product near water — for example, near a bathtub, wash bowl, kitchen sink, or laundry tub; in a wet basement; or near a swimming pool; and the like.

ACCESSORIES — Do not place this product on an unstable cart, stand, tripod, bracket, or table. The product may fall, causing serious injury to a child or adult, and serious damage to the product. Use only with a cart, stand, tripod, bracket, or table recommended by the manufacturer, or sold with the product. Any mounting of the product should follow the manufacturer's instructions, and should use a mounting accessory recommended by the manufacturer.

CART — A product and cart combination should be moved with care. Quick stops, excessive force, and uneven surfaces may cause the product and cart combination to overturn.



VENTILATION — Slots and openings in the cabinet are provided for ventilation and to ensure reliable operation of the product and to protect it from overheating, and these openings must not be blocked or covered. The openings should never be blocked by placing the product on a bed, sofa, rug, or other similar surface. This product should not be placed in a built-in installation such as a bookcase or rack unless proper ventilation is provided or the manufacturer's instructions have been adhered to.

POWER SOURCES — This product should be operated only from the type of power source indicated on the marking label. If you are not sure of the type of power supply to your home, consult your product dealer or local power company.

LOCATION — The appliance should be installed in a stable location.

NONUSE PERIODS — The power cord of the appliance should be unplugged from the outlet when left unused for a long period of time.

GROUNDING OR POLARIZATION

- If this product is equipped with a polarized alternating current line plug (a plug having one blade wider than the other), it will fit into the outlet only one way. This is a safety feature. If you are unable to insert the plug fully into the outlet, try reversing the plug. If the plug should still fail to fit, contact your electrician to replace your obsolete outlet. Do not defeat the safety purpose of the polarized plug.

- If this product is equipped with a three-wire grounding type plug, a plug having a third (grounding) pin, it will only fit into a grounding type power outlet. This is a safety feature. If you are unable to insert the plug into the outlet, contact your electrician to replace your obsolete outlet. Do not defeat the safety purpose of the grounding type plug.

POWER-CORD PROTECTION — Power-supply cords should be routed so that they are not likely to be walked on or pinched by items placed upon or against them, paying particular attention to cords at plugs, convenience receptacles, and the point where they exit from the product.

OUTDOOR ANTENNA GROUNDING — If an outside antenna or cable system is connected to the product, be sure the antenna or cable system is grounded so as to provide some protection against voltage surges and built-up static charges. Article 810 of the National Electrical Code, ANSI/NFPA 70, provides information with regard to proper grounding of the mast and supporting structure, grounding of the lead-in wire to an antenna discharge unit, size of grounding conductors, location of antenna-discharge unit, connection to grounding electrodes, and requirements for the grounding electrode. See Figure A.

LIGHTNING — For added protection for this product during a lightning storm, or when it is left unattended and unused for long periods of time, unplug it from the wall outlet and disconnect the antenna or cable system. This will prevent damage to the product due to lightning and power-line surges.

POWER LINES — An outside antenna system should not be located in the vicinity of overhead power lines or other electric light or power circuits, or where it can fall into such power lines or circuits. When installing an outside antenna system, extreme care should be taken to keep from touching such power lines or circuits as contact with them might be fatal.

OVERLOADING — Do not overload wall outlets, extension cords, or integral convenience receptacles as this can result in a risk of fire or electric shock.

OBJECT AND LIQUID ENTRY — Never push objects of any kind into this product through openings as they may touch dangerous voltage points or short-out parts that could result in a fire or electric shock. Never spill liquid of any kind on the product.

SERVICING — Do not attempt to service this product yourself as opening or removing covers may expose you to dangerous voltage or other hazards. Refer all servicing to qualified service personnel.

DAMAGE REQUIRING SERVICE — Unplug this product from the wall outlet and refer servicing to qualified service personnel under the following conditions:

- When the power-supply cord or plug is damaged.
- If liquid has been spilled, or objects have fallen into the product.
- If the product has been exposed to rain or water.
- If the product does not operate normally by following the operating instructions. Adjust only those controls that are covered by the operating instructions as an improper adjustment of other controls may result in damage and will often require extensive work by a qualified technician to restore the product to its normal operation.
- If the product has been dropped or damaged in any way.
- When the product exhibits a distinct change in performance — this indicates a need for service.

REPLACEMENT PARTS — When replacement parts are required, be sure the service technician has used replacement parts specified by the manufacturer or have the same characteristics as the original part. Unauthorized substitutions may result in fire, electric shock, or other hazards.

SAFETY CHECK — Upon completion of any service or repairs to this product, ask the service technician to perform safety checks to determine that the product is in proper operating condition.

WALL OR CEILING MOUNTING — The product should not be mounted to a wall or ceiling.

HEAT — The product should be situated away from heat sources such as radiators, heat registers, stoves, or other products (including amplifiers) that produce heat.

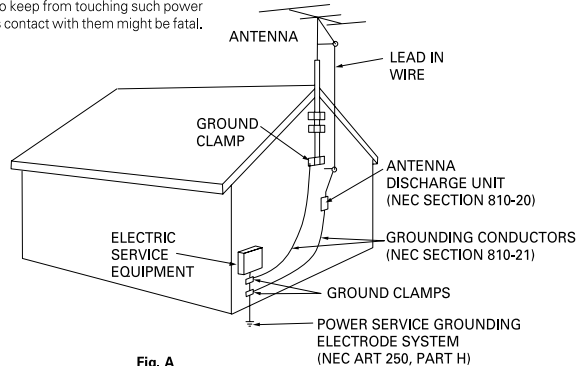

Fig. A

NEC — NATIONAL ELECTRICAL CODE

Table of Contents

Features	6
Before You Start	7
Checking the Supplied Accessories	7
Preparing the Remote Control	7
Loading the batteries	7
Remote Control Battery Indicator	7
Operating range of remote control unit	8
Installing the Receiver	8
Opening the Front Panel	8
Quick Start Guide Part 1	9
Home Theater: The Basics	9
Your Home System	9
The Source Material	9
The Listening Modes	9
Conclusion	9
1 Hooking Up Your DVD Player & TV	10
Digital Connections	10
2 Speaker Connections	11
3 Setting up the Main Unit	12
4 Assigning the Digital Inputs	12
Quick Start Guide Part 2	13
1 Auto Surround Sound Setup	13
2 Playing a DVD with Surround Sound	15
3 Personalizing Your Sound	15
Connecting Your Equipment	16
Connecting your TV	16
Component Video Input Default Settings	16
Connecting Video Components	17
Connecting a DVD, DVD/LD or LD player	17
Connecting VCRs or DVDs	18
Connecting a Video Component to the Front Panel	18
Connecting Satellite TV Components	19
Connecting Analog Audio Components	20
Cassette deck placement	21
Connecting to the Multi Channel Analog Inputs (DVD-A or Super Audio CD compatible player) ..	21
Connecting Digital Audio Components	22
Digital Input Default Settings	23
Connecting the Radio Antennas	24
Using outdoor antennas	24
Connecting Speakers	25
Placing Your Speakers	26
Speaker placement	26
AC Power Cord	26
AC Outlet [switched 100w max]	26

Displays & Controls	27
Remote Control	27
Back Panel	30
Front Panel	32
Display	34
Setting Up for Surround Sound	35
SPEAKER SYSTEMS	36
CHANNEL DELAY	38
CHANNEL LEVEL	39
Acoustic Calibration EQ	41
Check the Auto Settings	42
Basic Operation	43
Stereo and Multichannel Playback	43
Switching the channels used for playback (LISTENING CH SELECT)	44
Switching ANALOG/DIGITAL Signal Input	45
Playback of 96kHz 24 bit sound formats	45
Listening Modes	46
STEREO modes	46
STANDARD modes	46
HOME THX modes	47
ADVANCED CINEMA modes	48
ADVANCED CONCERT modes	49
Adjusting the Effect of Advanced Listening Modes ..	49
Listening with Acoustic Calibration EQ	50
Reducing Noise During Playback (DIGITAL NR Function)	50
Listening in MIDNIGHT Mode	51
Listening in LOUDNESS Mode	51
Adjusting Bass and Treble (Tone Control)	52
DVD Audio/MULTI CHANNEL IN Playback	53
DUAL MONO setting and Playback	54
Input Attenuator	54
Tape 2 Monitor	54
Using the Headphones	55
Video Select	55
Adjusting the Brightness of the Display	56
Status Display	56
Using the Tuner	57
Automatic and Manual Tuning	57
MPX Mode	57
Direct Access Tuning	58
Memorizing Frequently Used Stations	59
Naming Memorized Stations	60
Recalling Memorized Stations	61

Table of Contents

Remote Control of Other Components	62
Setting Up the Remote Control to Control Other Components	62
Recalling Settings Stored in the Remote Control	62
Programming Signals from Other Remote Controls (LEARNING Mode)	64
Using Remote Control with Other Components	66
CD/MD/VCR/DVD/LD/DVD Recorder and Cassette Deck operations	66
Cable TV/Satellite TV/ Digital TV/ TV operations ..	67
Setting up the DIRECT FUNCTION	68
Using Other Functions	69
Recording from Audio or Video Components	69
Speaker System B Setup	70
Stereo playback in another room	70
Bi-amping the front speakers	70
Bi-wiring your speakers	70
Switching A/B Speaker System	71
Connecting Additional Amplifiers	72
Pre Out Power Setup	73
Using an separate stereo pre-amplifier	73
Using a separate power amplifier for main room stereo sound	73
Multi-Room	74
MULTI-ROOM connections	74
MULTI-ROOM setup	75
Controlling the MULTI-ROOM system from the main room	76
Controlling the MULTI-ROOM system from the sub room	77
The PIONEER SR System: Operating other PIONEER components	78
Multi Operations	79
Performing multi operations	80
System off	81
Using System off	82
Editing Remote Control Display Names	83
Editing Buttons Names (KEY LABEL)	84
Adjusting the Light on the Remote control	85
Clearing Remote Control Settings You Have Input ..	86
Resetting the Main Unit	87
Advanced Setup	88
Assigning the Digital Inputs	88
Assigning the Component Video Inputs	89
Expert Setup	90
OSD (On-screen Display) ADJUSTMENT	91
BASS PEAK LEVEL	92
DYNAMIC RANGE CONTROL	93
MULTI CH IN SELECT	94
FUNCTION RENAME	95
THX Audio Setup	96
THX Ultra2 Subwoofer Setup	96
Surround Back Speaker Position	97
Re-Equalization	98
Techno Tidbits & Problem-solving	99
Dolby	99
Dolby Digital	99
Dolby Pro Logic II	99
Dolby Digital Surround EX	100
DTS	100
DTS	100
DTS-ES	100
DTS Neo:6	100
DTS 96/24	100
THX	100
Speaker Placement Information	102
Audio Block Diagram	104
Troubleshooting	105
Specifications	111

Table of Contents

Features	6
Before You Start	7
Checking the Supplied Accessories	7
Preparing the Remote Control	7
Loading the batteries	7
Remote Control Battery Indicator	7
Operating range of remote control unit	8
Installing the Receiver	8
Opening the Front Panel	8
Quick Start Guide Part 1	9
Home Theater: The Basics	9
Your Home System	9
The Source Material	9
The Listening Modes	9
Conclusion	9
1 Hooking Up Your DVD Player & TV	10
Digital Connections	10
2 Speaker Connections	11
3 Setting up the Main Unit	12
4 Assigning the Digital Inputs	12
Quick Start Guide Part 2	13
1 Auto Surround Sound Setup	13
2 Playing a DVD with Surround Sound	15
3 Personalizing Your Sound	15
Connecting Your Equipment	16
Connecting your TV	16
Component Video Input Default Settings	16
Connecting Video Components	17
Connecting a DVD, DVD/LD or LD player	17
Connecting VCRs or DVDs	18
Connecting a Video Component to the Front Panel	18
Connecting Satellite TV Components	19
Connecting Analog Audio Components	20
Cassette deck placement	21
Connecting to the Multi Channel Analog Inputs (DVD-A or Super Audio CD compatible player) ..	21
Connecting Digital Audio Components	22
Digital Input Default Settings	23
Connecting the Radio Antennas	24
Using outdoor antennas	24
Connecting Speakers	25
Placing Your Speakers	26
Speaker placement	26
AC Power Cord	26
AC Outlet [switched 100w max]	26

Displays & Controls	27
Remote Control	27
Back Panel	30
Front Panel	32
Display	34
Setting Up for Surround Sound	35
SPEAKER SYSTEMS	36
CHANNEL DELAY	38
CHANNEL LEVEL	39
Acoustic Calibration EQ	41
Check the Auto Settings	42
Basic Operation	43
Stereo and Multichannel Playback	43
Switching the channels used for playback (LISTENING CH SELECT)	44
Switching ANALOG/DIGITAL Signal Input	45
Playback of 96kHz 24 bit sound formats	45
Listening Modes	46
STEREO modes	46
STANDARD modes	46
HOME THX modes	47
ADVANCED CINEMA modes	48
ADVANCED CONCERT modes	49
Adjusting the Effect of Advanced Listening Modes ..	49
Listening with Acoustic Calibration EQ	50
Reducing Noise During Playback (DIGITAL NR Function)	50
Listening in MIDNIGHT Mode	51
Listening in LOUDNESS Mode	51
Adjusting Bass and Treble (Tone Control)	52
DVD Audio/MULTI CHANNEL IN Playback	53
DUAL MONO setting and Playback	54
Input Attenuator	54
Tape 2 Monitor	54
Using the Headphones	55
Video Select	55
Adjusting the Brightness of the Display	56
Status Display	56
Using the Tuner	57
Automatic and Manual Tuning	57
MPX Mode	57
Direct Access Tuning	58
Memorizing Frequently Used Stations	59
Naming Memorized Stations	60
Recalling Memorized Stations	61

Table of Contents

Remote Control of Other Components	62
Setting Up the Remote Control to Control Other Components	62
Recalling Settings Stored in the Remote Control	62
Programming Signals from Other Remote Controls (LEARNING Mode)	64
Using Remote Control with Other Components	66
CD/MD/VCR/DVD/LD/DVD Recorder and Cassette Deck operations	66
Cable TV/Satellite TV/ Digital TV/ TV operations ..	67
Setting up the DIRECT FUNCTION	68
Using Other Functions	69
Recording from Audio or Video Components	69
Speaker System B Setup	70
Stereo playback in another room	70
Bi-amping the front speakers	70
Bi-wiring your speakers	70
Switching A/B Speaker System	71
Connecting Additional Amplifiers	72
Pre Out Power Setup	73
Using an separate stereo pre-amplifier	73
Using a separate power amplifier for main room stereo sound	73
Multi-Room	74
MULTI-ROOM connections	74
MULTI-ROOM setup	75
Controlling the MULTI-ROOM system from the main room	76
Controlling the MULTI-ROOM system from the sub room	77
The PIONEER SR System: Operating other PIONEER components	78
Multi Operations	79
Performing multi operations	80
System off	81
Using System off	82
Editing Remote Control Display Names	83
Editing Buttons Names (KEY LABEL)	84
Adjusting the Light on the Remote control	85
Clearing Remote Control Settings You Have Input ..	86
Resetting the Main Unit	87
Advanced Setup	88
Assigning the Digital Inputs	88
Assigning the Component Video Inputs	89
Expert Setup	90
OSD (On-screen Display) ADJUSTMENT	91
BASS PEAK LEVEL	92
DYNAMIC RANGE CONTROL	93
MULTI CH IN SELECT	94
FUNCTION RENAME	95
THX Audio Setup	96
THX Ultra2 Subwoofer Setup	96
Surround Back Speaker Position	97
Re-Equalization	98
Techno Tidbits & Problem-solving	99
Dolby	99
Dolby Digital	99
Dolby Pro Logic II	99
Dolby Digital Surround EX	100
DTS	100
DTS	100
DTS-ES	100
DTS Neo:6	100
DTS 96/24	100
THX	100
Speaker Placement Information	102
Audio Block Diagram	104
Troubleshooting	105
Specifications	111

Features

Advanced Multichannel Stereophonic Concept

The VSX-47TX receiver is constructed with Pioneer's industry-leading advanced multichannel stereophonic concept. This means it is designed to reproduce music and movie soundtracks as close as possible to the intentions of the producer during mastering. The receiver uses a revolutionary 3-D Frame Construction technique and a Symmetrical Power Train Design, with high-performance Advanced Direct Energy MOS-FET output devices, generating 160 watts (FTC, 6Ω) of power for 7 independent channels. True 32-bit Twin Digital Signal Processing is used for ultra realistic sound.

Multi-Channel Acoustic Calibration System (MCACC)

In order to make setting up as easy as possible for users we have created the MCACC system. This unique and convenient way of getting good surround sound from the receiver makes trouble-free set up a snap. With the microphone equipped remote control plugged into the front panel with the remote control cable the MCACC system creates a monitoring environment to establish the parameters of the sound for the specific room you are using. The MCACC system adjusts the parameters to establish excellent surround sound effects and offer you the best in home theater for the minimum of effort.



Universal Player Compatibility (DVD Audio)

This receiver incorporates the latest technology and is able to handle cutting edge audio formats, like DVD Audio and 96 kHz/24 bit processing which are just hitting the market. Its high compatibility offers a variety of inputs to decode all types of sources at the highest possible quality. The receiver's multichannel input connections lets you hook up eight discrete channels of audio. It also has multichannel direct inputs and the ability to decode the cutting edge formats.

Next Generation THX Standards and New Digital Formats

The VSX-47TX is the first receiver in the world to be THX Ultra2 certified. Among the new THX technologies is ASA (Advanced Speaker Array), which can process any 5.1 channel source for 7.1 channel playback (THX Ultra2 Cinema and THX MusicMode), or 6.1 channel playback (THX Surround EX). THX Surround EX technology makes possible true playback of Dolby Digital Surround EX soundtracks. The VSX-47TX is also among the first generation of products able to play discs that feature high quality DTS 96/24 soundtracks. Naturally, you can also play all existing audio formats, including the recently developed Dolby Pro Logic II and DTS-ES Extended Surround formats. On the video side, the component video output is fully compatible with high definition, progressive-scan digital video (720p).

Lucasfilm and THX are trademarks or registered trademarks of Lucasfilm Ltd. & TM. Surround EX is a jointly developed technology of THX and Dolby Laboratories and is a trademark of Dolby Laboratories. All rights reserved. Used under authorization.

Manufactured under license from Dolby Laboratories. "Dolby  Pro Logic Surround EX", and double-D symbol  are trademarks of Dolby Laboratories.

"DTS", "DTS-ES Extended Surround" and "Neo:6" are trademarks of Digital Theater Systems, Inc.

Advanced Cinema & Advanced Concert Modes

The Advanced Cinema and Advanced Concert modes applied to movie soundtracks and music deliver a range of digital effects, giving you a wide range of listening possibilities.

LCD Illumination Remote Control

This self-illuminating remote control simplifies operation even in a darkened home theater room. Preset codes for other equipment and a learning function make it possible to use the remote control to operate products from other manufacturers. The full range of receiver functions can be controlled using the remote. A microphone is equipped for use for auto surround sound setup.

The Energy-saving Design

This unit is designed to use 0.65 W of energy when the receiver is in standby mode.

Before You Start

Checking the Supplied Accessories

Please check that you have received all of the following supplied accessories.



AM Loop Antenna



FM wire Antenna

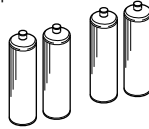

"AA" IEC LR6
batteries x 4

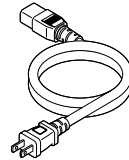

AC Power Cord

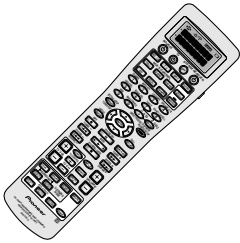

Remote Control Unit

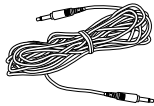

Remote Control
Cable for Auto
Surround Sound Setup

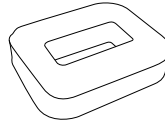

Remote Control
Stand for Auto
Surround Sound Setup

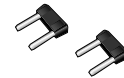

U-shaped
connectors x 2
(attached to back of
receiver)

Operating Instructions

PREPARATION

Preparing the Remote Control

Loading the batteries

Load the batteries into the remote control as shown below. Please use alkaline batteries. When you notice a decrease in the operating range, replace all batteries with new ones.

1

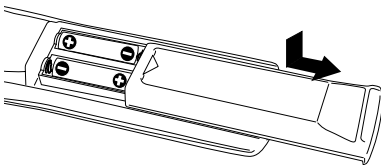

2

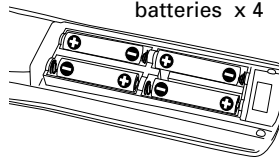

"AA" IEC LR6
batteries x 4

3

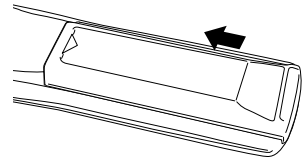

CAUTION!

Incorrect use of batteries may result in such hazards as leakage and bursting. Observe the following precautions.

- Never use new and old batteries together.
- Insert the plus and minus sides of the batteries properly according to the marks in the battery case.
- Batteries with the same shape may have different voltages. Do not use different batteries together.
- When disposing of used batteries, please comply with governmental regulations or environmental public institution's rules that apply in your country or area.

Remote Control Battery Indicator

When the batteries get too weak to operate the remote control properly an indicator warning screen will appear on the remote. Change the batteries as shown above. This must be done within five minutes or all your remote control settings will be cleared.

Shows when the
batteries are getting weak

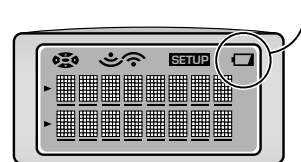

Before You Start

Operating range of remote control unit

The area in which you can use the remote control to operate the VSX-47TX is fairly large. To use, point the remote control toward the remote sensor on the front panel of this unit while within the range shown below.

Remote control may not function properly if:

- There are obstacles between the remote control and the remote sensor.
- Direct sunlight or fluorescent light is shining onto the remote sensor.
- The receiver located near a device emitting infrared rays.
- Operated simultaneously with another remote control which uses infrared rays.

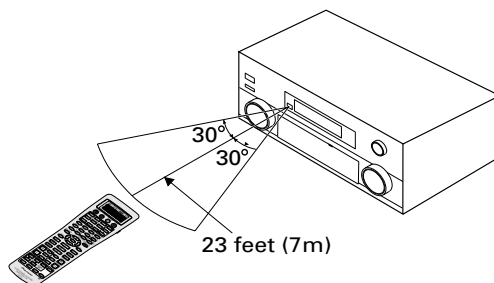

Installing the Receiver

CAUTION!

- Do not cover this unit in any way, for example with a sheet or piece of cloth. This would prevent proper heat dispersal.
- Do not place any object directly on top of this unit. This also would prevent proper heat dispersal.
- Be sure to leave adequate ventilation space around the amp! When installing in a rack, shelf, etc., be sure to leave more than 8 inches of space above the receiver.

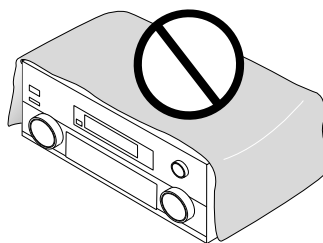

8 inches (20 cm)

Receiver

Opening the Front Panel

To open the front panel push gently on the lower third of the panel with your finger.

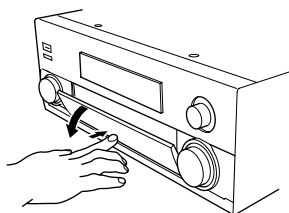

Quick Start Guide Part 1

Home Theater: The Basics

Most consumers are used to using stereo equipment to listen to music but many people are not used to home theater systems that give you many more options when listening to soundtracks. In fact, home theater is not really complicated and this little guide should give you an understanding of the basics.

The main reason why it seems so difficult is that there are three different factors involved in home theater and each will contribute to what kind of sound you get.

These factors are:

- 1) The equipment you are using for your home theater setup. Particularly important is the number of speakers you are using. We call this your speaker configuration.
- 2) The 'source' material you are using. This is the actual product (like a DVD) or broadcast (like cable TV) you are listening to/watching. We call this the source.
- 3) The last factor is the listening mode you choose on the VSX-47TX receiver. These are explained below and in subsequent chapters but most likely the STANDARD (default) setting will be fine.

Let's start with the home theater setup you have in your home.

1) Your Home System

The heart of your system is the VSX-47TX receiver and it is very flexible in getting you theater-like surround sound. You can use this receiver with anywhere from two to seven speakers (front left, front right, center, surround left and right, and surround back left and right) and a subwoofer to get home theater surround sound. We recommend you use seven speakers and a subwoofer. If this is not possible follow the instructions in "Auto Surround Setup" in the "Quick Start Guide" and you will be able to get good surround sound. Also, a DVD player is essential for home theater and you can also hook up satellite or cable TV tuner to this receiver and get a more home theater-like sound from these sources.

2) The Source Material

DVDs have become the basic source material for home theater because they offer excellent sound and picture quality, and allow users to enjoy home theater soundtracks with more than two channels of audio. For example, Dolby Pro Logic plays back four channels (front left, front right, center and a single channel for both surround speakers), Dolby Digital and DTS sources usually have six discrete channels (front left, front right, center, surround left and right and a channel that powers the subwoofer) of sound. Since the subwoofer channel is only for bass sounds, this multichannel setup has been named 5.1 channel sound.

It is important you consult the manual that came with your DVD player as well to make sure the player is outputting a surround soundtrack and all the other settings are appropriate for your home theater.

3) The Listening Modes

This receiver has many different listening modes and they are designed to cover all the speaker configurations and types of sources you might be using. In general, if you follow the recommended advice and have seven speakers and a subwoofer hooked up, in most cases the STANDARD listening mode is the easiest way to get realistic home theater sound. This is the default setting so you don't have to do anything.

To listen to music in stereo simply choose the STEREO listening mode. Other possibilities (like listening to a stereo CD with all seven speakers or taking a stereo source and getting multichannel home theater-like sound) are explained in listening modes (pages 46–49).

Conclusion

These are the three basic factors that contribute to your home theater sound. The easiest thing is to hook up seven speakers and a subwoofer and simply play your DVDs with STANDARD 7.1 mode. This will give you realistic and enjoyable home theater sound. First hook up your equipment, like your DVD player, TV and speakers. Then follow the instructions to set up your system for surround sound. It is very important you do one of the surround sound setups to get optimal sound from your receiver.

For more details on any of the information presented here check the main section of the manual.

Quick Start Guide Part 1

Before making or changing the connections, switch off the power and disconnect the power cord from the AC outlet.

1 Hooking Up Your DVD Player & TV

In order to use Dolby Digital/DTS soundtracks which are at the heart of home theater you need to hook up your DVD player with digital audio connections. You can do this by either a coaxial or an optical connection, **you don't need to do both**. The quality of these two types of connections is the same but since some DVD players only have one type of digital terminal you need to figure out which yours has and hook it up to the appropriate terminal on the receiver. In order to do this you will need the proper cable. For coaxial connections you can use a regular RCA video cord or the specially-made coaxial cords, they have the same type of plugs. For optical connections you will need a special optical cable which you can buy at your local stereo store. For more information on cords and cables see page 23. You should also hook up your DVD player with analog audio connections. Use regular RCA stereo cords for these connections. Also hook up the video connection on your DVD player, and your TV to this receiver. For your TV it's easiest to use a regular composite (RCA) video cord, as shown below. It is important that you hook up your TV (or monitor) in order to see a video image as well as the on screen displays (OSDs) shown by this receiver (for more on this see p.16).

Digital Connections

Some DVD players have both coaxial and optical terminals, but there is no need to connect both. If your DVD player has a coaxial terminal (not a PCM-only output) for the audio out hook it up using this terminal. Follow the diagram below. This is the best scenario, as you will be able to follow the default settings of this receiver and won't need to assign the digital inputs (you should use DIGITAL IN 1).

If your DVD player only has an optical terminal for the audio output you can hook it up using one of the DIGITAL IN terminals between 3-5 (for example, DIGITAL IN 3). In this case, you will need to assign the digital input (which means tell the receiver which input you used for your DVD digital audio). See page 12 for this.

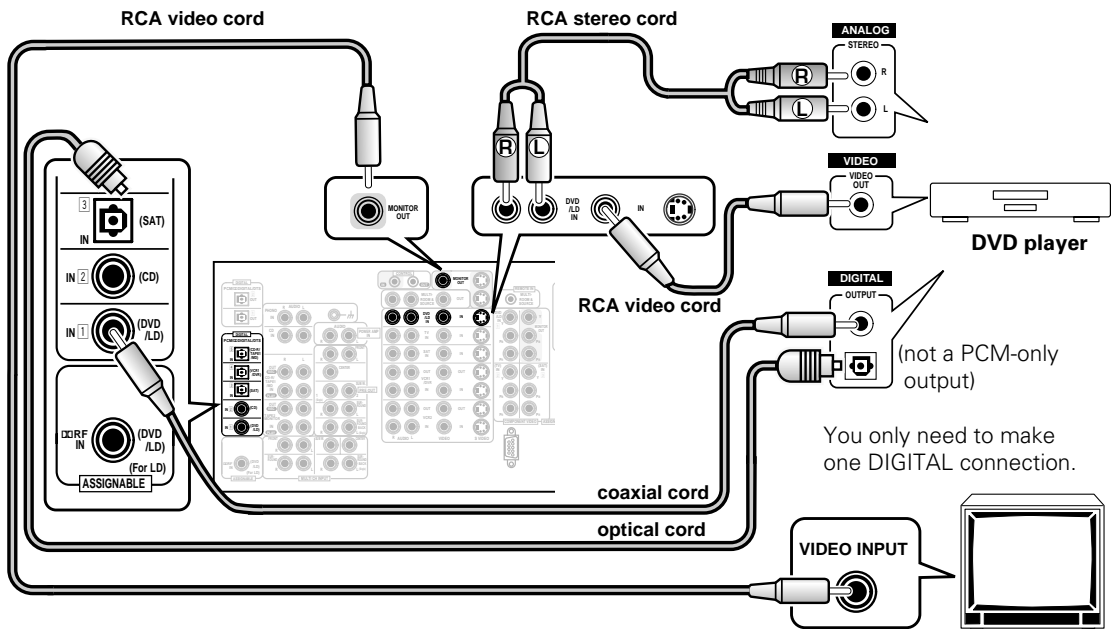

2 Speaker Connections

Home theater is designed to be setup with five, or seven speakers (front left & right; center; surround left & right; and, optimally, surround back left & right) and a subwoofer, but you can use this receiver with fewer speakers. Hook up the speakers you have to the A speaker terminals on the back of the receiver. If you only have two speakers hook them up as "FRONT." If you have three hook up the single speaker as "CENTER." Follow the diagram below in order to hook up all your speakers. A center speaker is very important for watching films because in digital soundtracks the dialog comes from the center speaker. If you do not have a center speaker you must tell the receiver the center channel is off or when you listen to digital soundtracks you won't hear any dialog. This can be done automatically by following the Auto Surround Sound Setup instructions from page 13 in this Quick Start Guide.

If possible, use surround back speakers. These speakers are important to take full advantage of all the sound channels on new, eight channel home theater DVDs. The diagram below also explains how to hook up a subwoofer which provides realistic bass sounds. For the subwoofer use a mono (single plug) RCA cord and for the other speakers use regular speaker cords. **See page 102-103 for advice on speaker placement.** Make sure you connect the speaker on the right to the R terminal and the speaker on the left to the L terminal. Also make sure the positive and negative (+/-) terminals on the receiver match those on the speakers.

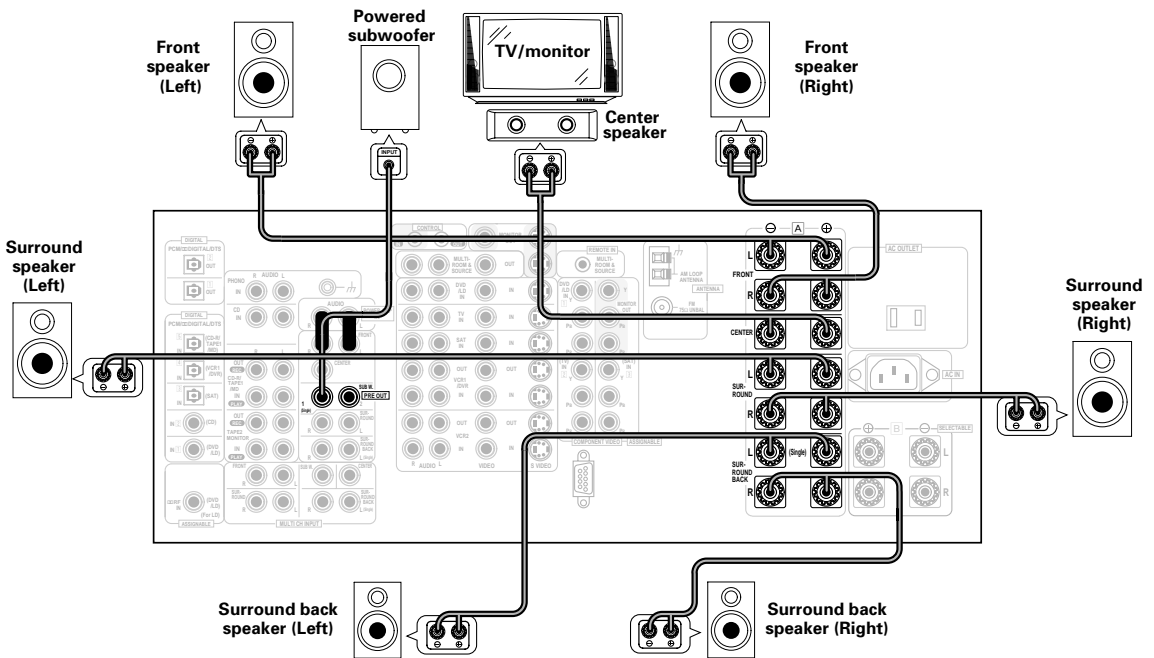

• Please use speakers with a nominal impedance rated 6Ω-16Ω.

- If you only have one surround back speaker hook it up to the left surround back terminal.
- If you use a THX certified subwoofer use the THX INPUT jack on the subwoofer (if your subwoofer has one) or switch the filter position to THX on your subwoofer.
- When you attached your speaker wire to the speaker terminal make sure that not even one strand of wire touches the back of the receiver. If this happens it could short out the receiver.

■ Speaker terminals

① Twist exposed wire strands together tightly.

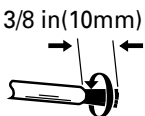

② Loosen speaker terminal and insert exposed wire.

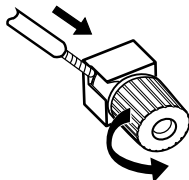

③ Tighten terminal.

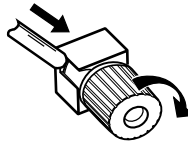

The speaker terminals also accept single banana plugs. (Refer to speaker manual for details.)

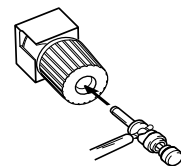

3 Setting up the Main Unit

- 1 Connect the supplied AC power cord to the back of the main unit and plug the other end into a wall outlet (don't use any other power cord than the one that came with this receiver).
- 2 Press the POWER ON/OFF button to put the receiver in ON mode.
- 3 Press the STANDBY/ON button to switch the receiver ON.

4 Assigning the Digital Inputs

This is only necessary if you did not hook up your DVD player to DIGITAL IN 1 using a coaxial cable but rather connected it to one of the optical digital inputs. The following example shows how to assign the DIGITAL IN 3 jack to DVD.

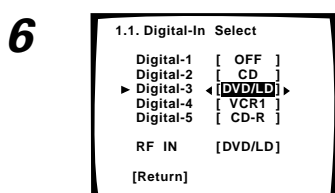
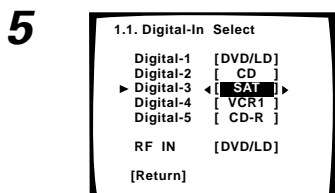
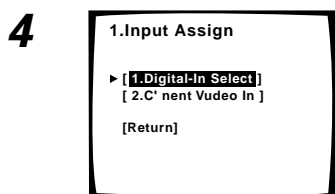
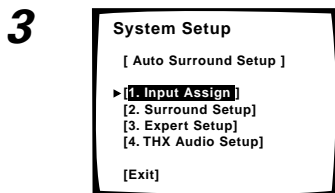
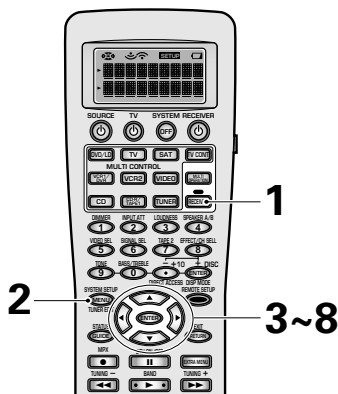

1 Turn on the receiver and your TV, press the RECEIVER button on the remote control.

2 Press the SYSTEM SETUP button.

The SYSTEM SETUP menu appears on your TV (if it doesn't, refer to page 12 to make sure you have properly connected the receiver to your TV).

3 Looking at the on-screen display on your TV, use the ▲▼ buttons to select INPUT ASSIGN. Press the ENTER button.

4 DIGITAL IN-SELECT should be selected, if not use the ▲▼ buttons to select it. Press the ENTER button.

5 The default setting for the DIGITAL-3 jack is SAT.

6 Use the ◀▶ buttons to select DVD/LD.

7 Select EXIT with the ▲▼ buttons and press ENTER.

You will return to the SYSTEM SETUP menu.

8 Use the ▲▼ buttons to select RETURN and press ENTER.

The receiver exits the setup process.

Quick Start Guide Part2

1 Auto Surround Sound Setup

If setting up your surround sound speakers seems like it's going to be an involved task you only need to use this quick, automatic method to achieve good surround sound. You'll need to hook up the remote control, which has a microphone in it, so that the receiver can hear and judge the distance, size, sound character and sound pressure level of the speakers and thus know what settings to make.

First turn the volume down, then plug the cord provided into the remote control (as shown in A below) and then plug the cord into the SETUP MIC jack on the front panel of the receiver (as shown in B below). Don't plug in the other way around.

Follow the step-by-step guide to setting up your surround sound below. This will customize the surround sound for your listening environment. After you get used to the system it is a good idea to make more advanced settings as explained in "Expert Setup" (page 90). Also, if you want to personalize your surround sound setups by making the settings manually go to "Setting up for Surround Sound" (starting on page 35). Make sure all the components you need, especially speakers, have been properly connected before you do the steps described here. Use the arrow buttons (▲▼) and the ENTER button on the remote control to navigate the on-screen display (OSD) on your TV.

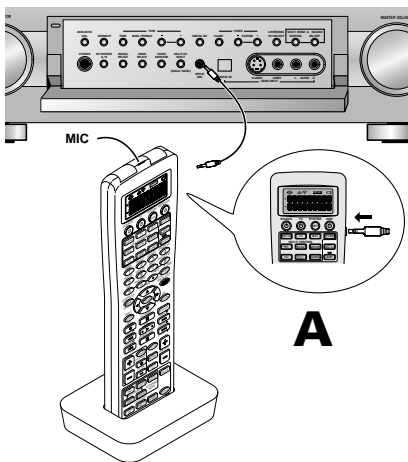

B

1 Switch on the receiver and your TV.

Make sure your TV is set to this receiver as you will use the on-screen displays (OSDs) on your TV to follow these instructions.

2 Hook up the remote control to the SETUP MIC jack on the Front Panel.

3 Place the remote control at your normal listening position.

Use a table, chair or something else to put the microphone at the same height as you usually listen to your system from.

4 If you have a subwoofer turn it on.

5 Press RECEIVER button on the remote control.

6 Press the SYSTEM SETUP button and use the on-screen display (OSD) that appears on your TV.

7 The arrow should be pointing at AUTO SURROUND SETUP, press ENTER.

8 NORMAL SURROUND should be selected. (Use the ◀▶ buttons to select it if it isn't.) Use the ▲▼ buttons to select GO NEXT and press ENTER.

For Bi-amp settings choose FRONT BI-AMP 5.1 and follow the directions from step 3 on page 37.

RETURN brings you back to the system setup menu.

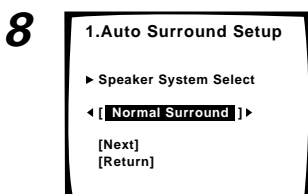
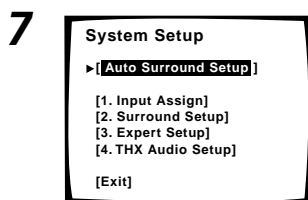
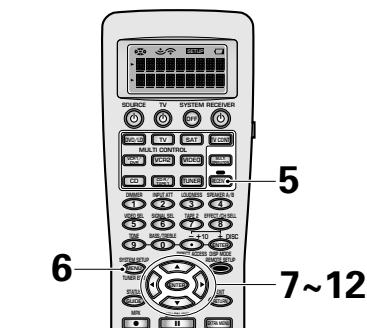

10

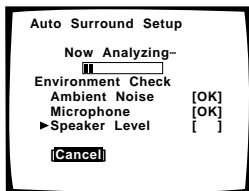
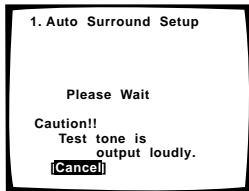
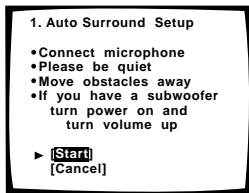

11

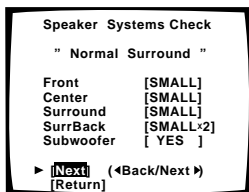
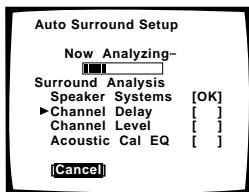
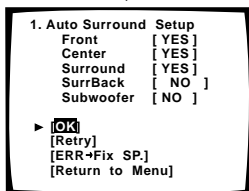

9 Some auto setup instructions will be listed, make sure to follow them.

Make sure you have: hooked up the remote control microphone and moved obstacles to the speakers out of the way. If you have a subwoofer make sure it is turned on and has the volume turned up.

WARNING: The test tones are very loud!! Make sure there are no infants or small children in the room and that no one who will be scared, upset or injured by loud noise is present. You yourself may want to wear ear-plugs. It is possible to lower the volume of test tones, but this could result in incorrect speaker settings.

10 If you have followed all setup instructions and warnings above make sure that the arrow is pointed to START and press ENTER. Put the remote control into the its stand and be prepared for loud test tones.

Try to be as quiet as possible after hitting ENTER. The test tones may take up to 30 seconds.

The volume automatically increases to 0dB, then the system will output some test tones and establish ambient noise levels, the microphone status, and what speakers you hooked up.

11 Check the speaker settings on the OSD

If they match your speaker configuration make sure **OK,GO NEXT** is selected and press **ENTER**. Put the remote control into the its stand again. The test tones will be output loudly again. The test tones may take up to 5 minutes this time.

After it has finished, you see the **SPEAKER SYSTEMS CHECK** screen. If you want to view the settings select **NEXT** and press **ENTER** repeatedly. If not, simply go to step 13.

If they do not match the speaker configuration you hooked up and you want to try again select **RETRY** with **▲▼** buttons and press **ENTER**. Put the remote control into the its stand again. Follow the instructions above from step 10.

If the speaker settings do not match the speaker configuration you connected and you want to input the settings manually select **ERR->FIX SP** with the **▲▼** buttons, press **ENTER**. Put the remote control into the its stand again. and go to step 12.

If you see an **ERR** message in the right side column, there may be a problem with the speaker connection. If selecting **RETRY** doesn't fix the problem, turn off the power and check the speaker connections.

12 Use the ▼▲ buttons to select a speaker then the ◀▶ buttons to select the size of each speaker individually.



- Make sure the room environment follows the guidelines displayed on the OSD during auto setup. If the room environment is not optimal for auto setup (too much ambient noise, obstacles blocking the speakers from the microphone on the remote control, etc.) the final settings may be incorrect. Check for household appliances (air conditioner, fridge, fan, etc.) that may be affecting the environment and switch them off if necessary.
- Screens will turn off after three minutes and the receiver will automatically exit from the setup process.
- If you leave CHECK!! or other error message on the screen for three minutes, or you choose CANCEL at anytime during the setup, the settings made up to that point will be cleared.
- After completing the Auto Surround Sound Setup, ACOUSTIC CAL EQ ON (ALL CH ADJ) is set automatically.

Use the ▼▲ buttons to select OK, GO NEXT and press ENTER. Put the remote control into its stand.

The system will output another series of test tones to establish the proper channel level, channel delay and acoustic calibration EQ. Again, be prepared for loud test tones.

After it has finished, you see the SPEAKER SYSTEMS CHECK screen. If you want to view the settings select **NEXT** and press **ENTER** repeatedly. If not, simply go to the next step.

13 Select RETURN to go back to the SYSTEM SETUP menu, then choose EXIT to complete the auto surround sound setup and return to normal use.

You should now have settings that will give you good surround sound. The MCACC indicator will light and the surround sound settings are complete.

2 Playing a DVD with Surround Sound

- 1 Make sure the receiver, your TV, and your DVD player are switched ON.**
- 2 Press the DVD/LD button on the remote control.**
You should see "DVD/LD" in the display on the receiver.
- 3 Press the LISTENING CH SELECT button on the remote control repeatedly until you see "7.1" in the display on the receiver.**
- 4 Press the STANDARD button on the remote control for the basic surround sound setting.**
- 5 Play a DVD then adjust the MASTER VOLUME.**

3 Personalizing Your Sound

- 1 Use the Surround Listening Mode buttons to find the listening mode(s) that work best for the source material.**
For more information see pages 46–49.
- 2 To get a more refined sound, make the sound settings in "Expert Setup" (p.90-95).**

Connecting Your Equipment

Connecting your TV

Connect your TV to the jacks as shown below. Hook up with either component video, S video, or composite video cords (the quality descends in this order) **but you must use the same type of video cords to hook up your DVD player (and all other video components) as you use to hook up your TV.** Composite video cords, which look just like regular RCA audio cords (see p.20) but have only one cable and connector, are the most common.

Before making or changing the connections, switch off the power and disconnect the power cord from the AC outlet.

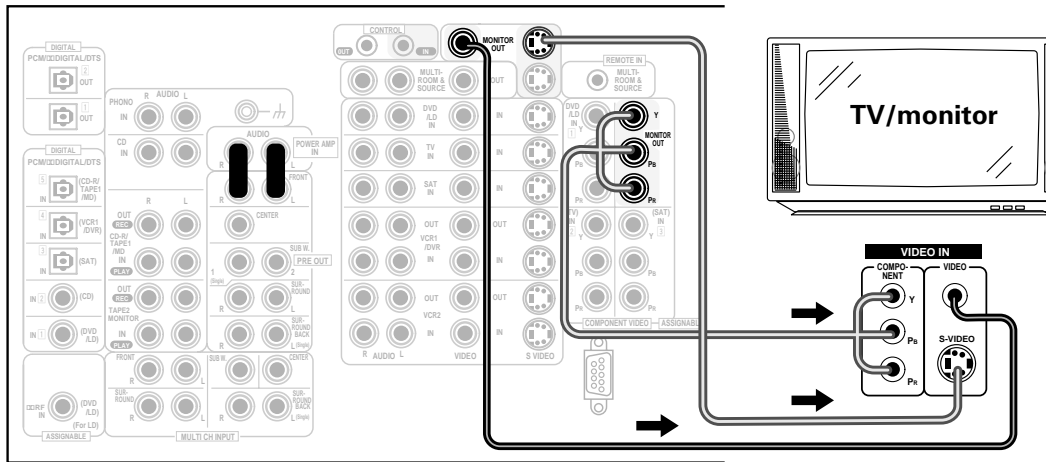

S Video

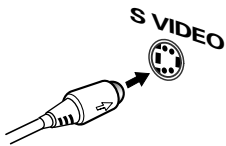

S video cables produce clearer picture reproduction by sending separate signals for the luminance and the color. These jacks are labeled by the Japanese designation "S2" on the VSX-47TX but they are simply S video jacks.

Component video

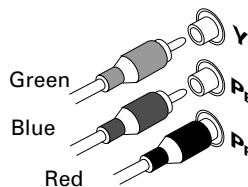

The video signal is divided into the luminance (Y) signal and the color (Pb and Pr) signals. In this way, interference between the signals is avoided.

Composite Video

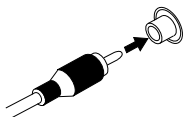

Composite video cords are the most common or standard video cord but also the lowest quality. The color on the connector is yellow to distinguish it from regular RCA audio cords which have white and red connectors (see p.20). It is important to use a true composite video cord and not an audio cord (though they look exactly the same) because the impedance is different and this will affect the picture quality.

Component Video Input Default Settings

If you use component video cords to hook up your video equipment it is easiest to do so following the default settings, which are listed below. Remember you must use component video cords from your video source (for example, a DVD player) to the receiver and from the receiver to your TV (or monitor). If you don't follow the default settings below you must assign the inputs you used with the "Assigning the Component Video Inputs" procedure. See page 89 to do this.

The default settings are:

COMPONENT VIDEO IN 1: DVD/LD

COMPONENT VIDEO IN 2: TV

16 COMPONENT VIDEO IN 3: SAT

Connecting Video Components

Connect your video components as shown on this and the following page. For video components (for example, a DVD player) there are two types of connections to make, video and audio.

Hook up your video signal with either component video, S video or composite video cords (the quality descends in this order) but you must use the same type of cord as you used to hook up your TV.

For the audio signal, in order to use digital soundtracks like Dolby Digital or DTS you must hook up a digital input, with either a coaxial or optical cord (see p.22 & 23). It is also a good idea to hook up your components with analog audio connections as well, since some DVDs may not output a digital audio track. A DVD/LD player or LD player requires a specialized **RF** connection (shown at the very top of the first diagram below) to cover the all possible soundtracks on laser discs.

If you want to record from your DVD player composite (or S video) cord connections and analog audio connections are necessary.

Before making or changing the connections, switch off the power and disconnect the power cord from the AC outlet.

Connecting a DVD, DVD/LD or LD player

Hook up your audio signal with either a coaxial or optical digital cords (you don't need to do both). For DVD/LD or LD players, if your player has a **RF** output hook up the **RF** connection as well (with a coaxial cord). This will ensure you can use all LDs (see below & p.22). If you hook up your DVD/LD player using component video cable connections you might need to setup your DVD player for component video output as well. See your DVD manual for details. If you have a DVD-A or Super Audio CD compatible player, see "Connecting to the Multi Channel Analog Inputs" on page 21.

You need to hook up your audio with analog connections as well.

Before making or changing the connections, switch off the power and disconnect the power cord from the AC outlet.

*The arrows indicate the direction of the signal.

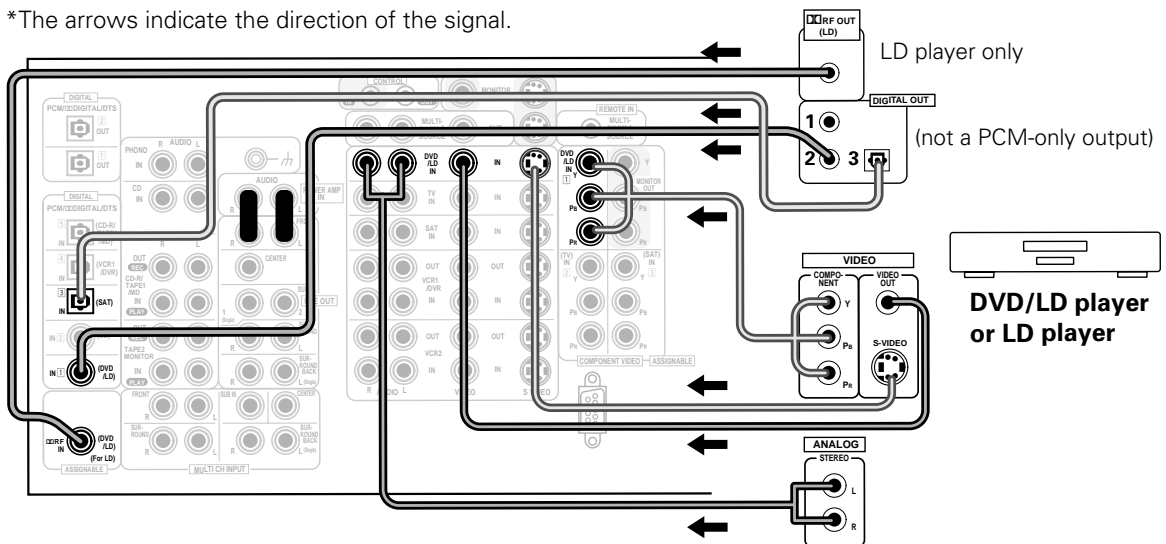

- If your digital connections are different than the default settings you will need to assign the digital jacks to the proper component(s) with the "Assigning the Digital Inputs" procedure. See page 88 to do this.
- If your component video connections are different from the default settings, you will need to assign them with "Assigning the Component Video Inputs". See page 89 for how to do this.

Connecting Your Equipment

Connecting VCRs or DVRs

Connect the video out of your VCR/DVR using either S video or composite video cords, depending on how you connected the receiver to your TV (see p.16). Use analog audio cords for the audio signal. To record, you also need to connect a set of audio/video outputs from the receiver to the audio/video inputs on your VCR/DVR. Note that to record video from a source component, the video connection from the source to the receiver and from the receiver to the recorder must be the same type.

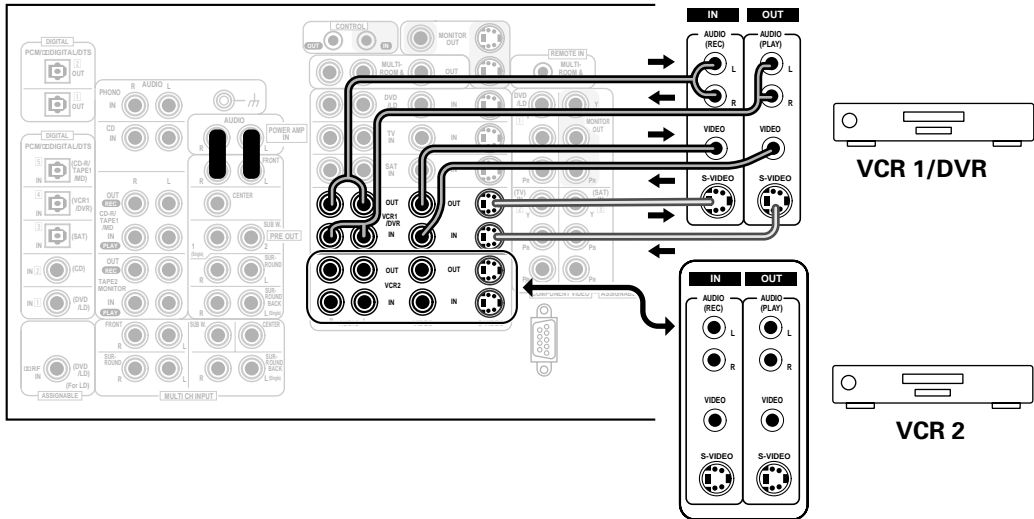

Connecting a Video Component to the Front Panel

Connect a portable DVD player, video game console or any video component to the front panel as show here. Front video connections are accessed via the front panel input selector as "VIDEO."

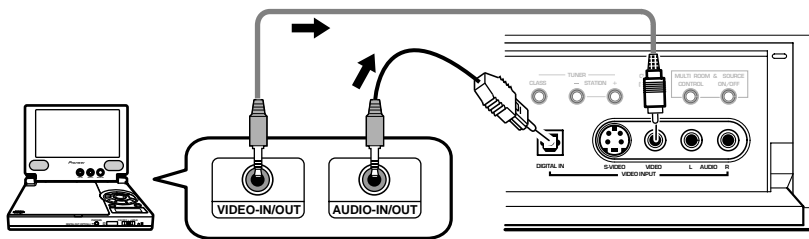

Be careful! For portable DVD players you will need a specialized optical cord (for the audio) that has a mini optical plug on one end and a regular optical plug on the other.



You cannot assign the name of the digital input on the front panel. It will always appear as "VIDEO" in the receiver's display. See page 88 for more information on "Assigning the Digital Inputs".

Connecting Satellite TV (SAT) Components

Hook up the video signal with either component video, S video, or composite video cords, depending on how you connected the receiver to your TV (see p.16).

For the audio signal, in order to use digital soundtracks broadcast you must hook up a digital input. Use either a coaxial or optical cable, it doesn't matter which (see p.22-23). We recommend hooking up your audio with analog cables as well (see below).

Before making or changing the connections, switch off the power and disconnect the power cord from the AC outlet.

*The arrows indicate the direction of the TV signal.

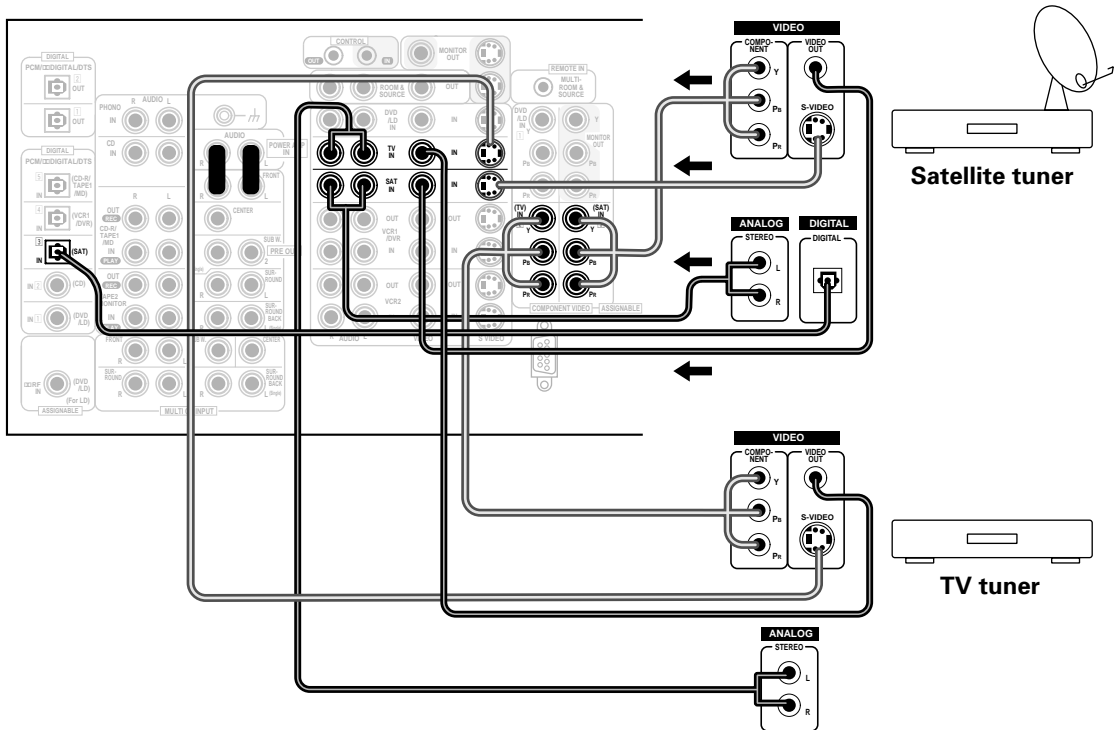

- If your component video connections are different from the default settings, you will need to assign them with "Assigning the Component Video Inputs". See page 89 for how to do this.
- If your digital connections are different than the default settings you will need to assign the digital jacks to the proper component(s) with the "Assigning the Digital Inputs" procedure. See page 88 to do this.

Connecting Analog Audio Components

Connect your audio components to the jacks as shown below. These are all analog connections and your analog audio components (turntable, cassette deck) use these jacks. Remember that for components you want to record with you need to hook up four plugs (a set of stereo ins and a set of stereo outs), but for components that only play (like a turntable) you only need to hook up one set of stereo plugs (two plugs). If you want to record to/from digital components (like a CD-R) to/from analog components you must hook up your digital equipment with these analog connections.

Before making or changing the connections, switch off the power and disconnect the power cord from the AC outlet.

*The arrows indicate the direction of the audio signal.

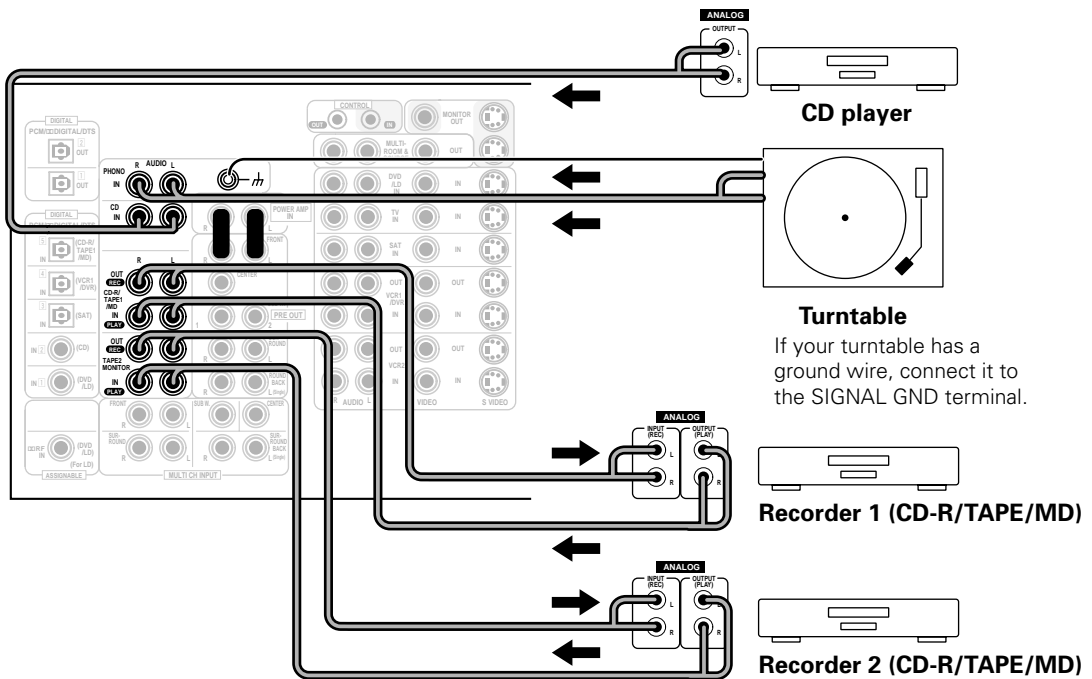

Don't hook up any other component to the PHONO jacks other than a turntable. It could damage the equipment. If your turntable has a phono pre-amplifier (most do not) please hook it up to an input other than PHONO.

■ Audio cords

Use (RCA) audio cords (not supplied) to connect the audio components.

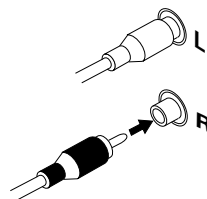

Connect red plugs to R (right) and white plugs to L (left).

Be sure to insert completely.

Cassette deck placement

Depending on where the cassette deck is placed, noise may occur during playback of your cassette deck which is caused by leakage flux from the transformer in the receiver. If you experience noise, move the cassette deck farther away from the receiver.

Connecting to the Multi Channel Analog Inputs (DVD-A or Super Audio CD compatible player)

If you have a DVD-A or Super Audio CD compatible player, or are using an external Dolby Digital/DTS decoder, connect it to the multichannel analog inputs as shown below. Note that if your DVD-A, Super Audio CD compatible player or decoder which doesn't have surround back outputs, it is possible to create a 7 channel environment with the "MULTI CH IN SELECT" feature on page 94.

Before making or changing the connections, switch off the power and disconnect the power cord from the AC outlet.

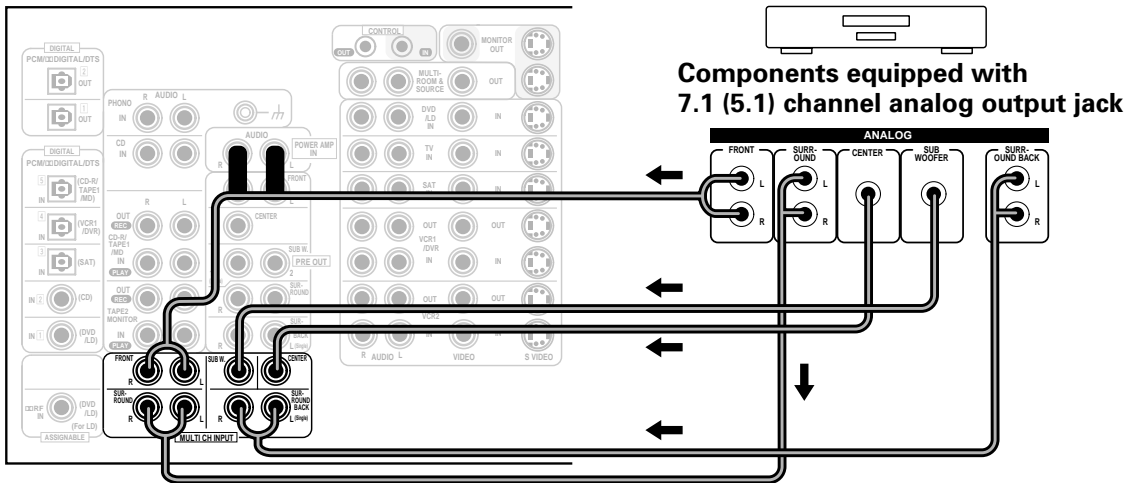

If you use only one surround back input hook up the left one.

Connecting Digital Audio Components

Connect your digital components as shown below. The VSX-47TX has two coaxial, three optical and one **RF** inputs for a total of six digital inputs. In order to use digital soundtracks like Dolby Digital or DTS (among others) you need to make digital audio connections. You can do this by either a coaxial or an optical connection (you don't need to do both). The quality of these two types of connections is the same but since some digital components only have one type of digital terminal, it is a matter of matching like with like (for example, the coaxial out from the component to coaxial in on the receiver). A DVD/LD player or LD player should also be connected to the special **RF** jack (if the LD has one).

Hook up your digital equipment in accordance with this receiver's default settings (see next page) unless you want to, or need to, change them. To do this see "Assigning the Digital Inputs" on p.88 .

There are two optical digital out jacks (the CD recorder is connected to one in the diagram below). If you connect this to the optical input on a digital recorder (currently these include MD, DAT and CD-R) you can make direct digital recordings with this unit.

We also recommend hooking up your digital components to analog audio jacks (see p.20) in order to make recordings (some digital sources may be protected against making digital copies).

Before making or changing the connections, switch off the power and disconnect the power cord from the AC outlet.

*The arrows indicate the direction of the audio signal.

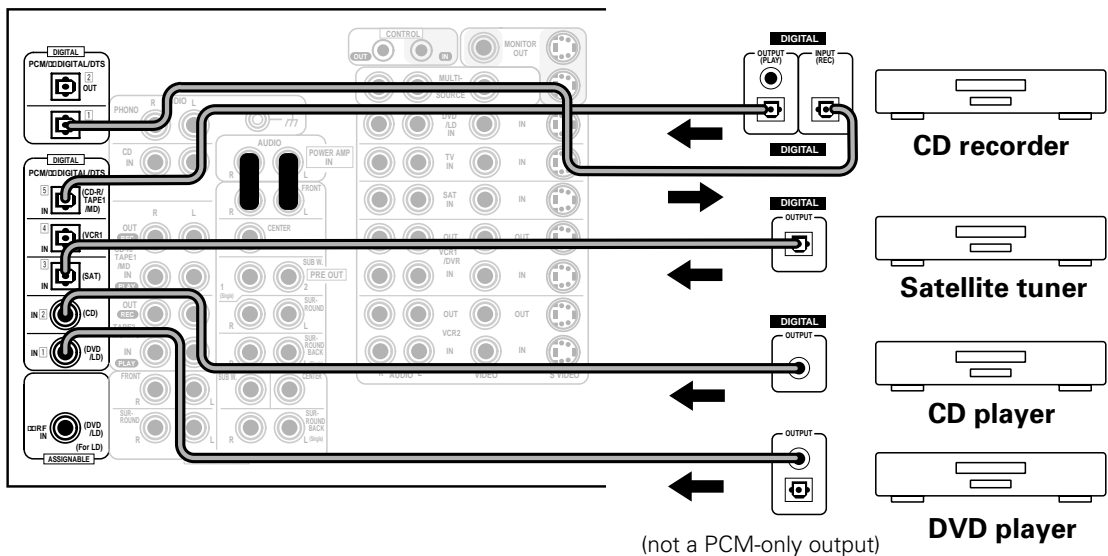

■ Coaxial cords/Optical cables

Commercially available digital audio coaxial cords (standard video cords can also be used) or optical cables (not supplied) are used to connect digital components to this receiver.

Be sure to insert completely and in the case of the optical cable, right-side up. If it is inserted improperly it can break the shutter on the optical terminal (this won't, however, affect the connection or insertion of an optical cable).

**Coaxial cord
(or standard [composite]
video cord)**

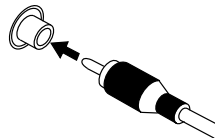

Optical cable

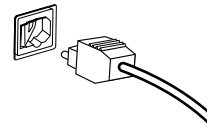

Digital Input Default Settings

Unlike analog connections, the jacks for digital connections are not dedicated to one type of component, they can be used freely. Thus you must tell the receiver what digital component is connected to which jack so your components will be in sync with the names on the remote control buttons and the like. To avoid having to assign the digital inputs you can hook up your equipment in accordance with the receiver's default settings.

The default settings are:

DIGITAL IN 1 (coaxial): DVD/LD

DIGITAL IN 2 (coaxial): CD

DIGITAL IN 3 (optical): SAT

DIGITAL IN 4 (optical): VCR1/DVR

DIGITAL IN 5 (optical): CD-R/TAPE 1/MD

RF IN (coaxial): DVD/LD

See "Assigning the Digital Inputs" on p.88 if the way you hook up your equipment is different from the default settings listed here.

Connecting Your Equipment

Connecting the Radio Antennas

Connect the supplied FM wire antenna and the AM loop antenna to the ANTENNA terminals as shown below. These antennas should provide adequate reception quality in most cases, but connecting outdoor antennas should noticeably improve sound quality.

Before making or changing the connections, switch off the power and disconnect the power cord from the AC outlet.

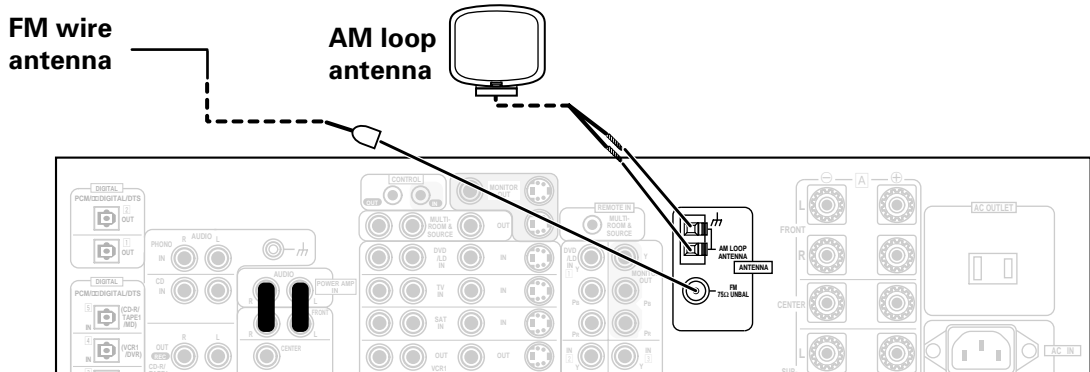

■ AM loop antenna

- 1 Assemble the antenna.
- 2 Twist exposed wire strands together and insert.
- 3 Attach to a wall, etc. (if desired) and face toward the direction providing the best reception.

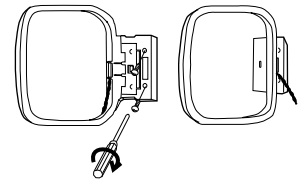
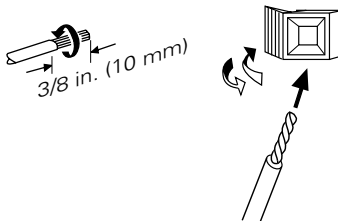
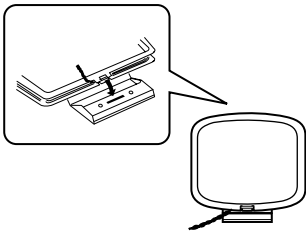

Using outdoor antennas

■ To improve FM reception

Connect an external FM antenna.

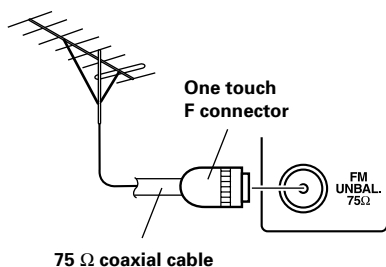

■ To improve AM reception

Connect a 15 to 18 feet (5 – 6 meter) length of vinyl-coated wire to the AM LOOP ANTENNA terminal in addition to the supplied AM loop antenna.

For best possible reception, suspend horizontally outdoors.

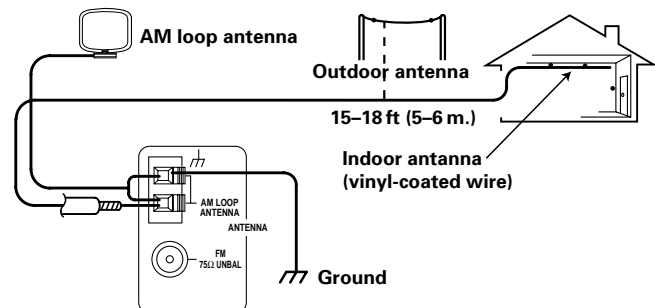

Connecting Speakers

We recommend a full complement of seven speakers and a subwoofer as shown here but, naturally, everyone's home setup will vary. Simply connect the speakers you have in the manner described below. The VSX-47TX will work with just two stereo speakers (called "front" speakers in the diagram) but it is desirable to have at least three speakers (two "front" speakers and a "center" speaker).

One of the latest features of home theater is the use of surround back speakers. These speakers add even greater realism in movie sound effects and some new discs with soundtracks in Dolby Digital or DTS incorporate these channels. See the next page for speaker placement.

In general, make sure you connect the speaker on the right to the R terminal and the speaker on the left to the L terminal. Also make sure the positive and negative (+/-) terminals on the receiver match those on the speakers.

Before making or changing the connections, switch off the power and disconnect the power cord from the AC outlet.



- If you only have one surround back speaker hook it up to the left surround back terminal.
- The VSX-47TX has two speaker systems, A & B. If you are planning on setting up another set of speakers (speaker system B), refer to "Speaker System B Setup" on page 70.
- If you use a THX certified subwoofer use the THX INPUT jack on the subwoofer (if your subwoofer has one) or switch the filter position to THX on your subwoofer.

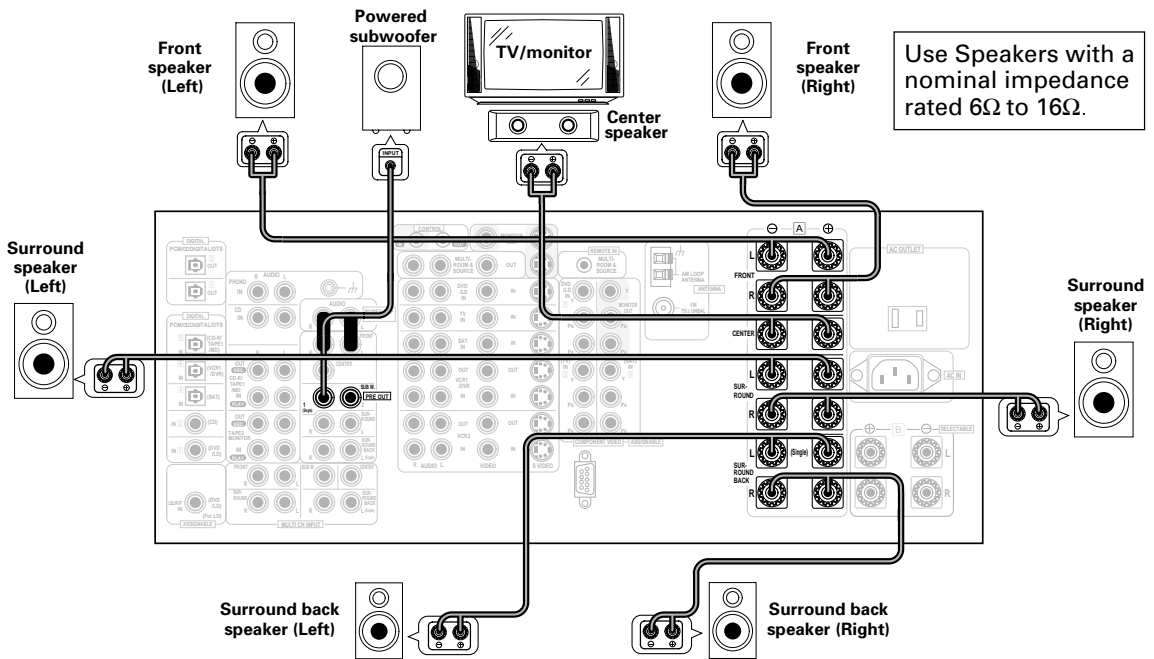

PREPARATION

■ Speaker terminals

- ① Twist exposed wire strands tightly together.
- ② Loosen speaker terminal and insert exposed wire.
- ③ Tighten terminal.

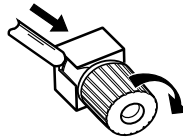
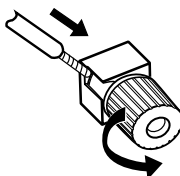
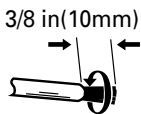

The speaker terminals also accept single banana plugs. (Refer to speaker manual for details.)

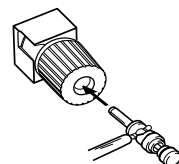

Connecting Your Equipment

Placing Your Speakers

Proper speaker placement is essential to realize the best sound from your system. The diagram and tips given here are just a rough guide, for more information see page 102 & 103. Also, it is very important for speaker placement to read the instructions that come with your speakers so please be sure to do so.

Speaker placement

If you have a multiple speaker arrangement the placement of the speakers is extremely important. To achieve the best possible surround sound, install your speakers as shown below. Make sure all speakers are installed securely to prevent accidents and improve sound quality. Some speakers are designed to be floor-standing but others benefit greatly from speaker stands which raise them off the floor. Be sure to read your speaker manuals for the best placement of the speakers.

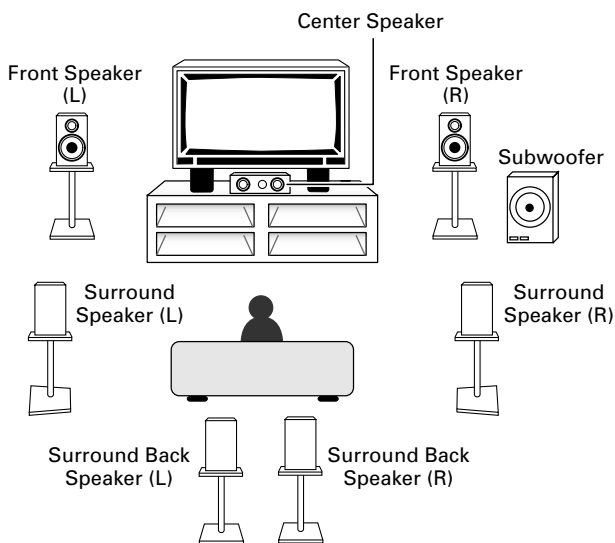

- When installing speakers near the TV, we recommend using magnetically shielded speakers to prevent distortion in the color of the TV screen. If you do not have magnetically shielded speakers and notice discoloration of the TV screen, place the speakers farther away from the TV.
- Install the center speaker above or below the TV so that the sound of the center channel is localized at the TV screen.
- THX recommends that if you have two surround back speakers place them close together. Then you can take advantage of the ASA feature (see p.97,101).
- See page 102 & 103 for more detailed advice on speaker placement.

CAUTION:

When installing the center speaker on top of the TV, be sure to secure it with suitable means.

AC Power Cord

Plug in the power cord first to the receiver and then to the wall outlet after you have finished hooking up the rest of your equipment.

CAUTION!

- Don't use any other power cord than the one supplied with this unit.
- The equipment should be disconnected by removing the mains plug from the wall socket when not in regular use, e.g. when on vacation.

AC Outlet [switched 100 w max]

Power supplied through this outlet is turned on and off by this unit's STANDBY/ON button. Total electrical power consumption of connected equipment should not exceed 100 W.

CAUTION!

- Do not connect appliances with high power consumption such as heaters, irons, or television sets to the AC OUTLET in order to avoid overheating or fire risk. This can cause the amplifier to malfunction.
- **DO NOT CONNECT A MONITOR OR TV SET TO THIS UNIT'S AC OUTLET.**

Displays & Controls

Remote Control

This page describes the buttons on the remote control used to operate the receiver.

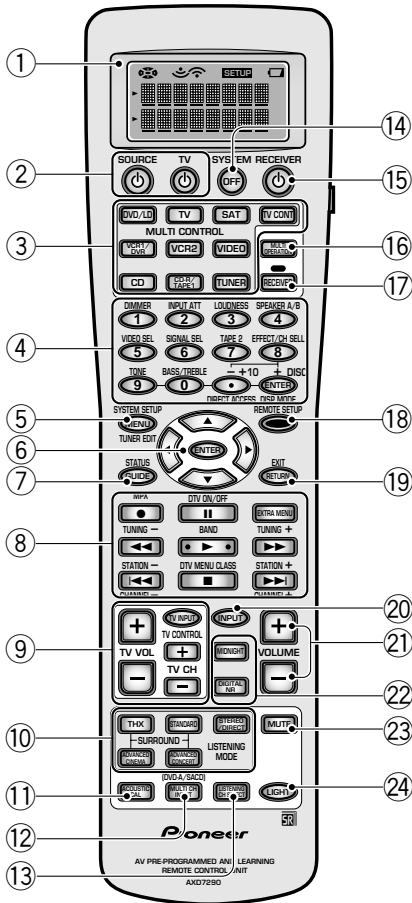

① Remote Control Display Screen

② SOURCE button

Use this button to turn off other components. You must input the preset code in order to use this function (see page 62-63).

TV button

This is a dedicated TV button. Use it to turn on/off your TV.

③ MULTI CONTROL buttons

These buttons are the basic controls that switch the mode of the receiver and the remote control, which allows you to control your other components.

TV CONT: Press so that the remote control can operate the TV control commands.

④ Number buttons

These can be used for many purposes depending on the mode of the remote control. When the in receiver mode the buttons operate as below:

Display DIMMER (see p.56)

Use to adjust the brightness of the receiver's display.

INPUT ATT. button (see p.54)

Use to lower the input level of an analog signal that is too powerful, thus causing the receiver to distort. In this case the OVER (overload) indicator will be flashing furiously.

LOUDNESS button (see p.51)

Switches the LOUDNESS mode on or off (for all modes except THX and MULTI CH IN).

SPEAKER A/B button (see p.71)

Use to select the speaker system. A is the primary setting. The button cycles through the speaker systems as follows: A⇒B⇒A&B⇒off. Different conditions apply when bi-amping the speakers. For this case refer to page 71.

VIDEO SELECT button (see p.55)

Use to toggle between the different video input possibilities.

SIGNAL SELECT button (see p.45)

Press SIGNAL SELECT repeatedly to select one of the following:

ANALOG: To select an analog signal.

DIGITAL: To select a digital signal

RF: To select a RF signal

AUTO: This is the default. If there are analog, digital and RF signals input, the receiver automatically selects the RF signal. If there are analog and digital signals input, the digital will be selected.

TAPE 2 MONITOR button (see p.54)

Selects the tape deck (or MD recorder, etc.) connected to the TAPE 2 MONITOR inputs/ outputs. Allows monitoring of a recording as it's being made.

EFFECT/CH SEL. button

Switches between all channels and EFFECT in ADVANCED mode. You can then use the + and - buttons to adjust the sound.

TONE buttons

This button has two functions. Firstly, it switches between TONE on and TONE bypass, which goes around the tone circuitry. Secondly, you need to press this button before using the BASS & TREBLE buttons.

BASS/TREBLE buttons (see p.52)

Use to choose the high or low frequencies to adjust.

(+/-) buttons

Use to adjust the high and low frequencies, effect level and channel level.

⑤ **SYSTEM SET UP button**

Use for all system setups, including the speaker and sound systems. For more information see "Setting up for Surround Sound" starting on p.35. For other components this button will give you the base or top menu.

⑥ **▲/▼/◀/▶/ENTER buttons**

These buttons can be used for a variety of operations in the SYSTEM SETUP menu. These buttons are used to control the menus for other components when in those modes (DVD, digital TV tuner, satellite tuner, cable tuner, etc.). In TUNER mode, they can select a station and/or a frequency.

⑦ **STATUS button see p.56)**

Use to display the present mode the receiver is in and another settings. For a digital TV tuner this button will call up the GUIDE menu.

⑧ **Command button for other components (see p.66-67)**

Use these buttons to control other components you selected with the MULTI CONTROL buttons. You must input the preset code in order use this function (see page 62-63).

⑨ **TV CONTROL buttons**

The following buttons are used to control the TV only and can be used once they are preset to control your TV.

TV INPUT: Press to select the input source for the TV.

TV CH +/- : Use these buttons to change the channel of the TV.

TV VOL +/- : Press to control the volume of the TV.

⑩ **LISTENING MODE buttons (see p.43-44)**

STEREO/DIRECT: Switches the receiver into STEREO mode if it was in a different listening mode or toggles between DIRECT and STEREO mode (see p.46).

THX: Press to put the receiver into Home THX listening mode (see p.47).

STANDARD: Press to put the receiver into STANDARD listening mode (see p.46).

ADVANCED CINEMA: Press to put the receiver into ADVANCED CINEMA listening mode (see p.48).

ADVANCED CONCERT: Press to put the receiver into ADVANCED CONCERT listening mode (see p.49).

⑪ **ACOUSTIC CAL. button (see p.41, 50)**

Press to switch on/off and select the type of acoustic calibration EQ.

⑫ **MULTI CH INPUT button (see p.53, 94)**

Use this button to select the component (for example, a DVD-Audio player) you have hooked up to the MULTI CH INPUT terminals.

⑬ **LISTENING CH SELECT. (see p.44)**

Use this button to select a listening channel (5.1, 7.1, AUTO).

⑭ **SYSTEM OFF button (see p.81)**

This button turns off components in two ways. First, when pressed it will turn off all PIONEER components. Secondly, any component that has programmed into the SYSTEM OFF settings will be turned off.

For example : If you programmed power off in the SYSTEM OFF settings for your TV and VCR, pressing the SYSTEM OFF button will turn off these components even if they are not PIONEER products.

⑮ **⏻ RECEIVER (standby/power on) button**

Press to turn power of the receiver on or to standby (off).

- ⑩ **MULTI OPERATION button**
Use this button to start the MULTI OPERATION mode. See p.79-80 for how to program and use the MULTI OPERATION mode.
- ⑪ **RECEIVER button**
Use this button to switch the remote control into receiver mode in order to get certain receiver functions or do receiver setups.
- ⑫ **REMOTE SETUP button.**
Use to customize the remote control functions and the remote control itself. (See "Setting Up Remote Control of Other Components" starting on p.62).
- ⑬ **EXIT button**
When you are in a receiver setup operation this button will exit from SYSTEM SETUP procedures. When you are using your DVD menu screen this button acts the same as the DVD player's "Return" button. When you are using cable tuners, satellite tuners or digital TV tuners this button will either exit you from the menu screen or act like a "Return" button above, depending on the maker of the unit.
- ⑭ **INPUT button**
Press to select an input source. The button will cycle through all the possible sources.
- ⑮ **VOLUME (+/-) buttons**
Use to raise or lower the volume of the receiver.
- ⑯ **MIDNIGHT button (see p.51)**
Switches the MIDNIGHT listening mode on or off (for all modes except THX and MULTI CH IN).
- DIGITAL NR button (see p.50)**
Switches the DIGITAL NR on or off (for all modes except THX and MULTI CH IN).
- ⑰ **MUTE button**
Press to mute or restore the volume.
- ⑱ **LIGHT button**
Use to light the remote control display and buttons.

Back Panel

All the terminals on the back panel are explained and/or referenced here.

5: U-shaped connectors

Don't remove the U-shaped connectors unless you plan to connect an external amp to this receiver.

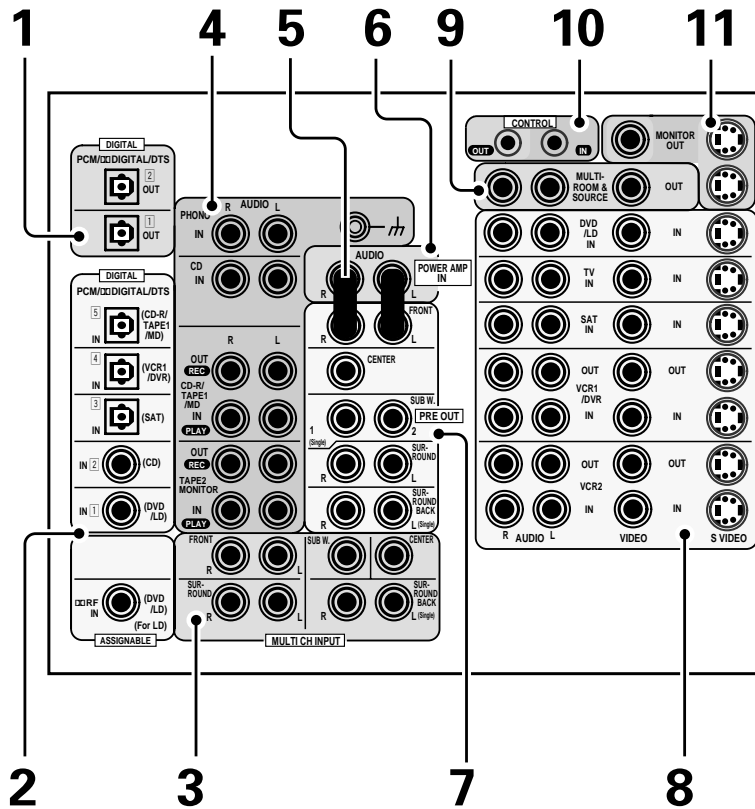

1 DIGITAL OUT terminals (see p.22)

Use these terminals to output the signal from a DVD, CD player or any other kind of digital player.

2 DIGITAL IN terminals (see p.22)

Use these terminals to input the signal from a DVD, CD player or any other kind of digital player. To be able to play Dolby Digital and other surround soundtracks you need to make digital connections. To do this use the digital terminals here. If you don't connect as per the default settings (see p.23) you need to complete "Assigning the Digital Inputs" (see p.84).

3 MULTI CH INPUT terminals (see p.21)

Use these terminals to input a multichannel surround signal (for example, a DVD-Audio signal) in an analog fashion. These are analog jacks.

4 Analog input/output terminals (connect analog components here, see p.20)

Use these terminals to input/output the audio signal from analog components (like a cassette deck or turntable). These are analog jacks.

5 U-shaped connectors

6 POWER AMP IN terminals (see p.73)

Use this terminal to connect an external power amp to this receiver. Remove the U-shaped connectors only if you plan to do so.

7 PRE OUT analog terminals (connect an amplifier here, see p.72, 73)

Use these terminals to output the audio signal from this amplifier to a different amplifier if that's how you choose to set up your system. Remove the U-shaped connectors only if you plan to do so.

8 Video components in/out terminals

Input/output signals from you video components (DVD, VCR, TV tuners, SAT tuners, etc.) here. (see number 2 here and p.17-19).

9 MULTI-ROOM & SOURCE OUT terminals (see p.74-78).

These terminals output the audio & video signal to a sub-system in a secondary room. These are analog jacks.

10 CONTROL IN/OUT terminal

You can use this jack to hook up other PIONEER equipment, that bears the mark, so

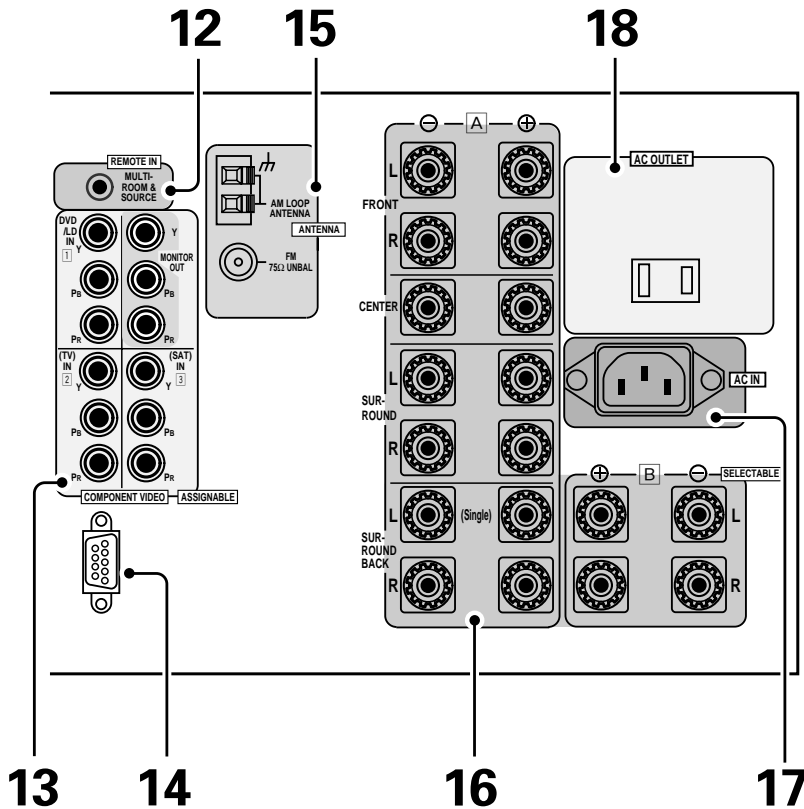

PREPARATION

that you can control them all pointing the remote control(s) at one remote sensor.

11 MONITOR OUT terminals (connect a TV or monitor here, see p.16)

Use these terminals to output a video signal to a TV or monitor.

12 MULTI-ROOM & SOURCE REMOTE IN terminals

Use these terminals to hook up a sub-system in a secondary room. This hook up requires a separately sold IR receiver and allows you to use the receiver to hear different audio sources in different rooms.

13 COMPONENT VIDEO IN terminals (see p.16-17)

Use these terminals to hook up the video connections of your video components with this high quality method. Your components will have to have the terminals as well to take advantage of this kind of connection. If you use these terminals you need to complete "Assigning the Component Video Inputs" (see p.89).

14 RS-232C Connection

This is a future-oriented port that has the possibility on inputting and/or outputting information to/from the receiver in the future.

15 Radio antenna terminals

Hook up antennas for the radio tuner built into the receiver here.

16 SPEAKERS terminals (see p.25)

Use these terminals to connect speakers to the receiver. There are two speaker systems on this receiver A & B. The A system is the one that handles surround sound and is fed by the surround and surround rear speakers. If you want to use alternative connections like bi-amping and bi-wiring see page 70.

17 AC IN (Power In)

Hook up the power cord to this terminal.

18 AC OUTLET

Hook up an external component to the power supply of this receiver. Only do this with audio or video components being used in this system and never hook up heavy equipment (like TVs, heaters, air conditioners, refrigerators, etc.) to this receiver.

Front Panel

All the controls on the front panel are explained and/or referenced here. To open the front panel push gently on the lower third of the panel.

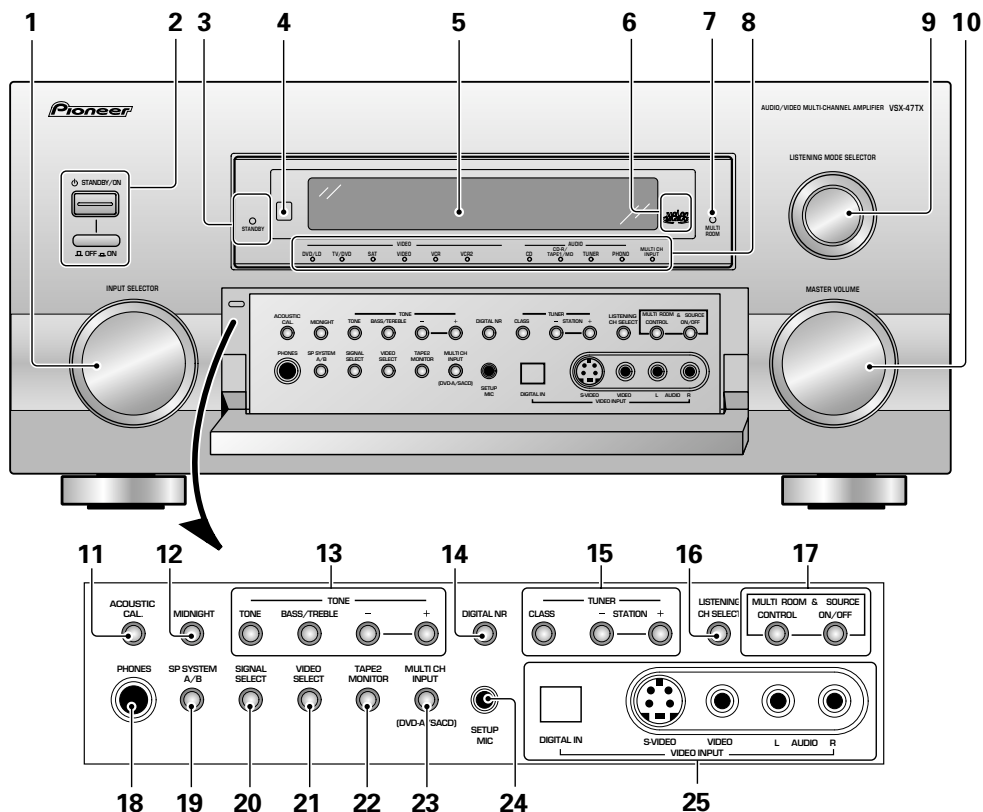

1 INPUT SELECTOR dial

Turn to select a source component. (You can also use to select a source in the MULTI-ROOM & SOURCE mode.) The input indicators show the current component.

2 STANDBY/ON button—power ON/ OFF button

Press to switch the receiver ON or into STANDBY mode or switch OFF.

3 STANDBY indicator

Lights when the receiver is in STANDBY mode. (Please note that this receiver consumes a small amount of power [0.65 W] in the standby mode.)

4 Remote sensor

Receives the signals from the remote control.

5 Display (See p.34)

6 MCACC indicator (see p.14-15, 35-41)

Lights when the ACOUSTIC CAL EQ is on. (After the Auto Surround Sound Setup has been completed the ACOUSTIC CAL EQ is set on and this display will light.)

7 MULTI-ROOM indicator (see p.77 & 78)

Shows whether the multi-room function is active or not.

8 INPUT indicators

Shows which source component is selected. The MULTI CH INPUT indicator lights up when a component connected to the MULTI CH INPUT is selected.

9 LISTENING MODE SELECTOR dial (see p.44)

Turn and push to select a listening mode.

10 MASTER VOLUME dial

Adjusts the overall receiver volume.

11 ACOUSTIC CAL. button (see p.50)

Use to switch on and off the Acoustic Calibration EQ.

12 MIDNIGHT button (see p.51)

Use to switch the receiver into MIDNIGHT mode.

13 TONE control buttons

TONE button

This button switches between TONE ON and TONE BYPASS, which bypasses the tone circuitry.

BASS/TREBLE button (see p.52)

Use to select whether the bass or treble will be adjusted.

(-/+) buttons (see p.52)

Use to adjust the frequency levels.

14 DIGITAL NR button (see p.50)

Switches the DIGITAL NR on or off (cannot be used in THX or MULTI CH IN modes).

15 TUNER control buttons (see p.57-61)

CLASS button

Press repeatedly to switch the preset station classes.

(-/+) buttons

Use to choose programmed radio stations.

16 LISTENING CH SELECT button (see p.44)

Use this button to select the number of channels used for playback (5.1, 7.1 or AUTO).

17 MULTI-ROOM & SOURCE button (see p.74-78)

Press to use the multi room feature (requires an optional PIONEER Multi-Room Remote Sensor Unit MR-100 or another IR receiver).

CONTROL button (see p.74-78)

Used together with the INPUT SELECTOR to select the function or use with the MASTER VOLUME to select the volume of the MULTI ROOM system.

ON/OFF button (see p.74-78)

Use to switch Multi-room function on or off.

18 PHONES jack

Connect headphones for private listening (no sound will be heard through the speakers).

19 SP SYSTEM A/B button (see p.71)

Use to select the speaker system. A is the primary setting. The button cycles through the speaker systems as follows: A⇒B⇒A&B⇒off. Different conditions apply when bi-amping the speakers. For this case refer to page 70.

20 SIGNAL SELECT button (see p.45)

Use to select the type of signal being input into the receiver. Press SIGNAL SELECT repeatedly to select one of the following:

ANALOG – To select an analog signal.

DIGITAL – To select an optical or coaxial digital signal.

RF – To select a RF signal.

AUTO – This is the default. If there are analog, digital and RF signals input, the receiver automatically selects the RF signal. If there are analog and digital signals input, the digital will be selected.

21 VIDEO SELECT button

Switches the receiver between the various types of video input.

22 TAPE 2 MONITOR button

Selects the tape deck (or CD-R, etc.) connected to the TAPE 2 MONITOR inputs/outputs. Allows monitoring of a recording as it's being made.

23 MULTI CH INPUT button

Selects the component (for example, a DVD-Audio player) you have hooked up to the MULTI CH INPUT terminals.

24 SET UP MIC jack (see p.13)

Plug in the set up mic (the remote control) here. This is very important for setting up your system to get proper surround sound.

25 Front VIDEO INPUT jacks (see p.18)

DIGITAL IN

Digital input for connecting a game console, DVD player, video camera (etc.), that has an optical digital connection.

S VIDEO

Video input for connecting a video camera (etc.), that has an S video out.

RCA VIDEO / AUDIO (L/R)

Video input for connecting a video camera, etc. That has standard RCA video/audio outputs.

Display

All the display information is explained and/or referenced here.

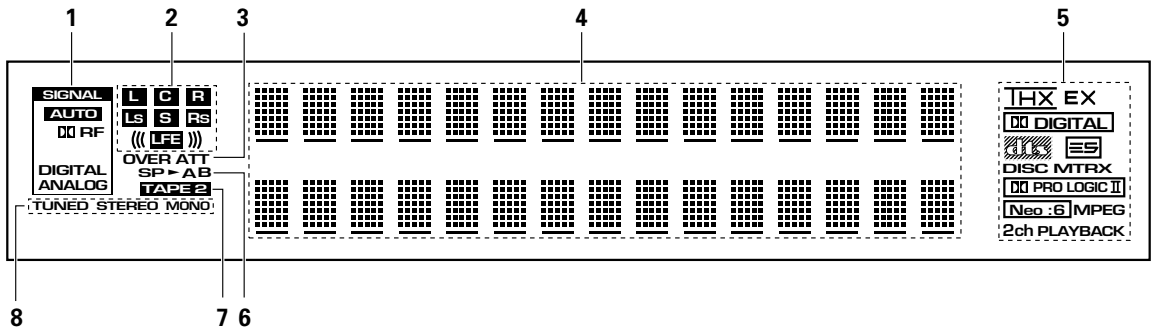

1 SIGNAL SELECT indicators

Light to indicate the input signal you selected.

ANALOG: Lights when analog signals are assigned.

DIGITAL: Lights when digital audio signals are selected.

DQ RF: Lights when **DQ RF** signals are assigned.

AUTO: Lights when the receiver is set to select the input signal automatically.

2 Program Format indicators

For Dolby Digital or DTS sources : These indicators change according to which channels are active in the source. When all three **LS** (left surround), **S** (surround) and **RS** (right surround) light at the same time it means a source with a 6.1 channel playback flag is being used.

L – Left front channel.

C – Center channel.

R – Right front channel.

LS – Left surround channel.

S – Surround channel (mono).

RS – Right surround channel.

LFE – Low Frequency Effects channel.

((())) – Lights when LFE signal is input.

3 Analog level indicators

OVER – This lights if the signal is in danger of distorting for analog source signals. Press INPUT ATT on the front panel to lower the signal level.

ATT – Lights when INPUT ATT is used to reduce the level of the analog source signal.

4 Character display

Shows current mode, status, etc.

5 Digital format indicators

DQ DIGITAL : Lights when a Dolby Digital signal is detected.

DTS: Lights when a DTS signal is detected.

MPEG: Lights when an MPEG signal is detected.

THX: Lights when the HOME THX mode is selected.

EX: Lights during Surround EX matrix processing.

ES: Lights during DTS ES processing.

DISC: Lights during DTS ES discrete processing

MTRX: Lights during DTS ES matrix processing

DQ PRO LOGIC II: Lights during Dolby Pro Logic II processing.

NEO:6: Lights during NEO:6 processing.

2CH PLAYBACK Lights during two-channel playback.

6 Speaker indicators

Light to indicate the current speaker system, A and/or B.

7 TAPE 2 indicator

Lights when the TAPE 2 monitor is on.

8 TUNER indicators

MONO: Lights when the tuner is set to receive FM broadcasts and when selected MPX mode.

STEREO: Lights when a FM stereo broadcast is received in the auto stereo mode.

TUNED: Lights when a broadcast is received.

Setting Up for Surround Sound

To ensure the best possible surround sound, complete the following setup operations. Some of these are the same (and take precedence over) the settings you made in the Quick Start Guide, so consider if the ones you made at that time were adequate. If you feel they were, move on to the next setting here. You only need to make these settings once (unless you change the placement of your current speaker system or add new speakers, etc.). These setup operations use on-screen displays (OSDs) on your TV to display the settings and choices so be sure your TV and receiver are properly hooked up and that your TV is set to this receiver. You need to connect the remote control, with its built in mic, to the front panel of the receiver so that it can measure the sound and ensure the proper settings. For more information on the remote control hookup see page 13.

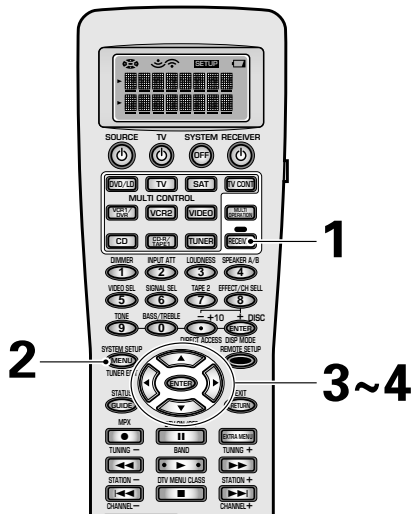

1 Turn on the receiver and your TV, press the RECEIVER button on the remote control.

Make sure your TV is connected and set to the receiver.

2 Press the SYSTEM SETUP button.

The menu possibilities appear on your TV.

3 Use the ▲▼ and buttons to select SURROUND SETUP. Press ENTER.

4 Follow the order below to set up your speakers for better sound. Use the ▲▼ and ◀▶ buttons to navigate through the menus. When you have the setting you want in a particular menu, press ENTER.

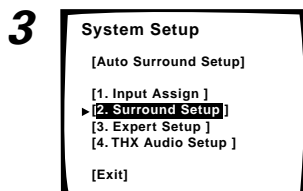

In each mode, the current settings are displayed. We suggest you adjust all these settings when you first hook up the receiver. That gets them out of the way and you won't need to return to this setting mode unless you change your home set up by adding new speakers (etc.).

SPEAKER SYSTEMS (See p.36-37)

Use to specify the type and number of speakers you connected.

CHANNEL DELAY (See p.38)

You must add distance settings to all your speakers for the most realistic surround sound. Adding a slight delay to some speakers enhances sound separation and is particularly important for achieving a surround sound effect. You need to figure out the distance from your listening position to your speakers to add the proper delay.

CHANNEL LEVEL (See p.39-40)

Use to balance the volumes of your different speakers.

ACOUSTIC CALIBRATION (See p.41)

This setting is a kind of room equalizer for your speakers.

SPEAKER SYSTEMS

The following steps show you how to select the correct setup for the type and number of speakers you connected. Most importantly, you need to decide how to route the sound for all the speakers you connected. To do this select the size of the front, center, surround and surround back speakers (if you hooked them up). It is important to make these settings as accurately as possible or, in some cases, you may not get the full soundtrack from a disc. The auto setup from the microphone in the remote control may not properly assess the size of your speakers if there is background noise, from an air conditioner or refrigerator, for example. If necessary try different possible settings manually.

Use the information below to complete the steps that follow and set up the receiver to match the speakers you have hooked up. Make sure the microphone is hooked up to the front panel and in the appropriate position before starting. See page 13 for more information on setting up the microphone.

FRONT (default setting is SMALL)

Select SMALL to send bass frequencies to the subwoofer. Select LARGE if your speakers will reproduce bass frequencies effectively or if you did not connect a subwoofer. (If you select SMALL for the front speakers the subwoofer will automatically be switched YES. Also, the center and surround speakers cannot be set to LARGE if the front speakers are set to SMALL. In this case, all bass frequencies are sent to the subwoofer.)

CENTER (default setting is SMALL)

- Select LARGE if your speaker will reproduce bass frequencies effectively.
- Select SMALL to send bass frequencies to the other speakers or subwoofer.
- If you did not connect a center speaker, choose NO. In this case, the center channel is output from the front speakers.

SURROUND (default setting is SMALL)

- Select LARGE if your speakers will reproduce bass frequencies effectively.
- Select SMALL to send bass frequencies to the other speakers or subwoofer.
- If you did not connect surround speakers choose NO. In this case, the sound of the surround channels is output from the front and center speakers.
- Remember, If you select SMALL for the front speakers, the surround and surround back speakers can only be set to SMALL.

SURROUND BACK (default setting is SMALL X2)

- Select the number of surround back speakers you have. You can choose one speaker, two, or none.
- If you select one, make sure that speaker is hooked up to the left surround back terminal.
- Select LARGE if your speakers will reproduce bass frequencies effectively.
- Select SMALL to send bass frequencies to the other speakers or subwoofer.
- If you did not connect surround back speakers choose NO.
- If the front speakers or the surround speakers are set to SMALL, the surround back speakers will automatically be set to SMALL.
- If you choose THX in step 2 then the surround back speakers can only be set to SMALL (X1 or)2, or NO.

SUBWOOFER (default setting is YES)

- Leave it selected if you connected a subwoofer.
- If you selected SMALL for the front speakers the subwoofer will automatically be set to on (you won't be able to choose NO or PLUS).
- If you did not connect a subwoofer choose NO. In this case, the bass frequencies are output from the front or surround speakers.
- Choose the PLUS setting if you want stronger reproduction of deep bass sounds.
- If you select PLUS the bass frequencies that would normally come out the front and center speakers are all routed to the subwoofer.

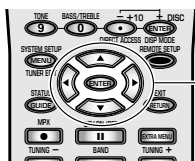

1 SPEAKER SYSTEMS should be selected. If it isn't use the ▲▼ buttons to select it. Press the ENTER button.

The setup possibilities appear on your TV.

1

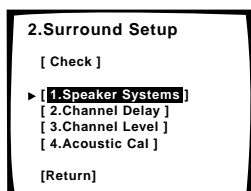

2 Use the ▲▼ buttons to select the speaker system setting.

Choose from :

MANUAL FREE : Sets all the speakers

MANUAL THX : Sets all the speakers to SMALL. The crossover frequency is fixed at 80kHz. You can only select the number of surround back speakers.

2

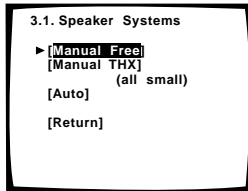

3,4

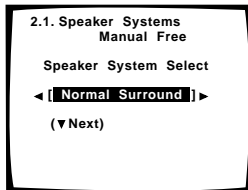

5,6

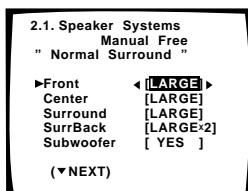

7

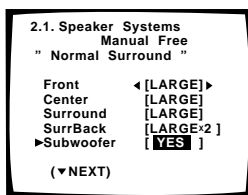

9

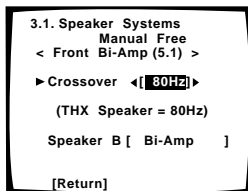

10

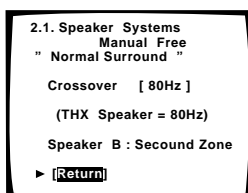

If you have a subwoofer and like lots of bass, it may seem logical to select LARGE for your front speakers and leave the subwoofer selected. This may not, however, yield the best bass results. Depending on the size and shape of your room you may actually experience a decrease in the amount of bass due to what is called "low frequency cancellations." If you have a subwoofer, listen to the bass response with the front speakers set to LARGE and SMALL alternatively and let your ears judge which sounds best. If you have a subwoofer, the safest option is to route all the bass sounds to it by selecting SMALL for the front speakers.

AUTO : All speakers are set automatically. (The remote control must be hooked up to the front panel in order to use this setting.)

For MANUAL FREE, select it and press **ENTER**. Then go to step 3.

For MANUAL THX, select it and press **ENTER**. Then go to step 3.

For AUTO, select it and press **ENTER**. Be prepared for loud test tones and make sure the room is free of ambient noise (see memo page 15). When you see **OK** on the OSD the setup is finished. Go to step 9.

3 Use the ◀ ▶ buttons to select either **NORMAL SURROUND** or **FRONT BI-AMP (5.1)**.

NORMAL SURROUND: For normal home theater use
FRONT BI-AMP (5.1): Settings for bi-amp (see p.70).

4 Use the ▼ button to go to the next screen.

5 With the ▲ ▼ buttons choose the set of speakers that you want to set.

If you selected **MANUAL THX** in step 2 set all speakers, except for surround back, to **SMALL**.

6 Use the ◀ ▶ buttons to choose the size and number for each set of speakers as well as **LARGE, SMALL, YES, NO** or **PLUS**.

7 Repeat steps 5 & 6 for all speakers channels.

8 Use the ▼ button to go to the next screen.

9 Use the ◀ ▶ buttons to choose a **Crossover Frequency of 50 Hz, 80 Hz, 100 Hz, 150 Hz or 200 Hz**.

Certain bass sounds will play back from the subwoofer if you selected it as **YES** (or **PLUS**), or from the front speakers if you selected them as **LARGE**. This setting decides where the cutoff will be between those bass sounds playing back from the speaker selected as above and the bass sounds for the entire soundtrack, which play back from all speakers used. If you selected **MANUAL THX** in step 2 the crossover frequency is fixed at 80kHz and this screen does not appear.

10 Use the ▲ ▼ buttons to select **RETURN** and press **ENTER**.

Next, proceed to **CHANNEL DELA Y** below.

If you want to change a setting before proceeding start over from step 1.

CHANNEL DELAY

Adding a slight delay to some speakers is necessary to achieve proper sound depth, separation as well as an effective surround sound effect. You need to figure out the distance from your listening position to your speakers to add the proper delay. The following steps show you how to set the delay time for each channel by specifying the distances from your listening position to each speaker. Once you specify the speaker distances (or it is done automatically through the AUTO selection, or in the Quick Start Guide), the receiver calculates the correct delay times automatically. If continuing from SPEAKER SYSTEMS go to step 1. If starting fresh, complete steps 1-3 in "Setting Up for Surround Sound" (p.35) first.

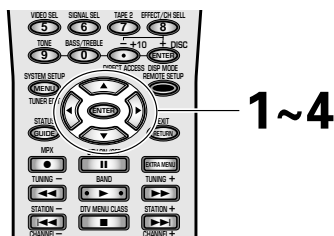

1 The CHANNEL DELAY should be selected. If it isn't use the ▲▼ buttons to select it. Press the ENTER button.

The setup possibilities appear on your TV

2 There are two ways to set the CHANNEL DELAY, MANUAL and AUTO. Select the method you'd like to use with the ▲▼ buttons and press ENTER.

MANUAL : In this way of setting the distance you choose the speaker and adjust the distance yourself.

AUTO : This way of setting the delay time is like that described in the Quick Start Guide (p.13–15). The levels are set automatically by the receiver as it outputs the test tones. For this setup you must have the mic on the remote control connected (see page 13).

WARNING : Be prepared! The test tones are output at a high volume level.
 MASTER VOLUME rotates to the reference position (0 dB) and the display on the receiver flashes TEST TONE. After a few seconds the test tone is output.

3 For MANUAL, select each speaker with the ▲▼ buttons. Use the ◀▶ buttons to add or subtract the distance in feet that the speaker is from your normal listening position.

Adjust the speaker distance in half foot increments from 0.5 to 45 feet (1 foot equals approximately 0.3 meters). The default setting is 10 ft.

4 When done select RETURN with the ▲▼ buttons and press ENTER.

Next, proceed to CHANNEL LEVEL below .

If you want to change a setting before proceeding Start over from step 1.

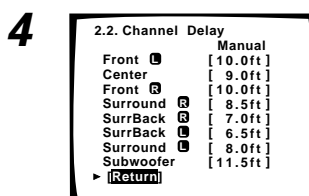
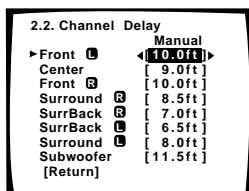
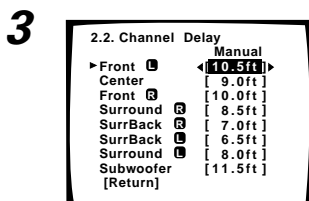
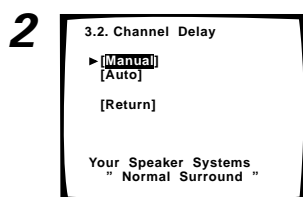
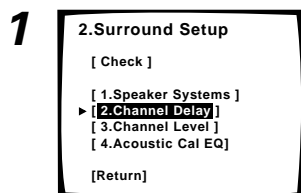

If you have two surround back speakers you can put them together, set them to the same distance and then use them get the benefit of ASA technology (see p.97, 101, 103).

CHANNEL LEVEL (channel balance)

The following steps show you how to balance the sound output level of your speakers. Proper speaker balance is essential for obtaining high quality surround sound. If continuing from CHANNEL DELAY go to step 1. If starting fresh, complete steps 1-3 in "Setting Up for Surround Sound" (p.35) first. If you're not sure of the best setting for your system, we recommend setting the CHANNEL LEVEL to AUTO.

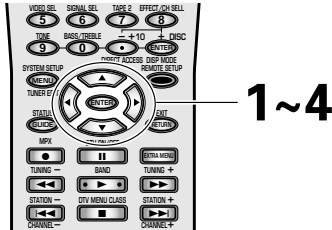

1 CHANNEL LEVEL should be selected. If it isn't use the ▲▼ buttons to select and press ENTER.

2 Use the ▲▼ buttons to select a channel level setting mode, then press ENTER.

Test tones will be output.

There are three ways to set the CHANNEL LEVEL: MANUAL; SEMI AUTO; AUTO.

MANUAL : For this setting method you move the test tone manually and adjust the channel level.

SEMI AUTO : In this setting the test tone moves by itself and you set the levels.

AUTO : This way of setting the levels is like that described in the Quick Start Guide (p.13). The levels are set automatically by the receiver as it outputs the test tones. For this setup you must have the mic on the remote control connected (see page 13).

WARNING : Be prepared! The test tones are output at a high volume level.

MASTER VOLUME rotates to the reference position (0 dB) and the display on the receiver flashes TEST TONE. After a few seconds the test tone is output.

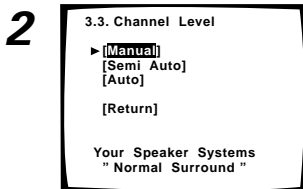
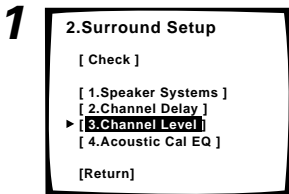

- If your subwoofer has a volume control, set it to the middle position before doing these operations.

3

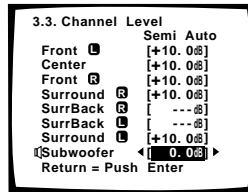
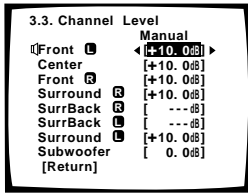

4

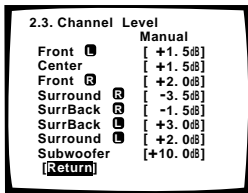

3 Adjust the level of each channel using the ◀▶ buttons (except for the AUTO setting where the adjustment is done automatically).

NOTE : The volume of the subwoofer test tone tends to sound lower than it actually is. You may need to adjust the level after testing with an actual soundtrack.

In MANUAL (manual test tone) mode

This mode lets you switch the test tone between each speaker manually with the ▲▼ buttons.

In SEMI AUTO (automatic test tone) mode

Adjust the level of a speaker as it's emitting the test tone. The tone will automatically switch between speakers after sounding for 2-3 seconds. The test tone is output in the following order:

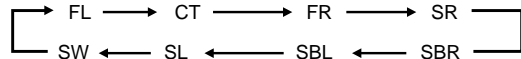

If you are using a Sound Pressure Level (SPL) meter

Take the readings from your main listening position and adjust the level of each speaker to 75 dB SPL (C-weighting /slow reading).

4 In MANUAL mode: When done select RETURN with the ▲▼ buttons and press ENTER. In SEMI AUTO mode: Press ENTER to exit the process

The display on the receiver will say RESUME and the MASTER VOLUME will return to its original position.

Next, proceed to Acoustic Calibration.



You can change the channel level of each speaker at any time by using the EFFECT CH/SEL. and +/- buttons on the remote control. You can set the levels for each three groups of the listening modes (STANDARD/HOME THX, ADVANCED CINEMA/ADVANCED CONCERT, STEREO) and MULTI CH IN mode but keep in mind that all your settings will be cleared if you use the Surround Setup or Auto Surround Sound Setup to set the channel levels at a later date.

Acoustic Calibration EQ

This setting is a kind of room equalizer for your speakers. You can select a frequency balance between your speakers that suits your personal tastes. This feature also allows you to increase the amount of a certain frequency in the soundtrack, which will have the effect of hearing more (or less) bass, mid-range or treble. When you use Acoustic Calibration EQ (see p.50) you can toggle between two variations (ALL CH ADJ and FRONT ALIGN) of this setting. Both are set here. If continuing from CHANNEL LEVEL go to step 1. If starting fresh, complete steps 1-3 in "Setting Up for Surround Sound" (p.35) first.

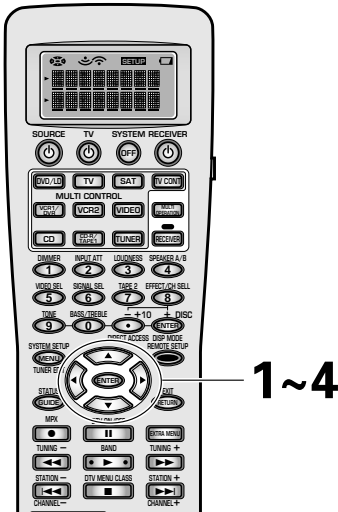

1 ACOUSTIC CAL EQ should be selected. If it isn't use the ▲▼ buttons to select and press ENTER.

2 AUTO will appear on the OSD. Press ENTER.

There are two types of curve modes that will be set. These are ALL CH ADJ mode and FRONT ALIGN mode.

ALL CH ADJ mode (flat curve): All the speakers are set individually (except for the subwoofer). No special weighting is given to any channel over any other channel so this setting is the most direct representation of the source being played.

FRONT ALIGN mode (front speaker curve): All speakers (except for the subwoofer) are set in accordance with the settings of the FRONT speakers. This setting allows the listener to enjoy a sound balance defined by the front speakers (the main speakers for home theater).

The frequency balance is set automatically by the receiver (see page 15) and both types curves are adjusted this way.

WARNING: the test tones are very loud!! Make sure there are no infants or small children in the room and that no one who will be scared, upset or damaged by loud noise is present. You yourself may want to wear earplugs.

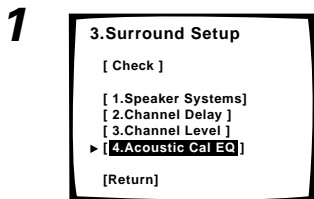

3 After it has finished, you see the ACOUSTIC CAL EQ CHECK screen. If you want to view the settings select NEXT and press ENTER. If not, simply go to the next step.

4 Select RETURN with the ▲▼ buttons and press ENTER.

You will return to the SURROUND SETUP menu. Next, if you want, proceed to Check the Auto Settings .



See page 50 to use the ACOUSTIC CAL feature.

Check the Auto Settings

If you want to check what settings have been input for your surround sound parameters you can do it following the steps below.

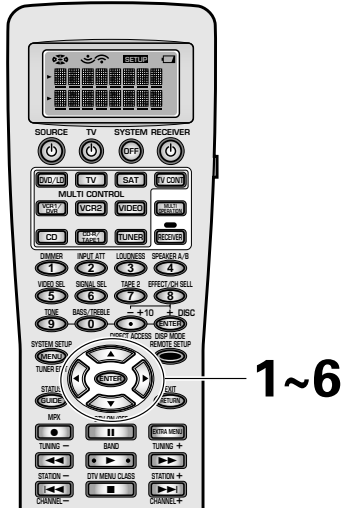

1

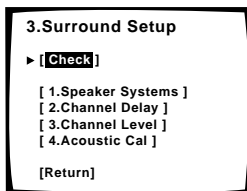

1 Use the ▲▼ buttons to select CHECK and press ENTER.

2 The first menu in which you can check your settings will appear. This is the speaker settings.

You can navigate this menu with the ◀▶ buttons but we recommend you follow the steps below.

The order of the settings menu is: Speakers; Channel Delay; Channel Level; Acoustic Calibration.

3 To check the next settings select NEXT with the ▲▼ buttons and press ENTER.

If you want to leave the settings check select RETURN with the ▲▼ buttons and press ENTER and go to step 6.

4 Continue to move through the menus using the ▲▼ buttons to select NEXT and pressing ENTER until you are done checking the settings.

5 To exit the check select RETURN with the ▲▼ buttons and press ENTER .

You will return to the SURROUND SETUP menu.

6 To exit the SURROUND SETUP menu select RETURN with the ▲▼ buttons and press ENTER. Then select EXIT with the ▲▼ buttons and press ENTER.

Basic Operation

Stereo and Multichannel Playback

The following instructions show you how to play Dolby Digital or DTS sound sources with the VSX-47TX. Before doing so be sure to complete the setup procedures described in the Quick Start Guide (starting on page 13) or Setting Up for Surround Sound (starting on page 35). This is particularly important to achieve a surround sound effect with Dolby Digital or DTS sources.

Listening modes available to you are contingent on what kind of source you are using and what LISTENING CH SELECT (5.1, 7.1, AUTO) option you choose. For background information on these ideas see page 9 (Home Theater: The Basics) and for more information of the listening modes and their uses see pages 46-49. Be sure to select Speaker system A (see p.71) or A&B if you are bi-amping the front speakers (see p.70).

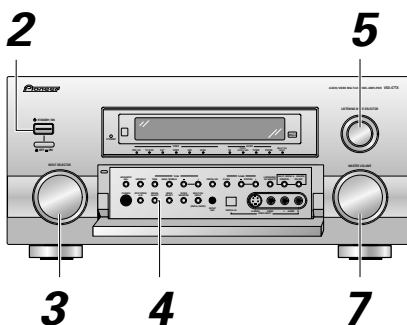
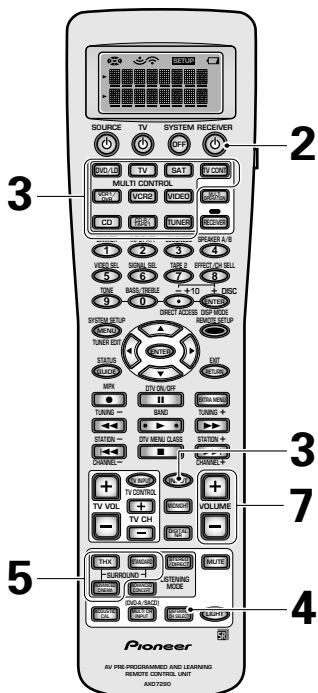

1 Turn on the power of the playback component.

2 Press the  STANDBY/ON button to turn on the receiver.

Be sure that the standby indicator turns off on the front panel.

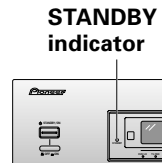

3 Press the MULTI CONTROL (or INPUT) on the remote control to select the source you want to playback.

On the front panel, use the INPUT SELECTOR dial to select the source.

The default setting for the input signal is AUTO, if you need to select ANALOG, DIGITAL or  RF see p.45.

4 Press the LISTENING CH SEL. button on the remote control.

Each press switches LISTENING CH SELECT between 5.1, 7.1 and AUTO (see page 44 for more on this). On the front panel, use the LISTENING CH SELECT button to select the channel.

5 Choose a listening mode by pressing STEREO/DIRECT, THX, ADVANCED CINEMA, ADVANCED CONCERT, or STANDARD.

On the front panel, use the LISTENING MODE SELECTOR dial. Depending on whether your source is 2 channel, 5.1 channel or 7.1 channel and your speaker configuration you will get different options for each of these modes. Press the button (or dial) repeatedly to cycle through these options.

See "Listening Modes," on p.46-49 for details on which modes are available and in which situations they are designed to be used.

6 Start playback of the component you selected in step 3.

Basic Operation

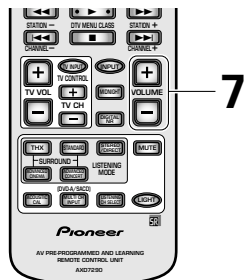

7 Adjust the volume by using the VOLUME buttons on the remote control. On the front panel use the MASTER VOLUME dial.



If the TAPE 2 indicator is visible in the display, it means the TAPE 2 MONITOR is on. Press TAPE 2 MONITOR (front panel) or TAPE 2 (remote) to turn it off unless you want to listen to the component hooked up to TAPE 2.

Switching the channels used for playback (LISTENING CH SELECT)

This button selects the number of channels used for playback, either 5.1 or 7.1 (includes 6.1). The default setting is AUTO, which will choose the appropriate playback channels for the source, speaker configuration and listening mode you are using. For more details see pages 46-49.

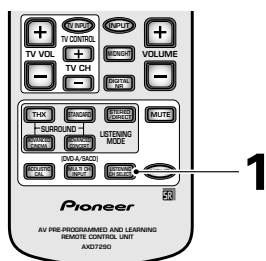

1 Press the LISTENING CH SEL. button on the remote control.

Each press switches LISTENING CH SELECT between 5.1, 7.1 and AUTO.



- If you haven't set your system up with surround back speakers you won't be able to choose 7.1 channel or AUTO with this button.
- LISTENING CH SELECT options may change if the SPEAKER SYSTEM settings are changed. (p.36-37).
- LISTENING CH SELECT affects which listening modes will be available.
- You can't select LISTENING CH SELECT in STEREO mode.

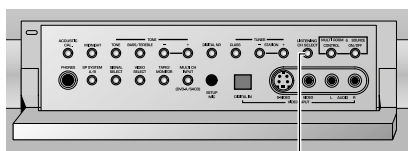

Switching ANALOG/DIGITAL Signal Input

This button selects the type of input signal, ANALOG, DIGITAL or **RF**, sent to the receiver. You need to take special care to switch to the appropriate input when necessary. For example, the switch would have to be on DIGITAL to hear DOLBY DIGITAL or DTS surround sound material but it would have to be on analog to record from the ANALOG out jacks on the receiver. The default setting is AUTO which chooses digital over analog when both are available but goes with whatever is available if it is the only choice.

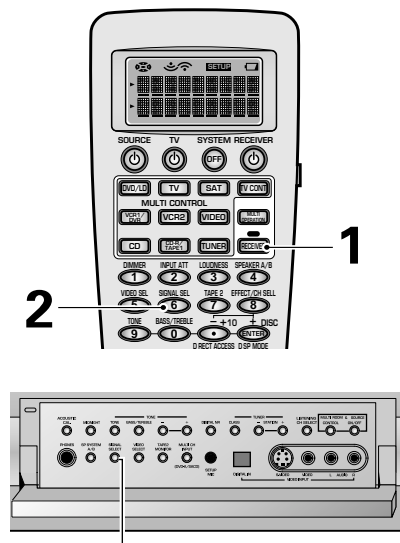

1 Press RECEIVER.

2 Press the SIGNAL SELECT button to select the input signal corresponding to the format of the source component.

Each press switches the signal in the order below:

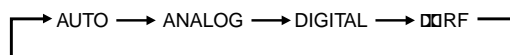

1



- In the AUTO setting, receiver chooses the signal, based on availability, in the following order of priority: **RF**, DIGITAL, ANALOG.
- When DIGITAL signal is selected, **DIGITAL** lights when a Dolby Digital signal is input; DTS lights when a DTS signal is input.
- If no digital inputs are assigned (see p.12), the SIGNAL SELECT will default to ANALOG.
- Because the audio signal from a karaoke microphone and LDs are recorded with analog audio only, they are not output from the digital outputs. Set SIGNAL SELECT to ANALOG to listen to these formats.
- When an LD with DTS is played back with the SIGNAL SELECT set in ANALOG, digital noise caused by playing back the DTS signal directly (with no decoding) is output. To prevent noise, you need to make digital connections (See p.22 & 23) and set SIGNAL SELECT to AUTO or DIGITAL.
- Some DVD players don't output DTS signals. For more details, refer to the instruction manual supplied with your DVD player.
- This receiver can only play back Dolby Digital, PCM (32kHz, 44kHz, 48kHz, 88kHz and 96kHz sampling frequency), and DTS digital signal formats. If your source is not one of these select ANALOG for playback.
- Make sure you connect your DVD/LD or LD players using the **RF** jack. If your player has a **RF** output this will ensure you can use all LDs. Refer to p.17.

Playback of 96kHz 24 bit sound formats

This receiver is capable of playing back 96kHz/24bit sound formats (such as DTS 96/24 and PCM 96kHz (up to 24bit)).

To Playback with the Best Sound Quality (all processing is done at 96 kHz).

For DTS 96/24 5.1 format, connect both center and surround left/right speakers, set LISTENING CH SELECT to AUTO or 5.1, choose STANDARD mode and turn off all sound functions. For 96kHz 2ch format (either DTS or PCM) choose STEREO mode and turn off sound functions. For both these playbacks, "96kHz" will appear in the receiver's display. If it doesn't the processing is being done at 48kHz.

You can listen to DTS 96/24 soundtracks through this receiver if your DVD player has a DTS output feature, even if it can't output 96kHz digital signals. For PCM 96kHz soundtracks, however, you won't be able to listen to them with digital connections if your DVD player can't output 96kHz digital signals.

Check the manual that came with your DVD player to confirm what it can output and for more information on these formats. Also, if you set the Re-Equalization function (p.98) you can use 96kHz processing.

Listening Modes

The five listening mode types on the receiver are explained here. To select listening modes see pages 43-44. The kind of playback you can get in the three modes, STANDARD, HOME THX, and ADVANCED CINEMA, depends on what kind of a source (DVD, etc.) you are using. The basic distinction is between 2 channel sources and multichannel sources. The modes that are available to you with these ADVANCED CINEMA modes will differ depending on the source. Also, different modes are used for different speaker configurations. This is explained below as well.

For home theater STANDARD, HOME THX, and ADVANCED CINEMA listening modes are designed to deliver realistic and powerful multichannel surround sound that recreates the movie theater experience. You may need to experiment with them to see which settings suit your home system and personal tastes.

The ADVANCED CONCERT and STEREO modes are designed to be used with music sources but some ADVANCED CONCERT modes are also suited for film soundtracks. Again, try different settings with various soundtracks to see which you like.

You must choose one of the three cinema modes or the ADVANCED CONCERT mode in order to get surround sound. Depending on your setup, in STEREO mode only the front two speakers, and sometimes the subwoofer (if you have one), are used.

STEREO modes

When a source is played in this mode, it plays through just the front left and right speakers (and possibly your subwoofer depending on your speaker settings). Dolby Digital and DTS multichannel sources are downmixed to stereo.

STEREO

In STEREO mode the audio plays according to the surround setup settings and you can still use Acoustic Calibration EQ, Digital NR, Midnight mode, Loudness mode and Tone Control functions.

DIRECT

In DIRECT mode, the audio bypasses all types of signal processing to remain as close to the source audio quality as possible.

Note: If you switch on Acoustic Calibration EQ, Digital NR, Midnight mode, Loudness mode or Tone Control when DIRECT is selected, the receiver automatically switches to STEREO.

STANDARD modes

This mode is for pure decoding of Dolby Digital, Dolby Surround and DTS sources as well as surround matrix decoding of 2 channel sources. It is good for enjoying regular movies/videos that have been recorded in Dolby Digital, Dolby Surround, DTS, STANDARD TX/SX is also the basic mode for enjoying sources with surround and surround back channels. For more detailed information see p.99-101. You will only be able to access the second two modes if you have hooked up surround back speaker(s). For more detailed information see p.11, 25, 36-37. The display will show you what kind of decoding (Dolby Digital, DTS, etc.) is being used.

For 2 Channel Sources:

PRO LOGIC II MOVIE

This mode gives 5.1 channel surround sound. It is suitable for movies, especially those recorded in Dolby Surround. The channel separation and movement of surround effects is comparable to Dolby Digital 5.1.

PRO LOGIC II MUSIC

This mode gives 5.1 channel surround sound and is suitable for music. Compared to the Movie Mode, the surround effect is more enveloping.

PRO LOGIC

This mode gives 4.1 channel surround sound. It is less sensitive to the quality of the source material, so may be useful when PRO LOGIC II MOVIE/ MUSIC modes do not give good results.

NEO:6 CINEMA

This mode gives 6.1 channel surround sound and is suitable for movies. The NEO:6 Cinema mode delivers good channel separation for movie soundtracks.

NEO:6 MUSIC

This mode gives 6.1 channel surround sound and is suitable for music. The NEO:6 Music mode plays the stereo source as is through the front left/right speakers, and generates a natural, ambient surround and center sound.

For 6.1 or 7.1 channel playback of 5.1 Channel Sources:

SX (Studio extension)

You can only use this mode if you have setup this receiver for use with surround back speaker(s) (see pages 11, 25, 36-37) and select 7.1 in LISTENING CH SELECT (see p.44).

This mode adds surround back channel(s) to 5.1 channel sources to give 7.1 channel surround sound. The sound you hear from the surround back speaker(s) is the same as the surround speakers. This recreates a 5.1 channel surround sound mixing studio or theater, which would usually have more than 6 speakers. The display shows the format of the source played.

TX (Technical extension)

You can only use this mode if you have setup this receiver for use with surround back speaker(s) (see pages 11, 25, 36-37) and select 7.1 in LISTENING CH SELECT (see p.44).

This mode generates surround back channel(s) for conventional 5.1 channel sources to give 7.1 channel surround sound. Any 5.1 channel source can be used, but some movies have soundtracks that sound especially good with TX mode on.

With 6.1 channel playback compatible sources, the TX mode is automatically selected when the LISTENING CH SELECT is set to AUTO (default).

HOME THX modes

THX and Home THX are technical standards created by Lucasfilm, Ltd. for cinema and home theater sound. The aim of Home THX is to improve the sound of straight decoding to make home theater audio more like the sound you hear in a cinema. See pages 100-101 for more information.

For all speaker playback of any source:

THX CINEMA

This mode will play any source through all the speakers in your system.

For 2 channel sources only:

After selecting one of the following modes the display shows the mode you selected, then, after a few seconds, shows THX CINEMA.

DOLBY PRO LOGIC II MOVIE

See page 46 for more on this mode.

DOLBY PRO LOGIC

See page 46 for more on this mode.

NEO:6 CINEMA

See page 46 for more on this mode.

For 6.1 or 7.1 channel playback of 5.1 channel sources:

THX SURROUND EX

You can only choose this mode if you have set up this receiver for use with surround back speaker(s) (see pages 11, 25, 36-37) and select 7.1 in LISTENING CH SELECT (see p.44).

For true 6.1 channel cinema sound, Dolby Digital Surround EX encoded discs should be played with THX Surround EX processing. However, it will also generate surround back channel(s) from any Dolby Digital 5.1 or DTS 5.1 channel disc. (when playing a DTS disc, the display shows DTS-ES +THX.

With 6.1 channel playback compatible sources, the THX SURROUND EX mode is automatically selected when the LISTENING CH SELECT is set to AUTO (default).

Basic Operation

For 7.1 channel playback of 5.1 channel sources:

THX ULTRA2 CINEMA

You can only choose this mode if you have set up this receiver for use with two surround back speakers (see pages 11, 25, 36-37 and select 7.1 in LISTENING CH SELECT (see p.44).

When played using THX SURROUND EX, the surround sound field may actually sound narrower on some earlier Dolby Digital 5.1 and DTS 5.1 channel sources than with THX CINEMA processing. THX ULTRA2 CINEMA creates two extra channels from these sources and plays them through the surround back speakers.

With 5.1 channel sources, the THX ULTRA2 CINEMA mode is automatically selected when the LISTENING CH SELECT is set to AUTO (default).

THX MUSICMODE

You can only choose this mode if you have set up this receiver for use with two surround back speakers (see pages 11, 25, 36-37) and select 7.1 in LISTENING CH SELECT (see p.44).

THX MUSICMODE is for Dolby Digital 5.1 and DTS 5.1 channel sources that were not produced for a theatrical release—typically music. This mode creates two extra channels of natural, ambient sound and plays them through the surround back speakers.

ADVANCED CINEMA modes

The ADVANCED CINEMA mode is a newly designed system for enhancing movie soundtracks and other audio-visual sources that optimizes its effects in accordance with your source, LISTENING CH SELECT and speaker configuration. There are six ADVANCED CINEMA settings that use DSP (Digital Signal Processing) to create different types of sound environments.

ACTION

This mode is designed for action movies, which generally use lots of sound effects. The mode enriches the sound to make it more realistic and extends the parameters to pick up high and low sound effects.

SCI-FI

This mode is designed for science fiction movies. It creates a broad sound space, separating dialog from sound effects to heighten the overall impact of the soundtrack.

DRAMA

This mode is designed for movies with a lot of dialog. The elements of dialog are enhanced, making the characters seem more real. The mode also compresses the dynamic range somewhat so loud sounds do not overpower softer ones (compare this with the MIDNIGHT listening mode explained on p.51).

MUSICAL

This mode is primarily for music and adds a spacious feeling to the sound. A long delay time of reflected sounds provides resonant tones which emulate a concert hall.

MONOFILM

This mode is designed for older movies which are recorded with mono soundtracks. The special sound processing of this mode will allow you to experience these movies in surround sound even though they were not recorded that way originally.

X-D THEATER

This mode is especially designed to give sound depth to stereo sources. The overall effect builds a dynamic and broad sound space, allowing two-channel (stereo) signals to faithfully imitate a five speaker sound. The mode should be used in conjunction with Dolby Pro Logic for sources bearing the

 **DOLBY SURROUND** mark.

ADVANCED CONCERT modes

The ADVANCED CONCERT (Digital Signal Processing) modes allow you to transform your living room into a variety of different sonic environments when playing either two-channel or multichannel sources. It optimizes its effects in accordance with your source, LISTENING CH SELECT and speaker configuration.

CLASSICAL

Simulates the acoustic effects of a large concert hall. Suitable for classical music. A long delay time of reflected sounds, coupled with reverb effects, let the listener experience the dynamic and rich sounds characteristic of concert halls and powerful orchestral performances.

CHAMBER

Simulates the acoustic environment of a very resonant concert hall. Rich reverberation and a full sound create the impression of a lively performance space.

JAZZ

Simulates the acoustic effects of a jazz club. Reflected sound is virtually below 100 msec so that the listener can experience a live band effect.

ROCK

Simulates the acoustic effects of a mid-sized concert hall. The listener can experience a live band effect with good separation of the instruments, a strong bass and the vivid feeling of a live performance.

DANCE

Simulates the acoustic effects of a dance club. Features a strong bass sound. Reflected sound delay time is virtually below 50 msec, for the listener to experience the visceral power of dance music.

X-CH STEREO

Simulates the acoustic environment of a regular stereo while using all the speakers in the system to induce a rich, all-around sound. The display will change to 5CH STEREO or 7CH STEREO according to the sources, LISTENING CH SELECT and speaker configuration.

Adjusting the Effect of ADVANCED Listening Modes

The ADVANCED listening modes have sound processing added to accentuate a certain kind of atmosphere or effect (see the preceding pages for explanation). You can choose if you want to strengthen or weaken this effect in the given mode.

The following instructions show you how to adjust the amount of effect.

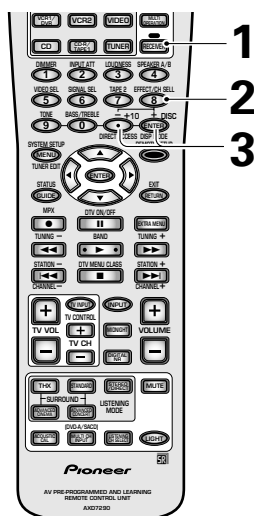

1 Press RECEIVER.

2 Press the EFFECT/CH SEL. button repeatedly until you see "EFFECT" in the receiver's display.

3 Use the +/- buttons to add or subtract the amount of effect.



- The amount of effect can be adjusted ranging from 10 to 90 (the default setting value is 70) by pressing +/-.
- 5/7CH STEREO modes cannot be adjusted.

Listening with Acoustic Calibration EQ

You can listen to the soundtrack with the Acoustic Calibration EQ you set on page 41. To do so follow the instructions below. For information about each Acoustic Calibration EQ mode, see page 41.

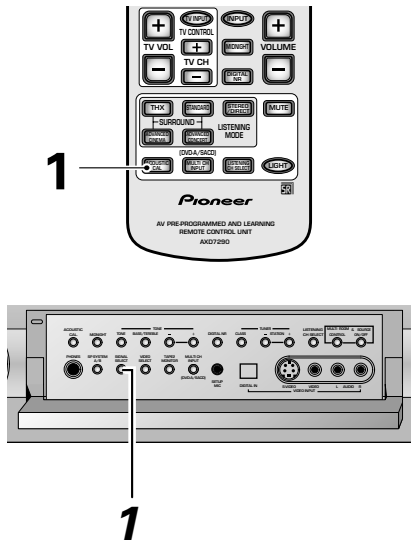

1 Press the ACOUSTIC CAL. button on the remote control or on the front panel.

Each press switches acoustic calibration EQ between ALL CH ADJ, FCH ALIGN and OFF.



- After completing the AUTO SURROUND SETUP (p.13) or setup using AUTO (p.41), ACOUSTIC CAL ON (ALL CH ADJ) is set automatically.
- You can't turn on ACOUSTIC CAL. on in MULTI CH IN mode.
- If you turn ACOUSTIC CAL. on in DIRECT mode, the receiver automatically switches to STEREO mode.

Reducing Noise During Playback (DIGITAL NR Function)

To reduce extraneous noise switch on DIGITAL NR. This feature is effective with sources containing a lot of background noise like cassette and video tape

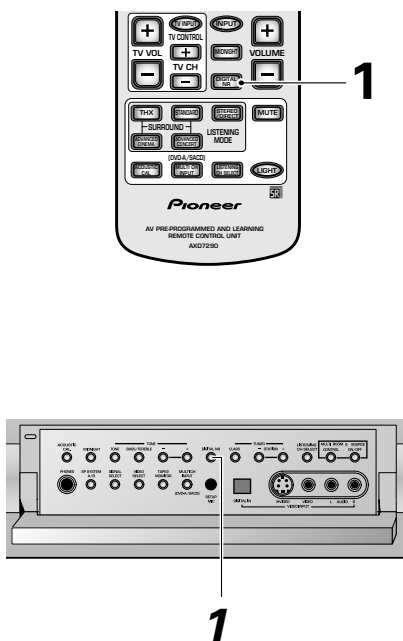

1 Press the DIGITAL NR button on the remote control or on the front panel.

Each press switches DIGITAL NR on or off.



- In cases described below, noise may not be reduced even if DIGITAL NR is on.
 - Sudden noise
 - Extremely loud noise
 - Signals that contain too many high frequencies
 - Signals which are very cleanly to begin with.
- DIGITAL NR is effective at levels shown below for each source.

STEREO (excluding 96 kHz)	
· Analog input	10-18 dB
· Digital input	10-15 dB
· AM/FM tuner	10-15 dB
· ADVANCED/STANDARD/96 kHz stereo	6-10 dB
- Depending on the condition of the source, there may not be a noticeable improvement in the quality of the sound.
- You can't use the DIGITAL NR mode with the HOME THX or MULTI CH IN mode.
- If you set the DIGITAL NR on in DIRECT mode the receiver will switch to STEREO mode.

Listening in MIDNIGHT Mode

This useful feature makes it possible to get excellent surround sound effects even when listening at low volumes. It can be used with any surround sound source and play soundtracks so that the quieter sounds are audible even while playing a soundtrack at low volumes. This feature is applicable only when the master volume is under -20 dB.

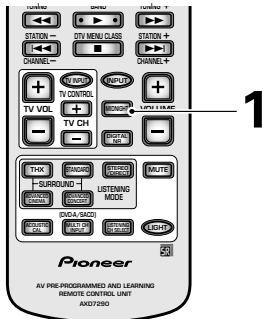

1 Press the MIDNIGHT button on the remote control or on the front panel.

Each press switches MIDNIGHT mode on or off.



- The surround effect adjusts itself automatically in accordance with the volume level.
- You can't use the MIDNIGHT mode with the HOME THX, MULTI CH IN, LOUDNESS or TONE CONTROL modes.
- If you set MIDNIGHT on when in DIRECT mode the receiver switches to STEREO mode.

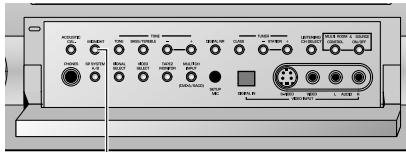

1

Listening in LOUDNESS Mode

The LOUDNESS mode boosts the bass and treble in a signal. It is useful for listening to music at low volumes.

1 Press RECEIVER.

2 Press the LOUDNESS button on the remote control.

Each press switches LOUDNESS mode on or off.

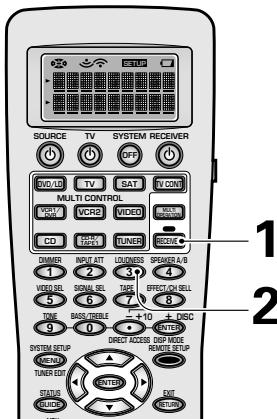

- You can't use the LOUDNESS mode with the HOME THX, MULTI CH IN, MIDNIGHT, or TONE CONTROL modes.
- If you set LOUDNESS on in DIRECT mode the receiver will switch to STEREO mode.

Adjusting Bass and Treble (TONE CONTROL)

You can adjust the low (bass) and high (treble) frequencies. The TONE button can also be used to bypass the tone circuitry.

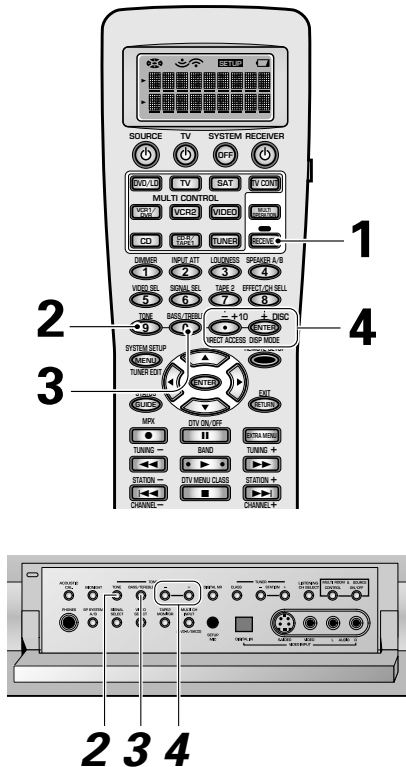

1 Press RECEIVER.

2 Press the TONE button on the remote control or the front panel to put the receiver in tone adjust mode.

There are two tone modes TONE: ON and TONE: BYPASS. The first means the tone functions are active and also lets you adjust these functions. The second means the tone controls are being bypassed, and thus have no effect on the sound.

If TONE: BYPASS appears, press the button again to get TONE: ON, which is the tone adjust mode.

3 Press the BASS/TREBLE button repeatedly to select BASS or TREBLE.

4 Use the +/- buttons to adjust the low or high frequency levels.

A few seconds after you finish adjusting the tone the receiver will revert to the sound mode it was in at the beginning of the process.



- The tone control can be adjusted in a range of ± 6 dB.
- The tone control cannot be set on in HOME THX, MULTI CH IN, MIDNIGHT or LOUDNESS modes.
- If the receiver is in DIRECT mode and you press the TONE button, TONE: BYPASS appears in the display. You will need to press TONE once more to switch the tone control on, canceling the STEREO DIRECT mode.

DVD Audio/MULTI CHANNEL IN Playback

MULTI CH IN allows you to connect a DVD audio player or an external decoder to enjoy certain types of specialized discs. To use MULTI CH playback follow the instructions below.

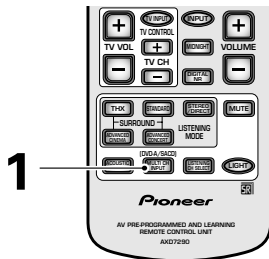

1 Press the MULTI CH IN button on the remote control's Receiver MAIN screen or the MULTI CH INPUT button on the front panel.

Each press switches the input between the previous mode and MULTI CH IN.

ON: This is a true playback of the signal from the MULTI CH INPUT terminals, output without digital processing. You can only control each channel level.

OFF: Cancels the MULTI CH IN modes.

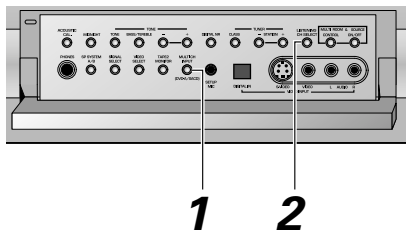

2 Use the LISTENING CH SEL button to select the number of input channels.

You can select 2 or 8 channels. For best sound quality use 2 channels when you listen to stereo sources.



- You can't use any kind of sound processing together with MULTI CH IN. Selecting a listening mode, or switching these modes, cancels the MULTI CH IN.
- If the center speaker is set to "NO" the signal for that channel is divided between the front speakers. If any other speakers are set to "NO" the signal for that (those) channel(s) won't get output at all.
- You cannot set sound features (p.50-52) on, in MULTI CH IN mode.

See MULTI CH IN SELECT (p.94) for more on MULTI CH IN playback.

DUAL MONO setting and playback

The dual mono setting can only be used when listening to Dolby Digital or homemade discs that have dual mono software encoded in them. Dual mono software usually is used to put two different mono recordings with one soundtrack on one DVD. With this setting you can choose which channel in the dual mono setting you want to listen to. Remember this setting is only applicable if you are using Dolby Digital software with dual mono and want to isolate one of the channels therein.

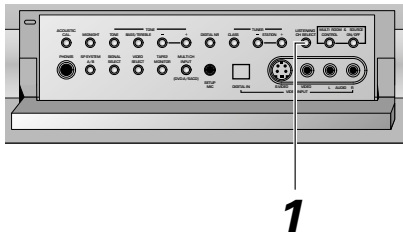

1 Press the LISTENING CH SELECT button for more than five seconds to put the receiver in DUAL MONO mode.

Hold down the LISTENING CH SELECT button to cycle through the different DUAL MONO settings. When you find the one you want release the button. The L (ch1) and R (ch2) indicators in the display light to indicate the playback channel.

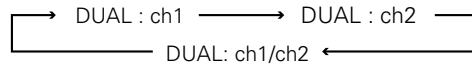

- The default setting is DUAL ch1.
- You can only use this function with Dolby Digital sources that have this function

The different settings are: DUAL ch1, where you only hear channel 1; DUAL ch2, where you only hear channel 2; and DUAL ch1/ch2, where you hear both channels, but independently from different speakers.

Input Attenuator

The input attenuator lowers the input level of an analog signal when it is too strong, causing distortion in the sound.

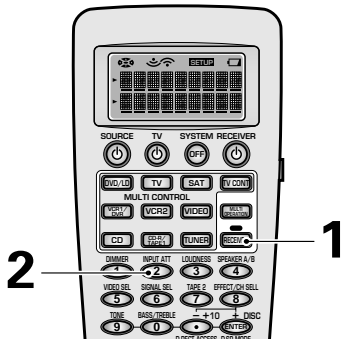

1 Press RECEIVER.

2 Use the INPUT ATT button on the remote control.

Tape 2 Monitor

If you connect a cassette deck with a record monitor function (a three-head tape deck) to the TAPE 2 MONITOR jacks, you can listen to the sound of an analog recording as it's being recorded.

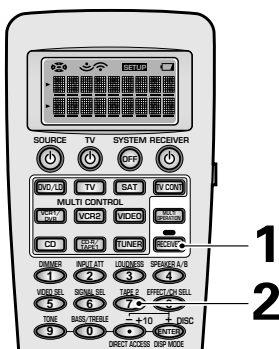

1 Press RECEIVER.

2 Use the TAPE 2 MONITOR button on the remote control to listen to the component hooked up to the TAPE 2 MONITOR jacks.

Using Headphones

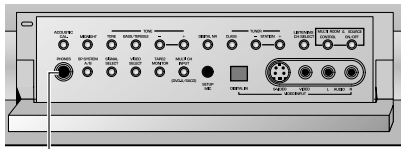

1 headphone jack

1 Plug headphones into the headphone jack on the front of the receiver.

No sound will be audible from the speakers when headphones are plugged in.



- All listening modes will be downmixed to 2 channels.
- If you're listening to a 2 channel source there will be no matrix decoding (i.e. you will not be able to get surround sound decoding).
- If your U-shaped connectors (see p.30) aren't in place you won't be able to use headphones.

Video Select

This function allows you to listen to one sound source while you watch a different video source on your TV. The sound source is set in the normal fashion as explained on p.43 & 44 You then change the video input with the VIDEO SEL button.

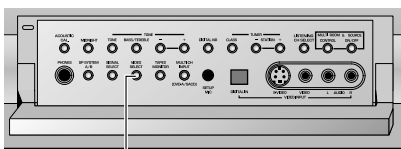
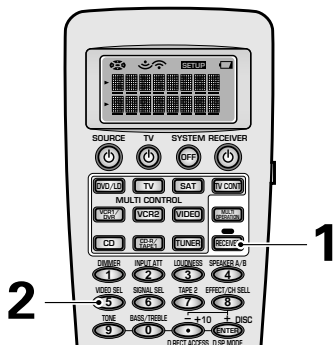

2

1 Press RECEIVER.

2 Press the VIDEO SEL button on the remote control to cycle through the different possible video inputs.

The first press shows the video input you are currently using. After that pressing VIDEO SELECT cycles through the possibilities in the following order:

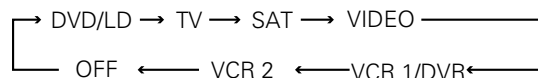

The OFF setting means you are listening without a video signal. (Also, when you select CD-R/TAPE1/MD, CD, TUNER, or PHONO functions the VIDEO SELECT will be set to off.)

After choosing a video input the display on the receiver will show that input for about 5 seconds and then revert to showing the listening mode the receiver is in.



- The VIDEO SELECT remains set to the input you chose until you change the audio input.
- If you change audio functions the receiver will reset itself to make the video and audio inputs correspond. Also, if you switch the power of the receiver off when you turn it back on the video and audio inputs will reset so that they correspond.

Adjusting the Brightness of the Display

Use the display DIMMER button to adjust the brightness of the fluorescent display.

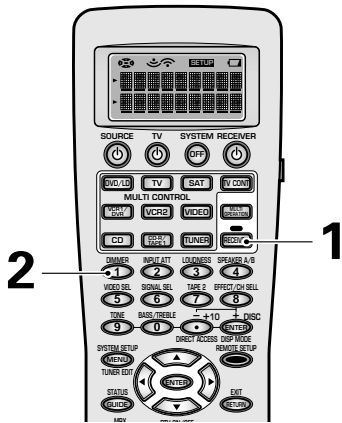

1 Press RECEIVER.

2 Use the display DIMMER button on the remote control to alternate between the different levels of brightness for the display.

Four levels of brightness ranging from very dim to very bright can be selected. Each press changes the brightness of the display. When cycling through the options, the default brightness can also be selected.



- Please note: It is a feature of this unit that the fluorescent display will be brighter for a few seconds after you choose a function (like DVD/LD, CD, etc.) and then get softer. This will still happen when you adjust the brightness but the new setting will be the one the display softens to.

Status Display

The Status display lets you see what the status is for most of the settings in this section.

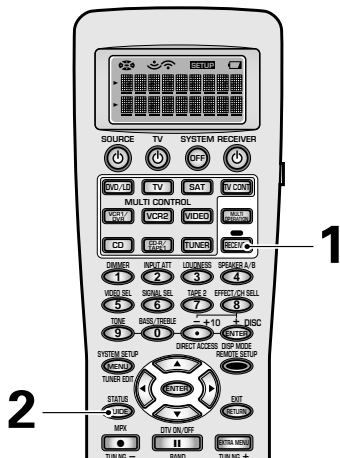

1 Press RECEIVER.

2 Press the STATUS button.

The status of the settings will appear on both the OSD and the display on the receiver. For the latter the settings will appear in the following order for two seconds each.

- Listening Channel Select
LISTEN 'CH : 7.1
- Acoustic Calibration
A-EQ : ALL CH ADJ
- Digital Noise Reduction
DIGITAL NR : OFF
- Midnight Mode/ Loudness/ Tone Control
MID LOUD TN : OFF
- Input Attenuator
INPUT ATT : OFF
- Tape 2 Monitor
TAPE 2 : OFF
- Video Select
VSEL : DVD/LD

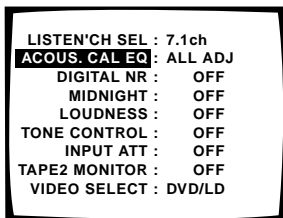

Using the Tuner

Automatic and Manual Tuning

The following steps show you how to tune in FM and AM radio broadcasts using the automatic (search) and manual (step) tuning functions. If you already know the exact frequency of the station you want, see "Direct Access Tuning" on the following page.

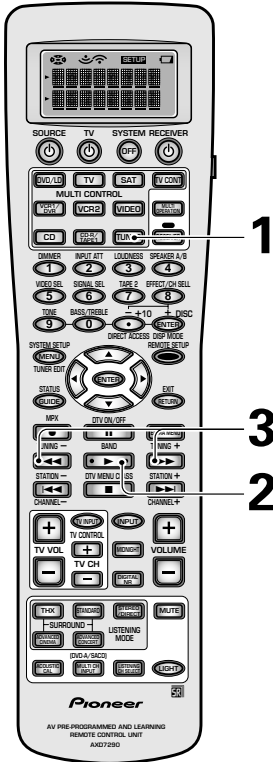

1 Press the TUNER button.

On the remote, this selects the tuner function on the receiver and sets the remote to the tuner operation mode.

FM 87.50MHz
STEREO

2 Press the BAND button to select the band (FM or AM).

Each press switches the band: FM ↔ AM

AM 530kHz
STEREO

3 Tune in the station.

For Automatic Tuning

Press and hold TUNING +/- for about one second, then release.

The tuner starts searching the selected band and stop automatically at the first station it locates. Repeat to locate other stations.

For Manual Tuning

- To change frequencies one step at a time, press TUNING +/- repeatedly.
- To change frequencies quickly, hold down TUNING +/- and release when you reach the frequency you desire.

MPX Mode

If the TUNED or STEREO indicators do not light when tuning an FM station, because the station is too far away or the broadcast signal is weak, press MPX on the remote control to switch to MONO reception. This should improve reception enough for you to enjoy the broadcast.

Direct Access Tuning

The following steps show you how to tune directly to a specific frequency using the remote control.

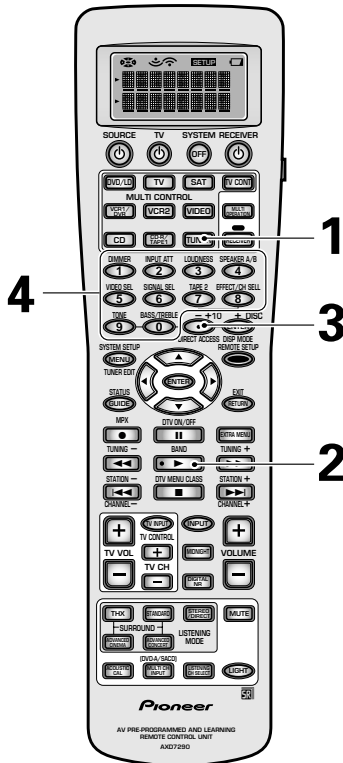

1 Press the TUNER button.

This selects the tuner function on the receiver and sets the remote to the tuner operation mode.

2 Press the BAND button to select the band (FM or AM).

Each press switches the band : FM ↔ AM

3 Press the DIRECT ACCESS button to activate the direct access tuning mode.

The cursor blinks in the display on the front panel.

```
DIRECT ACCESS
FM  ___ . __ MHz
```

4 Use the number buttons to enter the frequency of the station you want.

Example:

To tune station 106.00 (FM), press: ① → ⑥ → ① → ①

To cancel before inputting the frequency

Press DIRECT ACCESS, and enter the frequency again.

Memorizing Frequently Used Stations

The following steps show you how to memorize up to 30 radio stations in 3 classes (each holding 10 stations). When memorizing FM frequencies, the receiver also memorizes the MPX mode (STEREO or MONO).

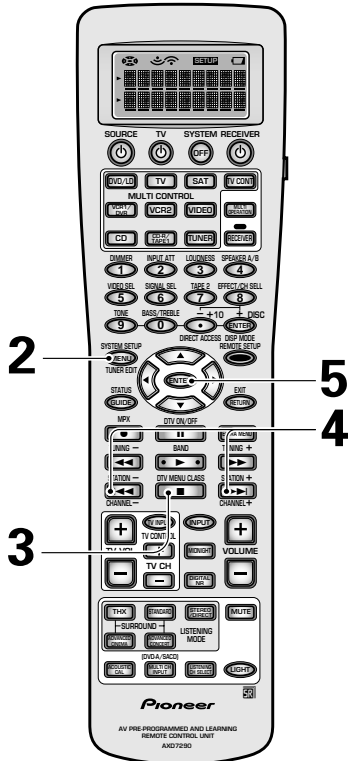

1 Tune in the station you want.

See "Automatic and Manual Tuning" or "Direct Access Tuning" on page 57 and 58.

2 Press the TUNER EDIT button to activate the memory function.

MEMORY INPUT
A- 99.50MHz

3 Press the DTV MENU CLASS button repeatedly to select a class number.

Each press switches the display:

→ CLASS A → CLASS B → CLASS C

4 Press the STATION +/- buttons (or the number buttons) repeatedly to select a channel (0~9) within the respective class.

MEMORY INPUT
A7 99.50MHz

The station is memorized automatically after 5 seconds.

5 Press the ENTER button to input your choice.

Naming Memorized Stations

You can input a name of up to eight characters for each preset station in the receiver's memory (see the previous page). This name can be anything you choose. For example, you could input "CLASSICS" for that station and when you listen to it the name, rather than the frequency number, will appear on your display.

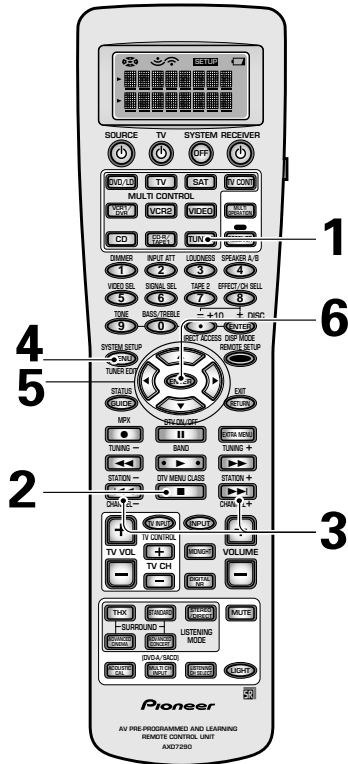

1 Press the TUNER button on the remote control.

2 Press DTV MENU CLASS repeatedly to select the class.

Repeatedly pressing this button cycles through the three available classes, A, B and C.

3 Press STATION + or STATION - to select the preset channel.

4 Press TUNER EDIT to select the station name mode.



5 Enter the station name you want.

Use ▲ (TUNE +) or ▼ (TUNE -) to cycle through the available characters. Press ► (ST +) to move to the next character position once you reach the character you want. Press ◀ to move back a character position. Any time you want to exit the process you can press the TUNER EDIT button.

6 Press ENTER when you have got the characters you want to enter.

Repeat steps 2 to 6 to memorize up to 30 preset broadcast station names.



- To erase a station name, enter eight spaces for the station name.
To change a station name, enter a new name over the top of the existing one.

Recalling Memorized Stations

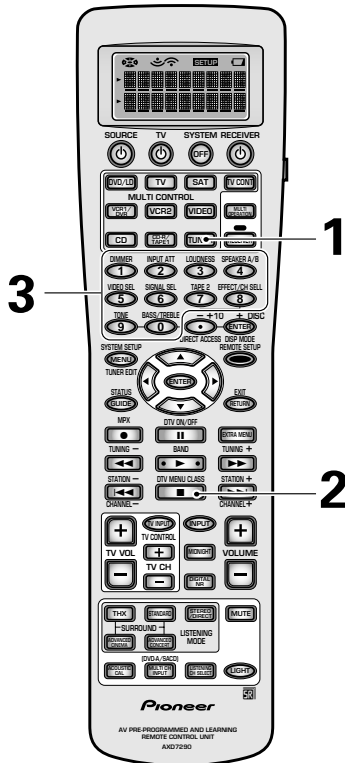

1 Press the TUNER button.

This selects the TUNER function on the receiver and sets the remote to the TUNER operation mode.

FM 87.50MHz
STEREO

2 Press the DTV MENU CLASS button repeatedly to select a class number.

Each press switches the display:

→ CLASS A → CLASS B → CLASS C

3 Use the NUMBER buttons to select the channel you desire.

To select channel 7, press ⑦.

To select channel 0, press ⑩.

For example : If 99.50 MHz (FM) was memorized in class A at channel 7.

A7 99.50MHz

To step through each channel in order

Press the STATION -/+ buttons repeatedly.

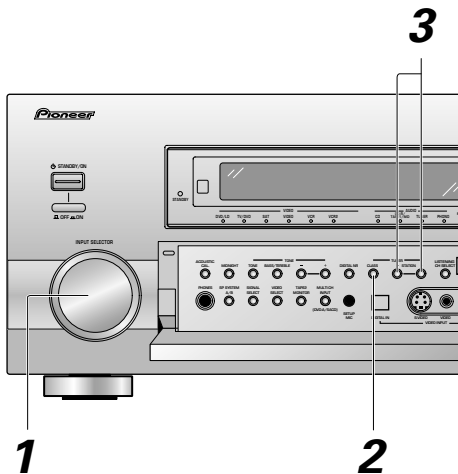

Remote Control of Other Components

Setting Up the Remote Control to Control Other Components

In addition to controlling the receiver, the supplied remote control can operate your other components (VCR, TV, DVD, CD, etc.) after you program it to do so. In this way, instead of fumbling with many different controls and buttons, you only need to use one remote control. If your component(s) are listed in the remote control's memory, simply follow the steps below. If your component(s) are not listed, or if you want the remote to learn additional operations, you can use the learning mode to input the information from the remote controls supplied with your other components.

Recalling Settings Stored in the Remote Control

The following steps show you how to recall the setting stored in the remote control. Once a setting is recalled and the component assigned, you can use this remote to easily operate the component.



- **To exit from the remote control setup mode at any time, press REMOTE SETUP.**
- See "Using Remote Control with Other Components" on pages 66 and 67 to operate your other components.
- The display will disappear after one minute or so if no new commands are entered. Press any button to 'wake up' the remote and continue the process.

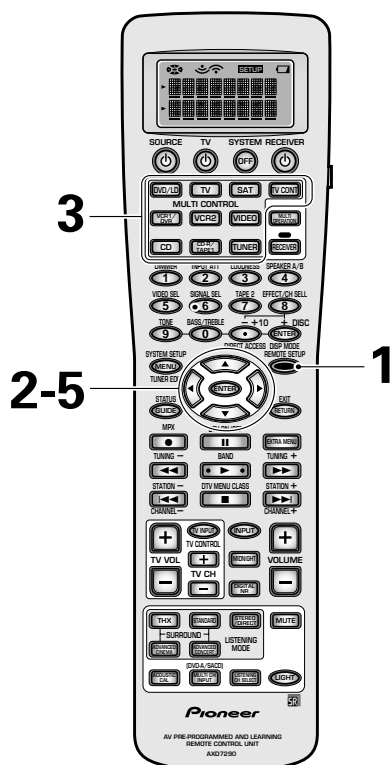

1 Press the **REMOTE SETUP** button for three seconds.

The REMOTE SETUP menu appears on the remote display.

2 **PRESET** should be selected (if it isn't use the **▲▼** buttons to select it) and press **ENTER**.

SELECT FUNCTION blinks in the display.

3 Press the **MULTI CONTROL** button (for example, **DVD/LD**) you want to set.

4 Use the **▲▼** buttons to select the component you want to set up. Press **ENTER**.

MAKER appears in the remote control display.

5 Use the **▲▼** buttons to select the name of the company that makes your component.

The company names appear in the remote control display. If there is more than one component type for that company that makes your component then -1, -2, etc., will appear in the display. Choose one of the types and see if that works.



The TUNER button cannot be assigned.

6-9

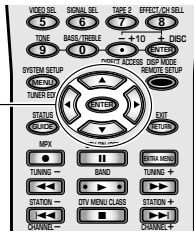

6 Point the remote control at the component you want set and press ENTER.

OK? will appear in the remote control display.

If the component you are trying to control turns on/off you have set it correctly. Use the ▲▼ buttons to select YES and go on to step 7.

If the component you are trying to control does not turn on/off the correct preset code has not been selected. In this case, use the ▲▼ buttons to select NO, press ENTER and go back to step 5. Try another preset code for that maker. (If the component you are trying to setup doesn't have a standby/on mode it won't turn on even if the correct preset code is entered. In this case select YES and go on to step 7.)

If you can't seem to get the component you are trying to set to turn on or off you can still set up your remote control by using the LEARNING mode (on the next page).

7 Press ENTER. The preset code has been entered.

COMPLETE will appear in the display.

Naturally it's easiest and most logical to assign the button that has the same name as the component you are setting up (for example, choose the DVD/LD button for your DVD player).

You may find you have components which do not correspond to the name on any MULTI CONTROL button (for example a cable TV tuner) or you have two components where only one button is provided (for example, CD-R/TAPE 1). In this case, use step 3 to assign any available MULTI CONTROL button to the component you want to remote control. For example, you may have both a CD-R and a tape deck in your system but only one video deck. It would make sense to assign the CD-R/TAPE 1 MULTI CONTROL button to the CD-R and the VCR 2 MULTI CONTROL button to your tape deck. To do this choose VCR 2 in step 3 when you want to set up the tape deck. Then choose TAPE in step 4 and proceed as above. The only practical difference in this method is that you have to remember the VCR 2 MULTI CONTROL button is actually your tape deck.

In this case, you would need to hook up your tape deck to the input jacks marked VCR 2 on the back of the receiver.

This method should help you customize the remote control for your system and let you control all of your components with the remote control for the VSX-47TX.

8 Repeat the process from step 2 for all of your components.

9 Select EXIT and press ENTER.

Remote Control of Other Components

Programming Signals from Other Remote Controls (LEARNING Mode)

If preset codes are not available for your component(s), or the available preset codes do not operate correctly, you can use this procedure to program in signals from the remote control(s) of your other component(s). These steps can also be used to add further operations to the remote control that were successfully set with the stored settings (see p.62-63).



- To exit from the remote control setup mode at any time, press **REMOTE SETUP**.
- You can also program the **▲/▼/◀/▶** and **ENTER** buttons with the LEARNING mode.
- The **TUNER** button cannot be assigned.
- The display will disappear after one minute or so if no new commands are entered. Press any button to 'wake up' the remote and continue the process.

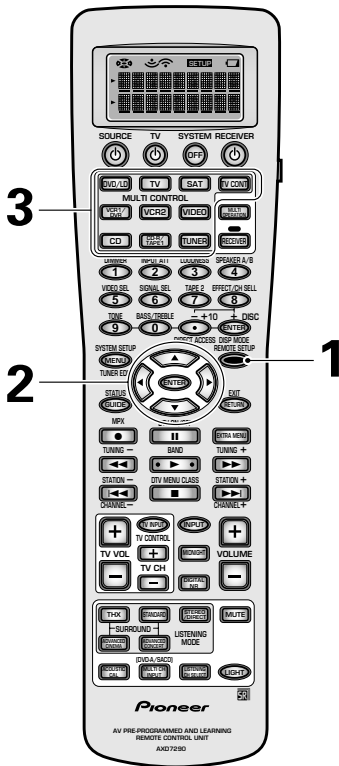

1 Press the **REMOTE SETUP** button for three seconds.

The **REMOTE SETUP** menu appears on the remote display.

2 Use the **▲▼** buttons to select **LEARNING** and press **ENTER**.

SELECT FUNCTION blinks on the remote control.

3 Press the **MULTI CONTROL** button for the component you want to control.

For example DVD/LD

SELECT KEY flashes in the display.

4 Choose the command you want to teach the remote control and press the corresponding button. The word **LEARN** will blink in the remote control display.

For example, choose the **▶** (play) button to program this remote control to play your DVD player.

- The **TV POWER**, **TV FUNC**, **TV CH +/-** and **VOL +/-** buttons are only available for learning when programming **TV CONT** button.

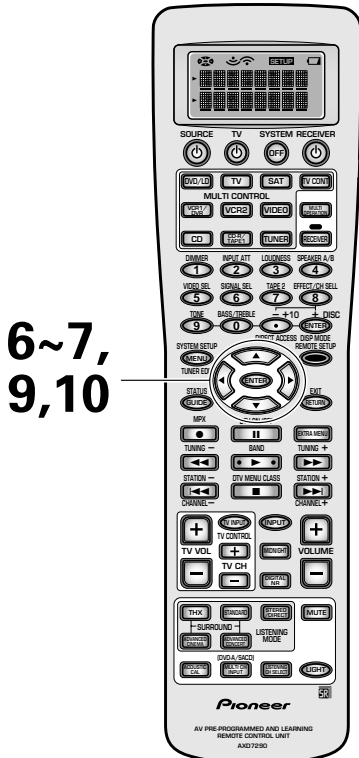

- 5 While LEARN continues to flash, point the two remote controls toward each other. Press the button on the other remote control corresponding to the operation you want to program.

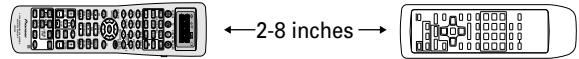

After the process is complete and the command has been learned, OK will appear in the remote control display. If NG (no good) appears, it means that for some reason the command was not learned. In this case, repeat steps 4 and 5. CONTINUE? appears in the remote's display. If SELECT KEY is flashing go back to step 4.

- 6 If you want to program in more commands use the ▲▼ buttons to select YES. Press ENTER.

Repeat steps 4 and 5 to teach the remote control of the VSX-47TX all the commands from the other remote control.

- 7 If you want to program in more commands for another MULTI CONTROL button use the ▲▼ buttons to select NO. Press ENTER.

- 8 Repeat the process from step 2 for all of your components.

Start again to program other components in this manner.

- 9 When you're done use the ▲▼ buttons to select EXIT.

You will return to the REMOTE SETUP menu.

- 10 Select EXIT and press ENTER.



- If FULL appears in step 5 it means that there isn't enough capacity to learn this command. If you want to clear other buttons to make room for this one follow the procedure on p.86.
- If there isn't enough capacity, an incorrect signal has been sent or, in some cases, the command from another remote control simply cannot be learned, "NG" (no good) will appear in the display in step 5.
- In some "NG" cases the remotes just need to be moved closer together or farther apart.

Remote Control of Other Components

Using Remote Control with Other Components

CD/MD/CD-R/VCR/DVD/LD/DVD recorder/Cassette Deck operations



- The following operations are available from the receiver's remote control after you program it (see "Setting Up the Remote Control to Control Other Components," p.62-65).
- To perform these operations, press the **MULTI CONTROL** button for the component you want to control.
- For more information on individual commands consult the manual that came with the component.

Button(s)	Function	Components
SOURCE	Press to switch the components between STANDBY and ON .	CD/MD/CD-R/VCR/DVD/LD/ DVD recorder/Cassette deck
	Press to return to the start of the current track or chapter. Repeated presses skips to the start of previous tracks or chapter.	CD/MD/CD-R/DVD/LD/
	Go back channels (channel -).	VCR/DVD recorder
	Play the reverse side of the tape on a reversible deck.	Cassette deck
	Press to advance to the start of the next track or chapter. Repeated presses skips to the start of following tracks or chapter.	CD/MD/CD-R/DVD/LD/
	Go forward channels (channel +).	VCR/DVD recorder
	Play the forward side of the tape on a reversible deck.	Cassette deck
	Pause playback or recording.	CD/MD/CD-R/VCR/DVD/LD/ DVD recorder/Cassette deck
	Hold down for fast forward playback.	CD/MD/CD-R/VCR/DVD/LD/ DVD recorder/Cassette deck
	Hold down for fast reverse playback.	CD/MD/CD-R/VCR/DVD/LD/ DVD recorder/Cassette deck
	Start playback.	CD/MD/CD-R/VCR/DVD/LD/ DVD recorder/Cassette deck
	Stop playback (on some models, pressing this when the disc is already stopped will cause the disc tray to open).	CD/MD/CD-R/VCR/DVD/LD/ DVD recorder/Cassette deck
	Starts recording.	MD/CD-R/VCR/DVD recorder/ Cassette deck
Number Buttons	Directly access tracks on a program source.	CD/MD/CD-R/LD
	Directly access chapter on a program source.	DVD/DVD recorder
	Directly select a channel.	VCR/DVD recorder
+10 Button	Select tracks or chapter higher than 10. Press this button and the remaining number to get the track or chapter (+10 Button + 3= track or chapter 13). Some components may operate differently.	CD/MD/CD-R/VCR/ DVD/LD/DVD recorder
ENTER/DISP MODE	Search mode	DVD
	Takes you to the disc navigator.	DVD recorder
	Changes between sides A & B of the disc.	LD
	Select channel 12 directly.	VCR
	Select the disc.	CD/MD/CD-R
MENU	Displays menus concerning the current DVD or DVR you are using.	DVD/DVD recorder
GUIDE	Displays the top menu of the current DVD or DVR you are using.	DVD/DVD recorder
RETURN	Takes you to the previous menu.	DVD/DVD recorder
& ENTER	Navigate DVD menus/options.	DVD/DVD recorder
	Basic playback options.	Double cassette 2nd deck

Remote Control of Other Components

Cable TV/Satellite TV/Digital TV/TV Operations



- The following operations are available from the receiver's remote control after you program it (see "Setting Up the Remote Control to Control Other Components," p.62-65).
- To perform these operations, press the **MULTI CONTROL** button for the component you want to control.
- For more information on individual commands consult the manual that came with the component.

Button(s)	Function	Components
TV	Press to switch the TV or CATV between STANDBY and ON .	Cable TV/ Satellite TV/ TV
TV INPUT	Press to switch the TV input.	TV
TV CH (+/-)	Select channels.	Cable TV/ Satellite TV/ TV
VOLUME (+/-)	Adjust the TV volume.	TV
MENU	Takes you to the TV menu of that system.	Cable TV/ Satellite TV/ TV/ Digital TV
GUIDE	Takes you to the guide menu of that system.	Cable TV/ Satellite TV/ TV/ Digital TV
RETURN	Exits the menu you are viewing.	Cable TV/ Satellite TV/ Digital TV
	A/BLUE	Satellite TV/ Digital TV
	B/DTV menu	Satellite TV
	C/GREEN	Satellite TV/ Digital TV
	D/RED	Satellite TV/ Digital TV
	E/YELLOW	Satellite TV/ Digital TV
Number Buttons (+10/ Buttons)	Use to select a specific TV channel.	Cable TV/ Satellite TV/ TV/ Digital TV
ENTER/DISP MODE	Use this button to immediately enter a new channel.	Cable TV/ TV
& ENTER	Press to select or adjust and navigate items on the menu screen.	Cable TV/ Satellite TV/ TV



- The first four buttons are dedicated to control the TV assigned to the TV CONT button. Thus if you only have one TV hooked up to this system, assign it to the TV CONT button. If you have two TVs, assign the main TV to the TV CONT button. If you hook up your system this way, the first four TV controls will always be accessible. For example, if you connect your TV to TV monitor, then use TV CONT for your TV. If you connect your TV to input source then use TV.
- Depending on the maker and individual model, there are some buttons that may not be able operate some equipment or may operate it in a different way.

Setting up the DIRECT FUNCTION

The direct function will not be necessary for most users. It is designed in case you have an external video source connected to your TV (a video source that is not going through the VSX-47TX). For this explanation we'll call this the "external video deck." You'd like to control external video deck with this unit's remote control so you've assigned it a function button (for example purposes, the VCR 2 button). Yet, if you put the receiver in VCR 2 mode you'll get no picture on your TV because the external video deck signal is not going through the VSX-47TX. To get around this problem you set the DIRECT FUNCTION for VCR 2 to OFF. Now when you press VCR 2 function button you can control the external video deck with the remote but the receiver does not go into VCR 2 mode.

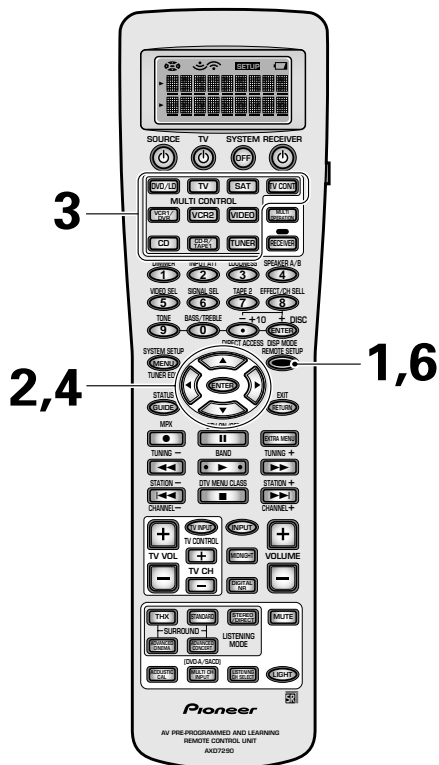

1 Press the REMOTE SETUP button for three seconds.

The REMOTE SETUP menu appears on the remote display.

2 Use the ▲▼ buttons to select DIRCTFNC and press ENTER.

SELECT FUNCTION will flash in the remote control display.

3 Press the MULTI CONTROL button of the component whose direct function you want to turn on or off.

DIRECTFUNC appears on the remote control display.

4 Use the ▲▼ buttons to select ON, OFF, or EXIT and press ENTER.

ON: The direct function is on.

OFF: The direct function is off.

EXIT: Leaves the DIRECT FUNCTION settings and returns you to the REMOTE SETUP menu.

After you press ENTER, if you chose one of the first two settings, COMPLETE will appear in the display.

5 Repeat steps 2-4 to set the direct function for as many components as you want.

6 Press the REMOTE SETUP button to return to the previous mode.



- To exit from the remote control setup mode at any time, press **REMOTE SETUP**.
- The default setting for all DIRECT FUNCTIONS is ON.

Using Other Functions

Recording from Audio/Video Components

The following explanations show you how make a recording from one component to another connected to this receiver. Note that an analog recorder (such as a VCR) cannot record from a source that is connected using only a digital connection. Likewise, a digital recorder (such as a CD-R) cannot record digitally from a component that is connected using only analog connections. In both of these cases, make sure that the digital component also has analog connections to the receiver, and that the SIGNAL SELECT is set to ANALOG.

When recording from one digital component to another, bear in mind that the digital signal output from this receiver mirrors the input from the source. So if the input is, say, Dolby Digital, the output will also be Dolby Digital. Before recording, make sure that the recorder is compatible with the source digital audio format.

See p.20 for more on analog audio connections and p.22-23 for digital audio connections.



- The receiver's volume, channel level, balance, TONE, Digital NR, MIDNIGHT, LOUDNESS, ACOUSTIC CAL EQ and surround effects have no effect on the recorded signal.
- In some cases, digital recordings have copy guard protections and making a digital copy is not possible. In this case you can only copy them in an analog manner.
- When the source is the connected to the MULTI CH IN jacks, only the front left/right channels can be recorded.
- Some video recordings are copy-protected; these sources cannot be recorded.
- When recording video, the source must be connected to the receiver using the same type of video cord (composite, or S video) as you used to connect the recorder to the receiver.

Functions that can be recorded

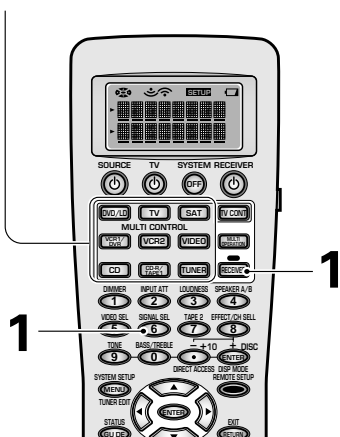

1 Select the source component. Set SIGNAL SELECT according to the source component's signal (ANALOG or DIGITAL).

2 Start recording (tape deck, CD recorder, VCR, etc.)

3 Playback the source to be recorded.

Record monitor (TAPE 2 MONITOR)

If you connect a cassette deck with a record monitor function to the TAPE 2 MONITOR jacks, you can listen to the sound of an analog recording as it is being recorded.

Press TAPE 2 MONITOR to switch between the sound of the recording (TAPE 2 indicator on) and the sound of the source component (TAPE 2 indicator off).



- To record the TAPE 2 MONITOR signal to a recorder connected to the CD-R/TAPE 1 inputs, select any input except CD-R/TAPE 1 and switch the TAPE 2 MONITOR on.

Speaker System B Setup

Stereo playback in another room

Connect a pair of speakers to the B speaker terminals to listen to stereo playback in another room (kitchen, bedroom, etc.). Select NORMAL SURROUND and choose the speaker system setup that you want. See the next page for more details on these speaker system settings. Please use speakers with a nominal impedance rated 6Ω-16Ω.

Bi-amping the front speakers

For bi-amp playback you can connect both the A and B speaker terminals to your front speakers. To do this your speakers must be bi-wireable (that is they must have separate terminals for the high and low frequencies).

Bi-amping delivers more power to the front speakers, but disables the surround back speakers, so you will be limited to 5.1 channel playback.

Caution!

Do not allow any speaker wire from any terminal to touch a wire from a different terminal.

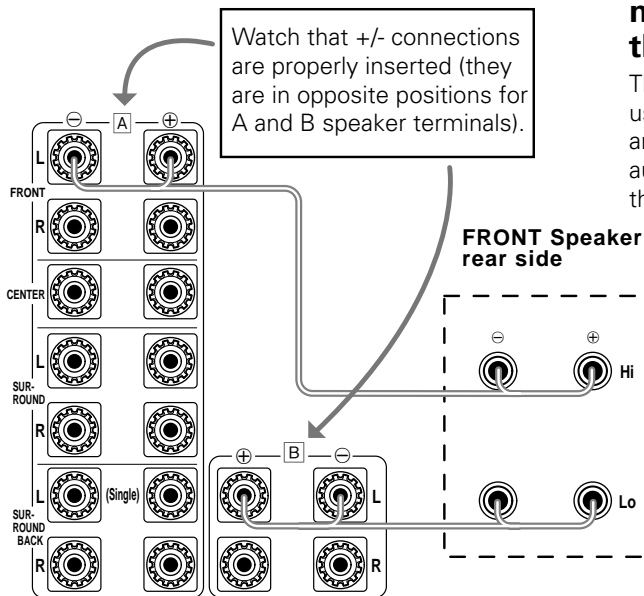

1 Connect your speakers as shown.

Since both Front A and B speaker terminals output the same audio, it doesn't matter which set (A or B) is powering which part (HI or LOW) of the speaker.

2 Select BI-AMP(5.1). If you need more information on how to do this see page 37, step 3.

The surround back channel amplifier is now used to power the B set of speaker terminals and the A+B (SP►AB) speaker setting is automatically selected. The speaker setting in this case can only be A+B or OFF.

Caution!

Most speakers with both Hi and Low terminals have two metal plates that connect the Hi to the Low terminals. These must be removed when you are bi-amping the speakers or you could severely damage the amplifier. See your speaker manual for more information.

Bi-wiring your speakers

In order to do this your speakers must be bi-wireable (that is they must have separate terminals for the high and low frequencies).

To bi-wire a speaker, connect two sets of speaker cords to each speaker terminal on the receiver. The easiest way to do this is to connect one wire in the normal way, and use a banana plug for the other one. Make sure you use a parallel (not series) connection when doing so. Don't connect different speakers from the same terminal in this way.

70 When using this kind of connection, select NORMAL SURROUND.

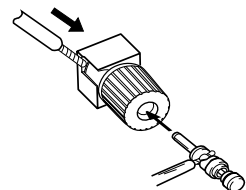

Switching A/B Speaker System

This unit has three types of speaker systems A, B, A&B. This switch allows you to select the speaker system you will use.

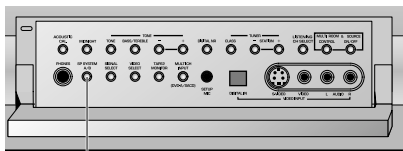
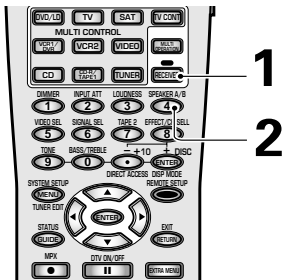

2

A(SP▶A):

Sound is output from speaker system A and the same signal is output from the pre out terminals.

B(SP▶B):

Sound is output from the two speakers in speaker system B. Multichannel sources will be downmixed to these two speakers and the same signal is output from the FRONT pre outs.

A&B(SP▶AB):

Sound is output from speaker system A's FRONT speakers and the B speakers. The other channels (excluding the LFE channel) will be downmixed to the FRONT speakers. If you have set the FRONT speakers to "SMALL" the low frequencies of all the channels are output from the subwoofer. The same sound is output from the B speakers and the FRONT pre out terminals.

OFF(SP▶):

No sound is output from the speakers. Depending on the input signal and settings in "SPEAKER SYSTEMS" sound may be output from the subwoofer. The same sound is output from the pre out terminals as when selecting speaker system A (above).



- What is output from the subwoofer depends on the SPEAKER SYSTEM settings and the type of source.
- Depending on the settings in "SPEAKER SYSTEMS" and the MULTI CH IN SELECT, output from the SURROUND BACK pre out terminals may change.
- When using headphones the speakers are switched off.
- Please use speakers with a nominal impedance rated 6Ω-16Ω.

Connecting Additional Amplifiers

This receiver has more than sufficient power for any home use, but it is possible to add additional amplifiers to every channel of your system. Make the connections shown below to add amplifiers to power your speakers. Before making or changing the connections, switch off the power and disconnect the power cord from the AC outlet. Take out the U-shaped connectors (see p.30) if you connect an external amp to power the front left and right speakers.

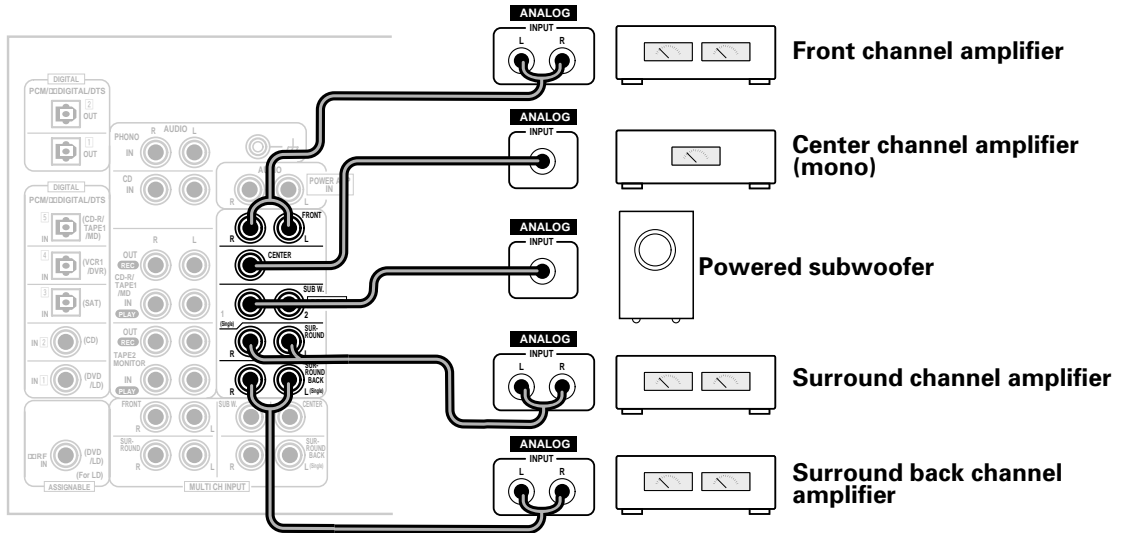

- You can use the additional amplifier on the surround back channels for a single speaker as well. In this case plug the amplifier into the L (SINGLE) terminal only.

Pre Out Power Setup

Using an separate stereo pre-amplifier

It is possible to use a separate stereo pre-amp in conjunction with this receiver. You might want to do this if you need to connect more sources than this receiver can accommodate.

You can connect sources to either this receiver or to the external pre-amp (giving you a greater number of input possibilities). For stereo sources connected directly to the external pre-amp, this receiver acts as a standard power amplifier. For digital sources connected to this receiver, the receiver acts as a digital decoder/digital-to-analog converter and as a power amplifier.

- 1 Remove the U-shaped connectors that connect the FRONT PRE OUT jacks to the POWER AMP IN jacks.
- 2 Use a stereo RCA audio cable to connect the FRONT PRE OUT jacks of this receiver to a stereo input on the pre-amp.
Use any input except phono.
- 3 Use a stereo RCA audio cable to connect the stereo pre-out jack of the pre-amp to the POWER AMP IN jack of this receiver.

Using a separate power amplifier for main room stereo sound

An alternative multi room setup involves using a separate power amplifier to power a pair of stereo speakers in the main room, while using this receiver to power the sub-room speakers. You might want to do this if your power requirements for the main room are not met by this receiver.

- 1 Connect the MULTI ROOM OUT jacks to the POWER AMP IN jacks (both on this receiver).
- 2 Use a stereo RCA audio cable to connect the FRONT PRE OUT jacks of this receiver to the power amp's inputs.
- 3 Connect the sub room speakers to the FRONT A speaker outputs on this receiver.
- 4 Connect the main room speakers to the speaker outputs on the power amp.

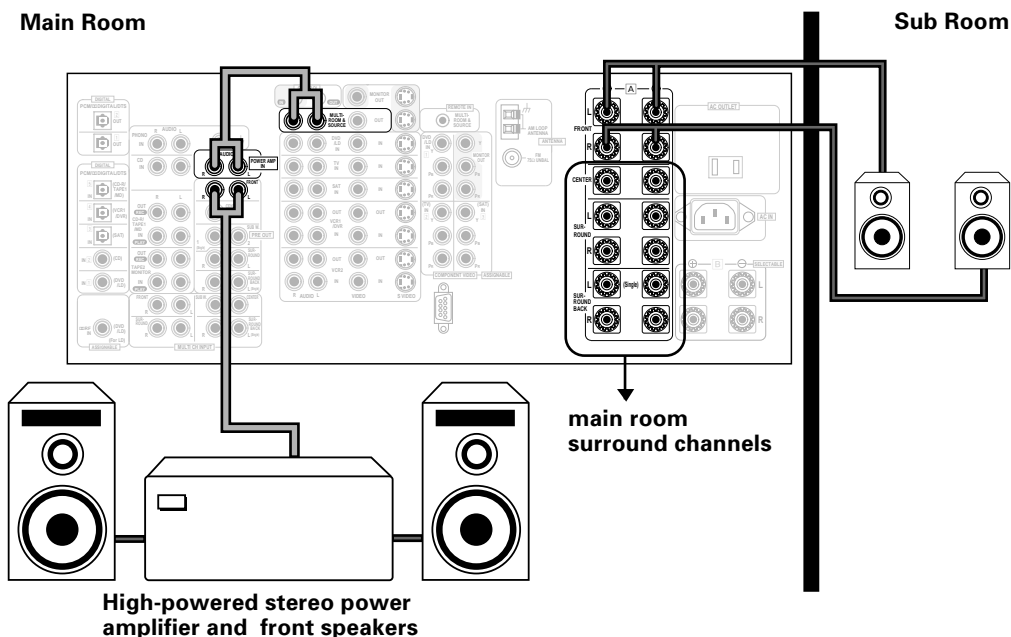

Multi-Room

When used together with an optional IR receiver, this receiver is capable of outputting two different sources at the same time. One to the VIDEO OUT jack and SPEAKERS terminals and another to the MULTI ROOM & SOURCE AUDIO and VIDEO OUT jacks. Thus the VSX-47TX can power two independent systems, in separate rooms, listening to or watching different sources. With this system the two rooms can have completely independent power (the main room power can be off while the sub room is on) and the sub room can be controlled by this unit's remote control. If you go into the main room to change the source but forget the remote control it's not a problem. While in MULTI ROOM mode the input selector on the front panel of the VSX-47TX is able to change the input even though the receiver is off.

MULTI-ROOM connections

On the VSX-47TX, connect the IR receiver sensor to the MULTI-ROOM & SOURCE REMOTE IN jack, then connect a separate amplifier (and speakers) and TV monitor to the MULTI-ROOM & SOURCE AUDIO and VIDEO OUT jacks. All of this equipment should be placed in your sub-room as shown below.



- When connecting the IR receiver, be sure to connect it to the green MULTI-ROOM & SOURCE REMOTE IN jack, not the black CONTROL IN or OUT jacks.
- It is not possible to input digital signals into the sub room. You must use an analog signal.
- You can't use tone controls (etc.) or any surround modes in the sub room.

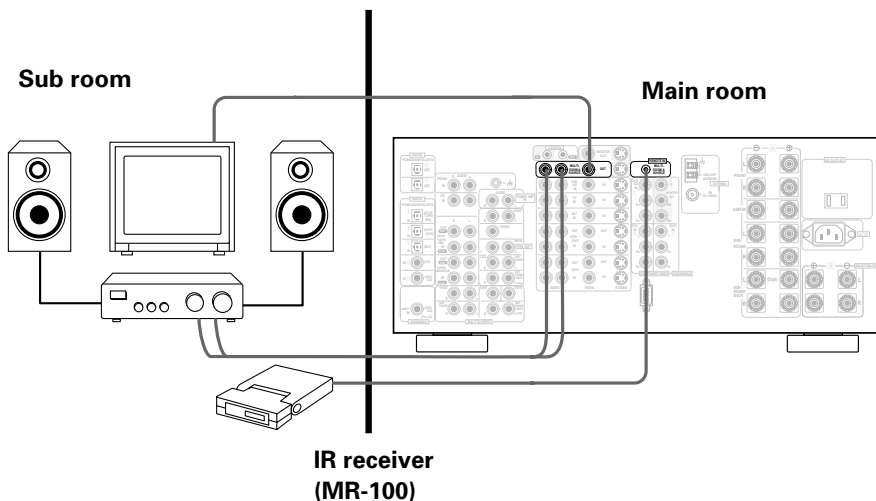

Setup example

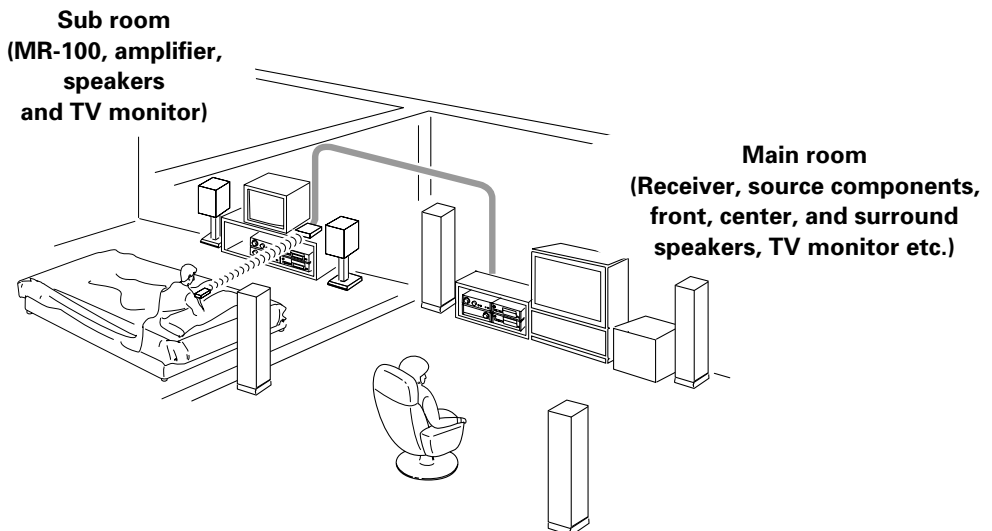

MULTI-ROOM setup

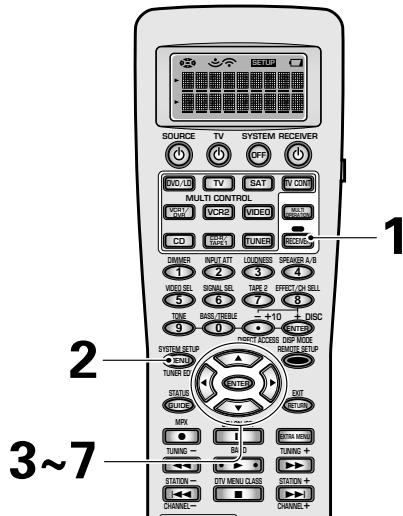

1 Turn on the receiver, your TV and press RECEIVER on the remote control.

Make sure your TV is set to the receiver.

2 Press the SYSTEM SETUP button then select EXPERT SETUP using ▲ and ▼. Press ENTER.

The EXPERT SETUP menu appears on the OSD.

3 Use the ▲▼ buttons to select MULTI-ROOM SETTING . Press ENTER.

4 Select the VOLUME LEVEL by selecting VARIABLE or FIXED.

If you hook up a just a power amplifier in the sub room the VSX-47TX will act as a pre-amp. In this case choose VARIABLE for the VOLUME LEVEL setting. If you hook up a full integrated amplifier in the sub room (such as another Pioneer VSX receiver) choose FIXED for the VOLUME LEVEL setting.

CAUTION!

If the MULTI ROOM is set to FIXED the volume on the main unit will be set to maximum. Thus, when output, it will be extremely loud. Please set the master volume controls of the integrated amplifier in the sub room very low at first and experiment to find the correct volume.

5 Select the IR RECEIVER type.

If you have an IR receiver from a different company than PIONEER, select OTHERS. If you have the Pioneer-made MR-100, or the IR receiver you're using doesn't seem to work after selecting OTHERS, select PIONEER.

6 Select RETURN (use ▼▲) then press ENTER to go back to the EXPERT SETUP menu.

7 Use the ▼▲ buttons to select RETURN and press ENTER, again. Then use the ▼▲ buttons to select EXIT and press ENTER.

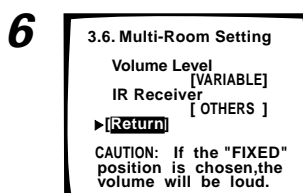
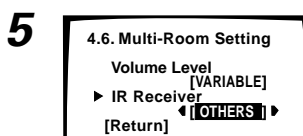
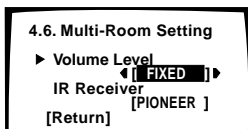
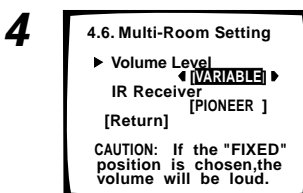
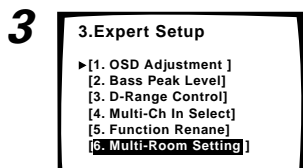
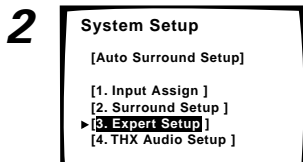

There may be some IR receivers that can't be used with this receiver. Check with a PIONEER representative to be sure.

Controlling the MULTI-ROOM system from the main room

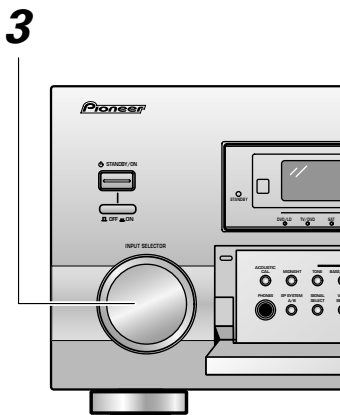
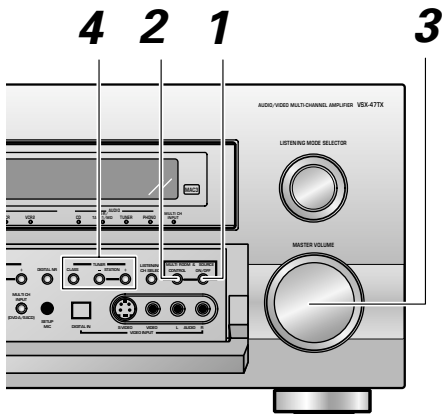

1 Press the MULTI ROOM & SOURCE ON/OFF button to turn on the MULTI ROOM system.

The display shown below will illuminate when the receiver is in STANDBY mode. Also, the MULTI ROOM indicator will light.



2 Press the CONTROL button to enter the control mode.

All operations regarding the sub-room MUST be made while "MULTI ROOM" appears in the receiver's display. Once it reverts to its previous display any adjustments will affect the main room, not the sub room.

3 Select the source with the INPUT SELECTOR and adjust the VOLUME. The volume can be adjusted in a range of -60dB to 0dB.

If you have selected FIXED for the volume level in the Multi-Room Setup (previous page), you can't adjust the volume.

For this example we'll use the DVD/LD function. The display shown below will illuminate.



The volume doesn't appear if you selected FIXED.

The INPUT SELECTOR steps through the functions in the following order:

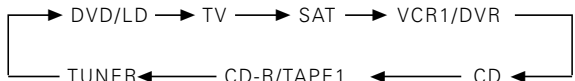

If you don't turn the MULTI ROOM function off the receiver will not turn off completely.

4 When in TUNER function, press the CLASS button and use STATION +/- to select the station.

The display will appear as shown below.

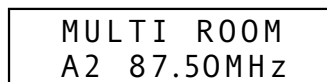
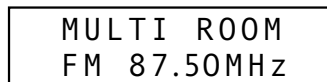

Press CONTROL at any time to exit the control mode of the MULTI ROOM system.

Press MULTI ROOM & SOURCE ON/OFF button at any time to turn off the MULTI ROOM system.

Controlling the MULTI-ROOM system from the sub room

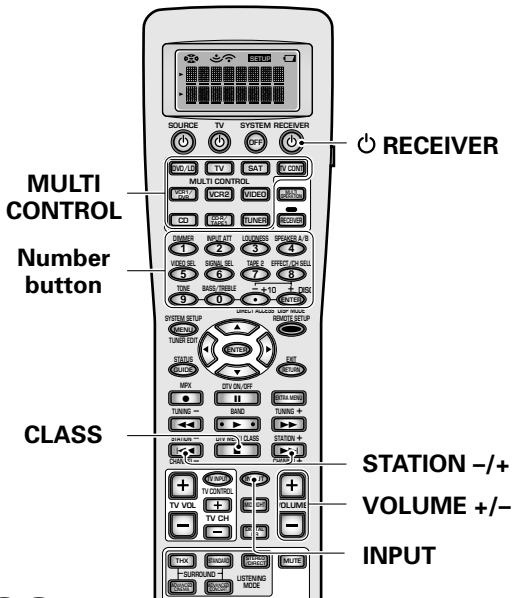

- If the main power ON/OFF button has been switched OFF, you can't use the MULTI ROOM function. Make sure the system is in STANDBY mode or ON.
- When someone is controlling the system from the main room you won't be able to operate the remote room controls.
- When you are doing the system setup process the MULTI-ROOM cannot be used.
- If you use a PIONEER amplifier in the sub room, when you want to control the VSX-47TX only you will also change the settings in the sub room. To avoid this, cover up the remote sensor on the sub room amplifier.

- 1 From the sub room, point the remote control at the IR Receiver and press a \odot STANDBY/ON button to turn on the MULTI-ROOM system.**

The MULTI ROOM & SOURCE indicator lights on the front panel in the main room.

- 2 Press the INPUT button to select the sub room source.**

You can also use a specific MULTI CONTROL button (for example, the DVD/LD button) for this purpose.

- 3 Press VOLUME +/- to adjust the volume.**

The following remote control buttons can be used to operate the receiver from the sub room.

- \odot RECEIVER button
- MULTI CONTROL button (will not select PHONO, VCR 2 or VIDEO)
- VOLUME +/- buttons (for adjusting the sub-room's volume level, but can't be used when set to FIXED)
- CLASS button (for selecting the memory class you want)
- STATION +/- button (for recalling memorized radio stations (the tuner is selected automatically))
- Number button (0~9)

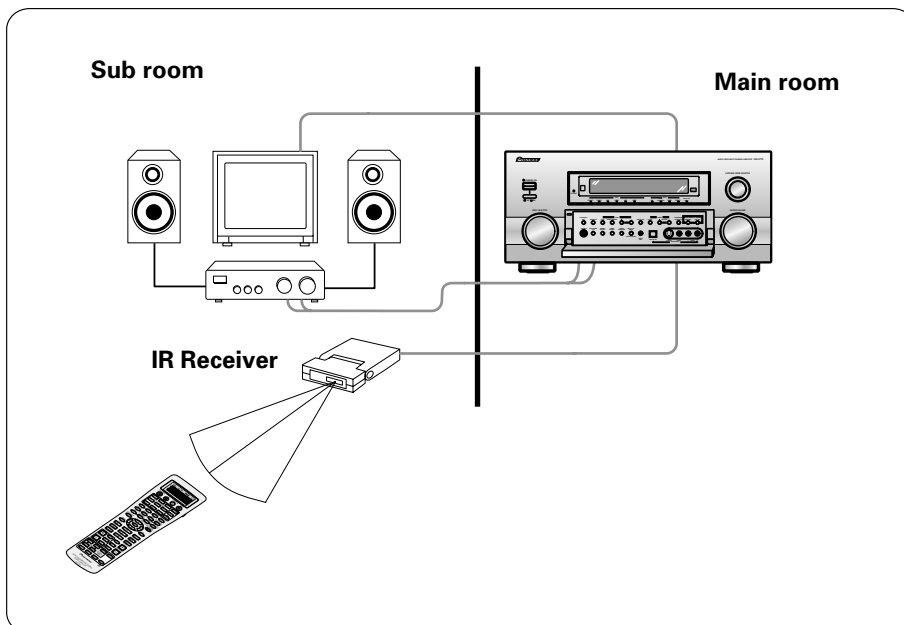

Using Other Functions



- Remote operation may not be possible if direct light from a strong fluorescent lamp is shining on the IR receiver remote sensor window.
- The tuner cannot be tuned to more than one station at a time. Therefore, changing the station in one room also changes the station in the other room. Please be careful not to change stations when recording a radio broadcast.
- The volume levels of the main and sub rooms are independent.
- When more than one remote control signal is transmitted at the same time, the receiver does not operate.
- When operating MULTI-ROOM & SOURCE with the MULTI-ROOM & SOURCE OUT jacks connected to a sub room amplifier which bears the PIONEER SR mark and has a remote sensor, both the IR receiver and the amplifier may receive remote control commands (making correct operation impossible). In this case, place the IR receiver and amplifier apart from each other, and point the remote control directly at the IR receiver during operation.
- If you plan to leave the MULTI ROOM feature off for a lengthy period please turn off the power in both the sub and main rooms. Make sure the STANDBY indicator turns red and the MULTI ROOM indicator goes off.
- If you send the SYSTEM OFF command from the sub room by remote control, the power of both rooms will go off. Please be careful when making a recording in the main room.

The PIONEER SR System: Operating other PIONEER components

Connecting an optional control cord allows you to operate other PIONEER components simply by pointing the receiver's remote control at the remote sensor on the front panel of the receiver. The receiver then sends the remote control signals to the other devices via the CONTROL OUT terminal.

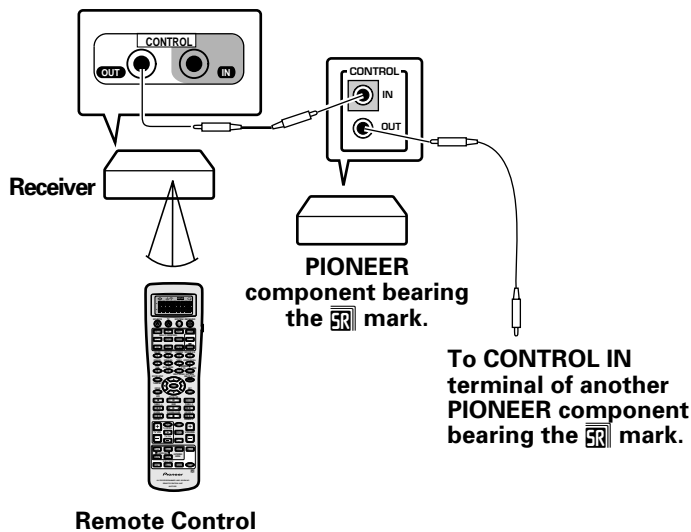

- You can also control PIONEER components (and those made by other manufacturers) by pointing the receiver's remote control directly at the respective component. This type of operation does not require control cords. All you have to do is recall the appropriate stored settings (see p.62- 63).
- If you use a remote control hooked up via the CONTROL IN jack with a control cord, you won't be able to use this unit's remote control.
- If you use this feature make sure an analog (audio and/or video) connection has been made between the units.

Multi Operations

Multi operations allow you to tell the receiver and your other components to do a number of things with the push of only two buttons on the remote control (see "Performing Multi Operations" on the next page). For example, you can program the unit to turn on your TV, turn on your DVD player and start playing the loaded DVD. This allows you to freely decide which operations you want performed as well as the order in which you want them performed. The steps below show you how to program a string of up to 5 different operations for each MULTI CONTROL button. You don't need to program the power of this receiver (or any Pioneer component used) to go on, it (or they) will do so automatically when multi operations are performed.



Be sure to set up each component before programming multi operations (see "Setting Up the Remote Control to Control Other Components", p.62-65).

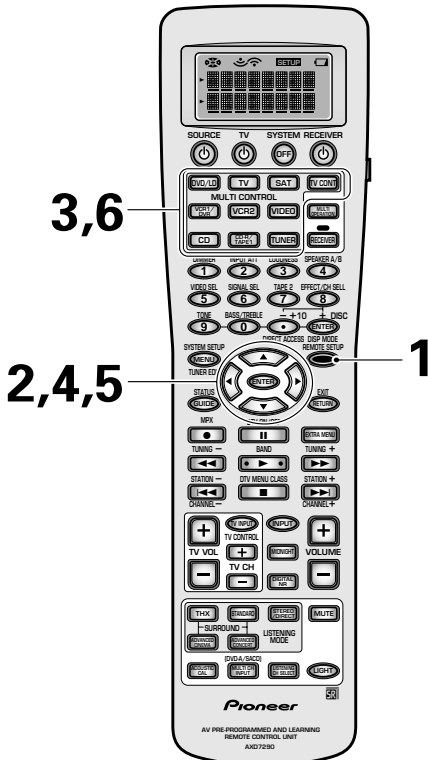

1 Press the REMOTE SETUP button for more than three seconds.

The REMOTE SETUP menu appears on the remote display.

2 Use the ▲▼ buttons to select MULTI OPE and press ENTER.

SELECT FUNCTION blinks on the remote display.

3 Press the MULTI CONTROL button for the component you want to start the MULTI OPERATIONS with. MULTI OPE appears in the display.

For example, DVD/LD

4 Use the ▲▼ buttons to select first command. "1st Cmmnd" appears in the display. Press ENTER.

This tells the receiver this will be the first command.

To erase a command

Select CLEAR and press ENTER. Then go to step 8.

To go back one step

Select EXIT and press ENTER.

5 To setup a command select CHANGE and press ENTER.

FUNCTION flashes in the display,

6 Select the component whose command you want to input (for example, a DVD player), and press the MULTI CONTROL button for it.

KEY will flash in the display.

7 Select a button for the command you want to input (for example, ► [play]).

COMPLETE appears in the display.

8 Repeat steps 4-7 to program a sequence of up to five commands.

You can assign MULTI OPERATIONS for up to 5 commands for each MULTI CONTROL button.



- To exit from the remote setup mode at any time press the REMOTE SETUP button.
- The display will disappear after one minute or so if no new commands are entered. Press any button to 'wake up' the remote and continue the process.

Using Other Functions

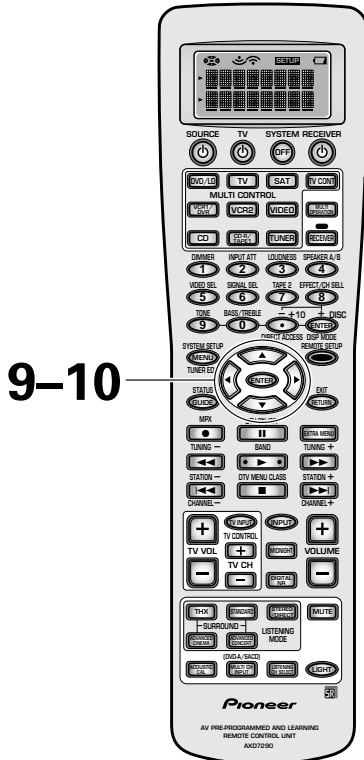

9 When done select EXIT and press ENTER.

You will return to the REMOTE SETUP menu. Start again from step 2 if you want to set do another MULTI CONTROL button.

10 Select EXIT and press ENTER again.



You don't need to program power on for PIONEER components (except for the first generation of Pioneer DVRs), they will go on automatically if a command for that unit is entered in the MULTI OPERATIONS settings. Also, your TV will go on automatically if a TV related command is entered in the MULTI OPERATIONS.

Performing Multi Operations

Do the following to use the MULTI OPERATIONS.

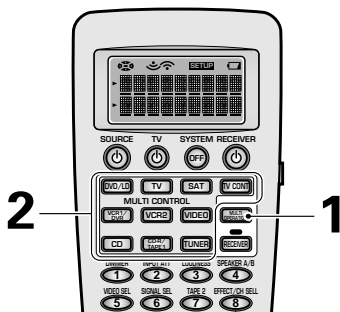

1 Press the MULTI OPERATION button.

SELECT FUNCTION flashes in the display,

2 Press the MULTI CONTROL button for the component that has been set up with multi operations.

The power of the receiver (and any Pioneer components use in the program) goes on and the programmed multi operations are performed automatically.

System Off

The SYSTEM OFF feature allows you to tell the receiver and your other components to stop and/or turn off with the push of only one button on the remote control. For example, you can program the unit to stop your DVD, turn off your TV and turn off your DVD player. You don't need to program power off for PIONEER components, they will go off automatically in this mode. The receiver itself will go off automatically as well. The steps below show you how to program a string of up to 5 different SYSTEM OFF operations.



Be sure to set up each component before programming the SYSTEM OFF function (see "Setting Up the Remote Control to Control Other Components", p.62-65).

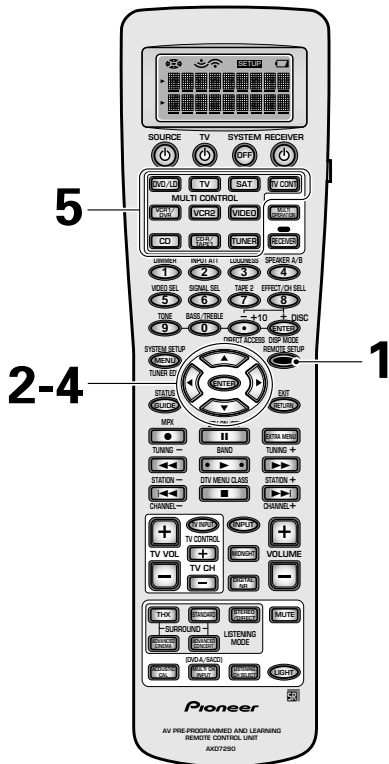

1 Press the REMOTE SETUP button for more than three seconds.

The REMOTE SETUP menu appears on the remote display.

2 Use the ▲▼ buttons to select SYS OFF and press ENTER.

SYSTEM OFF appears in the remote display.

3 Use the ▲▼ buttons to select first command. "1st Cmmnd" appears in the display. Press ENTER.

This tells the receiver this will be the first command.

To erase a command

Select CLEAR and press ENTER. Then go to step 7.

To go back one step

Select EXIT and press ENTER.

4 To setup a command select CHANGE and press ENTER.

FUNCTION flashes in the display,

5 Select the component whose command you want to input (for example, a DVD player), and press the MULTI CONTROL button for it.

KEY will flash in the display.

6 Select a button for the command you want to input (for example, ■ [stop]).

COMPLETE appears in the display.

7 Repeat steps 3-6 to program a sequence of up to five commands.

You can assign SYSTEM OFF information for up to 5 commands.



- To exit from the remote setup mode at any time press the REMOTE SETUP button.
- The display will disappear after one minute or so if no new commands are entered. Press any button to 'wake up' the remote and continue the process.

Using Other Functions

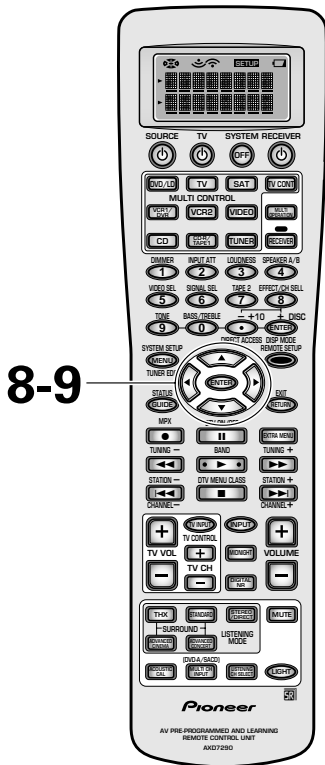

8 When done select EXIT and press ENTER.

You will return to the REMOTE SETUP menu.

9 Select EXIT and press ENTER again.

Using System Off

Do the following to use the SYSTEM OFF function.

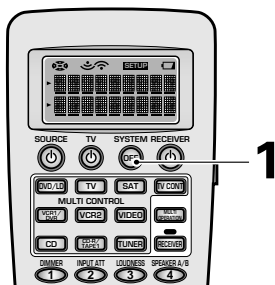

1 Press the SYSTEM OFF button.

The remote control must be on to be able to use this command but it can be in any mode.

All the components programmed into the SYSTEM OFF mode will stop and/or go off. The receiver and Pioneer components will go off as well.

Editing Remote Control Display Names

Use this capability to rename the display on the remote control for different MULTI CONTROL buttons (DVD/LD, etc.). For example, you could change "TV" to "DVD2". In this way you can personalize your system. This is similar to the feature on p.95 but that feature changes the display on the receiver.

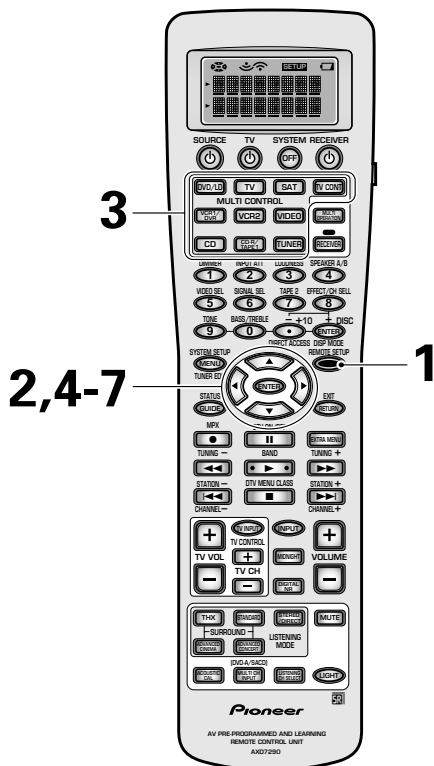

1 Press the REMOTE SETUP for more than three seconds.

The REMOTE SETUP menu appears on the remote display.

2 Use the ▲▼ buttons to select FUNCNAME and press ENTER.

SELECT FUNCTION will flash in the display.

3 Press the MULTI CONTROL button for the component you want to rename.

For example, "TV"

4 Use the ▲▼ buttons to select the letters and/or numbers you want to enter and use the ◀▶ buttons to move the cursor to the next position.

Here are the possible letters/numbers.

```

ABCDEFGHIJKLMN OPQRSTUVWXYZ
abcdefghijklmnopqrstu vwxyz
0123456789
!#%&'()*+,-./:;<=>?
@[\^_`{|}~▶◀◂◃◅◆◇◈◉◊○◌◍◎●◐◑◒◓◔◕◖◗◘◙◚◛◜◝◞◟◠◡◢◣◤◥◦◧◨◩◪◫◬◭◮◯◰◱◲◳◴◵◶◷◸◹◺◻◼◽◾◿◿(space)

```

You can input up to eight letter/numbers.

5 When you're finished press ENTER, END will blink, press ENTER again.

The COMPLETE appears in the display.

6 Go back to step 2 to input as many function names as you want.

7 Select EXIT and press ENTER.



- To exit from the remote setup mode at any time press the REMOTE SETUP button.
- The display will disappear after one minute or so if no new commands are entered. Press any button to 'wake up' the remote and continue the process.

Using Other Functions

Editing Button Names (KEY LABEL)

Use the KEY LABEL capability to rename the display on the remote control for different buttons (keys). You would want to do this if you taught a specific button a new operation.

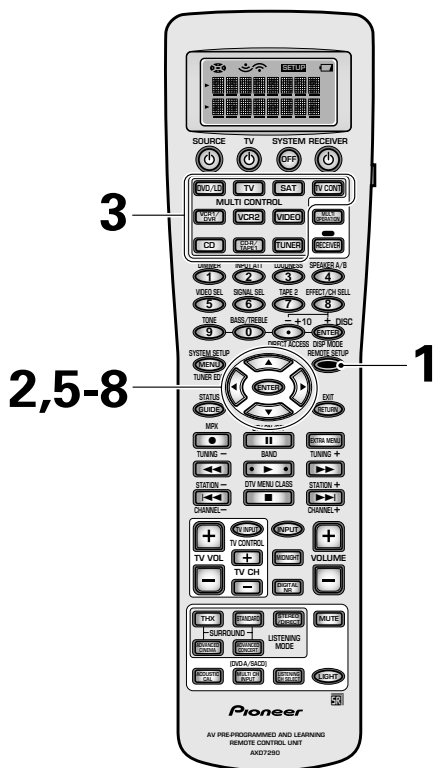

1 Press the REMOTE SETUP for more than three seconds.

The REMOTE SETUP menu appears on the remote display.

2 Use the ▲▼ buttons to select KEY LABEL and press ENTER.

SELECT FUNCTION will flash in the display.

3 Press the MULTI CONTROL button for the component whose button you want to rename.

For example DVD/LD
SELECT KEY flashes in the display.

4 Press the buttons whose name you want to change.

For example, ►
The name-changing screen appears in the display.

5 Use the ▲▼ buttons to select the letters and/or numbers you want to enter and use the ◀▶ buttons to move the cursor to the next position.

Here are the possible letters/numbers.

```
ABCDEFGHIJKLMNOPQRSTUVWXYZ  
abcdefghijklmnopqrstuvwxyz  
0123456789  
!#%&'()*+,-./:;<=>?  
@[\|^_`{}~▶◀■●⊕↑↓↔◀▶(space)
```

You can input up to eight letter/numbers.

6 When you're finished press ENTER, END will blink, press ENTER again.

COMPLETE appears in the display.

7 Go back to step 2 to input as many button names as you want.

8 Select EXIT and press ENTER.



- To exit from the remote setup mode at anytime press the REMOTE SETUP button.
- The display will disappear after one minute or so if no new commands are entered. Press any button to 'wake up' the remote and continue the process.

Adjusting the Light on the Remote Control

This feature allows you to adjust the brightness of the light on the remote control.

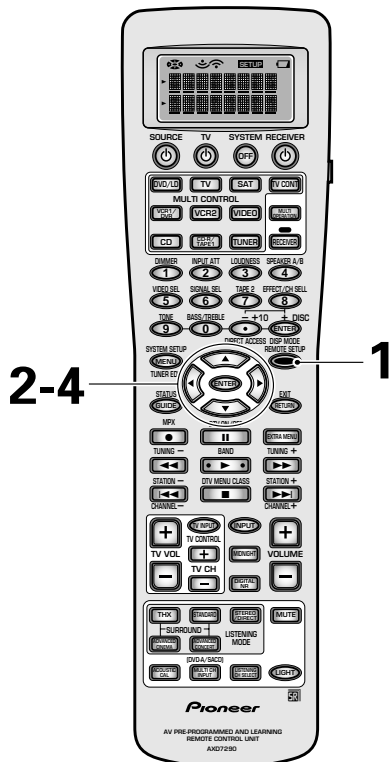

1 Press the **REMOTE SETUP** button for three seconds.

The **REMOTE SETUP** menu appears on the remote display.

2 Use the **▲▼** buttons to select **LIGHT** and press **ENTER**.

3 Use the **▲▼** buttons to select **HIGH**, **LOW**, or **EXIT** and press **ENTER**.

HIGH : The brightest setting

LOW : A dimmer setting

EXIT : Leaves the **LIGHT** setting and returns you to the **REMOTE SETUP** menu.

After pressing **ENTER** in the first two cases, **COMPLETE** will appear in the display and you will be returned to the **REMOTE SETUP** menu.

4 Select **EXIT** and press **ENTER**.



- To exit from the remote setup mode at any time press the **REMOTE SETUP** button.
- The display will disappear after one minute or so if no new commands are entered. Press any button to 'wake up' the remote and continue the process.

Clearing Remote Control Settings You Have Input

This feature allows you to clear a particular setting, or all of the settings from a function in the REMOTE SETUP menu.

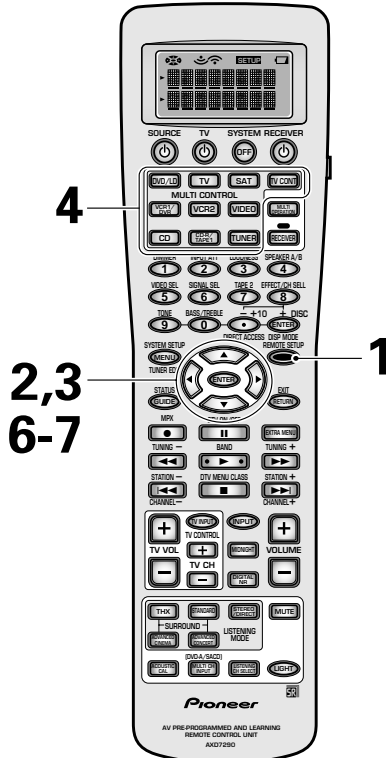

1 Press the REMOTE SETUP button for three seconds.

The REMOTE SETUP menu appears on the remote display.

2 Use the ▲▼ buttons to select CLEAR and press ENTER.

CLEAR appears in the display.

3 Use the ▲▼ buttons to select one setting, or all of the settings, and press ENTER.

The choices in this feature include:

LEARNING CLEAR: allows you to clear one command you have set in the LEARNING function. After pressing ENTER SELECT FUNCTION flashes in the display. Go to step 4.

KEYLABEL CLEAR: allows you to clear one button name you have set in the KEYLABEL function. After pressing ENTER SELECT FUNCTION flashes in the display. Go to step 4.

ALL CLEAR: Allows you to clear all the REMOTE SETUP settings. After pressing ENTER, CLEAR? appears in the display. Go to step 6.

EXIT: Returns you to the REMOTE SETUP menu.

4 Press the MULTI CONTROL button for the component whose command or key label you want to clear.

SELECT KEY flashes in the display.

5 Press the button you want to clear.

The button chosen will appear in the display. CLEAR? will appear in the display.

6 Use the ▲▼ buttons to select YES, NO or EXIT and press ENTER.

YES: clears the setting.

NO and **EXIT:** leaves the setting as is and returns you to the REMOTE SETUP menu.

If you select YES and press ENTER then COMPLETE appears in the display and you are returned to the REMOTE SETUP menu.

7 Select EXIT and press ENTER.



- To exit from the remote setup mode at any-time press the REMOTE SETUP button.
- The display will disappear after one minute or so if no new commands are entered. Press any button to 'wake up' the remote and continue the process.

Resetting the Main Unit

The following operations allow you to reset the unit to the default settings.

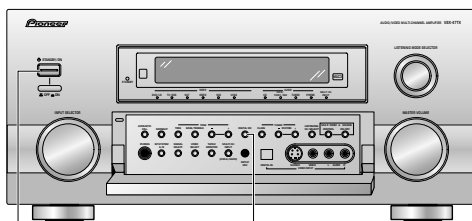

1 While holding down the **DIGITAL NR** button press the **STANDBY/ON** button for about three seconds.

2 When you see **RESET?** appear in the display, press the **TONE -** button. **OK?** appears in the display, press **TONE +**.

All the settings, including the speaker, surround sound settings and tuner settings will be reset the unit to the factory default settings.

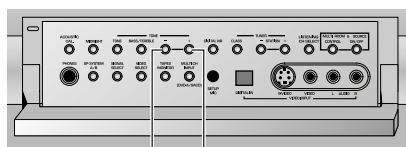

2 2

Advanced Setup

Assigning the Digital Inputs

If you did not hook up your digital equipment in accordance with the default settings for the digital inputs (see p.17, 19 & 22-23) you need to complete the procedure below. You have to do this in order to tell the receiver what digital equipment is hooked up to which terminal so the buttons on the remote correspond to what you have hooked up.

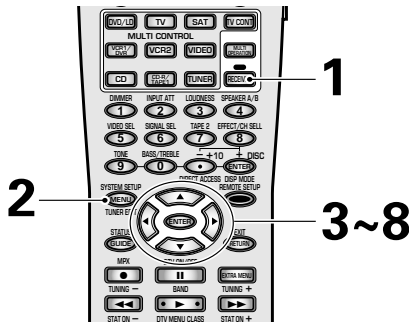

1 Turn on the receiver and your TV, press the **RECEIVER** on the remote control.

2 Press the **SYSTEM SETUP** button.

3 Looking at the on-screen display on your TV, use the **▲▼** buttons to select **INPUT ASSIGN**. Press the **ENTER** button.

4 **DIGITAL-IN SELECT** should be selected, if not use the **▲▼** buttons to select it. Press the **ENTER** button.

5 Use the **▲▼** buttons to move through the different digital input settings and use the **◀▶** buttons to select the component that you hooked up to that digital in.

6 If you're not sure which component is connected to which digital in, look on the back of the receiver and check the cables you connected.

7 When you're finished use the **▲▼** buttons to select **RETURN** and press **ENTER**.

This exits the "Assigning the Digital Inputs" mode.

8 Use the **▲▼** buttons to select **RETURN** and press **ENTER**, again. Then, use the **▲▼** buttons to select **EXIT** and press **ENTER**.

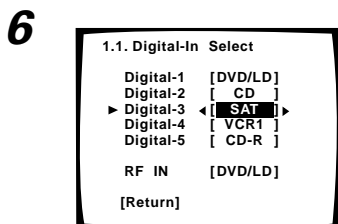
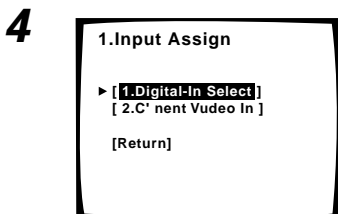
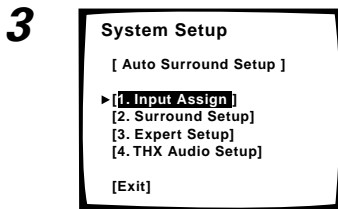

- The possible digital inputs that can be assigned are: DVD/LD, TV, SAT, VCR 1/DVR, VCR 2, CD, CD-R/TAPE 1 (except for a  RF input which doesn't include CD, CD-R/TAPE 1).
- If you assign a digital input to a certain function (for example DVD/LD) then any digital inputs previously assigned to that function will automatically be set to OFF. This is because one function cannot be assigned to two different places (except for RF IN).

Assigning the Component Video Inputs

This receiver has three component video inputs. By default they act as video inputs for the DVD/LD, TV and SAT functions, but you can reassign them if you want to use them as video inputs for other receiver functions. For example, if you have a DVD recorder connected to the VCR1/DVR jacks and want to use its component video output, and you're not using the COMPONENT VIDEO IN 3 jacks on this receiver, you can reassign the input from SAT to VCR1.

See pages 16–19 for more on connecting equipment using component video cords.

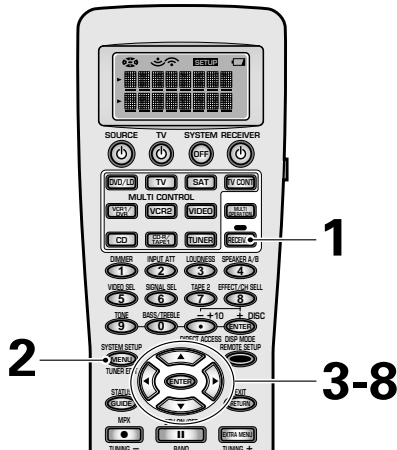

1 Turn on the receiver and your TV, press RECEIVER on the remote control.

2 Press the SYSTEM SETUP button.

3 Looking at the on-screen display on your TV, use the ▲▼ buttons to select INPUT ASSIGN. Press the ENTER button.

4 Use the ▲▼ buttons to select C'NENT VIDEO IN then press ENTER.

5 Use the ▲▼ buttons to select the component video input you want to reassign.

In the example above, we would select C'NENT-IN 3.

6 Use the ◀▶ buttons to assign a receiver function.

Choose between DVD/LD, TV, SAT, VCR1 and VCR2. In the example above, we would select VCR1

7 When you're finished use the ▲▼ buttons to select RETURN and press ENTER.

You will leave the "Assigning the Component Video Inputs" mode.

8 Use the ▲▼ buttons to select RETURN and press ENTER, again. Then, use the ▲▼ buttons to select EXIT and press ENTER.

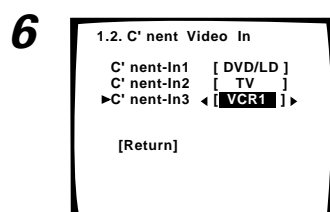
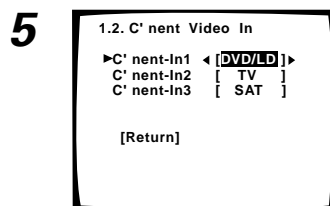
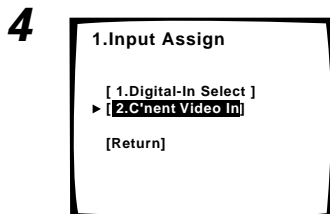
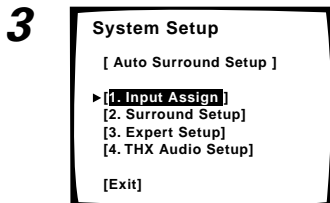

If you connect any source component to the receiver using a component video input, you should also have your TV connected to this receiver's component video output.

Expert Setup

These settings are more advanced. Some could add depth or listenability to your sound (like the Dynamic Range Control) and others are for your convenience (like the Function Rename). You can decide if you want to make these settings or not. They are not crucial to good surround sound. You only need to make these settings once (unless you change the placement of your current speaker system, add new speakers or components to your system, etc.). These setup operations use your TV to display the settings and choices so be sure your TV and receiver are properly hooked up.

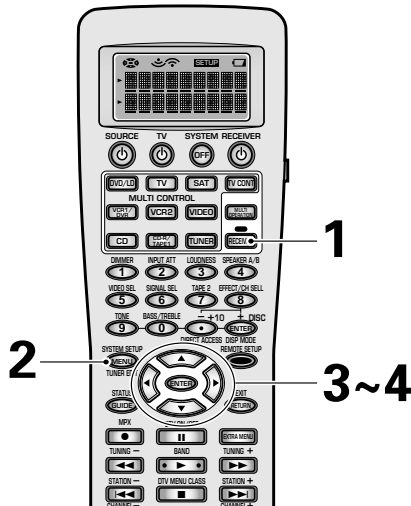

1 Turn on the receiver and your TV, press the RECEIVER on the remote control.

Make sure your TV is set to the receiver.

2 Press the SYSTEM SETUP button.

The menu possibilities appear on your TV.

3 Select EXPERT SETUP with the ▲▼ buttons. Press the ENTER button.

4 Follow the order below to make advance settings. Use the ▲▼ buttons to navigate through the menus. When you have the setting you want in particular menu, press ENTER.

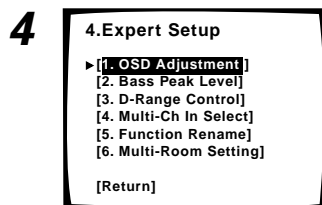
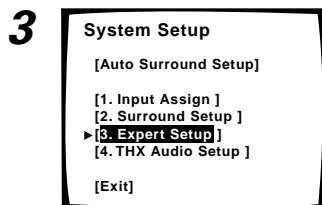

In each mode, the current settings are displayed automatically.

OSD (ON-SCREEN DISPLAY) ADJUSTMENT (p.91)

This feature allows you to adjust positioning of the display to fit your TV better.

BASS PEAK LEVEL (p.92)

Dolby Digital and DTS audio sources include ultra-low bass tones. Set the bass peak level as needed to prevent the ultra-low bass tones from distorting the sound from the speakers.

DYNAMIC RANGE CONTROL (p.93)

This feature makes possible excellent surround sound effects when listening to Dolby Digital sources at low volumes.

MULTI CH IN SELECT (p.94)

This feature is for choosing an output method for people who have connected their DVD player up with multichannel analog inputs.

FUNCTION RENAME (p.95)

This feature allows you to change the names that appear in the receiver display to reflect what you have connected.

MULTI ROOM (p.74-78)

You can set up this unit to power systems in different rooms.

OSD (On-screen Display) ADJUSTMENT

Use this feature to adjust your TV display if it seems difficult to see all the instructions on the screen. This adjustment basically lets you move the screen displays up or down and left or right to get a better match between the displays for this receiver and your TV.

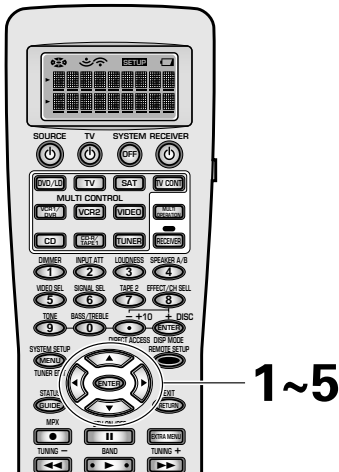

Follow steps 1-3 on page 90, if necessary, to get to the starting point mentioned here.

1 OSD ADJUSTMENT should be selected, if it isn't use the ▲▼ buttons to select it. Press ENTER.

2 Use the ◀▶▲▼ buttons to move the display field around until you get one that you feel best suits your TV.

3 Press ENTER.

Your new screen display will be set. Next, move on to BASS PEAK LEVEL, if necessary.

If you want to change a setting before proceeding Start over from step one.

4 If you want to continue EXPERT SETUP use the ▲▼ buttons to select the next setup and press ENTER.

Go on to the next page.

5 If you want to finish EXPERT SETUP use the ▲▼ buttons to select RETURN and press ENTER. Then use the ▲▼ buttons to select EXIT and press ENTER.

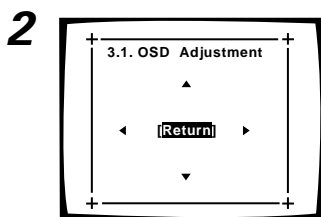
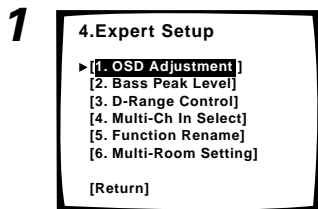

Advanced Setup

BASS PEAK LEVEL

The LFE (Low Frequency Effect) channel in Dolby Digital, DTS program sources can produce heavily concentrated ultra-low bass tones that may exceed the capabilities of your speaker system. The following steps show you how to set the peak level for the LFE channel. If continuing from the preceding page the BASS PEAK LEVEL MANAGER should be selected.

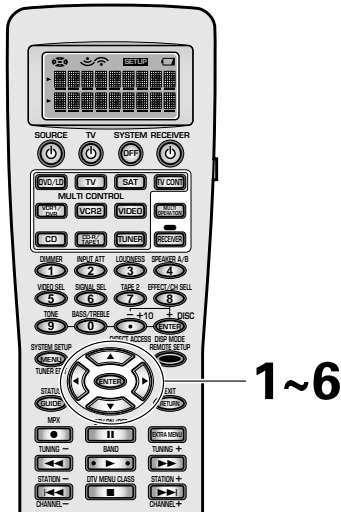

Follow steps 1-3 on page 90, if necessary, to get to the starting point mentioned here.

1 BASS PEAK LEVEL should be selected if, it isn't use the ▲▼ buttons to select it. Press ENTER.

2 Use the ▲▼ buttons to select SETTING START or SETTING CANCEL.

SETTING START: The MASTER VOLUME is set to MIN (---dB), a test tone plays back and you make the setting (in step 3).

SETTING CANCEL: This setting won't limit the peak level of the LFE channel.

For **SETTING START**, select it and press **ENTER**. Then go on to step 3.

For **SETTING CANCEL**, select it and press **ENTER**.

The bass peak level setting is finished. Go on to the next setup.

1 4. Expert Setup
[1. OSD Adjustment]
▶ [2. Bass Peak Level]
[3. D-Range Control]
[4. Multi-Ch In Select]
[5. Function Rename]
[6. Multi-Room Setting]

[Return]

2 4.2. Bass Peak Level Manager
▶ [Setting Start]
[Setting Cancel]

[Return]

Please Wait

3 4.2. Bass Peak Level Manager
▶ [Setting OK]
Bass Peak Level ◀ [80] ▶

[Setting Cancel]

3 Use the ◀▶ buttons to adjust the test tones and specify the bass peak level.

① Raise the level gradually.

② Set the bass peak level at the point just before the tone starts to distort.

Be careful! Test tones play back at loud volumes . Make sure there are no infants or small children in the room at distortion level.

If the YES or PLUS setting on the subwoofer is selected the test tone will only play back from the subwoofer. If not, the test tone will play back from all speakers set to LARGE except for the subwoofer.

4 Press ENTER.

The display on the receiver will show RESUME and the MASTER VOLUME will return to its original position.

5 If you want to continue EXPERT SETUP use the ▲▼ buttons to select the next setup and press ENTER.

Go on to the next page.

6 If you want to finish EXPERT SETUP use the ▲▼ buttons to select RETURN and press ENTER. Then use the ▲▼ buttons to select EXIT and press ENTER.



- If you set the THX Ultra2 feature to YES on p.96 the BASS PEAK LEVEL feature will be cancelled.

DYNAMIC RANGE CONTROL

This feature makes it possible to enjoy full surround sound effects on Dolby Digital sources even at low volumes. It does this by compressing the dynamic range. Dynamic range is the difference between the loudest and the softest sounds in any given signal. Compressing the range plays sounds so the quieter ones are audible and the louder ones don't get distorted or become overpowering. This feature only applies to Dolby Digital sources but the MIDNIGHT LISTENING mode (explained on p.51) accomplishes the same end for a variety of sources. If continuing from BASS PEAK LEVEL, DYNAMIC RANGE CONTROL should be selected.

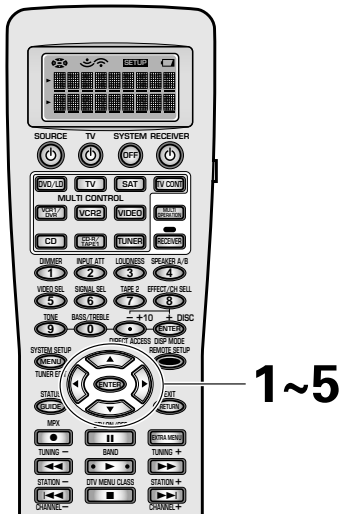

Follow steps 1-3 on page 90, if necessary, to get to the starting point mentioned here.

1 D-RANGE CONTROL should be selected, if it isn't use the ▲▼ buttons to select it. Press ENTER.

2 Use the ◀▶ buttons to choose either OFF, MID or MAX.

OFF: No Dynamic Range Control.
MID: A moderate amount of Dynamic Range Control.
MAX: The most Dynamic Range Control available is applied.

3 Use the ▲▼ buttons to select RETURN. Press ENTER.

Dynamic Range Control is set. Go on to the next setting.

If you want to change a setting before proceeding Start over from step one.

You may need to experiment with different Dolby Digital sources before you can use the DYNAMIC RANGE CONTROL setting to suit your low volume listening needs.

4 If you want to continue EXPERT SETUP use the ▲▼ buttons to select the next setup and press ENTER.

5 If you want to finish EXPERT SETUP use the ▲▼ buttons to select RETURN and press ENTER. Then use the ▲▼ buttons to select EXIT and press ENTER.

1

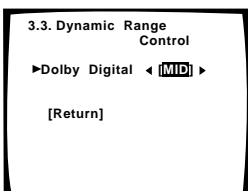
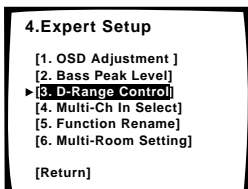

If you are listening at loud volumes we recommend turning the DYNAMIC RANGE CONTROL OFF.

Advanced Setup

MULTI CH IN SELECT

If you have two surround back speakers, and connected a source, such as a DVD-Audio player, to the analog multi-channel inputs, you can use this setting to control how the surround and surround back channels are routed. This will allow you to make the most of your speaker system, enabling you to play 5.1 channel sources through all of your speakers.

There are three OUTPUT MODE settings:

THROUGH: The surround channels are played through the surround speakers; the surround back channels are played through the surround back speaker(s).

S →SB: The surround channels are played through the surround back speakers only.

S→S & SB: The surround channels are played through the surround and surround back speakers. We recommend this setting for 5.1 channel soundtracks.

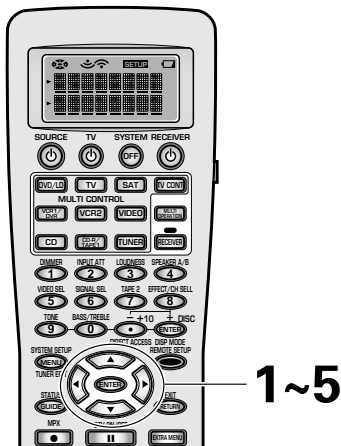

Follow steps 1-3 on page 90, if necessary, to get to the starting point mentioned here.

1 MULTI-CH IN SELECT should be selected if it isn't use the ▲▼ buttons to select it. Press ENTER.

2 Use the ◀▶ buttons to choose a type of output mode: THROUGH, S →SB, S→S & SB.

3 Use the ▲▼ buttons to select RETURN. Press ENTER button.

Your MULTI CH IN SELECT output set. Next, move on to FUNCTION RENAME, if necessary.

If you want to change a setting before proceeding Start over from step one.

4 If you want to continue EXPERT SETUP use the ▲▼ buttons to select the next setup and press ENTER.

5 If you want to finish EXPERT SETUP use the ▲▼ buttons to select RETURN and press ENTER. Then use the ▲▼ buttons to select EXIT and press ENTER.

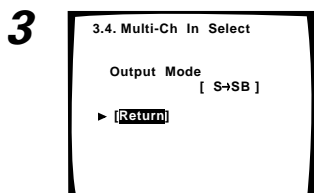
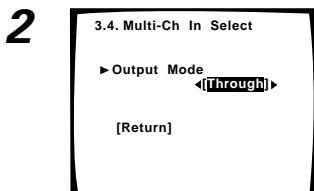
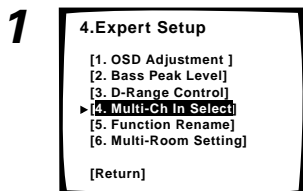

• For details on speaker placement in this mode see page 103.

• If you select S→SB or S→S & SB, the surround back MULTI CH IN jacks are switched off.

FUNCTION RENAME

Use the FUNCTION RENAME capability to rename the display on the receiver and your OSD for different functions (DVD, etc.). For example, you could rename VCR1/DVR as "DVR-7000".

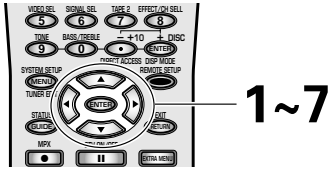

Follow steps 1-3 on page 90, if necessary, to get to the starting point mentioned here.

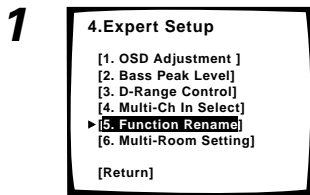

1 FUNCTION RENAME should be selected if it isn't use the ▲▼ buttons to select it. Press ENTER.

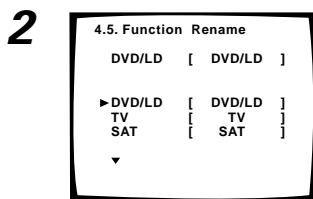

2 Use the ▲▼ buttons to select the name of the function (for example, "VCR1/DVR") you want to change. Press ENTER.

The functions are divided into three different on-screen displays so you may have to move through them to find the function you want to rename.

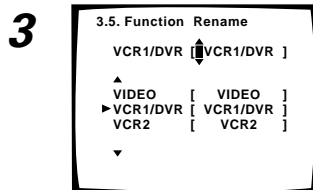

3 Use the ◀▶ buttons to move the cursor around and use the ▲▼ buttons to enter a letter, number or symbol.

The possible selections are shown below.

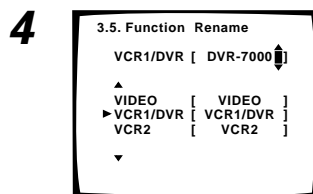

4 Repeat step 3 until you get the name as you want it.

You can input up to ten characters.

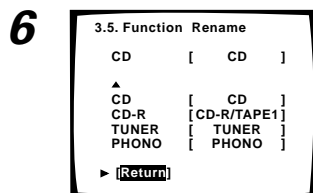

5 Press ENTER. The new function name is set.

6 Repeat steps 2-5 to change other function names. Use the ▲▼ buttons to select RETURN and press ENTER.

7 To finish EXPERT SETUP use the ▲▼ buttons to select RETURN and press ENTER. Then use the ▲▼ buttons to select EXIT and press ENTER.

THX Audio Setup

THX Ultra2 Subwoofer Setup

If you have a high-precision speaker that outputs very low frequencies, the sound may have too much boom because of the resonant frequencies in the room where your subwoofer is setup. If you have this problem use the THX Ultra2 Subwoofer Setup to adjust the low end sounds.

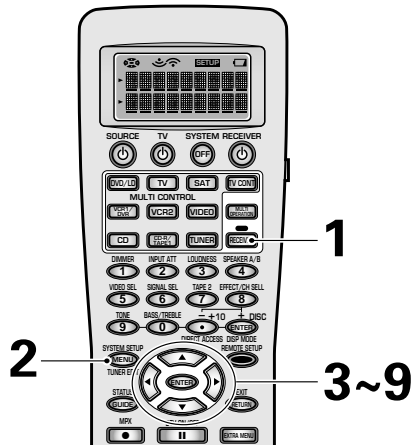

1 Turn on the receiver and your TV, press the RECEIVER on the remote control.

Make sure your TV is set to the receiver.

2 Press the SYSTEM SETUP button.

The menu possibilities appear on your TV.

3 Use the ▲▼ buttons to select THX AUDIO SETUP. Press ENTER.

4 Use the ▲▼ buttons to select ULTRA2 SW SETUP. Press ENTER.

5 If your subwoofer is THX Ultra2 certified, select YES. Use the ◀▶ buttons and then press ▼.

If your subwoofer isn't THX Ultra2 certified, but you still want to switch the boundary gain compensation to ON, select YES. However, the results may not be satisfactory.

6 Use the ◀▶ buttons to select ON or OFF.

7 Use ▼ to select RETURN then press ENTER.

8 If you want to continue THX AUDIO SETUP use the ▲▼ buttons to select the next setup and press ENTER.

Go on to the next page.

9 If you want to finish THX AUDIO SETUP use the ▲▼ buttons to select RETURN and press ENTER. Then use the ▲▼ buttons to select EXIT and press ENTER.

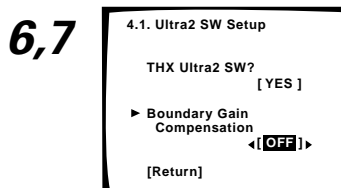
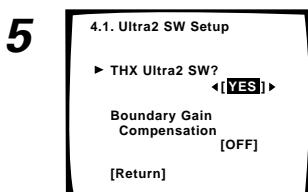
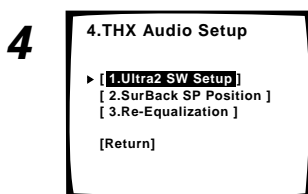
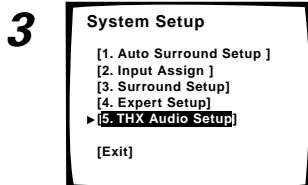

- If you select YES the BASS PEAL LEVEL limiter (see p.92) will be cancelled.
- See the THX section in Techno Tidbits (p.100-101) for more information on the THX Ultra2 Subwoofer feature.

Surround Back Speaker Position

This setting has been specifically designed to set the distance between your surround back speakers. If you don't have surround back speakers, or just have one, you won't be able to select this setting. The Advanced Speaker Array (ASA) system was developed with the principles of THX Ultra2 technology in order to get optimum sound from your surround back speakers. Choose whether your speakers are closer or further apart than 4 feet. To optimize the ASA technology closer together is better than farther apart. For more information about ASA see page 101 and for THX speaker placement information see p.103.

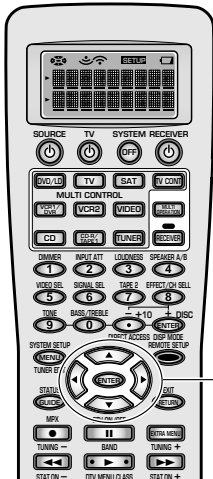

Follow steps 1-3 on page 96, if necessary, to get to the starting point mentioned here.

1 SURBACK SP POSITION should be selected, if it isn't use the ▲▼ buttons to select it, and press ENTER.

2 Use the ◀▶ buttons to select either APART or TOGETHER.

3 Use the ▲▼ buttons to select RETURN and press ENTER.

4 If you want to continue THX AUDIO SETUP use the ▲▼ buttons to select the next setup and press ENTER.

Go on to the next page.

5 If you want to finish THX AUDIO SETUP use the ▲▼ buttons to select RETURN and press ENTER. Then use the ▲▼ buttons to select EXIT and press ENTER.

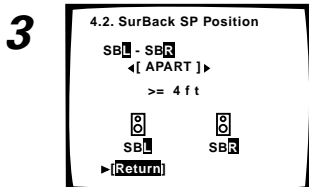
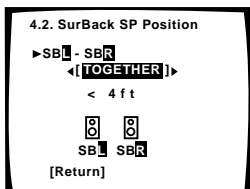
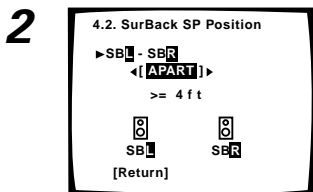
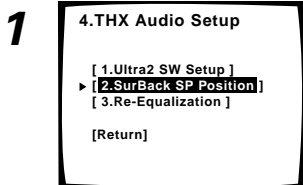

Advanced Setup

Re-Equalization

Re-Equalization is a built-in feature of THX technology (see p.101) and is thus always in use for HOME THX modes. If you want to apply this feature to other listening modes complete the steps below. Whether this setting will benefit you or not depends on the type of room you have and your individual listening tastes.

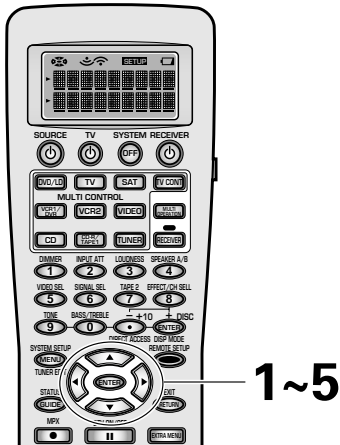

Follow steps 1-3 on page 96, if necessary, to get to the starting point mentioned here.

1 RE-EQUALIZATION should be selected if it isn't use the ▲▼ buttons to select it.

2 Use the ▼▲ buttons to select STANDARD or STEREO.

You should choose the listening mode that you would use for listening to movies or other sources that would generally be played in a large theater.

3 Use the ◀▶ buttons to select ON for the mode(s) you specified above.

Selecting STANDARD ON will also apply Re-Equalization to the ADVANCED CINEMA listening modes.

4 Select RETURN (use ▼▲) to go back to the THX AUDIO SETUP menu, and press ENTER.

5 To finish THX AUDIO SETUP use the ▲▼ buttons to select RETURN and press ENTER. Then use the ▲▼ buttons to select EXIT and press ENTER.

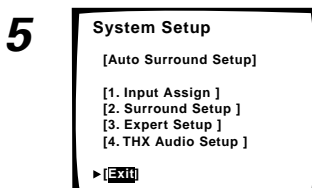
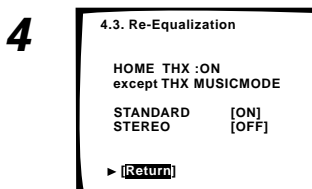
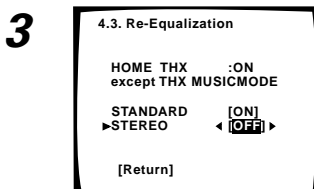
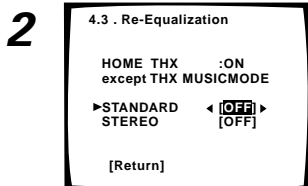
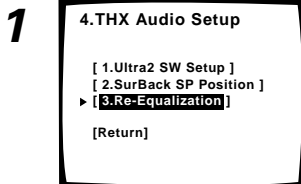

If you set this feature on you won't be able to get 96 kHz processing.

Techno Tidbits & Problem-solving

Dolby



Dolby Digital

Dolby Digital is a discrete digital surround format used for multichannel surround sound. It was developed after the Dolby Surround System and Dolby Pro Logic Surround System. Dolby Digital is a high quality digital sound format that is used by many theatrical film releases.

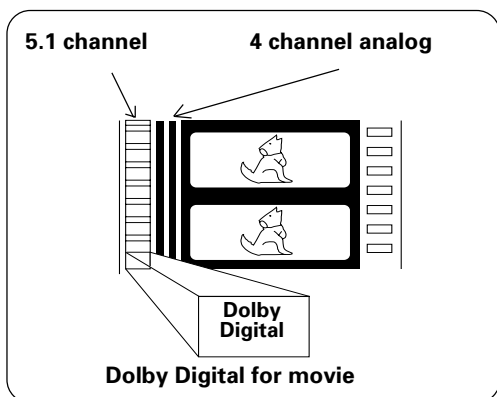

Soundtracks using linear PCM audio generate too much data for multichannel use. Dolby Digital technology was developed in response to the need for efficient multichannel digital sound. It uses masking technology and Adaptive Transform Coding, resulting in no audible loss of sound quality. In the present age of digital sound Dolby Digital is a standard audio format for DVD and has been adopted by HDTV broadcasts throughout the USA.

Other features include:

- 1) Downmixing on playback for compatibility with mono, stereo, Dolby Pro Logic and 5.1 channel audio.
- 2) A wide range of bitrates and channels.
- 3) Decoding dynamic range information and adjusting the dialog level in the soundtrack (called Dialog Normalization, see below for more information).

The advantages of the Dolby Digital system of encoding allow it to maintain its high quality sound while at the same time being very flexible, with the ability to handle many different types of soundtracks.

Dialog Normalization

When a Dolby Digital soundtrack is played back the Dialog Normalization function of the receiver activates automatically. Dialog Normalization is a Dolby Digital function that establishes the average dialog level for the program source being played. If the receiver's level does not match the average dialog level, first you see "DIAL NORM" and "OFFSET +4 dB" (as an example) appear in the receiver's display. In this example, the number +4 dB is the difference between the receiver's gain structure and the Dolby Digital average dialog level. To match the average dialog level, subtract or add the OFFSET level. For example, if the OFFSET level is +4 dB, the amplifier's output is 4 dB over the average recorded level.

Dolby Pro Logic II

Dolby Pro Logic II is an improved version of Dolby Pro Logic technology with extended matrix decoding technology that can create 5.1 channel sound from two channel sources. Dolby Pro Logic II creates basic 5 channel sound by using the innovative "steering logic" circuit. Therefore when listening to typical two-channel sources like CD, the listener can enjoy a richer spatial effect. When using software encoded with Dolby Surround, this decoding system affords the listener an improved surround experience with greater sound detail.

Chart Comparing Dolby Pro Logic and Dolby Pro Logic II

	Pro Logic	Pro Logic II
Effective sound source	Dolby Surround encoded sources	All two channel stereo sources
Surround Sound	Mono	Stereo
Frequency Range	Surround within 7kHz	All Channels/Full Range

This unit has a three Dolby Pro Logic II functions. The first is "Movie Mode" (suitable for film soundtracks); "Music Mode" (suitable for music); "Pro Logic Mode" (this mode is less sensitive to the quality of the source material, so may be useful when Movie Mode or Music Mode do not give good results). One can select one of them depending on your soundtrack of choice.



- For receivers and components other than the VSX-47TX Dolby Pro Logic II may not have the above mentioned functions.

Download from www.Somanuals.com. All Manuals Search And Download.

Dolby Digital Surround EX

This new recording technology is able to play 6.1 channel sound and was developed in a collaboration between Dolby Laboratories and Lucasfilm, Ltd. for the film "Stars Wars: The First Episode", the first movie ever to be made with Dolby Digital Surround EX technology. In a movie theater this format affords the listener vivid surround sound experience replete with the effect of sounds flying overhead, even for those seated towards the sides of the theater.

Dolby Digital Surround EX contains surround back channels which are dubbed into the soundtrack in studio. The channels are encoded into the left and right channels of the soundtrack so this format can be compatible with Dolby Digital 5.1 channel decoding. For a list of movies that contain Dolby Digital Surround EX soundtracks see Dolby website at: <http://www.dolby.com>

THX Surround EX technology was developed for movie theater use originally but has been extended for home theater use and consumers can no benefit from this excellent, realistic sound format. (For more details see "THX Surround EX" on the next page.) This unit is equipped with a THX Surround EX decoder.

DTS



DTS

DTS has been adopted as a sound recording format in the movie theaters since the release of "JURASSIC PARK" in 1993, and has a good reputation for high quality sound and dynamic surround effects. In this system, 6 channels of digital sound are recorded on CD-ROM. DTS adopts a simultaneous playback format. With a low rate of compression of sound signals and a high rate of transmittance, a higher sound quality format is produced. For this reason, the format is being introduced in more and more movie theaters, and is being adopted for home use as DTS Digital Surround. When used with movies it's called DTS-LD DVD and for music software (5.1 channel CD) as DTS-CD .

DTS-ES

DTS launched a new surround format in November 2000. This has come to be known as DTS Extended Surround or simply DTS-ES. The technology has been advanced to include two new home formats DTS-ES Discrete 6.1 format, and DTS-ES Matrix 6.1 ch format, both are able to playback discrete, 6.1-channel content from DVDs and CDs. Both of these formats are compatible with a conventional DTS 5.1 ch decoder. In this system each channel is encoded and decoded individually, adding to the separation of the channels. Since DTS adds a third surround channel, the surround back channel, the realism and all-encompassing nature of the sound reaches levels not seen before in home theater. This unit is equipped with a DTS-ES decoder.

DTS Neo:6

This is a matrix decoding technology that transforms two-channel sources into 6.0 channel surround sound. There are two modes, "Cinema Mode" and "Music Mode".

DTS 96/24

This high-quality format will be used for software which will be available from November, 2001. For compatibility with equipment that was produced before this format was made, DVD players can play this software using a conventional DTS 5.1ch decoder. This unit is equipped with a DTS 96 kHz/24 bit decoder to take advantage of the higher sound quality available.

THX®



THX Cinema™ processing :THX is an exclusive set of standards and technologies established by the world-renowned film production company, Lucasfilm Ltd. THX grew from George Lucas' personal desire to make your experience of the film soundtrack, in both movie theaters and in your home theater, as faithful as possible to what the director intended. Movie soundtracks are mixed in special movie theaters called dubbing stages and are designed to be played back in movie theaters with similar equipment and conditions. This same soundtrack is then transferred directly onto Laserdisc, VHS tape, DVD, etc., and is not changed for playback in a small home theatre environment.

THX engineers developed patented technologies to accurately translate the sound from the movie theater environment into the home, correcting the tonal and spatial errors that occur. On this product, when the THX indicator is on, THX features are automatically added in Cinema modes (e.g. THX Cinema, THX Surround EX).

Re-Equalization™ : The tonal balance of a film soundtrack will be excessively bright and harsh when played back over audio equipment in the home because film soundtracks were designed to be played back in large movie theaters using very different professional equipment. Re-Equalization restores the correct tonal balance for watching a movie soundtrack in a small home environment.

Timbre Matching™ : The human ear changes our perception of a sound depending on the direction from which the sound is coming. In a movie theater, there is an array of surround speakers so that the surround information is all around you. In a home theater, you use only two speakers located to the side of your head. The Timbre Matching feature filters the information going to the surround speakers so that they more closely match the tonal characteristics of the sound coming from the front speakers. This ensures seamless panning between the front and surround speakers.

Adaptive Decorrelation™ : In a movie theater, a large number of surround speakers help create an enveloping surround sound experience, but in a home theater there are usually only two speakers. This can make the surround speakers sound like headphones that lack spaciousness and envelopment. The surround sounds will also collapse into the closest speaker as you move away from the middle seating position. Adaptive Decorrelation slightly changes one surround channel's time and phase relationship with respect to the other surround channel. This expands the listening position and creates—with only two speakers—the same spacious surround experience as in a movie theater.

THX Ultra™ : Before any home theater component can be THX Ultra certified, it must incorporate all the features above and also pass a rigorous series of quality and performance tests. Only then can a product feature the THX Ultra logo, which is your guarantee that the Home Theater products you purchase will give you superb performance for many years to come. THX Ultra requirements cover every aspect of the product including pre-amplifier performance and operation, and hundreds of other parameters in both the digital and analog domain.

THX Surround EX™ : THX Surround EX-Dolby Digital Surround EX is a joint development of Dolby Laboratories and the THX division of Lucasfilm Ltd.

In a movie theater, film soundtracks that have been encoded with Dolby Digital Surround EX technology are able to reproduce an extra channel which has been added during the mixing of the program. This channel, called Surround Back, places sounds behind the listener in addition to the currently available front left, front center, front right, surround right, surround left and subwoofer channels. This additional channel provides the opportunity for more detailed imaging behind the listener and brings more depth, spacious ambience and sound localization than ever before.

Movies that were created using the Dolby Digital Surround EX technology, when released into the home consumer market may exhibit wording to that effect on the packaging. A list of movies created using this technology can be found on the Dolby web site at www.dolby.com. A list of available DVD software titles encoded with this technology can be found at www.thx.com. Only receiver and controller products bearing the THX Surround EX logo, when in the THX Surround EX mode, faithfully reproduce this new technology in the home.

This product may also engage the THX Surround EX mode during the playback of 5.1 channel material that is not Dolby Digital Surround EX encoded. In such case the information delivered to the Surround Back channel will be program dependent and may or may not be very pleasing depending on the particular soundtrack and the tastes of the individual listener.

Advanced Speaker Array™ (ASA) : When you set up your home theater system using all eight speaker outputs (Left, Center, Right, Surround Right, Surround Back Right, Surround Back Left, Surround Left and Subwoofer) and the two Surround Back speakers are placed close together as shown in the diagram on page 103, you can take advantage of THX's Advanced Speaker Array (ASA) technology.

ASA optimizes the surround sound experience using two new modes; THX Ultra2 Cinema and THX MusicMode.

THX Ultra2™ Cinema mode : When presented with a multichannel digital signal (Dolby Digital, DTS, etc.) the VSX-47TX automatically selects THX Ultra2 Cinema mode. This mode plays 5.1 movies using all 8 speakers giving you the best possible movie watching experience. In this mode ASA processing blends the side surround speakers and back surround speakers providing the optimal mix of ambient and directional surround sounds.

THX's ASA circuitry will automatically detect DTS-ES (Matrix and 6.1 Discrete) and Dolby Digital Surround EX encoded soundtracks for correct playback using all 8 speakers.

Please note that some Dolby Digital Surround EX soundtracks are missing the digital flag that allows ASA to switch automatically. Therefore, if you know that the movie that you are watching is encoded in Surround EX, you may manually select the THX Surround EX playback mode.

THX MusicMode™ : On some music DVDs the surround sounds are mixed quite differently than surround sounds mixed for movie soundtracks. ASA technology optimizes the play back of 5.1 encoded music sources such as DTS and Dolby Digital. Using all 8 speakers the THX MusicMode provides a wide stable rear soundstage, placing surround sounds best suited for music playback.

Boundary Gain Compensation™ : Room boundaries (walls) or other characteristics (such as wall construction) may increase the perceived acoustics levels at low frequencies. Depending on the listener's and the subwoofer's position, the listener may experience an excessive bass effect. The purpose of this feature is to compensate for excessive bass resulting from a boundary gain effect. This feature is designed to operate when used with a subwoofer certified to THX Ultra2 specifications. If not used with a THX certified Ultra2 subwoofer then this feature will not operate correctly and its operation will be unpredictable. In the THX Audio setup menu choose "Ultra2 SW Setup". Then choose "THX Ultra2 Subwoofer-Yes". This now allows you to operate the Boundary Gain Compensation feature. Once you have set up the speaker system, play some program material with familiar bass content. If you are close to a boundary you may decide to switch the Boundary Gain Compensation feature ON if you feel that the bass sound excessive. Please also note that when a THX certified Ultra2 subwoofer is used, the Bass Limiting protection feature is disabled in this product as protection is provided by the subwoofer.

Speaker Placement Information

Placement of your speakers is a crucial aspect of attaining accurate and realistic surround sound. Certain pointers concerning speakers stands, direction, angle and distance of speakers will be useful in this regard.

Firstly, it is best not to put your speakers directly on the floor. If you do this some of the sound vibration (especially bass) will go directly into the flooring and be lost. Instead we recommend using extremely hard objects (like cinder blocks) or designated speaker stands to support your speakers. Avoid placing the speakers on soft (like cushions or sofas) as these will also lead to sound loss and unstable surfaces (like flimsy shelving) as they may cause speaker accidents. In order to achieve a surround sound effect, make sure the speakers are a reasonable distance from your main listening position. Follow the diagrams and instructions below for optimum placement of each set of speakers.

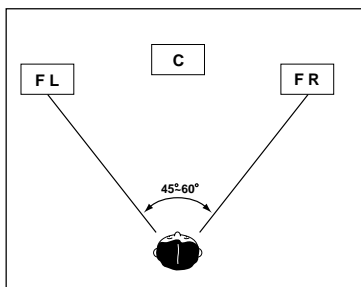

If you're using a CENTER speaker set the FRONT speakers to a wider angle. If not, set them to a narrower angle.

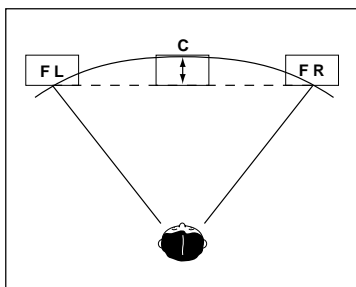

Make sure the CENTER speaker does not cross the forward plane of the FRONT speakers.

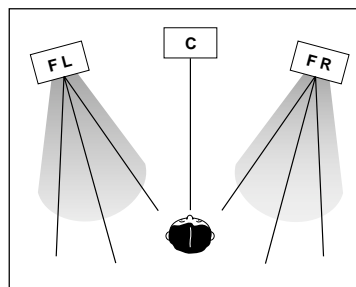

It is best to angle the speakers towards the listening position. The angle depends on the size of the room. Use less angle for bigger rooms.

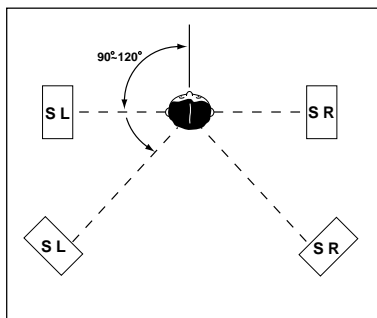

Surround speakers should be positioned a foot and a half to three feet (60 cm -1 meter) higher than your ears and titled slight downward. Make sure the speakers don't face each other. For DVD Audio the speakers should be more directly behind the listener than for home theater playback.

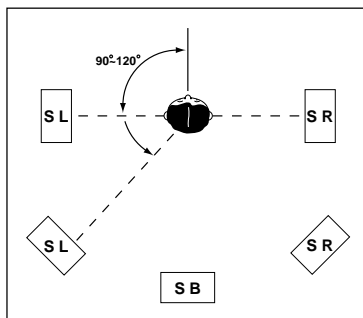

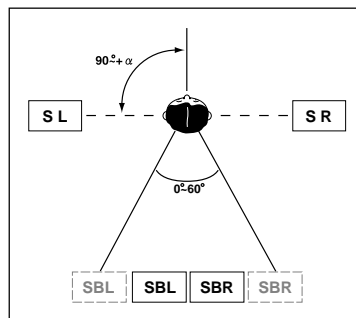

Surround back speakers should also be positioned a foot and a half to three feet (60 cm -1 meter) higher than your ears and titled slight downward. Make sure the speakers don't face each other. For DVD Audio the speakers should be more directly behind the listener than for home theater playback.

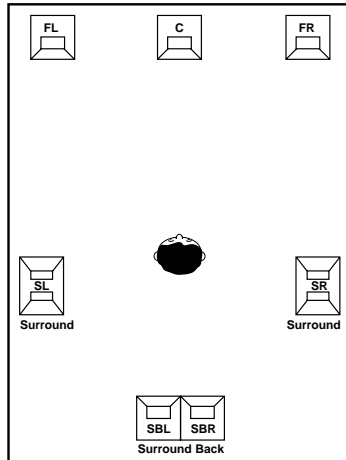

Speaker Placement for a Complete THX Speaker System

If you have a complete THX Speaker System set (LucasFilm authorized), follow the diagram below to place your speakers. Placing your surround back speakers together, and the same distance from the listening position, will allow you to take advantage of the ASA technology (see p.97 & 101). Notice the surround speakers should output at an angle parallel to the listener. Also, notice the angle of the front speakers.



 Di-polar Radiating Speaker

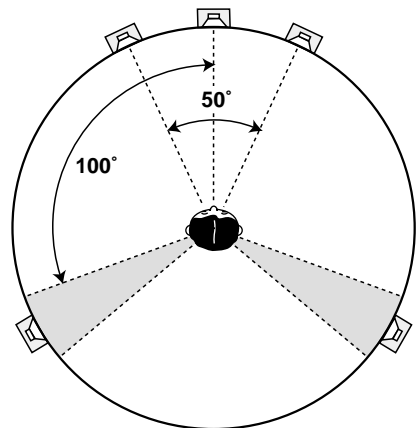

Speaker Placement for DVD-Audio (etc.) Sources

The best speaker placement for DVD-Audio (and other multichannel music sources) may be different than for regular DVD discs. For these formats follow the diagram at right as opposed to the home theater setups of the preceding pages. If you want to use both home theater and DVD-Audio discs follow the diagrams below and set up your MULTI CH IN SELECT output mode accordingly.

In order to choose the best MULTI CH IN SELECT output mode (see p.94) use the diagrams here. Find the diagram that most closely resembles your surround and surround back speaker setup and then chose that output mode.

[S→S&SB]

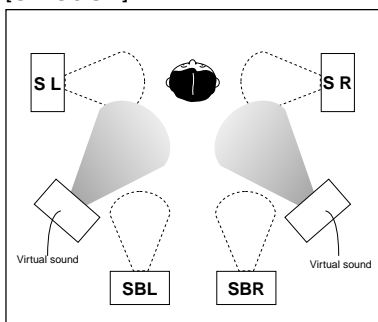

[S→SB]

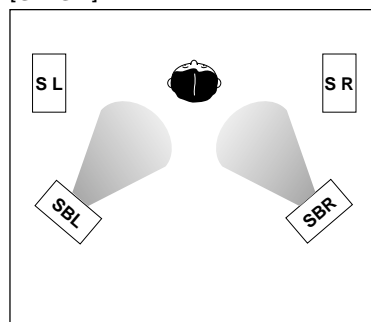

[Through]

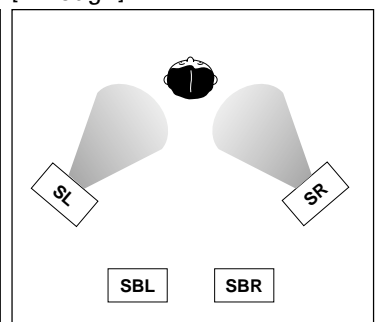

In this diagram the white sound waves represent the actual transmitted sound and the shaded sound waves represent the how the sound will seem to the listener (the virtual sound).

Audio Block Diagram

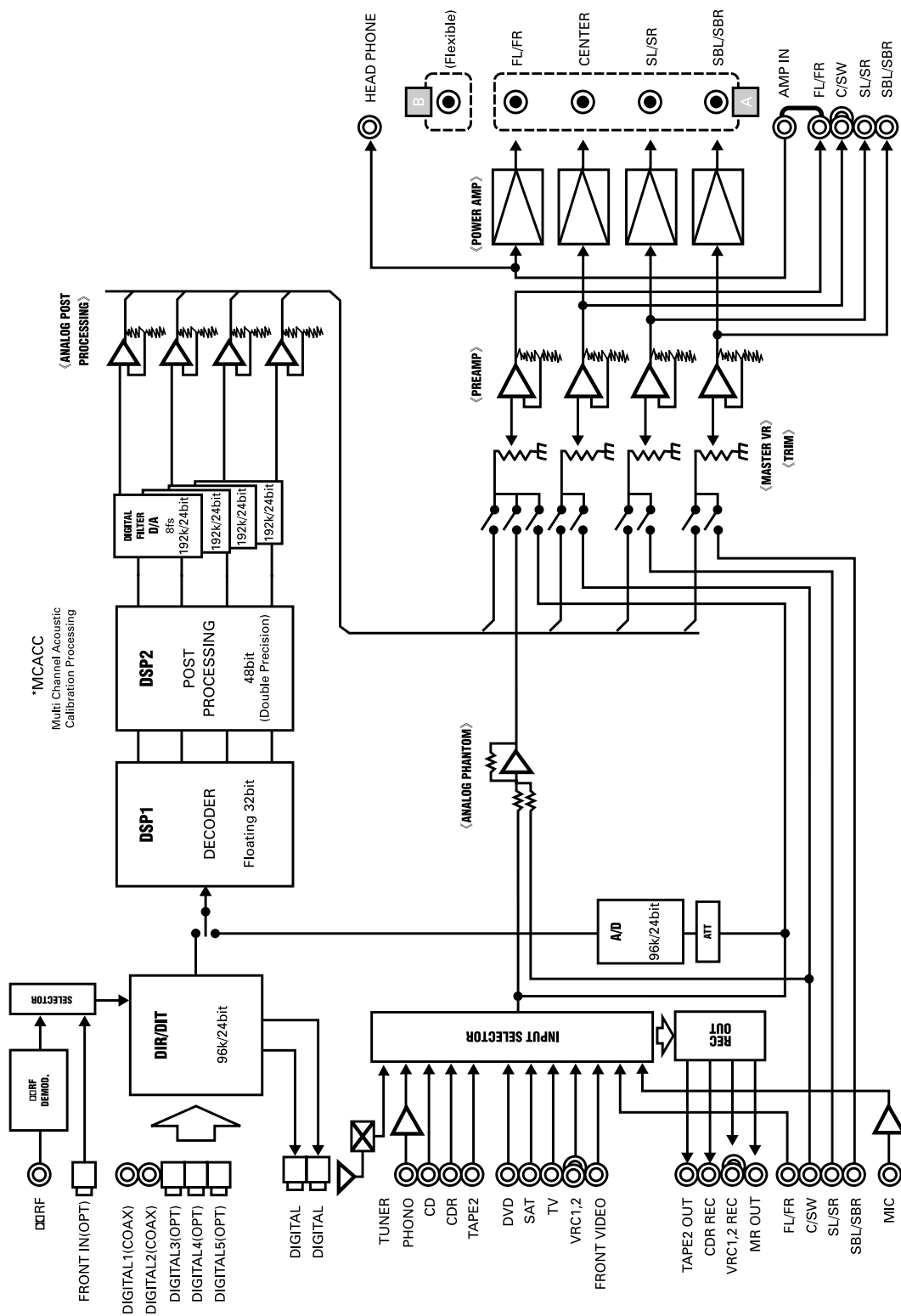

Troubleshooting

Incorrect operations are often mistaken for trouble and malfunctions. If you think that there is something wrong with this component, check the points below. Sometimes the trouble may lie in another component. Investigate the other components and electrical appliances being used. If the trouble cannot be rectified even after exercising the checks listed below, ask your nearest PIONEER authorized service center or your dealer to carry out repair work.

Symptom	Cause	Remedy
Power		
The power does not turn on.	<ul style="list-style-type: none"> The power plug is disconnected. The protection circuit may have been activated. 	<ul style="list-style-type: none"> Connect the power plug to the wall outlet. Disconnect the power plug from the outlet, and insert again.
The unit does not respond when the buttons are pressed.	<ul style="list-style-type: none"> Static electricity caused by dry air. 	<ul style="list-style-type: none"> Switch the unit off, then on again. Disconnect the power plug from the outlet, and insert again.
During operation, the unit suddenly switches off.	<ul style="list-style-type: none"> The speaker wires are frayed or sticking out of the jack, and are touching the back of the receiver or another set of wires. 	<ul style="list-style-type: none"> Reinsert the speaker wires, making sure there are no stray strands of wire and that they are inserted fully (see p.25)
AMP ERR blinks in the display and the unit turns off.	<ul style="list-style-type: none"> The receiver probably has a serious problem. 	<ul style="list-style-type: none"> You won't be able to operate the receiver for a minute. After that turn the receiver back on. If you have the same problem again call a Pioneer-accredited repair center.
OVERHEAT blinks in the display and no sound is output.	<ul style="list-style-type: none"> The receiver has gotten too hot. 	<ul style="list-style-type: none"> Turn the receiver off and allow it to cool down with good ventilation. It is very likely that you have a heat dispersal and ventilation problem so please follow the instructions in "Installing the Receiver" (p.8) carefully.
Setup		
The setup screen doesn't appear.	<ul style="list-style-type: none"> The output jacks haven't been connected properly. The MONITOR OUT jack haven't been connected. 	<ul style="list-style-type: none"> Check all connections (see p.16-23). Connect the MONITOR OUT jacks to the TV monitor (see p.16).
Every time Auto Surround Sound Setup is attempted, there is some kind of error, or the settings seem incorrect.	<ul style="list-style-type: none"> The room environment is not optimal for auto setup (too much ambient noise, obstacles blocking the speakers from the microphone, etc.) 	<ul style="list-style-type: none"> Make sure the room environment is in line with the guidelines displayed on the OSD during auto setup (see p.13-14, memo p.15, & 36-37).
The LARGE and SMALL settings for speakers after the Auto Surround Sound Setup are incorrect.	<ul style="list-style-type: none"> There are other frequencies in the room that are affecting the auto setup. 	<ul style="list-style-type: none"> Check for household appliances (air conditioner, fan, etc.) that may be affecting the environment and switch them off if necessary.
After the proper settings have been made, there still seems to be something wrong with the sound.	<ul style="list-style-type: none"> The speakers have been incorrectly connected (+/- connections are reversed). 	<ul style="list-style-type: none"> Check all connections (see p.25).
No audio		
No sound is output when a function is selected.	<ul style="list-style-type: none"> Improper connections. Sound is muted. The volume is turned down. The TAPE 2 MONITOR is on. Speakers are turned off. DIGITAL/ANALOG setting is incorrect. MULTI CH IN mode is on. 	<ul style="list-style-type: none"> Make sure the component is connected correctly (see p.16-26). Press MUTING on the remote control. Adjust MASTER VOLUME. Turn TAPE 2 MONITOR off (see p.54). Press SPEAKERS (A/B) to select the speakers you connected (see p.71). Select the proper signal with the SIGNAL SELECT button (see p.45). Turn MULTI CH IN mode off (see p.53).
No sound output from the front speakers.	<ul style="list-style-type: none"> The U-shaped connectors that connect the POWER AMP IN terminals to the front channel pre outs are not connected. The front speakers are connected to the B speaker system jack. 	<ul style="list-style-type: none"> Connect the POWER AMP IN terminals to the front channel pre outs using the supplied U-shaped connectors (see p.30). Connect the front speakers to the A speaker system jacks (see p.25).

Techno Tidbits & Problem-solving

Symptom	Cause	Remedy
No sound from surround or center speakers.	<ul style="list-style-type: none"> • Speaker system B or AB is selected • Speaker settings are incorrect. • The surround and/or center speakers are disconnected. • The listening mode is STEREO. 	<ul style="list-style-type: none"> • Select the A speaker system (see p.71). • See "SPEAKER SYSTEMS" on p.36-37 to check the speaker settings. • Connect the speakers (see p.25). • Choose a surround listening mode (see p.43).
No sound output from the subwoofer.	<ul style="list-style-type: none"> • The subwoofer setting is NO. • The subwoofer output setting is too small. • The bass peak level setting is too low. • There is very little low frequency information in your source. • The crossover frequency is set too low. • There is a problem with the subwoofer. • The subwoofer isn't connected properly. 	<ul style="list-style-type: none"> • Change the setting to YES or PLUS (see p.35-37). • Adjust the output setting to the level you want see p.92). • Adjust the peak level setting to the level you want. • Change your subwoofer setting to one of the following (see p.35-37): Front: SMALL Subwoofer: YES Front: LARGE Subwoofer: PLUS • Raise the frequency level to match your speakers' playback characteristics. • Check the three following points: <ul style="list-style-type: none"> • Check the power. • Check the subwoofer volume control . • Check the subwoofer hasn't automatically switched to standby mode (check the subwoofer manual) • Check all connections.
No sound output from the surround back speakers.	<ul style="list-style-type: none"> • The LISTENING CH SELECT is set to 5.1 channel playback. • The source is not a 6.1 channel playback source. • The speaker system setting is on FRONT BI-AMP 5.1 or the surround back speaker setting is NO. • The surround back speakers aren't connected properly. • The surround back channel is set to 1 speaker setting only, and the speaker is connected to the right channel output. 	<ul style="list-style-type: none"> • Choose 7.1 channel playback (see p.44). • Choose 7.1 channel playback or choose one of the ADVANCED listening modes (see p.43 & 44). • Choose NORMAL SURROUND, adjust the surround back channel setting according to the number of speakers you're using, and then set LISTENING CH SELECT to 7.1 (see p.35-37, 44). • Check all connections (see p.16-23). • Connect the speaker to the surround back left channel output (see p.25).
No sound output from one speaker.	<ul style="list-style-type: none"> • The speaker system setting is NO. • The speaker isn't connected properly. • The source has no sound output for that channel. • The speaker output level is set too small. 	<ul style="list-style-type: none"> • Change the speaker setting to YES (see p.35-37). • Check all connections. • If you choose one of the ADVANCED listening modes, an extra channel may be created for the speaker (see p.43). • Increase the speaker output level.
Sound is produced from some components, but not from digital components.	<ul style="list-style-type: none"> • SIGNAL SELECT is set incorrectly. • The digital inputs are assigned incorrectly, or not at all. • The digital components aren't connected properly. • The player is not compatible with the source you're using, or the player settings are incorrect. • The TAPE 2 MONITOR is on, or MULTI CH IN mode has been selected. • The digital output level has been turned down on a CD player or other component equipped with digital output level adjustment capability. 	<ul style="list-style-type: none"> • Set SIGNAL SELECT to "AUTO" or according to the type of connections made (see p.45). • Set the digital input settings correctly (see p.12, memo on 17, 23, and especially 88). • Check all connections. • Choose a compatible source, or check the player's manual for the correct settings. • Switch the TAPE 2 MONITOR off (see p.54), or choose one of the listening modes (see p.43). The MULTI CH IN switches off automatically. • Set the digital volume level of the player to full, or to the neutral position.

Techno Tidbits & Problem-solving

Symptom	Cause	Remedy
When playing an LD the SIGNAL SELECT is on RF but there is still no sound.	<ul style="list-style-type: none"> The LD is not a Dolby Digital compatible disc. 	<ul style="list-style-type: none"> Set the SIGNAL SELECT to AUTO (see p.45). Make sure your LD player is hooked up with analog connections in addition to digital and RF connections (see p.17, 22).
Other audio problems		
Subwoofer output is very low.	<ul style="list-style-type: none"> Settings route signal away from subwoofer. 	<ul style="list-style-type: none"> To get more signal to the subwoofer set it to PLUS or choose SMALL for the front speakers (see p.36-37).
During multi channel playback, there is no sound output from one speaker.	<ul style="list-style-type: none"> The MULTI CH IN SELECT is not set correctly. That speaker is set to NO (except center). 	<ul style="list-style-type: none"> Select the correct number of input channels (see p.94). Set the speaker to YES.
During multi channel playback, the only sound output is from the front speakers.	<ul style="list-style-type: none"> 2 channel input is selected. 	<ul style="list-style-type: none"> Set the MULTI CHANNEL IN playback to 8 channel (see p.53).
A multi channel DVD source appears to be downmixed from 2 channels during playback.	<ul style="list-style-type: none"> The source is coming from something other than the MULTI CH IN jacks (for example, digital PCM output, etc.) 	<ul style="list-style-type: none"> Check the MULTI CH IN connection (see p.21) and select the type of playback with the MULTI CH IN button (see p.53).
The OVER indicator is constantly lit.	<ul style="list-style-type: none"> If you are using an analog source, the signal is too strong. 	<ul style="list-style-type: none"> Press the INPUT ATT button (see p.54). If the player has an analog output setting, lower it as necessary.
Considerable noise in radio broadcasts.	<ul style="list-style-type: none"> Incorrect frequency. The antenna is not connected. RF and/or digital cables are near the antenna terminals and wires. 	<ul style="list-style-type: none"> Tune in the correct frequency. Connect the antenna (see p.24). Route RF and digital cables away from the antenna terminals and wires.
Broadcast stations cannot be selected automatically.	<ul style="list-style-type: none"> The antenna is poorly positioned. Interference caused by other equipment (fluorescent lamp, motor, etc.). Weak radio signals. 	<ul style="list-style-type: none"> Adjust the direction and position for best reception. Turn off the equipment causing the noise or move it away from the receiver. Place the antenna farther away from the equipment causing the noise. Connect an outdoor AM or FM antenna (see p.24).
Noise or hum can be heard even when there is no sound being input.	<ul style="list-style-type: none"> There is electrical interference from another component or appliance. 	<ul style="list-style-type: none"> Check that personal computers or other digital components connected to the same power source are not causing interference.
When a search is performed by a DTS compatible CD player during playback, noise is output.	<ul style="list-style-type: none"> The search function performed by the player interferes with the reading of digital information. 	<ul style="list-style-type: none"> This is not a malfunction, but be sure to turn the volume down to prevent the output of loud noise from your speakers.
When playing a DTS format LD there is noise audible on the soundtrack.	<ul style="list-style-type: none"> The SIGNAL SELECT is on ANALOG. 	<ul style="list-style-type: none"> Set the SIGNAL SELECT to DIGITAL (see p.45).
Can't record audio.	<ul style="list-style-type: none"> You are trying to make an analog recording from a digital signal, or a digital recording of an analog source. The digital source is copy protected. The jacks for recording have not been connected properly. 	<ul style="list-style-type: none"> You can only record analog to analog, or digital to digital. You can't record digital sources that have been copy protected. Check connections (see p.20 & 22).

If the unit does not operate normally due to external effects such as static electricity

Disconnect the power plug from the outlet and insert again to return to normal operating conditions.

Techno Tidbits & Problem-solving

Symptom	Cause	Remedy
Video		
No image is output when a function is selected.	<ul style="list-style-type: none"> Improper connections. The input source is not properly selected. The video input selected on the TV monitor is incorrect. The TV or monitor is hooked up with cord that is different than that used for the video player. The component video setting is incorrect. 	<ul style="list-style-type: none"> Make sure the component is connected correctly (see p.16, 17-19). Press the correct function button. Please read the TV monitor manual and change the settings accordingly. Use the same cable to connect to your TV and all your video equipment (see p.16-23). Select the correct C'NENT VIDEO IN setting (see p.89).
There is no image coming from the selected component video jacks.	<ul style="list-style-type: none"> The type of cord connected to the TV doesn't match your video input settings. 	<ul style="list-style-type: none"> Change the settings to match the cord connected (see p.16-23).
Can't record video.	<ul style="list-style-type: none"> The source is copy protected. You are trying to record a source connected to the component video jacks. The recorder's video input is hooked up using a different type of cord to the source video output. 	<ul style="list-style-type: none"> You can't record sources that have been copy protected. Connect the component with S video or composite video cords (see p.16-23). Hook up the source and the recorder using the same type of video cord.
Input/display		
The display is dark.	<ul style="list-style-type: none"> The display DIMMER button is pushed. 	<ul style="list-style-type: none"> Press DIMMER on the remote control repeatedly to return to the default setting (see p.56).
You can't get DIGITAL to come up when using the SIGNAL SELECT button.	<ul style="list-style-type: none"> Either the digital connections or the DIGITAL IN SELECT is incorrect. Tape 2 MONITOR is on. MULTI CH IN mode is on. 	<ul style="list-style-type: none"> Make sure the digital connections (see p.17-19 & 22-23) and the DIGITAL IN SELECT (see p.88) is done correctly. Press the Tape 2 MONITOR button so it goes into the off setting (see p.54) . Turn MULTI CH IN mode off (see p.53) .
The digital format indicator doesn't light up even when playing a non-PCM digital source.	<ul style="list-style-type: none"> The player is paused or stopped. There is a mistake in the player settings for audio output. 	<ul style="list-style-type: none"> Play the source. Fix the audio settings (check the manual that came with your DVD player).
A compressed digital source is being played, but the digital format indicators don't light up.	<ul style="list-style-type: none"> Although it's a non-PCM digital source there is a possibility the present track is not the proper format (5.1, 6.1, or 7.1 channel). 	<ul style="list-style-type: none"> There is no problem. The indicator won't light when the track is not a compressed digital source.
During playback of a compressed digital source, the PRO LOGIC or NEO:3 indicators show in the display.	<ul style="list-style-type: none"> The digital signal is not being sent with the source. The audio is in two channel format. It has already been Dolby surround encoded. 	<ul style="list-style-type: none"> Choose DIGITAL or AUTO with the signal select button (see p.45). This is not a malfunction. Check the manufacturer information for the source.
During playback of a Surround EX or DTS ES source on the AUTO setting, the EX and ES indicators won't light.	<ul style="list-style-type: none"> The source may be 6.1 playback compatible, but there is no signal from the source to indicate this. 	<ul style="list-style-type: none"> Switch the LISTENING CH SELECT to 7.1 and switch to the THX Surround EX or Standard TX listening mode see p.43 & 44).
During playback of a Surround EX or DTS ES source on the AUTO setting, the EX and ES indicators light, but the signal is not properly processed.	<ul style="list-style-type: none"> The listening mode is set incorrectly for the source. 	<ul style="list-style-type: none"> Switch the LISTENING CH SELECT to AUTO and select HOME THX or STANDARD listening modes (see p.43 & 44). Switch the LISTENING CH SELECT to 7.1 and switch to the THX Surround EX or Standard TX listening mode (see p.43 & 44).

Symptom	Cause	Remedy
During playback of a DVD audio source, the player shows a transfer rate of 96kHz, but the receiver does not.	<ul style="list-style-type: none"> The multi channel connections are analog, so there is no digital transfer. 	<ul style="list-style-type: none"> This is not a malfunction. See the player's manual for more details.
During playback of a DTS 96/24 source, the display doesn't show 96kHz	<ul style="list-style-type: none"> The receiver may be on a different mode than STANDARD. One of the DIGITAL NR, MIDNIGHT, LOUDNESS, and TONE features are switched on. The setting for speakers other than the surround back is set to NO. Re-EQ is set on. 	<ul style="list-style-type: none"> Switch to STANDARD mode (see p.43). Turn it/them off (see p.50-52). The source has been downmixed to 48 kHz. Set Re-EQ off (see p.98).
During playback of a 96kHz source, the display doesn't show 96kHz	<ul style="list-style-type: none"> The receiver may be on a different mode than STEREO. One of the DIGITAL NR, MIDNIGHT, LOUDNESS, and TONE features are switched on. Re-EQ is set on. 	<ul style="list-style-type: none"> Switch to STEREO mode (see p.43). Turn it/them off (see p.50-52). Set Re-EQ off (see p.98).
Remote control		
Cannot be remote controlled.	<ul style="list-style-type: none"> The remote control batteries have worn out. Too far away or bad angle of operation. There is an obstacle between the receiver and the remote control. Strong light such as fluorescent light is shining onto the unit's remote control signal light-receiving window. A cord is connected to the CONTROL IN terminal on this unit. The IR -Receiver type is mismatched with the setting. 	<ul style="list-style-type: none"> Replace the batteries (see p.7). Operate within 7 m, 30° of the remote sensor on the front panel (see p.8). Remove the obstacle or operate from another position (see p.8). Avoid exposing the remote sensor on the front panel to direct light. Connect cord to the correct jack. Disconnect the IR Receiver from the rear panel, and set to the other IR Receiver type using the remote control.
Other components can't be operated with the system remote.	<ul style="list-style-type: none"> The preset code settings are wrong. The battery wore out and the system settings were cleared. 	<ul style="list-style-type: none"> Input the correct preset code. Reset the proper system settings.
The SR cable is connected, but the connected components can't be operated with the remote.	<ul style="list-style-type: none"> The SR cable hasn't been connected properly. The rest of the component connection have not been made. The component you have hooked up is not SR compatible. 	<ul style="list-style-type: none"> Reinsert the SR cable, making sure it is the right jack (see p.78). Make sure an analog connection has been made between the units. This is not a malfunction.
Miscellaneous		
HOME THX 7.1 channel mode is selected, but there are certain options that can't be chosen.	<ul style="list-style-type: none"> The current setting is for only one surround back speaker. 	<ul style="list-style-type: none"> Connect two surround back speakers and make the settings accordingly (see p.25, 36-37).
There seems to be a time lag between the speakers and the output of the subwoofer.	<ul style="list-style-type: none"> The subwoofer channel can be delayed slightly if run through a low-pass filter. 	<ul style="list-style-type: none"> The MCACC system will automatically compensate for a delay in the subwoofer output during the Auto Surround Sound Setup.

Power cord CAUTION!

Handle the power cord by the plug. Do not pull out the plug by tugging the cord and never touch the power cord when your hands are wet as this could cause a short circuit or electric shock. Do not place the unit, a piece of furniture, etc., on the power cord, or pinch the cord. Never make a knot in the cord or tie it with other cords. The power cords should be routed such that they are not likely to be stepped on. A damaged power cord can cause a fire or give you an electrical shock. Check the power cord once in a while. When you find it damaged, ask your nearest PIONEER authorized service center or your dealer for a replacement.



Dear Customer:

Selecting fine audio equipment such as the unit you've just purchased is only the start of your musical enjoyment. Now it's time to consider how you can maximize the fun and excitement your equipment offers. This manufacturer and the Electronic Industries Association's Consumer Electronics Group want you to get the most out of your equipment by playing it at a safe level. One that lets the sound come through loud and clear without annoying blaring or distortion-and, most importantly, without affecting your sensitive hearing.

Sound can be deceiving. Over time your hearing "comfort level" adapts to higher volumes of sound. So what sounds "normal" can actually be loud and harmful to your hearing. Guard against this by setting your equipment at a safe level BEFORE your hearing adapts.

To establish a safe level:

- Start your volume control at a low setting.
- Slowly increase the sound until you can hear it comfortably and clearly, and without distortion.

Once you have established a comfortable sound level:

- Set the dial and leave it there.

Taking a minute to do this now will help to prevent hearing damage or loss in the future. After all, we want you listening for a lifetime.

We Want You Listening For A Lifetime

Used wisely, your new sound equipment will provide a lifetime of fun and enjoyment. Since hearing damage from loud noise is often undetectable until it is too late, this manufacturer and the Electronic Industries Association's Consumer Electronics Group recommend you avoid prolonged exposure to excessive noise. This list of sound levels is included for your protection.

Decibel

Level	Example
30	Quiet library, soft whispers
40	Living room, refrigerator, bedroom away from traffic
50	Light traffic, normal conversation, quiet office
60	Air conditioner at 20 feet, sewing machine
70	Vacuum cleaner, hair dryer, noisy restaurant
80	Average city traffic, garbage disposals, alarm clock at two feet.

THE FOLLOWING NOISES CAN BE DANGEROUS UNDER CONSTANT EXPOSURE

90	Subway, motorcycle, truck traffic, lawn mower
100	Garbage truck, chain saw, pneumatic drill
120	Rock band concert in front of speakers, thunderclap
140	Gunshot blast, jet plane
180	Rocket launching pad

Information courtesy of the Deafness Research Foundation.



Specifications

Amplifier Section

Continuous average power output of 160 watts* per channel, min., at 6 ohms, from 20 Hz to 20,000 Hz with no more than 0.09 % total harmonic distortion (front).**

Continuous Power Output (6 Ω)
 Front 160 W + 160 W (20 Hz-20 kHz, 0.09 %, 6 Ω)
 Center 160 W (20 Hz-20 kHz, 0.09 %, 6 Ω)
 Surround 160 W + 160 W (20 Hz-20 kHz, 0.09 %, 6 Ω)
 Surr. back 160 W + 160 W (20 Hz-20 kHz, 0.09 %, 6 Ω)

Continuous Power Output (8 Ω)
 Front 130 W + 130 W (20 Hz-20 kHz, 0.09 %, 8 Ω)
 Center 130 W (20 Hz-20 kHz, 0.09 %, 8 Ω)
 Surround 130 W + 130 W (20 Hz-20 kHz, 0.09 %, 8 Ω)
 Surr. back 130 W + 130 W (20 Hz-20 kHz, 0.09 %, 8 Ω)

Audio Section

Input (Sensitivity/Impedance)
 PHONO MM 4.7 mV/47 kΩ
 LINE 382 mV/47 kΩ

Phono Overload level (T.H.D.0.1 %, 1kHz)
 PHONO MM 120 mV

Frequency Response
 PHONO MM 20 Hz to 20,000 Hz ± 0.3 dB
 LINE 5 Hz to 100,000 Hz \pm_{-3}^{+0} dB

Output (Level/Impedance)
 LINE 382 mV/2.2 kΩ

Tone Control
 BASS ± 6 dB (100 Hz)
 TREBLE ± 6 dB (10 kHz)
 LOUDNESS +4/+2 dB (100Hz/10 kHz)
 (at volume position -40dB)

Signal-to-Noise Ratio (IHF, short circuited, A network)
 PHONO MM 86 dB
 LINE 105 dB

Signal-to-Noise Ratio [EIA, at 1 W (1 kHz)]
 PHONO MM 83 dB
 LINE 93 dB

* Measured pursuant to the Federal Trade Commission's Trade Regulation rule on Power Output Claims for Amplifiers.

** Measured by Audio Spectrum Analyzer.

Video Section

Input (Sensitivity) 1 Vp-p/75 Ω
 Output (Level/Impedance) 1 Vp-p/75 Ω
 Signal-to-Noise Ratio 70 dB
 Frequency Response 5 Hz to 10 MHz dB

Component Video Section

Input (Sensitivity) 1 Vp-p/75 Ω
 Output (Level/Impedance) 1 Vp-p/75 Ω
 Signal-to-Noise Ratio 70 dB
 Frequency Response 5 Hz to 40 MHz \pm_{-3}^{+0} dB

FM Tuner Section

Frequency Range 87.5 MHz to 108 MHz
 Usable Sensitivity Mono: 13.2 dBf, IHF (1.3 μV/75 Ω)
 50 dB Quieting Sensitivity Mono: 20.2 dBf
 Stereo: 38.6 dBf
 Signal-to-Noise Ratio Mono: 73 dB (at 85 dBf)
 Stereo: 70 dB (at 85 dBf)
 Distortion Stereo: 0.5 % (1 kHz)
 Alternate Channel Selectivity 60 dB (400 kHz)
 Stereo Separation 40 dB (1 kHz)
 Frequency Response 30 Hz to 15 kHz (± 1) dB
 Antenna Input 75 Ω unbalanced

AM Tuner Section

Frequency Range 530 kHz to 1,700 kHz
 Sensitivity (IHF, Loop antenna) 350 μV/m
 Selectivity 25 dB
 Signal-to-Noise Ratio 50 dB
 Antenna Loop antenna

Miscellaneous

Power Requirements AC 120 V, 60 Hz
 Power Consumption 710 W
 Power Consumption in Standby mode 0.65 W
 AC Outlet
 SWITCHED 100 W (0.8 A) MAX
 Dimensions 440 (W) × 203 (H) × 472 (D) mm
 (17 $\frac{5}{16}$ (W) × 8 (H) × 18 $\frac{9}{16}$ (D) in.)
 Weight (without package) 28.3 kg (62 lb 4 oz)

Furnished Parts

FM wire Antenna 1
 AM Loop Antenna 1
 "AA" IEC LR6 batteries 4
 Remote Control Unit 1
 Remote Control Cable 1
 Remote Control Stand 1
 U-shaped connectors 2
 AC Power Cord 1
 Operating Instructions 1

NOTE:

Specifications and the design are subject to possible modifications without notice, due to improvements.

Maintenance of External Surfaces

- Use a polishing cloth or dry cloth to wipe off dust and dirt.
- When the surfaces are dirty, wipe with a soft cloth dipped in some neutral cleanser diluted five or six times with water, and wrung out well, and then wipe again with a dry cloth. Do not use furniture wax or cleaners.
- Never use thinners, benzine, insecticide sprays or other chemicals on or near this unit, since these will corrode the surfaces.

Should this product require service in the U.S.A. and you wish to locate the nearest Pioneer Authorized Independent Service Company, or if you wish to purchase replacement parts, operating instructions, service manuals, or accessories, please call the number shown below.

8 0 0 – 4 2 1 – 1 4 0 4

Please do not ship your product to Pioneer without first calling the Customer Service Department at the above listed number for assistance.

PIONEER ELECTRONICS SERVICE, INC.
CUSTOMER SERVICE DEPARTMENT
P.O. BOX 1760, LONG BEACH,
CA 90801-1760, U.S.A.

For warranty information please see the Limited Warranty sheet included with your product.

Should this product require service in Canada, please contact a Pioneer Canadian Authorized Dealer to locate the nearest Pioneer Authorized Service Company in Canada. Alternatively, please contact the Customer Service Department at the following address:

Pioneer Electronics of Canada, Inc.
Customer Service Department
300 Allstate Parkway, Markham, Ontario L3R
OP2
(905) 479-4411
1-877-283-5901

For warranty information please see the Limited Warranty sheet included with your product.

Si ce produit doit être réparé au Canada, veuillez vous adresser à un distributeur autorisée Pioneer au Canada pour obtenir le nom de la Société de Service Autorisée Pioneer le plus près de chez vous. Ou encore, veuillez vous communiquer avec le Service de Clientèle de Pioneer:

Pioneer électroniques du Canada, Inc.
Département de service au consommateurs
300 Allstate Parkway, Markham, Ontario L3R
OP2
(905) 479-4411
1-877-283-5901

Pour obtenir des renseignements sur la garantie, veuillez vous reporter au feuillet sur la Garantie Limitée qui accompagne le produit.

Published by Pioneer Corporation.
Copyright © 2001 Pioneer Corporation.
All rights reserved.

PIONEER CORPORATION 4-1, Meguro 1-Chome, Meguro-ku, Tokyo 153-8654, Japan
PIONEER ELECTRONICS [USA] INC. P.O. BOX 1540, Long Beach, California 90801-1540, U.S.A.
PIONEER ELECTRONICS OF CANADA, INC. 300 Allstate Parkway, Markham, Ontario L3R OP2, Canada
PIONEER EUROPE NV Haven 1087, Keetberglaan 1, B-9120 Melsele, Belgium TEL: 03/570.05.11
PIONEER ELECTRONICS AUSTRALIA PTY. LTD. 178-184 Boundary Road, Braeside, Victoria 3195, Australia, TEL: [03] 9586-6300
PIONEER ELECTRONICS DE MEXICO S.A. DE C.V. San Lorenzo 1009 3er Piso Desp. 302 Col. Del Valle Mexico D.F. C.P. 03100
TEL: 5-688-52-90

Free Manuals Download Website

<http://myh66.com>

<http://usermanuals.us>

<http://www.somanuals.com>

<http://www.4manuals.cc>

<http://www.manual-lib.com>

<http://www.404manual.com>

<http://www.luxmanual.com>

<http://aubethermostatmanual.com>

Golf course search by state

<http://golfingnear.com>

Email search by domain

<http://emailbydomain.com>

Auto manuals search

<http://auto.somanuals.com>

TV manuals search

<http://tv.somanuals.com>