

**Pioneer** *sound.vision.soul*

**AUDIO/VIDEO MULTI-CHANNEL  
RECEIVER**

**VSX-9300TX**

**Register your product at  
[www.pioneerelectronics.com](http://www.pioneerelectronics.com)**

- **Protect your new investment**  
The details of your purchase will be on file for reference in the event of an insurance claim such as loss or theft.
- **Receive free tips, updates and service bulletins on your new product**
- **Improve product development**  
Your input helps us continue to design products that meet your needs.
- **Receive a free Pioneer newsletter**  
Registered customers can opt in to receive a monthly newsletter.

**Operating Instructions**



The lightning flash with arrowhead, within an equilateral triangle, is intended to alert the user to the presence of uninsulated "dangerous voltage" within the product's enclosure that may be of sufficient magnitude to constitute a risk of electric shock to persons.

## CAUTION

**RISK OF ELECTRIC SHOCK  
DO NOT OPEN**

### CAUTION:

TO PREVENT THE RISK OF ELECTRIC SHOCK, DO NOT REMOVE COVER (OR BACK). NO USER-SERVICEABLE PARTS INSIDE. REFER SERVICING TO QUALIFIED SERVICE PERSONNEL.



The exclamation point within an equilateral triangle is intended to alert the user to the presence of important operating and maintenance (servicing) instructions in the literature accompanying the appliance.

D1-4-2-3\_En

Thank you for buying this Pioneer product. Please read through these operating instructions so you will know how to operate your model properly. After you have finished reading the instructions, put them away in a safe place for future reference.

**WARNING:** Handling the cord on this product or cords associated with accessories sold with the product will expose you to lead, a chemical known to the State of California and other governmental entities to cause cancer and birth defects or other reproductive harm.

**Wash hands after handling**

D36-P4\_En

**WARNING** – TO PREVENT FIRE OR SHOCK HAZARD, DO NOT EXPOSE THIS APPLIANCE TO RAIN OR MOISTURE.

D1-4-2-1\_En

**CAUTION** – TO PREVENT ELECTRIC SHOCK DO NOT USE THIS (POLARIZED) PLUG WITH AN EXTENSION CORD, RECEPTACLE OR OTHER OUTLET UNLESS THE BLADES CAN BE FULLY INSERTED TO PREVENT BLADE EXPOSURE.

**ATTENTION** – POUR PREVENIR LES CHOCS ELECTRIQUES, NE PAS UTILISER CETTE FICHE POLARISEE AVEC UN PROLONGATEUR, UNE PRISE DE COURANT, OU UNE AUTRE SORTIE DE COURANT, SAUF SI LES LAMES PEUVENT ETRE INSEREES A FOND SANS EN LAISSER AUCUNE PARTIE A DECOUVERT.

D2-4-4-1\_EF

**IMPORTANT NOTICE** – THE SERIAL NUMBER FOR THIS EQUIPMENT IS LOCATED IN THE REAR. PLEASE WRITE THIS SERIAL NUMBER ON YOUR ENCLOSED WARRANTY CARD AND KEEP IN A SECURE AREA. THIS IS FOR YOUR SECURITY.

D11-4-2-6-1\_En

This Class B digital apparatus complies with Canadian ICES-003.

Cet appareil numérique de la Classe B est conforme à la norme NMB-003 du Canada.

D8-10-1-3\_EF

### Information to User

Alteration or modifications carried out without appropriate authorization may invalidate the user's right to operate the equipment.

D8-10-2\_En

**NOTE:** This equipment has been tested and found to comply with the limits for a Class B digital device, pursuant to Part 15 of the FCC Rules. These limits are designed to provide reasonable protection against harmful interference in a residential installation. This equipment generates, uses, and can radiate radio frequency energy and, if not installed and used in accordance with the instructions, may cause harmful interference to radio communications. However, there is no guarantee that interference will not occur in a particular installation. If this equipment does cause harmful interference to radio or television reception, which can be determined by turning the equipment off and on, the user is encouraged to try to correct the interference by one or more of the following measures:

- Reorient or relocate the receiving antenna.
- Increase the separation between the equipment and receiver.
- Connect the equipment into an outlet on a circuit different from that to which the receiver is connected.
- Consult the dealer or an experienced radio/TV technician for help.

D8-10-1-2\_En

**CAUTION:** This product satisfies FCC regulations when shielded cables and connectors are used to connect the unit to other equipment. To prevent electromagnetic interference with electric appliances such as radios and televisions, use shielded cables and connectors for connections.

D8-10-3a\_En

# IMPORTANT SAFETY INSTRUCTIONS

**READ INSTRUCTIONS** — All the safety and operating instructions should be read before the product is operated.

**RETAIN INSTRUCTIONS** — The safety and operating instructions should be retained for future reference.

**HEED WARNINGS** — All warnings on the product and in the operating instructions should be adhered to.

**FOLLOW INSTRUCTIONS** — All operating and use instructions should be followed.

**CLEANING** — The product should be cleaned only with a polishing cloth or a soft dry cloth. Never clean with furniture wax, benzene, insecticides or other volatile liquids since they may corrode the cabinet.

**ATTACHMENTS** — Do not use attachments not recommended by the product manufacturer as they may cause hazards.

**WATER AND MOISTURE** — Do not use this product near water — for example, near a bathtub, wash bowl, kitchen sink, or laundry tub; in a wet basement; or near a swimming pool; and the like.

**ACCESSORIES** — Do not place this product on an unstable cart, stand, tripod, bracket, or table. The product may fall, causing serious injury to a child or adult, and serious damage to the product. Use only with a cart, stand, tripod, bracket, or table recommended by the manufacturer, or sold with the product. Any mounting of the product should follow the manufacturer's instructions, and should use a mounting accessory recommended by the manufacturer.

**CART** — A product and cart combination should be moved with care. Quick stops, excessive force, and uneven surfaces may cause the product and cart combination to overturn.



**VENTILATION** — Slots and openings in the cabinet are provided for ventilation and to ensure reliable operation of the product and to protect it from overheating, and these openings must not be blocked or covered. The openings should never be blocked by placing the product on a bed, sofa, rug, or other similar surface. This product should not be placed in a built-in installation such as a bookcase or rack unless proper ventilation is provided or the manufacturer's instructions have been adhered to.

**POWER SOURCES** — This product should be operated only from the type of power source indicated on the marking label. If you are not sure of the type of power supply to your home, consult your product dealer or local power company.

**LOCATION** — The appliance should be installed in a stable location.

**NONUSE PERIODS** — The power cord of the appliance should be unplugged from the outlet when left un-used for a long period of time.

## GROUNDING OR POLARIZATION

- If this product is equipped with a polarized alternating current line plug (a plug having one blade wider than the other), it will fit into the outlet only one way. This is a safety feature. If you are unable to insert the plug fully into the outlet, try reversing the plug. If the plug should still fail to fit, contact your electrician to replace your obsolete outlet. Do not defeat the safety purpose of the polarized plug.
- If this product is equipped with a three-wire grounding type plug, a plug having a third (grounding) pin, it will only fit into a grounding type power outlet. This is a safety feature. If you are unable to insert the plug into the outlet, contact your electrician to replace your obsolete outlet. Do not defeat the safety purpose of the grounding type plug.

**POWER-CORD PROTECTION** — Power-supply cords should be routed so that they are not likely to be walked on or pinched by items placed upon or against them, paying particular attention to cords at plugs, convenience receptacles, and the point where they exit from the product.

**OUTDOOR ANTENNA GROUNDING** — If an outside antenna or cable system is connected to the product, be sure the antenna or cable system is grounded so as to provide some protection against voltage surges and built-up static charges. Article 810 of the National Electrical Code, ANSI/NFPA 70, provides information with regard to proper grounding of the mast and supporting structure, grounding of the lead-in wire to an antenna discharge unit, size of grounding conductors, location of antenna-discharge unit, connection to grounding electrodes, and requirements for the grounding electrode. See Figure A.

**LIGHTNING** — For added protection for this product during a lightning storm, or when it is left unattended and unused for long periods of time, unplug it from the wall outlet and disconnect the antenna or cable system. This will prevent damage to the product due to lightning and power-line surges.

**POWER LINES** — An outside antenna system should not be located in the vicinity of overhead power lines or other electric light or power circuits, or where it can fall into such power lines or circuits. When installing an outside antenna system, extreme care should be taken to keep from touching such power lines or circuits as contact with them might be fatal.

**OVERLOADING** — Do not overload wall outlets, extension cords, or integral convenience receptacles as this can result in a risk of fire or electric shock.

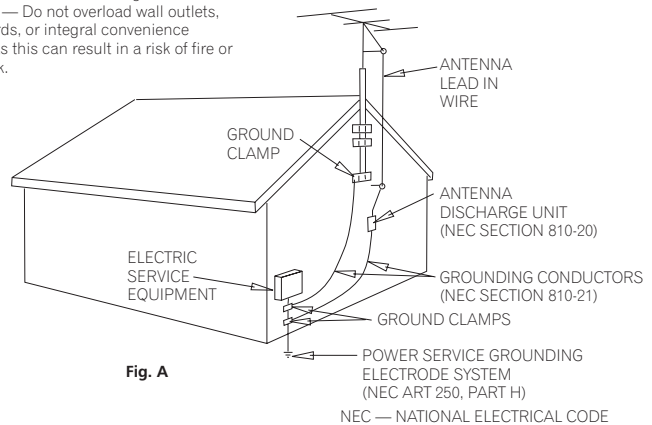

Fig. A

**OBJECT AND LIQUID ENTRY** — Never push objects of any kind into this product through openings as they may touch dangerous voltage points or short-out parts that could result in a fire or electric shock. Never spill liquid of any kind on the product.

**SERVICING** — Do not attempt to service this product yourself as opening or removing covers may expose you to dangerous voltage or other hazards. Refer all servicing to qualified service personnel.

**DAMAGE REQUIRING SERVICE** — Unplug this product from the wall outlet and refer servicing to qualified service personnel under the following conditions:

- When the power-supply cord or plug is damaged.
- If liquid has been spilled, or objects have fallen into the product.
- If the product has been exposed to rain or water.
- If the product does not operate normally by following the operating instructions. Adjust only those controls that are covered by the operating instructions as an improper adjustment of other controls may result in damage and will often require extensive work by a qualified technician to restore the product to its normal operation.
- If the product has been dropped or damaged in any way.
- When the product exhibits a distinct change in performance — this indicates a need for service.

**REPLACEMENT PARTS** — When replacement parts are required, be sure the service technician has used replacement parts specified by the manufacturer or have the same characteristics as the original part. Unauthorized substitutions may result in fire, electric shock, or other hazards.

**SAFETY CHECK** — Upon completion of any service or repairs to this product, ask the service technician to perform safety checks to determine that the product is in proper operating condition.

**WALL OR CEILING MOUNTING** — The product should not be mounted to a wall or ceiling.

**HEAT** — The product should be situated away from heat sources such as radiators, heat registers, stoves, or other products (including amplifiers) that produce heat.

This product is for general household purposes. Any failure due to use for other than household purposes (such as long-term use for business purposes in a restaurant or use in a car or ship) and which requires repair will be charged for even during the warranty period.

K041\_En

For U.S. and Australia Model



# Contents

## 01 Before you start

Features .....	6
Checking the supplied accessories .....	6
Ventilation .....	7
Installing the receiver .....	7
Opening the front panel .....	7
Using the remote control .....	7
Loading the batteries .....	7
Operating range of the remote control .....	8

## 02 5 minute guide

Introduction to home theater .....	9
Setting up for Surround Sound .....	9
Automatically setting up for surround sound .....	12
Other problems when using the Auto Surround Setup .....	14
Checking the settings on your DVD (or other) player .....	14
Playing a source .....	14

## 03 Connecting your equipment

Rear panel .....	15
About the video converter .....	16
About cable types .....	17
Analog audio cables .....	17
Digital audio cables .....	17
Video cables .....	17
When making cable connections .....	17
Connecting your TV .....	18
Connecting a DVD player .....	19
Connecting the multichannel analog outputs .....	20
Connecting a satellite/cable receiver or other set-top box .....	21
Connecting a VCR or DVD recorder .....	22
Connecting other video sources .....	23
Using the component video jacks .....	24
Connecting digital audio sources .....	25
Connecting analog audio sources .....	26
Connecting a component to the front panel inputs .....	27
Installing your speaker system .....	28
Connecting the speakers .....	29
Placing the speakers .....	29
Connecting antennas .....	30
AM loop antenna .....	30
FM wire antenna .....	30
Connecting external antennas .....	30
Plugging in the receiver .....	31
About the AC outlet .....	31

## 04 Controls and displays

Front panel .....	32
Display .....	34
Remote control .....	35

## 05 Listening to your system

Auto playback .....	37
Listening in surround sound .....	37
The MOVIE listening modes .....	38
The MUSIC listening modes .....	39
Dolby Pro Logic IIx Music settings .....	39
Adjusting the advanced effect level .....	40
Listening in stereo .....	40
Listening with headphones .....	40
Using the multichannel analog inputs .....	41
Listening with Acoustic Calibration EQ .....	41
Selecting the input signal type .....	42
Using the surround back channel .....	43
Listening with virtual surround back speakers .....	44
Using the audio scaler for Hi-bit and Hi-sampling .....	44
Using Midnight and Loudness listening .....	45
Using the tone control .....	45
Switching the tone control on or off .....	45
Adjusting the bass and treble .....	45
Reducing noise during playback .....	46
Listening to dual mono soundtracks .....	46

## 06 Using the tuner

Finding a station .....	47
Tuning directly to a station .....	47
MPX mode .....	48
Memorizing station presets .....	48
Listening to memorized station presets .....	49
Naming station presets .....	49

## 07 The Surround Setup menu

Making receiver settings from the Surround Setup menu .....	50
Surround back speaker setting .....	51
Normal surround setting .....	51
Speaker Setting .....	51
Channel Level .....	52
Speaker Distance .....	53

## 08 Controlling other equipment

Using the remote control with other components ..	54
Recalling preset codes ..	54
Programming signals from other remote controls ..	55
Controls for TVs ..	56
Controls for other components ..	57
Direct function ..	59
Multi Operation and System Off ..	59
Programming a multi-operation or a shutdown sequence ..	59
Using multi operations ..	60
Using System off ..	61
Switching components on and off using the 12 volt trigger ..	61
Operating other Pioneer components with this unit's sensor ..	61

## 09 Using other functions

Making an audio or a video recording ..	62
Adjusting the delay of a soundtrack ..	62
Watching video and audio sources independently ..	63
Dimming the display ..	63
Switching the speaker impedance ..	64
Advanced remote control features ..	64
Editing remote control display names ..	64
Adjusting the remote control backlight ..	65
Clearing remote control settings ..	65
Resetting the system ..	66

## 10 Other connections

Second Zone speaker B setup ..	67
Switching the speaker system ..	67
Bi-amping your front speakers ..	68
Bi-wiring your speakers ..	68
Multi-room listening ..	69
Making multi-room connections ..	69
Using the multi-room controls ..	70
Connecting an IR receiver ..	71
Connecting additional amplifiers ..	71
Using the USB interface ..	72
Connecting a PC for Advanced MCACC output ..	73
Advanced MCACC output using your PC ..	73

## 11 Advanced setup

The System Setup menu ..	74
THX CINEMA Setup ..	75
The Input Assign menu ..	75
Function Rename ..	76
PHONO/LINE Setup ..	78
Multi-Room and IR receiver setup ..	78
12 Volt Trigger ..	79
The Expert setup menu ..	79
Crossover Network ..	80
Fine Channel Level ..	81
Fine Channel Delay ..	81
Acoustic Calibration EQ ..	82
Professional Acoustic Calibration ..	84
Using Professional Acoustic Calibration ..	85
Bass Peak Level ..	87
Dynamic Range Control ..	88

## 12 Additional information

Troubleshooting ..	89
Power ..	89
No sound ..	90
Other audio problems ..	91
Video ..	92
Settings ..	93
Display ..	93
Remote control ..	94
USB interface ..	94
Surround sound formats ..	96
Dolby ..	96
DTS ..	96
About THX® ..	97
Preset code brands ..	98
Specifications ..	99
Maintenance of external surfaces ..	99

## Chapter 1

# Before you start

### Features

- **Easy setup using Advanced Multichannel Acoustic Calibration (MCACC)**

Setting up for home theater sound is as easy as connecting your speakers, a DVD player or other source, and your TV. The Auto Surround Setup provides a quick but accurate surround sound setup, while for complete surround sound control you still have access to the full range of surround sound settings.

In addition, the Professional Acoustic Calibration setup measures the reverb characteristics of your listening area, allowing you to customize your system calibration with the help of a graphical output that can be displayed on-screen, or using a computer.

- **Dolby Digital and DTS decoding, including Dolby Digital EX, DTS 96/24 and DTS-ES**

Dolby Digital and DTS decoding brings theater sound right into your home with up to six channels of surround sound, including a special LFE (Low Frequency Effects) channel for deep, realistic sound effects.

The built-in Dolby Pro Logic IIx and DTS Neo:6 decoders not only provide full surround sound decoding for Dolby Surround sources, but will also generate convincing surround sound for any stereo source.

Also, with the addition of a surround back speaker, you can take advantage of the built-in Dolby Digital EX and DTS-ES decoders for six-channel surround sound.

- **Seamless video conversion**

With the Pioneer video converter, you can use a wide range of cables interchangeably, giving you more flexibility when making video connections.

- **USB digital interface**

It is possible to listen to audio sources from your computer by connecting to the USB interface on the rear of this receiver.

- **Fine-tuned to world-class standards**

With the cooperation of the world-class studio engineers at AIR Studios, this receiver amplifier has been designated AIR Studios Monitor.



### Checking the supplied accessories

Please check that you've received the following supplied accessories:

- Setup microphone and stand

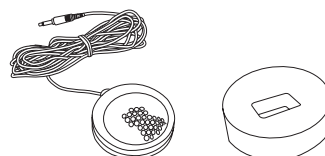

- Remote control unit



- Alkaline batteries (AA IEC LR6) x 4

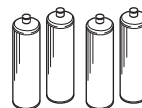

- AM loop antenna



- FM wire antenna



- Power cord

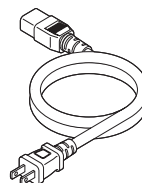

- Warranty card
- These operating instructions

## Ventilation

When installing this unit, make sure to leave space around the unit for ventilation to improve heat dispersal (at least 8 in. (20 cm) at the top). If not enough space is provided between the unit and walls or other equipment, heat will build up inside, interfering with performance and/or causing malfunctions.

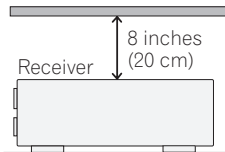

Slot and openings in the cabinet are provided for ventilation and to protect the equipment from overheating. To prevent fire hazard, do not place anything on top of the unit, make sure the openings are never blocked or covered with items (such as newspapers, table-cloths and curtains), and do not operate the equipment on thick carpet or a bed.

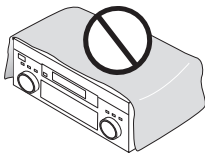

## Installing the receiver

- When installing this unit, make sure to put it on a level and stable surface.

Don't install it on the following places:

- on a color TV (the screen may distort)
- near a cassette deck (or close to a device that gives off a magnetic field). This may interfere with the sound.
- in direct sunlight
- in damp or wet areas
- in extremely hot or cold areas
- in places where there is vibration or other movement
- in places that are very dusty
- in places that have hot fumes or oils (such as a kitchen)

## Opening the front panel

To open the front panel, push gently on the lower third of the panel with your finger.

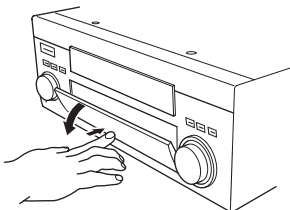

## Using the remote control

### Loading the batteries

Load the batteries into the remote control as shown below using alkaline batteries (AA IEC LR6) batteries. When you notice a decrease in the operating range, replace all batteries with new ones.

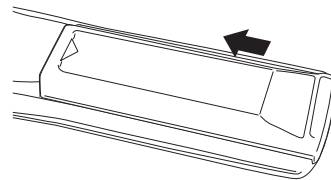
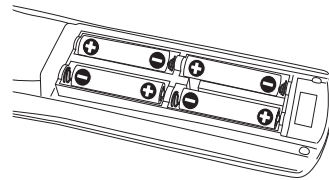
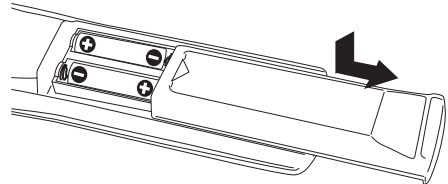

### ⚠ Caution

Incorrect use of batteries can result in hazards such as leakage and bursting. Please observe the following:

- Don't mix new and old batteries together.
- Don't use different kinds of batteries together—although they may look similar, different batteries may have different voltages.
- Make sure that the plus and minus ends of each battery match the indications in the battery compartment.
- Remove batteries from equipment that isn't going to be used for a month or more.
- When disposing of used batteries, please comply with governmental regulations or environmental public instruction's rules that apply in your country or area.

H048 En

### Remote control battery indicator

When the batteries get too weak to operate the remote control properly an indicator warning screen will appear on the remote. Change the batteries as shown above. This must be done within five minutes or all your remote control settings will be cleared.

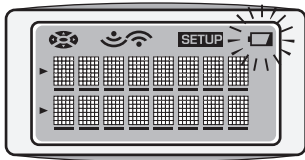

### Operating range of the remote control

The operating range is quite large, but please keep in mind the following when using the remote control:

- Make sure that there are no obstacles between the remote and the remote sensor on the unit.
- The remote has a range of about 23 feet (7 meters).

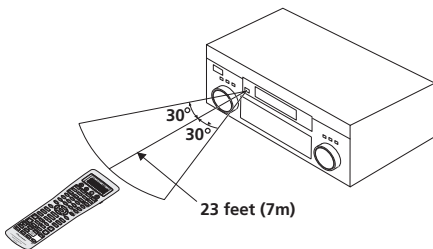

- Remote operation may become unreliable if strong sunlight or fluorescent light is shining on the unit's remote sensor.
- Remote controllers for different devices can interfere with each other. Avoid using remotes for other equipment located close to this unit.



## Chapter 2: 5 minute guide

### Introduction to home theater

You are probably used to using stereo equipment to listen to music, but may not be used to home theater systems that give you many more options (such as surround sound) when listening to soundtracks.

Home theater refers to the use of multiple audio tracks to create a surround sound effect, making you feel like you're in the middle of the action or concert. The surround sound you get from a home theater system depends not only on the speakers you have set up in your room, but also on the source and the sound settings of the receiver.

DVD-Video has become the basic source material for home theater due to its size, quality, and ease of use. Depending on the DVD, you can have up to seven different audio tracks coming from one disc, all of them being sent to different speakers in your system. This is what creates a surround sound effect and gives you the feeling of 'being there'.

This receiver will automatically decode Dolby Digital, DTS, or Dolby Surround DVD-Video discs, according to your speaker setup. In most cases, you won't have to make changes for realistic surround sound, but other possibilities (like listening to a CD with multichannel surround sound) are explained in *Listening to your system* on page 37.

### Setting up for Surround Sound

This receiver was designed with the easiest possible setup in mind, so with the following quick setup guide, you should have your system hooked up for surround sound in no time at all. In most cases, you can simply leave the receiver in the default settings.

Be sure to complete all connections before connecting this unit to the AC power source.

#### 1 Hook up your DVD player.

For surround sound, you'll want to hook up using a digital connection from the DVD player to the receiver. You can do this with either a coaxial, or an optical connection (you don't need to connect both). If you hook up using an optical cable, you should refer to *The Input Assign menu* on page 75 to assign the optical input to **DVD/LD**.

Use a standard RCA video cable to connect your DVD player video output to the receiver using the jacks shown below.

#### 2 Hook up your TV.

Use a standard RCA video cable to connect your receiver to the TV using the jacks as shown below.

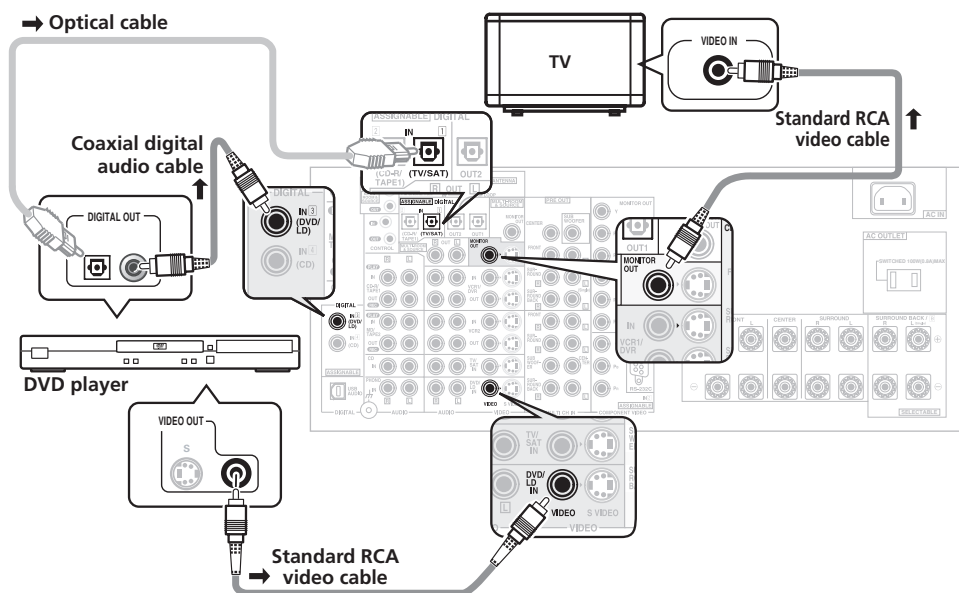

### 3 Connect your speakers.

To take full advantage of the receiver's surround sound capabilities connect front, center, surround and surround back speakers, as well as a subwoofer. Although this is ideal, other configurations with fewer speakers—no subwoofer or no center speaker, or even no surround speakers—will work. At the very least, front left and right speakers only are necessary. Note that your main surround speakers should always be connected as a pair, but you can connect just one surround back speaker if you like (it must be connected to the left surround back terminal).

You can use speakers with a nominal impedance between 6–16 $\Omega$  (please see *Switching the speaker impedance* on page 64 if you plan to use speakers with an impedance of less than 8 $\Omega$ ).

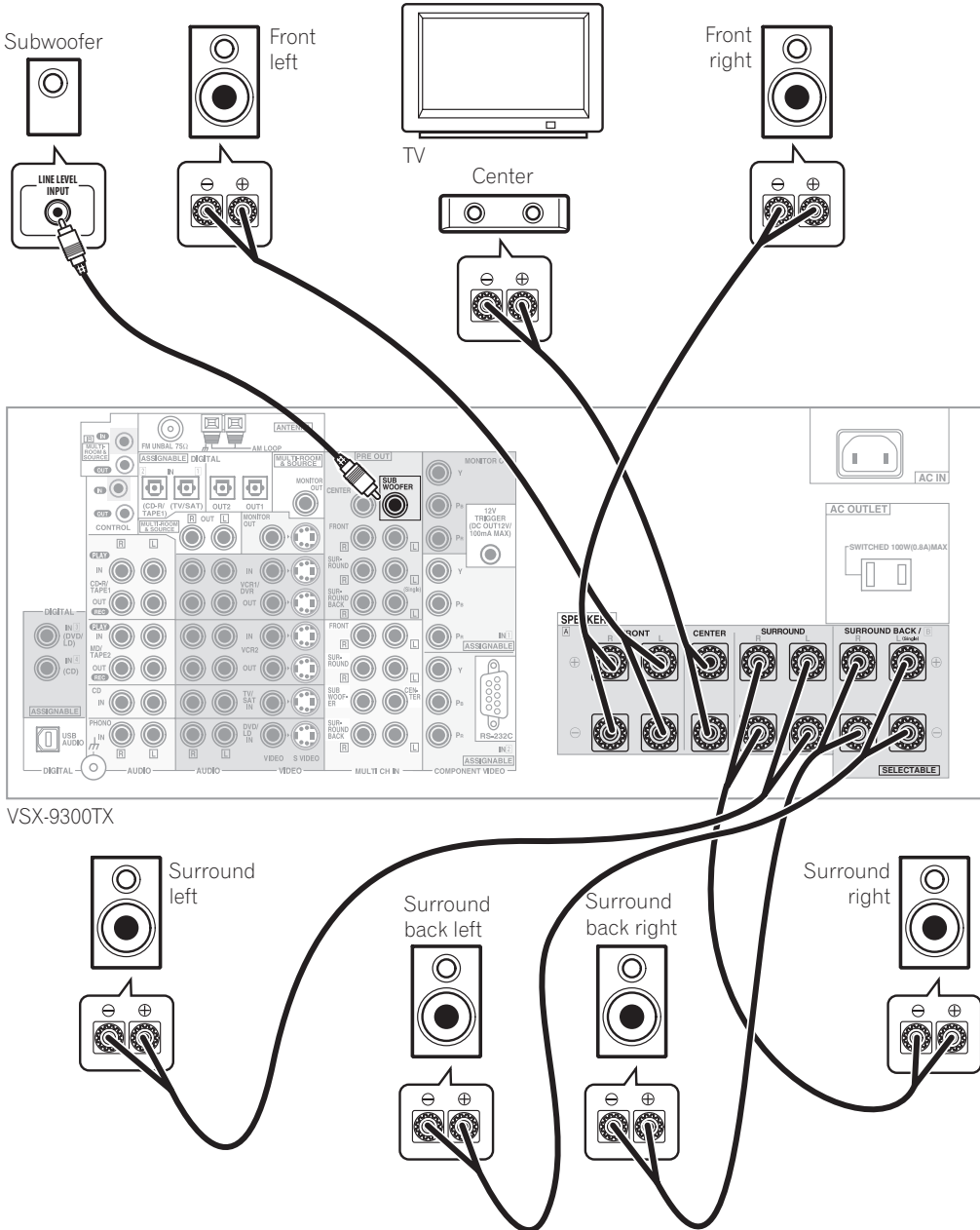

VSX-9300TX

Each speaker connection on the receiver comprises a positive (+) red, and negative (-) black terminal. For proper sound you should take care to match these up with the terminals on the speakers themselves.

- If you only have one surround back speaker, hook it up to the surround back left (**Single**) terminal.
- If you're not using a subwoofer, change the front speaker setting (see *Speaker Setting* on page 51) to **LARGE**.

### ⚠ Caution

- Make sure that all the bare speaker wire is twisted together and inserted fully into the speaker terminal. If any of the bare speaker wire touches the back panel it may cause the power to cut off as a safety measure.

Make sure that the speaker cable you're going to use is properly prepared with about  $\frac{3}{8}$  in. (10 mm) of insulator stripped from each wire, and the exposed wire strands twisted together (*fig. A*).

To connect a terminal, unscrew the terminal a few turns until there is enough space to insert the exposed wire (*fig. B*). Once the wire is in position, tighten the terminal until the wire is firmly clamped (*fig. C*).

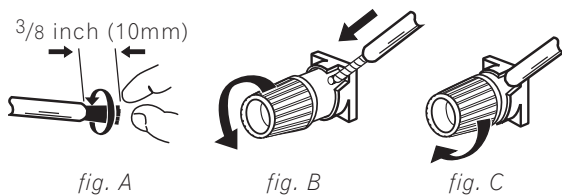

Where you place the speakers will have a big effect on the sound. Place your speakers as shown below for the best surround sound effect. For more tips on speaker placement, see *Placing the speakers* on page 29.

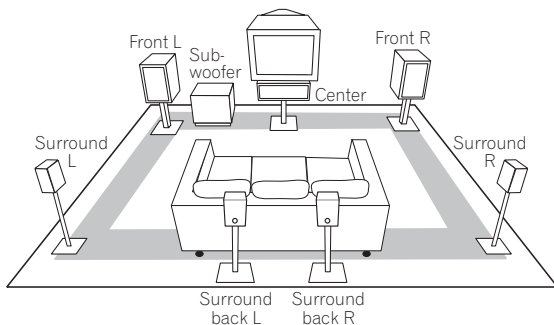

### 4 Plug in the receiver and switch it on, followed by your DVD player, your subwoofer and the TV.

Make sure you've set the video input on your TV to this receiver. Check the manual that came with the TV if you don't know how to do this.

Also make sure that **DVD/LD** is showing in the receiver's display, indicating that the DVD input is selected. If it isn't, press **DVD/LD** on the remote control to set the receiver to the DVD input.

### 5 Use the on-screen Auto Surround setup to set up your system.

See *Automatically setting up for surround sound* on the next page for more on this.

### 6 Play a DVD, and adjust the volume to your liking.

In addition to the basic playback explained in *Playing a source* on page 14, there are several other sound options you can select. See *Listening to your system* on page 37 for more on this. See also *Making receiver settings from the Surround Setup menu* on page 50 for more setup options.

- If you're not familiar with the proper DVD settings, refer to *Checking the settings on your DVD (or other) player* on page 14.

## Automatically setting up for surround sound

The Auto Surround Setup measures the acoustic characteristics of your listening area, taking into account ambient noise, speaker size and distance, and tests for both channel delay and channel level. After you have set up the microphone provided with your system, the receiver uses the information from a series of test tones to optimize the speaker settings and equalization for your particular room.

Make sure you do this before moving on to *Playing a source* on page 14.

### Important

- Make sure the microphone and speakers are not moved during the Auto Surround Setup.
- Using the Auto Surround Setup will overwrite any existing speaker settings in the receiver.
- The receiver will automatically exit the on-screen menu after three minutes of inactivity.

### Caution

- The test tones used in the Auto Surround Setup are output at high volume.

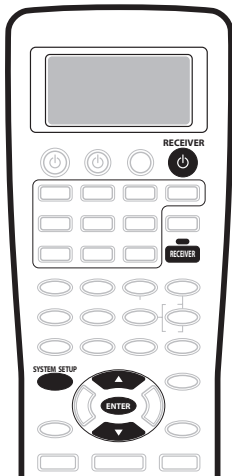

- 1 Switch on the receiver and your TV. Use the  **RECEIVER** button to switch on.

- 2 Connect the microphone to the **MCACC SETUP MIC jack on the front panel.**

Make sure there are no obstacles between the speakers and the microphone.

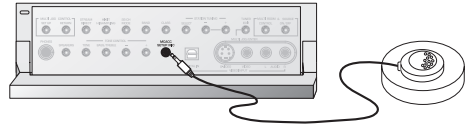

- Place the microphone on the supplied microphone stand (shown above) for the best results with the Auto Surround Setup.

### Important

- If you have a tripod, use it to *place the microphone so that it's about ear level* at your normal listening position. Otherwise, place the microphone at ear level using a table or a chair.

- 3 Press **RECEIVER** on the remote control, then press the **SYSTEM SETUP** button.

An on-screen display (OSD) appears on your TV. Use the **▲/▼** (cursor up/down) buttons and **ENTER** on the remote control to navigate through the screens and select menu items.

- 4 'Surround Setup' should be highlighted. Press **ENTER**.

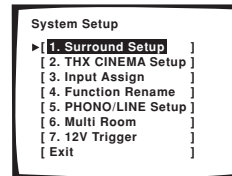

- 5 'SurrBack System' should be highlighted. Press **ENTER**.

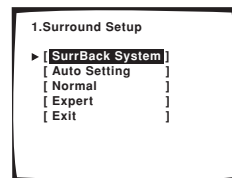

**6 Make sure 'Normal System' is selected, then select 'Exit'.**

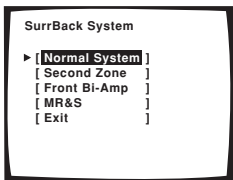

- If you are planning on bi-amping your front speakers, or setting up a separate speaker system in another room, read through *Surround back speaker setting* on page 51 and make sure to connect your speakers as necessary before continuing to step 7.

**7 'Auto Setting' should be highlighted. Press ENTER.**

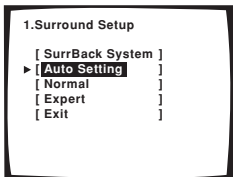

**8 Follow the instructions on-screen.**

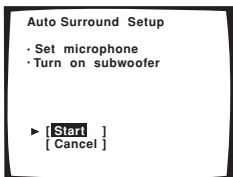

- Make sure the microphone is connected.
- If you're using a subwoofer, switch it on and turn up the volume.
- See below for notes regarding high background noise levels and other possible interference.

**9 Make sure 'Start' is selected, then press ENTER.**

A progress report is displayed on-screen while the receiver outputs test tones to determine the speakers present in your setup. Try to be as quiet as possible while it's doing this.

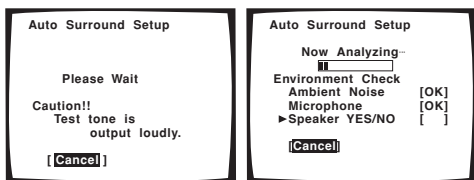

- Do not turn down the volume during the test tones. This may result in incorrect speaker settings.

**10 Confirm the speaker configuration in the OSD.**

The configuration shown on-screen should reflect the actual speakers you have.

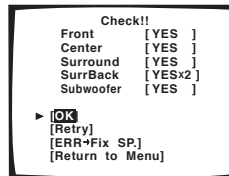

If the speaker configuration displayed isn't correct, use the ▲/▼ (cursor up/down) buttons to select **Retry**. Follow the instructions from step 8.

If the configuration is incorrect and you want to input the settings manually, select **ERR→Fix SP**. Use ▲/▼ (cursor up/down) to select the speaker and to specify the size (and number for surround back). When you're finished, go to the next step.

If you see an **ERR** message in the right side column, there may be a problem with the speaker connection. If selecting **Retry** (above) doesn't fix the problem, turn off the power and check the speaker connections.

**11 Make sure 'OK' is selected, then press ENTER.**

A progress report is displayed on-screen while the receiver outputs more test tones to determine the optimum receiver settings for channel level, speaker distance, and acoustic calibration EQ.

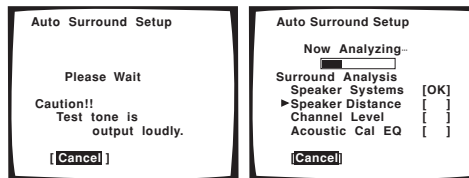

Again, try to be as quiet as possible while this is happening.

**12 The Auto Surround Setup has finished! Select 'Exit' to go back to the Surround Setup menu.**

The MCACC indicator continues to light to show the surround settings are complete.

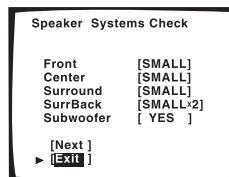

The settings made in the Auto Surround Setup should give you excellent surround sound from your system, but it is also possible to adjust these settings manually using the Surround Setup menu (starting on page 50).

You can also choose to view all the settings by selecting **Next**. Press **ENTER** after you have finished checking each screen. When you're finished, select **Exit** to go back to the Surround Setup menu.

#### Note

- If you leave a check screen for over three minutes, or if you select **Cancel** at any time during the Auto Surround Setup, the receiver automatically exits and no settings will be made.
- Remember to disconnect the microphone after you've finished the Auto Surround Setup.

### Other problems when using the Auto Surround Setup

If the room environment is not optimal for the Auto Surround Setup (too much background noise, echo off the walls, obstacles blocking the speakers from the microphone) the final settings may be incorrect. Check for household appliances (air conditioner, fridge, fan, etc.), that may be affecting the environment and switch them off if necessary.

Some older TVs may interfere with the operation of the microphone. If this seems to be happening, switch off the TV when doing the Auto Surround Setup.

### Checking the settings on your DVD (or other) player

Before continuing, you may want to check the digital audio output settings on your DVD player and digital satellite receiver.

- **Check that your DVD player/satellite receiver is set to output Dolby Digital, DTS and 88.2/96kHz PCM (2 channel) audio.**

If there is an option for MPEG audio, set this to convert the MPEG audio to PCM.

If you connected the multichannel analog outputs of the player to this receiver, make sure that the player is set to output multichannel analog audio.

#### Note

- Depending on your DVD player or source discs, you may only get digital 2 channel stereo and analog sound. In this case, select one of the surround listening modes (see *Listening in surround sound* on page 37 if you need to do this) if you want multichannel surround sound.

### Playing a source

Here are the basic instructions for playing a source (such as a DVD disc) with your home theater system.

#### 1 Turn on the power of the playback component (for example a DVD player), your TV and subwoofer (if you have one).

- If your source is the TV's built-in tuner, then switch to the channel you want to watch, otherwise make sure that the TV's video input is set to this receiver. (For example, if you connected this receiver to the **VIDEO 1** jacks on your TV, make sure that **VIDEO 1** input is now selected.)

#### 2 If the receiver isn't already on, press RECEIVER to switch it on.

#### 3 Change the receiver input to the source you want to play.

You can use the front panel **MULTI JOG** dial or the dedicated **MULTI CONTROL** buttons on the remote control.

#### 4 Start playback of the DVD (or other component).

If you're playing a Dolby Digital or DTS surround sound DVD disc, you should hear surround sound. If you are playing a stereo source, you will only hear sound from the front left/right speakers in the default listening mode.

- See also *Listening to your system* on page 37 for more information on different ways of listening to sources.

#### 5 Use the MASTER VOLUME control (front panel or remote) to adjust the volume level.

- Turn down the volume of your TV so that all the sound is coming from the speakers connected to this receiver.

#### Note

- For more detailed surround sound setup, see *The Surround Setup menu* on page 50.

### Chapter 3

# Connecting your equipment

This receiver provides you with almost limitless possibilities for connecting your audio/video system, but it doesn't have to be difficult. Depending on your needs, you could be up and running in no time after a few simple connections. This section has been designed so that you can read through this short introduction, then jump to the specific connections that you need to make. For a basic home theater setup, you may only need to look through the TV, DVD and speaker connections.

## Rear panel

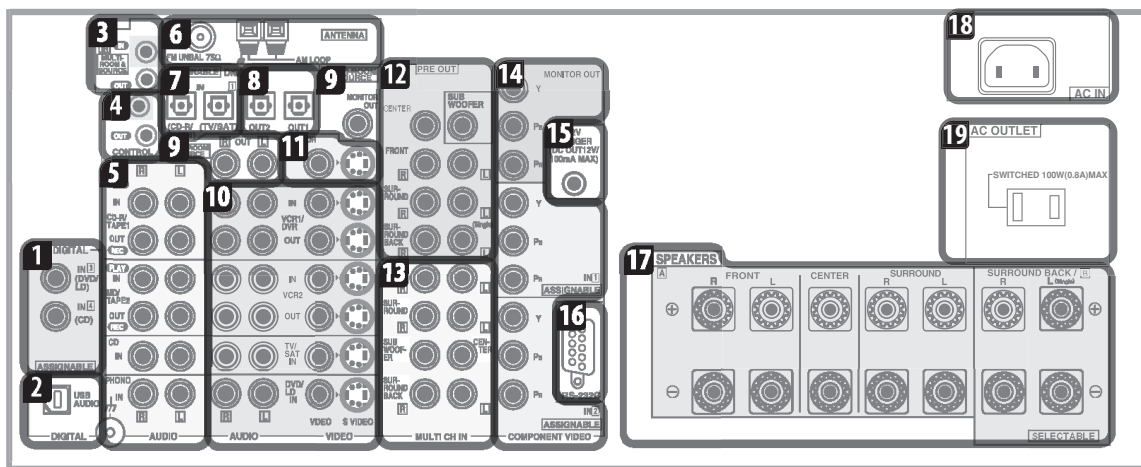

### Caution

- Before making or changing the connections, switch off the power and disconnect the power cord from the power outlet. Plugging in components should be the last connection you make with your system.

#### 1 Digital audio coaxial inputs

Two coaxial digital audio inputs for connecting digital audio sources to this receiver. All the inputs are freely assignable to input functions for maximum flexibility.

- If a connected component does not correspond to the input function (DVD/LD, etc.), see *Assigning the digital inputs* on page 75 to assign it properly.

#### 2 USB audio input

The USB audio input allows you to use your PC as a playback source for audio. See *Using the USB interface* on page 72 for connection details.

#### 3 IR input/output

An IR connection allows you to connect an external remote control sensor, when your component system is in a closed cabinet or shelving unit, for example. See *Connecting an IR receiver* on page 71 for connection details.

#### 4 Control input/output

Mini-plug terminals for connection to other Pioneer components to enable you to control all your equipment from a single remote sensor. See *Operating other Pioneer components with this unit's sensor* on page 61 for connection details.

#### 5 Stereo analog audio source inputs/outputs

Four sets of analog audio jacks for connection to audio sources such as CD players, tape decks and turntables. The **CD-R/TAPE1** and **MD/TAPE2** functions also feature outputs for recording. See *Connecting analog audio sources* on page 26 for connection details.

- The grounding (⏏) terminal is for use with turntables that require it. See *Connecting analog audio sources* on page 26 for connection details.

#### 6 Antenna terminals

Connections for AM and FM radio antennas. See *Connecting antennas* on page 30 for connection details.

#### 7 Digital audio optical inputs

Two optical digital audio inputs for connecting digital audio sources to this receiver. All the inputs are freely assignable to input functions for maximum flexibility.



- If a connected component does not correspond to the input function (**DVD/LD**, etc.), see *Assigning the digital inputs* on page 75 to assign it properly.

### 8 Digital audio outputs

Two optical digital audio outputs for connecting to a CD-R, MD or other digital recorder. See *Connecting digital audio sources* on page 25 for connection details.

### 9 Multi-room and source outputs

The analog audio outputs are for connection to a second amplifier in a separate room. The **MULTI-ROOM & SOURCE** composite video output is for connection to a second monitor or TV in a separate room. See *Multi-room listening* on page 69.

### 10 Audio/video source inputs

Each of the six source input functions has stereo analog audio jacks, a composite video jack and an S-video jack for basic connections. On top of these, you can assign digital audio and component video jacks to input functions as necessary. As well as audio/video inputs, the two input functions **VCR 1/DVR** and **VCR 2** also have audio/video outputs for recording. See *Connecting a VCR or DVD recorder* on page 22 for connection details.

### 11 Monitor video outputs

Two video outputs consisting of a standard composite video output and an S-video output, for connection to monitors and TVs. See *Connecting your TV* on page 18 for connection details.

### 12 Multichannel pre-amplifier outputs

Multichannel pre-amp outputs that you can use to connect separate amplifiers for center, surround, surround back and subwoofer channels. See *Connecting additional amplifiers* on page 71 for connection details.

### 13 Multichannel analog audio inputs

7.1 channel analog inputs for connection to a component with multichannel analog outputs. See *Connecting the multichannel analog outputs* on page 20 for connection details.

### 14 Component video inputs/output

The two component video inputs are freely assignable to any of the audio/video input functions. The component video output is for connection to a monitor or TV. See *Using the component video jacks* on page 24 for connection details.

### 15 12V trigger jack

This terminal outputs DC 12V according to the input functions (100 mA max.). See *Switching components on and off using the 12 volt trigger* on page 61 for connection details.

### 16 RS-232C connector

This port is provided for connecting a personal computer for graphical output when using Advanced MCACC.

### 17 Speaker terminals

These are the main speaker terminals for front, center, surround and surround back speakers. See *Installing your speaker system* on page 28 for connection details.

### 18 AC power inlet

Connect the supplied power cord here.

### 19 AC power outlet (Switched 100W max.)

This 120V AC power outlet can be used to power another component in your setup (up to 100 W). Power to this outlet is switched off when the receiver is in standby.

## About the video converter

The video converter allows you to connect various video sources using composite, S-video or component video connections and the signal will be output through all of the **MONITOR VIDEO OUT** jacks. The only exception is component video input, which is only output from the component video output. Therefore, if you want to connect any source using component video, you must also connect your TV using component video. If several video components are connected to the same input function, the converter gives priority to component, S-video, then composite (in that order).

The following chart shows when the video signal will be converted from the various video inputs (left column) for output to the **MONITOR VIDEO OUT** jacks (top row):

Video terminal	MONITOR OUT		
	VIDEO (Composite)	S-VIDEO	COMPONENT VIDEO
VIDEO IN (Composite)	✓	✓	✓
S-VIDEO IN	✓	✓	✓
COMPONENT VIDEO IN	✗	✗	☑

- The ☑ mark above indicates that the component video input must be assigned before it will be output (see *Assigning the component video inputs* on page 76 for more on this).
- When recording video sources however, you won't be able to record sources connected to the component video inputs. With composite and S-video sources, they must be connected using the same type of video cable as you used to connect the recorder to the receiver.
- Also note that this feature is available with NTSC signals only. For a PAL signal, make sure you've used the same type of cable for your video component and monitor connections.



## About cable types

### Analog audio cables

Use stereo RCA phono cables to connect analog audio components. These cables are typically red and white, and you should connect the red plugs to R (right) terminals and white plugs to L (left) terminals.

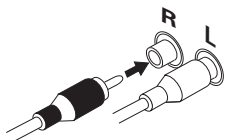

### Digital audio cables

Commercially available coaxial digital audio cables or optical cables should be used to connect digital components to this receiver.



Coaxial digital audio cable

Optical cable

- When connecting optical cables, be careful when inserting the plug not to damage the shutter protecting the optical socket.
- When storing optical cable, coil loosely. The cable may be damaged if bent around sharp corners.
- You can also use a standard RCA video cable for coaxial digital connections.

## Video cables

### Standard RCA video cables

These cables are the most common type of video connection and should be used to connect to the composite video terminals. They have yellow plugs to distinguish them from cables for audio.



### S-video cables

S-video cables give you clearer picture reproduction than regular video cables by sending separate signals for the luminance and color.



### Component video cables

Use component video cables to get the best possible color reproduction of your video source. The color signal of the TV is divided into the luminance (Y) signal and the color (Pb and Pr) signals and then output. In this way, interference between the signals is avoided.

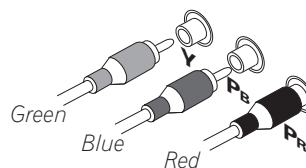

### When making cable connections

Be careful not to arrange cables in a manner that bends the cables over the top or around this unit. If the cables are laid on top of the unit, the magnetic field produced by the transformers in this unit may cause a humming noise to come from the speakers.

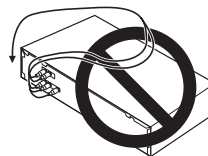

## Connecting your TV

This page shows you how to connect your TV to the receiver. To be able to play the sound from the TV's built-in tuner, connect the analog audio outputs from your TV to this receiver.

If your TV has a built-in digital decoder, you can connect the digital audio output to this receiver to enjoy Dolby Digital and DTS sound from digital TV broadcasts.

### 1 Connect the MONITOR OUT video jack on this receiver to a video input on your TV.

Make sure you don't connect to the **MONITOR OUT** connection for **MULTI ROOM & SOURCE**.

- You can use a standard RCA video cable to connect to the composite video jack, or for higher quality video, you can use an S-video cable to connect to the S-video jack (**S-VIDEO**).
- See *Using the component video jacks* on page 24 if you want to use the component video outputs to connect this receiver to your TV.

- See *About the video converter* on page 16 if you plan on connecting your other video components using different types of video cables than for your TV.

### 2 Connect the analog audio outputs from your TV to the TV/SAT inputs on this receiver.

- Use a stereo RCA phono cable for the connection.

### 3 Connect an optical digital audio output from your TV to the DIGITAL 1 (TV/SAT) input on this receiver.

- Use an optical cable for the connection.
- If your TV only has a coaxial digital output, you can connect it to one of the coaxial inputs on this receiver using a coaxial digital audio cable. When you set up the receiver you'll need to tell the receiver which input you connected the TV to (see *Assigning the digital inputs* on page 75).

#### Note

- If your TV doesn't have a digital audio output, omit step 3 above.

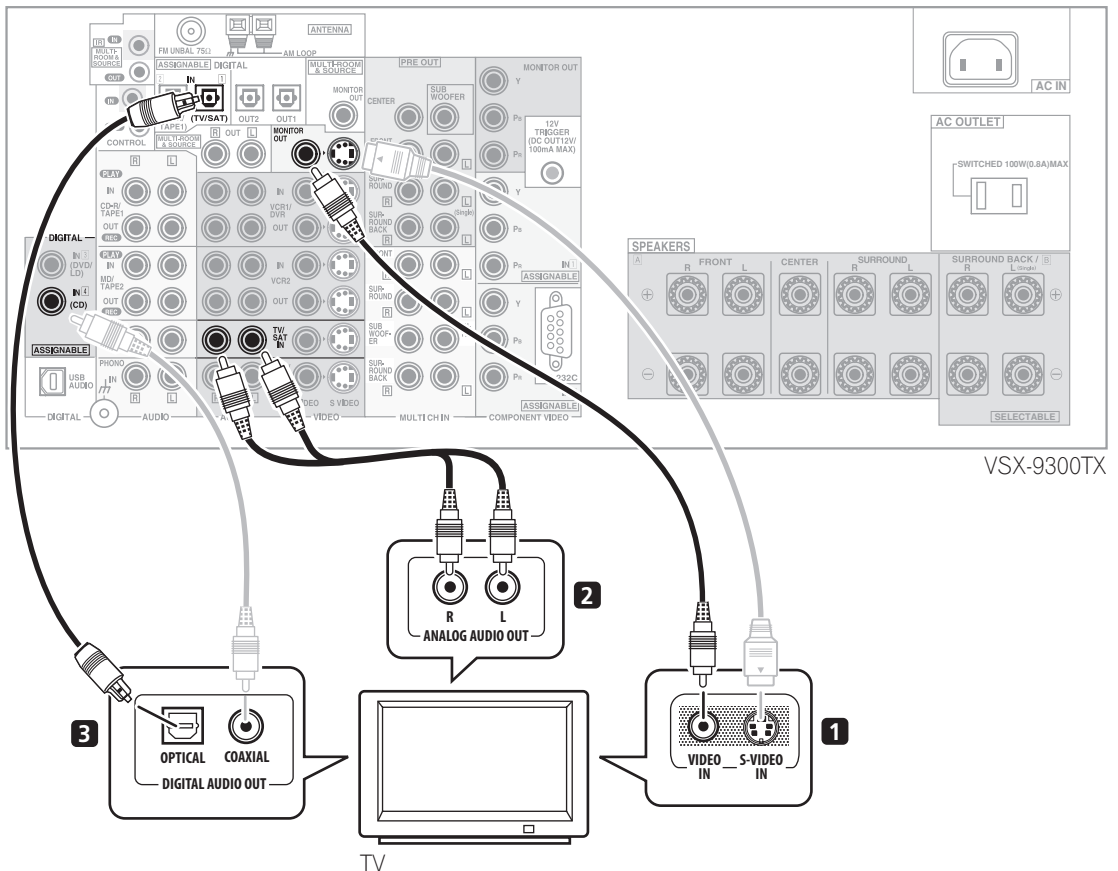

## Connecting a DVD player

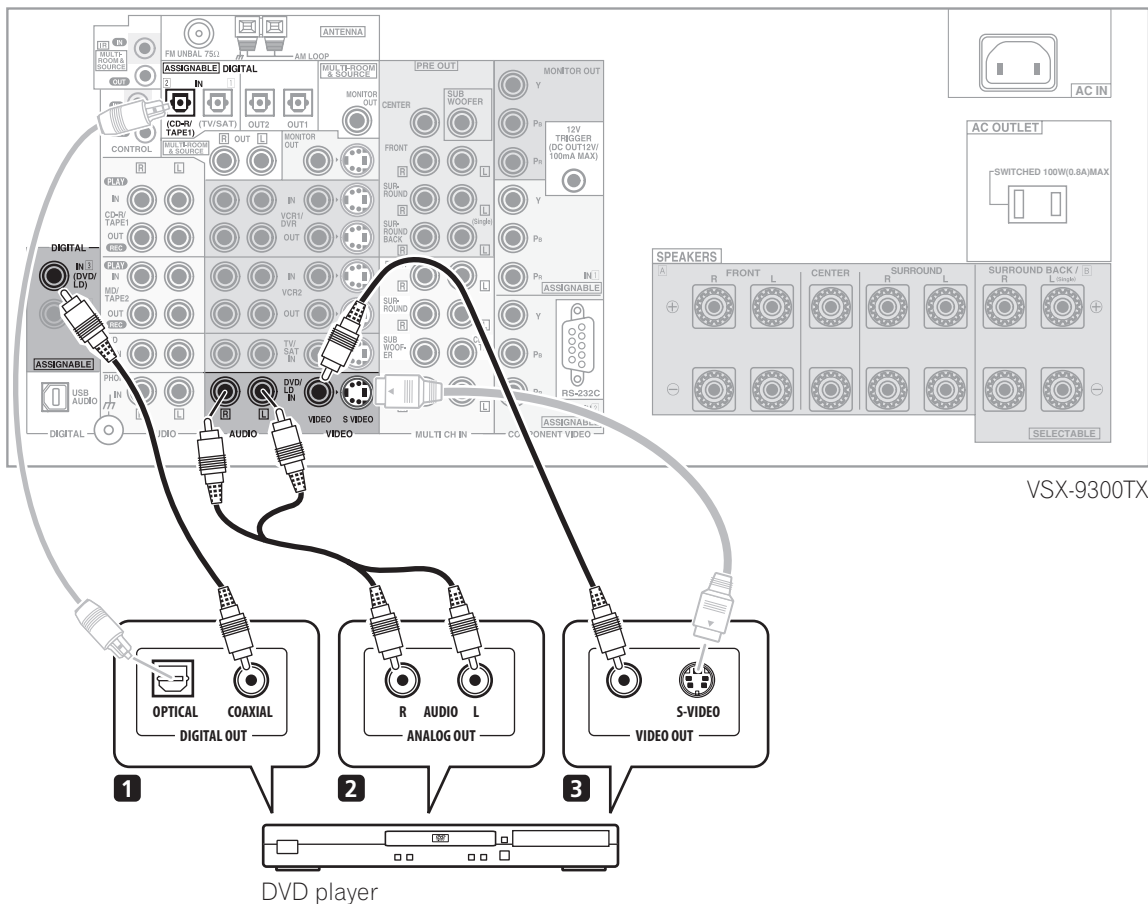

Different DVD players offer a different selection of connections, but all should give you at least a digital audio output, stereo analog audio outputs and a video output. Additionally, you may have a player with multichannel analog audio outputs and different kinds of video outputs to choose from.

**1 Connect a coaxial digital audio output on your DVD player to the DIGITAL 3 (DVD/LD) input on this receiver.**

- Use a coaxial digital audio cable for the connection.
- If your DVD player only has an optical digital output, you can connect it to one of the optical inputs on this receiver using an optical cable. When you set up the receiver you'll need to tell the receiver which input you connected the player to (see *Assigning the digital inputs* on page 75).

**2 If your DVD player only has stereo analog audio outputs, connect these to the DVD/LD AUDIO inputs on this receiver.**

- Use a stereo RCA phono cable for the connection.
- If your DVD player has multichannel analog outputs, see *Connecting the multichannel analog outputs* below for how to connect it.

**3 Connect a composite or S-video output on your DVD player to the DVD/LD VIDEO or DVD/LD S-VIDEO input on this receiver.**

- Use a standard RCA video cable or an S-video cable for the connection.
- See *About the video converter* on page 16 if you plan to use a different type of video cable than you used to connect your TV.
- If your player also has a component video output, you can connect this too. See *Using the component video jacks* on page 24 for more on this.

## Connecting the multichannel analog outputs

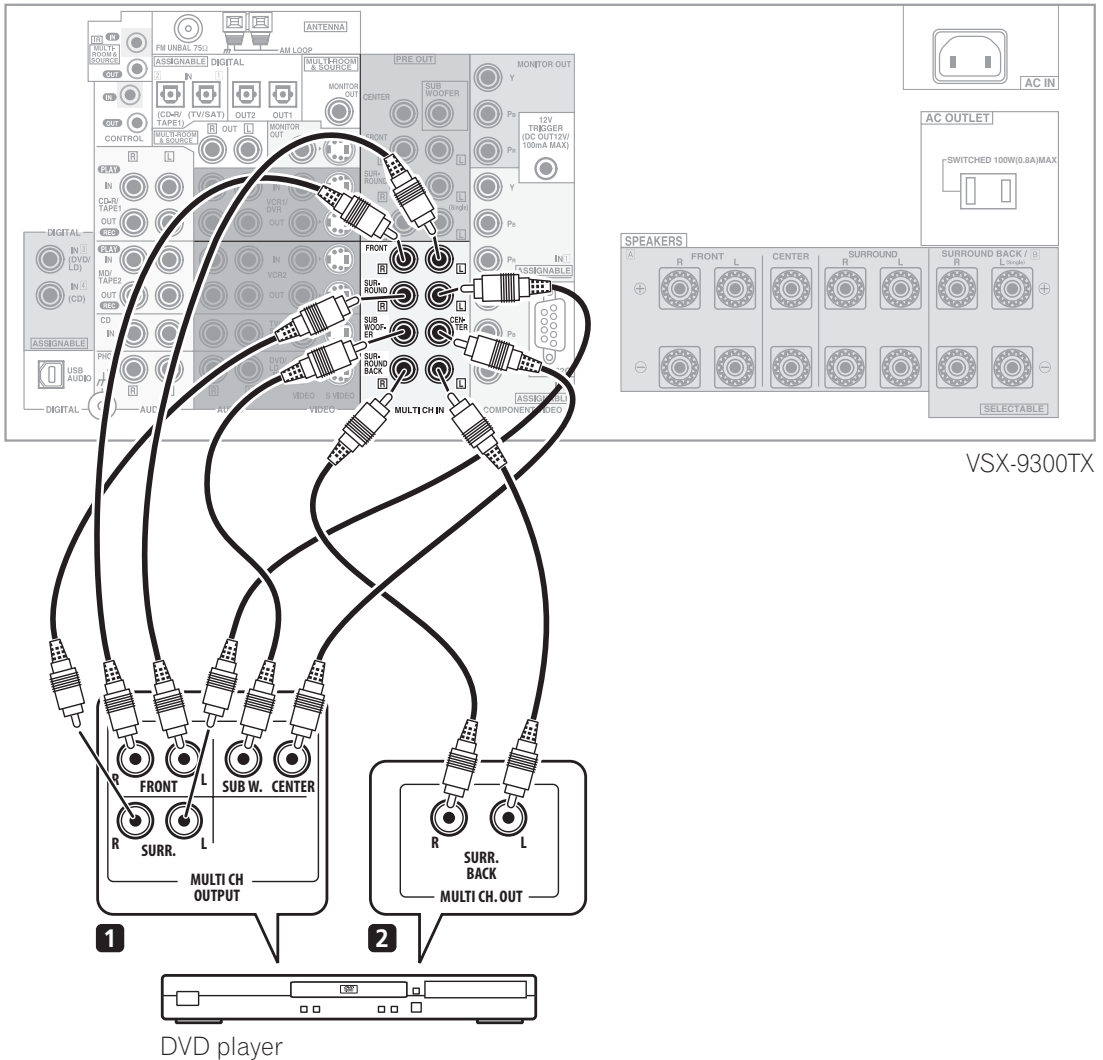

For DVD Audio and SACD playback, your DVD player may have 5.1, 6.1 or 7.1 channel analog outputs (depending on whether your player supports surround back channels).

**1 Connect the front, surround, center and subwoofer outputs on your DVD player to the corresponding MULTI CH IN jack on this receiver.**

- Use standard RCA phono cables for the connections.
- Take care to connect each output to its corresponding input on the receiver.

**2 If your DVD player also has outputs for surround back channels, connect these to the corresponding MULTI CH IN jacks on this receiver.**

- Use standard RCA phono cables for the connections.
- If there is only a single surround back output, be sure to connect it to the **SURROUND BACK L** jack on this receiver.

**Note**

- To listen to multichannel analog audio you'll need to press **MULTI CH INPUT** on the remote (see *Using the multichannel analog inputs* on page 41 for more on this).

## Connecting a satellite/cable receiver or other set-top box

Satellite and cable receivers, and terrestrial digital TV tuners are all examples of so-called 'set-top boxes'.

### 1 Connect a set of audio/video outputs on the set-top box component to the TV/SAT AUDIO and VIDEO inputs on this receiver.

- Use a stereo RCA phono cable for the audio connection and a standard RCA video or S-video cable for the video connection.
- See *About the video converter* on page 16 if you plan to use a different type of video cable than you used to connect your TV.

### 2 Connect an optical digital audio output from your set-top box component to the DIGITAL 1 (TV/SAT) input on this receiver.

- Use an optical cable for the connection.

- If your set-top box only has a coaxial digital output, you can connect it to one of the coaxial inputs on this receiver using a coaxial digital audio cable. When you set up the receiver you'll need to tell the receiver which input you connected the set-top box to (see *Assigning the digital inputs* on page 75).

### Note

- If your satellite/cable receiver doesn't have a digital audio output, omit step 2 above.
- If you've already connected your TV to the TV/SAT inputs above, simply choose another input. However, you'll need to tell the receiver which input you connected the set-top box to (see *Assigning the digital inputs* on page 75).

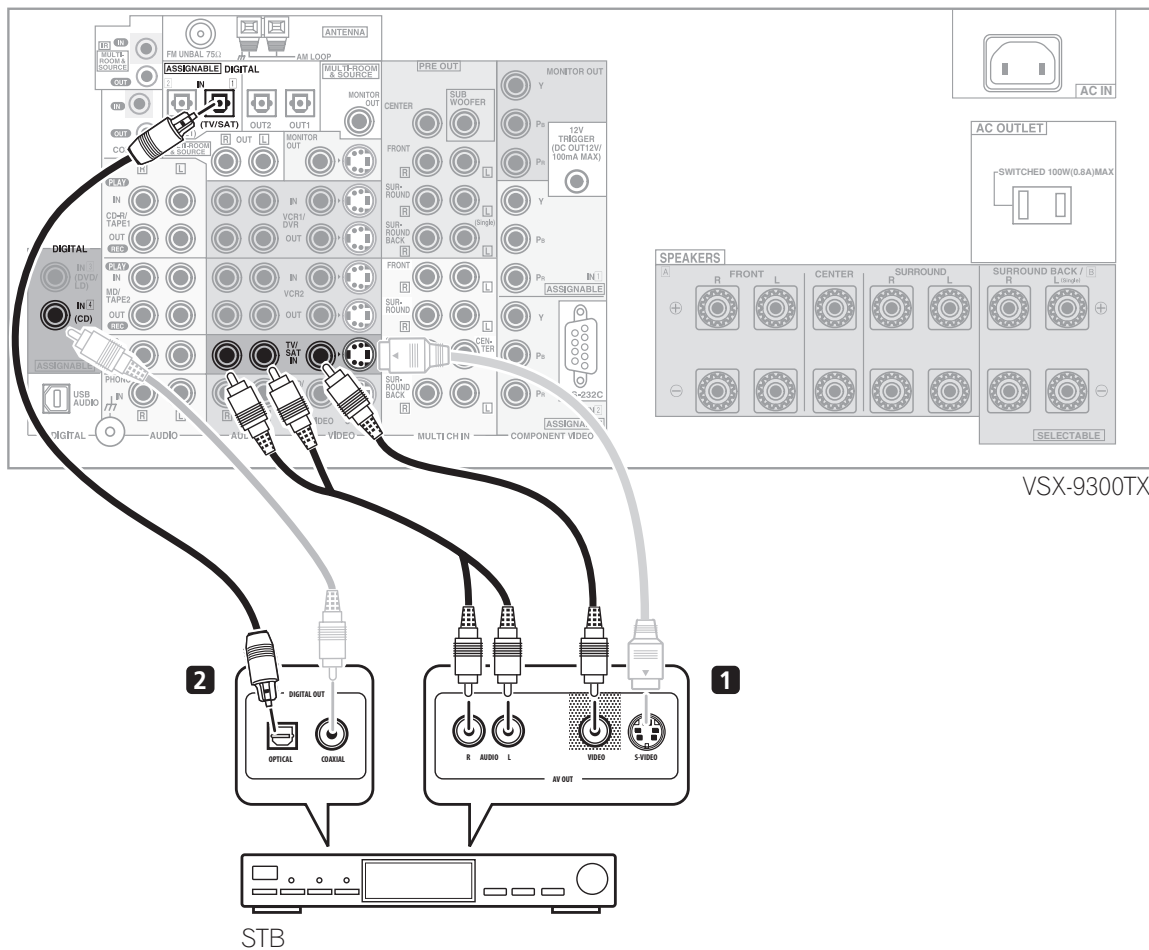

## Connecting a VCR or DVD recorder

This receiver has two sets of audio/video inputs and outputs suitable for connecting analog or digital video recorders, including VCRs, DVD-recorders and HDD recorders.

- See *About the video converter* on page 16 if you plan to use a different type of video cable than you used to connect your TV.

### 1 Connect a set of audio/video outputs on the recorder to the VCR1/DVR AUDIO and VIDEO inputs on this receiver.

- Use a stereo RCA phono cable for the audio connection and a standard RCA video or S-video cable for the video connection.
- For a second recorder, use the **VCR2** inputs.

### 2 Connect a set of audio/video inputs on the recorder to the VCR1/DVR AUDIO and VIDEO outputs on this receiver.

- Use a stereo RCA phono cable for the audio connection and a standard RCA video or S-video cable for the video connection.

- For a second recorder, use the **VCR2** outputs.

### 3 Connect an optical digital audio output from the recorder to a digital input on this receiver.

The example illustration below shows a recorder connected to the optical **DIGITAL 2 (CD-R/TAPE1)** input. When you set up the receiver you'll need to tell the receiver which input you connected the recorder to (see *Assigning the digital inputs* on page 75).

- Use a coaxial digital audio cable or an optical cable for the connection depending on the type of input you used.
- The digital outputs from another recorder can be connected to any spare digital audio input on this receiver. You can assign it when setting up the receiver (see *Assigning the digital inputs* on page 75).

#### Note

- If your video component doesn't have a digital audio output, omit step **3** above.

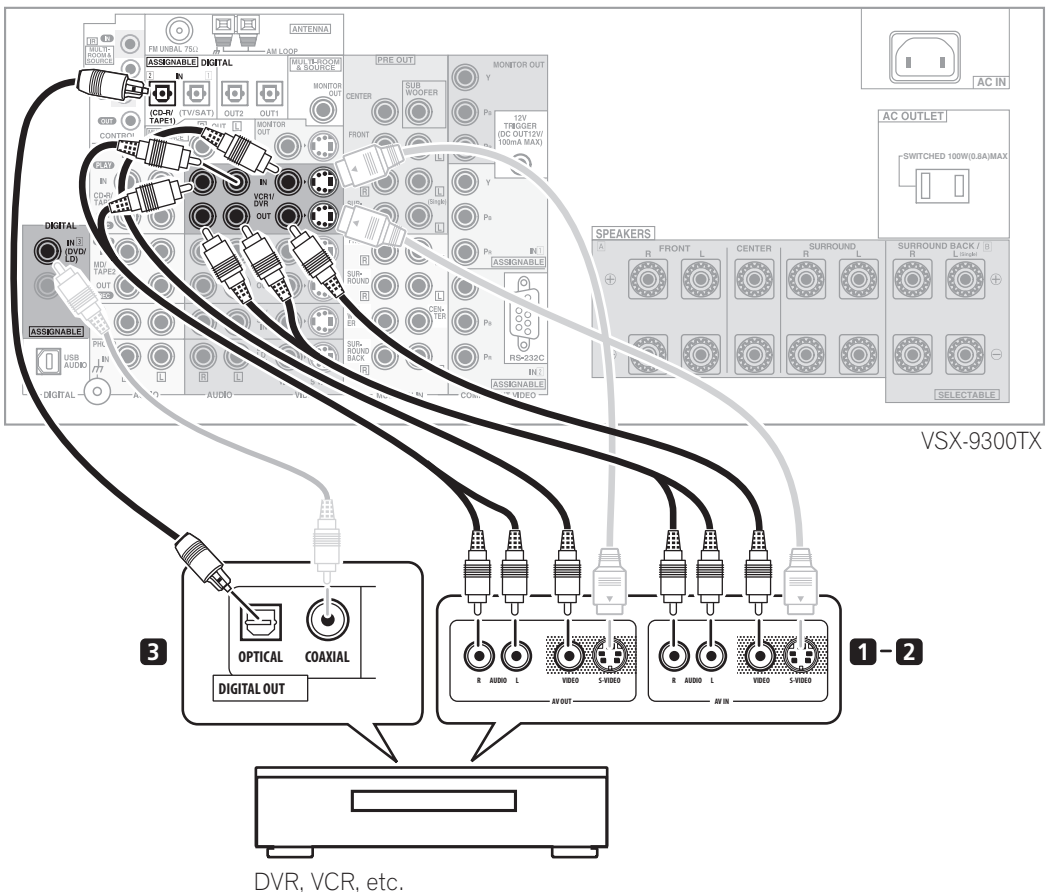

## Connecting other video sources

You can basically use any of the audio/video inputs on this receiver for any kind of video source. The example illustration below shows a component connected to the VCR2 inputs.

### 1 Connect the analog audio outputs and a video output of the source component to a set of spare audio/video inputs on this receiver.

- Use a stereo RCA phono cable for the audio connection and a standard RCA video or S-video cable for the video connection.

- See *About the video converter* on page 16 if you plan to use a different type of video cable than you used to connect your TV.

### 2 If the source component has a digital audio output, connect it to a spare digital audio input on this receiver.

- Use a coaxial digital audio cable or an optical cable for the connection depending on the type of input you used.
- You may need to assign the digital input you used when setting up the receiver (see *Assigning the digital inputs* on page 75).

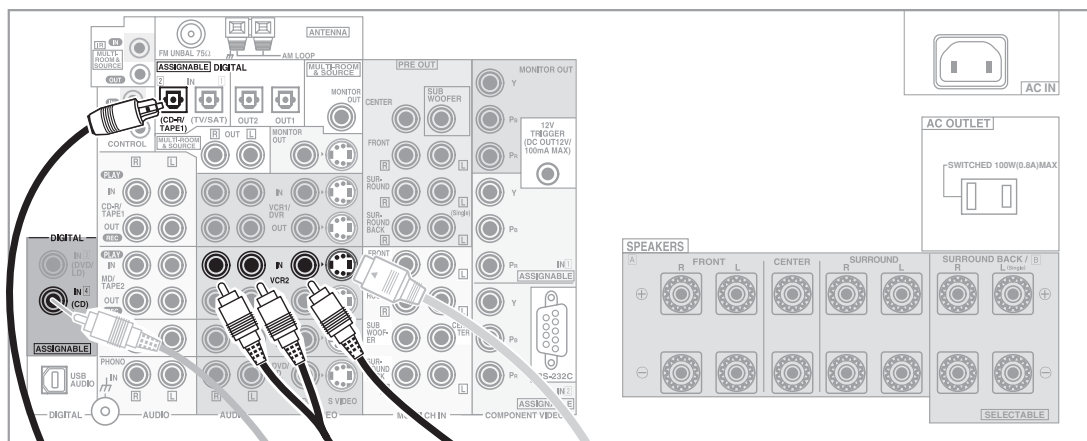

VSX-9300TX

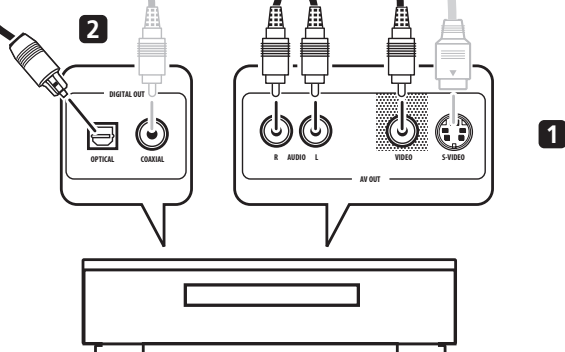

LD player, video player, TV game, etc.



## Using the component video jacks

Component video should deliver superior picture quality when compared to composite or S-video. A further advantage (if your source and TV are both compatible) is progressive-scan video, which delivers a very stable, flicker-free picture. See the manuals that came with your TV and source component to check whether they are compatible with progressive-scan video.

### Important

- If you connect any source component to the receiver using a component video input, you should also have your TV connected to this receiver's component video **MONITOR** output.

### 1 Connect the component video outputs of your source to a set of component video inputs on this receiver.

Use a three-way component video cable for the connection.

### 2 Assign the component video inputs to the input source you've connected.

This must be done so that they can be used in conjunction with the audio/video input(s) to which you have connected the component above (see *Assigning the component video inputs* on page 78 for more on this).

### 3 Connect the COMPONENT VIDEO MONITOR OUT jacks on this receiver to the component video inputs on your TV or monitor.

- Use a three-way component video cable.

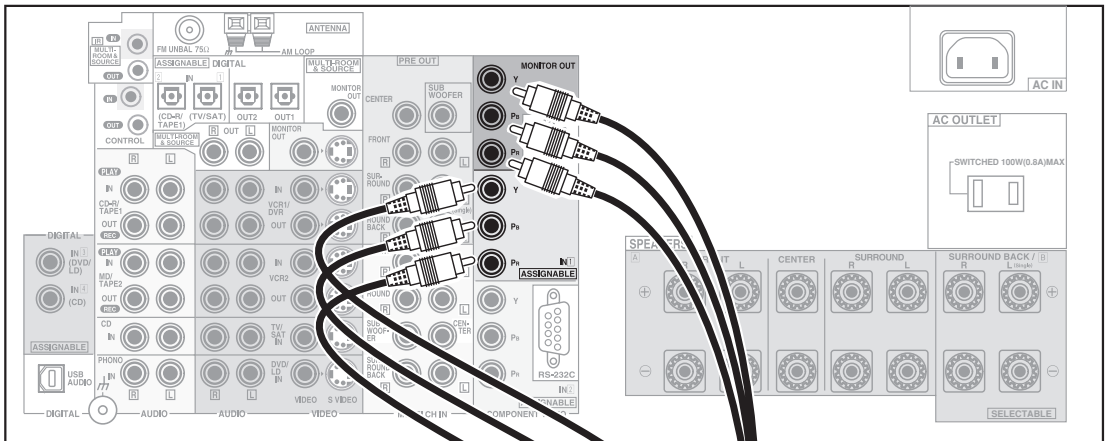

VSX-9300TX

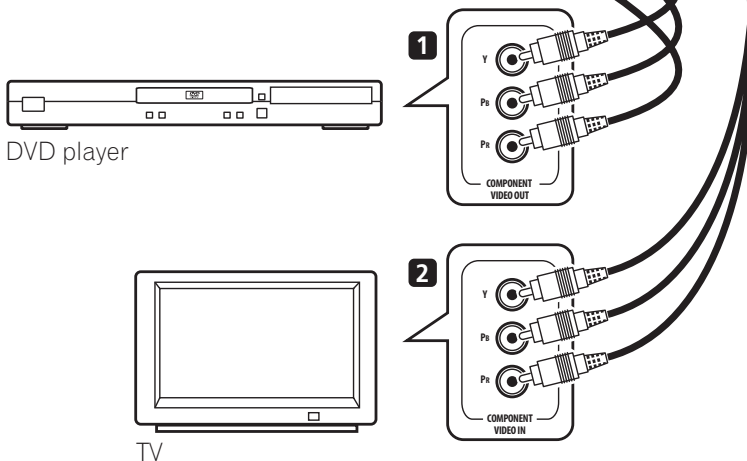



## Connecting digital audio sources

This receiver has both digital inputs and outputs, allowing you to connect digital components for playback and for making digital recordings. Many digital components also have analog connections for recording analog sources (such as a turntable or tape deck). See *Connecting analog audio sources* below for more on this.

### 1 Connect a coaxial digital output on your digital component to the DIGITAL 4 (CD) input on this receiver.

- Use a coaxial digital audio cable for the connection.
- If your digital component only has an optical digital output, you can connect it to one of the optical inputs on this receiver using an optical cable. When you set up the receiver you'll need to tell the receiver which input you connected the player to (see *Assigning the digital inputs* on page 75).

- The digital outputs from other components can be connected to any spare digital audio inputs on this receiver. You can assign them when setting up the receiver (see *Assigning the digital inputs* on page 75).

### 2 Connect one of the DIGITAL outputs on this receiver to a digital input on the component.

- Use an optical cable to connect to the **DIGITAL OUT1** or **OUT2** (**OUT2** is shown in the illustration below).

#### Note

- In order to record some digital sources, you must make analog connections as explained in *Connecting analog audio sources* below.

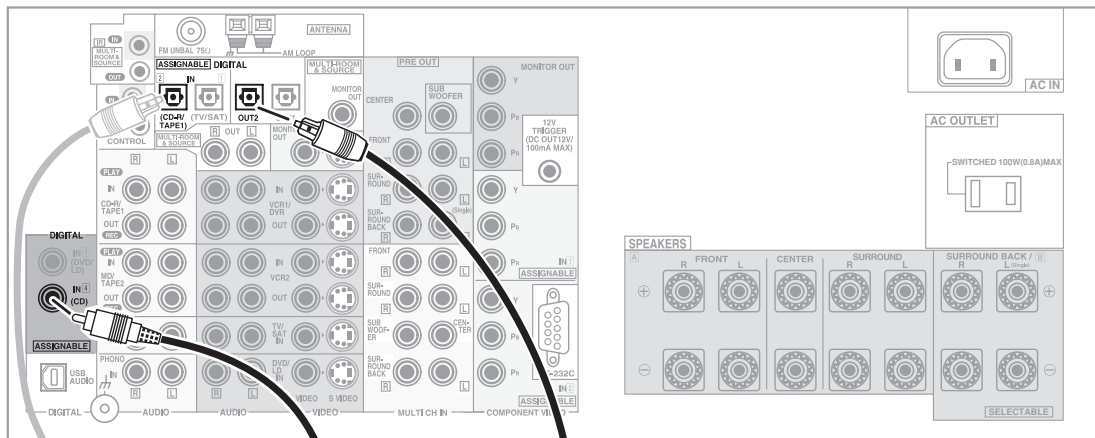

VSX-9300TX

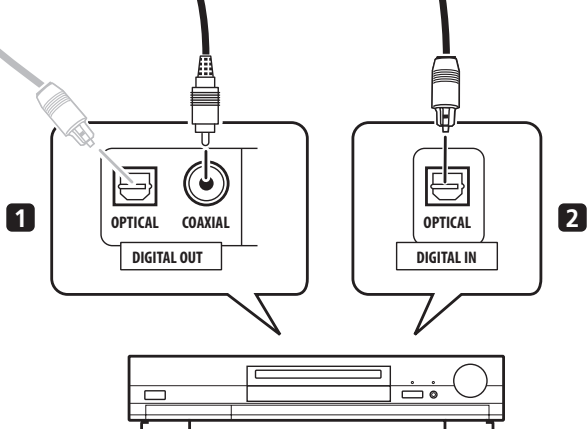

CD-R, MD, DAT, etc.



## Connecting a component to the front panel inputs

The front panel inputs include a composite video jack (**VIDEO**), an S-video jack (**S-VIDEO**), stereo analog audio inputs (**AUDIO L/R**) and an optical digital audio input (**DIGITAL**). You can use these connections for any kind of audio/video component, but they are especially convenient for portable equipment such as camcorders, video games and portable audio/video equipment.

- The input signals can be accessed by selecting **VIDEO** as the input source.
- Pull down the front cover where indicated to access the front panel inputs.
- The illustration below shows example connections to a portable DVD player. Note that you may need a specialized optical cable for this connection.

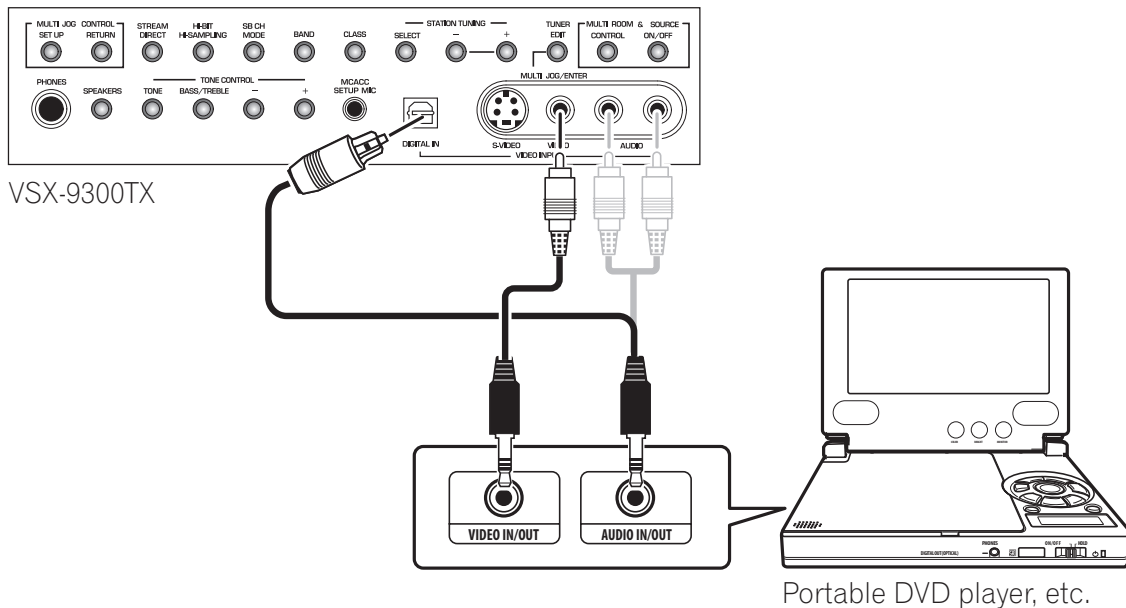

## Installing your speaker system

To take full advantage of the receiver's surround sound capabilities connect front, center, surround and surround back speakers, as well as a subwoofer. Although this is ideal, other configurations with fewer speakers—no subwoofer or no center speaker, or even no surround speakers—will work. At the very least, front left and right speakers only are necessary. Note that your

main surround speakers should always be connected as a pair, but you can connect just one surround back speaker if you like (it must be connected to the left surround back terminal). You can use speakers with a nominal impedance between 6–16Ω (please see *Switching the speaker impedance* on page 64 if you plan to use speakers with an impedance of less than 8Ω).

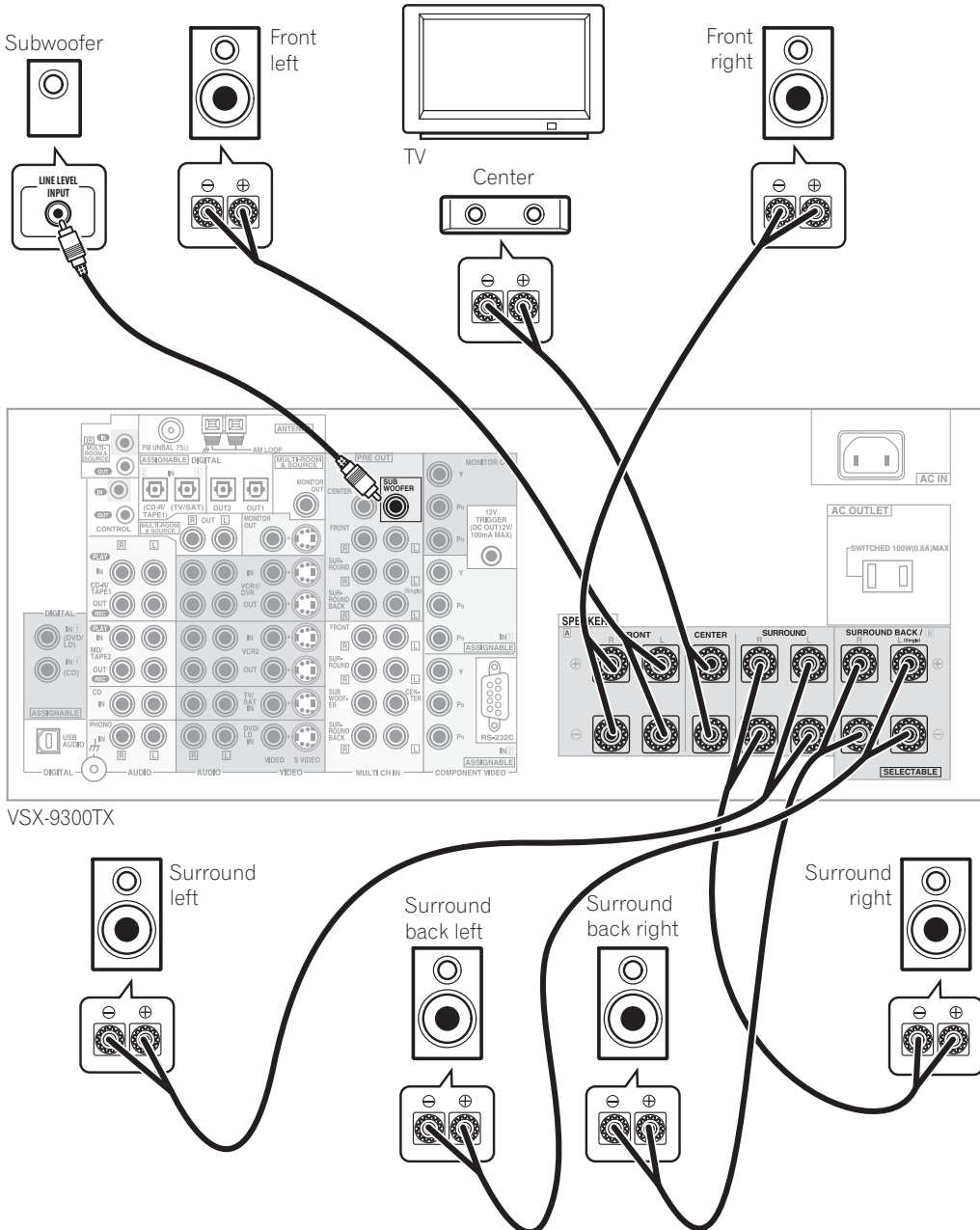

## Connecting the speakers

Each speaker connection on the receiver comprises a positive (+) red, and negative (-) black terminal. For proper sound you should take care to match these up with the terminals on the speakers themselves.

- If you only have one surround back speaker, hook it up to the surround back left (**Single**) terminal.

### Caution

- Make sure that all the bare speaker wire is twisted together and inserted fully into the speaker terminal. If any of the bare speaker wire touches the back panel it may cause the power to cut off as a safety measure.

## Bare wire connections

Before you start connecting the speakers, make sure that the speaker cable you're going to use is properly prepared with about 3/8 in. (10 mm) of insulator stripped from each wire, and the exposed wire strands twisted together (*fig. A*).

To connect a terminal, unscrew the terminal a few turns until there is enough space to insert the exposed wire (*fig. B*). Once the wire is in position, tighten the terminal until the wire is firmly clamped (*fig. C*).

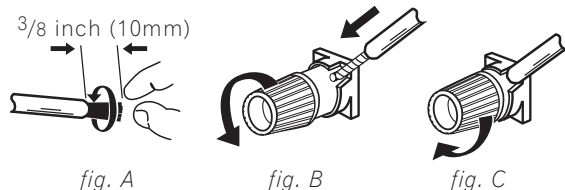

## Banana plug connections

If you want to use speaker cables terminated with banana plugs, screw the speaker terminal fully shut then plug the banana plug into the end of the speaker terminal.

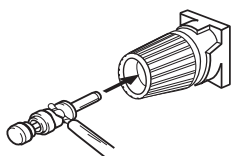

### Note

- Please refer to the manual that came with your speakers for details on how to connect the other end of the speaker cables to your speakers.
- If you are using a THX certified subwoofer use the **THX INPUT** jack on the subwoofer (if your subwoofer has one) or switch the filter position to **THX** on your subwoofer.

- The surround speaker terminals on this receiver can be connected in a number of ways, depending on your setup. See *Surround back speaker setting* on page 51 for an overview of the possible configurations.
- *Other connections* on page 67 provides greater detail on alternate speaker setups such as using speaker system B (page 67), bi-amping (page 68) and bi-wiring (page 68).

## Placing the speakers

Where you put your speakers in the room has a big effect on the quality of the sound. The following guidelines should help you to get the best sound from your system.

- The subwoofer can be placed on the floor. Ideally, the other speakers should be at about ear-level when you're listening to them. Putting the speakers on the floor (except the subwoofer), or mounting them very high on a wall is not recommended.
- For the best stereo effect, place the front speakers 6–9 ft. apart, at equal distance from the TV.
- Install the center speaker above or below the TV so that the sound of the center channel is localized at the TV screen.
- When placing speakers near the TV, use magnetically shielded speakers to prevent possible interference, such as discoloration of the picture when the TV is switched on. If you do not have magnetically shielded speakers and notice discoloration of the TV picture, move the speakers farther away from the TV.
- If possible, install the surround speakers slightly above ear level.
- If you have two surround back speakers THX recommends placing them together and the same distance from your listening position.

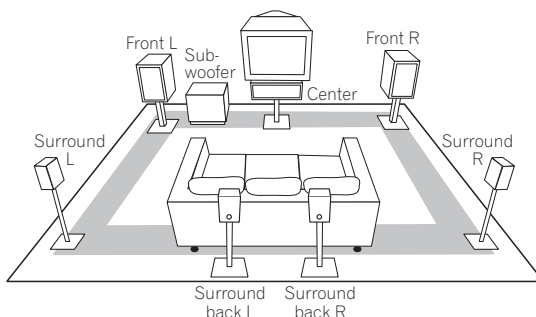

### Caution

- Make sure that all speakers are securely installed. This not only improves sound quality, but also reduces the risk of damage or injury resulting from speakers being knocked over or falling in the event of external shocks such as earthquakes.

## Connecting antennas

The supplied antennas provide a simple way to listen to AM and FM radio. If you find that reception quality is poor, an outdoor antenna should give you better sound quality—see *Connecting external antennas* below.

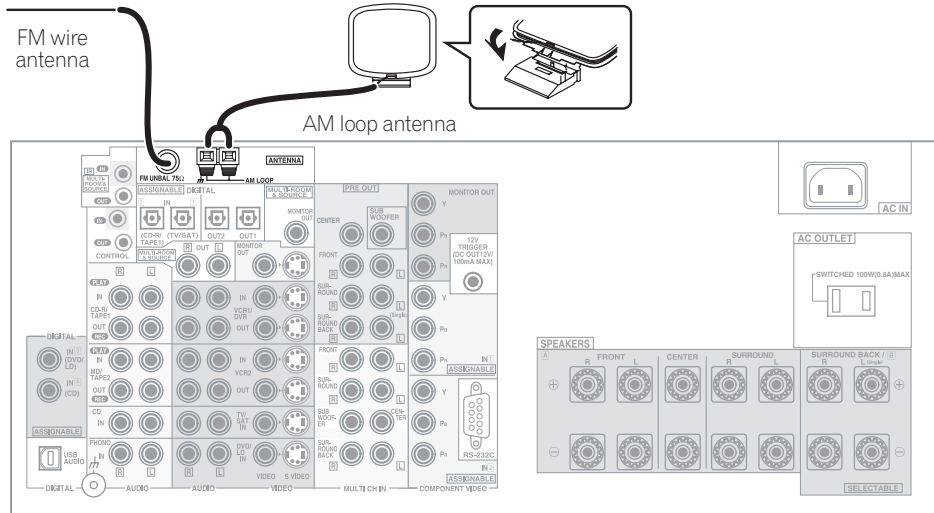

VSX-9300TX

### AM loop antenna

#### 1 Assemble the stand as shown in the illustration.

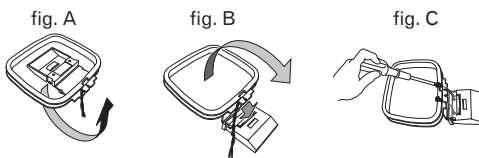

- Bend the stand in the direction indicated (fig. A).
- Clip the loop into the stand (fig. B).
- It's possible to fix the AM antenna to a wall (fig. C). Before fixing, make sure that the reception is satisfactory.

#### 2 Pull off the protective shields of both AM antenna wires.

#### 3 Press the AM LOOP antenna terminal tabs to open and insert one wire into each terminal.

#### 4 Release the tabs to secure the AM antenna wires.

#### 5 Place the AM antenna on a flat surface and point in the direction giving the best reception.

Avoid placing near computers, television sets or other electrical appliances and do not let it come into contact with metal objects.

### Note

- The signal ground (⏏) is designed to reduce noise that occurs when an antenna is connected. It is not an electrical safety ground.

### FM wire antenna

- **Connect the FM wire antenna to the FM UNBAL 75Ω terminal.**

For best results, extend the FM antenna fully and fix to a wall or door frame. Don't drape loosely or leave coiled up.

### Connecting external antennas

To improve FM reception connect an external FM antenna to the **FM UNBAL 75Ω**.

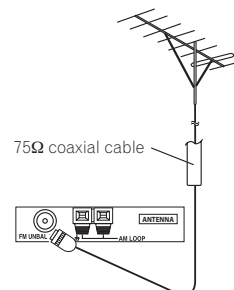

To improve AM reception, connect a 15–18 ft. length of vinyl-coated wire to the **AM LOOP** terminals without disconnecting the supplied AM loop antenna.

For the best possible reception, suspend horizontally outdoors.

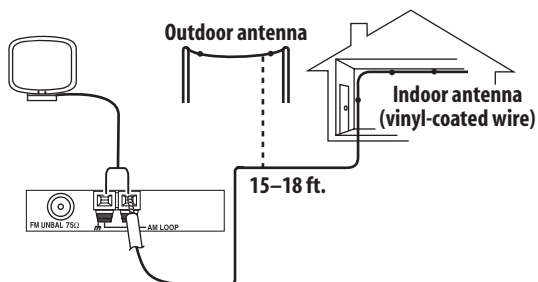

### About the AC outlet

(Switched 100W max.)

Power supplied through this outlet is turned on and off by the receiver's **STANDBY/ON** switch. Total electrical power consumption of connected equipment *should not exceed 100 W (0.8 A)*.

#### ⚠ Caution

- Do not connect a TV set, monitor, heater, or similar appliance to this unit's AC outlet.
- Do not connect appliances with high power consumption to the AC outlet in order to avoid overheating and fire risk. This can also cause the receiver to malfunction.
- Since a subwoofer can exceed the 100W maximum when playing sources at a high volume, it is best not to connect a subwoofer to the AC outlet.

### Plugging in the receiver

Only plug in after you have connected all your components to this receiver, including the speakers.

#### ⚠ Caution

- Handle the power cord by the plug part. Do not pull out the plug by tugging the cord, and never touch the power cord when your hands are wet, as this could cause a short circuit or electric shock. Do not place the unit, a piece of furniture, or other object on the power cord or pinch the cord in any other way. Never make a knot in the cord or tie it with other cables. The power cords should be routed so that they are not likely to be stepped on. A damaged power cord can cause a fire or give you an electric shock. Check the power cord once in a while. If you find it damaged, ask your nearest Pioneer authorized independent service company for a replacement.
- Do not use any power cord other than the one supplied with this unit.
- Do not use the supplied power cord for any purpose other than that described below.
- The receiver should be disconnected by removing the mains plug from the wall socket when not in regular use (for example, when on vacation).

**1 Plug the supplied power cord into the AC IN socket on the back of the receiver.**

**2 Plug the other end into a power outlet.**

## Chapter 4

## Controls and displays

## Front panel

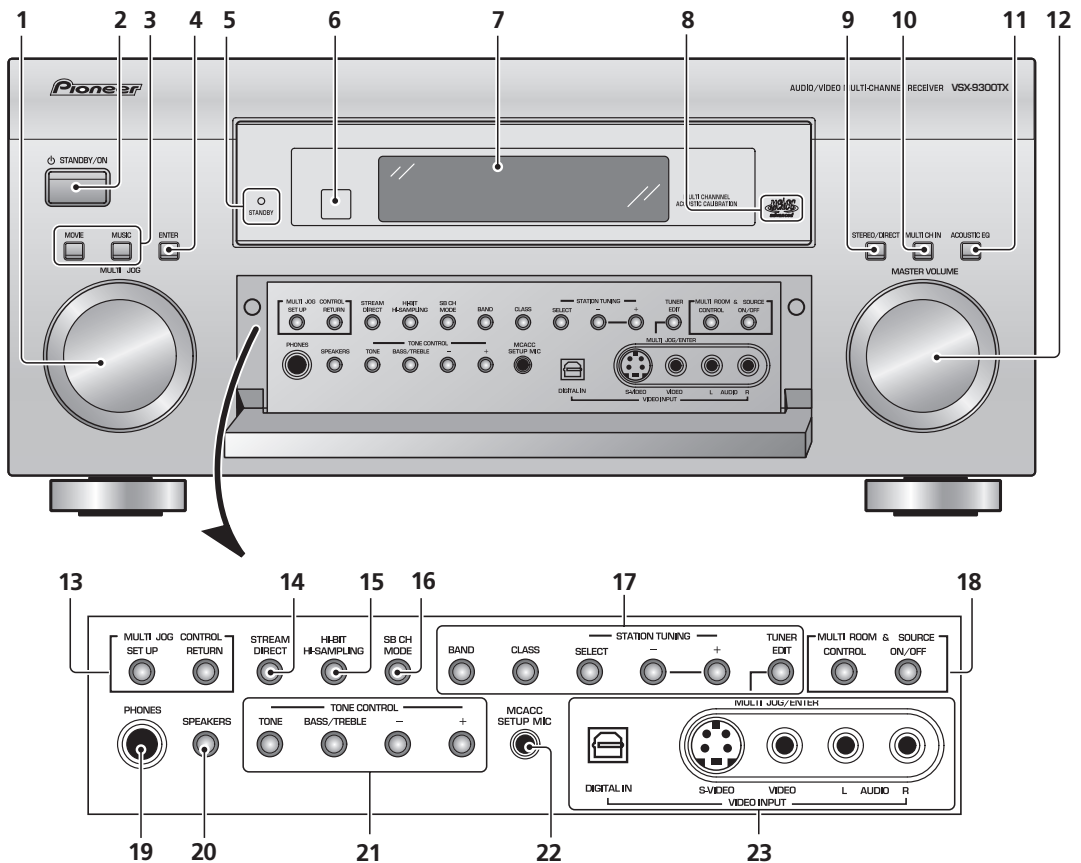
**1 MULTI JOG dial**

Depending on the operation, you can use this to select an input source or listening mode, as well as for tuner and system settings. It can often be used instead of the remote control ▲/▼ (cursor up/down) buttons.

**2  STANDBY/ON**

Press  **STANDBY/ON** to switch the receiver on or into standby.

**3 Surround listening mode buttons** (page 37)

Use to select the **MOVIE** and **MUSIC** surround listening modes.

**4 ENTER**

Use to confirm your selection (with the **MULTI JOG** dial).

**5 STANDBY indicator**

Lights when the receiver is in standby.

**6 Remote sensor**

Receives the signals from the remote control.

**7 Display**

See *Display* on page 34.

**8 Advanced MCACC indicator** (page 41)

Lights when Acoustic Calibration EQ is on (Acoustic Calibration EQ is automatically set to **ALL CH ADJUST** after the Auto Surround Setup has been completed).

**9 STEREO/DIRECT** (page 40)

Switches the receiver into **STEREO** mode if it was in a different listening mode or toggles between **DIRECT** and **STEREO**.



## 10 MULTI CH IN (page 41)

Press to select the component connected to the **MULTI CH IN** terminals (for example, a DVD-Audio player).

## 11 ACOUSTIC EQ (page 41)

Press to select an acoustic calibration EQ setting.

## 12 MASTER VOLUME dial

Adjusts the volume.

## 13 MULTI JOG CONTROL

Use the **SET UP** button to access the System Setup menu, and **RETURN** to exit the current menu screen.

## 14 STREAM DIRECT (page 37)

Press to switch on/off Auto playback.

## 15 HI-BIT/HI-SAMPLING (page 44)

Use this to switch the audio scaler on or off.

## 16 SB CH MODE (page 43)

Use to select the surround/virtual back channel mode.

## 17 TUNER controls (page 47)

Use the front panel tuner controls for tuning into stations and recalling station presets.

### BAND

Press to select the AM or FM band.

### CLASS

Press repeatedly to switch the preset station classes.

### SELECT

Switches between the station memory and frequency select mode when using the **-/+** buttons.

### - /+

Selects station memories or frequencies when using the tuner.

### TUNER EDIT

Press to memorize and name a station for recall with the **MULTI JOG** dial.

## 18 MULTI ROOM & SOURCE controls

If you've made multi-room connections (see *Multi-room listening* on page 69) use these controls to control the sub room from the main room (see *Using the multi-room controls* on page 70).

### CONTROL

Use together with the **MULTI JOG** dial to select the function or use with the **MASTER VOLUME** to select the volume of the sub room.

### ON/OFF

Use to switch the multi-room feature on or off.

## 19 PHONES jack (page 40)

Use to connect headphones (no sound will be heard through the speakers).

## 20 SPEAKERS (page 67)

Depending on the surround back speaker setting (page 51), press either to switch the speaker system or simply to switch it off (See *Switching the speaker system* on page 67 for more on this).

## 21 TONE CONTROL (page 45)

### tone

Press to switch the tone controls on or off (bypass).

### BASS/TREBLE

Use to select whether the bass or treble will be adjusted.

### +/-

Use to adjust the frequency setting.

## 22 MCACC SETUP MIC jack

Use to connect the supplied microphone.

## 23 VIDEO INPUT jacks (page 27)

- **DIGITAL IN** – Connect a game console, portable DVD player, video camera (etc.), that has an optical digital connection.
- **S-VIDEO** – Connect a video camera (etc.), that has an S-video out.
- **VIDEO / AUDIO (L/R)** – Connect a video camera, etc. that has standard RCA video/audio outputs.

## Display

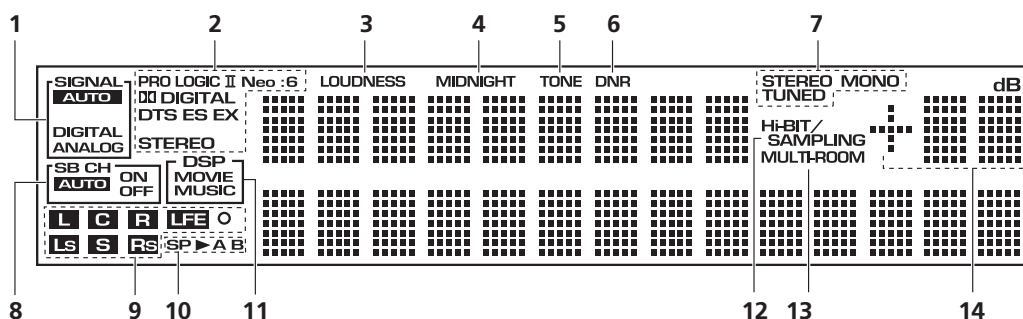

### 1 SIGNAL indicators (page 42)

Light to indicate the currently selected input signal.

**AUTO** lights when the receiver is set to select the input signal automatically.

### 2 Digital format indicators

- **PRO LOGIC II** – Lights during Dolby Pro Logic II and Pro Logic IIx processing.
- **Neo:6** – Lights during Neo:6 processing with 2-channel sources.
- **DIGITAL** – Lights when a Dolby Digital signal is detected.
- **DTS** – Lights when a DTS signal is detected.
- **ES** – Lights when a DTS-ES signal is detected.
- **EX** – Lights when a Dolby Digital EX signal is detected.
- **STEREO** – Lights during 2-channel playback.

### 3 LOUDNESS (page 45)

Lights when Loudness listening is active.

### 4 MIDNIGHT (page 45)

Lights when Midnight listening is active.

### 5 TONE (page 45)

Lights when the tone control is switched on.

### 6 DNR (page 46)

Lights when digital noise reduction is switched on.

### 7 Tuner indicators

#### STEREO (page 47)

Lights when listening to a stereo FM broadcast in auto/stereo mode.

#### MONO (page 48)

Lights when the tuner MPX mode is set to mono.

#### TUNED

Lights when tuned to a broadcast.

### 8 SB CH (page 43)

Indicates the surround back channel (or Virtual Surround Back) setting (**AUTO**, **ON** or **OFF**).

### 9 Program format indicators

These change according to which channels are active in Dolby, DTS, DVD-A and SACD sources.

**LS**, **S** and **RS** will light at the same time to indicate 6.1 channel sources.

- **L** – Left front channel
- **C** – Center channel
- **R** – Right front channel
- **LS** – Left surround channel
- **S** – Surround channel (mono) or surround back channel
- **RS** – Right surround channel
- **LFE** – Low frequency effects channel
- **O** – Lights when an LFE signal is detected

### 10 Speaker indicators (page 67)

Lights to indicate the current speaker system, **A** and/or **B**.

### 11 Listening mode indicators (page 37)

Shows **MOVIE** or **MUSIC** when a surround listening mode is selected. **DSP** will light with a box around it when one of the advanced (DSP) listening modes is selected.

### 12 Hi-BIT/SAMPLING (page 44)

Lights when the audio scaler is switched on.

### 13 MULTI-ROOM (page 69)

Lights when the multi room feature is active.

### 14 Volume level indicator

## Remote control

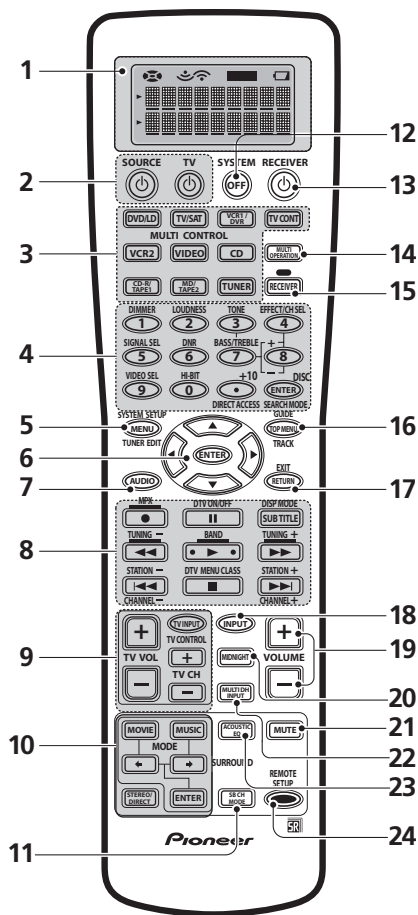

### 1 Remote Control Display Screen

### 2 SOURCE $\square$

Use this button to turn on/off other components. You must input the component preset code in order to do this (see *Using the remote control with other components* on page 54).

### TV $\square$

This is a dedicated TV button. Use it to turn on/off your TV.

### 3 MULTI CONTROL buttons

These buttons are the basic controls that switch the mode of the receiver and the remote control, which allows you to control your other components.

#### TV CONT

Press so that the remote control can operate the TV control commands.

### 4 Number buttons

The operation of these buttons depends on whether the remote control has been set to the **RECEIVER** or **MULTI CONTROL** setting (see *Controlling other equipment* on page 54 for more on this). When **RECEIVER** is selected, you'll be able to select the following:

#### DIMMER (page 63)

Use to adjust the brightness of the front panel display.

#### LOUDNESS (page 45)

Press to switch Loudness on/off.

#### TONE (page 45)

Press to switch the tone controls on or off (bypass).

#### BASS/TREBLE (page 45)

Use to select whether the bass or treble will be adjusted.

#### +/-

Use to adjust the sound delay, the tone, effect and channel levels, as well as to change Dolby Pro Logic II / Dolby Pro Logic IIx Music parameter settings.

#### EFFECT/CH SEL

Press repeatedly to select a channel, then use **-/+** to adjust the level (see *Tip* on page 53). Also selects the **EFFECT** mode, Dolby Pro Logic II / Dolby Pro Logic IIx Music parameters (see page 39) and the sound delay setting (see page 62). You can then use the **+** and **-** buttons to make these adjustments.

#### SIGNAL SEL (page 42)

Press repeatedly to select one of the following:

- **AUTO**

If there are analog and digital signals input, the receiver automatically selects the digital signal.

- **DIGITAL**

Selects an optical or coaxial digital signal.

- **ANALOG**

Selects an analog signal.

#### DNR

Press to switch digital noise reduction on/off (see *Reducing noise during playback* on page 46).

#### VIDEO SEL (page 63)

Press repeatedly to select the video source.

#### HI-BIT (page 44)

Use this to switch the audio scaler on or off.

### 5 SYSTEM SETUP

Use to display the System Setup menu (page 74). Also used to display a menu when controlling other components (such as a DVD player or TV), or as the **TUNER EDIT** button when using the tuner.

**6 ▲/▼/◀/▶/ENTER buttons**

Use to navigate menus and select options/execute commands.

**7 AUDIO**

Use to switch the audio tracks of a DVD when a DVD player is selected as the input source.

**8 Command buttons for other components**

Use these buttons to control the component you selected with the **MULTI CONTROL** buttons. They are available once you've programmed the remote to control the appropriate component (for example, your TV or DVD player). See *Controlling other equipment* on page 54 for more on this.

**9 TV CONTROL buttons**

These are dedicated buttons used to control your TV once you've programmed your TV preset code (see *Controlling other equipment* on page 54 for more on this).

**TV INPUT**

Press to select the input source for the TV.

**TV CH +/-**

Use these buttons to change the channel of the TV.

**TV VOL +/-**

Press to control the volume of the TV.

**10 Listening mode buttons** (page 37)**MOVIE / MUSIC**

Press to select the surround listening mode you want (see *Listening in surround sound* on page 37).



After selecting a **MOVIE** or **MUSIC** listening mode above, use these to select the options available.

**ENTER**

Use to confirm your selection.

**STEREO/DIRECT** (page 40)

Switches the receiver into **STEREO** mode if it was in a different listening mode or toggles between **DIRECT** and **STEREO**.

**11 SB CH MODE** (page 43)

Use to select the surround/virtual back channel mode.

**12 SYSTEM OFF** (page 59)

Press to switch off all Pioneer components in your system, or any other component you have also programmed to switch off using the System Off function.

**13 ⏻ RECEIVER (STANDBY/ON)**

Press to switch the receiver on or into standby.

**14 MULTI OPERATION** (page 59)

Use this button to perform multi operations.

**15 RECEIVER**

Press this button to access receiver functions or when setting up the receiver.

**16 TOP MENU/GUIDE**

Use to display the disc 'top menu' when a DVD player is selected as the input source. Also use to find stations or menus on a digital TV tuner.

**17 RETURN**

When you are setting up the receiver, this button will take you back one step. When another component is selected (such as a DVD player, cable tuner, satellite tuner or digital TV tuner), use it the same way as the components 'Return' button (it may also exit from the menu screen, depending on the maker of the unit).

**18 INPUT**

Press to select an input source. The button will cycle through all the possible input sources (such as **DVD/LD**, **USB** and **PHONO**).

**19 VOLUME (+/-)**

Use to increase or decrease the volume of the receiver.

**20 MIDNIGHT** (page 45)

Press to switch on/off Midnight listening.

**21 MUTE**

Press to mute or restore the volume.

**22 MULTI CH INPUT** (page 41)

Press to select the component connected to the **MULTI CH IN** terminals (for example, a DVD-Audio player).

**23 ACOUSTIC EQ** (page 41)

Press to select an acoustic calibration EQ setting.

**24 REMOTE SETUP**

Use to customize remote control functions and the remote control display (see *Controlling other equipment* on page 54 for more on this).

## Chapter 5

## Listening to your system

## Auto playback

- Default setting: **On**

There are many ways to listen back to sources using this receiver, but for the simplest, most direct listening option is the Stream Direct feature. With this, the receiver automatically detects what kind of source you're playing and selects multichannel or stereo playback as necessary.

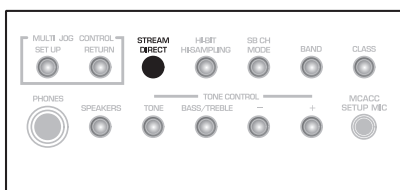

- **While listening to a source, press STREAM DIRECT on the front panel to switch it on or off.**

The decoding or playback format shows briefly in the display before showing **STREAM DIRECT**. Check the digital format indicators in the front panel display to see how the source is being processed.

### Note

- Stereo surround (matrix) formats are decoded accordingly using **NEO:6 CINEMA** or **Pro Logic IIx MOVIE** (see *Listening in surround sound* below for more on these decoding formats).
- The Stream Direct feature is canceled if you connect headphones or select the multichannel analog inputs.

## Listening in surround sound

Using this receiver, you can listen to any source in surround sound. However, the listening mode options and the current active mode may change depending on your speaker setup, the **SB CH** mode setting, and the type of source you're listening to.

- If you connected surround back speakers, see also *Using the surround back channel* on page 43 for more on the **SB CH** mode setting.

- **While listening to a source, press MOVIE or MUSIC and ←/→ (cursor left/right) to select a listening mode, then press ENTER.**

You can also use the front panel **MUSIC** and **MOVIE** buttons instead of the remote control to select listening modes. After selecting the mode you want, simply turn the **MULTI JOG** dial to cycle through the available options, pressing **ENTER** to select a mode.

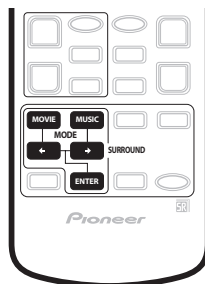

### Note

- If the **SB CH MODE** (page 43) is switched to **OFF**, or the surround back speakers are set to **NO** (this happens automatically if the *Surround back speaker setting* on page 51 is set to anything but **Normal System**), **Pro Logic IIx** (below) becomes **Pro Logic II** (5.1 channel sound).
- When the Virtual Surround Back mode (page 44) is switched on, **+VSB** will show in the front panel display after modes which are using this feature.
- In modes that give 6.1 channel sound, the same signal is heard from both surround back speakers.
- You can't use the **MUSIC** and **MOVIE** modes with sources over 48kHz when using one of the digital inputs.

### The MOVIE listening modes

These modes are specifically designed for watching movies. The basic modes provide pure decoding of multichannel sources, and will create surround channels for two channel sources. The advanced effect modes have been created give you different kinds of surround sound environments when listening to any source.

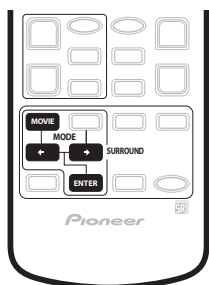

#### Basic modes

- **THX CINEMA** – Gives you cinema-quality sound from your home theater system using all the speakers in your setup (for both multichannel *and* two channel sources)

With *multichannel sources* (such as DVDs and digital satellite broadcasts), the **DIGITAL** or **DTS** indicator on the front panel lights depending on the source format.

With *two channel sources*, select from:

- **Pro Logic IIx MOVIE** – Up to 7.1 channel sound, especially suited to movie sources
- **PRO LOGIC** – 4.1 channel surround sound with sound from the surround speakers in mono
- **NEO:6 CINEMA** – 6.1 channel sound, especially suited to movie sources

With *multichannel sources*, if you have connected surround back speaker(s) and have selected **SB CH MODE ON**, you can select (according to format):

- **THX SURROUND EX** – Allows you to hear 6.1 or 7.1 channel playback with Dolby 5.1 channel sources
- **Pro Logic IIx MOVIE+THX** – Up to 7.1 channel sound, especially suited to Dolby multichannel movie sources
- **Dolby Digital EX** – Creates surround back channel sound for 5.1 channel sources and provides pure decoding for 6.1 channel sources (like Dolby Digital Surround EX)
- **Pro Logic IIx MOVIE** – See above
- **DTS+Neo:6** – Allows you to hear 6.1 or 7.1 channel playback with DTS 5.1 encoded sources
- **DTS+Neo:6+THX** – Up to 7.1 channel sound, especially suited to DTS multichannel movie sources

- **DTS-ES** – Allows you to hear 6.1 or 7.1 channel playback with DTS-ES encoded sources (depending on the disc, **DISC 6.1** or **MTRX 6.1** may be displayed)
- **DTS-ES+THX** – Up to 7.1 channel sound with DTS-ES encoded sources, especially suited to multichannel movie sources

#### Advanced effect modes

- **ACTION** – Designed for action movies with dynamic soundtracks
- **SCI-FI** – Designed for science fiction with lots of special effects
- **DRAMA** – Designed for movies with lots of dialog
- **MUSICAL** – Creates a concert hall-type sound for musicals
- **MONOFILM** – Creates surround sound from mono soundtracks
- **5/7-D THEATER** – Creates an extra wide stereo field

## The MUSIC listening modes

These modes are specifically designed for listening to music. The basic modes provide pure decoding of multichannel sources, and will create surround channels for two channel sources. The advanced effect modes have been created give you different kinds of surround sound environments when listening to any source.

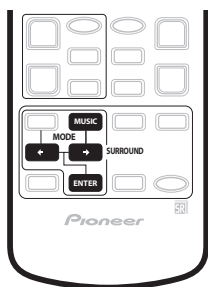

### Basic modes

With multichannel sources (such as DVDs and digital satellite broadcasts), the **DIGITAL** or **DTS** indicator on the front panel lights depending on the source format.

With two channel sources, select from:

- **Dolby Pro Logic IIx MUSIC** – Up to 7.1 channel sound, especially suited to music sources
- **NEO:6 MUSIC** – 6.1 channel sound, especially suited to music sources

With multichannel sources, if you have connected surround back speaker(s) and have selected **SB CH MODE ON**, you can select (according to format):

- **Dolby Digital EX** – Creates surround back channel sound for Dolby 5.1 channel sources and provides pure decoding for 6.1 channel sources (like Dolby Digital Surround EX)
- **Dolby Pro Logic IIx MUSIC** – See above
- **DTS+Neo:6** – Creates surround back channel sound for DTS 5.1 channel sources
- **DTS-ES** – Provides pure decoding of DTS-ES encoded sources (depending on the disc, **DISC 6.1** or **MTRX 6.1** may be displayed)

### Advanced effect modes

- **CLASSICAL** – Gives a large concert hall-type sound
- **CHAMBER** – Creates a space with a lot of reverb
- **JAZZ** – Creates the sound of a small jazz club
- **ROCK** – Creates a live concert sound for rock music
- **DANCE** – Designed for music with lots of bass
- **5/7CH STEREO** – Allows you to hear stereo sources from all the speakers in your setup

## Dolby Pro Logic IIx Music settings

When listening to 2-channel sources in Dolby Pro Logic IIx Music mode, there are three further parameters you can adjust: Center Width, Dimension, and Panorama.

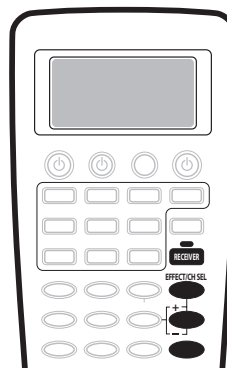

1 Press **RECEIVER**.

2 With '**Dolby Pro Logic IIx MUSIC**' mode active, press **EFFECT/CH SEL** repeatedly to select **CENTER WIDTH**, **DIMENSION** or **PANORAMA**.

- **CENTER WIDTH** – Provides a better blend of the front speakers by spreading the center channel between the front right and left speakers, making it sound wider (higher settings) or narrower (lower settings). (This is only available when using a center speaker.)
- **DIMENSION** – Adjusts the depth of the surround sound balance from front to back, making the sound more distant (minus settings), or more forward (positive settings).
- **PANORAMA** – Extends the front stereo image to include the surround speakers for a 'wraparound' effect.

3 Use the **+/-** buttons to adjust the setting.

Center Width is adjustable between **0** and **7** (default : **3**); Dimension between **-3** and **+3** (default : **0**); Panorama is **ON** or **OFF** (default : **OFF**).

4 Press **EFFECT/CH SEL** again to adjust other settings.

### Note

- If the **SB CH MODE** is switched to **OFF**, **Dolby Pro Logic IIx** (above) becomes **Dolby Pro Logic II** (5.1 channel sound), however the above setting will still be effective.
- If you set the **CENTER WIDTH** to **7**, all the center channel signal goes to your front speakers, creating a 'phantom' center channel.

### Neo:6 Music settings

- Default setting: **2**

When listening to 2-channel sources in Neo:6 Music mode, you can adjust the center image to create a wider stereo effect with vocals. Note that this is only available when using a center speaker.

- 1 Press **RECEIVER**.
- 2 With **NEO:6 MUSIC** mode active, press **EFFECT/CH SEL** repeatedly to select **CENTER IMAGE**.

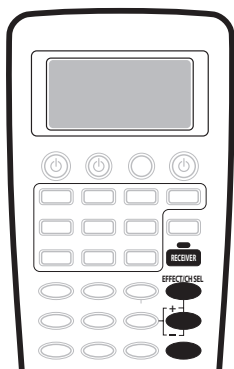

- 3 Use the **+/-** buttons to adjust the setting.

Adjust the effect from **0** (no effect) to **5** (most prominence given to the center channel).

### Adjusting the advanced effect level

- Default setting: **50** (except **5/7CH STEREO: 90**)

You can emphasize or reduce the level of the advanced effects as you like. You can set the effect level independently for each mode.



- 1 Press **RECEIVER**.
- 2 With one of the advanced effect modes active, press **EFFECT/CH SEL** repeatedly until **EFFECT** shows in the front panel display.
- 3 Use the **+/-** buttons to adjust the effect level. The effect level can be adjusted from **10** (min) to **90** (max).

### Listening in stereo

When you select **STEREO** or **DIRECT**, you will hear the source through just the front left and right speakers (and possibly your subwoofer depending on your speaker settings). Dolby Digital and DTS multichannel sources are downmixed to stereo.

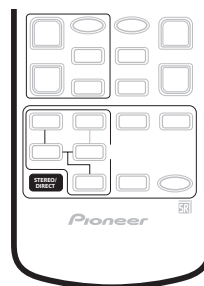

- While listening to a source, press **STEREO/DIRECT** for stereo playback.

Press repeatedly to switch between:

- **STEREO** – The audio is heard with your surround settings (such as channel level) and you can still use digital processing (such as the Midnight, Loudness, and Tone control functions).
- **DIRECT** – Bypass all effects and surround settings so that the audio remains as close to the source audio signal as possible.

#### Note

- If you switch on any signal processing features (for example, digital noise reduction or the tone controls) when **DIRECT** is selected, the receiver automatically switches to **STEREO**.

### Listening with headphones

When headphones are connected, all multichannel sources, as well as all of the **MOVIE** and **MUSIC** modes will be downmixed to 2 channels. Two channel sources will be heard in stereo.

- Connect a pair of headphones to the **PHONES** jack on the front panel.

All sources will be heard in stereo (downmixed). When you disconnect them it reverts to the previous mode.

#### Note

- Many receiver features (such as matrix decoding) are not accessible when the headphones are connected.
- When headphones are connected, no sound is heard from the speakers. However, sound will still be output from the preouts.
- You can only hear the front left and right channels when **MULTI CH IN** is switched on.



## Using the multichannel analog inputs

If you've connected to the multichannel inputs on the rear panel (see *Connecting the multichannel analog outputs* on page 20), you will be able to select them as your input source.

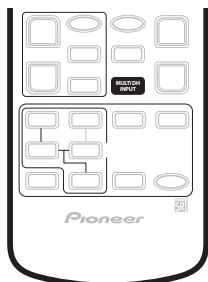

### 1 Make sure you have set the playback source to the proper output setting.

For example, you might need to set your DVD player to output multichannel analog audio.

### 2 Press **MULTI CH INPUT (MULTI CH IN on the front panel)** to select the multichannel analog inputs.

**MULTI CH IN** shows in the display to indicate the audio is coming from the multichannel analog inputs, regardless of the input source selected. The input source remains dedicated to the multichannel inputs until you press **MULTI CH IN/MULTI CH INPUT** again to cancel.

- If you need to set the channel levels, see *Channel Level* on page 52 to do so.

#### Note

- You can't use any signal processing features (for example, the **MOVIE** or **MUSIC** modes or the tone controls) with the multichannel analog inputs.
- Any speakers set to **NO** in the *Speaker Setting* on page 51 do not output the audio for the corresponding channel.
- You can't use the Second Zone speaker B setup (page 67) with the multichannel analog inputs.

## Listening with Acoustic Calibration EQ

You can listen to sources using the Acoustic Calibration Equalization set in *Automatically setting up for surround sound* on page 12 or *Acoustic Calibration EQ* on page 81. Refer to these pages for more on Acoustic Calibration Equalization.

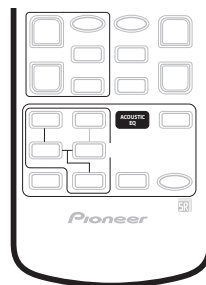

- **While listening to a source, press ACOUSTIC EQ.** Press repeatedly to select between:

- **ALL CH ADJUST** – No special weighting is given to any one channel.
- **FRONT ALIGN** – All speakers are heard in accordance with the front speaker settings.
- **CUSTOM 1/2** – Custom settings
- **OFF** – Switches Acoustic Calibration EQ off.

The MCACC indicator on the front panel lights when Acoustic Calibration EQ is active.

#### Note

- You can't use Acoustic Calibration EQ when **MULTI CH IN** is switched on.
- If you switch on Acoustic Calibration EQ when **DIRECT** is selected, the receiver automatically switches to **STEREO**.

## Selecting the input signal type

Most of the audio inputs have both analog and digital jacks. You can select the type of signal to be used in each case.

The input signal type for the current input is indicated in the display. With digital signals, the signal type (Dolby Digital or DTS) also shows in the display.

The default **AUTO** setting is usually sufficient, letting the receiver decide the most suitable signal type. However, in other cases (for example, if you want to record the analog output of a digital source) then you should set the input signal type to analog.



**1 Press RECEIVER.**

**2 Press SIGNAL SEL to select the type of input signal for the current source.**

Press repeatedly to choose between:

- **AUTO** – The receiver selects the first available signal in the following order: **DIGITAL**; **ANALOG**.
- **ANALOG** – Selects an analog signal.
- **DIGITAL** – Selects an optical or coaxial digital signal.

### Note

- If no digital inputs are assigned for the current source, the input signal type is fixed to **ANALOG**.
- When using **DIGITAL IN** terminals the following digital signal formats are supported: Dolby Digital, DTS and PCM (32, 44.1, 48, 88.2 and 96 kHz sampling frequencies). If your source is not supported, select **ANALOG**.
- Some DVD players don't output DTS signals. For more details, refer to the instruction manual supplied with your DVD player.
- The audio signal from karaoke microphones and some LDs is not output from the digital outputs. Select **ANALOG** to listen to these formats.
- If you want to play DTS-encoded sources, you need to have digital connections. If **ANALOG** is selected, you'll hear digital noise through your speakers.

## Using the surround back channel

- Default setting: **SB CH ON**

You can have the receiver automatically use 6.1 or 7.1 decoding for 6.1 encoded sources (for example, Dolby Digital EX or DTS-ES), or you can choose to always use 6.1 or 7.1 decoding with other sources (for example, 5.1 encoded material). With 5.1 encoded sources, a surround back channel will be generated, but the material may sound better in the 5.1 format for which it was originally encoded, in which case you can simply switch the surround back channel off. The table below indicates when you will hear the surround back channel when playing various kinds of sources. ● = Sound plays through surround back channel speaker(s)

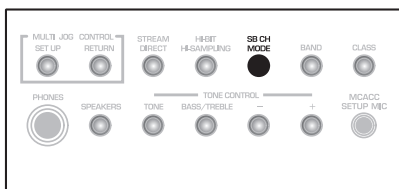
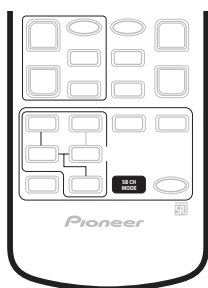

- Press **SB CH MODE** repeatedly to cycle through the surround back channel options.

Each press changes the setting as follows (see the table above for an explanation of each):

- **SB CH ON** – 6.1 or 7.1 encoding is always used (for example, on 5.1 encoded material)
- **SB CH AUTO** – Automatically switches to 6.1 or 7.1 decoding for 6.1 encoded sources (for example, Dolby Digital EX or DTS-ES)
- **SB CH OFF** – Surround back channel is switched off

### Note

- You will only hear the surround back channel when you've selected **Normal Surround** in the *Surround back speaker setting* on page 51. Changing the speaker system may automatically change this setting (see notes below).
- If the surround back speaker is set to **NO** in *Speaker Setting* on page 51, or you have selected a Second Zone speaker B setup, you can only use the virtual surround back effect (see next page).
- You can't use the surround back channel setting with **MULTI CH IN** or **STEREO/DIRECT**.
- You can't use the surround back channel feature with sources over 48kHz when using one of the digital inputs.

Type of source	SB CH mode	Surround modes (Basic)			Advanced effects
		Multichannel sources	Stereo sources		
			Pro Logic II x	Pro Logic	
Dolby Digital EX/DTS-ES encoded multichannel source with 6.1ch surround	ON	●			●
	AUTO	●			●
Dolby Digital/DTS encoded multichannel source	ON	●			●
	AUTO				●
Dolby Digital/DTS encoded stereo source; other digital stereo source	ON		●		●
	AUTO		●		●
Analog 2-channel (stereo) source	ON		●		●
	AUTO		●		●

## Listening with virtual surround back speakers

- Default setting: **VIRTL SB OFF**

If you don't have real surround back speakers connected, you can use the Virtual Surround Back feature to simulate one.

Sometimes the material may sound better in the 5.1 format for which it was originally encoded. In this case you can have the receiver only apply this effect to 6.1 encoded sources like Dolby Digital EX or DTS-ES (**VIRTL SB AUTO**), or you can simply switch it off (**VIRTL SB OFF**). For stereo sources, you'll have to select one of the **NEO:6** modes or an advanced effect mode (see *Listening in surround sound* on page 37) to use the Virtual Surround Back feature.

Note that this feature only works when the surround channels are active and the surround back speaker is set to **NO** in *Speaker Setting* on page 51.

See also *Using the surround back channel* above.

- Press **SB CH MODE** repeatedly to cycle through the virtual surround back channel options.

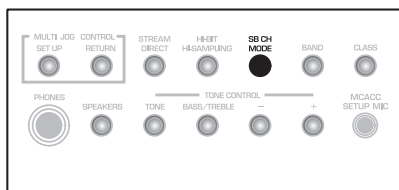
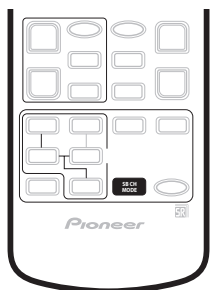

Each press cycles through the options as follows:

- **VIRTL SB ON** – Virtual Surround Back is used for all sources
- **VIRTL SB AUTO** – Automatically applied to 6.1 encoded sources (for example, Dolby Digital EX or DTS-ES)
- **VIRTL SB OFF** – Virtual Surround back is switched off

### Note

- You can't use the Virtual Surround Back setting with **THX CINEMA**, **PRO LOGIC II**, **PRO LOGIC IIx**, **MULTI CH IN** or **STEREO/DIRECT**.

- You can't use the Virtual Surround Back feature with sources over 48kHz when using one of the digital inputs.
- When using the Virtual Surround Back feature with the surround modes, **+VSB** shows in the display.

## Using the audio scaler for Hi-bit and Hi-sampling

- Default setting: **Off**

You can use the audio scaler to create a wider dynamic range with digital sources like CDs or DVDs.

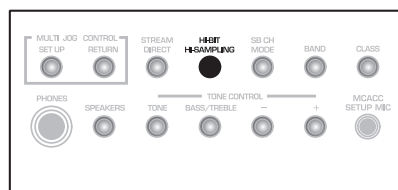
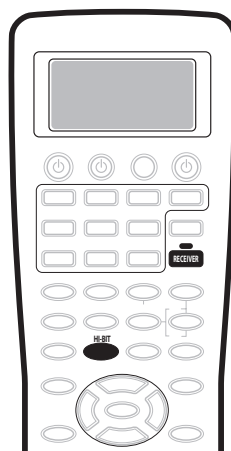

- 1 If you're using the remote, press **RECEIVER**.
- 2 Press **HI-BIT (HI-BIT/HI-SAMPLING on the front panel)**.

### Note

- You can't use the audio scaler with **MULTI CH IN**.
- You can't use the audio scaler with sources over 48kHz when using one of the digital inputs.
- If you switch on the audio scaler when **DIRECT** is selected, the receiver automatically switches to **STEREO**.

## Using Midnight and Loudness listening

- Default setting: **Off**

The Midnight listening feature makes quieter sounds more audible, allowing you to hear effective surround sound at low volume levels.

The Loudness feature boosts the bass and treble in audio sources, useful for listening at low volumes.

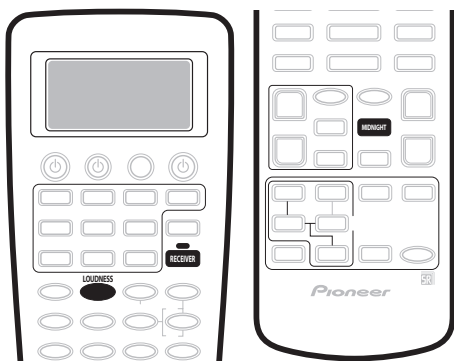

### 1 Press RECEIVER.

This step is only necessary if you want to use Loudness.

### 2 Press MIDNIGHT or LOUDNESS to switch the effect on or off.

The mode you've selected lights in the display.

#### Note

- You can't use the Midnight and Loudness modes at the same time.
- You can't use these modes with **THX CINEMA** or **MULTI CH IN**.
- These modes automatically adjust according to the volume at which you're listening. However, the volume must be under -20dB for these features to take effect.
- You can't use these modes with sources over 96kHz when using one of the digital inputs.
- If you switch on either of these modes when **DIRECT** is selected, the receiver automatically switches to **STEREO**.

## Using the tone control

You can use the tone control to make customized settings for the bass and treble.

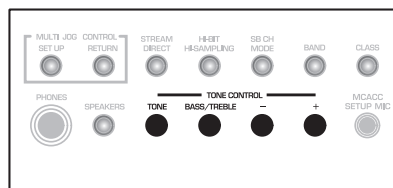
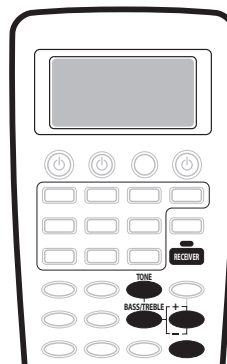

### Switching the tone control on or off

- Default setting: **Off**

You'll need to switch the tone control on to adjust the bass and treble below.

#### 1 If you're using the remote, press RECEIVER.

#### 2 Press TONE to switch the tone control on or off.

**TONE** shows in the display when the tone control is switched on.

### Adjusting the bass and treble

- Default setting: Bass: **0**, Treble: **0**

You can adjust the bass and treble controls separately to adjust the overall tone.

#### 1 Press BASS/TREBLE repeatedly to select BASS or TREBLE.

If you see **TONE:BYPASS** in the display, the tone control needs to be switched on (see above).

#### 2 Use the +/- buttons to adjust the sound.

The bass and treble can be adjusted from **-6** to **+6**.

#### Note

- You can't use the tone control with **THX CINEMA** or **MULTI CH IN**.
- You can't use the tone control with sources over 96kHz when using one of the digital inputs.

- If you switch on the tone control when **DIRECT** is selected, the receiver automatically switches to **STEREO**.

## Reducing noise during playback

- Default setting: **Off**

If you have a noisy source (for example, cassette or video tape with lots of background noise), you may be able to improve the quality of the sound by switching on digital noise reduction (**DNR**).

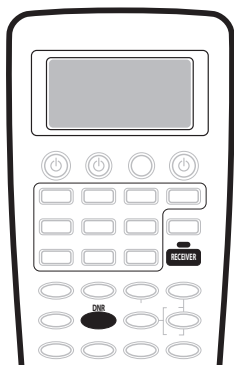

**1 Press RECEIVER.**

**2 Press the DNR button to switch digital noise reduction on or off.**

**DNR** shows in the display when digital noise reduction is switched on.

### Note

- Depending on the source, there may not be a noticeable improvement in the quality of the sound.
- You can't use digital noise reduction with **THX CINEMA** or **MULTI CH IN**.
- You can't use digital noise reduction with sources over 48kHz when using one of the digital inputs.
- If you switch on digital noise reduction when **DIRECT** is selected, the receiver automatically switches to **STEREO**.

## Listening to dual mono soundtracks

- Default setting: **DUAL ch1**

You can specify how dual mono encoded Dolby Digital soundtracks should be played. Dual mono is not widely used, but is sometimes necessary when two languages need to be sent to separate channels.

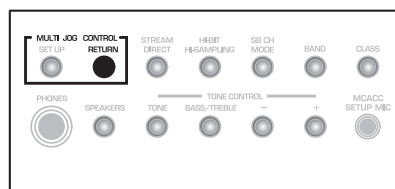

**1 Press and hold the RETURN button for more than three seconds to select a DUAL MONO setting.**

You will see the following settings cycle in the display:

- **DUAL ch1** – Only channel 1 is played
- **DUAL ch2** – Only channel 2 is played
- **DUAL ch1/ch2** – Both channels are played through the front speakers

**2 Release the button when you see the setting you want.**

### Note

- This setting works only with dual mono encoded Dolby Digital soundtracks.

## Chapter 6

# Using the tuner

### Finding a station

The following steps show you how to tune in to FM and AM radio broadcasts using the automatic (search) and manual (step) tuning functions. If you already know the exact frequency of the station you want to listen to, see *Tuning directly to a station* below. Once you are tuned to a station you can memorize the frequency for recall later—see *Memorizing station presets* below for more on how to do this.

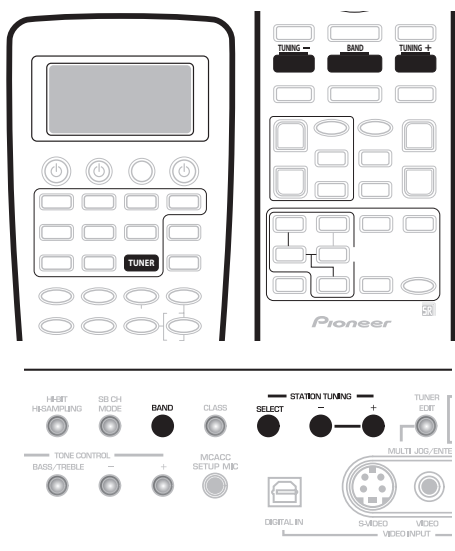

#### 1 Press TUNER, then press BAND to change the band (FM or AM), if necessary.

Each press switches the band between FM and AM.

- You can also use the front panel **MULTI JOG** dial to select the tuner.

#### 2 Tune to a station using the TUNING +/- buttons.

On the front panel, press **SELECT** first to switch to the frequency select mode for (STATION) TUNING +/-.

##### Automatic tuning

To search for stations in the currently selected band, press and hold either of the **TUNING +/-** buttons for about a second. The receiver will start searching for the next station, stopping when it has found one. Repeat this step to search for other stations.

##### Manual tuning

To change the frequency one step at a time, press the **TUNING +/-** buttons repeatedly.

### High speed tuning

Press and hold the **TUNING +/-** buttons for high speed tuning, releasing the button once you reach the frequency you want.

### Tuning directly to a station

Sometimes, you'll already know the frequency of the station you want to listen to. In this case, you can simply enter the frequency directly using the number buttons on the remote control.

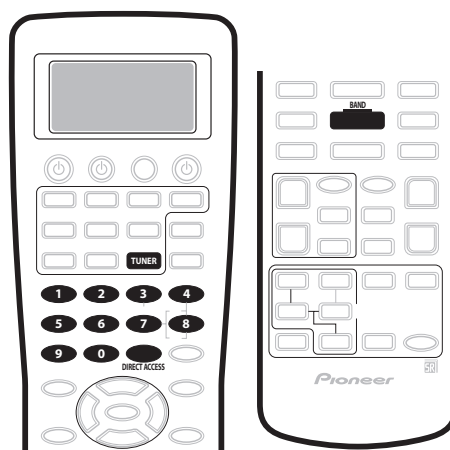

#### 1 Press TUNER, then press BAND to change the band (FM or AM), if necessary.

Each press switches the band between FM and AM.

#### 2 Press DIRECT ACCESS.

#### 3 Use the number buttons to enter the frequency of the radio station.

For example, to tune to 106.00 (FM), press **1, 0, 6, 0, 0**.

#### Note

- If you make a mistake while inputting the frequency, press the **DIRECT ACCESS** button again to cancel the frequency and start again.

### MPX mode

If there is interference or noise during a stereo FM radio broadcast (the **STEREO** indicator is lit), or the radio reception is weak, press **MPX** on the remote to switch the receiver into mono reception mode (the **MONO** indicator lights). This should improve the sound quality and allow you to enjoy the broadcast.

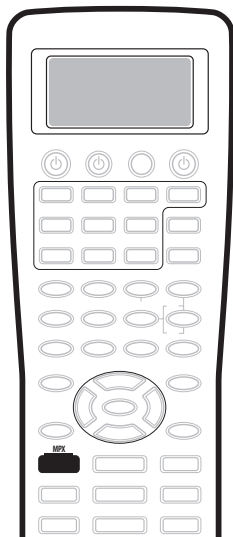

### Memorizing station presets

If you often listen to a particular radio station, it's convenient to have the receiver store the frequency for easy recall whenever you want to listen to that station. This saves the effort of manually tuning in each time. The receiver can memorize up to 30 stations, stored in three banks, or classes, (A, B and C) of 10 stations each. When memorizing FM frequencies, the receiver also stores the MPX setting (see *MPX mode* above).

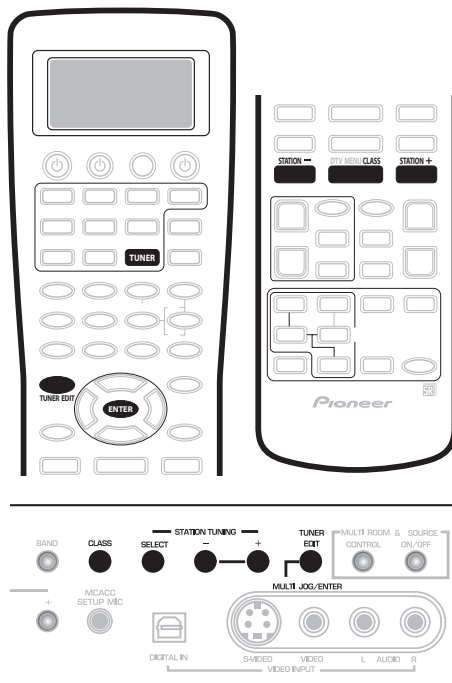

#### 1 Tune to a station you want to memorize.

See *Finding a station* above and *Tuning directly to a station* above for more details on how to do this.

#### 2 Press TUNER EDIT.

The display shows **MEMORY INPUT** then a blinking memory class (**A**, **B** or **C**).

#### 3 Press CLASS to select one of the three classes.

Press repeatedly to cycle through the three memory classes, **A**, **B** and **C**.

#### 4 Use the STATION +/- buttons to select the station preset you want.

On the front panel, press **SELECT** first to switch to the station select mode for **STATION (TUNING) +/-**.

- You can also use the front panel **MULTI JOG** dial or the number buttons on the remote control to select the station preset.

#### 5 While the display is blinking, press ENTER.

#### 6 Repeat steps 1 – 5 to memorize up to 30 stations.



## Listening to memorized station presets

You can do this from both the remote control and the front panel.

### 1 Press CLASS to select the class in which the station is stored.

Press repeatedly to cycle through the three memory classes, **A**, **B** and **C**.

### 2 Use the STATION +/- buttons to select the station memory in which the station is stored.

On the front panel, press **SELECT** first to switch to the station select mode for **STATION (TUNING) +/-**.

- You can also use the number buttons or the ◀/▶ (cursor left/right) buttons on the remote control to recall the station preset.

## Naming station presets

You can input a name of up to four characters for each preset station in the receiver's memory. For example, you could input **Jazz** for that station and when you listen to it the name, rather than the frequency, will appear in the front panel display.

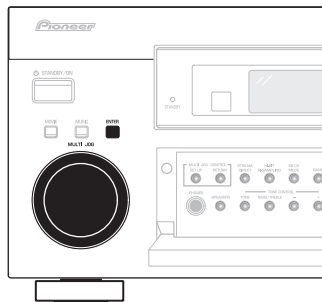
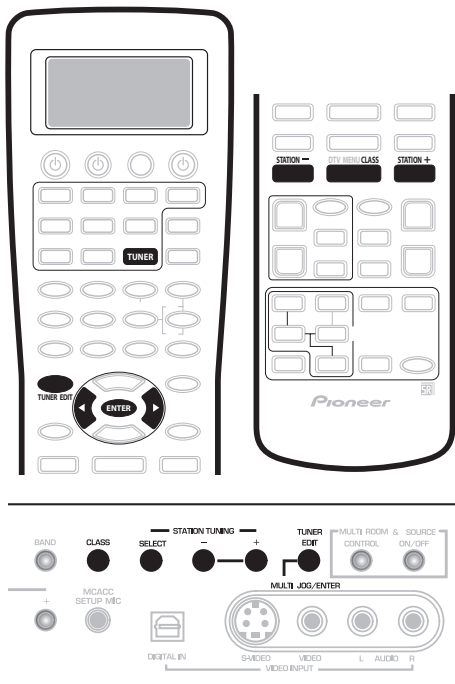

### 1 Press CLASS repeatedly to select the class.

Press repeatedly to cycle through the three memory classes, **A**, **B** and **C**.

### 2 Use the STATION +/- buttons to select an FM or AM preset station.

On the front panel, press **SELECT** first to switch to the station select mode for **STATION (TUNING) +/-**.

### 3 Press TUNER EDIT to select the station name mode.

### 4 Edit the name as necessary and press ENTER.

Use the ◀/▶ (cursor left/right) buttons or the front panel **MULTI JOG** dial to change the character and **ENTER** to confirm (or to add a space if no character is input). The name can be up to four characters (the possible characters are listed below).

**ABCDEFGHIJKLMNOPQRSTUVWXYZ**

**abcdefghijklmnopqrstuvwxyz**

**0123456789**

**!"#\$%&'()\*+,-./:;<=>?@[ \ ]^\_{|} (space)**

To exit the process at any time, press **TUNER EDIT**.

### 5 Repeat steps 2 – 4 to memorize up to 30 preset broadcast station names.



#### Tip

- To change a station name, just enter the new name over the top of the old one. To erase a station name, enter a new name of four spaces.
- You can switch between the frequency display and the station name display using the remote control **DISP MODE** button.

## Chapter 7

# The Surround Setup menu

## Making receiver settings from the Surround Setup menu

This receiver allows you to make detailed settings to optimize the surround sound performance. You only need to make these settings once (unless you change the placement of your current speaker system or add new speakers.).

These settings are designed to fine-tune your system, but if you're satisfied with the settings made in *Automatically setting up for surround sound* on page 12, it isn't necessary to make all of these settings.

### Important

- For some of the settings below, you'll have to connect the setup microphone to the front panel and place it about ear level at your normal listening position. See *Automatically setting up for surround sound* on page 12 if you're unsure how to do this. Also see *Other problems when using the Auto Surround Setup* on page 14 for notes regarding high background noise levels and other possible interference.
- If you're using a subwoofer, switch it on and turn up the volume to the middle position.
- After three minutes of inactivity during the **Auto** setup options, the OSD will go to sleep until a button is pressed. With other screens, the receiver automatically exits and no settings will be made.

### Caution

- The test tones used in the Surround Setup are output at high volume (the volume increases to 0dB automatically).

### 1 Switch on the receiver and your TV.

Use the  **RECEIVER** button to switch on.

- If headphones are connected to the receiver, disconnect them.

### 2 Using the remote control, press RECEIVER, then press the SYSTEM SETUP button.

An on-screen display (OSD) appears on your TV. Use the **▲/▼** (cursor up/down) buttons and **ENTER** on the remote control to navigate through the screens and select menu items.

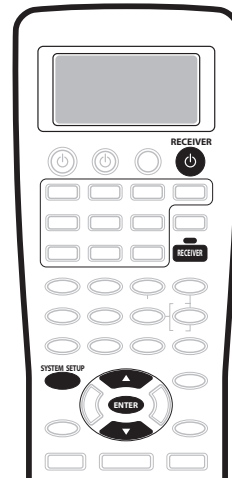

### Tip

- You can also use the front panel display to make settings. You can also use the **MULTI JOG** dial and **ENTER** on the front panel instead of the **▲/▼** (cursor up/down) buttons and **ENTER** on the remote control.

### 3 Select 'Surround Setup' then press ENTER.

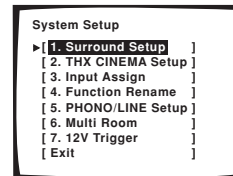

### 4 Select the setting you want to adjust.

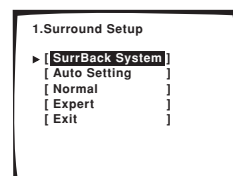

- **SurrBack System** – Specify how you are using your surround back speakers (see *Surround back speaker setting* below).
- **Auto Setting** – This is a quick and easy automatic surround setup (see *Automatically setting up for surround sound* on page 12).
- **Normal** – Specify the size, number, distance and overall balance of the speakers you've connected (see *Normal surround setting* below).
- **Expert** – Use this menu to fine tune your surround setup (see *The Expert setup menu* on page 79).

**5 Make the adjustments necessary for each setting, pressing ENTER to confirm after each setting.**

## Surround back speaker setting

- Default setting: **Normal**

There are several ways you can use the surround back speaker channels with this system. In addition to a normal home theater setup where they are used for the surround back speakers, they can be used for bi-amping the front speakers or as an independent speaker system in another room.

**1 Select 'SurrBack System' from the Surround Setup menu.**

See *Making receiver settings from the Surround Setup menu* above if you're not already at this screen.

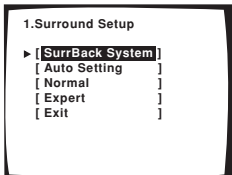

**2 Select the surround back speaker setting.**

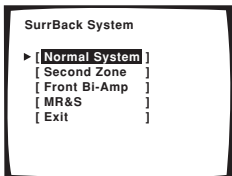

- **Normal System** – Select for normal home theater use with surround back speakers in your main (speaker system A) setup.
- **Second Zone** – Select to use the (surround back) B speaker terminals to listen to stereo playback in another room (see *Second Zone speaker B setup* on page 67).

- **Front Bi-Amp** – Select this setting if you're bi-amping your front speakers (see *Bi-amping your front speakers* on page 68).
- **MR&S** – Select to use the (surround back) B speaker terminals for an independent system in another room (see *Multi-room listening* on page 69).

**3 When you're finished, select 'Exit'.**

You will return to the Surround Setup menu.

## Normal surround setting

If you aren't satisfied with the results the Auto Setup (*Automatically setting up for surround sound* on page 12), you can use these settings to adjust speaker parameters manually. Note that these settings overwrite the settings made with the Auto Setup.

- **Select 'Normal' from the Surround Setup menu.**

See *Making receiver settings from the Surround Setup menu* above if you're not already at this screen.

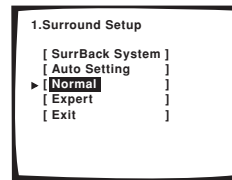

## Speaker Setting

- Default setting: **SMALL** (all speakers) / **Subwoofer – YES**

Use this setting to specify your speaker configuration (size, number of speakers). You can make sure that the settings made in *Automatically setting up for surround sound* on page 12 are correct.

**1 Choose 'Speaker Setting' from the Normal setup menu.**

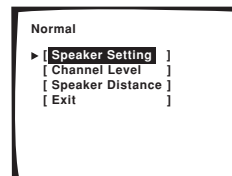

**2 Choose the set of speakers that you want to set then select a speaker size.**

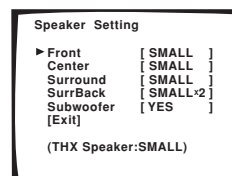

Use ▲/▼ (cursor up/down) to select the size (and number) of each of the following speakers:

- **Front** – Select **LARGE** if your front speakers reproduce bass frequencies effectively, or if you didn't connect a subwoofer. Select **SMALL** to send the bass frequencies to the subwoofer.
- **Center** – Select **LARGE** if your center speaker reproduces bass frequencies effectively, or select **SMALL** to send bass frequencies to the other speakers or subwoofer. If you didn't connect a center speaker, choose **NO** (the center channel is sent to the front speakers).
- **Surround** – Select **LARGE** if your surround speakers reproduce bass frequencies effectively. Select **SMALL** to send bass frequencies to the other speakers or subwoofer. If you didn't connect surround speakers choose **NO** (the sound of the surround channels is sent to the front speakers or a subwoofer).
- **SurrBack** – Select the number of surround back speakers you have (one, two or none). Select **LARGE** if your surround back speakers reproduce bass frequencies effectively. Select **SMALL** to send bass frequencies to the other speakers or subwoofer. If you didn't connect surround back speakers choose **NO**.
- **Subwoofer** – LFE signals and bass frequencies of channels set to **SMALL** are output from the subwoofer when **YES** is selected (see notes below). Choose the **PLUS** setting if you want the subwoofer to output bass sound continuously or you want deeper bass (the bass frequencies that would normally come out the front and center speakers are also routed to the subwoofer). If you did not connect a subwoofer choose **NO** (the bass frequencies are output from other speakers).

#### Note

- If you selected **Second Zone**, **Front Bi-Amp**, or **MR&S** in *Surround back speaker setting* above you can't adjust the surround back settings.
- If you select **SMALL** for the front speakers the subwoofer will automatically be fixed to **YES**. Also, the center and surround speakers can't be set to **LARGE** if the front speakers are set to **SMALL**. In this case, all bass frequencies are sent to the subwoofer.
- If the surround speakers are set to **NO**, the surround back speakers will automatically be set to **NO**.
- If you select one surround back speaker only, make sure that speaker is hooked up to the left surround back terminal.
- If you're using a THX speaker setup, we recommend setting all speakers to **SMALL**.

### 3 When you're finished, select 'Exit'.

You will return to the Normal setup menu.

#### Tip

- If you have a subwoofer and like lots of bass, it may seem logical to select **LARGE** for your front speakers and **PLUS** for the subwoofer. This may not, however, yield the best bass results. Depending on the speaker placement of your room you may actually experience a decrease in the amount of bass due to low frequency cancellations. In this case, try changing the position or direction of speakers. If you can't get good results, listen to the bass response with it set to **PLUS** and **YES** or the front speakers set to **LARGE** and **SMALL** alternatively and let your ears judge which sounds best. If you're having problems, the easiest option is to route all the bass sounds to the subwoofer by selecting **SMALL** for the front speakers.

### Channel Level

- Default setting: **0dB** (all speakers)

Using the channel level setting, you can adjust the overall balance of your speaker system, an important factor when setting up a home theater system.

#### 1 Select 'Channel Level' from the Normal setup menu.

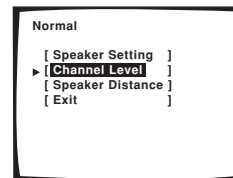

#### 2 Select a setup option and press ENTER to start the test tones.

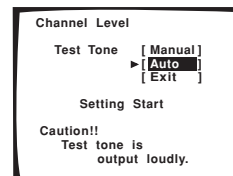

- **Manual** – Move the test tone manually from speaker to speaker and adjust individual channel levels.
- **Auto** – Adjust channel levels as the test tone moves from speaker to speaker automatically.

### 3 Adjust the level of each channel using the ▲/▼ (cursor up/down) buttons.

If you selected **Manual**, use ▲/▼ (cursor up/down) and **ENTER** to select speakers. The **Auto** setup will output test tones in the order shown on-screen:

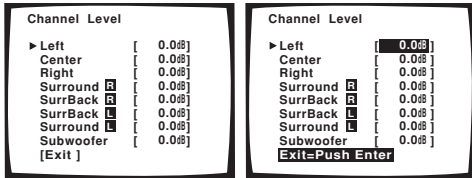

Manual setup

Auto setup

Adjust the level (+/- 10dB) of each speaker as the test tone is emitted.

#### Note

- If you are using a Sound Pressure Level (SPL) meter, take the readings from your main listening position and adjust the level of each speaker to 75 dB SPL (C-weighting/slow reading).
- The subwoofer test tone is output at low volumes. You may need to adjust the level after testing with an actual soundtrack.

### 4 If you selected 'Manual', select 'Exit' to finish. With 'Auto', simply press ENTER.

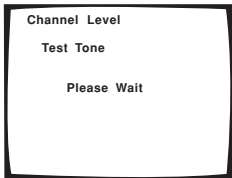

You will return to the Normal setup menu.

#### Tip

- You can change the channel levels at any time by pressing **RECEIVER** then **EFFECT/CH SEL** (to select the channel you want to adjust) on the remote. Use the +/- buttons to increase/decrease the level.

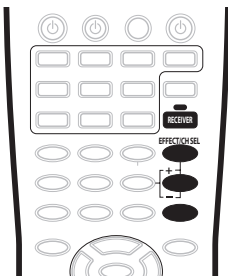

### Speaker Distance

- Default setting: **10.0 ft** (all speakers)

For good sound depth and separation from your system, you need to specify the distance of your speakers from the listening position. The receiver can then add the proper delay needed for effective surround sound.

### 1 Select 'Speaker Distance' from the Normal setup menu.

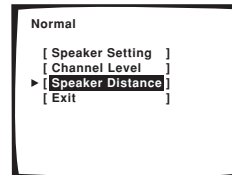

### 2 Specify the distance of each speaker from the listening position.

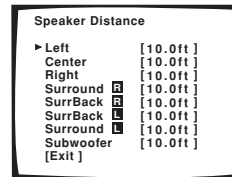

Adjust the distance of each speaker within the range of 0.5–45 feet.

### 3 When you're finished, select 'Exit'.

You will return to the Normal setup menu.

#### Tip

- For best surround sound, make sure the surround back speakers are the same distance.

## Chapter 8

# Controlling other equipment

## Using the remote control with other components

The supplied remote control can operate not only this receiver, but also your TV, DVD player and other components. If the component is listed in the remote control's memory, you can simply follow the steps in *Recalling preset codes* below. If the component is not listed, or if you want the remote to learn additional operations, see *Programming signals from other remote controls* on page 55.

See *Preset code brands* on page 97 for a list of brands available for each component.



### Note

- You can cancel or exit any of the following steps by pressing **REMOTE SETUP**.
- After one minute of inactivity, the remote goes to sleep. Press any button to reactivate the remote display and continue.
- TV codes (for example, codes for TV, CATV, Satellite TV or DTV) can only be assigned to the **TV/SAT** or **TV CONT** button.
- The default preset setting for all functions is a corresponding Pioneer component. Note that where two buttons are listed, the first component is the the default (for example, **MD/TAPE2** is an MD), and the **VIDEO** button is set to a Pioneer DVD player.

## Recalling preset codes

The following steps show you how to recall preset codes for each input source. Use the remote control to do this.

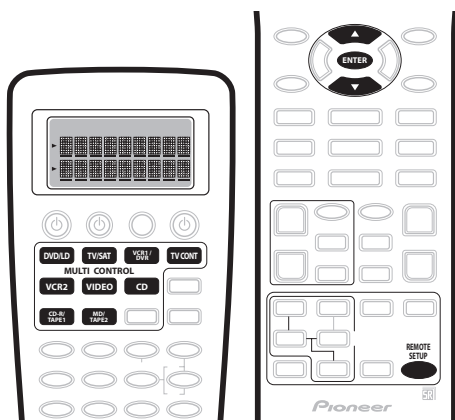

**1 Make sure the component you want to control is switched on.**

**2 Press and hold REMOTE SETUP for three seconds.** The **REMOTE SETUP** menu appears in the remote control display.

**3 Use ▲/▼ (cursor up/down) to select 'Preset' from the menu and press ENTER.** **Select Function** flashes in the display.

**4 Press the MULTI CONTROL button that matches the connection for the component you want to control.**

For example, press **DVD/LD** if you want to control the DVD player that you connected to the **DVD/LD** terminals.

- Choosing a button that's already assigned will overwrite the old preset (and any other operations you may have programmed).
- You can't assign the **RECEIVER** or **TUNER** buttons.

**5 Use ▲/▼ (cursor up/down) to choose the type of component you've connected and press ENTER.**

Following our example above, you would select **DVD**, but you should choose from the **ITEM** list according to the component connected. For example, if you connected a DVD recorder instead of a VCR to the **VCR2** inputs, you would select **DVR** here.

**6 Use ▲/▼ (cursor up/down) to select the manufacturer's name from the list.**

If there is more than one component type for the manufacturer, then **-1, -2, etc.** will appear in the display. Start with the first one in the list.

**7 Point the remote at the component you want to control and press ENTER.**

**OK?** shows in the remote control display.

If the component switches off (into standby), use ▲/▼ (cursor up/down) and **ENTER** to select **Yes**. **COMPLETE** shows in the display to confirm that the component preset has been recalled properly.

If the component doesn't switch off (into standby), use ▲/▼ (cursor up/down) and **ENTER** to select **No**. Choose another preset for your manufacturer (step 6).

- If the component you are trying to control doesn't have a standby mode, simply select **Yes** above then confirm that it is the right code by testing it with another operation button.
- If you can't find or properly enter a preset code, you can still teach the remote individual commands from another remote control (see *Programming signals from other remote controls* below).

8 Repeat steps 3 – 7 for any other components you want to control.

9 When you're finished, use ▲/▼ (cursor up/down) to select '\*Exit\*' from the menu and press ENTER.

## Programming signals from other remote controls

If the preset code for your component is not available, or the available preset codes do not operate correctly, you can program signals from the remote control of another component. This can also be used to program additional operations (buttons not covered in the presets) after assigning a preset code in *Recalling preset codes* on page 54.

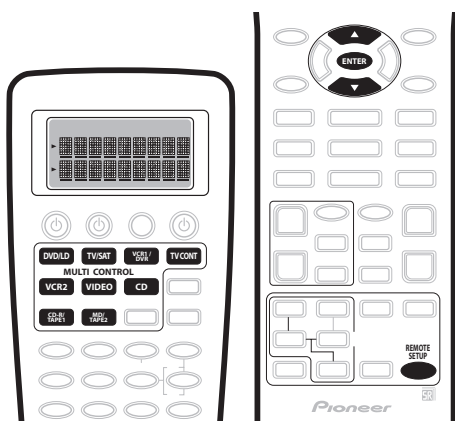

1 Press and hold REMOTE SETUP for three seconds.

The REMOTE SETUP menu appears on the remote control display.

2 Use ▲/▼ (cursor up/down) to select 'Learning' from the menu and press ENTER.

Select Function flashes in the display.

3 Press the MULTI CONTROL button that matches the connection for the component you want to control.

For example, press DVD/LD if you want to program an operation for the DVD player that you connected to the DVD/LD terminals.

Select Key flashes in the display.

- You can't assign the RECEIVER or TUNER buttons.

4 Select the button corresponding to the command you want to teach the remote control.

For example, press ► if you want to program the play command from your DVD player remote control.

LEARN flashes in the display.

- When programming TV CONT, you can only select TV⏻, or one of the TV CONTROL buttons.

5 Point the two remote controls towards each other then press the corresponding button on the other remote control that is sending (teaching) the signal to this receiver's remote control.

For example, if you want to learn the playback control signal, press ►.

- The remote controls should be 2–8 inches apart, and the LEARN icon should be flashing to indicate the remote is ready to accept a signal.



If the operation has been learned, the display will show OK

If the operation hasn't been learned the display will show NG.

Continue? shows in the display (if Select Key is flashing, go back to step 4). Go to step 6.

- If the remote display shows FULL, it means the memory is full. See *Clearing remote control settings* on page 65 to erase a programmed button you're not using to free up more memory.
- If NG keeps showing in the display, or the remote control keeps on returning to step 4 (Select Key flashes in the display), it may be possible that the command cannot be learned by this remote control.

Certain buttons represent operations that cannot be learned from other remote controls. The buttons available are shown below:

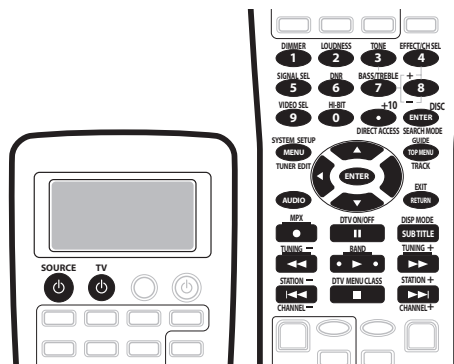

6 Use ▲/▼ (cursor up/down) to select 'Yes' to program additional signals for the current component.

Repeat steps 4 and 5.

- To program signals for another component, select No and repeat steps 2 through 5.

7 When you're finished, use ▲/▼ (cursor up/down) to select '\*Exit\*' from the menu and press ENTER.

You will return to the REMOTE SETUP menu. Select \*Exit\* again to exit.



## Controls for TVs

This remote control can control components after entering the proper codes or teaching the receiver the commands (see *Using the remote control with other components* on page 54 for more on this). Use the **MULTI CONTROL** buttons to select the component.

Button (s)	Function	Components
TV 	Switches the TV, Satellite TV or Cable TV between standby and on.	Cable TV/Satellite TV/TV
TV INPUT	Switches the TV input.	TV
TV CH (+/-)	Selects channels	Cable TV/Satellite TV/TV
TV VOL (+/-)	Adjusts the TV volume.	TV
MENU	Takes you to the TV menu of that system.	Cable TV/Satellite TV/TV/ Digital TV
GUIDE	Takes you to the guide menu of that system.	Cable TV/Satellite TV/TV/ Digital TV
RETURN	Exits the current menu.	Cable TV/Satellite TV/ Digital TV
●	A/BLUE	Satellite TV/Digital TV/TV
	B/Press to switch the DTV ON.	Satellite TV/Digital TV/TV
◀◀	C/GREEN Use to go to the previous page in a menu.	Satellite TV/Digital TV/TV Cable TV
▶	D/RED	Satellite TV/Digital TV/TV
▶▶	E/YELLOW Use to go to the next page in a menu.	Satellite TV/Digital TV/TV Cable TV
◀◀◀	Use to move back channels. Use to move back a page in a menu.	Digital TV/TV/Cable TV Satellite TV
▶▶▶	Use to move forward channels. Use to go to the next page in a menu.	Digital TV/TV/Cable TV Satellite TV
■	Use to show the DTV menu.	Digital TV/TV
<b>Number buttons</b>	Use to select a specific TV channel.	Cable TV/Satellite TV/TV/ Digital TV
ENTER/ DISC	Use this button to immediately enter a new channel.	Cable TV/TV/Digital TV
◀▶▶▶ & ENTER	Press to select or adjust and navigate items on the menu screen.	Cable TV/Satellite TV/TV/ Digital TV











### Note

- The **TV CONTROL** buttons on the remote control are dedicated to control the TV assigned to the **TV CONT** button. Thus if you only have one TV to hook up to this system assign it to the **TV CONT MULTI CONTROL** button. If you have two TVs, assign the main TV to the **TV CONT** button.
- Depending on the maker and individual model, there are some buttons that may not be able operate some equipment or may operate it in a different way.



## Controls for other components

This remote control can control these components after entering the proper codes or teaching the receiver the commands (see *Using the remote control with other components* on page 54 for more on this). Use the **MULTI CONTROL** buttons to select the component.

Button(s)	Function	Components
<b>SOURCE</b> 	Press to switch the component between standby and on.	CD/MD/CD-R/VCR/DVD/LD/DVD recorder/Cassette deck
	Press to return to the start of the current track or chapter. Repeated presses skips to the start of previous tracks or chapters.	CD/MD/CD-R/DVD/LD
	Use to move back channels (channel -).	VCR/DVD recorder
	Play the reverse side of the tape on a reversible deck.	Cassette deck
	Skips to the start of the next track or chapter. Repeated presses skips to the start of following tracks or chapters.	CD/MD/CD-R/DVD/LD
	Use to go forward channels (channel +).	VCR/DVD recorder
	Pauses playback or recording.	CD/MD/CD-R/VCR/DVD/LD/DVD recorder/Cassette deck
	Hold down for fast forward playback.	CD/MD/CD-R/VCR/DVD/LD/DVD recorder/Cassette deck
	Hold down for fast reverse playback.	CD/MD/CD-R/VCR/DVD/LD/DVD recorder/Cassette deck
	Start playback.	CD/MD/CD-R/VCR/DVD/LD/DVD recorder/Cassette deck
	Stop playback (on some models, pressing this when the disc is already stopped will cause the disc tray to open).	CD/MD/CD-R/VCR/DVD/LD/DVD recorder/Cassette deck
	Starts recording.	MD/CD-R/VCR/DVD recorder/Cassette deck
<b>SUBTITLE/ DISP MODE</b>	Displays/changes the subtitles on multilingual DVDs.	DVD/DVD recorder
	Change the display mode.	CD/MD/CD-R/VCR/LD
<b>Number buttons</b>	Use to directly access tracks on a program source.	CD/MD/CD-R/LD
	Use to directly access chapters on a program source.	DVD/DVD recorder
	Use to directly select a channel.	VCR/DVD recorder
<b>+10 button</b>	Use to select tracks or chapters higher than 10. Press this button and the remaining number to get the track or chapter (+10 button + 3 = track or chapter 13). • Some components may operate differently.	CD/MD/CD-R/DVD/LD/ DVD recorder
	Press to start the search mode.	DVD
<b>ENTER/ DISC</b>	Takes you to the disc navigator.	DVD recorder
	Changes between sides A & B of the disc.	LD
	Press to enter the selected channel.	VCR
	Selects a disc in a multi-disc CD player.	CD
<b>MENU</b>	Displays menus for the current DVD, DVR or VCR you are using.	DVD/DVD recorder/VCR

Button(s)	Function	Components
<b>AUDIO</b>	Changes the audio track of discs with more than one audio track.	DVD/LD/DVD recorder
	Changes between the tuner in the TV and the tuner in the VCR.	VCR
	Play the reverse side of the tape on a reversible cassette deck.	Double cassette 2nd deck
<b>TOP MENU/ GUIDE</b>	Displays the top menu of the current DVD, LD or DVR you are using.	DVD/LD/DVD recorder
	Takes you to the guide menu of the system.	VCR
	Press to select a track.	CD
<b>RETURN/ EXIT</b>	Takes you to the previous menu.	VCR/DVD/LD/DVD recorder
<b>◀▶▲▼ &amp; ENTER</b>	Navigates menu/options.	VCR/DVD/LD/DVD recorder
	Basic playback options.	Double cassette 2nd deck

**Note**

- Depending on the maker and individual model, there are some buttons that may not be able operate some equipment or may operate it in a different way.
- The default preset setting for all functions is a corresponding Pioneer component. Note that where two buttons are listed, the first component is the the default (for example, **MD/TAPE2** is an MD), and the **VIDEO** button is set to a Pioneer DVD player.

## Direct function

- Default setting: **On** (all components)

You can use the direct function feature to control one component using the remote control while at the same time, using your receiver to playback a different component. This could let you, for example, use the remote control to set up and listen to a CD on the receiver and then use the remote control to rewind a tape in your VCR while you continue to listen to your CD player.

When direct function is on, any component you select (using the **MULTI CONTROL** buttons) will be selected by both the receiver and the remote control. When you turn direct function off, you can operate the remote control without affecting the receiver.

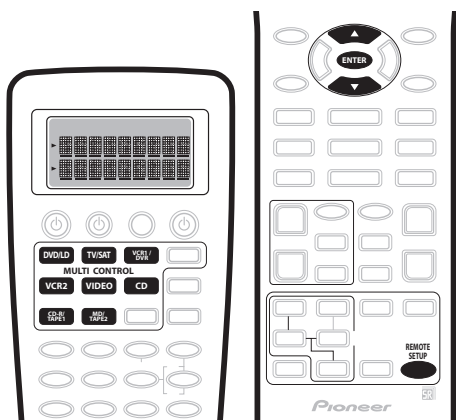

### 1 Press and hold **REMOTE SETUP** for three seconds.

The **REMOTE SETUP** menu appears on the remote control display.

### 2 Use **▲/▼** (cursor up/down) to select 'DirctFnc' from the menu and press **ENTER**.

**Select Function** flashes in the display.

### 3 Press the **MULTI CONTROL** button for the component you want to set.

The remote displays the component you want to set.

### 4 Use **▲/▼** (cursor up/down) to switch direct function on or off then press **ENTER**.

The display shows **COMPLETE** to confirm the setting.

### 5 Repeat steps 2-4 for as many components as you want.

#### **Note**

- You can't use direct function with the **TUNER** or **TV CONT** functions.

## Multi Operation and System Off

The Multi Operation feature allows you to program a series of commands for the components in your system. For example, you could turn on your TV, turn on your DVD player and start playing the loaded DVD using only two buttons on the remote control.

Similar to multi operations, System Off allows you to use one button to stop and switch off a series of components in your system at the same time.

#### **Note**

- Before Multi Operation and System Off will work correctly, you must setup the remote to work with your TV and other components (see *Recalling preset codes* on page 54 and *Programming signals from other remote controls* on page 55 for more on this).
- Power on and off commands only work with components that have a standby mode.

## Programming a multi-operation or a shutdown sequence

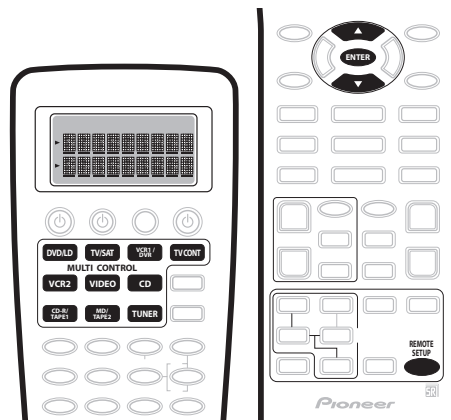

### 1 Press and hold **REMOTE SETUP** for three seconds.

The **REMOTE SETUP** menu appears on the remote control display.

### 2 Use **▲/▼** (cursor up/down) to select 'MultiOpe' or 'SysOff' from the menu and press **ENTER**.

If you selected *Multi Operation* (**MultiOpe**), **Select Function** flashes in the display.

If you selected *System Off* (**SysOff**), **System Off** appears in the display. Go to step 4.

### 3 Press the **MULTI CONTROL** button for the component you want to start the multi-operation. **Multi Ope** appears in the display.

#### 4 Use ▲/▼ (cursor up/down) to select a command in the sequence then press ENTER.

If this is the first command in the sequence, select **1st Cmmnd**. Otherwise, simply choose the next command in the sequence.

#### 5 To add (or change) a command select 'Change' and press ENTER.

**Function** flashes in the display.

- To erase a command select **Clear** and press **ENTER**. You will return to the last step.
- To go back a step, select **\*Exit\*** and press **ENTER**.

#### 6 Press the MULTI CONTROL button for the component whose command you want to input.

**Key** flashes in the display.

#### 7 Select the button for the command you want to input.

The following remote control commands can be selected:

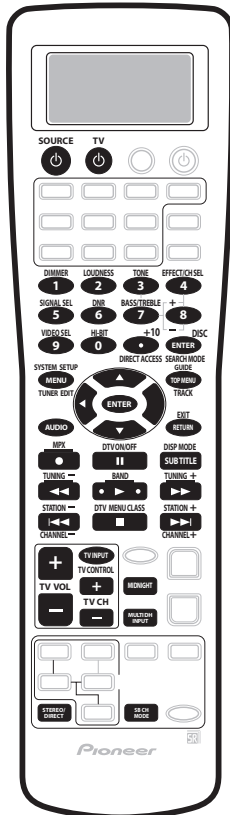

- After selecting a command, **COMPLETE** appears in the display.

#### 8 Repeat steps 4–7 to program a sequence of up to five commands.

- You don't need to program the receiver to switch on or off. This is done automatically.

With Pioneer components, you don't need to:

- program the power to switch off in a shutdown sequence;
- program the power to switch on if it's the source component selected in step 3;
- program a Pioneer TV or monitor to switch on if the input function (selected in step 2) has video input terminals;

These take priority in multi operations (not shutdown).

#### 9 When you're finished, use ▲/▼ (cursor up/down) to select '\*Exit\*' from the menu and press ENTER.

You will return to the **REMOTE SETUP** menu. Select **\*Exit\*** again to exit.

### Using multi operations

You can start multi operations with the receiver switched on, or in standby.



#### 1 Press MULTI OPERATION.

Select **Function** flashes in the display.

#### 2 Press a function button that has been set up with a multi operation.

The receiver switches on (if it was in standby) and the programmed multi operation is performed automatically.

### Using System off

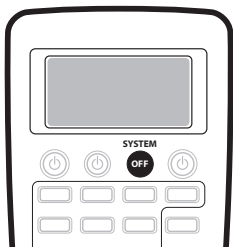

- Press **SYSTEM OFF**.

The command sequence you programmed will run, then all Pioneer components will switch off, followed by this receiver.

### Switching components on and off using the 12 volt trigger

You can connect components in your system (such as a screen or projector) to this receiver so that they switch on or off using a 12 volt trigger when you select an input function. However, you must specify which input functions switch on the trigger using the System Setup menu (see *12 Volt Trigger* on page 78 to do this). Note that this will only work with components that have a standby mode.

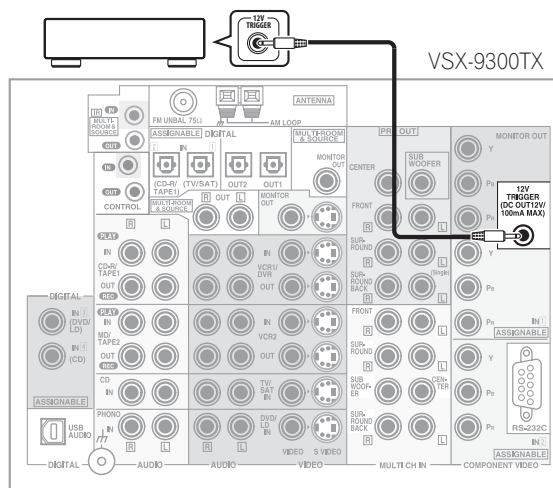

- Connect the **12V TRIGGER** jack of this receiver to the **12V TRIGGER** of another component.

Use a cable with a mono mini-plug on each end for the connection.

- The trigger maximum power is DC OUT 12V/100mA.

After you've specified the input functions that will switch on the trigger, you'll be able to switch the component on or off just by pressing the input function(s) you've set on page 78.

### Operating other Pioneer components with this unit's sensor

Many Pioneer components have **SR CONTROL** jacks which can be used to link components together so that you can use just the remote sensor of one component. When you use a remote control, the control signal is passed along the chain to the appropriate component.

#### Important

- Note that if you use this feature, *make sure that you also have at least one set of analog audio or video jacks connected* to another component for grounding purposes.

#### 1 Decide which component you want to use the remote sensor of.

When you want to control any component in the chain, this is the remote sensor at which you'll point the corresponding remote control.

#### 2 Connect the **CONTROL OUT** jack of that component to the **CONTROL IN** jack of another Pioneer component.

Use a cable with a mono mini-plug on each end for the connection.

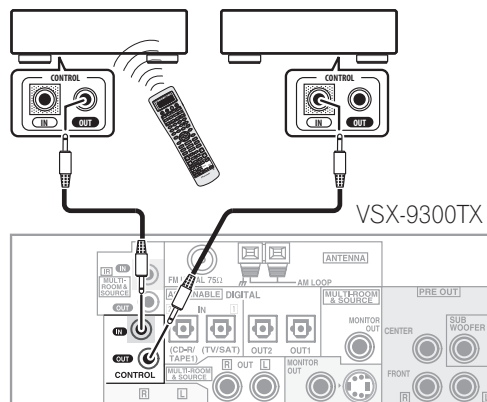

#### 3 Continue the chain in the same way for as many components as you have.

#### Note

- If you want to control all your components using this receiver's remote control, refer to *Using the remote control with other components* on page 54 and *Programming signals from other remote controls* on page 55.
- If you have connected a remote control to the **CONTROL IN** jack (using a mini-plug cable), you won't be able to control this unit using the remote sensor.

## Chapter 9

# Using other functions

### Making an audio or a video recording

You can make an audio or a video recording from the built-in tuner, or from an audio or video source connected to the receiver (such as a CD player or TV).

Keep in mind you can't make a digital recording from an analog source or vice-versa, so make sure the components you are recording to/from are hooked up in the same way (see *Connecting your equipment* on page 15 for more on connections).

Note that when recording video, you won't be able to record sources connected to the component video inputs. With composite and S-video sources, make sure they are connected using the same type of video cable as you used to connect the recorder to the receiver.

For more information about video connections, see *Connecting a VCR or DVD recorder* on page 22 and *Connecting other video sources* on page 23.

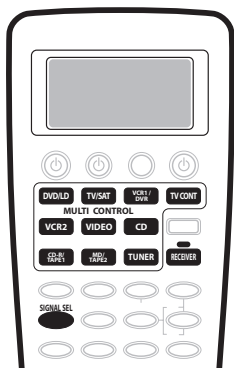

#### 1 Select the source you want to record.

Use the **MULTI CONTROL** buttons (or the **MULTI JOG** dial on the front panel).

#### 2 Select the input signal (if necessary).

Press **SIGNAL SEL** to select the input signal corresponding to the source component (see *Selecting the input signal type* on page 42 for more on this).

#### 3 Prepare the source you want to record.

Tune to the radio station, load the CD, video, DVD etc.

#### 4 Prepare the recorder.

Insert a blank tape, MD, video etc. into the recording device and set the recording levels.

Refer to the instructions that came with the recorder if you are unsure how to do this. Most video recorders set the audio recording level automatically—check the component's instruction manual if you're unsure.

#### 5 Start recording, then start playback of the source component.

#### Note

- The receiver's volume, tone (bass, treble, Midnight, Loudness), and surround effects have no effect on the recorded signal. (The exception to this is **PHONO**, which is best recorded using stereo **DIRECT**.)
- Some digital sources are copy-protected, and can only be recorded in analog.
- Some video sources are copy-protected. These cannot be recorded.

### Adjusting the delay of a soundtrack

- Default setting: **0.0 frame**

Some monitors have a slight delay when showing video, so the soundtrack will be slightly out of sync with the picture. By adding a bit of delay, you can adjust the sound to match the presentation of the video.

#### 1 Press RECEIVER.

#### 2 Press EFFECT/CH SEL repeatedly until DELAY shows in the display.

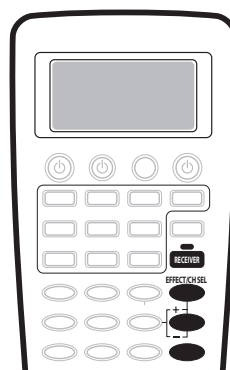

#### 3 Use the +/- buttons to adjust the amount of delay.

The delay can be adjusted from 0.0–6.0 frames (in 0.1 frame steps).

#### Note

- One second is equal to 30 frames of NTSC format.
- This setting is applied to all video sources.
- You can't use sound delay when **MULTI CH IN** or **DIRECT** is switched on.

## Watching video and audio sources independently

You can listen to a sound source and select a different video source on your TV.

- While listening to a source, press **RECEIVER**, then **VIDEO SEL** to select the video source you want to watch.

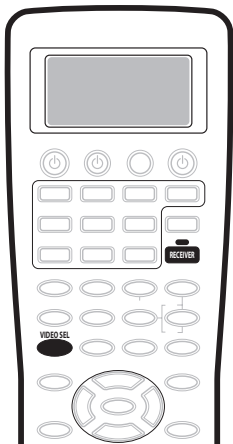

Press repeatedly to cycle through the possible video sources. You can select **DVD/LD**, **TV/SAT**, **VIDEO**, **VCR1/DVR**, **VCR2** or **OFF** (no video signal).

- Selecting any input besides those listed above is the same as selecting **OFF**.

### Note

- If you change the source using the **MULTI CONTROL** buttons (or the **MULTI JOG** dial on the front panel), or switch the power off, the system returns to normal playback.

## Dimming the display

You can choose between four brightness for the front panel display. Note that when selecting sources, the display automatically brightens for a few seconds.

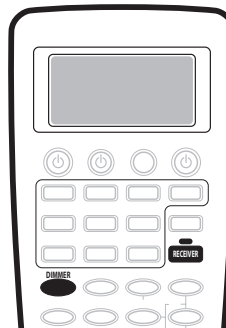

- 1 Press **RECEIVER**.
- 2 Press **DIMMER** repeatedly to change the brightness of the front panel display.

### Tip

- Switching the dimmer to lowest setting will also switch off the MCACC indicator.

## Switching the speaker impedance

- Default setting: **Speaker 8Ω**

You can use speakers with a nominal impedance between 6–16Ω but if you are using speakers with an impedance of less than 8Ω, you must change the impedance setting below.

- **With the receiver in standby, press  $\odot$  STANDBY/ON while holding down the SPEAKERS button.**

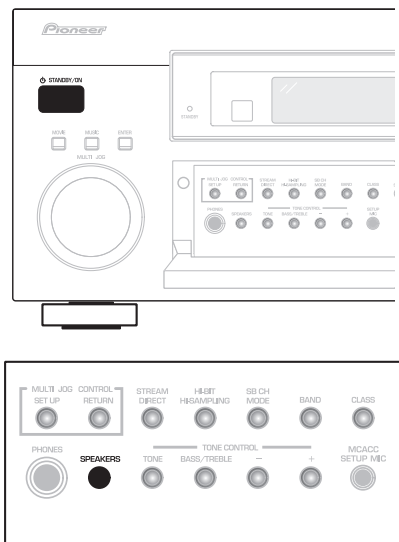

Each time you do this, you switch between the impedance settings:

- **Speaker 6Ω** – Use this setting if your speakers are rated lower than 8Ω (down to 6Ω).
- **Speaker 8Ω** – Use this setting if your speakers are rated 8Ω–16Ω.

## Advanced remote control features

### Note

- You can cancel or exit any of the following steps by pressing **REMOTE SETUP**.
- After one minute of inactivity, the remote goes to sleep. Press any button to reactivate the remote display and continue.

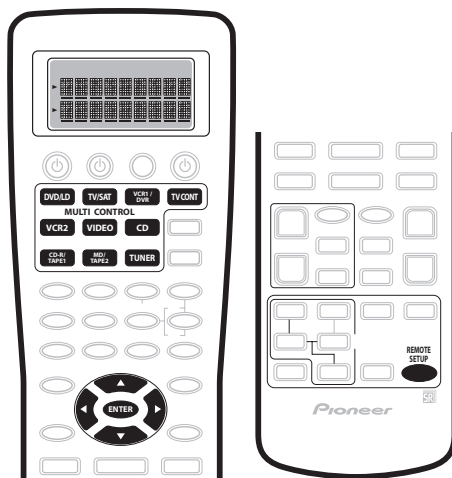

## Editing remote control display names

You can rename what appears in the display on the remote control for the **MULTI CONTROL** buttons (such as **DVD/LD** or **TV/SAT**), or for individual buttons for each input source. You may want to do this if the component connected to the inputs doesn't correspond to the **MULTI CONTROL** button name, or individual commands don't correspond to their respective buttons.

### 1 Press and hold **REMOTE SETUP** for three seconds.

The **REMOTE SETUP** menu appears in the remote control display.

### 2 Use $\blacktriangle$ / $\blacktriangledown$ (cursor up/down) to select 'FuncName' or 'Key Label' from the menu and press **ENTER**.

Select **Function Name (FuncName)** if you want to rename a **MULTI CONTROL** button.

Select **Key Label (KeyLabel)** if you want to rename a command button (you can rename individual command buttons for each input source).

**Select Function** flashes in the display.

### 3 Press the **MULTI CONTROL** button for the component.

If you selected **Function Name (FuncName)** above, go to step 5.

If you selected **Key Label (KeyLabel)** above, **Select Key** flashes in the display.





## Resetting the system

Use this feature to reset the system to its factory default settings.

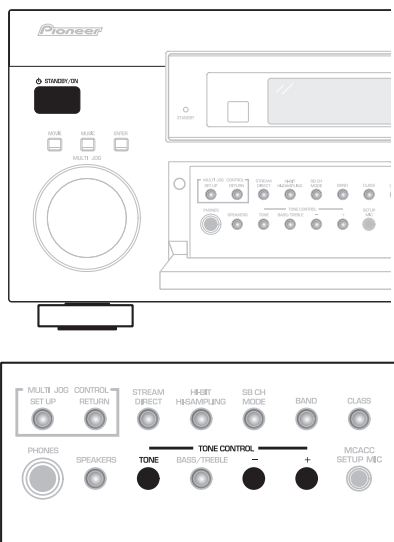

- 1 Switch the receiver into standby.**
- 2 While holding down the front panel TONE button, press and hold  STANDBY/ON for about three seconds.**  
The display shows **RESET?**.
- 3 Press the front panel TONE- button.**  
The display shows **OK?**.
- 4 Within 5 seconds, press TONE+.**  
The display shows **OK** and the receiver should now be reset.

### Note

- Make sure the multi-room feature is switched off when doing this.
- If the receiver is unplugged from the AC outlet for a month or more, it resets to the default settings.

## Chapter 10

# Other connections

### Caution

- Before making or changing the connections, switch off the power and disconnect the power cord from the power outlet. Plugging in components should be the last connection you make with your system.
- Be careful not to allow any contact between speaker wires from different terminals.
- You can use speakers with a nominal impedance between 6–16Ω (please see *Switching the speaker impedance* on page 64 if you plan to use speakers with an impedance of less than 8Ω).

### Second Zone speaker B setup

After selecting **Second Zone** in *Surround back speaker setting* on page 51, you can use the speakers connected to the (surround back) B speaker terminals on the rear panel to listen to stereo playback in another room. See *Switching the speaker system* below for the listening options with this setup.

#### 1 Connect a pair of speakers to the surround back speaker terminals on the rear panel.

Connect them the same way you connected your speakers in *Connecting the speakers* on page 29. Make sure to review *Placing the speakers* on page 29 when placing the speakers in another room.

#### 2 Select 'Second Zone' from the 'SurrBack System' menu.

See *Surround back speaker setting* on page 51 to do this.

### Note

- You can also use the multi-room feature to listen to stereo playback in another room. See *Multi-room listening* on page 69 for more on this.

### Switching the speaker system

If you selected **Second Zone** in *Surround back speaker setting* on page 51, three speaker system settings are possible using the **SPEAKERS** button. If you selected **Normal Surround**, the button will simply switch your main speaker system on or off. The options below are for the **Second Zone** setting only

- Use the **SPEAKERS** button on the front panel to select a speaker system setting.

As mentioned above, if you have selected **Normal Surround**, the button will simply switch your main speaker system (A) on or off.

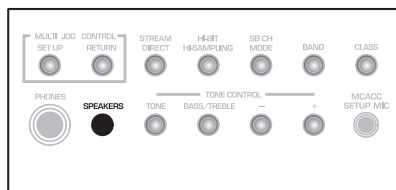

Press repeatedly to choose a speaker system option:

- **SP▶A** – Sound is output from speaker system A and the same signal is output from the pre-out terminals.
- **SP▶B** – Sound is output from the two speakers connected to speaker system B. Multichannel sources will not be heard.
- **SP▶AB** – Sound is output from speaker system A (up to 5 channels, depending on the source), the two speakers in speaker system B. The sound from speaker system B will be the same as the sound from speaker system A (multichannel sources will be downmixed to 2 channels).
- **SP▶** (off) – No sound is output from the speakers. The same sound is output from the pre-out terminals as when selecting speaker system A (above).

### Note

- The subwoofer output depends on the settings you made in *Normal surround setting* on page 51. However, if **SP▶B** is selected above, no sound is heard from the subwoofer (the LFE channel is not downmixed).
- Depending on the settings in *Normal surround setting* on page 51 and *Listening with Acoustic Calibration EQ* on page 41, output from the surround back pre-out terminals may change.
- Some sources (for example, when **MULTI CH IN** is selected) will not be downmixed.
- All speaker systems are switched off when headphones are connected.

## Bi-amping your front speakers

Bi-amping is when you connect the high frequency driver and low frequency driver of your speakers to different amplifiers (in this case, to both front and surround back terminals) for better crossover performance. Your speakers must be bi-ampable to do this (having separate terminals for high and low) and the sound improvement will depend on the kind of speakers you're using.

### 1 Connect your speakers as shown below.

This illustration below shows the connections for bi-amping your front left speaker. Hook up your front right speaker in the same way.

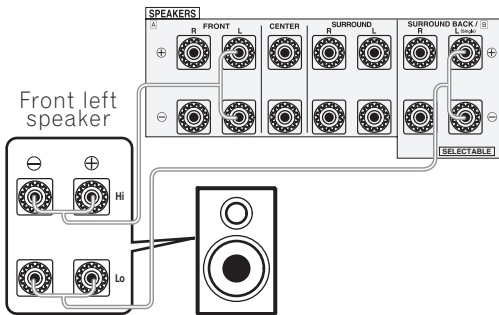

Since both front and surround back speaker terminals output the same audio, it doesn't matter which set (front or surround back) is powering which part (**Hi** or **Low**) of the speaker.

- Make sure that the + / - connections are properly inserted.

### 2 Select the 'Front Bi-Amp' setting from the 'SurrBack System' menu.

See *Surround back speaker setting* on page 51 to specify how you're using the surround back speaker terminals.

#### Caution

- Most speakers with both **Hi** and **Low** terminals have two metal plates that connect the **Hi** to the **Low** terminals. These must be removed when you are bi-amping the speakers or you could severely damage the amplifier. See your speaker manual for more information.
- If your speakers have a removable crossover network, make sure you do not remove it for bi-amping. Doing so may damage your speakers.

## Bi-wiring your speakers

The reasons for bi-wiring are basically the same as bi-amping, but additionally, interference effects within the wire could be reduced, producing better sound. Again, to do this your speakers must be bi-wireable (that is they must have separate terminals for the high and low frequencies). When bi-wiring, make sure you've selected **Normal Surround** in *Surround back speaker setting* on page 51.

### • To bi-wire a speaker, connect two speaker cords to the speaker terminal on the receiver.

Using a banana plug for the second connection is recommended.

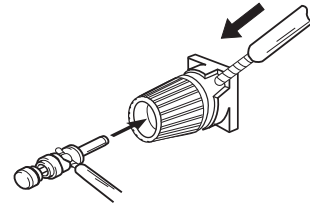

#### Caution

- Make sure you use a parallel (not series, which are fairly uncommon) connection when bi-wiring your speakers.
- Don't connect different speakers from the same terminal in this way.

## Multi-room listening

This receiver can power two independent systems in separate rooms after you have made the proper multi-room connections. Different sources can be playing in both rooms at the same time or, depending on your needs, the same source can also be used. The main and sub rooms have independent power (the main room power can be off while the sub room is on) and the sub room can be controlled by the front panel controls. However, you may need to specify the volume setting in *Multi-Room and IR receiver setup* on page 78.

## Making multi-room connections

It is possible to make these connections if you have a separate TV and speakers for your sub room. You will also need a separate amplifier if you are not using the SurrBack System setup (see below). There are two multi-room setups possible with this system:

### Basic multi-room setup

- Connect a separate amplifier to the **MULTI-ROOM & SOURCE OUT** jacks and a TV monitor to the **MULTI-ROOM & SOURCE MONITOR OUT** jacks, both on the rear of this receiver.

You should have a pair of speakers attached to the sub room amplifier as shown in the illustration below.

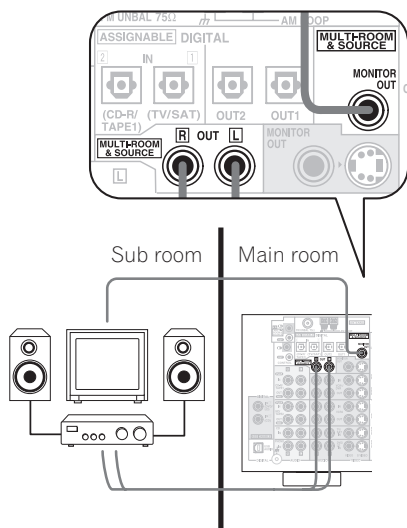

### SurrBack System multi-room setup

You must select **MR&S** in *Surround back speaker setting* on page 51 to use this setup. Note that the sound in the sub room will be temporarily interrupted when controlling the main room (for example, changing the input source or starting playback).

- Connect a TV monitor to the **MULTI-ROOM & SOURCE MONITOR OUT** jacks on the rear of this receiver.

You should have a pair of speakers attached to the surround back speaker terminals as shown in the illustration below.

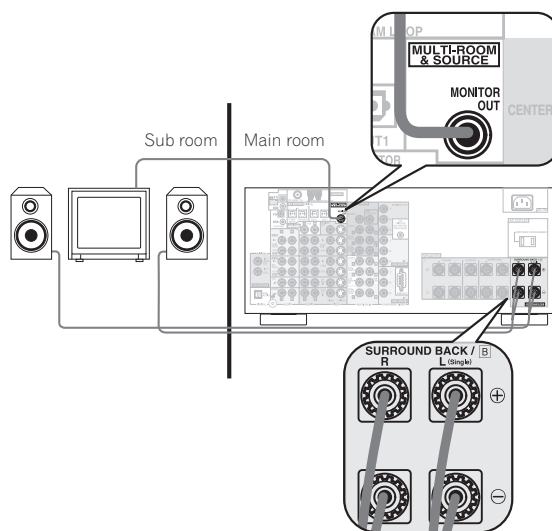

### Note

- It is not possible to hear the digital output of a component in the sub room. However, you can connect the analog outputs of your digital component into the receiver's (analog) input terminals to hear the component in the sub room.
- You can't use sound controls (such as the tone controls or Midnight listening) or any surround modes in the sub room. You can, however, use the features available with your sub room amplifier.

## Using the multi-room controls

You can use the front panel controls to adjust the sub room volume and select sources.

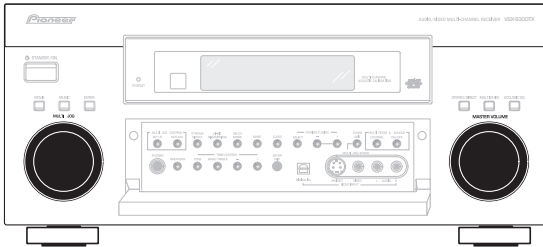
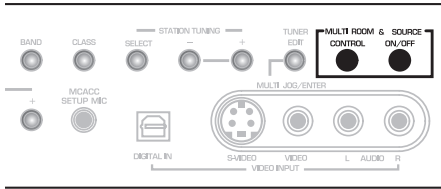

### 1 Press the **MULTI ROOM & SOURCE ON/OFF** button on the front panel.

The **MULTI ROOM** indicator lights and **MR&S ON** appears in the front panel display to indicate the multi-room control has been switched on.

### 2 Press **CONTROL**.

Make sure that any operations for the sub room are done while **MULTI-ROOM** shows in the display. If **MULTI-ROOM** is not showing, the front panel controls affect the main room only.

### 3 Use the **MULTI JOG** dial to select the source.

Select between **DVD/LD**, **TV/SAT**, **VCR 1/DVR**, **CD**, **CD-R/TAPE 1** or **TUNER** (in that order).

- If you select **TUNER**, you can use the front panel **TUNER** controls to select a preset station (see *Listening to memorized station presets* on page 49 if you're unsure how to do this).

### 4 Use the **MASTER VOLUME** dial to adjust the volume.

This is only possible if you selected the **VARIABLE** volume control in *Multi-Room and IR receiver setup* on page 78.

### 5 When you're finished, press **CONTROL** again to return to the main room controls.

You can also press the **MULTI ROOM & SOURCE ON/OFF** button on the front panel to switch off all output to the sub room.

#### Note

- Multi-room can't be used when you're setting up the system (from the on-screen **System Setup** menu).

- You won't be able to switch the main room off completely unless you've switched off the multi-room control first.
- The tuner cannot be tuned to more than one station at a time. Therefore, changing the station in one room also changes the station in the other room. Please be careful not to change stations when recording a radio broadcast.
- The volume levels of the main and sub rooms are independent.
- If you don't plan to use the multi-room feature for awhile, turn off the power in both the sub and main rooms. Make sure the **STANDBY** indicator turns red and the **MULTI-ROOM** indicator goes off.

### Connecting an IR receiver

If you keep your stereo components in a closed cabinet or shelving unit, you can use an optional IR receiver (such as a Niles or Xantech unit) to control your system instead of the remote sensor on the front panel of this receiver. You may need to specify your IR receiver type in *Multi-Room and IR receiver setup* on page 78.

**1 Connect the IR receiver sensor to the MULTI-ROOM & SOURCE IR IN jack on the rear of this receiver.**

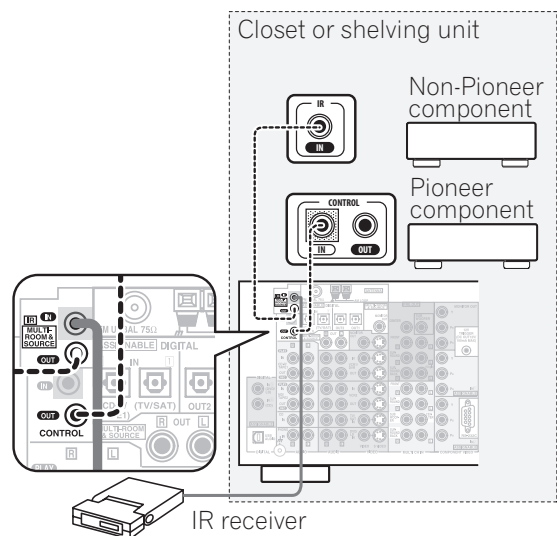

**2 Connect the IR IN jack of another component to the MULTI-ROOM & SOURCE IR OUT jack on the rear of this receiver to link it to the IR receiver.**

Please see the manual supplied with your IR receiver for the type of cable necessary for the connection.

- If you want to link a Pioneer component to the IR receiver, see *Operating other Pioneer components with this unit's sensor* on page 61 to connect to the **CONTROL** jacks instead of the **IR OUT** jack.

**Note**

- Remote operation may not be possible if direct light from a strong fluorescent lamp is shining on the IR receiver remote sensor window.
- Note that other manufacturers may not use the IR terminology. Refer to the manual that came with your component to check for IR compatibility.
- If using two remote controls (at the same time), the IR receiver's remote sensor takes priority over the remote sensor on the front panel.

### Connecting additional amplifiers

This receiver has more than enough power for any home use, but it's possible to add additional amplifiers to every channel of your system using the pre-outs. Make the connections shown below to add amplifiers to power your speakers.

**Note**

- Before making or changing the connections, switch off the power and disconnect the power cord from the AC outlet.

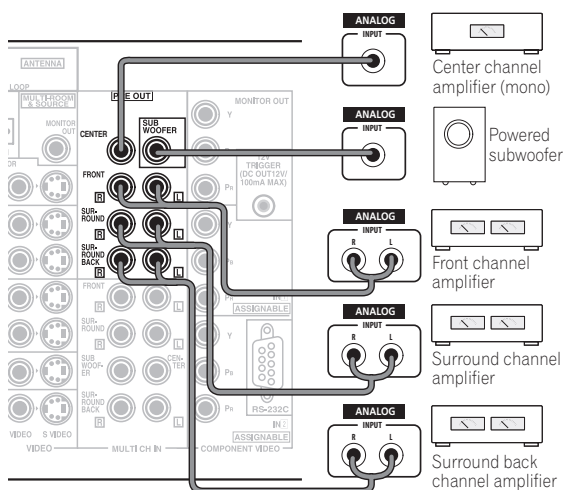

- You can use the additional amplifier on the surround back channel pre-outs for a single speaker as well. In this case plug the amplifier into the left **(L (Single))** terminal only.
- The sound from the surround back terminals will depend on how you have configured the *Surround back speaker setting* on page 51.

## Using the USB interface

It is possible to listen to two channels of audio from your computer by connecting to the USB interface on the rear of this receiver. Depending on your model of computer and the software installed, you can listen to the stereo audio source through the speaker setup you've connected to this receiver.

### 1 Connect your computer's USB terminal to the USB terminal on the rear panel of this receiver.

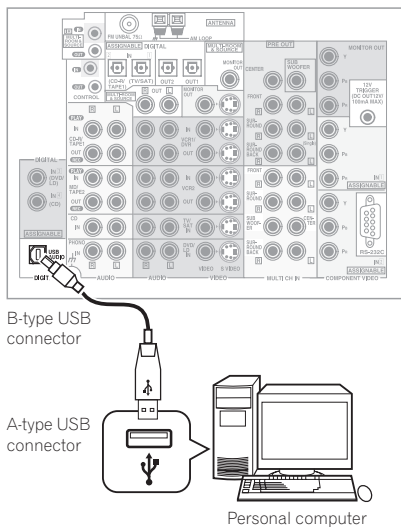

### 2 Switch on your computer and this receiver.

If the computer was previously running, quit all applications

### 3 If you're connecting for the first time, wait for the USB driver installation to finish.

The installation may take a minute or two to complete. Make sure you leave the USB cable connected until the dialog box indicates that the USB setup is finished. Note that some older operating systems may require a disc for installation.

- If your PC doesn't recognize the receiver, try disconnecting the USB cable and connecting it again. If it is still unrecognized, restart the computer.

### 4 Press INPUT on the remote control repeatedly to select USB.

You can also use the **MULTI JOG** dial on the front panel to select **USB**.

### 5 Make any necessary settings required to select the USB interface as your computer audio output.

### 6 Turn up the volume control on your computer and this receiver.

We recommend turning the computer volume to the maximum level and using the volume control on this receiver.

- You may want to start with a fairly low volume on this receiver and turn it up as necessary after you've checked your levels.

### 7 Start playback of a source on your computer.

#### Note

- Windows® XP, Windows® 2000, Windows® Millennium Edition and Windows® 98 operating systems have been tested for compatibility with this interface, but depending on your computer setup, you may find that your system is not compatible.
- Make sure you use a USB cable that connects from an A-type connector (from your PC) to a 4-pin B-type connector (to the receiver).
- Any computer alert sounds will also be heard through the speakers unless you switch them off from the computer's control panel.
- You won't be able to hear the audio from the USB connection through the digital outputs of this receiver.
- Note that using hubs or extensions may cause connection problems.
- The sound may be interrupted, degraded, or played back incorrectly due to your software, PC settings or PC specifications. Consult your PC manual regarding USB devices.

#### Caution

- Make sure you don't switch off the computer or unplug the USB cable during playback.
- To prevent noise being output, don't use other software on your computer during playback.
- Pioneer is not responsible for computer system damage, software crashes or failures, or any other possible computer problems due to this configuration.

*Microsoft Windows® XP, Windows® 2000, Windows® Millennium Edition, Windows® NT and Windows® 98 are registered trademarks of Microsoft Corporation, Inc.*



## Connecting a PC for Advanced MCACC output

If you use the Professional Acoustic Calibration (see page 84) to measure the reverb characteristics of your listening room, you can check the results graphically using a computer connected to this receiver. Use a commercially-available RS-232C cable to connect the RS-232C jack on your computer to the 9-pin RS-232C jack on the back panel of this receiver (the cable must be cross type, female–female).

To obtain the software to output the results, please register this unit online as instructed on the front cover of the manual. After registering, you will receive an email within a week, in which both the software and instruction manual will be available. If you have any questions regarding, please contact the Customer Support Division of Pioneer.

Please make sure your system meets the following requirements:

- Operating system must be Windows® XP, Windows® 2000, Windows® Millennium Edition, Windows® 98 Second Edition, or Windows® NT 4.0 (Service pack 6).
- CPU must be at least Pentium 3 / 300MHz or AMD K6 / 300MHz (or equivalent) with at least 128MB of memory, and your monitor must be able to display a minimum resolution of 800x600.
- An RS-232C port connector is necessary for graphical output. Refer to the operating instructions and/or the PC manufacturer for more information on making the proper port settings.
- System must have internet access.

### • Connect your computer to the RS-232C jack on the rear panel of the receiver.

Make sure that the receiver and all connected components are switched off and disconnected from the power outlet when you do this.

Use a commercially-available cable to connect the RS-232C jack on your computer to the 9-pin RS-232C jack on this receiver. See the documentation provided with the Advanced MCACC application for more information.

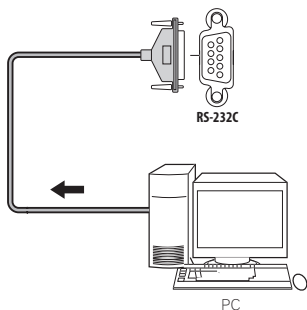

## Advanced MCACC output using your PC

Before continuing, make sure you have completed *Professional Acoustic Calibration* on page 84.

### 1 Select 'PC Output' and press ENTER.

When the receiver is ready for transmission, **Operate a PC** shows on the OSD.

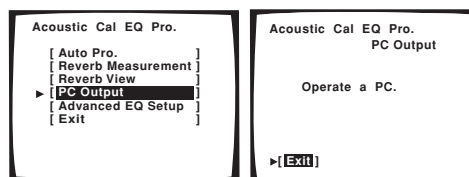

### 2 Start the MCACC application on your computer.

Follow the instructions provided with the application. It will take about ten seconds for the transmission to complete, then you will be able to analyze the output on your computer. Since the data will be cleared from the receiver when you restart reverb measurement, you might want to save the information on your PC after measurement.

### 3 When you're finished, select 'Exit' on the on-screen display.

You'll be taken to the Advanced EQ Setup. Depending on the results, you may want to continue with the Advanced EQ setup (see *Using Professional Acoustic Calibration* on page 85 for more on this). You can also simply press **Exit** again to exit the Professional Acoustic Calibration setup.

## Chapter 11

# Advanced setup

### The System Setup menu

The System Setup menu is where you can make customized settings to reflect how you are using the receiver.

#### 1 Switch on the receiver and your TV.

#### 2 Using the remote control, press RECEIVER, then press the SYSTEM SETUP button.

An on-screen display (OSD) appears on your TV. Use the ▲/▼ (cursor up/down) buttons and ENTER on the remote control to navigate through the screens and select menu items.

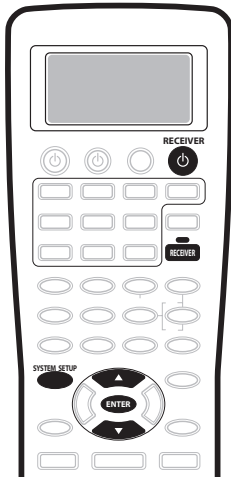

#### Tip

- You can also use the front panel display to make settings. You can also use the **MULTI JOG** dial and **ENTER** on the front panel instead of the ▲/▼ (cursor up/down) buttons and **ENTER** on the remote control.

#### 3 Select the setting you want to adjust then press ENTER.

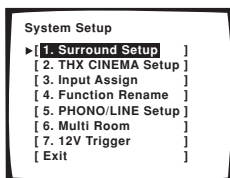

- Surround Setup** – Access the setup menu for basic surround sound settings (see *Making receiver settings from the Surround Setup menu* on page 50 for more on this).
- THX CINEMA Setup** – Select the decoding method used with the **THX CINEMA** mode (see *THX CINEMA Setup* below).
- Input Assign** – Specify what you've connected to the digital and component video inputs (see *The Input Assign menu* below).
- Function Rename** – Change the names that appear on the receiver display and on-screen display (see *Function Rename* on page 76).
- PHONO/LINE Setup** – Specify how you're using the **PHONO** jack on the rear of the receiver (see *PHONO/LINE Setup* on page 77).
- Multi Room** – Specify your volume setting for a multi-room setup and your IR receiver type (see *Multi-Room and IR receiver setup* on page 78).
- 12V Trigger** – Specify which components are switched on or off using the 12 volt trigger (see *12 Volt Trigger* on page 78).

#### 4 Make the adjustments necessary for each setting, pressing ENTER to confirm after each setting.

### THX CINEMA Setup

- Default setting: **PLII / PLIIX MOVIE**

If you want, you can choose which decoding method the receiver will use for 2-channel sources when you've selected the **THX CINEMA** mode (see *Listening in surround sound* on page 37 for details).

#### 1 Select 'THX CINEMA Setup' from the System Setup menu.

The current setting is highlighted on-screen:

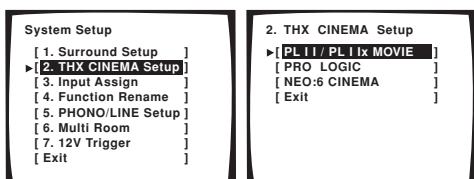

#### 2 Select the THX CINEMA decoding format you want.

For more on decoding formats see *Surround sound formats* on page 95.

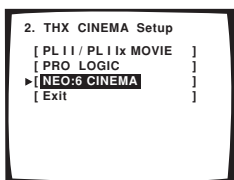

- Pro Logic II /  Pro Logic IIX MOVIE
- Pro Logic
- Neo:6 CINEMA

#### 3 When you're finished, select 'Exit'.

You will return to the System Setup menu.

### The Input Assign menu

You only need to make settings in the Input Assign menu if you didn't hook up your digital equipment according to the default settings for the digital inputs, or if you have connected equipment using component video cables.

- **Select 'Input Assign' from the System Setup menu.**

The Input Assign menu appears on screen:

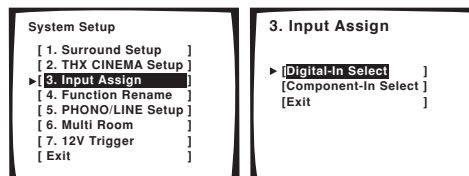

#### Assigning the digital inputs

- Default settings:

**Digital-1** (optical) – TV/SAT

**Digital-2** (optical) – CD-R

**Digital-3** (coaxial) – DVD/LD

**Digital-4** (coaxial) – CD

You only need to do this if you didn't hook up your digital equipment according to the default settings for the digital inputs (see above). This setting tells the receiver what digital equipment is hooked up to which terminal so the buttons on the remote correspond to what you have hooked up.

#### 1 Select 'Digital-In Select' from the Input Assign menu.

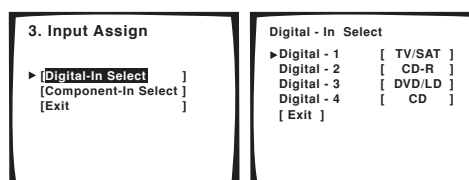

#### 2 Select the number of the digital input to which you've connected your digital component.

The numbers correspond with the numbers beside the inputs on the back of the receiver.

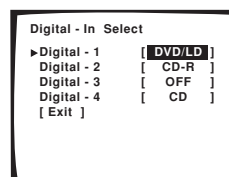

### 3 Select the component that corresponds with the one you connected to that input

Select between **DVD/LD**, **TV/SAT**, **VCR1**, **VCR 2**, **CD**, **CD-R** or **MD**.

- Use the ▲/▼ (cursor up/down) buttons and **ENTER** to do this.
- If you assign a digital input to a certain function (for example, **DVD/LD**) then any digital inputs previously assigned to that function will automatically be switched off.

### 4 When you're finished, select 'Exit'.

You will return to the Input Assign menu.

### Assigning the component video inputs

- Default settings:

**Component-1 – OFF**

**Component-2 – OFF**

If you used component video cables to connect your video equipment you must tell the receiver which device it is, or else you may see the S-video or composite video input instead of the component video signal.

### 1 Select 'Component-In Select' from the Input Assign menu.

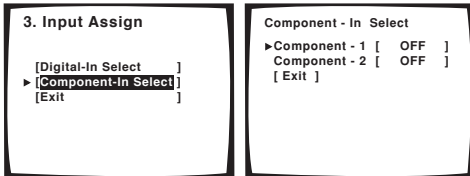

### 2 Select the number of the component video input to which you've connected your video component.

The numbers correspond with the numbers beside the inputs on the back of the receiver.

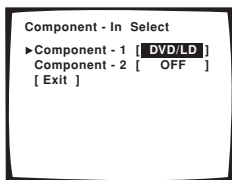

### 3 Select the component that corresponds with the one you connected to that input.

- Use the ▲/▼ (cursor up/down) buttons and **ENTER** to do this.
- If you connect any source component to the receiver using a component video input, you should also have your TV connected to this receiver's component video **MONITOR** output.

### 4 When you're finished, select 'Exit'.

You will return to the Input Assign menu.

### Function Rename

You can customize the names that appears on the display when you select an input source (for example, you could change the name of **VCR1/DVR** to **DVR-310**).



#### Tip

- It's convenient to use the front panel controls when editing names. However, if you want to use the remote, you can press and hold ▲/▼ to change characters quickly.

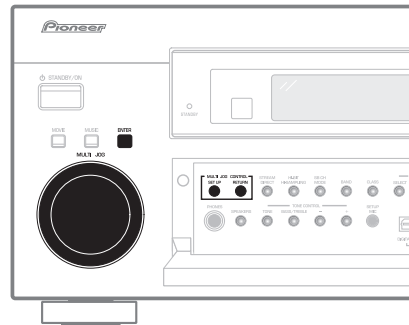

### 1 Select 'Function Rename' from the System Setup menu.

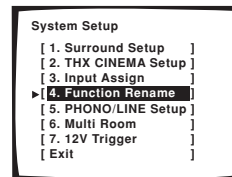

### 2 Select the name of the input you want to rename.

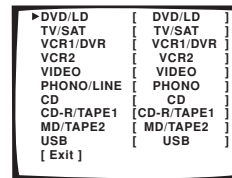

### 3 Edit the name as necessary, then press ENTER repeatedly to set the name and move to the following line.

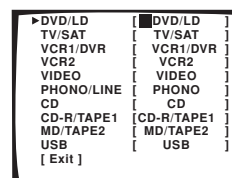

Use the front panel **MULTI JOG** dial (or ▲/▼ on the remote) to change the character and **ENTER** to move forward a position. If you want to change a character you input, you can press **RETURN** to go back one position.

The name can be up to ten characters (the possible characters are listed below).

ABCDEFGHIJKLMNOPQRSTUVWXYZ

abcdefghijklmnopqrstuvwxyz

0123456789

!"#\$%&'()\*+,-./:;<=>?@[ \ ]^\_{ } (space)

#### 4 Select another name to edit, or select 'Exit' from the bottom of the list if you're done.

If you've selected another name, repeat step 3, otherwise you'll return to the System Setup menu.

### PHONO/LINE Setup

- Default setting: **PHONO**

You can choose whether you want to use the **PHONO** jack on the rear of the receiver to connect a turntable, or a line level component (such as a CD or DVD player).

#### 1 Select 'PHONO/LINE Setup' from the System Setup menu.

The current setting is highlighted in the display.

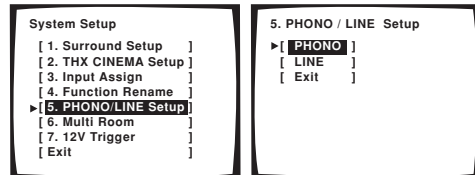

#### 2 Select either PHONO or LINE.

- **PHONO** – High level setting for turntables (without a built-in equalizer or pre-amplifier)
- **LINE** – Line level setting for all audio components other than a turntable (except those with a built-in phono equalizer)

#### 3 When you're finished, select 'Exit'.

You will return to the System Setup menu.

## Multi-Room and IR receiver setup

- Default setting: **VARIABLE** / Setting 1

If you've made multi-room connections (see *Multi-room listening* on page 69) you may need to specify your volume setting. Also use this menu to specify your IR receiver type (if necessary).

### 1 Select 'Multi-Room' from the System Setup menu.

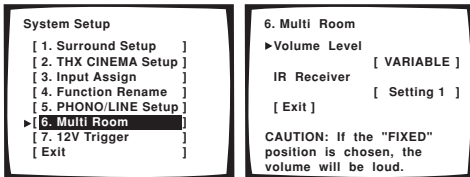

### 2 Select the volume level setting.

- **VARIABLE** – Use this setting if you've connected a power amplifier in the sub room (this receiver is simply being used as a pre-amp) and you will be using this receiver's controls to adjust the volume.
- **FIXED** – Use this setting if you've connected a fully integrated amplifier (such as another Pioneer VSX receiver) in the sub room and want to use that receiver's volume controls.

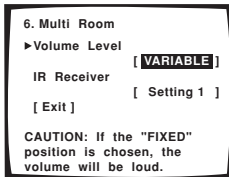

With the **FIXED** setting, the source is sent from this receiver at maximum volume, so make sure the volume is quite low in the sub room at first and then experiment to find the correct level.

### 3 Select the type of IR receiver you're using.

- **Setting 1** – Use this setting for all (other) IR receivers.
- **Setting 2** – Use this setting if the IR receiver you're using doesn't seem to work after selecting **Setting 1**.

### 4 When you're finished, select 'Exit' and press ENTER.

You will return to the System Setup menu.

#### Note

- Some IR receivers may not work with this receiver. Check with your audio dealer for more information.
- If you selected **MR&S** in the *Surround back speaker setting* on page 51, you won't be able to change the volume level.

## 12 Volt Trigger

- Default setting: **OFF** (all components)

After connecting a component the 12 volt trigger (see *Switching components on and off using the 12 volt trigger* on page 61), it switches on automatically when you select an input function set to switch the trigger on. Specify which input functions switch on the trigger below.

### 1 Select '12V Trigger' from the System Setup menu.

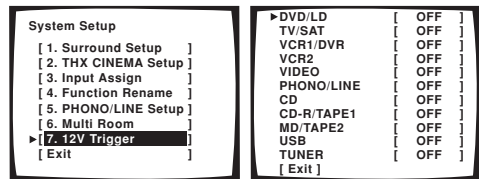

### 2 Select an input function and choose the setting that you want.

This should be the input function, that when selected, switches on the 12 volt trigger.

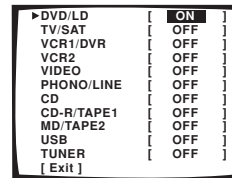

- **OFF** – 12 volt trigger is not activated for the selected component.
- **ON** – 12 volt trigger is activated for the selected component.

### 3 Repeat for as many input functions as you would like to set.

### 4 When you're finished, select 'Exit'.

You will return to the System Setup menu.

## The Expert setup menu

The settings in the Expert setup menu are more advanced features of this receiver that you can use to make detailed adjustments when you're more familiar with the system. Before making these settings, you should have already completed *Automatically setting up for surround sound* on page 12.

You only need to make these settings once (unless you change the placement of your current speaker system or add new speakers).

**1 Make sure your receiver and TV are both switched on.**

**2 Using the remote control, press RECEIVER, then press the SYSTEM SETUP button.**

An on-screen display (OSD) appears on your TV. Use the ▲/▼ (cursor up/down) buttons and ENTER on the remote control to navigate through the screens and select menu items.

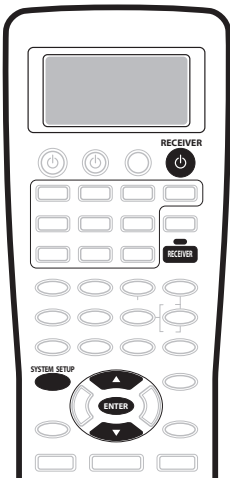

### Tip

- You can also use the front panel display to make settings. You can also use the **MULTI JOG** dial and **ENTER** on the front panel instead of the ▲/▼ (cursor up/down) buttons and **ENTER** on the remote control.

**3 Select 'Surround Setup' then press ENTER.**

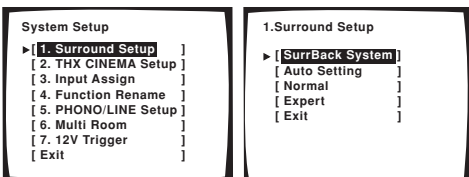

**4 Select 'Expert' then press ENTER.**

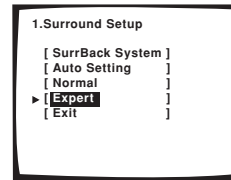

**5 Select the setting you want to adjust.**

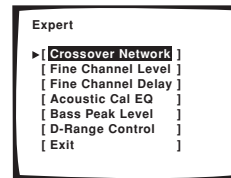

- Crossover Network**– Specify which frequencies will be sent to the subwoofer (see *Crossover Network* below).
- Fine Channel Level** – Make fine adjustments to the overall balance of your speaker system (see *Fine Channel Level* below).
- Fine Channel Delay**– Make precise delay settings for your speaker system (see *Fine Channel Delay* on page 81).
- Acoustic Cal EQ** – Measure the acoustic characteristics of your room and make detailed adjustments to the frequency balance of your speaker system (see *Acoustic Calibration EQ* on page 81 and *Professional Acoustic Calibration* on page 84).
- Bass Peak Level** – Prevent bass tones from distorting the sound from your speakers (see *Bass Peak Level* on page 86).
- D-Range Control** – Specify the amount of dynamic range adjustment to Dolby Digital and DTS movie soundtracks (see *Dynamic Range Control* on page 87).

**6 Make the adjustments necessary for each setting, pressing ENTER to confirm after each setting.**

When you're finished, you can select **Exit**, then press **ENTER** to go back to the System Setup menu.

## Crossover Network

- Default setting: **80Hz**

This setting decides the cutoff between bass sounds playing back from the speakers selected as **LARGE**, or the subwoofer, and bass sounds playing back from those selected as **SMALL**. It also decides where the cutoff will be for bass sounds in the LFE channel.

### Note

- For more on selecting the speaker sizes, see *Normal surround setting* on page 51.
- You don't need to set the crossover frequency if all speakers are set to **LARGE**.

### 1 Select 'Crossover Network' from the Expert setup menu.

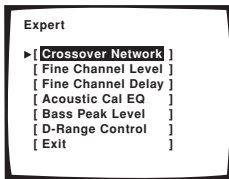

### 2 Choose the frequency cutoff point.

Frequencies below the cutoff point will be sent to the subwoofer (or **LARGE** speakers).

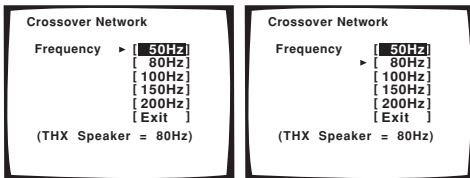

### 3 When you're finished, select 'Exit'.

You will return to the Expert setup menu.

## Fine Channel Level

- Default setting: **0dB** (all channels)

You can achieve better surround sound by properly adjusting the overall balance of your speaker system. The following setting can help you make detailed adjustments that you may not achieve using the *Normal surround setting* on page 51.

### 1 Select 'Fine Channel Level' from the Expert setup menu.

The volume increases to the **0dB** reference level.

### Caution

- After pressing **ENTER**, loud test tones will be output.

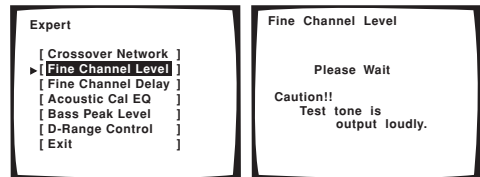

### 2 Adjust the level of the left channel.

This will be the reference speaker level, so you may want to keep the level around **0dB** so that you'll have plenty of room to adjust the other speaker levels.

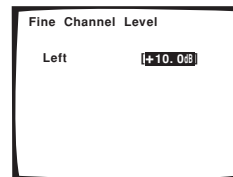

### 3 Select each channel in turn and adjust the levels (+/- 10dB) as necessary.

Use **▲/▼** (cursor up/down) to adjust the volume of the speaker you selected to match the front left (reference) speaker. When it sounds like both tones are the same volume, press **ENTER** to confirm and continue to the next channel.

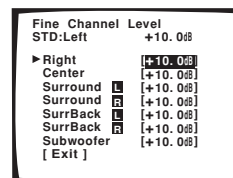

- If you want to go back and adjust a channel, simply use **▲/▼** (cursor up/down) to select it.

### 4 When you're finished, select 'Exit'.

You will return to the Expert setup menu.



### Fine Channel Delay

For proper sound depth and separation with your system, it is necessary to add a slight bit of delay to some speakers so that all sounds will arrive at the listening position at the same time. The following setting can help you make detailed adjustments that you may not achieve using the *Normal surround setting* on page 51.

**1 Select 'Fine Channel Delay' from the Expert setup menu.**

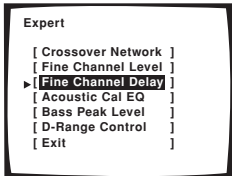

**2 Adjust the distance of the left channel from the listening position.**

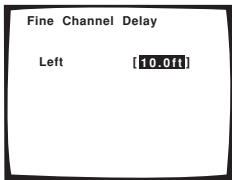

**3 Select each channel in turn and adjust the distance as necessary.**

Use ▲/▼ (cursor up/down) to adjust the delay of the speaker you selected to match the front left (reference) speaker. The delay is measured in terms of speaker distance from **0.5 to 45** feet.

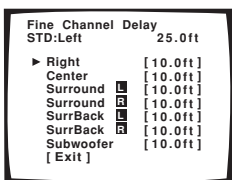

Listen to the reference speaker and use it to measure the target channel. Face the two speakers with your arms outstretched pointing at each speaker. Try to make the two tones sound as if they are arriving simultaneously at a position slightly in front of you and between your arm span.

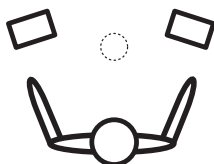

When it sounds like the delay settings are matched up, press **ENTER** to confirm and continue to the next channel.

- If you want to go back and adjust a channel, simply use ▲/▼ (cursor up/down) to select it.

**4 When you're finished, select 'Exit'.**

You will return to the Expert setup menu.

### Acoustic Calibration EQ

Acoustic Calibration Equalization is a kind of room equalizer for your speakers (excluding the subwoofer). It works by measuring the acoustic characteristics of your room and neutralizing the ambient characteristics that can color the original source material. You can also make these settings manually to get a frequency balance that suits your tastes. A more advanced setup is also available, where you can make detailed settings according to your room's reverb characteristics (see *Professional Acoustic Calibration* on page 84). You should have the mic connected when using any of the setup options.

#### Setting the Acoustic Calibration EQ automatically

If you have already completed *Automatically setting up for surround sound* on page 12, **ALL CH ADJUST** and **FRONT ALIGN** (below) should already be set. Therefore, if you want to adjust your settings manually, you can skip to *Setting the Acoustic Calibration EQ manually* below.

**1 Select 'Acoustic Cal EQ' from the Expert setup menu.**

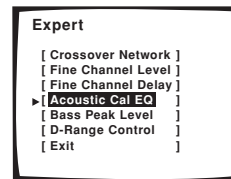

**2 Select 'EQ AUTO SETTING' then select 'Start'.**

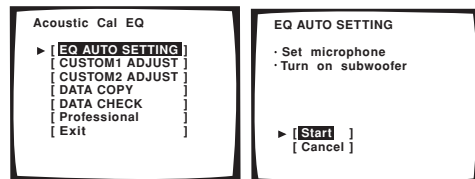

As the receiver outputs test tones, the frequency balance is adjusted automatically for the following settings:

- **ALL CH ADJUST** – All the speakers are set individually so no special weighting is given to any one channel.
- **FRONT ALIGN** – All speakers are set in accordance with the front speaker settings.

**!! Complete !!** is displayed on-screen after the Acoustic Calibration Equalization is set. If you want to check the settings, select **Check**. Select **Next** after you have finished checking each screen.

- If you want to copy these settings and adjust them manually, select **Data Copy**. Go to step 3 of *Copying your Acoustic Calibration EQ settings* below.

### 3 When you're finished, select 'Exit'.

You will return to the Acoustic Cal EQ setup menu.

### Setting the Acoustic Calibration EQ manually

Before manually adjusting the Acoustic Calibration EQ, we recommend copying the **ALL CH ADJUST** or the **FRONT ALIGN** settings from the auto setup above (or from *Automatically setting up for surround sound* on page 12) to one of the custom settings. Instead of just a flat EQ curve, this will give you a reference point from which to start (see *Copying your Acoustic Calibration EQ settings* below for how to do this).

#### 1 Select 'Acoustic Cal EQ' from the Expert setup menu.

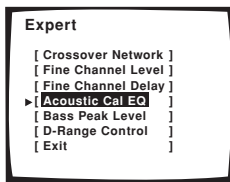

#### 2 Select CUSTOM1 ADJUST or CUSTOM2 ADJUST.

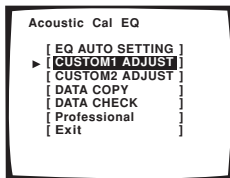

#### 3 Select which method you would like to use to adjust the overall frequency balance.

It is best to choose whichever one you copied to the custom setting in *Copying your Acoustic Calibration EQ settings* below.

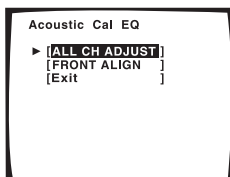

- ALL CH ADJUST** – All the speakers can be set independently so no special weighting is given to any one channel. When adjusting, test tones will sound for each individual channel.

- FRONT ALIGN** – Speakers are set in accordance with the front speaker settings. The sound of the test tone will alternate between the left front (reference) speaker and the target speaker.

#### 4 Select the channel(s) you want and adjust to your liking.

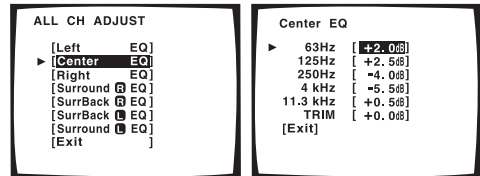

Use the ▲/▼ (cursor up/down) buttons to select the channel (and **ENTER** to select it).

Use the ▲/▼ (cursor up/down) buttons to select the frequency and ▲/▼ (cursor up/down) to boost or cut the EQ. When you're finished, the cursor automatically moves to the next channel after you press **ENTER**.

- The front speakers can't be adjusted if you selected **FRONT ALIGN**.

#### Tip

- Changing the frequency curve of one channel too drastically will affect the overall balance. If the speaker balance seems uneven, you can raise or lower channel levels using test tones with the **TRIM** feature. Use ▲/▼ (cursor up/down) to raise or lower the channel level for the current speaker.

#### 5 When you're finished, select 'Exit'.

Select **Exit** again to confirm your custom settings and return to the Acoustic Cal EQ setup menu.

#### Note

- Note that five bands are available for adjustment here, however six bands are measured and displayed with the *Professional Acoustic Calibration* on page 84 (including the PC graphical output feature). The 1kHz band acts as a reference setting (to ensure optimal adjustment of the other frequency settings) for a total of six band adjustment.

### Copying your Acoustic Calibration EQ settings

If you want to manually adjust the Acoustic Calibration EQ (see *Setting the Acoustic Calibration EQ manually* above), we recommend copying the **ALL CH ADJUST** or the **FRONT ALIGN** settings from the **Auto** setup above (or from *Automatically setting up for surround sound* on page 12) to one of the custom settings. Instead of just a flat EQ curve, this will give you a reference point from which to start.

1 Select 'Acoustic Cal EQ' from the Expert setup menu.

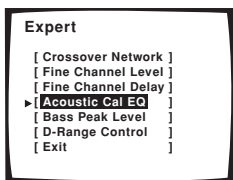

2 Select 'DATA COPY' then press ENTER.

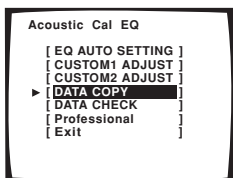

3 Select CUSTOM1 or CUSTOM2 then use the ▲/▼ (cursor up/down) buttons to select the setting you want to copy.

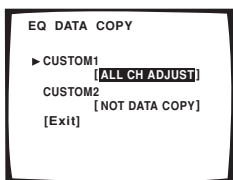

- You can also copy from one custom setting to another. For more on the **ALL CH ADJUST** and **FRONT ALIGN** settings, see *Setting the Acoustic Calibration EQ automatically* above.

4 Select 'Exit' to copy and confirm.

You will return to the Acoustic Cal EQ setup menu.

### Checking your Acoustic Calibration EQ settings

If you want to manually adjust the Acoustic Calibration EQ (see *Setting the Acoustic Calibration EQ manually* above), we recommend copying the **ALL CH ADJUST** or the **FRONT ALIGN** settings from the **Auto** setup above (or from *Automatically setting up for surround sound* on page 12) to one of the custom settings. Instead of just a flat EQ curve, this will give you a reference point from which to start.

1 Select 'Acoustic Cal EQ' from the Expert setup menu.

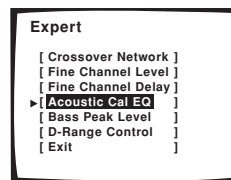

2 Select 'DATA CHECK' then press ENTER.

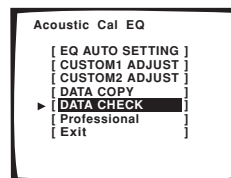

3 Select the setting you want to check.

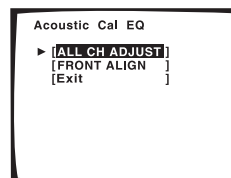

4 Select the channels you want, selecting 'Exit' when you're finished checking each one.

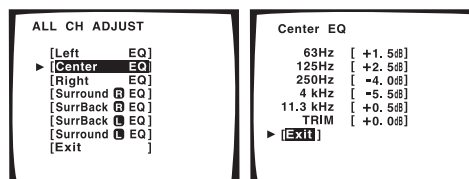

5 When you're finished, select 'Exit'.

You will return to the Acoustic Cal EQ setup menu.

### Professional Acoustic Calibration

This setup minimizes the unwanted effects of room reverberation by calibrating your system based on the direct sound coming from the speakers. It can also provide you with a graphical output of the frequency response of your room.

#### Note

- Before setting up with Professional Acoustic Calibration, you should finish calibrating using the Auto Surround Setup on page 12.

### How to use Professional Acoustic Calibration

If you find that lower frequencies seem overly reverberant in your listening room (i.e. it sounds 'boomy'), or that different channels seem to exhibit different reverb characteristics, use the Auto Pro setup to calibrate the room automatically. This should provide a more balanced calibration than simply using the standard Acoustic Calibration EQ.

If you still aren't satisfied with the results, the manual Advanced EQ Setup allows you to customize your system calibration with the help of a graphical output that can be displayed on-screen, or using a computer (with software available from Pioneer—see *Connecting a PC for Advanced MCACC output* on page 73 for more on this).

### How to interpret the graphical output

The graph shows decibels on the vertical axis and time (in milliseconds) on the horizontal axis. A straight line indicates a flat-response room (no reverb), whereas a sloping line indicates the presence of reverberation when outputting test tones. The sloping line will eventually flatten out when the reverberant sound stabilizes (this usually takes about 100ms or so).

By analyzing the graph, you should be able to see how your room is responding to certain frequencies. Differences in channel level and speaker distance are taken into account automatically (compensation is provided for comparison purposes), but the frequency measurements are always shown without the equalization performed by this receiver.

Note that due to an effect known as 'group delay', lower frequencies will take longer to be generated than higher frequencies (this is most obvious when comparing the frequencies at 0ms). This initial slope is not a problem (i.e. excessive reverb) with your listening room.

### Setting Professional Acoustic Calibration according to your room characteristics

Using the manual setup, you can set the time period at which the frequency response is analyzed for calibration. You can pinpoint the time that is best for calibration of the system for your particular room characteristics.

The graph below shows the difference between standard acoustic calibration and professional calibration (the gray circles represent the point at which the microphone captures the sound for frequency analysis).

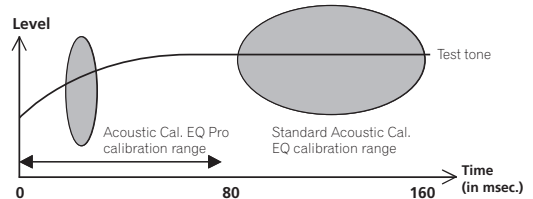

As soon as audio is output from your speaker system, it is influenced by room characteristics, such as walls, furniture, and the dimensions of the room. The sooner the frequency analysis, the less it is influenced by the room. We recommend an earlier time setting of 20–40ms to compensate for two major factors that will influence the sound of most rooms:

- **Reverberance of high vs. low frequencies** – Depending on your room, you may find that lower frequencies seem overly reverberant compared to higher frequencies (i.e. your room sounds 'boomy'). This may result in a skewed frequency analysis if the measurement is done too late.

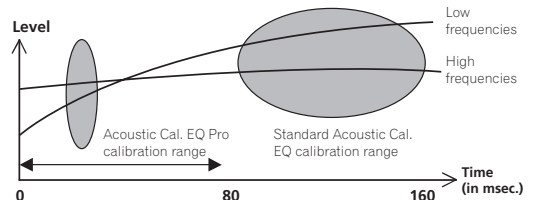

- **Reverb characteristics for different channels** – Reverb characteristics can be somewhat different for each channel. Since this difference increases as the sound is influenced by the various room characteristics, it is often better to capture a frequency analysis early on for smoother mixing of channel frequencies/sounds.

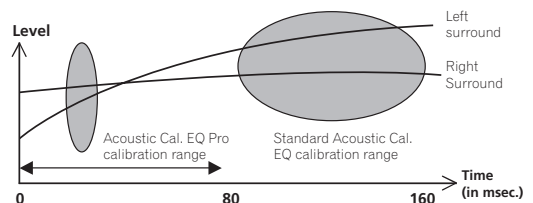

If your room isn't affected by the factors above, it is often not necessary to make a 20–40ms setting. Later time settings may provide a more detailed sound experience with your speaker system. It is best to try and see what works best for your particular room.

Note that changing the room (for example, moving furniture or paintings) will affect the calibration results. In such cases, you should recalibrate your system.

## Using Professional Acoustic Calibration

### 1 Select 'Acoustic Cal EQ' from the Expert setup menu.

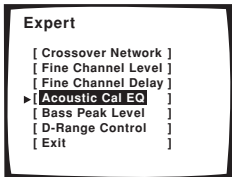

### 2 Select 'Professional'.

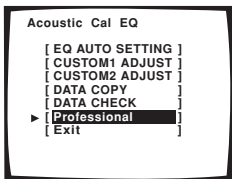

### 3 Select a setup option.

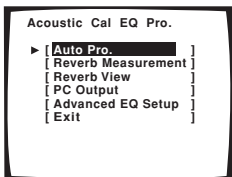

- **Auto Pro.** – This is the recommended setup when using the Professional Acoustic Calibration. If you feel confident with a setup that's more involved, you can use an advanced setup below. With this setup, the receiver automatically sets an early time period (20–40 ms or 60–80 ms) for reverb measurement, giving you a system calibration based on the direct sound coming from the speakers. The frequency balance for each channel is then adjusted to minimize the effect of the room characteristics on the overall sound.
- **Reverb Measurement** – Use this to measure the reverb characteristics of your room for each channel in select frequency ranges. Since this measurement is also made in **Auto Pro** (above), there is no need to do this again if you were satisfied with the results.
- **Reverb View** – You can check the reverb measurements made for specified frequency ranges in each channel.
- **PC Output** – See *Connecting a PC for Advanced MCACC output* on page 73 for more on this option.

- **Advanced EQ Setup** – Use this to select the time period that will be used for frequency adjustment and calibration, based on the reverb measurement of your listening area. Note that this advanced setup is not necessary if you're satisfied with the results of *Automatically setting up for surround sound* on page 12 or **Auto Pro** above (your previous settings will be altered with this setup).

### 4 If you selected 'Auto Pro.', select 'Start' and press ENTER.

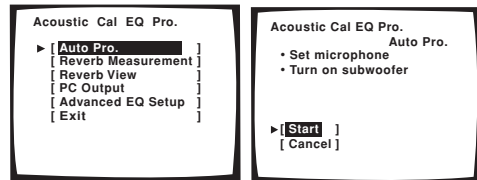

**!! Complete !!** is displayed on-screen after the Acoustic Calibration Equalization is set. Select **Exit** to return to the Professional Acoustic Calibration menu.

### 5 If you selected 'Reverb Measurement', select 'Start' and press ENTER.

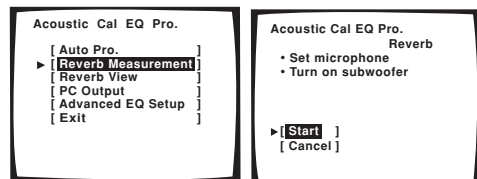

**!! Complete !!** is displayed on screen when the reverb measurement is finished (this may take 2–6 minutes). After selecting **Exit**, you can select **Reverb View** to see the results on-screen. See *Connecting a PC for Advanced MCACC output* on page 73 for more on setting up your computer for the graphical output.

### 6 If you selected 'Reverb View', you can use the cursor buttons (buttons) to check the reverb characteristics for each channel. Select 'Exit' when you're done.

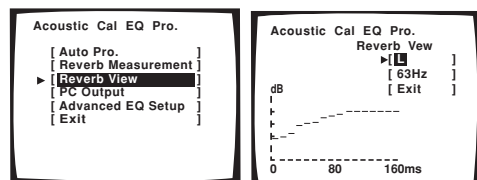

Use the **▲/▼** (cursor up/down) buttons (and **ENTER**) to select the channel and the frequency you want to check. Note that the markers on the vertical axis indicate decibels in 2dB steps.

- If **No Data** is displayed, you will need to make a reverb measurement using the Auto Pro or Reverb Measurement setup option.

### 7 If you selected 'Advanced EQ Setup', input the time setting you want to use for calibration, then select 'Start'.

After checking on the reverb measurement above, you may want to manually choose the time period that will be used for the final frequency adjustment and calibration. Even though you can make this setting without reverb measurement, it is best to use the measurement results as a reference for your time setting. For an optimal system calibration based on the direct sound coming from the speakers, we recommend using the **20–40ms** setting.

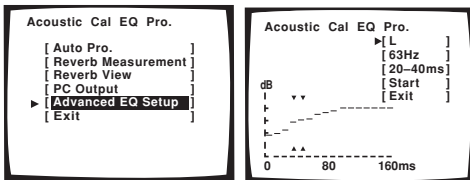

- If **No Data** is displayed, you will need to make a reverb measurement using the Auto Pro or Reverb Measurement setup option.

Use the ▲/▼ (cursor up/down) buttons to select the channel, frequency, and time setting. Use the ▲/▼ (cursor up/down) buttons to switch between them.

You can switch between your connected speakers (excluding the subwoofer), and display the measurements for the following frequencies: 63Hz, 125 Hz, 250Hz, 1kHz, 4kHz and 11.3kHz.

- Note that six bands are available for measurement and analysis here, but you will only be able to set five bands when using *Acoustic Calibration EQ* on page 81. The 1kHz band acts as a reference setting (to ensure optimal adjustment of the other frequency settings) for a total of six band adjustment.

Select the setting from the following time periods (in milliseconds): 0–20ms, 10–30ms, 20–40ms, 30–50ms, 40–60ms, 50–70ms and 60–80ms. This setting will be applied to all channels during calibration.

When you're finished, select **Start**. It will take about 2–11 minutes for the calibration to finish.

**!! Complete !!** is displayed on-screen after the Acoustic Calibration Equalization is set. If you want to check the settings, select **Check** and press **ENTER**. If you want to finish, select **Exit** to exit each screen.

## Bass Peak Level

Some audio sources (for example, Dolby Digital and DTS) include ultra-low bass tones. Set the bass limiter as needed to prevent the bass from distorting the sound from the subwoofer.

### 1 Select 'Bass Peak Level' from the Expert setup menu.

The current setting is displayed.

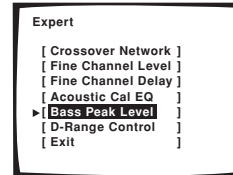

- When **[OFF]** is displayed the attenuator is off (bass output is not affected).

### Important

- When **[-80]** is displayed, no bass is output.

### 2 Select a setup option.

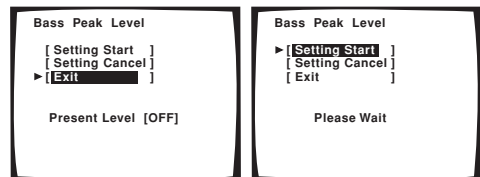

- **Setting Start** – The volume is set to -80dB, a test tone plays back and you make the setting.
- **Setting Cancel** – Switches limiting off.

### 3 If you selected 'Setting Start', use the ▲/▼ (cursor up/down) buttons to adjust the test tone and specify the bass peak level then press ENTER.

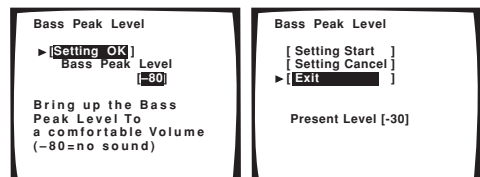

Set the bass peak level gradually, then press **ENTER** at the point just before the tone starts to distort. When you're finished, the display on the receiver will show **RESUME** and the volume will return to its original position.

- Press **RETURN** at any time to exit without setting the bass peak level.
- If your subwoofer has an Auto Sleep feature, make sure the subwoofer is active (not in standby).

- If the **YES** or **PLUS** setting on the subwoofer is selected (in *Speaker Setting* on page 51), the test tone will only play back from the subwoofer. If not, the test tone will play back from the front and surround speakers set to **LARGE**.

#### 4 When you're finished, select 'Exit'.

You will return to the Expert setup menu.

### Dynamic Range Control

- Default setting: **OFF**

This setting specifies the amount of dynamic range adjustment to Dolby Digital and DTS movie soundtracks. You may want to use this when listening to surround sound at low volumes.

#### 1 Select 'D-Range Control' from the Expert setup menu.

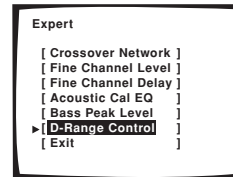

#### 2 Choose the setting that you want.

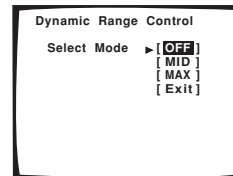

- **OFF** – No dynamic range adjustment (use when listening at higher volume).
- **MID** – Mid setting.
- **MAX** – Dynamic range is reduced (loud sounds are reduced in volume while quieter sounds are increased)

#### 3 When you're finished, select 'Exit'.

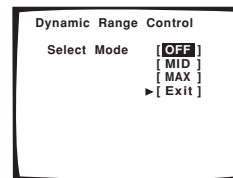

You will return to the Expert setup menu.

#### Tip

- For general dynamic range control, you can use the Midnight listening mode (see *Using Midnight and Loudness listening* on page 45) on a variety of sources that are not Dolby Digital or DTS encoded.

## Chapter 12

## Additional information

## Troubleshooting

Incorrect operations are often mistaken for trouble and malfunctions. If you think that there is something wrong with this component, check the points below. Sometimes the trouble may lie in another component. Investigate the other components and electrical appliances being used. If the trouble cannot be rectified even after exercising the checks listed below, ask your nearest Pioneer authorized independent service company to carry out repair work.

## Power

Symptom	Cause	Remedy
The power does not turn on.	<ul style="list-style-type: none"> <li>The power plug is disconnected.</li> <li>The protection circuit may have been activated.</li> <li>Something is obstructing the rear panel ventilation device.</li> </ul>	<ul style="list-style-type: none"> <li>Connect the power plug to the wall outlet.</li> <li>Disconnect the power plug from the outlet, and insert again.</li> <li>Unplug the receiver from the wall and call a Pioneer authorized independent service company.</li> </ul>
The receiver suddenly switches off.	<ul style="list-style-type: none"> <li>The speaker wires are frayed or sticking out of the jack, and are touching the back of the receiver or another set of wires.</li> <li>The receiver has a serious problem.</li> </ul>	<ul style="list-style-type: none"> <li>Reinsert the speaker wires, making sure there are no stray strands of wire and that they are inserted fully.</li> <li>Unplug the receiver from the wall and call a Pioneer authorized independent service company.</li> </ul>
During loud playback the power suddenly switches off.	<ul style="list-style-type: none"> <li>The protection circuit has been activated because the lowest actual impedance of the speakers (as opposed to the speakers rated impedance) is dangerously low.</li> </ul>	<ul style="list-style-type: none"> <li>Turn down the volume.</li> <li>When it's convenient, go to <i>Acoustic Calibration EQ</i> on page 81 and lower the 63 Hz and 125 Hz equalizer levels using the manual setting.</li> <li>Turning the digital safety feature on may allow you to turn up the volume a little more. To switch between <b>SAFETY ON</b> and <b>SAFETY OFF</b>, put the receiver into standby, then press the <b>STANDBY/ON</b> button while holding down the <b>MULTI JOG CONTROL SET UP</b> button on the front panel.</li> </ul>
The unit does not respond when the buttons are pressed.	<ul style="list-style-type: none"> <li>Static electricity caused by dry air.</li> </ul>	<ul style="list-style-type: none"> <li>Switch the unit off, then on again.</li> <li>Disconnect the power plug from the outlet, and insert again.</li> </ul>
<b>AMP ERR</b> blinks in the display, then the power automatically switches off.	<ul style="list-style-type: none"> <li>The receiver has a serious problem.</li> </ul>	<ul style="list-style-type: none"> <li>After about a minute (you won't be able to switch the unit on during this time), switch the receiver back on. If the message persists, call a Pioneer authorized independent service company.</li> </ul>
<b>FAN STOP</b> blinks in the display, then the power automatically switches off.	<ul style="list-style-type: none"> <li>Something is obstructing the fan.</li> <li>The fan is malfunctioning.</li> </ul>	<ul style="list-style-type: none"> <li>Remove the obstruction and try switching the receiver back on. If the fan is still not working, or you can't remove the object, unplug the receiver from the wall and call a Pioneer authorized independent service company.</li> <li>Unplug the receiver from the wall and call a Pioneer authorized independent service company.</li> </ul>
<b>OVERHEAT</b> blinks in the display and no sound is output.	<ul style="list-style-type: none"> <li>The internal temperature of the unit has become too high.</li> </ul>	<ul style="list-style-type: none"> <li>After allowing the unit to cool down in a well-ventilated place, try switching the receiver back on. Make sure you follow the guidelines for improving heat dispersal in <i>Ventilation</i> on page 7.</li> </ul>
<b>THDCT NG</b> blinks in the display and the unit turns off.	<ul style="list-style-type: none"> <li>The thermistor (temperature sensor) is broken.</li> </ul>	<ul style="list-style-type: none"> <li>Turn the receiver off, unplug from wall and call a Pioneer authorized independent service company to look at the problem.</li> </ul>



No sound

Symptom	Cause	Remedy
No sound is output when an input source is selected.	• Improper connections.	• Make sure you have properly connected the component to the corresponding input on the back of the receiver (see <i>Connecting your equipment</i> on page 15).
	• Sound is muted or the volume is turned down.	• Press <b>MUTE</b> or adjust the volume accordingly.
	• Speakers are turned off or selected improperly with the <b>SPEAKERS</b> switch.	• Press <b>SPEAKERS</b> to select the proper speaker set (see <i>Switching the speaker system</i> on page 67).
	• The input signal type is incorrect.	• Press <b>SIGNAL SELECT</b> to select the proper input signal (see <i>Selecting the input signal type</i> on page 42).
No sound output from the front speakers.	• The multichannel analog inputs are selected.	• Press <b>MULTI CH INPUT</b> again (see <i>Using the multichannel analog inputs</i> on page 41).
	• The front speakers aren't connected properly.	• See <i>Installing your speaker system</i> on page 28 to connect them properly.
No sound from the surround or center speakers.	• Speaker settings are incorrect. (for example, they have been set to <b>NO</b> ).	• Check you speaker settings in <i>Speaker Setting</i> on page 51.
	• The surround and/or center levels are turned down.	• Check the levels in <i>Channel Level</i> on page 52.
	• The surround and/or center speakers aren't connected properly.	• Check <i>Installing your speaker system</i> on page 28 to make sure the speakers are connected correctly.
	• The <b>STEREO</b> listening mode has been selected.	• Choose a surround listening mode (see <i>Listening in surround sound</i> on page 37).
No sound from surround back speakers.	• Surround back speakers are set to <b>NO</b> .	• Set the surround back speakers to <b>LARGE</b> or <b>SMALL</b> (see <i>Speaker Setting</i> on page 51).
	• The <b>SB CH</b> mode is switched off.	• Set the surround back channel to <b>SB CH ON</b> (see page 43).
	• The source is not a 6.1 channel playback source.	• Choose an advanced effect listening mode (see <i>Listening in surround sound</i> on page 37).
	• The surround back speakers aren't connected properly.	• Check <i>Installing your speaker system</i> on page 28 to make sure the speakers are connected correctly.
	• The surround back channel is on the 1 speaker setting, and your speaker is connected to the right channel output.	• Connect the speaker to the surround back left channel output ( <i>Installing your speaker system</i> on page 28).
	• The <b>SB CH MODE</b> is switched to <b>AUTO</b> and the Dolby Surround EX / DTS ES software you're playing has no flag to indicate it is 6.1 compatible.	• You can still listen with surround back sound by setting the surround back channel to <b>SB CH ON</b> (page 43).
	• The surround back channel is on the 1 speaker setting, and your speaker is connected to the right channel output.	• Connect the speaker to the surround back left channel output ( <i>Installing your speaker system</i> on page 28).
No sound from subwoofer.	• The bass attenuator is set too low (for example, the <b>-80</b> setting).	• See <i>Bass Peak Level</i> on page 86 to adjust the setting.
	• The subwoofer isn't connected properly, or it is switched off.	• Connect or switch on the subwoofer (see <i>Installing your speaker system</i> on page 28). • Make sure the sleep function on your subwoofer isn't activated.
	• The subwoofer's settings are incorrect.	• Set the subwoofer (see <i>Speaker Setting</i> on page 51) to <b>YES</b> or <b>PLUS</b> .
	• The crossover frequency is set too low.	• Set the crossover frequency to a (higher) frequency that matches your speaker characteristics (see <i>Crossover Network</i> on page 80)
	• There is very little low frequency information in your source.	• Change your subwoofer setting to one of the following in the <i>Speaker Setting</i> on page 51: Front: <b>SMALL</b> / Subwoofer: <b>YES</b> Front: <b>LARGE</b> / Subwoofer: <b>PLUS</b>
	• The subwoofer's levels are too low.	• See <i>Channel Level</i> on page 52 to check the speaker levels. • Check the volume control on the subwoofer to make sure it is turned up.

Symptom	Cause	Remedy
No sound from one speaker.	<ul style="list-style-type: none"> <li>The speaker setting has been set to <b>NO</b>.</li> <li>The speaker level is too low.</li> <li>The speaker isn't connected properly.</li> </ul>	<ul style="list-style-type: none"> <li>Change the setting in <i>Speaker Setting</i> on page 51.</li> <li>Check the level in <i>Channel Level</i> on page 52.</li> <li>Check <i>Installing your speaker system</i> on page 28 to make sure the speaker is connected correctly.</li> </ul>
Sound is produced from analog components, but not from digital ones (DVD, LD, CD-ROM etc.).	<ul style="list-style-type: none"> <li>The digital input assignment is wrong.</li> <li>The digital components aren't connected properly.</li> <li>The player is not compatible with the source you're using, or the player settings are incorrect.</li> <li>The digital output level has been turned down on a CD player or other component equipped with digital output level adjustment capability.</li> <li>The multichannel analog inputs are selected.</li> <li>The input signal type is set to <b>ANALOG</b>.</li> </ul>	<ul style="list-style-type: none"> <li>By choosing an advanced effect listening mode (see <i>Listening in surround sound</i> on page 37), you may be able to create an extra channel for the speaker.</li> <li>Assign the digital inputs correctly (see <i>Assigning the digital inputs</i> on page 75).</li> <li>Make sure you have properly connected the digital component to the corresponding input on the back of the receiver (see <i>Connecting your equipment</i> on page 15).</li> <li>Choose a compatible source, or check the component's manual for the correct settings.</li> <li>Set the digital volume level of the player to full, or to the neutral position.</li> <li>Press <b>MULTI CH INPUT</b> again (see <i>Using the multichannel analog inputs</i> on page 41).</li> <li>Set the input signal type to <b>DIGITAL</b> (see <i>Selecting the input signal type</i> on page 42).</li> </ul>
No sound is output or a noise is output when Dolby Digital/DTS software is played back.	<ul style="list-style-type: none"> <li>A DVD player not compatible with Dolby Digital/DTS is being used.</li> <li>The settings on the DVD player are incorrect and/or the DTS signal output is turned off.</li> <li>The digital output level is turned down on a CD player or other component equipped with digital output level adjustment capability. (The DTS signal has been altered by the player, and cannot be read.)</li> </ul>	<ul style="list-style-type: none"> <li>Make sure your DVD player is compatible with Dolby Digital/DTS.</li> <li>Make sure the player's settings are correct and/or the DTS signal out is on. Refer to the instruction manual supplied with the DVD player.</li> <li>Set the digital volume level of the player to full, or to the neutral position.</li> </ul>

## Other audio problems

Symptom	Cause	Remedy
Broadcast stations cannot be selected automatically, or there seems to be considerable noise in radio broadcasts.	<p><b>FM broadcasts</b></p> <ul style="list-style-type: none"> <li>The FM antenna is not fully extended or is poorly positioned.</li> <li>Weak radio signals.</li> </ul> <p><b>AM broadcasts</b></p> <ul style="list-style-type: none"> <li>The AM antenna is poorly positioned.</li> <li>Weak radio signals.</li> <li>Interference caused by other equipment (fluorescent lamp, motor, etc.).</li> </ul>	<ul style="list-style-type: none"> <li>Fully extend the FM wire antenna, position for best reception, and secure to a wall.</li> <li>Connect an outdoor FM antenna (see page 30).</li> <li>Adjust the direction and position for best reception.</li> <li>Connect an additional internal or external AM antenna (see page 30).</li> <li>Turn off the equipment causing the noise or move it away from the receiver.</li> <li>Place the antenna farther away from the equipment causing the noise.</li> </ul>
A multi channel DVD source appears to be downmixed from 2 channels during playback.	<ul style="list-style-type: none"> <li>The source is coming from something other than the <b>MULTI CH IN</b> jacks (for example, digital PCM output, etc.)</li> </ul>	<ul style="list-style-type: none"> <li>Check the <b>MULTI CH IN</b> connection (see <i>Connecting the multichannel analog outputs</i> on page 20) and select the multichannel analog inputs with the <b>MULTI CH IN</b> button (see <i>Using the multichannel analog inputs</i> on page 41).</li> </ul>
Noise is output when scanning a DTS CD.	<ul style="list-style-type: none"> <li>The scan function performed by the player slightly alters the digital information, making it unreadable.</li> </ul>	<ul style="list-style-type: none"> <li>This is not a malfunction, but be sure to turn the volume down to prevent the output of loud noise from your speakers.</li> </ul>
When playing a DTS format LD there is audible noise on the soundtrack.	<ul style="list-style-type: none"> <li>The input signal type is set to <b>ANALOG</b>.</li> </ul>	<ul style="list-style-type: none"> <li>Set the input signal type to <b>DIGITAL</b> (see <i>Selecting the input signal type</i> on page 42)</li> </ul>

Symptom	Cause	Remedy
Can't record audio.	• You are trying to make an analog recording from a digital signal, or a digital recording of an analog source.	• You can only record analog to analog, or digital to digital.
	• The digital source is copy protected.	• You can't record digital sources that have been copy protected.
Subwoofer output is very low.	• The analog <b>REC</b> jacks have not been connected properly.	• Check your analog connections (see <i>Connecting analog audio sources</i> on page 26).
	• The bass attenuator is set too low.	• See <i>Bass Peak Level</i> on page 86 to adjust the setting.
Everything seems to be set up correctly, but the playback sound is odd.	• The speaker settings result in very little audio signal being sent to the subwoofer.	• Change your subwoofer setting to one of the following in the <i>Speaker Setting</i> on page 51: Front: <b>SMALL</b> / Subwoofer: <b>YES</b> Front: <b>LARGE</b> / Subwoofer: <b>PLUS</b>
	• The speakers are out of phase.	• Check that the positive/negative speaker terminals on the receiver are matched with the corresponding terminals on the speakers (page 28).
Noise or hum can be heard even when there is no sound being input.	• There is electrical interference from another component or appliance.	• Check that personal computers or other digital components connected to the same power source are not causing interference.
There seems to be a time lag between the speakers and the output of the subwoofer.	• The subwoofer channel can be delayed slightly if run through a low-pass filter.	• See <i>Automatically setting up for surround sound</i> on page 12 to set up your system again using MCACC (this will automatically compensate for a delay in the subwoofer output).

Video

Symptom	Cause	Remedy
No image is output when an input is selected.	• The video connections are incorrect.	• Make sure the video component is connected correctly (see pages 19–27).
	• You are using component video connections for your source, but not for your TV.	• Using the video converter, video signals can be converted from a composite or S-video input to a component video output, but not vice-versa. See <i>About the video converter</i> on page 16 for more on this.
	• You are using component video connections and the component video inputs are assigned incorrectly.	• Check <i>Assigning the component video inputs</i> on page 76 to make sure you're assigned the correct input.
	• The DVD/video player settings are incorrect.	• Set correctly. Refer to the instruction manual supplied with the DVD/video player.
	• The video input selected on the TV monitor is incorrect.	• Set correctly. Refer to the instruction manual supplied with the TV.
	• Even though the sub room monitor is connected properly, the multi-room feature is switched off.	• Press the <b>MULTI ROOM&amp;SOURCE ON/OFF</b> button to switch it on.
	• The component video inputs are assigned to a video component connected only to the composite or S-Video terminals.	• Check <i>Assigning the component video inputs</i> on page 76 to make sure the component video assign for that video component is switched to <b>OFF</b> .
The <b>System Setup</b> screen doesn't appear.	• The <b>MONITOR OUT</b> jack hasn't been connected.	• Connect the <b>MONITOR OUT</b> jack to the TV monitor (see <i>Connecting your TV</i> on page 18).
	• You connected your TV to the <b>MULTI ROOM &amp; SOURCE MONITOR OUT</b> jack instead of the main <b>MONITOR OUT</b> jack.	
Screen noise when playing back a video source.	• Some TVs connected to the receiver with component video cables do not display the <b>System Setup</b> screen when the Color Burst feature is on.	• When the receiver is in standby, switch to <b>COLOR BURST OFF</b> by holding down the <b>MULTI JOG CONTROL RETURN</b> button and pressing <b>STANDBY/ON</b> . (the current setting appears in the display).
	• The video source signal has a problem.	• If your video connections use mixed cable types (for example RCA standard video to a component video connection), you may want to try connecting your system using only one cable type (for example, use RCA standard video cable for all connections).

Symptom	Cause	Remedy
Can't record video.	• You are trying to record a source connected to the component video jacks.	• Connect the source component to either the composite video or the S-video jacks (see <i>Connecting your equipment</i> on page 15).
	• The source is copy protected.	• You can't record sources that have been copy protected.
	• The recorder's video input is hooked up using a different type of cable to the source video output.	• Hook up the source and the recorder using the same type of video cable (see <i>Making an audio or a video recording</i> on page 62).

## Settings

Symptom	Cause	Remedy
The Auto Surround Setup continually shows an error.	• The ambient noise level in the room is too high, or obstacles are blocking the setup microphone.	• Keep the noise level in the room as low as possible when using the Auto Surround Setup (see <i>Other problems when using the Auto Surround Setup</i> on page 14 for more on this). If the noise cannot be kept low enough, you will have to set up the surround sound manually (page 50).
After using the Auto Surround Setup, the speaker size setting ( <b>LARGE</b> or <b>SMALL</b> ) is incorrect.	• There was some inaudible low-frequency noise in the room.	• The low-frequency noise could have been caused by an air conditioner or motor. Switch off all appliances in the room and rerun the Auto Surround Setup.
The display shows <b>KEY LOCK ON</b> when you try to make settings.	• Your Pioneer dealer has enabled the key lock feature.	• Ask your Pioneer dealer to disable the key lock.

## Display

Symptom	Cause	Remedy
The display is dark or off.	• The display is set to dark or off.	• Press <b>DIMMER</b> on the remote control repeatedly to select a different brightness.
After making an adjustment the display goes off.	• The display is set to off.	• Press <b>DIMMER</b> on the remote control repeatedly to select a different brightness.
You can't get <b>DIGITAL</b> to display when using the <b>SIGNAL SELECT</b> button.	• There is a problem with the digital connections or the digital input is assigned incorrectly.	• Check your digital connections and/or assign the digital inputs correctly (see <i>Assigning the digital inputs</i> on page 75).
	• The multichannel analog inputs are selected.	• Press <b>MULTI CH INPUT</b> again (see <i>Using the multichannel analog inputs</i> on page 41).
The Dolby/DTS indicator doesn't light when playing Dolby/DTS software.	• The player is paused. • The player's sound output settings are wrong.	• Press play. • Set the player correctly (consult the manual that came with the player, if necessary).
When playing a DVD-Audio CD, the DVD player display shows <b>96 kHz</b> . However, the receiver's display does not.	• The audio from these discs is output from the analog audio jacks of the DVD player only; the receiver does not show the sampling rate of the input signal through the analog inputs.	• This is not a malfunction. See also the operating instructions that came with your DVD player.
During playback of a DTS 96/24 source, the display doesn't show <b>96kHz</b> .	• The receiver's input signal type is set to analog.	• Set the receiver to <b>AUTO</b> or <b>DIGITAL</b> (see <i>Selecting the input signal type</i> on page 42).
When playing Dolby Digital or DTS sources, the receiver's format indicators do not light.	• No digital connection, or the digital connection is incorrect.	• Check the digital audio connection (page 19).
	• The receiver's input signal type is set to analog.	• Set the receiver to <b>AUTO</b> or <b>DIGITAL</b> (see <i>Selecting the input signal type</i> on page 42).
	• The DVD player is set to output Dolby Digital and/or DTS audio as PCM.	• Check the settings on the player. Set the output for Dolby Digital and DTS (no PCM conversion). See also the operating instructions that came with your DVD player.
	• The disc has several playback audio tracks; the one currently playing is actually PCM.	• Switch the playback audio channel on your DVD player. See the operating instructions that came with your DVD player.
When playing certain discs, none of the receiver's format indicators light.	• The audio format of the disc is not 5.1/6.1 channel.	• This is not a malfunction. Check the disc packaging for details of the audio formats available on the disc.

Symptom	Cause	Remedy
When playing a disc, the <b>PRO LOGIC II</b> or <b>Neo:6</b> indicator lights on the receiver.	<ul style="list-style-type: none"> <li>The input signal type is set to analog.</li> <li>A 2 channel soundtrack is currently playing.</li> <li>The soundtrack currently playing is encoded using Dolby Surround.</li> </ul>	<ul style="list-style-type: none"> <li>Set the receiver to <b>AUTO</b> or <b>DIGITAL</b> (see <i>Selecting the input signal type</i> on page 42).</li> <li>This is not a malfunction. Check the disc packaging for details of the audio formats available on the disc.</li> <li>This is not a malfunction. Check the disc packaging for details of the audio formats available on the disc.</li> </ul>
During playback of a Surround EX or DTS ES source on the <b>SB CH AUTO</b> setting, the <b>EX</b> and <b>ES</b> indicators don't light, or the signal is not properly processed.	<ul style="list-style-type: none"> <li>The source may be Dolby Surround EX / DTS ES software, but it has no flag to indicate it is 6.1 compatible.</li> </ul>	<ul style="list-style-type: none"> <li>Switch the surround back channel setting (page 43) to <b>SB CH ON</b> then switch to the THX Surround EX or Standard EX listening mode (see <i>Listening in surround sound</i> on page 37).</li> </ul>

## Remote control

Symptom	Cause	Remedy
Cannot be remote controlled.	<ul style="list-style-type: none"> <li>The remote control batteries have worn out.</li> <li>Too far away or improper angle of operation.</li> <li>There is an obstacle between the receiver and the remote control.</li> <li>Strong light such as fluorescent light is shining onto the unit's remote control sensor.</li> <li>Something is plugged into the <b>CONTROL IN</b> jack.</li> <li>The IR receiver type is mismatched with the setting.</li> </ul>	<ul style="list-style-type: none"> <li>Replace the batteries (see <i>Loading the batteries</i> on page 7).</li> <li>Operate within 23 feet and a 30° angle of the remote sensor on the front panel (see <i>Operating range of the remote control</i> on page 8).</li> <li>Remove the obstacle or move to another place.</li> <li>Avoid exposing the remote sensor on the front panel to direct light.</li> <li>Unplug the cable from the <b>CONTROL IN</b> jack and use remote normally (see <i>Operating other Pioneer components with this unit's sensor</i> on page 61).</li> <li>Disconnect the IR receiver from the rear panel or set to the other IR receiver type (see <i>Multi-Room and IR receiver setup</i> on page 78).</li> </ul>
Other components can't be operated with the system remote.	<ul style="list-style-type: none"> <li>The preset code settings are wrong.</li> <li>The batteries wore out and the system settings were cleared.</li> </ul>	<ul style="list-style-type: none"> <li>Input the correct preset code.</li> <li>Reset the proper system settings.</li> </ul>
The SR cable is connected, but the connected components can't be operated with the remote.	<ul style="list-style-type: none"> <li>The SR cable hasn't been connected properly.</li> <li>The rest of the component connections have not been made.</li> <li>The component you have hooked up is not a Pioneer product.</li> </ul>	<ul style="list-style-type: none"> <li>Reinsert the SR cable, making sure it's connected to the right jack (see <i>Operating other Pioneer components with this unit's sensor</i> on page 61).</li> <li>Make sure an analog connection has been made between the units.</li> <li>This feature only works with Pioneer products.</li> </ul>
The remote control backlight is switched on, but the <b>ENTER</b> button doesn't light.	<ul style="list-style-type: none"> <li>This is not a malfunction.</li> </ul>	<ul style="list-style-type: none"> <li>This is a feature designed for quickly identifying the remote control buttons in a dark room.</li> </ul>
<ul style="list-style-type: none"> <li>For information about using the remote control in the sub room, please contact your local Pioneer dealer or the Pioneer Customer Support division.</li> </ul>		

## USB interface

Symptom	Cause	Remedy
No sound.	<ul style="list-style-type: none"> <li>The computer settings are incorrect.</li> <li>The software or source material you are using is not compatible with USB output.</li> <li>The volume control on your computer is set too low.</li> </ul>	<ul style="list-style-type: none"> <li>Make sure you have set up your computer system to output through the USB interface (see <i>Using the USB interface</i> on page 72).</li> <li>Update to a more recent version of your existing software, try a different audio program, or try a different source.</li> <li>Turn up the volume on your computer.</li> </ul>

**Note**

- If the unit does not operate normally due to external effects such as static electricity, disconnect the power plug from the outlet and insert again to return to normal operating conditions.

## Surround sound formats

Below is a brief description of the main surround sound formats you'll find on DVDs, satellite, cable and terrestrial broadcasts, and video cassettes.

### Dolby

The Dolby technologies are explained below. See [www.dolby.com](http://www.dolby.com) for more detailed information.



### Dolby Digital

Dolby Digital is a multichannel digital audio coding system widely used in cinemas, and in the home for DVD and digital broadcast soundtracks. It can deliver up to six discrete audio channels, comprising five full range channels and a special LFE (Low frequency effects) channel used mainly for deep, rumbling sound effects; hence the term "5.1-channel" Dolby Digital.

In addition to the format features above, Dolby Digital decoders offer downmixing for compatibility with mono, stereo and Dolby Pro Logic audio from a number of bit rates and channels. Another feature, called Dialog Normalization, attenuates programs based on the average level of dialog in a program relative to its peak level (also known as Dialnorm) in order to achieve uniform playback level.

### Dolby Digital Surround EX

Dolby Digital Surround EX (the EX stands for EXtended) is an extension of Dolby Digital encoding whereby a surround back channel is matrixed into the surround left/right channels for 6.1 channel playback. This allows for compatibility with Dolby Digital 5.1 channel decoding, as well as for decoding using Dolby Digital EX.

### Dolby Pro Logic IIx and Dolby Surround

Dolby Pro Logic IIx is an improved version of the Dolby Pro Logic II (and Dolby Pro Logic) *decoding* system. Using the innovative "steering logic" circuit, this system extracts surround sound from sources as follows:

- **Dolby Pro Logic** – 4.1 channel sound (mono surround) from any stereo source
- **Dolby Pro Logic II** – 5.1 channel sound (stereo surround) from any stereo source
- **Dolby Pro Logic IIx** – 6.1 or 7.1 channel sound (stereo surround and surround back) from two channel or 5.1 (and 6.1) channel sources

*With two channel sources, the ".1" subwoofer channel is generated by bass management in the receiver.*

Dolby Surround is an *encoding* system which embeds surround sound information within a stereo soundtrack, which a Dolby Pro Logic decoder can then use for enhanced surround listening with greater sound detail.

*Manufactured under license from Dolby Laboratories. "Dolby", "Pro Logic", "Surround EX" and the double-D symbol are trademarks of Dolby Laboratories.*

### DTS

The DTS technologies are explained below. See [www.dtstech.com](http://www.dtstech.com) for more detailed information.



### DTS Digital Surround

DTS Digital Surround is a 5.1-channel audio coding system from Digital Theater Systems Inc. now widely used for DVD-Video, DVD-Audio, 5.1 music discs, digital broadcasts, and video games. It can deliver up to six discrete audio channels, comprising five full range channels, including an LFE channel. Higher sound quality is achieved through the use of a low compression rate, and high rates of transmittance during playback.

### DTS-ES

DTS-ES (the ES stands for Extended Surround) is a decoder that is capable of decoding both DTS-ES Discrete 6.1 and DTS-ES Matrix 6.1 encoded sources. DTS-ES Discrete 6.1 gives 'true' 6.1 channel sound, with a completely separate (discrete) surround back channel. DTS-ES Matrix 6.1 has a surround back channel matrixed into the surround left/right channels. Both sources are also compatible with a conventional DTS 5.1 channel decoder.

### DTS Neo:6

DTS Neo:6 can generate 6.1 channel surround sound from any matrixed stereo source (such as video or TV) and from 5.1 channel sources. It uses both the channel information already encoded into the source, as well as its own processing to determine channel localization (with two channel sources, the ".1" subwoofer channel is generated by bass management in the receiver). Two modes (Cinema and Music) are available using DTS Neo:6 with two channel sources.

### DTS 96/24

DTS 96/24 is an extension of the original DTS Digital Surround which offers high quality 96 kHz / 24-bit audio using a DTS 96/24 decoder. This format is also fully backward compatible with all existing decoders. This means that DVD players can play this software using a conventional DTS 5.1 channel decoder.

*"DTS", "DTS-ES", "Neo:6" and "DTS 96/24" are trademarks of Digital Theater Systems, Inc.*

## About THX

The THX technologies are explained below. See [www.thx.com](http://www.thx.com) for more detailed information.



### THX Cinema processing

THX is an exclusive set of standards and technologies established by the world-renowned film production company, Lucasfilm Ltd. THX grew from George Lucas' personal desire to make your experience of the film soundtrack, in both movie theatres and in your home theatre, as faithful as possible to what the director intended. Movie soundtracks are mixed in special movie theatres called dubbing stages and are designed to be played back in movie theatres with similar equipment and conditions. This same soundtrack is then transferred directly onto Laserdisc, VHS tape, DVD, etc., and is not changed for playback in a small home theatre environment. THX engineers developed patented technologies to accurately translate the sound from the movie theatre environment into the home, correcting the tonal and spatial errors that occur. On this product, when the THX indicator is on, THX features are automatically added in Cinema modes (e.g. THX Cinema, THX Surround EX).

### Re-Equalization

The tonal balance of a film soundtrack will be excessively bright and harsh when played back over audio equipment in the home because film soundtracks were designed to be played back in large movie theaters using very different professional equipment. Re-Equalization restores the correct tonal balance for watching a movie soundtrack in a small home environment.

### Timbre Matching

The human ear changes our perception of a sound depending on the direction from which the sound is coming. In a movie theatre, there is an array of surround speakers so that the surround information is all around you. In a home theatre, you use only two speakers located to the side of your head. The Timbre Matching feature filters the information going to the surround speakers so that they more closely match the tonal characteristics of the sound coming from the front speakers. This ensures seamless panning between the front and surround speakers.

### Adaptive Decorrelation

In a movie theatre, a large number of surround speakers help create an enveloping surround sound experience, but in a home theatre there are usually only two speakers. This can make the surround speakers sound like headphones that lack spaciousness and envelopment.

The surround sounds will also collapse into the closest speaker as you move away from the middle seating position. Adaptive Decorrelation slightly changes one surround channel's time and phase relationship with respect to the other surround channel. This expands the listening position and creates—with only two speakers—the same spacious surround experience as in a movie theatre.

### THX Select

Before any home theatre component can be THX Select certified, it must incorporate all the features above and also pass a rigorous series of quality and performance tests. Only then can a product feature the THX Select logo, which is your guarantee that the Home Theatre products you purchase will give you superb performance for many years to come. THX Select requirements cover every aspect of the product including pre-amplifier and power amplifier performance and operation, and hundreds of other parameters in both the digital and analog domain.

### THX Surround EX

THX Surround EX - Dolby Digital Surround EX is a joint development of Dolby Laboratories and the THX Ltd. In a movie theater, film soundtracks that have been encoded with Dolby Digital Surround EX technology are able to reproduce an extra channel which has been added during the mixing of the program. This channel, called Surround Back, places sounds behind the listener in addition to the currently available front left, front center, front right, surround right, surround left and subwoofer channels. This additional channel provides the opportunity for more detailed imaging behind the listener and brings more depth, spacious ambience and sound localization than ever before. Movies that were created using the Dolby Digital Surround EX technology, when released into the home consumer market may exhibit wording to that effect on the packaging. A list of movies created using this technology can be found on the Dolby web site at [www.dolby.com](http://www.dolby.com).

Only receiver and controller products bearing the THX Surround EX logo, when in the THX Surround EX mode, faithfully reproduce this new technology in the home.

This product may also engage the "THX Surround EX" mode during the playback of 5.1 channel material that is not Dolby Digital Surround EX encoded. In such case the information delivered to the Surround Back channel will be program dependent and may or may not be very pleasing depending on the particular soundtrack and the tastes of the individual listener.

*THX is a trademark or registered trademark of THX Ltd. Surround EX is a jointly developed technology of THX and Dolby Laboratories and is a trademark of Dolby Laboratories. Used under authorization. All rights reserved.*



**Preset code brands**

**DVD**

Pioneer  
Denon  
JVC  
Philips  
Panasonic  
RCA  
Samsung  
Sony  
Toshiba  
Yamaha

**LD**

Pioneer  
Denon  
Kenwood  
Panasonic  
Philips  
Sony  
Yamaha

**CD-R**

Pioneer  
Denon  
JVC  
Kenwood  
Philips  
Sony

**DVR**

Pioneer  
**MD**  
Pioneer  
Denon  
JVC  
Kenwood  
Sony  
Yamaha

**CD**

Pioneer  
Denon  
Fisher  
JVC  
Kenwood  
Magnavox  
Marantz  
Onkyo  
Panasonic  
Philips  
RCA  
Sanyo  
Sharp  
Sony  
TEAC  
Technics  
Yamaha

**STB (Satellite/CATV)**

Pioneer  
Blaupunkt  
General Instrument  
Goldstar  
Grundig  
Hamlin  
HNS/Hughes  
Hitachi  
ITT/Nokia  
Jerrold  
NEC  
Oak  
Panasonic  
Philips  
Radio Shack  
RCA  
Samsung  
Scientific Atlanta  
Siemens  
Sony  
Toshiba  
Tocom  
Zenith

**Tape**

Pioneer  
Denon  
Fisher  
JVC  
Kenwood  
Nakamichi  
Onkyo  
Philips  
Sony  
TEAC  
Technics  
Yamaha

**Tuner**

**VCR**

Pioneer  
Admiral  
Aiwa  
Akai  
Alba  
Audio Dynamic  
Bell&Howell  
Blaupunkt  
Brocsonic  
Bush  
Canon  
CGM  
Citizen

Clatronic  
Craig  
Curtis Mathis  
Daewoo  
DBX  
Dimensia  
Emerson  
Ferguson  
Fisher  
Funai  
GE  
Goldstar  
Goodmans  
Grundig  
Hitachi  
Instant Replay  
ITT/Nokia  
JC Penny  
JVC  
Kendo  
Kenwood  
Loewe  
Luxor  
LXI  
Magnavox  
Marantz  
Marta  
Matsui  
Memorex  
Minolta  
Mitsubishi  
Multitech  
NEC  
Nokia Oceanic  
Nokia  
Nordmende  
Okano  
Olympic  
Orion  
Panasonic  
Pentax  
Philco  
Philips  
Phonola  
Quasar  
RCA/Proscan  
Realistic  
Saba  
Samsung  
Sansui  
Sanyo  
Schneider  
Scott  
SEG

Seleco  
Sharp  
Siemens  
Signature  
Sony  
Sylvania  
Symphonic  
Tandberg  
Tashiro  
Tatung  
TEAC  
Technics  
Telefunken  
Thorn  
Toshiba  
Universum  
W.W House  
Wards  
Yamaha  
Zenith

**TV**

Pioneer  
Admiral  
Aiwa  
Akai  
Alba  
AOC  
Bestar  
Blaupunkt  
Blue Sky  
Brandt  
Brocsonic  
Bush  
Clatronic  
Craig  
Croslex  
Curtis Mathis  
Daewoo  
Daytron  
Dual  
Emerson  
Ferguson  
First  
Fisher  
Fujitsu  
Funai  
GE  
Goldstar  
Goodmans  
Grandiente  
Grundig  
Hitachi  
ICE  
Irradio  
ITT/Nokia  
JC Penny  
JVC  
Kendo  
KTV  
Loewe  
LXI  
Magnavox  
Mark  
Matsui  
Matsushita  
Medion  
Mitsubishi  
Mivar  
NEC  
Nokia Oceanic  
Nordmende  
Okano  
Onwa  
Panasonic  
Philco  
Philips  
Phonola  
Portland  
Proscan  
Quasar  
Radio  
Radio Shack  
Radiola  
RCA/Proscan  
Saba  
Samsung  
Sanyo  
Schneider  
Scott  
Sharp  
Siemens  
Signature  
Sony  
Sylvania  
Symphonic  
Tatung  
Telefunken  
Thomson  
Thorn  
Toshiba  
Universum  
Videch  
W.W House  
Wards  
Watson  
Zenith

## Specifications

### Amplifier section

**Continuous average power output of 110 watts\* per channel, min., at 8 ohms, from 20 Hz to 20,000 Hz with no more than 0.09%\*\* total harmonic distortion (front).**

Continuous Power Output

Front	110 W + 110 W (20 Hz-20 kHz, 0.09%)
Center	110 W (20 Hz-20 kHz, 0.09%)
Surround	110 W + 110 W (20 Hz-20 kHz, 0.09%)
Surround back	110 W + 110 W (20 Hz-20 kHz, 0.09%)

### Audio Section

Input (Sensitivity/Impedance)	
PHONO MM	4.7 mV/47 k $\Omega$
LINE	335 mV/47 k $\Omega$
Frequency Response	
PHONO MM	20 Hz to 20,000 Hz $\pm$ 0.3 dB
LINE	.5 Hz to 100,000 Hz $\pm$ 3 dB
Output (Level/Impedance)	
LINE	335 mV/2.2 k $\Omega$
Tone Control	
BASS	$\pm$ 6 dB (100 Hz)
TREBLE	$\pm$ 6 dB (10 kHz)
LOUDNESS	+4/+2 dB (100Hz/10 kHz) (at volume position -40dB)
Signal-to-Noise Ratio (IHF, short circuited, A network)	
LINE	101 dB
Signal-to-Noise Ratio [EIA, at 1W (1kHz)]	
LINE	83 dB

\* Measured pursuant to the Federal Trade Commission's Trade Regulation rule on Power Output Claims for Amplifiers  
 \*\* Measured by Audio Spectrum Analyzer

### Composite Video / S-Video Section

Input (Sensitivity/Impedance)	1 Vp-p/75 $\Omega$
Output (Level/Impedance)	1 Vp-p/75 $\Omega$
Signal-to-Noise Ratio	65 dB
Frequency Response	.5 Hz to 10 MHz $\pm$ 3 dB

### Component Video Section

Input (Sensitivity/Impedance)	1 Vp-p/75 $\Omega$
Output (Level/Impedance)	1 Vp-p/75 $\Omega$
Signal-to-Noise Ratio	65 dB
Frequency Response	.5 Hz to 100 MHz $\pm$ 3 dB

### FM Tuner Section

Frequency Range	87.5 MHz to 108 MHz
Usable Sensitivity	Mono: 13.2 dBf, IHF (1.3 $\mu$ V/75 $\Omega$ )
50 dB Quieting Sensitivity	Mono: 20.2 dBf Stereo: 38.6 dBf
Signal-to-Noise Ratio	Mono: 73 dB (at 85 dBf) Stereo: 70 dB (at 85 dBf)
Distortion	Stereo: 0.5% (1 kHz)
Alternate Channel Selectivity	60 dB (400 kHz)

Stereo Separation	40 dB (1 kHz)
Frequency Response	30 Hz to 15 kHz $\pm$ 1dB
Antenna Input	75 $\Omega$ unbalanced

### AM Tuner Section

Frequency Range	.530 kHz to 1,700 kHz
Sensitivity (IHF, Loop antenna)	350 $\mu$ V/m
Selectivity	25 dB
Signal-to-Noise Ratio	50 dB
Antenna	Loop antenna

### Miscellaneous

Power Requirements	AC 120 V, 60 Hz
Power Consumption	600 W
Power Consumption in standby	0.8W
AC outlet (switched)	100 W (0.8 A) MAX
Dimensions	420 (W) $\times$ 188 (H) $\times$ 464 (D) mm (16-9/16 (W) $\times$ 7-7/16 (H) $\times$ 18-5/16 (D) in.)
Weight (without package)	20.3 kg (44.8 lb)

### Furnished Parts

Microphone	1
Microphone stand	1
Remote control unit	1
Alkaline batteries (AA IEC LR6)	4
AM loop antenna	1
FM wire antenna	1
Power cord	1
Warranty card	1
These operating instructions	1



### Note

- Specifications and the design are subject to possible modifications without notice, due to improvements.

## Maintenance of external surfaces

- Use a polishing cloth or dry cloth to wipe off dust and dirt.
- When the surfaces are dirty, wipe with a soft cloth dipped in some neutral cleanser diluted five or six times with water, and wrung out well, and then wipe again with a dry cloth. Do not use furniture wax or cleaners.



### Dear Customer:

Selecting fine audio equipment such as the unit you've just purchased is only the start of your musical enjoyment. Now it's time to consider how you can maximize the fun and excitement your equipment offers. This manufacturer and the Electronic Industries Association's Consumer Electronics Group want you to get the most out of your equipment by playing it at a safe level. One that lets the sound come through loud and clear without annoying blaring or distortion-and, most importantly, without affecting your sensitive hearing.

Sound can be deceiving. Over time your hearing "comfort level" adapts to higher volumes of sound. So what sounds "normal" can actually be loud and harmful to your hearing. Guard against this by setting your equipment at a safe level BEFORE your hearing adapts.

#### To establish a safe level:

- Start your volume control at a low setting.
- Slowly increase the sound until you can hear it comfortably and clearly, and without distortion.

#### Once you have established a comfortable sound level:

- Set the dial and leave it there.

Taking a minute to do this now will help to prevent hearing damage or loss in the future. After all, we want you listening for a lifetime.

## We Want You Listening For A Lifetime

Used wisely, your new sound equipment will provide a lifetime of fun and enjoyment. Since hearing damage from loud noise is often undetectable until it is too late, this manufacturer and the Electronic Industries Association's Consumer Electronics Group recommend you avoid prolonged exposure to excessive noise. This list of sound levels is included for your protection.

#### Decibel Level Example

30	Quiet library, soft whispers
40	Living room, refrigerator, bedroom away from traffic
50	Light traffic, normal conversation, quiet office
60	Air conditioner at 20 feet, sewing machine
70	Vacuum cleaner, hair dryer, noisy restaurant
80	Average city traffic, garbage disposals, alarm clock at two feet.

#### THE FOLLOWING NOISES CAN BE DANGEROUS UNDER CONSTANT EXPOSURE

90	Subway, motorcycle, truck traffic, lawn mower
100	Garbage truck, chain saw, pneumatic drill
120	Rock band concert in front of speakers, thunderclap
140	Gunshot blast, jet plane
180	Rocket launching pad

Information courtesy of the Deafness Research Foundation.



S001\_En

Should this product require service in the U.S.A. and you wish to locate the nearest Pioneer Authorized Independent Service Company, or if you wish to purchase replacement parts, operating instructions, service manuals, or accessories, please call the number shown below.

8 0 0 – 4 2 1 – 1 4 0 4

Please do not ship your product to Pioneer without first calling the Customer Support Division at the above listed number for assistance.

Pioneer Electronics (USA) Inc.  
Customer Support Division  
P.O. BOX 1760, Long Beach,  
CA 90801-1760, U.S.A.

For warranty information please see the Limited Warranty sheet included with your product.

Should this product require service in Canada, please contact a Pioneer Canadian Authorized Dealer to locate the nearest Pioneer Authorized Service Company in Canada. Alternatively, please contact the Customer Satisfaction Department at the following address:

Pioneer Electronics of Canada, Inc.  
Customer Satisfaction Department  
300 Allstate Parkway, Markham, Ontario L3R OP2  
1(877)283-5901

For warranty information please see the Limited Warranty sheet included with your product.

Si ce produit doit être réparé au Canada, veuillez vous adresser à un distributeur autorisé Pioneer du Canada pour obtenir le nom du Centre de Service Autorisé Pioneer le plus près de chez-vous. Vous pouvez aussi contacter le Service à la clientèle de Pioneer:

Pioneer Électroniques du Canada, Inc.  
Service à la clientèle  
300, Allstate Parkway, Markham, Ontario L3R OP2  
1(877)283-5901

Pour obtenir des renseignements sur la garantie, veuillez vous reporter au feuillet sur la garantie restreinte qui accompagne le produit.

5018\_A\_EF

Published by Pioneer Corporation.  
Copyright © 2004 Pioneer Corporation.  
All rights reserved.

---

## **PIONEER CORPORATION**

4-1, Meguro 1-Chome, Meguro-ku, Tokyo 153-8654, Japan

### **PIONEER ELECTRONICS (USA) INC.**

P.O. BOX 1540, Long Beach, California 90810-1540, U.S.A. TEL: (800) 421-1404

### **PIONEER ELECTRONICS OF CANADA, INC.**

300 Allstate Parkway, Markham, Ontario L3R OP2, Canada TEL: 1-877-283-5901

### **PIONEER EUROPE NV**

Haven 1087, Keetberglaan 1, B-9120 Melsele, Belgium TEL: 03/570.05.11

### **PIONEER ELECTRONICS ASIACENTRE PTE. LTD.**

253 Alexandra Road, #04-01, Singapore 159936 TEL: 65-6472-7555

### **PIONEER ELECTRONICS AUSTRALIA PTY. LTD.**

178-184 Boundary Road, Braeside, Victoria 3195, Australia, TEL: (03) 9586-6300

### **PIONEER ELECTRONICS DE MEXICO S.A. DE C.V.**

Blvd.Manuel Avila Camacho 138 10 piso Col.Lomas de Chapultepec, Mexico,D.F. 11000 TEL: 55-9178-4270

K002\_A\_En

## Free Manuals Download Website

<http://myh66.com>

<http://usermanuals.us>

<http://www.somanuals.com>

<http://www.4manuals.cc>

<http://www.manual-lib.com>

<http://www.404manual.com>

<http://www.luxmanual.com>

<http://aubethermostatmanual.com>

Golf course search by state

<http://golfingnear.com>

Email search by domain

<http://emailbydomain.com>

Auto manuals search

<http://auto.somanuals.com>

TV manuals search

<http://tv.somanuals.com>