

**Pioneer** *sound.vision.soul*

**VSX-1015-S**  
**VSX-1015-K**

AUDIO/VIDEO MULTI-CHANNEL RECEIVER

Discover the benefits of registering your product online at [www.pioneer.co.uk](http://www.pioneer.co.uk)  
([www.pioneer-eur.com](http://www.pioneer-eur.com)).

Operating Instructions

# IMPORTANT



The lightning flash with arrowhead symbol, within an equilateral triangle, is intended to alert the user to the presence of uninsulated "dangerous voltage" within the product's enclosure that may be of sufficient magnitude to constitute a risk of electric shock to persons.

## CAUTION

**RISK OF ELECTRIC SHOCK  
DO NOT OPEN**



**CAUTION:**  
TO PREVENT THE RISK OF ELECTRIC SHOCK, DO NOT REMOVE COVER (OR BACK). NO USER-SERVICEABLE PARTS INSIDE. REFER SERVICING TO QUALIFIED SERVICE PERSONNEL.

The exclamation point within an equilateral triangle is intended to alert the user to the presence of important operating and maintenance (servicing) instructions in the literature accompanying the appliance.

D3-4-2-1-1\_En-A

Replacement and mounting of an AC plug on the power supply cord of this unit should be performed only by qualified service personnel.

# IMPORTANT

## FOR USE IN THE UNITED KINGDOM

**The wires in this mains lead are coloured in accordance with the following code:**

**Blue : Neutral  
Brown : Live**

If the plug provided is unsuitable for your socket outlets, the plug must be cut off and a suitable plug fitted.

The cut-off plug should be disposed of and must not be inserted into any 13 amp socket as this can result in electric shock. The plug or adaptor or the distribution panel should be provided with 10 A fuse. As the colours of the wires in the mains lead of this appliance may not correspond with coloured markings identifying the terminals in your plug, proceed as follows :  
The wire which is coloured blue must be connected to the terminal which is marked with the letter N or coloured black.  
The wire which is coloured brown must be connected to the terminal which is marked with the letter L or coloured red.

Do not connect either wire to the earth terminal of a three pin plug.

### NOTE

After replacing or changing a fuse, the fuse cover in the plug must be replaced with a fuse cover which corresponds to the colour of the insert in the base of the plug or the word that is embossed on the base of the plug, and the appliance must not be used without a fuse cover. If lost replacement fuse covers can be obtained from your dealer.  
Only 10 A fuses approved by B.S.I or A.S.T.A to B.S.1362 should be used.

D3-4-2-1-2\_En

Thank you for buying this Pioneer product. Please read through these operating instructions so you will know how to operate your model properly. After you have finished reading the instructions, put them away in a safe place for future reference.

## WARNING

*Before plugging in for the first time, read the following section carefully.*

**The voltage of the available power supply differs according to country or region. Be sure that the power supply voltage of the area where this unit will be used meets the required voltage (e.g., 230V or 120V) written on the rear panel.**

D3-4-2-1-4\_A\_En

## WARNING

**To prevent a fire hazard, do not place any naked flame sources (such as a lighted candle) on the equipment.**

D3-4-2-1-7a\_A\_En

This product complies with the Low Voltage Directive (73/23/EEC, amended by 93/68/EEC), EMC Directives (89/336/EEC, amended by 92/31/EEC and 93/68/EEC).

D3-4-2-1-9a\_En

## WARNING

**This equipment is not waterproof. To prevent a fire or shock hazard, do not place any container filled with liquid near this equipment (such as a vase or flower pot) or expose it to dripping, splashing, rain or moisture.**

D3-4-2-1-3\_A\_En

## VENTILATION CAUTION

**When installing this unit, make sure to leave space around the unit for ventilation to improve heat radiation (at least 60 cm at top, 10 cm at rear, and 30 cm at each side).**

## WARNING

**Slots and openings in the cabinet are provided for ventilation to ensure reliable operation of the product, and to protect it from overheating. To prevent fire hazard, the openings should never be blocked or covered with items (such as newspapers, table-cloths, curtains) or by operating the equipment on thick carpet or a bed.**

D3-4-2-1-7b\_A\_En

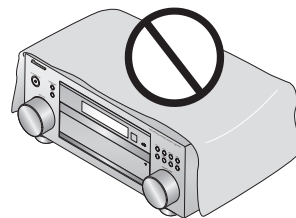

## Operating Environment

Operating environment temperature and humidity: +5 °C – +35 °C (+41 °F – +95 °F); less than 85 %RH (cooling vents not blocked)

Do not install this unit in a poorly ventilated area, or in locations exposed to high humidity or direct sunlight (or strong artificial light)

D3-4-2-1-7c\_A\_En

**When disposing of used batteries, please comply with governmental regulations or environmental public instruction's rules that apply in your country/area.**

D3-4-2-3-1\_En

If the AC plug of this unit does not match the AC outlet you want to use, the plug must be removed and appropriate one fitted. Replacement and mounting of an AC plug on the power supply cord of this unit should be performed only by qualified service personnel. If connected to an AC outlet, the cut-off plug can cause severe electrical shock. Make sure it is properly disposed of after removal. The equipment should be disconnected by removing the mains plug from the wall socket when left unused for a long period of time (for example, when on vacation).

D3-4-2-2-1a\_A\_En

#### **CAUTION**

The **⏻STANDBY/ON** switch on this unit will not completely shut off all power from the AC outlet. Since the power cord serves as the main disconnect device for the unit, you will need to unplug it from the AC outlet to shut down all power. Therefore, make sure the unit has been installed so that the power cord can be easily unplugged from the AC outlet in case of an accident. To avoid fire hazard, the power cord should also be unplugged from the AC outlet when left unused for a long period of time (for example, when on vacation).

D3-4-2-2-2a\_A\_En

This product is for general household purposes. Any failure due to use for other than household purposes (such as long-term use for business purposes in a restaurant or use in a car or ship) and which requires repair will be charged for even during the warranty period.

K041\_En

### **Important information about this unit's AC outlets**

#### **Switched total 100 W MAX**

Power supplied through these outlets is turned on and off by this unit's **⏻STANDBY/ON** switch. Total electrical power consumption of connected equipment should not exceed 100 W.

#### **CAUTION**

- Do not connect a TV set, monitor, heater or similar appliance to this unit's AC outlet.
- Do not connect appliances with high power consumption to the AC outlet in order to avoid overheating and fire risk. This can cause this unit to malfunction.

D3-4-2-2-1b\_A\_En

# Contents

## 01 Before you start

Features	6
Checking what's in the box	6
Installing the receiver	7
Loading the batteries	7

## 02 5 minute guide

Introduction to home theater	8
Listening to Surround Sound	8
Automatically setting up for surround sound (MCACC)	11
Other problems when using the Auto MCACC Setup	13
Checking the settings on your DVD (or other) player	13
Playing a source	13

## 03 Connecting up

About cable types	14
Analog audio cables	14
Digital audio cables	14
Video cables	14
When making cable connections	15
Connecting digital audio components	16
Connecting analog audio components	17
Connecting multichannel analog components	17
Connecting video components	18
Connecting to the front panel video terminal	18
Connecting antennas	19
FM wire antenna	19
AM loop antenna	19
Using external antennas	19
Connecting the speakers	20
Speaker terminals	21
Hints on speaker placement	21
THX speaker system setup	22
AC outlet	22
Operating other Pioneer components	23

## 04 Controls and displays

Front panel	24
Display	26
Remote control	28
Operating range of remote control unit	30

## 05 Listening to your system

Auto playback	31
Listening in surround sound	31
Standard surround sound	31
Using the Home THX modes	32
Using the Advanced surround effects	33
Dolby Pro Logic IIx Music settings	33
Neo:6 Music settings	34
Listening in stereo	34
Listening with Acoustic Calibration EQ	34
Choosing the input signal	35
Using the surround back channel (Extended mode)	36
Using the Virtual Surround Back mode (VirtualSB)	37
Using Loudness and Midnight listening	38
Enhancing dialog	38
Using the tone controls	38
Playing other sources	39
Selecting the multichannel analog inputs	39
Using the sleep timer	39

## 06 The System Setup menu

Making receiver settings from the System Setup menu	40
Surround back speaker setting	40
Manual MCACC speaker setup	41
Fine Channel Level	42
Fine Channel Distance	42
Acoustic Calibration EQ	43
Manual speaker setup	45
Speaker Setting	46
Crossover Network	47
Channel Level	47
Speaker Distance	48
Surround Back Speaker Position	48

## 07 Using the tuner

Listening to the radio	49
Improving FM stereo sound	49
Tuning directly to a station	49
Saving station presets	50
Naming station presets	50
Listening to station presets	50
An introduction to RDS	51
Displaying RDS information	51
Searching for RDS programs	52
Using EON	52
Clearing all stations from the RDS and EON searches	52

## 08 Making recordings

Making an audio or a video recording . . . . . 53

## 09 Controlling the rest of your system

Setting the remote to control other components . . . . . 54

Selecting preset codes directly . . . . . 54

Programming signals from other remote controls . . . . . 55

Erasing one of the remote control button settings . . . . . 56

Erasing all of the remote control presets . . . . . 56

Direct function . . . . . 56

Confirming preset codes . . . . . 56

Controls for TVs . . . . . 57

Controls for other components . . . . . 58

## 10 Other connections

Second Zone speaker B setup . . . . . 60

    Switching the speaker system . . . . . 60

Bi-amping your front speakers . . . . . 61

Bi-wiring your speakers . . . . . 61

Connecting additional amplifiers . . . . . 62

Using this receiver with a Pioneer plasma display . . . . . 62

Using the SR+ mode with a Pioneer plasma display . . . . . 63

## 11 Other Settings

The Input Assign menu . . . . . 64

The Other Setup menu . . . . . 65

    Dynamic Range Control Setup . . . . . 66

    Dual Mono Setup . . . . . 66

    LFE Attenuator Setup . . . . . 67

    SR+ Setup for Pioneer plasma displays . . . . . 67

## 12 Additional information

Troubleshooting . . . . . 68

    Power . . . . . 68

    No sound . . . . . 69

    Other audio problems . . . . . 70

    Video . . . . . 71

    Settings . . . . . 72

    Display . . . . . 72

    Remote control . . . . . 73

Resetting the main unit . . . . . 73

Switching the speaker impedance . . . . . 73

Changing the TV format setting . . . . . 73

Surround sound formats . . . . . 74

    Dolby . . . . . 74

    DTS . . . . . 74

    Windows Media® Audio 9 Professional . . . . . 75

About THX . . . . . 75

Specifications . . . . . 77

Cleaning the unit . . . . . 77

## Chapter 1: Before you start

### Features

- **High quality MOSFET design**

This receiver offers high-quality discrete MOSFET configuration unique to Pioneer for low distortion, and generates equal amplifier power to all channels, eliminating the possibility of one channel dominating a particular sound field.

- **Easy setup using Multichannel Acoustic Calibration (MCACC)**

Setting up for home theater sound is as easy as connecting your speakers, a DVD player or other source, and your TV. The Auto Surround Setup provides a quick but accurate surround sound setup, while for complete surround sound control you still have access to the full range of surround sound settings.

- **THX Select2 certified design**

This receiver bears the THX Select2 logo, which means it has passed a rigorous series of quality and performance tests covering every aspect of the product. This includes testing of pre-amplifier and power amplifier performance and operation, and hundreds of other parameters in both the digital and analog domain, making your home theater experience as faithful as possible to what the director intended.

- **Dolby Digital and DTS decoding, including Dolby Digital EX, Dolby Pro Logic IIx, DTS 96/24 and DTS-ES**

Dolby Digital and DTS decoding brings theater sound right into your home with up to six channels of surround sound, including a special LFE (Low Frequency Effects) channel for deep, realistic sound effects.

The built-in Dolby Pro Logic IIx and DTS Neo:6 decoders not only provide full surround sound decoding for Dolby Surround sources, but will also generate convincing surround sound for any stereo source.

Also, with the addition of a surround back speaker, you can take advantage of the built-in Dolby Digital EX and DTS-ES decoders for six-channel surround sound.

- **Easy-to-use LCD remote control**

The remote control gives you not only complete control over every function of this receiver, but also over the main functions for other components in your home theater system. Using a system of preset codes, you can program the remote to operate a wide range of other equipment.

### Checking what's in the box

Please check that you've received the following supplied accessories:

- Setup microphone



- Remote control unit

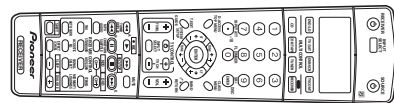

- AA/LR6 dry cell batteries x2

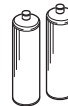

- AM loop antenna



- FM wire antenna



- These operating instructions

## Installing the receiver

- When installing this unit, make sure to put it on a level and stable surface.

Don't install it on the following places:

- on a color TV (the screen may distort)
- near a cassette deck (or close to a device that gives off a magnetic field). This may interfere with the sound.
- in direct sunlight
- in damp or wet areas
- in extremely hot or cold areas
- in places where there is vibration or other movement
- in places that are very dusty
- in places that have hot fumes or oils (such as a kitchen)

## Loading the batteries

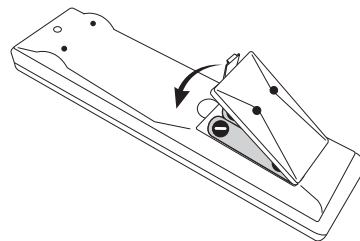
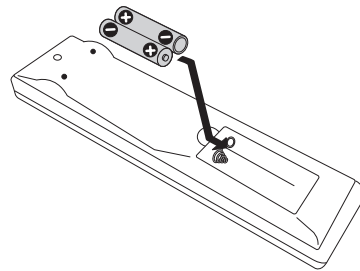
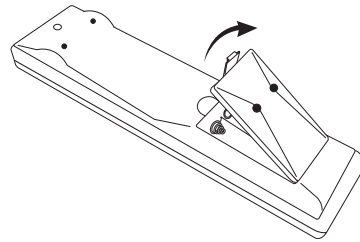

### Caution

Incorrect use of batteries may result in such hazards as leakage and bursting. Observe the following precautions:

- Never use new and old batteries together.
- Insert the plus and minus sides of the batteries properly according to the marks in the battery case.
- Batteries with the same shape may have different voltages. Do not use different batteries together.
- When disposing of used batteries, please comply with governmental regulations or environmental public instruction's rules that apply in your country or area.

## Chapter 2: 5 minute guide

### Introduction to home theater

You are probably used to using stereo equipment to listen to music, but may not be used to home theater systems that give you many more options (such as surround sound) when listening to soundtracks.

Home theater refers to the use of multiple audio tracks to create a surround sound effect, making you feel like you're in the middle of the action or concert. The surround sound you get from a home theater system depends not only on the speakers you have set up in your room, but also on the source and the sound settings of the receiver.

DVD-Video has become the basic source material for home theater due to its size, quality, and ease of use. Depending on the DVD, you can have up to seven different audio tracks coming from one disc, all of them being sent to different speakers in your system. This is what creates a surround sound effect and gives you the feeling of 'being there'.

This receiver will automatically decode Dolby Digital, DTS, or Dolby Surround DVD-Video discs, according to your speaker setup. In most cases, you won't have to make changes for realistic surround sound, but other possibilities (like listening to a CD with multichannel surround sound) are explained in *Listening to your system* on page 31.

### Listening to Surround Sound

This receiver was designed with the easiest possible setup in mind, so with the following quick setup guide, you should have your system hooked up for surround sound in no time at all. In most cases, you can simply leave the receiver in the default settings.



#### Important

- Before making or changing any connections, switch off the power and disconnect the power cord from the AC outlet.

#### 1 Hook up your DVD player.

For surround sound, you'll want to hook up using a digital connection from the DVD player to the receiver. You can do this with either a coaxial (recommended), or an optical connection (you don't need to connect both). If you hook up using an optical cable, you should refer to *The Input Assign menu* on page 64 to assign the optical input to **DVD**.

Use a video cord to connect the video output on your DVD player to the receiver using the jacks shown below.

#### 2 Hook up your TV.

Use a video cord to connect your receiver to the TV using the jacks as shown below.

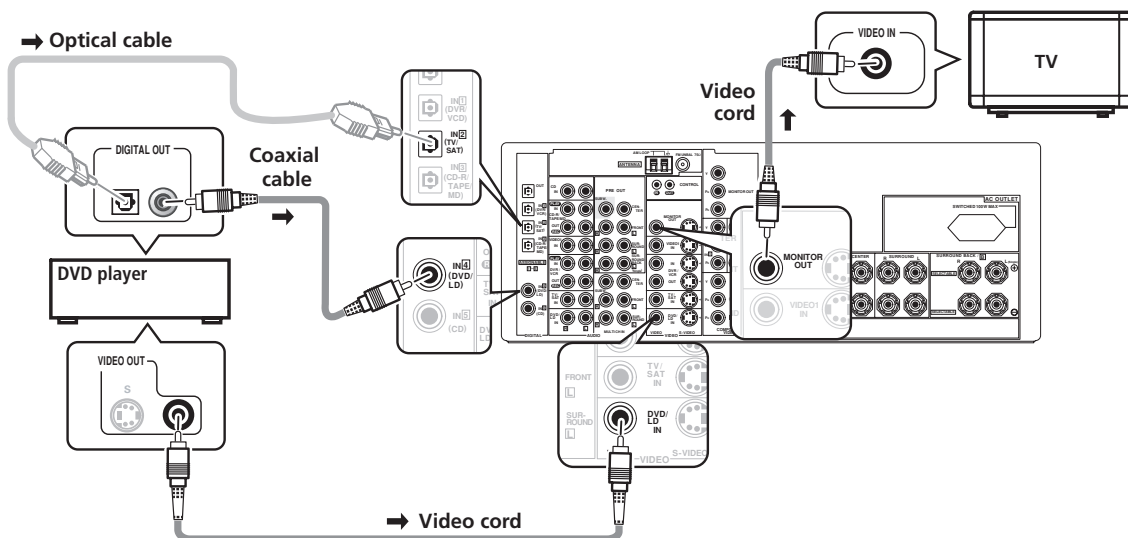



### 3 Connect your speakers.

A complete setup of eight speakers (including the subwoofer) is shown here but everyone's home setup will vary. Simply connect the speakers you have in the manner shown below. The receiver will work with just two stereo speakers (the front speakers in the diagram) but using at least three speakers is recommended, and a complete setup is best. Make sure you connect the speaker on the right to the right terminal and the speaker on the left to the left terminal. Also make sure the positive and negative (+/-) terminals on the receiver match those on the speakers. You can use speakers with a nominal impedance between 6–16Ω (please see *Switching the speaker impedance* on page 73 if you plan to use speakers with an impedance of less than 8Ω).

- If you only have one surround back speaker, hook it up to the surround back left (**Single**) terminal.

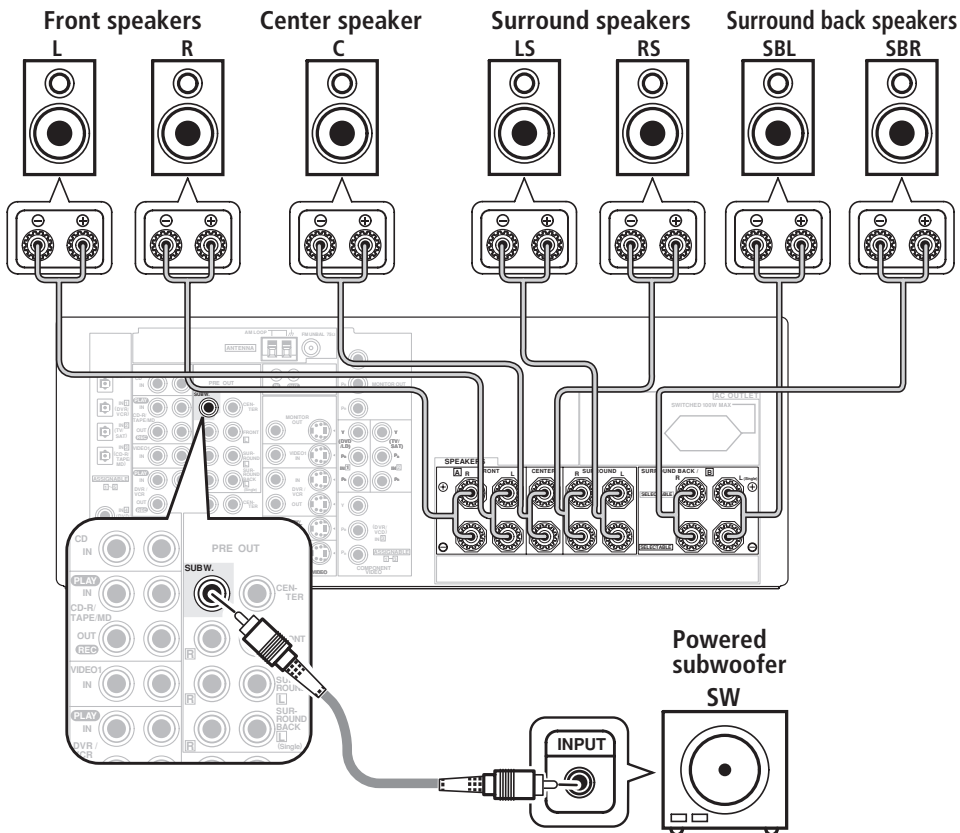

#### Caution

- These speaker terminals carry **HAZARDOUS LIVE** voltage. To prevent the risk of electric shock when connecting or disconnecting the speaker cables, disconnect the power cord before touching any uninsulated parts.
- Make sure that all the bare speaker wire is twisted together and inserted fully into the speaker terminal. Use good quality speaker wire to connect the speakers to the receiver.

Make sure that the speaker cable you're going to use is properly prepared with about 10 mm of insulator stripped from each wire, and the exposed wire strands twisted together (*fig. A*).

To connect a terminal, unscrew the terminal a few turns until there is enough space to insert the exposed wire (*fig. B*). Once the wire is in position, tighten the terminal until the wire is firmly clamped (*fig. C*).

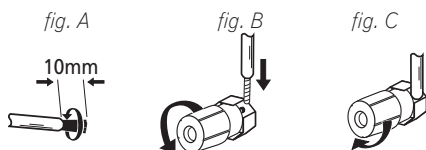

Where you place the speakers will have a big effect on the sound. Place your speakers as shown below for the best surround sound effect. See *Hints on speaker placement* on page 21 for more on this.

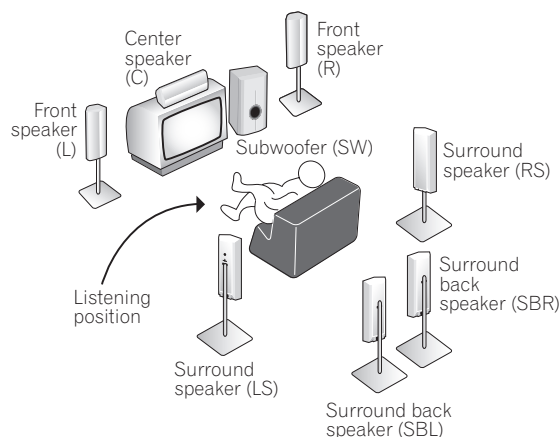

#### 4 Plug in the receiver and switch it on, followed by your DVD player, your subwoofer and the TV.

Make sure you've set the video input on your TV to this receiver. Check the manual that came with the TV if you don't know how to do this.

#### 5 Use the on-screen automatic MCACC setup to set up your system.

See *Automatically setting up for surround sound (MCACC)* on the next page for more on this.

#### 6 Play a DVD, and adjust the volume to your liking.

Make sure that **DVD/LD** is showing in the receiver's display, indicating that the DVD input is selected. If it isn't, press **DVD/LD** on the remote control to set the receiver to the DVD input.

In addition to the basic playback explained in *Playing a source* on page 13, there are several other sound options you can select. See *Listening to your system* on page 31 for more on this. See also *Making receiver settings from the System Setup menu* on page 40 for more setup options.

- If you're not familiar with the proper DVD settings, refer to *Checking the settings on your DVD (or other) player* on page 13.

## Automatically setting up for surround sound (MCACC)

The Auto MCACC Setup measures the acoustic characteristics of your listening area, taking into account ambient noise, speaker size and distance, and tests for both channel delay and channel level. After you have set up the microphone provided with your system, the receiver uses the information from a series of test tones to optimize the speaker settings and equalization for your particular room.

Make sure you do this before moving on to *Playing a source* on page 13.

### Important

- Make sure the microphone and speakers are not moved during the Auto MCACC Setup.
- Using the Auto MCACC Setup will overwrite any existing speaker settings in the receiver.
- Before using the Auto MCACC Setup the headphones should be disconnected and **MULTI CH IN** switched off.
- The receiver will automatically exit the current screen after three minutes of inactivity.

### Caution

- The test tones used in the Auto MCACC Setup are output at high volume.



### 1 Switch on the receiver and your TV.

### 2 Connect the microphone to the MCACC SETUP MIC jack on the front panel.

Make sure there are no obstacles between the speakers and the microphone.

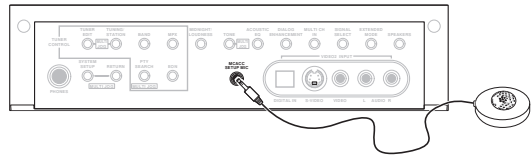

If you have a tripod, use it to place the microphone so that it's about ear level at your normal listening position. Otherwise, place the microphone at ear level using a table or a chair.

### 3 Press RECEIVER on the remote control, then press the SYSTEM SETUP button.

An on-screen display (OSD) appears on your TV. Use the **↑/↓/←/→** buttons and **ENTER** on the remote control to navigate through the screens and select menu items. Press **RETURN** to exit the current menu.

- Press **SYSTEM SETUP** at any time to exit the System Setup menu.

### 4 Select 'AUTO MCACC' from the System Setup menu then press ENTER.

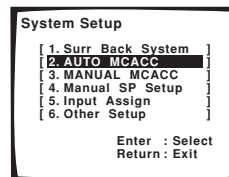

### 5 Make sure 'Normal (SB)' is selected then press ENTER.

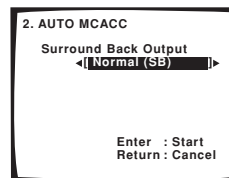

- If you are planning on bi-amping your front speakers, or setting up a separate speaker system in another room, read through *Surround back speaker setting* on page 40 and make sure to connect your speakers as necessary before continuing to step 6.

## 6 Follow the instructions on-screen.

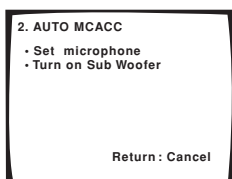

- Make sure the microphone is connected.
- If you're using a subwoofer, it is automatically detected every time you switch on the system. Make sure it is on and the volume is turned up.
- See below for notes regarding high background noise levels and other possible interference.

## 7 Wait for the Auto MCACC Setup to finish outputting test tones.

A progress report is displayed on-screen while the receiver outputs test tones to determine the speakers present in your setup. Try to be as quiet as possible while it's doing this.

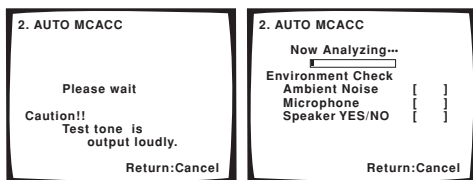

- Do not adjust the volume during the test tones. This may result in incorrect speaker settings.

## 8 Confirm the speaker configuration in the OSD.

The configuration shown on-screen should reflect the actual speakers you have.

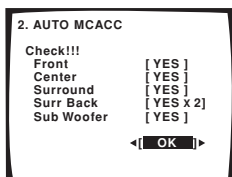

If the speaker configuration displayed isn't correct, use the **↑/↓** (cursor up/down) buttons to select the speaker and **←/→** (cursor left/right) to change the setting (and number for surround back). When you're finished, go to the next step.

If you see an error message (**ERR**) in the right side column, there may be a problem with the speaker connection. If selecting **RETRY** doesn't fix the problem, turn off the power and check the speaker connections.

## 9 Make sure 'OK' is selected, then press ENTER.

A progress report is displayed on-screen while the receiver outputs more test tones to determine the optimum receiver settings for channel level, speaker distance, and Acoustic Calibration EQ.

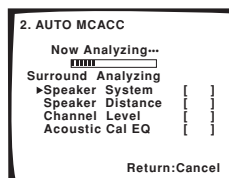

Again, try to be as quiet as possible while this is happening. It may take 3-8 minutes.

## 10 The Auto MCACC Setup has finished! Select 'Skip' to go back to the System Setup menu.

The MCACC indicator on the front panel will light to show the surround settings are complete.

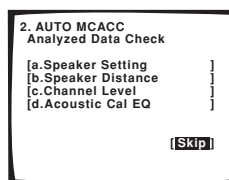

The settings made in the Auto MCACC Setup should give you excellent surround sound from your system, but it is also possible to adjust these settings manually using the System Setup menu (see page 40).

- If you are using THX Certified speakers, confirm that all speakers are set to **SMALL** in *Speaker Setting* on page 46, and that the *Crossover Network* on page 47 is set to **80HZ**.

You can also choose to view the settings by selecting individual parameters from the **Analyzed Data Check** screen:

- **Speaker Setting** – The size and number of speakers you've connected (see page 46 for more on this)
- **Speaker Distance** – The distance of your speakers from the listening position (see page 48 for more on this)
- **Channel Level** – The overall balance of your speaker system (see page 47 for more on this)
- **Acoustic Cal EQ** – Adjustments to the frequency balance of your speaker system based on the acoustic characteristics of your room (see page 43 for more on this)

Press **RETURN** after you have finished checking each screen. When you're finished, select **Skip** to go back to the System Setup menu.

 **Note**

- If you leave an error message on the screen for over three minutes, or if you cancel the Auto MCACC Setup at any time, the receiver automatically exits and no settings will be made.
- Depending on the characteristics of your room, sometimes identical speakers with cone sizes of around 12cm will end up with different size settings. You can correct the setting manually using the *Manual speaker setup* on page 45.
- The subwoofer distance setting may be farther than the actual distance from the listening position. This setting should be accurate (taking delay and room characteristics into account) and generally does not need to be changed.
- Remember to disconnect the microphone after you've finished the Auto MCACC Setup.

**Other problems when using the Auto MCACC Setup**

If the room environment is not optimal for the Auto MCACC Setup (too much background noise, echo off the walls, obstacles blocking the speakers from the microphone) the final settings may be incorrect. Check for household appliances (air conditioner, fridge, fan, etc.), that may be affecting the environment and switch them off if necessary. If there are any instructions showing in the front panel display, please follow them.

- Some older TVs may interfere with the operation of the microphone. If this seems to be happening, switch off the TV when doing the Auto MCACC Setup.

**Checking the settings on your DVD (or other) player**

Before continuing, you may want to check the digital audio output settings on your DVD player and digital satellite receiver.

- **Check that your DVD player/satellite receiver is set to output Dolby Digital, DTS and 88.2/96kHz PCM (2 channel) audio.**

If there is an option for MPEG audio, set this to convert the MPEG audio to PCM.

If you connected the multichannel analog outputs of the player to this receiver, make sure that the player is set to output multichannel analog audio.

 **Note**

- Depending on your DVD player or source discs, you may only get digital 2 channel stereo and analog sound. In this case, the receiver must be set to a multichannel listening mode (see *Listening in surround sound* on page 31 if you need to do this) if you want multichannel surround sound.

**Playing a source**

Here are the basic instructions for playing a source (such as a DVD disc) with your home theater system.

**1 Turn on the power of the playback component (for example a DVD player), your TV and subwoofer (if you have one).**

- If your source is the TV's built-in tuner, then switch to the channel you want to watch, otherwise make sure that the TV's video input is set to this receiver. (For example, if you connected this receiver to the **VIDEO 1** jacks on your TV, make sure that the **VIDEO 1** input is now selected.)

**2 If the receiver isn't already on, press  RECEIVER to switch it on.****3 Change the receiver input to the source you want to play.**

You can use the front panel input select buttons or the dedicated **MULTI CONTROL** buttons on the remote control.

**4 Press **AUTO SURR** (remote control) and start playback of the DVD (or other component).**

If you're playing a Dolby Digital or DTS surround sound DVD disc, you should hear surround sound. If you are playing a stereo source, you will only hear sound from the front left/right speakers in the default listening mode.

- See also *Listening to your system* on page 31 for more information on different ways of listening to sources.

**5 Use the volume control (front panel or remote) to adjust the volume level.**

- Turn down the volume of your TV so that all the sound is coming from the speakers connected to this receiver.
- Adjust the volume to your liking between **-80dB** (min) and **+12dB** (max).

 **Note**

- If you need to manually switch the input signal type from digital to analog (stereo or multichannel), press **SIGNAL SELECT** (page 35).
- For more detailed surround sound setup, see *The System Setup menu* on page 40.

## Chapter 3: Connecting up

### Important

- Before making or changing any connections, switch off the power and disconnect the power cord from the AC outlet.

### About cable types

#### Analog audio cables

Use stereo RCA phono cables to connect analog audio components. These cables are typically red and white, and you should connect the red plugs to R (right) terminals and white plugs to L (left) terminals.

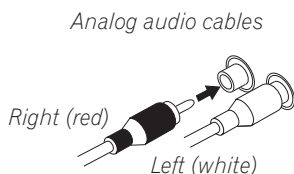

#### Digital audio cables

Commercially available coaxial digital audio cables or optical cables should be used to connect digital components to this receiver.

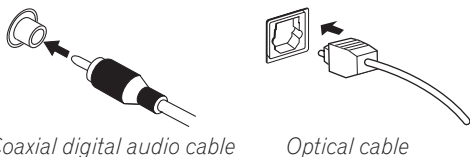

- When connecting optical cables, be careful when inserting the plug not to damage the shutter protecting the optical socket.
- When storing optical cable, coil loosely. The cable may be damaged if bent around sharp corners.
- You can also use a standard RCA video cable for coaxial digital connections.

### Video cables

#### Standard RCA video cables

These cables are the most common type of video connection and should be used to connect to the composite video terminals. They have yellow plugs to distinguish them from cables for audio.



#### S-video cables

S-video cables give you clearer picture reproduction than standard RCA video cables by sending separate signals for the luminance and color.



#### Component video cables

Use component video cables to get the best possible color reproduction of your video source. The color signal of the TV is divided into the luminance (**Y**) signal and the color (**P<sub>B</sub>** and **P<sub>R</sub>**) signals and then output. In this way, interference between the signals is avoided.

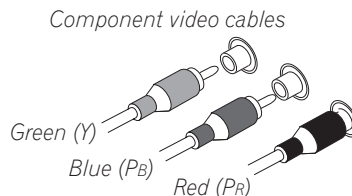

**When making cable connections**

Be careful not to arrange cables in a manner that bends the cables over the top or around this unit. If the cables are laid on top of the unit, the magnetic field produced by the transformers in this unit may cause a humming noise to come from the speakers.

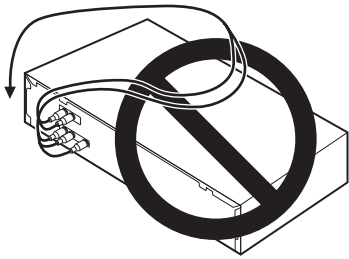

## Connecting digital audio components

The easiest way to hook up this receiver for surround sound (Dolby Digital and DTS sources) is to use a digital input. You can do this by either coaxial or optical connections (you do not need to do both). The quality of these two types of connections is the same but since some digital components only have one type of digital terminal, it is a matter of matching like with like (for example, the coaxial output from the component to coaxial input on the receiver). This receiver has five digital inputs (two coaxial inputs and three optical inputs) on the rear panel. Connect your digital components as shown below.

There is one digital output jack which is marked **DIGITAL OUT**. If you connect this to the optical input on a digital recorder (for example an MD, DAT or CD-R) you can make direct digital recordings with this unit.

When connecting your equipment, always make sure the power is turned off and the power cord is disconnected from the AC outlet.

- The arrows indicate the direction of the signal.

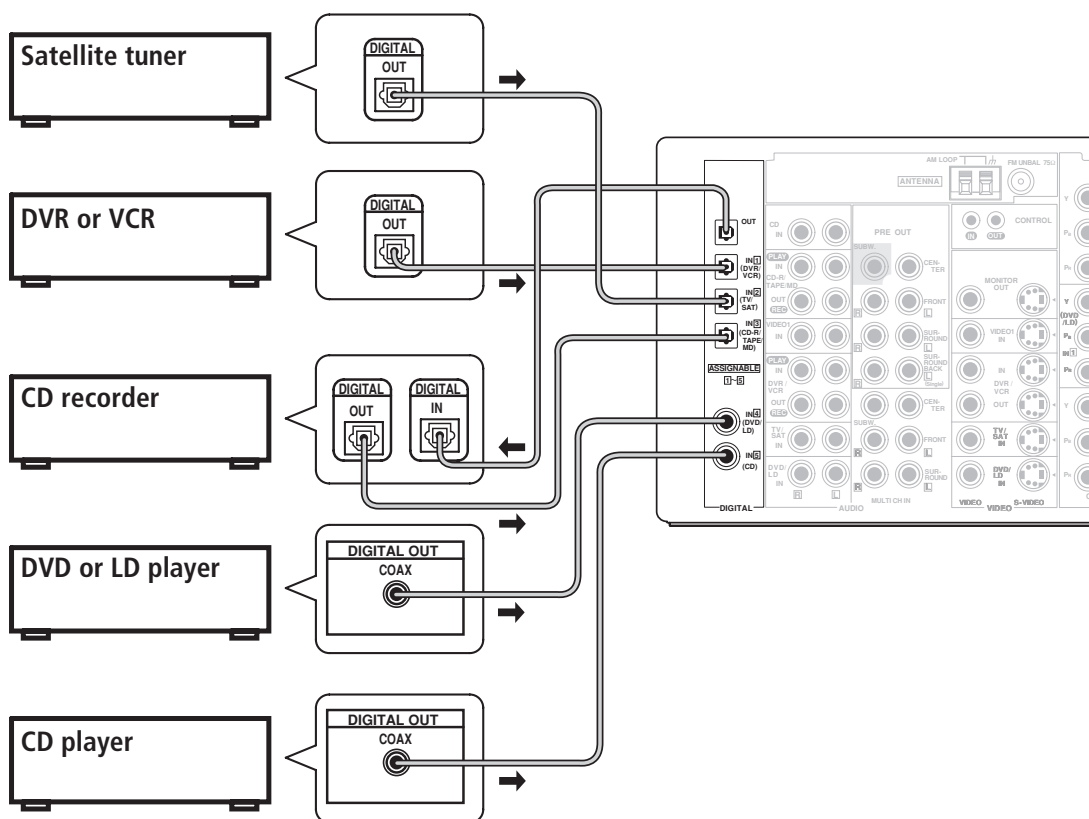

### Note

- If your digital connections are different from the default settings, you should refer to *The Input Assign menu* on page 64 to assign the jacks to the proper component(s).
- If you have a DVD-Audio or SACD compatible player, see *Connecting multichannel analog components* on page 17.



### Connecting analog audio components

To begin set up, connect your analog audio components (such as a cassette deck) to the jacks. For components you want to record with, you need to hook up four plugs to the receiver (a set of stereo inputs and a set of stereo outputs), but for components that only play, you only need to hook up one set of stereo plugs. You must also hook up your digital components to analog audio jacks if you want to record to/from digital components (like an MD) to/from analog components. See page 16 for more on digital connections.

When connecting your equipment, always make sure the power is turned off and the power cord is disconnected from the AC outlet.

- The arrows indicate the direction of the audio signal.

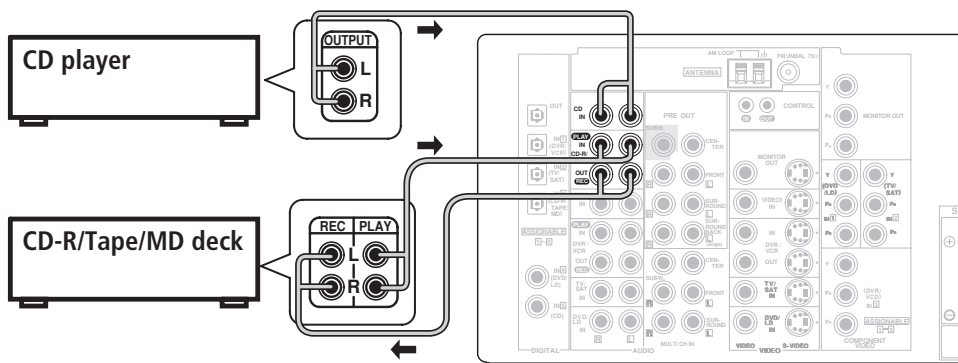

**Tip**

- If you don't plan on using the spare audio jacks for video components (for example, **VIDEO1**), you can use these for connecting another audio component, like a line-level turntable.

### Connecting multichannel analog components

If you prefer to use a separate component for decoding multichannel formats such as DVD Audio and SACD, you can connect a decoder or a DVD player with multichannel analog outputs to the multichannel inputs of this receiver. Note that the multichannel input can only be used when **MULTI CH IN** is selected (see page 39).

When connecting your equipment, always make sure the power is turned off and the power cord is disconnected from the AC outlet.

- The arrows indicate the direction of the signal.

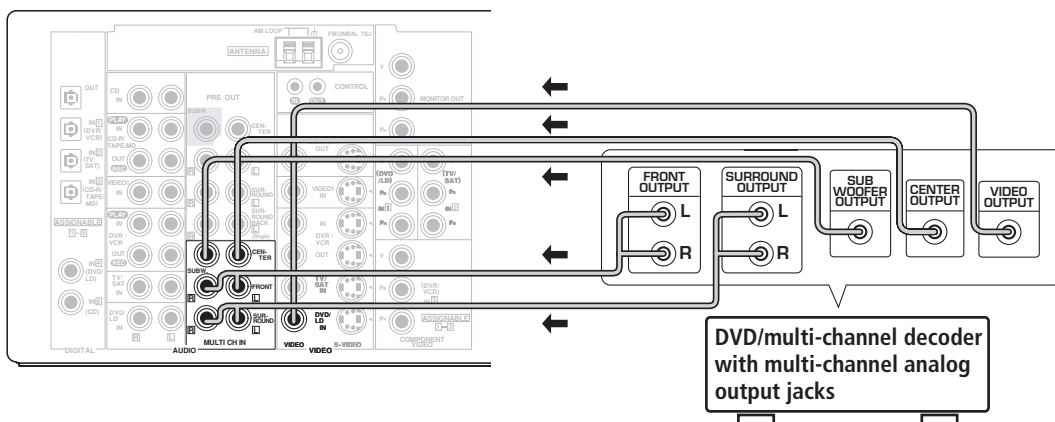

## Connecting video components

Connect your video components to the jacks as shown below. With digital video components (like a DVD player), you must use the connections shown on this page for the video signal, but in order to hear a digital source (like a DVD) you should hook up the audio to a digital input (see page 16). It is also a good idea to hook up your digital components with analog audio connections (see page 17).

For better quality video, you can hook up using the component video jacks or the S-video jacks (quality descends in this order) on the rear of the receiver instead of the regular video jacks.

When connecting your equipment, always make sure the power is turned off and the power cord is disconnected from the AC outlet.

- The arrows indicate the direction of the signal.

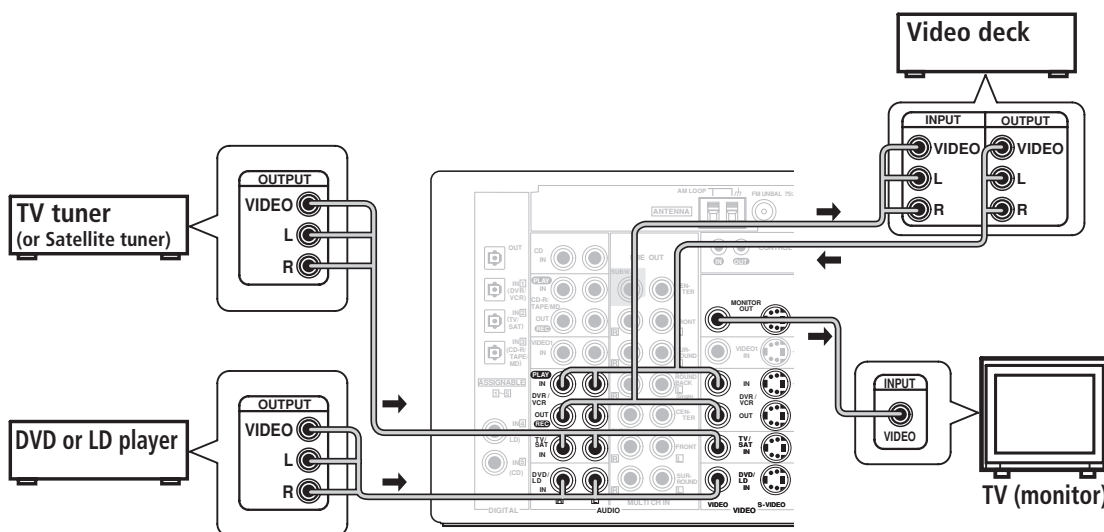

### Important

- Make sure to use the same type of cable for your video connections as you used to connect your TV.

## Connecting to the front panel video terminal

Front video connections are accessed via the front panel using the **VIDEO2** button. There are standard audio/video jacks as well as an S-video jack and an optical input. Hook them up the same way you made the rear panel connections.

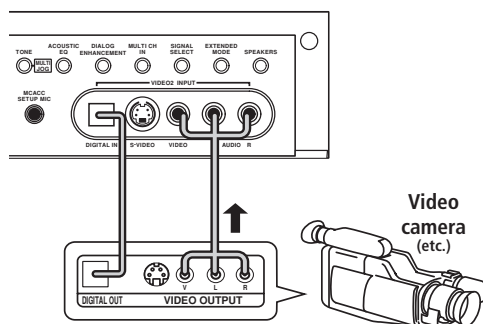

## Connecting antennas

Connect the AM loop antenna and the FM wire antenna as shown below. To improve reception and sound quality, connect external antennas (see *Using external antennas* below). Always make sure that the receiver is switched off and unplugged from the wall outlet before making or changing any connections.

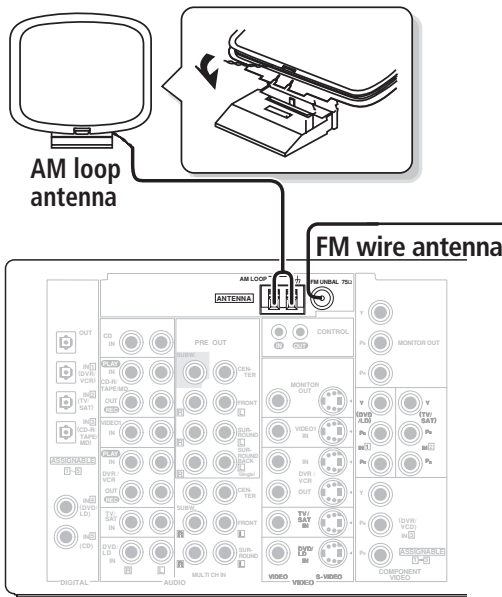

### FM wire antenna

Connect the FM wire antenna and fully extend vertically along a window frame or another suitable place that gives good reception.

### AM loop antenna

Assemble the antenna and connect to the receiver as shown above. The ground terminal (⏏) helps reduce radio noise (it is not an earthing plug). Attach (if necessary) and face in the direction that gives the best reception.

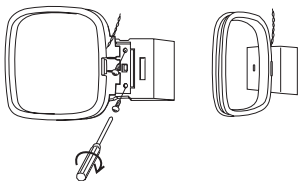

- Note that either wire can be inserted into the respective terminals when connecting.

### Antenna snap connectors

Twist the exposed wire strands together and insert into the hole, then snap the connector shut.

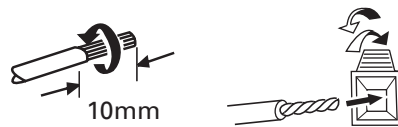

### Using external antennas

#### To improve FM reception

Use an F connector to connect an external FM antenna using a coaxial 75Ω cable.

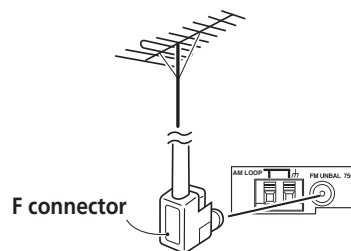

#### To improve AM reception

Connect a 5–6m length of vinyl-coated wire to the AM antenna terminal without disconnecting the supplied AM loop antenna.

For the best possible reception, suspend horizontally outdoors.

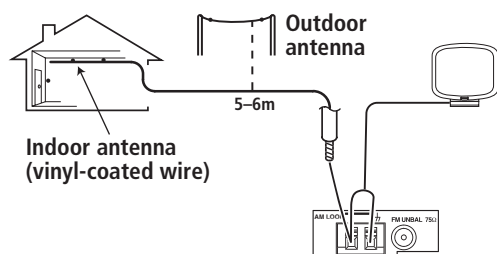

## Connecting the speakers

A complete setup of eight speakers (including the subwoofer) is shown below, but everyone's home setup will vary. Simply connect the speakers you have in the manner shown below. The receiver will work with just two stereo speakers (the front speakers in the diagram) but using at least three speakers is recommended, and a complete setup is best for surround sound. If you're not using a subwoofer, change the front speaker setting (see *Speaker Setting* on page 46) to large.

Make sure you connect the speaker on the right to the right terminal and the speaker on the left to the left terminal. Also make sure the positive and negative (+/−) terminals on the receiver match those on the speakers.

- You can use speakers with a nominal impedance between 6–16Ω (please see *Switching the speaker impedance* on page 73 if you plan to use speakers with an impedance of *less than 8Ω*).

Be sure to complete all connections before connecting this unit to the AC power source.

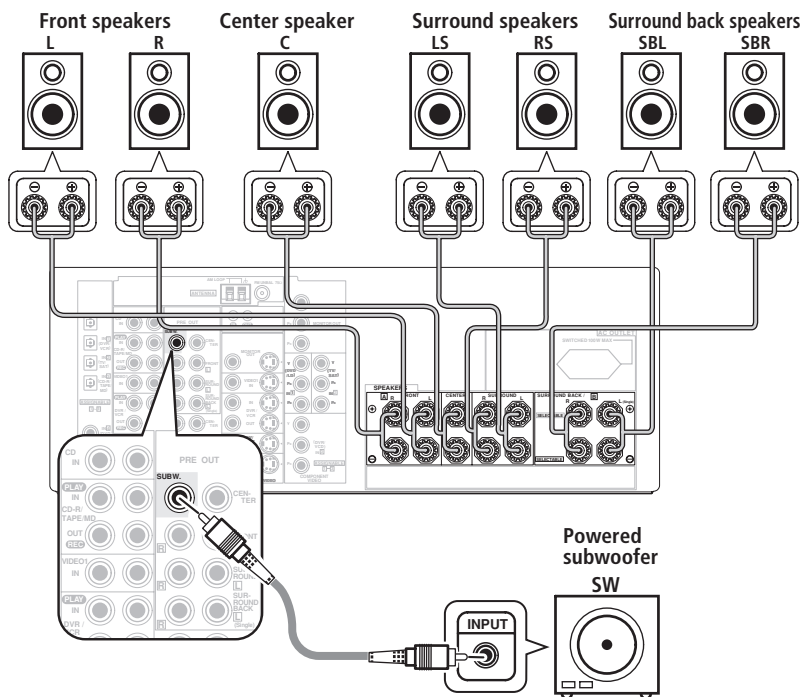

### ⚠ Caution

- These speaker terminals carry **HAZARDOUS LIVE** voltage. To prevent the risk of electric shock when connecting or disconnecting the speaker cables, disconnect the power cord before touching any uninsulated parts.
- Make sure no bare speaker wire is touching the back panel when the unit is switched on. The power may cut off as a safety measure.

### 📝 Note

- If you only have one surround back speaker, hook it up to the surround back left (**Single**) terminal.
- If you are planning on bi-amping your front speakers, or setting up a separate speaker system in another room, read through *Surround back speaker setting* on page 40 and make sure to connect your speakers as necessary (these connections are explained in *Other connections* on page 60).
- If you are using a THX certified subwoofer use the **THX INPUT** jack on the subwoofer (if your subwoofer has one) or switch the filter position to **THX** on your subwoofer.

### Speaker terminals

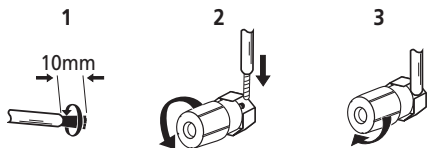

- 1 Twist exposed wire strands together.**
- 2 Loosen speaker terminal and insert exposed wire.**  
Make sure that all the bare speaker wire is twisted together and inserted fully into the speaker terminal. Use good quality speaker wire to connect the speakers to the receiver.
- 3 Tighten terminal.**

### Hints on speaker placement

Speakers are usually designed with a particular placement in mind. Some are designed to be floorstanding, while others should be placed on stands to sound their best. Some should be placed near a wall; others should be placed away from walls. We have provided a few tips on getting the best sound from your speakers (following), but you should also follow the guidelines on placement that the speaker manufacturer provided with your particular speakers to get the most out of them.

- Place the front left and right speakers at equal distances from the TV.
- When placing speakers near the TV, we recommend using magnetically shielded speakers to prevent possible interference, such as discoloration of the picture when the TV is switched on. If you do not have magnetically shielded speakers and notice discoloration of the TV picture, move the speakers farther away from the TV.
- If you're using a center speaker, place the front speakers at a wider angle. If not, place them at a narrower angle.
- Place the center speaker above or below the TV so that the sound of the center channel is localized at the TV screen. Also, make sure the center speaker does not cross the line formed by the leading edge of the front left and right speakers.
- It is best to angle the speakers towards the listening position. The angle depends on the size of the room. Use less of an angle for bigger rooms.
- Surround and surround back speakers should be positioned 60 cm–90 cm higher than your ears and tilted slight downward. Make sure the speakers don't face each other. For DVD-Audio, the speakers should be more directly behind the listener than for home theater playback.

- To achieve the best possible surround sound, install your speakers as shown below. Be sure all speakers are installed securely to prevent accidents and improve sound quality.

### Caution

- If you choose to install the center speaker on top of the TV, be sure to secure it with putty, or by other suitable means, to reduce the risk of damage or injury resulting from the speaker falling from the TV in the event of external shocks such as earthquakes.

### Overhead view of speaker setup

You can also refer to the 3-D speaker setup illustration on page 10.

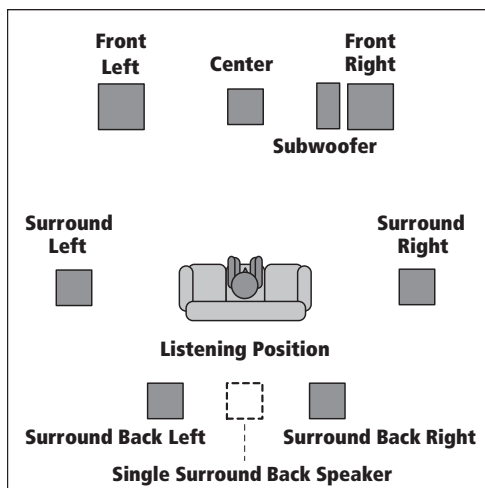

The diagrams below show suggested surround and surround back speaker orientation. The first diagram (fig. A) shows orientation with one surround back speaker (or none) connected. The second (fig. B) shows orientation with two surround back speakers connected.

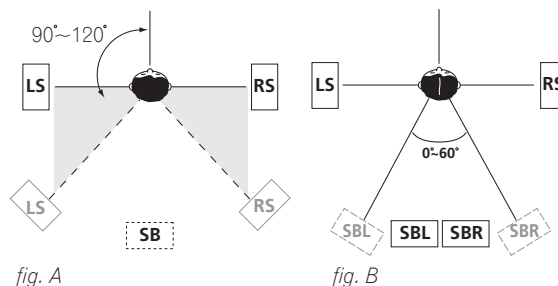

### 3-D view of 7.1 channel speaker setup



### THX speaker system setup

If you have a complete THX speaker system, follow the diagram below to place your speakers. Note that the surround speakers (⊠ indicates bi-polar radiating speakers) should output at an angle parallel to the listener.

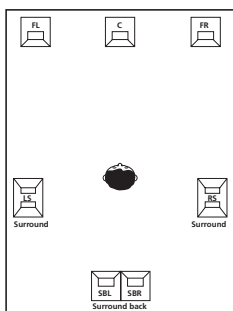

If you have two surround back speakers THX recommends placing them together and the same distance from your listening position so you can take advantage of the ASA feature. For more details see *Advanced Speaker Array (ASA)* on page 76.

See also *Surround Back Speaker Position* on page 48 to make the settings that will give you the best sound experience when using the Home THX modes (on page 32).

### AC outlet

Power supplied through this outlet is turned on and off by the receiver's power switch. Total electrical power consumption of connected equipment should not exceed 100 W.

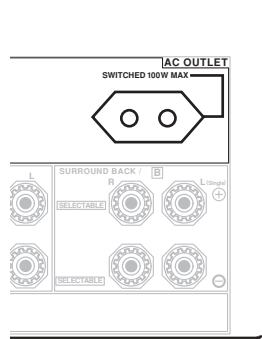

#### ⚠ Caution

- Do not connect a TV set, monitor, heater, or similar appliance to this unit's AC outlet.
- Do not connect appliances with high power consumption to the AC outlet in order to avoid overheating and fire risk. This can also cause the receiver to malfunction.
- Since a subwoofer or power amplifier can exceed the 100W maximum when playing sources at a high volume, this type of equipment should not be connected to the AC outlet.

#### ✎ Note

- This unit should be disconnected by removing the power plug from the wall socket when not in regular use (ex. when on vacation).

#### ⚠ Power cord caution

- Handle the power cord by the plug. Do not pull out the plug by tugging the cord and never touch the power cord when your hands are wet as this could cause a short circuit or an electric shock. Do not place the unit, a piece of furniture, etc., on the power cord, or pinch the cord. Never make a knot in the cord or tie it with other cords. The power cords should be routed such that they are not likely to be stepped on. A damaged power cord can cause a fire or give you an electrical shock. Check the power cord once in a while. When you find it damaged, ask your nearest Pioneer authorized independent service company for a replacement.

## Operating other Pioneer components

Many Pioneer components have SR **CONTROL** jacks which can be used to link components together so that you can use just the remote sensor of one component. When you use a remote control, the control signal is passed along the chain to the appropriate component.

Note that if you use this feature, *make sure that you also have at least one set of analog audio or video jacks connected* to another component for grounding purposes.

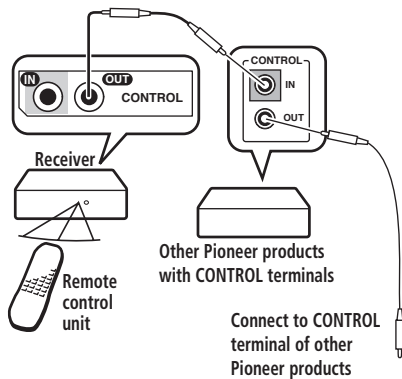

### Note

- If you want to control all your components using this receiver's remote control, refer to *Controlling the rest of your system* on page 54.
- If you have connected a remote control to the **CONTROL IN** jack (using a mini-plug cable), you won't be able to control this unit using the remote sensor.

## Chapter 4: Controls and displays

### Front panel

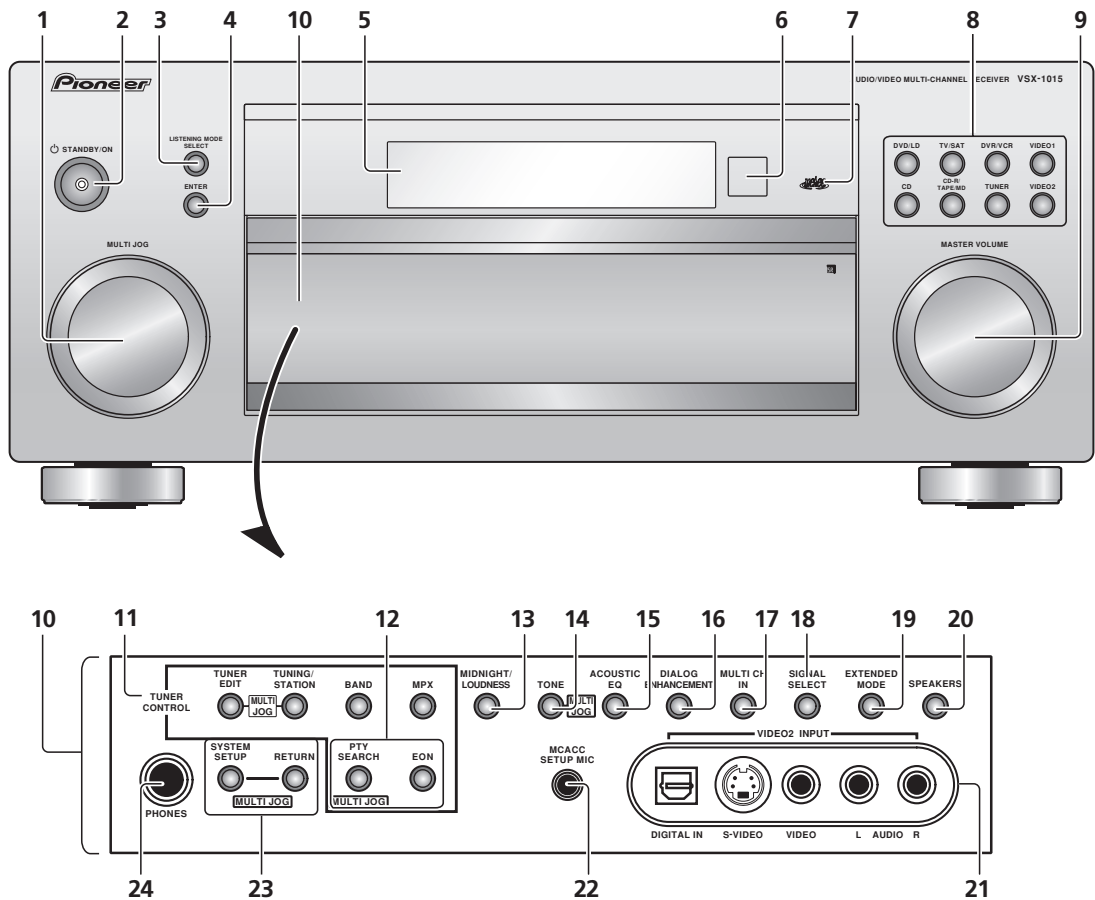



## 1 MULTI JOG dial

Use the **MULTI JOG** dial to select various settings and menu options.

## 2 STANDBY/ON

Switches the receiver between on and standby. Power indicator lights when the receiver is on.

## 3 LISTENING MODE SELECT

Use with the **MULTI JOG** dial to select the various listening modes (page 31).

## 4 ENTER

## 5 Character display

See *Display* on page 26.

## 6 Remote sensor

Receives the signals from the remote control.

## 7 MCACC indicator

Lights when Acoustic Calibration EQ (page 34) is on (Acoustic Calibration EQ is automatically set to **ALL CH ADJUST** after the Auto MCACC Setup (page 11) or EQ Auto Setting (page 43) is complete).

## 8 Input select buttons

Press to select an input source.

## 9 MASTER VOLUME dial

## 10 Front panel controls

To access the front panel controls, push gently on the lower third portion of the panel with your finger.

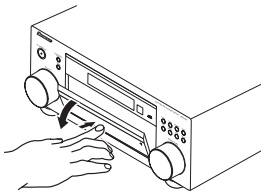

## 11 TUNER CONTROL

### TUNER EDIT

Use with the **MULTI JOG** dial to memorize and name stations for recall (page 50).

### TUNING/STATION

Use with the **MULTI JOG** dial to select station presets and radio frequencies (page 49).

### BAND

Switches between AM and FM radio bands (page 49).

### MPX

Press to receive a radio broadcast in mono (page 49).

## 12 PTY SEARCH

Use this button to search for RDS program types (page 52).

### EON

Use to search for programs that are broadcasting traffic or news information (page 52).

## 13 MIDNIGHT/LOUDNESS

Use Midnight when listening to movie soundtracks at low volume. Use Loudness to boost the bass and treble at low volume (page 38).

## 14 TONE

When the **STEREO** mode is selected, press this button to access the bass and treble controls, which you can then adjust with the **MULTI JOG** dial.

## 15 ACOUSTIC EQ

Press to select an Acoustic Calibration EQ setting (page 34).

## 16 DIALOG ENHANCEMENT

Use to make dialog stand out when watching TV or a movie (page 38).

## 17 MULTI CH IN

Press to select the component connected to the **MULTI CH IN** terminals (for example, a DVD-Audio player). See *Selecting the multichannel analog inputs* on page 39.

## 18 SIGNAL SELECT

Use to select an input signal (page 35).

## 19 EXTENDED MODE

Selects the surround back channel mode (page 36) or virtual surround back mode (page 37).

## 20 SPEAKERS

Use to change the speaker system (page 60).

## 21 VIDEO2 INPUT

See *Connecting to the front panel video terminal* on page 18.

## 22 MCACC SETUP MIC jack

Use to connect the supplied microphone.

## 23 System Setup menu controls

### SYSTEM SETUP

Use with the **MULTI JOG** dial to access the System Setup menu (page 11, page 40, page 64).

### RETURN

Press to confirm and exit the current menu screen.

## 24 PHONES jack

Use to connect headphones. When the headphones are connected, there is no sound output from the speakers.

## Display

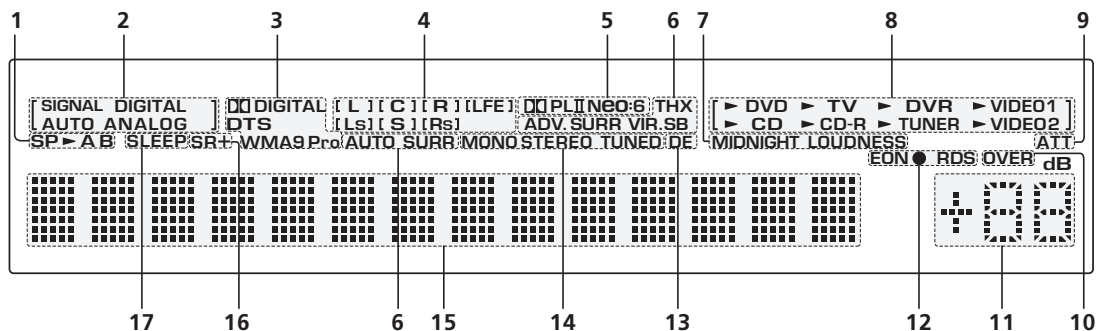

### 1 Speaker indicators (page 60)

Lights to indicate the current speaker system, **A** and/or **B**.

### 2 SIGNAL SELECT indicators

Lights to indicate the type of input signal assigned for the current component:

#### AUTO

Lights when **AUTO** signal select is on.

#### DIGITAL

Lights when a digital audio signal is detected.

#### ANALOG

Lights when an analog signal is detected.

### 3 Digital format indicators

#### DIGITAL

Lights when a Dolby Digital encoded signal is detected.

#### DTS

Lights when a DTS encoded signal is detected.

#### WMA9 Pro

Lights to indicate decoding of a WMA9 Pro signal.

### 4 Program format indicators

These change according to which channels are active in Dolby and DTS encoded sources.

**LS**, **S** and **RS** will light at the same time to indicate 6.1 channel sources.

- **L** – Left front channel
- **C** – Center channel
- **R** – Right front channel
- **LS** – Left surround channel
- **S** – Surround channel (mono) or surround back channel
- **RS** – Right surround channel
- **LFE** – Low frequency effects channel

### 5 Matrix decoding format indicators

#### DPLII

This lights to indicate Pro Logic II / Pro Logic IIx decoding (see *Listening in surround sound* on page 31 for more on this).

#### Neo:6

When one of the Neo:6 modes of the receiver is on, this lights to indicate Neo:6 processing (see *Listening in surround sound* on page 31 for more on this).

### 6 Listening mode indicators

#### THX

Lights when one of the Home THX modes is selected.

#### VIR.SB

Lights during Virtual surround back processing.

#### ADV.SURR

Lights when one of the Advanced Surround modes has been selected.

#### AUTO SURR

Lights when the Auto Surround feature is switched on (see *Auto playback* on page 31).

### 7 MIDNIGHT / LOUDNESS

When Midnight or Loudness listening is switched on, the corresponding indicator shows in the display.

### 8 Input source indicators

Light to indicate the input source you have selected.

### 9 ATT

Lights when **INPUT ATT** is used to attenuate (reduce) the level of the analog input signal.

### 10 OVER

Lights to indicate that the level of an analog source is too high. Use the attenuator (**INPUT ATT**) to reduce it.

### 11 Master volume level

Shows the overall volume level. **-80dB** indicates the minimum level, and **+12dB** indicates the maximum level.

## 12 EON / RDS indicators

### EON ●

**EON** lights when the EON mode is set, and flashes during reception of an EON broadcast. The ● indicator lights when the current station carries the EON service (page 52).

### RDS

Lights when an RDS broadcast is received (page 51).

## 13 DE

Lights when Dialog Enhancement (**DIALOG E**) is switched on (page 38).

## 14 TUNER indicators (page 49)

### STEREO

Lights when a stereo FM broadcast is being received in auto stereo mode.

### MONO

Lights when the mono mode is set using the **MPX** button.

### TUNED

Lights when a broadcast is being received.

## 15 Character display

Displays various system information (for example, the reason an operation is not possible may flash in the display).

## 16 SR+

Lights when the SR+ control mode has been switched on (see *Using the SR+ mode with a Pioneer plasma display* on page 63).

## 17 SLEEP

Lights when the receiver is in sleep mode (page 39).

## Remote control

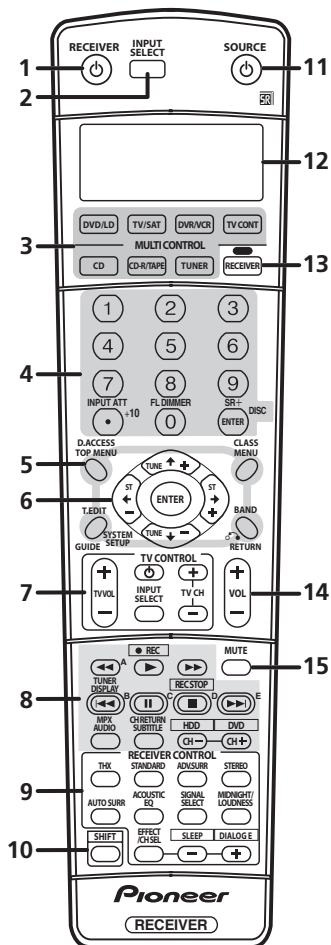

### 1 RECEIVER

This switches between standby and on for this receiver.

### 2 INPUT SELECT

Use to select the input source.

### 3 MULTI CONTROL buttons

Press to select control of other components (see *Controlling the rest of your system* on page 54).

### 4 Number buttons and other receiver/component controls

Use the number buttons to directly select a radio frequency (page 49) or the tracks on a CD, DVD, etc.

**DISC (ENTER)** can be used to enter commands for TV and can also be used to select a disc in a multi-CD player.

The following are accessed by pressing the **RECEIVER** button first:

#### INPUT ATT

Attenuates (lowers) the level of an analog input signal to prevent distortion.

#### FL DIMMER

Dims or brightens the display. Switching the dimmer to lowest setting will also switch off the MCACC indicator.

#### SR+

Switches the SR+ mode on/off (page 63).

### 5 Tuner/component control buttons/SYSTEM SETUP

The following button controls (except **SYSTEM SETUP**) can be accessed after you have selected the corresponding **MULTI CONTROL** button (**TUNER**, **DVD/LD**, **TV/SAT**, etc.)

#### D. ACCESS

After pressing, you can access a radio station directly using the number buttons (page 49).

#### TOP MENU

Displays the disc 'top' menu of a DVD.

#### T. EDIT

Press to memorize and name a station for recall (page 50).

#### GUIDE

Displays the guides on a digital TV.

#### SYSTEM SETUP

(Press **RECEIVER** first to access)

Use to access the System Setup menu (see page 40).

#### CLASS

Switches between the three banks (classes) of radio station presets (page 50).

#### MENU

Displays the disc menu of DVD-Video discs. It also displays TV menus.

#### BAND

Switches between the tuner AM and FM bands (page 49).

#### RETURN

Press to confirm and exit the current menu screen (also use to return to the previous menu with DVDs).

### 6 (TUNE/ST +/-) /ENTER

Use the arrow buttons when setting up your surround sound system (see page 40). Also used to control DVD menus/options and for deck 1 of a double cassette deck player. Use the **TUNE +/-** buttons to find radio frequencies and use **ST +/-** to find preset stations (page 50).

## 7 TV CONTROL buttons

These buttons are dedicated to control the TV assigned to the **TV CONT** button. Thus if you only have one TV to hook up to this system assign it to the **TV CONT MULTI CONTROL** button. If you have two TVs, assign the main TV to the **TV CONT** button (see page 54 for more on this).

### TV

Use to turn on/off the power of the TV.

### TV VOL +/-

Use to adjust the volume on your TV.



### INPUT SELECT

Use to select the TV input signal.

### TV CH +/-

Use to select channels.

## 8 Component control buttons

The main buttons (, , etc.) are used to control a component after you have selected it using the **MULTI CONTROL** buttons.

The controls above these buttons can be accessed after you have selected the corresponding **MULTI CONTROL** button (for example **DVD/LD**, **DVR/VCR** or **TV/SAT**).

### TUNER DISPLAY

Switches between named station presets, radio frequencies and RDS information (page 50).

### MPX

Switches between stereo and mono reception of FM broadcasts. If the signal is weak then switching to mono will improve the sound quality (page 49).

### AUDIO

Changes the audio language or channel on DVD discs.

### CH RETURN

Returns to the last channel selected with SAT and some TVs.

### SUBTITLE

Displays/changes the subtitles included in multilingual DVD-Video discs.

### CH +/-

Use to select channels when using a TV, VCR, DVR, etc.

The following DVR controls can be accessed by pressing **SHIFT**:

### REC

Starts recording.

### REC STOP

Stops recording.

### HDD/DVD

These buttons switch between the hard disk and DVD controls for DVD/HDD recorders.

## 9 RECEIVER CONTROL buttons

### THX

Press to select a Home THX listening mode (page 32).

### STANDARD

Press for Standard decoding and to switch between the various Pro Logic IIx and Neo:6 options (page 31).

### ADV. SURR

Use to switch between the various surround modes (page 33).

### STEREO

Switches between direct and stereo playback. Direct playback bypasses the tone controls and any other signal processing for the most accurate reproduction of a source (page 34).

### AUTO SURR

Press to have the receiver automatically detect what kind of source you're playing and select multichannel or stereo playback as necessary (page 31).

### ACOUSTIC EQ

Press to select an Acoustic Calibration EQ setting (page 34).

### SIGNAL SELECT

Use to select an input signal (page 35).

### MIDNIGHT/LOUDNESS

Use Midnight when listening to movie soundtracks at low volume. Use Loudness to boost the bass and treble at low volume (page 38).

### EFFECT/CH SEL

Press repeatedly to select a channel, then use +/- to adjust the level (page 47). Also adjusts the level of the Advanced Surround effects (page 33) as well as Dolby Pro Logic IIx Music (page 33) and Neo:6 Music parameters (page 34). You can then use the + and - buttons to make these adjustments.

### +/-

Use to adjust the effect and channel levels, as well as to change Dolby Pro Logic IIx and Neo:6 Music parameter settings.

### SLEEP (SHIFT & -)

Use to put the receiver in sleep mode and select the amount of time before the receiver turns off (page 39).

### DIALOG E (SHIFT & +)

Use to make dialog stand out when watching TV or a movie (page 38).

## 10 SHIFT

Press to access the DVR controls (above the component control buttons) as well as some **RECEIVER** controls.

**11 SOURCE**

Press to turn on/off other components connected to the receiver (see page 54 for more on this).

**12 Character display (LCD)**

This display shows information when transmitting control signals.

The following commands are shown when you're setting the remote to control other components (see *Controlling the rest of your system* on page 54):

**SETUP**

Indicates the setup mode, from which you choose the options below.

**PRESET**

See *Selecting preset codes directly* on page 54.

**LEARN**

See *Programming signals from other remote controls* on page 55.

**DIRECT F**

See *Direct function* on page 56.

**ERASE**

See *Erasing one of the remote control button settings* on page 56.

**RESET**

See *Erasing all of the remote control presets* on page 56.

**READ ID**

See *Confirming preset codes* on page 56.

**13 RECEIVER**

Switches the remote to control the receiver (used to select the green commands above the number buttons (**INPUT ATT**, etc)). Also use this button to set up surround sound (page 11, page 40).

**14 VOL +/-**

Use to set the listening volume.

**15 MUTE**

Mutes the sound or restores the sound if it has been muted (adjusting the volume also restores the sound).

**Operating range of remote control unit**

The remote control may not work properly if:

- There are obstacles between the remote control and the receiver's remote sensor.
- Direct sunlight or fluorescent light is shining onto the remote sensor.
- The receiver is located near a device that is emitting infrared rays.
- The receiver is operated simultaneously with another infrared remote control unit.

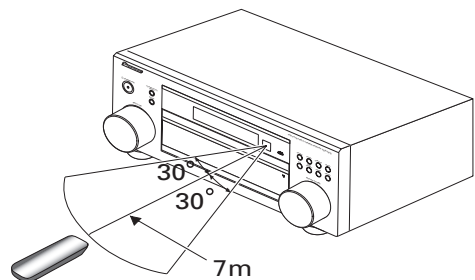



- **Dolby Digital EX** – Creates surround back channel sound for 5.1 channel sources and provides pure decoding for 6.1 channel sources (like Dolby Digital Surround EX)
- **DTS-ES** – Allows you to hear 6.1 channel playback with DTS-ES encoded sources
- **DTS Neo:6** – Allows you to hear 6.1 channel playback with DTS encoded sources

#### Note

- If the Extended mode (page 36) is switched to **OFF**, or the surround back speakers are set to **NO** (this happens automatically if the *Surround back speaker setting* on page 40 is set to anything but **Normal (SB)**), **Pro Logic IIx** becomes **Pro Logic II** (5.1 channel sound).
- In modes that give 6.1 channel sound, the same signal is heard from both surround back speakers.

### Using the Home THX modes

THX and Home THX are technical standards created by Lucasfilm Ltd. for cinema and home theater sound. Home THX is designed to make home theater audio sound more like what you hear in a cinema.

Different THX options will be available depending on the source and the Extended mode setting (see *Using the surround back channel (Extended mode)* on page 36 for more on this).

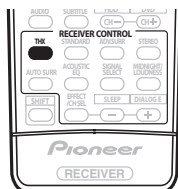

- **Press THX to select a THX listening mode.**

With *two channel sources*, select a matrix-decoding process for the **THX CINEMA** mode (see *Listening in surround sound* above for an explanation of each process):

- **Pro Logic IIx MOVIE+THX**
- **PRO LOGIC+THX**
- **Neo:6 CINEMA+THX**
- **THX GAMES MODE**

With *multichannel sources*, you can select (according to format):

- **THX CINEMA** – Gives you cinema-quality sound from your home theatre system using all the speakers in your setup

- **Pro Logic IIx MOVIE+THX** – Especially suited to movie sources, this allows you to hear 7.1 channel playback with 5.1 channel sources (only available when you're using two surround back speakers)
- **THX Surround EX** – Allows you to hear 6.1 or 7.1 channel playback with 5.1 channel sources
- **THX Select2 CINEMA** – Allows you to hear 7.1 channel playback with 5.1 channel sources
- **THX MUSICMODE** – Allows you to hear 7.1 channel playback with 5.1 channel sources
- **THX GAMES MODE** – Allows you to hear 7.1 channel playback from the output of a video game console

#### Note

- You won't be able to use the THX options with 88.2/96kHz PCM or DTS 96kHz/24 bit sources, or with the headphones connected.
- If you only have one surround back speaker connected, **THX Select2 CINEMA**, **THX MUSICMODE** and **THX GAMES MODE** are not available.
- When selecting the Dolby Pro Logic modes above, the display shows the mode you selected, then after a few seconds, shows **THX CINEMA**.



## Using the Advanced surround effects

The Advanced surround effects can be used for a variety of additional surround sound effects. Most Advanced Surround modes are designed to be used with film soundtracks, but some modes are also suited for music sources. Try different settings with various soundtracks to see which you like.

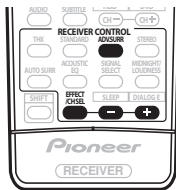

- Press **ADV. SURR (ADVANCED SURROUND)** repeatedly to select a listening mode.

- **ADVANCED MOVIE** – Simulates the relaxed environment of a movie theater, and is suitable for watching movies.
- **ADVANCED MUSIC** – Simulates the acoustic environment of a large concert hall and is suitable for music or musical sources.
- **TV SURROUND** – This mode produces surround sound for both mono and stereo TV sources. It is useful for older movies recorded with mono soundtracks.
- **SPORTS** – This is designed for sports programs with a lot of action, adding to the excitement by bringing background action to the forefront.
- **ADVANCED GAME** – Useful when playing video games. It works especially well with sound moving from left to right in game software with a lot of movement.
- **EXPANDED** – This mode is especially designed to give sound depth to stereo sources, and lets you hear two-channel (stereo) signals as simulated multichannel surround sound. Use with Dolby Pro Logic for a stereo surround effect. You can also use with Dolby Digital sources for a wider stereo field than the Standard modes.
- **7ch STEREO** – This can be selected to give multichannel sound to a stereo source, using all of the speakers in your setup.
- **PhonesSurround** – When listening through headphones, you can still get the effect of overall surround.

### Note

- Depending on the source and the sound mode you have selected, you may not get sound from the surround back speakers in your setup. For more on this, refer to *Using the surround back channel (Extended mode)* on page 36.

- If you press **ADV. SURR** when the headphones are connected, the **PhonesSurround** mode will automatically be selected.
- You can't use the Advanced Surround effects with 88.2/96kHz PCM or DTS 96kHz/24 bit sources.

### Tip

- When an Advanced Surround listening mode is selected, the effect level can be adjusted in the range of **10 to 90** by pressing **EFFECT/CH SEL** (until **EFFECT** shows in the display). The effect level can be set for each Advanced Surround mode by pressing **+/-**.

## Dolby Pro Logic IIx Music settings

When listening to 2-channel sources in Dolby Pro Logic IIx Music mode, there are three further parameters you can adjust: Center Width, Dimension, and Panorama.

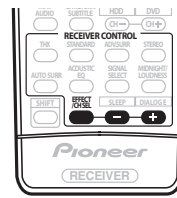

- 1 With '**DOLBY IIx MUSIC**' mode active, press **EFFECT/CH SEL** repeatedly to select **CENTER WIDTH**, **DIMENSION** or **PANORAMA**.

- **CENTER WIDTH** – Provides a better blend of the front speakers by spreading the center channel between the front right and left speakers, making it sound wider (higher settings) or narrower (lower settings). (This is applicable only when using a center speaker.)
- **DIMENSION** – Adjusts the depth of the surround sound balance from front to back, making the sound more distant (minus settings), or more forward (positive settings).
- **PANORAMA** – Extends the front stereo image to include the surround speakers for a 'wraparound' effect.

- 2 Use the **+/-** buttons to adjust the setting.

Center Width is adjustable between **0** and **7** (default : **3**); Dimension between **-3** and **+3** (default : **0**); Panorama is **On** or **Off** (default : **Off**).

- 3 Press **EFFECT/CH SEL** again to adjust other settings.

### Note

- If the Extended mode is switched off, **DOLBY IIx MUSIC** (above) becomes **DOLBY II Pro Logic II** (5.1 channel sound), however the above setting will still be effective.

### Neo:6 Music settings

- Default setting: **3**

When listening to 2-channel sources in Neo:6 Music mode, you can adjust the center image to create a wider stereo effect with vocals. Note that this is only available when using a center speaker.

**1 With Neo:6 MUSIC mode active, press EFFECT/CH SEL repeatedly to select C. IMAGE.**

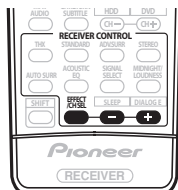

**2 Use the +/- buttons to adjust the setting.**

Adjust the effect from **0** (all center channel sent to front right and left speakers) to **10** (center channel sent to the center speaker only).

### Listening in stereo

When you select **STEREO** or **DIRECT**, you will hear the source through just the front left and right speakers (and possibly your subwoofer depending on your speaker settings). Dolby Digital and DTS multichannel sources are downmixed to stereo.

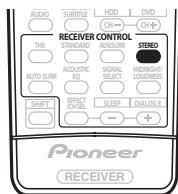

• **While listening to a source, press STEREO for stereo playback.**

Press repeatedly to switch between:

- **STEREO** – The audio is heard with your surround settings (such as channel level) and you can still use digital processing (such as the Midnight, Loudness, and Tone control functions).
- **DIRECT** – Bypass all effects and surround settings so that the audio remains as close to the source audio signal as possible.

#### Note

- If you switch on any signal processing features (for example, the Midnight listening mode or the tone controls) when **DIRECT** is selected, the receiver automatically switches to **STEREO**.

### Listening with Acoustic Calibration EQ

- Default setting: **OFF / ALL CH ADJ** (after the Auto MCACC Setup or EQ Auto Setting)

You can listen to sources using the Acoustic Calibration Equalization set in *Automatically setting up for surround sound (MCACC)* on page 11 or *Acoustic Calibration EQ* on page 43. Refer to these pages for more on Acoustic Calibration Equalization.

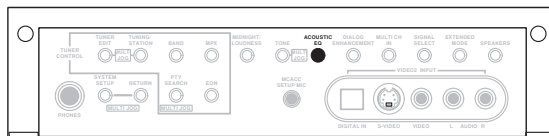
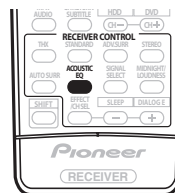

• **While listening to a source, press ACOUSTIC EQ.** Press repeatedly to select between:

- **ALL CH ADJ** – No special weighting is given to any one channel.
- **FRONT ALIGN** – All speakers are heard in accordance with the front speaker settings.
- **CUSTOM 1/2** – Custom settings
- **OFF** – Switches Acoustic Calibration EQ off.

The MCACC indicator on the front panel lights when Acoustic Calibration EQ is active.

#### Note

- You can't use Acoustic Calibration EQ with WMA9 Pro sources or when **MULTI CH IN** is switched on, and it has no effect when headphones are connected.
- If you switch on Acoustic Calibration EQ when **DIRECT** is selected, the receiver automatically switches to **STEREO**.

## Choosing the input signal

You need to hook up a component to both analog and digital inputs on the rear of the receiver to select between input signals.

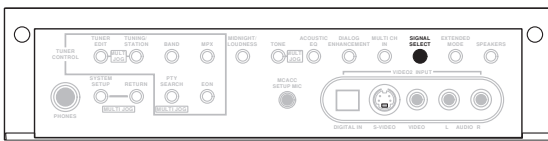
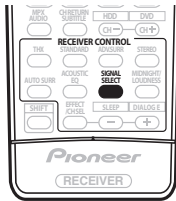

- Press **SIGNAL SELECT** to select the input signal corresponding to the source component.

Each press cycles through the options as follows:

- **AUTO** – The receiver selects the first available signal in the following order:  
**DIGITAL; ANALOG.**
- **ANALOG** – Selects the analog inputs.
- **DIGITAL** – Selects the digital input.

When set to **DIGITAL** or **AUTO**,  **DIGITAL** lights with Dolby Digital decoding, **DTS** lights with DTS decoding, and **WMA9 Pro** lights to indicate decoding of a WMA9 Pro signal.

### Note

- This receiver can only play back Dolby Digital, PCM (32kHz–96 kHz), DTS and WMA9 Pro digital signal formats (including DTS 96kHz/24 bit). With other digital signal formats, set to **ANALOG**.
- You may get digital noise when a LD or CD player compatible with DTS is playing an analog signal. To prevent noise, make the proper digital connections (page 16) and set the signal input to **DIGITAL**.
- Some DVD players don't output DTS signals. For more details, refer to the instruction manual supplied with your DVD player.

## Using the surround back channel (Extended mode)

- Default setting: **Extended ON**

You can have the receiver automatically use 6.1 or 7.1 decoding for 6.1 encoded sources (for example, Dolby Digital EX or DTS-ES), or you can choose to always use 6.1 or 7.1 decoding (for example, with 5.1 encoded material). With 5.1 encoded sources, a surround back channel will be generated, but the material may sound better in the 5.1 format for which it was originally encoded (in which case, you can simply switch the Extended mode off).

The table below indicates when you will hear the surround back channel when playing various kinds of sources. (●=Sound plays through surround back speaker(s))

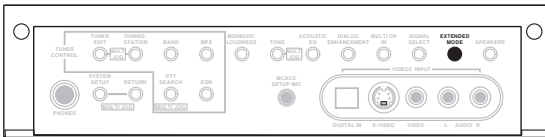

- Press **EXTENDED MODE (front panel)** repeatedly to cycle the surround back channel options.

Each press cycles through the options as follows:

- **Extended ON** – 6.1 or 7.1 decoding is always used (for example, a surround back channel will be generated for 5.1 encoded material)
- **Extended AUTO** – Automatically switches to 6.1 or 7.1 decoding for 6.1 encoded sources (for example, Dolby Digital EX or DTS-ES)
- **Extended OFF** – Maximum 5.1 playback

### Note

- You must have surround back speakers connected (and set to **LARGE** or **SMALL** in the *Speaker Setting* on page 46) and the *Surround back speaker setting* on page 40 must be set to **Normal (SB)** to hear the surround back channel.
- You can't use the surround back channel with headphones, the **STEREO** / **DIRECT** mode.
- You can't hear the surround back channel with DTS 96kHz/24 bit or PCM 96/88.2kHz sources.

Type of source	Extended mode	Standard / THX			Advanced surround
		Multichannel sources	Stereo sources		
			Pro Logic II x	Pro Logic	
Dolby Digital EX/DTS-ES encoded multichannel source with 6.1ch surround	ON	●			●
	AUTO	●			●
Dolby Digital/DTS encoded multichannel source	ON	●			●
	AUTO				●
WMA9 Pro encoded multichannel source	ON	●			
	AUTO				
Dolby Digital/DTS/PCM encoded stereo source	ON		●		●
	AUTO		●		●
WMA9 Pro encoded stereo source	ON		●		●
	AUTO		●		●
Analog 2-channel (stereo) source	ON		●		●
	AUTO		●		●

## Using the Virtual Surround Back mode (VirtualSB)

When you're not using surround back speakers, selecting this mode allows you to hear a virtual surround back channel through your surround speakers. For example, you can choose to listen to sources with no surround back channel information (for example, 5.1 encoded material) with emulated 6.1 encoding (**VirtualSB ON**). Sometimes the material may sound better in the 5.1 format for which it was originally encoded. In this case you can have the receiver only apply this effect to 6.1 encoded sources like Dolby Digital EX or DTS-ES (**VirtualSB AUTO**), or you can simply switch it off (**VirtualSB OFF**).

The table indicates when you will hear the virtual surround back channel. (●=Virtual surround back channel is active)

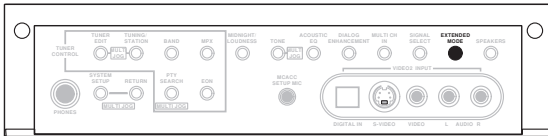

- Press **EXTENDED MODE** (front panel) repeatedly to cycle the virtual surround back channel options. Each press cycles through the options as follows:

- **VirtualSB ON** – Virtual Surround Back is always used (for example, on 5.1 encoded material)
- **VirtualSB AUTO** – Virtual Surround Back is automatically applied to 6.1 encoded sources (for example, Dolby Digital EX or DTS-ES)
- **VirtualSB OFF** – Virtual Surround Back mode is switched off

 **Note**

- You can't use the Virtual Surround Back mode with headphones, or with the **THX** or **STEREO / DIRECT** modes.
- You can only use the Virtual Surround Back mode if the surround speakers are on and the **Surr Back** setting is set to **NO** in the *Speaker Setting* on page 46.
- You can't hear the virtual surround back channel with DTS 96kHz/24 bit, PCM 96/88.2kHz, or WMA9 Pro sources.
- The Virtual Surround Back mode cannot be applied to sources that do not have surround channel information.

Type of source	VirtualSB mode	Standard			Advanced surround	
		Multichannel sources	Stereo sources			
			Pro Logic II	Pro Logic		Neo:6
Dolby Digital EX/DTS-ES encoded multichannel source with 6.1ch surround	ON	●			●	
	AUTO	●			●	
Dolby Digital/DTS encoded multichannel source	ON	●			●	
	AUTO				●	
Dolby Digital/DTS encoded stereo source; other digital stereo source	ON		●	●	●	
	AUTO			●	●	
Analog 2-channel (stereo) source	ON		●	●	●	
	AUTO			●	●	

## Using Loudness and Midnight listening

The Loudness listening feature can be used to get good bass and treble from music sources at low volume levels.

The Midnight listening feature allows you to hear effective surround sound of movies at low volume levels. The effect automatically adjusts according to the volume at which you're listening.

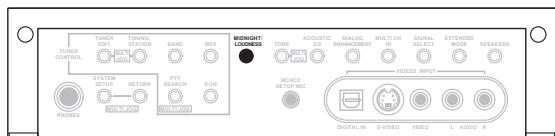
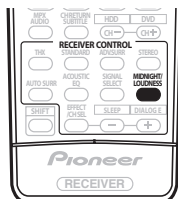

- Press **MIDNIGHT/LOUDNESS** to switch between **MIDNIGHT**, **LOUDNESS**, and **OFF**.

### Note

- You can't use **MIDNIGHT/LOUDNESS** with DTS 96kHz/24 bit, PCM 96/88.2kHz or WMA9 Pro sources, or when **MULTI CH IN**, or one of the THX modes has been selected.
- If you switch on Loudness or Midnight listening when **DIRECT** is selected, the receiver automatically switches to **STEREO**.

## Enhancing dialog

- Default setting: **DIALOG E OFF**

The Dialog Enhancement feature localizes dialog in the center channel to make it stand out from other background sounds in a TV or movie soundtrack.

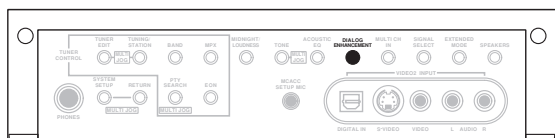
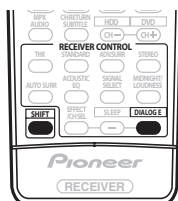

- Press **SHIFT+DIALOG E** to switch dialog enhancement on or off.

If you're using the front panel, press **DIALOG ENHANCEMENT**.

### Note

- You can't use dialog enhancement with DTS 96kHz/24 bit, PCM 96/88.2kHz or WMA9 Pro sources, or when one of the THX modes has been selected.

## Using the tone controls

Depending on what you are listening to, you may want to adjust the bass or treble using the front panel tone control.

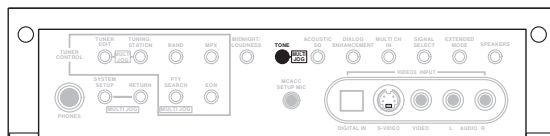
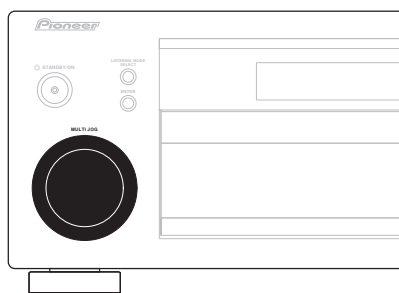

- 1 Press **TONE** to select the frequency you want to adjust.

Each press switches between **BASS** and **TREBLE**.

- 2 Use the **MULTI JOG** dial to change the amount of bass or treble as necessary.

The bass and treble can be adjusted from **-6** to **+6** (dB).

- Wait about five seconds for your changes to be input automatically.

### Note

- You can only use the tone controls when **STEREO/DIRECT** is selected. **DIRECT** will switch to **STEREO** when the tone controls are used.

## Playing other sources

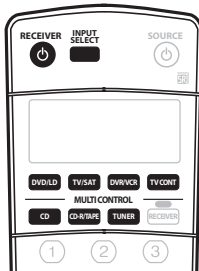

- 1 Turn on the power of the playback component.
- 2 Turn on the power of the receiver.
- 3 Select the source you want to playback.  
Use the **MULTI CONTROL** buttons (or **INPUT SELECT**).
- 4 Start playback of the component you selected in step 1.

## Selecting the multichannel analog inputs

If you have connected a decoder or a DVD player with multichannel analog outputs to this receiver (page 17), you must select the analog multichannel inputs for surround sound playback.

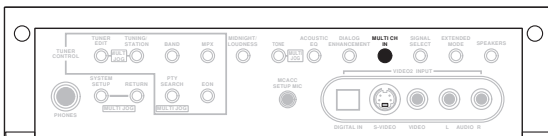

- 1 Make sure you have set the playback source to the proper output setting.  
For example, you might need to set your DVD player to output multichannel analog audio.
- 2 Press **MULTI CH IN** on the front panel.  
To cancel playback from the multichannel inputs, press **MULTI CH IN** once again.

### Note

- When playback from the multichannel inputs is selected, you can't use the **ACOUSTIC CAL EQ**, **DIALOG E**, **SIGNAL SELECT**, **INPUT ATT**, **TONE**, and **MIDNIGHT/LOUDNESS** buttons, as well as any of the listening modes (including **STEREO/DIRECT** and the Extended mode).
- When playback from the multichannel inputs is selected, only the volume and channel levels can be set.

- You can't listen to your speaker B (Second Zone) system during playback from the multichannel system inputs.

## Using the sleep timer

The sleep timer switches the receiver into standby after a specified amount of time so you can fall asleep without worrying about the receiver being left on all night. Use the remote control to set the sleep timer.

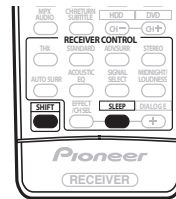

- Press **SHIFT+SLEEP** repeatedly to set the sleep time.

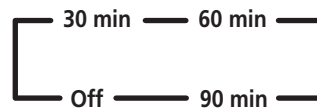

### Note

- You can check the remaining sleep time at any time by pressing **SHIFT+SLEEP** once. Pressing repeatedly will cycle through the sleep options again.
- You can also switch off the sleep timer simply by switching off the receiver.

## Chapter 6: The System Setup menu

### Making receiver settings from the System Setup menu

The following section shows you how to make detailed settings to specify how you're using the receiver (for example, if you want to set up two speaker systems in separate rooms), and also explains how to fine-tune individual speaker system settings to your liking.



#### 1 Switch on the receiver and your TV.

Use the **RECEIVER** button to switch on.

- If headphones are connected to the receiver, disconnect them.

#### 2 Press **RECEIVER** on the remote control, then press the **SYSTEM SETUP** button.

An on-screen display (OSD) appears on your TV. Use the **↑/↓/←/→** buttons and **ENTER** on the remote control to navigate through the screens and select menu items. Press **RETURN** to confirm and exit the current menu.

- Press **SYSTEM SETUP** at any time to exit the System Setup menu.

#### 3 Select the setting you want to adjust.

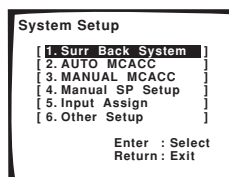

- **Surr Back System** – Specify how you are using your surround back speakers (see *Surround back speaker setting* below).
- **AUTO MCACC** – This is a quick and effective automatic surround setup (see *Automatically setting up for surround sound (MCACC)* on page 11).
- **MANUAL MCACC** – Fine tune your speaker settings and customize the Acoustic Calibration EQ (see *Manual MCACC speaker setup* below).
- **Manual SP Setup** – Specify the size, number, distance and overall balance of the speakers you've connected (see *Manual speaker setup* on page 45).
- **Input Assign** – Specify what you've connected to the digital and component video inputs (see *The Input Assign menu* on page 64).
- **Other Setup** – Make customized settings to reflect how you are using the receiver (see *The Other Setup menu* on page 65).

### Surround back speaker setting

- Default setting: **Normal (SB)**

There are several ways you can use the surround back speaker channels with this system. In addition to a normal home theater setup where they are used for the surround back speakers, they can be used for bi-amping the front speakers or as a separate speaker system in another room.

#### 1 Select 'Surr Back System' from the System Setup menu.

See *Making receiver settings from the System Setup menu* above if you're not already at this screen.

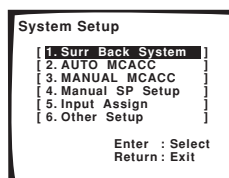



## 2 Select the surround back speaker setting.

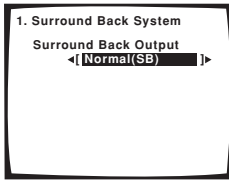

- **Normal (SB)** – Select for normal home theater use with surround back speakers in your main (speaker system A) setup.
- **Second Zone** – Select to use the (surround back) B speaker terminals to listen to stereo playback in another room (see *Second Zone speaker B setup* on page 60).
- **Front Bi-Amp** – Select this setting if you're bi-amping your front speakers (see *Bi-amping your front speakers* on page 61).

## 3 When you're finished, press RETURN.

You will return to the System Setup menu.

## Manual MCACC speaker setup

You can use the settings in the Manual MCACC setup menu to make detailed adjustments when you're more familiar with the system. Before making these settings, you should have already completed *Automatically setting up for surround sound (MCACC)* on page 11.

You only need to make these settings once (unless you change the placement of your current speaker system or add new speakers).

### Important

- For some of the settings below, you'll have to connect the setup microphone to the front panel and place it about ear level at your normal listening position. See *Automatically setting up for surround sound (MCACC)* on page 11 if you're unsure how to do this. Also see *Other problems when using the Auto MCACC Setup* on page 13 for notes regarding high background noise levels and other possible interference.
- If you're using a subwoofer, switch it on and turn up the volume to the middle position.

## 1 Select 'MANUAL MCACC' from the System Setup menu.

See *Making receiver settings from the System Setup menu* above if you're not already at this screen.

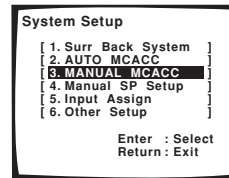

## 2 Select the setting you want to adjust.

If you're doing this for the first time, you might want to make these settings in order.

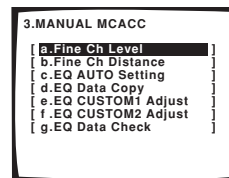

- **Fine Ch Level** – Make fine adjustments to the overall balance of your speaker system (see *Fine Channel Level* below).
- **Fine Ch Distance** – Make precise delay settings for your speaker system (see *Fine Channel Distance* on page 42).

The last five settings are specifically for customizing the parameters explained in *Acoustic Calibration EQ* below:

- **EQ AUTO Setting** – Measure the acoustic characteristics of your room and automatically adjust the frequency balance of your speaker system (see *Setting the Acoustic Calibration EQ automatically* below).
- **EQ Data Copy** – Copy Acoustic Calibration EQ settings for manual adjustment (see *Copying your Acoustic Calibration EQ settings* below).
- **EQ CUSTOM1/2 Adjust** – Make detailed manual adjustments to your custom Acoustic Calibration EQ settings (see *Setting the Acoustic Calibration EQ manually* on page 44).
- **EQ Data Check** – Check the **ALL CH ADJUST**, **FRONT ALIGN** and custom settings using the on-screen display (see *Checking your Acoustic Calibration EQ settings* on page 44).

## Fine Channel Level

- Default setting: **0dB** (all channels)

You can achieve better surround sound by properly adjusting the overall balance of your speaker system. The following setting can help you make detailed adjustments that you may not achieve using the *Manual speaker setup* on page 45.

### 1 Select 'Fine Ch Level' from the Manual MCACC setup menu.

The volume increases to the **0dB** reference level.

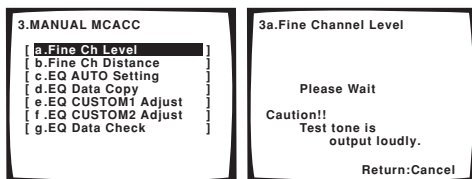

### 2 Adjust the level of the left channel.

This will be the reference speaker level, so you may want to keep the level around **0dB** so that you'll have plenty of room to adjust the other speaker levels.

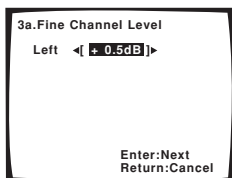

- After pressing **ENTER**, test tones will be output.

### 3 Select each channel in turn and adjust the levels (+/- 10dB) as necessary.

Use  $\leftarrow/\rightarrow$  (cursor left/right) to adjust the volume of the speaker you selected to match the reference speaker. When it sounds like both tones are the same volume, press **ENTER** to confirm and continue to the next channel.

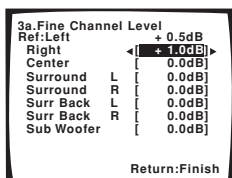

- For comparison purposes, the reference speaker will change depending on which speaker you select.
- If you want to go back and adjust a channel, simply use  $\uparrow/\downarrow$  (cursor up/down) to select it.

### 4 When you're finished, press RETURN.

You will return to the Manual MCACC setup menu.

## Fine Channel Distance

- Default setting: **2.0 m** (all channels)

For proper sound depth and separation with your system, it is necessary to add a slight bit of delay to some speakers so that all sounds will arrive at the listening position at the same time. The following setting can help you make detailed adjustments that you may not achieve using the *Manual speaker setup* below.

### 1 Select 'Fine Ch Distance' from the Manual MCACC setup menu.

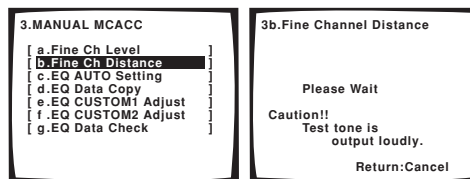

### 2 Adjust the distance of the left channel from the listening position.

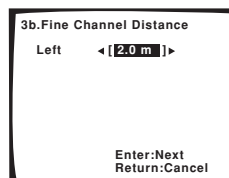

### 3 Select each channel in turn and adjust the distance as necessary.

Use  $\leftarrow/\rightarrow$  (cursor left/right) to adjust the delay of the speaker you selected to match the reference speaker. The delay is measured in terms of speaker distance from **0.1 to 9.0 meters**.

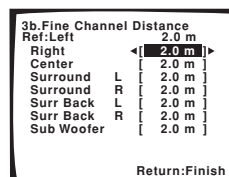

Listen to the reference speaker and use it to measure the target channel. From the listening position, face the two speakers with your arms outstretched pointing at each speaker. Try to make the two tones sound as if they are arriving simultaneously at a position slightly in front of you and between your arm span.

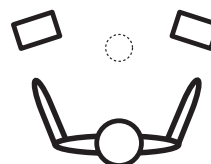

When it sounds like the delay settings are matched up, press **ENTER** to confirm and continue to the next channel.

- For comparison purposes, the reference speaker will change depending on which speaker you select.
- If you want to go back and adjust a channel, simply use **↑/↓** (cursor up/down) to select it.

#### 4 When you're finished, press RETURN.

You will return to the Manual MCACC setup menu.

### Acoustic Calibration EQ

Acoustic Calibration Equalization is a kind of room equalizer for your speakers (excluding the subwoofer). It works by measuring the acoustic characteristics of your room and neutralizing the ambient characteristics that can color the original source material. This provides a 'flat' equalization setting. If you're not satisfied with the automatic adjustment, you can also adjust these settings manually to get a frequency balance that suits your tastes.

#### Setting the Acoustic Calibration EQ automatically

If you have already completed *Automatically setting up for surround sound (MCACC)* on page 11, **ALL CH ADJUST** and **FRONT ALIGN** (below) should already be set. Therefore, if you want to adjust your settings manually, you can skip to *Setting the Acoustic Calibration EQ manually* below.

#### 1 Select 'EQ AUTO Setting' from the Manual MCACC setup menu.

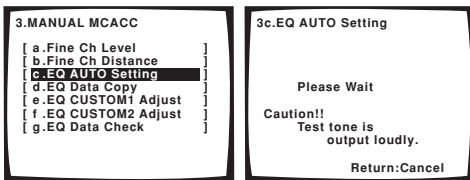

- Make sure the microphone is connected.
- If you're using a subwoofer, it is automatically detected every time you switch on the system. Make sure it is on and the volume is at the middle position.
- See *Other problems when using the Auto MCACC Setup* on page 13 for notes regarding high background noise levels and other possible interference.

#### 2 Wait for the Auto MCACC Setup to finish.

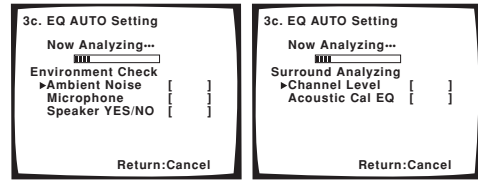

As the receiver outputs test tones, the frequency balance is adjusted automatically for the following settings:

- **ALL CH ADJUST** – A 'flat' setting where all the speakers are set individually so no special weighting is given to any one channel.
- **FRONT ALIGN** – All speakers are set in accordance with the front speaker settings (no equalization is applied to the front left and right channels).

You will return to the Acoustic Cal EQ setup menu after the Acoustic Calibration Equalization is set.

#### Copying your Acoustic Calibration EQ settings

If you want to manually adjust the Acoustic Calibration EQ (see *Setting the Acoustic Calibration EQ manually* below), we recommend copying the **ALL CH ADJUST** or the **FRONT ALIGN** settings from the **EQ AUTO** setup above (or from *Automatically setting up for surround sound (MCACC)* on page 11) to one of the custom settings. Instead of just a flat EQ curve, this will give you a reference point from which to start.

#### 1 Select 'EQ Data Copy' from the Manual MCACC setup menu.

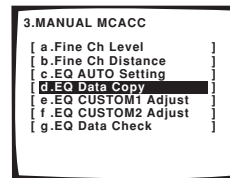

#### 2 Select CUSTOM1 or CUSTOM2 then use the ←/→ (cursor left/right) buttons to select the setting you want to copy.

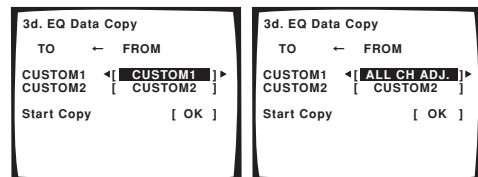

- You can also copy from one custom setting to another. For more on the **ALL CH ADJUST** and **FRONT ALIGN** settings, see *Setting the Acoustic Calibration EQ automatically* above.

### 3 Select 'OK' to copy and confirm.

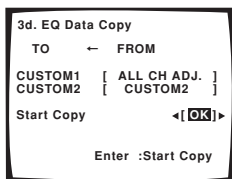

### Setting the Acoustic Calibration EQ manually

Before manually adjusting the Acoustic Calibration EQ, we recommend copying the **ALL CH ADJUST** or the **FRONT ALIGN** settings from the auto setup above (or from *Automatically setting up for surround sound (MCACC)* on page 11) to one of the custom settings. Instead of just a flat EQ curve, this will give you a reference point from which to start (see *Copying your Acoustic Calibration EQ settings* above for how to do this).

### 1 Select 'EQ CUSTOM1 Adjust or EQ CUSTOM2 Adjust' from the Manual MCACC setup menu.

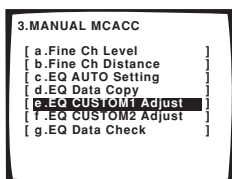

### 2 Select which method you would like to use to adjust the overall frequency balance.

It is best to choose whichever one you copied to the custom setting in *Copying your Acoustic Calibration EQ settings* above.

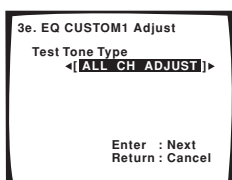

- **ALL CH ADJUST** – All the speakers can be set independently so no special weighting is given to any one channel. When adjusting, test tones will sound for each individual channel.
- **FRONT ALIGN** – Speakers are set in accordance with the front speaker settings. The sound of the test tone will alternate between the left front (reference) speaker and the target speaker.

### 3 Select the channel(s) you want and adjust to your liking.

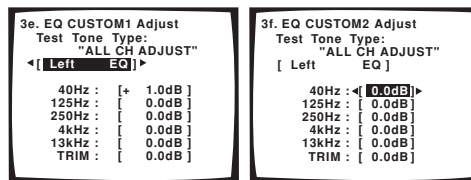

Use the ←/→ (cursor left/right) buttons to select the channel.

Use the ↑/↓ (cursor up/down) buttons to select the frequency and ←/→ (cursor left/right) to boost or cut the EQ. When you're finished, go back to the top of the screen and use the ←/→ (cursor left/right) buttons to select the next channel.

- The front speakers can't be adjusted if you selected **FRONT ALIGN**.
- The **OVER** indicator shows in the display if the frequency adjustment is too drastic and might distort. If this happens, bring the level down until **OVER** disappears from the display.

### Tip

- Changing the frequency curve of one channel too drastically will affect the overall balance. If the speaker balance seems uneven, you can raise or lower channel levels using test tones with the **TRIM** feature. Use ↑/↓ (cursor up/down) to select **TRIM** then use ←/→ (cursor left/right) to raise or lower the channel level for the current speaker.

### 4 When you're finished, press RETURN.

You will return to the Manual MCACC setup menu.

### Checking your Acoustic Calibration EQ settings

After you have completed an automatic or manual Acoustic Calibration EQ adjustment, you can check the **ALL CH ADJUST**, **FRONT ALIGN** and custom settings using the on-screen display.

### 1 Select 'EQ Data Check' from the Manual MCACC setup menu.

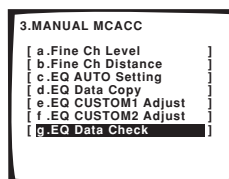

## 2 Select the setting you want to check.

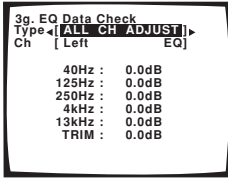

- It is useful to do this while a source is playing so you can compare the different settings.

## 3 Select the channels you want, pressing ENTER when you're finished checking each one.

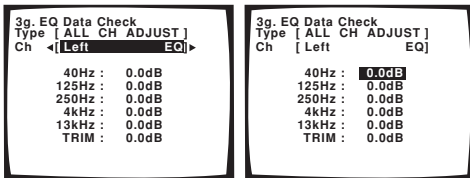

## 4 When you're finished, press RETURN.

You will return to the Manual MCACC setup menu.

## Manual speaker setup

This receiver allows you to make detailed settings to optimize the surround sound performance. You only need to make these settings once (unless you change the placement of your current speaker system or add new speakers).

These settings are designed to fine-tune your system, but if you're satisfied with the settings made in *Automatically setting up for surround sound (MCACC)* on page 11, it isn't necessary to make all of these settings.

### Caution

- The test tones used in the System Setup are output at high volume (the volume increases to 0 db automatically).

## 1 Select 'Manual SP Setup' then press ENTER.

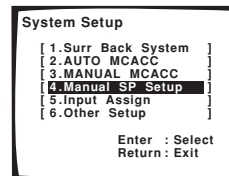

## 2 Select the setting you want to adjust.

If you are doing this for the first time, you may want to adjust these settings in order:

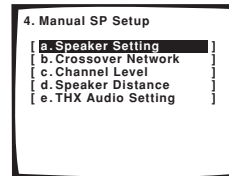

- **Speaker Setting** – Specify the size and number of speakers you've connected (page 46).
- **Crossover Network**– Specify which frequencies will be sent to the subwoofer (see *Crossover Network* below).
- **Channel Level** – Adjust the overall balance of your speaker system (page 47).
- **Speaker Distance** – Specify the distance of your speakers from the listening position (page 48).
- **THX Audio Setting** – Specify whether you are using a THX speaker setup (page 48).

## 3 Make the adjustments necessary for each setting, pressing RETURN to confirm after each screen.

## Speaker Setting

Use this setting to specify your speaker configuration (size, number of speakers). It is a good idea to make sure that the settings made in *Automatically setting up for surround sound (MCACC)* on page 11 are correct.

### 1 Select 'Speaker Setting' from the Manual SP Setup menu.

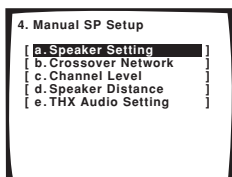

### 2 Choose the set of speakers that you want to set then select a speaker size.

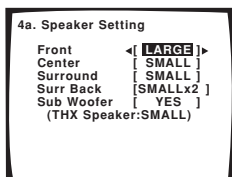

Use  $\leftarrow/\rightarrow$  (cursor left/right) to select the size (and number) of each of the following speakers:

- **Front** – Select **LARGE** if your front speakers reproduce bass frequencies effectively, or if you didn't connect a subwoofer. Select **SMALL** to send the bass frequencies to the subwoofer.
- **Center** – Select **LARGE** if your center speaker reproduces bass frequencies effectively, or select **SMALL** to send bass frequencies to the other speakers or subwoofer. If you didn't connect a center speaker, choose **NO** (the center channel is sent to the front speakers).
- **Surround** – Select **LARGE** if your surround speakers reproduce bass frequencies effectively. Select **SMALL** to send bass frequencies to the other speakers or subwoofer. If you didn't connect surround speakers choose **NO** (the sound of the surround channels is sent to the front speakers or a subwoofer).
- **Surr Back** – Select the number of surround back speakers you have (one, two or none). Select **LARGE** if your surround back speakers reproduce bass frequencies effectively. Select **SMALL** to send bass frequencies to the other speakers or subwoofer. If you didn't connect surround back speakers choose **NO**.
- **Subwoofer** – LFE signals and bass frequencies of channels set to **SMALL** are output from the subwoofer when **YES** is selected (see notes below). Choose the **PLUS** setting if you want the subwoofer to

output bass sound continuously or you want deeper bass (the bass frequencies that would normally come out the front and center speakers are also routed to the subwoofer). If you did not connect a subwoofer choose **NO** (the bass frequencies are output from other speakers).

### Note

- If you selected **Second Zone** or **Front Bi-Amp** (in *Surround back speaker setting* on page 40) you can't adjust the surround back settings.
- If you select **SMALL** for the front speakers the subwoofer will automatically be fixed to **YES**. Also, the center and surround speakers can't be set to **LARGE** if the front speakers are set to **SMALL**. In this case, all bass frequencies are sent to the subwoofer.
- If the surround speakers are set to **NO**, the surround back speakers will automatically be set to **NO**.
- If you select one surround back speaker only, make sure that speaker is hooked up to the left surround back terminal.
- If you're using a THX speaker setup, confirm that all speakers are set to **SMALL**.

### 3 When you're finished, press RETURN.

You will return to the Manual SP Setup menu.

### Tip

- If you have a subwoofer and like lots of bass, it may seem logical to select **LARGE** for your front speakers and **PLUS** for the subwoofer. This may not, however, yield the best bass results. Depending on the speaker placement of your room you may actually experience a decrease in the amount of bass due low frequency cancellations. In this case, try changing the position or direction of speakers. If you can't get good results, listen to the bass response with it set to **PLUS** and **YES** or the front speakers set to **LARGE** and **SMALL** alternatively and let your ears judge which sounds best. If you're having problems, the easiest option is to route all the bass sounds to the subwoofer by selecting **SMALL** for the front speakers.

## Crossover Network

- Default setting: **80Hz**

This setting decides the cutoff between bass sounds playing back from the speakers selected as **LARGE**, or the subwoofer, and bass sounds playing back from those selected as **SMALL**. It also decides where the cutoff will be for bass sounds in the LFE channel.

### Note

- For more on selecting the speaker sizes, see *Speaker Setting* above.

### 1 Select 'Crossover Network' from the Manual SP Setup menu.

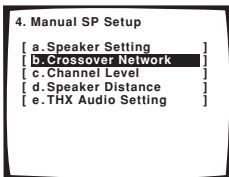

### 2 Choose the frequency cutoff point.

Frequencies below the cutoff point will be sent to the subwoofer (or **LARGE** speakers).

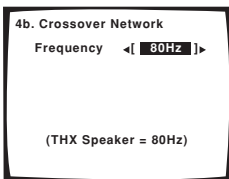

### 3 When you're finished, press RETURN.

You will return to the Manual SP Setup menu.

### Note

- If you're using a THX speaker setup, confirm that the crossover frequency is set to **80Hz**.

## Channel Level

Using the channel level settings, you can adjust the overall balance of your speaker system, an important factor when setting up a home theater system.

### 1 Select 'Channel Level' from the Manual SP Setup menu.

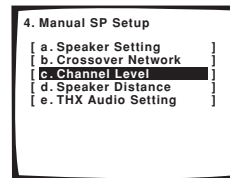

### 2 Select a setup option.

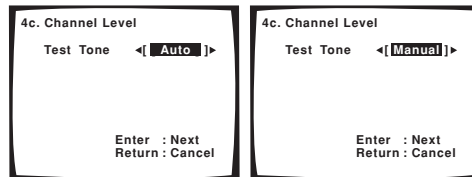

- **Manual** – Move the test tone manually from speaker to speaker and adjust individual channel levels.
- **Auto** – Adjust channel levels as the test tone moves from speaker to speaker automatically.

### 3 Confirm your selected setup option.

The test tones will start after you press **ENTER**.

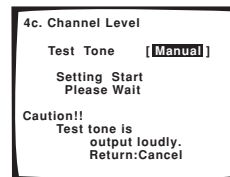

### 4 Adjust the level of each channel using the <=> (cursor left/right) buttons.

If you selected **Manual**, use ↑/↓ (cursor up/down) to switch speakers. The **Auto** setup will output test tones in the order shown on-screen:

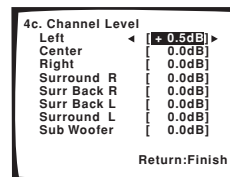

Adjust the level of each speaker as the test tone is emitted.

### Note

- If you are using a Sound Pressure Level (SPL) meter, take the readings from your main listening position and adjust the level of each speaker to 75 dB SPL (C-weighting/slow reading).
- The subwoofer test tone is output at low volumes. You may need to adjust the level after testing with an actual soundtrack.

### 5 When you're finished, press RETURN.

You will return to the Manual SP Setup menu.

### Tip

- You can change the channel levels at any time by using **EFFECT/CH SEL** and **+/-** on the remote control. You can set separate levels for the listening modes (Standard, Home THX, Advanced and Stereo/Direct) as well as for the **MULTI CH IN** mode. However, the listening mode setting will be cleared if you use one of the setups (for example, the System Setup or Auto Setup) to set the channel levels at a later date.

## Speaker Distance

For good sound depth and separation from your system, you need to specify the distance of your speakers from the listening position. The receiver can then add the proper delay needed for effective surround sound.

### 1 Select 'Speaker Distance' from the Manual SP Setup menu.

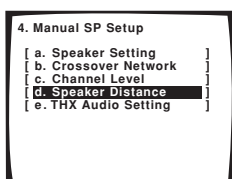

### 2 Adjust the distance of each speaker using the ←/→ (cursor left/right) buttons.

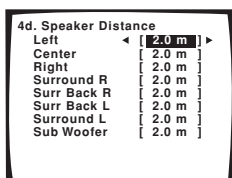

You can adjust the distance of each speaker in 0.1 meter increments.

### 3 When you're finished, press RETURN.

You will return to the Manual SP Setup menu.

### Tip

- For best surround sound, make sure the surround back speakers are the same distance from the listening position.

## Surround Back Speaker Position

For the most effective results when using the THX Select2 Cinema and THX MusicMode listening modes (see *Using the Home THX modes* on page 32) with the Advanced Speaker Array (ASA) system (see *About THX* on page 75), it is required that you make the setting. See *THX speaker system setup* on page 22 for more on this.

### Note

- If you don't have surround back speakers, or just have one, you won't be able to select this setting.

### 1 Select 'THX Audio Setting' from the Manual SP Setup menu.

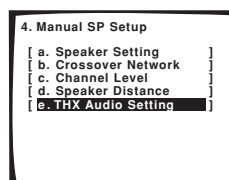

### 2 Specify the distance of your surround back speakers from each other.

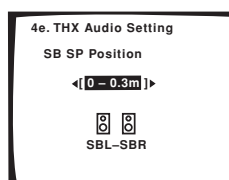

- **0–0.3 m** – Surround speakers within 30 cm apart (best for THX surround sound).
- **>0.3–1.2 m** – Surround speakers between 30 cm and 1.2 m apart.
- **1.2 m<** – Surround speakers more than 1.2 m apart.

### 3 When you're finished, press RETURN.

You will return to the Manual SP Setup menu.



## Chapter 7: Using the tuner

### Listening to the radio

The following steps show you how to tune in to FM and AM radio broadcasts using the automatic (search) and manual (step) tuning functions. If you already know the frequency of the station you want, see *Tuning directly to a station* below. Once you are tuned to a station you can memorize the frequency for recall later—see *Saving station presets* on page 50 for more on how to do this.

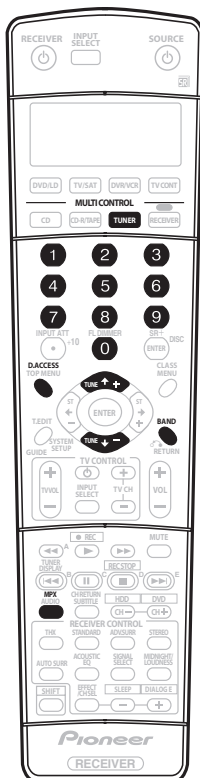

- 1 Press the TUNER button to select the tuner.**
- 2 Use the BAND button to change the band (FM or AM), if necessary.**  
Each press switches the band between FM and AM.
- 3 Tune to a station.**  
There are three ways to do this:

#### Automatic tuning

To search for stations in the currently selected band, press and hold **TUNE +/-** for about a second. The receiver will start searching for the next station, stopping when it has found one. Repeat to search for other stations.

#### Manual tuning

To change the frequency one step at a time, press **TUNE +/-**.

#### High speed tuning

Press and hold **TUNE +/-** for high speed tuning. Release the button at the frequency you want.

### Improving FM stereo sound

If the **TUNED** or **STEREO** indicators don't light when tuning to an FM station because the signal is weak, press the **MPX** button to switch the receiver into mono reception mode. This should improve the sound quality and allow you to enjoy the broadcast.

### Tuning directly to a station

Sometimes, you'll already know the frequency of the station you want to listen to. In this case, you can simply enter the frequency directly using the number buttons on the remote control.

- 1 Press the TUNER button to select the tuner.**
- 2 Use the BAND button to change the band (FM or AM), if necessary.**  
Each press switches the band between FM and AM.
- 3 Press D.ACCESS (Direct Access).**
- 4 Use the number buttons to enter the frequency of the radio station.**  
For example, to tune to **106.00** (FM), press **1, 0, 6, 0, 0**.  
If you make a mistake halfway through, press **D.ACCESS** twice to cancel the frequency and start over.

## Saving station presets

If you often listen to a particular radio station, it's convenient to have the receiver store the frequency for easy recall whenever you want to listen to that station. This saves the effort of manually tuning in each time. This unit can memorize up to 30 stations, stored in three banks, or classes, (A, B and C) of 10 stations each. When saving an FM frequency, the **MPX** setting (see page 49) is also stored.

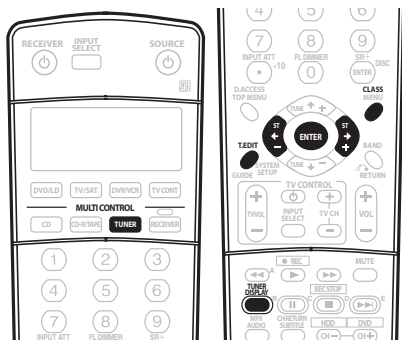
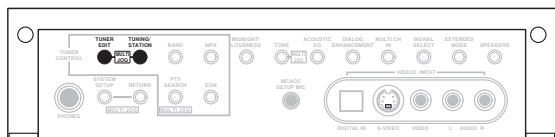
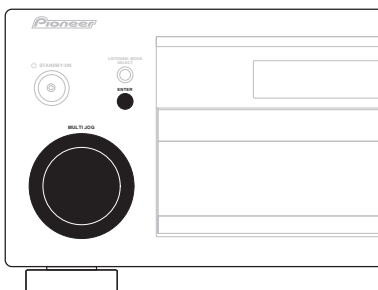

### 1 Tune to a station you want to memorize.

See *Listening to the radio* on page 49 for more on this.

### 2 Press T.EDIT (TUNER EDIT).

The display shows **STATION MEMORY**, then a blinking memory class.

### 3 Press CLASS to select one of the three classes then press ST +/- (STATION +/-) to select the station preset you want.

You can also use the number buttons or the **MULTI JOG** dial (front panel) to select a station preset.

### 4 Press ENTER.

After pressing **ENTER**, the preset class and number stop blinking and the receiver stores the station.

## Naming station presets

For easier identification, you can name your station presets.

### 1 Choose the station preset you want to name.

See *Listening to station presets* below for how to do this.

### 2 Press T.EDIT (TUNER EDIT).

The display shows **STATION NAME**, then a blinking cursor at the first character position.

### 3 Input the name you want.

Choose from the following characters for a name up to four characters long.

**ABCDEFGHIJKLMNOPQRSTUVWXYZ**

**abcdefghijklmnopqrstuvwxyz**

**0123456789**

**! " # \$ % & ' ( ) \* + , - . / : ; < = > ? @ [ \ ] ^ \_ { } ~**

- Use the **MULTI JOG** dial (front panel) or the **ST +/-** buttons (remote) to select characters.
- Press **ENTER** to confirm a character. If no character is input, a space is input.
- The name is stored when **ENTER** is pressed after choosing the fourth character.

## Tip

- To erase a station name, simply repeat steps 1-3 and input four spaces instead of a name.
- Once you have named a station preset, you can press **TUNER DISPLAY** when listening to a station to switch the display between name and frequency.

## Listening to station presets

You will need to have some presets stored to do this. See *Saving station presets* above if you haven't done this already.

### 1 Press TUNER to select the tuner.

### 2 Press CLASS to select the class in which the station is stored.

Press repeatedly to cycle through classes A, B and C.

### 3 Press ST +/- (STATION +/-) to select the station preset you want.

- You can also use the number buttons on the remote control to recall the station preset.

## Note

- If the receiver is left disconnected from the AC power outlet for over a month, the station memories will be lost and will have to be reprogrammed.

## An introduction to RDS

Radio Data System, or RDS as it's usually known, is a system used by FM radio stations to provide listeners with various kinds of information—the name of the station and the kind of show they're broadcasting, for example. This information shows up as text on the display, and you can switch between the kind of information shown. Although you don't get RDS information from all FM radio stations, you do with most.

Probably the best feature of RDS is that you can search automatically by type of program. So, if you felt like listening to jazz, you could search for a station that's broadcasting a show with the program type, **JAZZ**. There are around 30 such program types, including various genres of music, news, sport, talk shows, financial information, and so on.

The receiver lets you display three different kinds of RDS information: Radio Text, Program Service Name, and Program Type.

Radio Text (**RT**) is messages sent by the radio station. These can be anything the broadcaster chooses—a talk radio station might give out its telephone number as RT, for example.

Program Service Name (**PS**) is the name of the radio station.

Program Type (**PTY**) indicates the kind of program currently being broadcast.

The receiver can search for and display the following program types:

- NEWS** – News
- AFFAIRS** – Current affairs
- INFO** – General information
- SPORT** – Sport
- EDUCATE** – Educational material
- DRAMA** – Radio plays or serials
- CULTURE** – National or regional culture, theatre, etc.
- SCIENCE** – Science and technology
- VARIED** – Usually talk-based material, such as quiz shows or interviews.
- POP M** – Pop music
- ROCK M** – Rock music
- EASY M** – "Middle of the road" music also called soft rock
- LIGHT M** – 'Light' classical music
- CLASSICS** – 'Serious' classical music
- OTHER M** – Other music not fitting any of the above categories
- WEATHER** – Weather reports
- FINANCE** – Stock market reports, commerce, trading, etc.

**CHILDREN** – Programs for children

**SOCIAL** – Social affairs

**RELIGION** – Programs concerning religion

**PHONE IN** – Public expressing their views by phone

**TRAVEL** – Holiday-type travel rather than traffic announcements

**LEISURE** – Leisure interests and hobbies

**JAZZ** – Jazz

**COUNTRY** – Country music

**NATION M** – Popular music in a language other than English

**OLDIES** – Popular music from the '50s and '60s

**FOLK M** – Folk music

**DOCUMENT** – Documentaries

In addition, there is a program type called **ALARM**, used for emergency announcements. You can't search for this, but the tuner will switch automatically to this RDS broadcast signal.

## Displaying RDS information

When the tuner is selected, use the **TUNER DISPLAY** button to display the different types of RDS information available (**RT**, **PS** and **PTY**).

- Press **TUNER DISPLAY** to select the RDS information display.

Each press changes the display as follows:

- **RT** – Radio Text display
- **PS** – Program Service display
- **PTY** – Program Type display
- Current tuner frequency

### Note

- If any noise is picked up while displaying the RT scroll, some characters may be displayed incorrectly.
- If you see **NO RADIO TEXT DATA** in the display, it means no RT data is transmitted from the broadcast station. If you have entered a name for the station, it is broadcast instead of RT data. If you haven't, the display will automatically switch to the PS data display. If no PS data is transmitted from the station, the frequency will be displayed.
- In the PTY display, there are cases where **NO DATA** is shown. If this happens, the PS display is shown after a few seconds.

## Searching for RDS programs

One of the most useful features of RDS is the ability to search for a particular kind of radio program. You can search for any of the program types listed on the previous page.

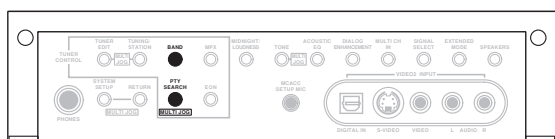
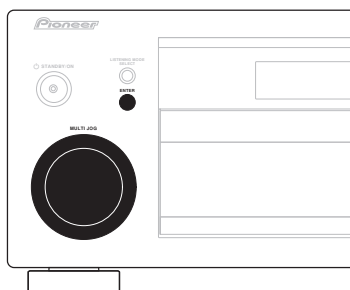

### 1 Press the **BAND** button to select the FM band.

RDS is only possible in the FM band.

### 2 Press the **PTY SEARCH** button.

**SEARCH** shows in the display.

### 3 Use the **MULTI JOG** dial to select the program type you want to hear.

### 4 Press **ENTER** to search for the program type.

The system starts searching through the station presets for a match. When it finds one, the search stops and the station plays for five seconds.

### 5 If you want to keep listening to the station, press **ENTER** within the 5 seconds.

If you don't press **ENTER**, searching resumes.

If **NO PTY** is displayed it means the tuner couldn't find that program type at the time of the search.

#### Note

- RDS searches station presets only. If no stations have been preset, or if the program type could not be found among the station presets **NO PTY** is displayed. **FINISH** means the search is complete.

## Using EON

When EON (Enhanced Other Network information) is turned on, the receiver jumps to an EON-linked broadcast when it begins, even if a receiver function other than the tuner is being used. It can't be used in

areas that EON information isn't transmitted and when FM broadcast stations don't transmit PTY data. When the broadcast ends, the tuner returns to the original frequency or function.

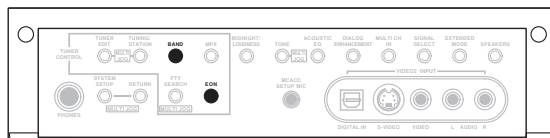

### 1 Press the **BAND** button to select the FM band.

EON is only possible in the FM band.

### 2 Press **EON** to select one of the possible modes.

Press repeatedly to switch between:

- EON TA** (Traffic Announcement) – Sets the tuner to pick up traffic information when it is broadcast.
- EON NEWS** – Sets the tuner to pick up news when it is broadcast.
- OFF** – Switches off the EON feature.

When set to **TA** or **NEWS**, the **EON** indicator in the display lights (it flashes when receiving an EON broadcast). The ● indicator in the display lights when the current station carries the EON service.

#### Note

- The EON function does not work when listening to AM reception.
- You can't search for traffic announcements and news at the same time.
- You cannot operate the **TUNER EDIT** and **PTY SEARCH** buttons while the **EON** indicator in the display is lit.
- If you want to change to a function other than the tuner when the **EON** indicator is flashing, press **EON** to turn EON off.

## Clearing all stations from the RDS and EON searches

The receiver will automatically register an identifying marker (called a PI code) for any station you input into the memory classes which can receive RDS or EON data. If you want to remove the currently memorized stations from RDS and EON searches, you can do it by erasing the PI codes.

### 1 Press and hold **EON** for about two seconds.

**ERASE PI** is displayed.

### 2 Press **ENTER**.

**ERASE PI** flashes for two seconds to indicate the PI codes have been erased.

## Chapter 8: Making recordings

### Making an audio or a video recording

You can make an audio or a video recording from the built-in tuner, or from an audio or video source connected to the receiver (such as a CD player or TV).

Keep in mind you can't make a digital recording from an analog source or vice-versa, so make sure the components you are recording to/from are hooked up in the same way (see *Connecting up* on page 14 for more on connections).

If you want to record a video source, you also need to use the same type of connection for the source as for the recorder. For example, you can't record a component hooked up to S-video jacks with a recorder hooked up to the composite video outputs (see page 18 for more on video connections).

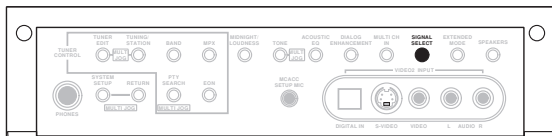
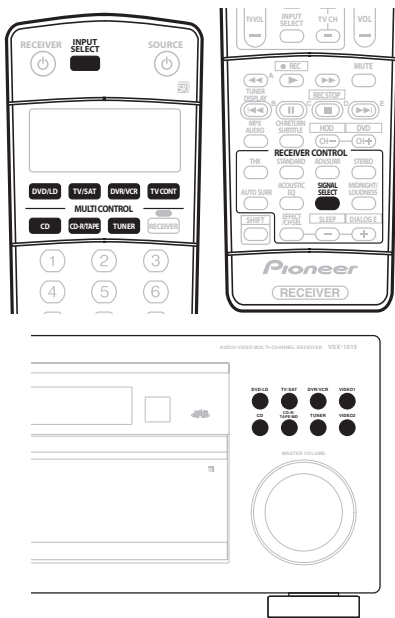

**1 Select the source you want to record.**  
Use the **MULTI CONTROL** buttons (or **INPUT SELECT**).

**2 Select the input signal (if necessary).**  
Press **SIGNAL SELECT** to select the input signal corresponding to the source component (see page 35 for more on this).

**3 Prepare the source you want to record.**  
Tune to the radio station, load the CD, video, DVD etc.

**4 Prepare the recorder.**  
Insert a blank tape, MD, video etc. into the recording device and set the recording levels.

Refer to the instructions that came with the recorder if you are unsure how to do this. Most video recorders set the audio recording level automatically—check the component's instruction manual if you're unsure.

**5 Start recording, then start playback of the source component.**

#### Note

- The receiver's volume, balance, tone (bass, treble, loudness), and surround effects have no effect on the recorded signal.
- Some digital sources are copy-protected, and can only be recorded in analog.
- Some video sources are copy-protected. These cannot be recorded.

## Chapter 9:

# Controlling the rest of your system

## Setting the remote to control other components

Most components can be assigned to one of the **MULTI CONTROL** buttons using the component's manufacturer preset code stored in the remote.

However, please note that there are cases where only certain functions may be controllable after assigning the proper preset code, or the codes for the manufacturer in the remote control will not work for the model that you are using.

If you can't find a preset code that matches the component you want to control, you can still teach the remote individual commands from another remote control (page 55).

### Note

- TV codes (for example, codes for TV, CATV or Satellite TV) can only be assigned to the **TV/SAT** or **TV CONT** button.
- If you assign the **TUNER** function to another component, you will have to reassign it to the Pioneer preset code to use this receiver's built-in tuner.
- You can cancel or exit any of the steps by pressing **RECEIVER**. To go back a step, press **RETURN**.
- After one minute of inactivity, the remote automatically exits the operation.

## Selecting preset codes directly

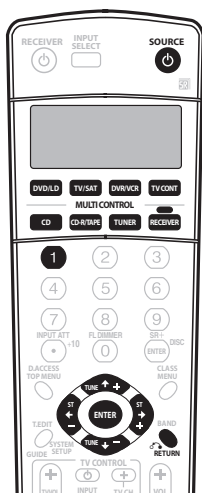

- 1 While pressing the **RECEIVER** button, press and hold the **1** button.

The remote LCD display shows **SETUP**.

- 2 Press the **MULTI CONTROL** button for the component you want to control.

The LCD on the remote displays the component you want to control.

- You can't assign the **RECEIVER** button.

- 3 Use **←/→** (cursor left/right) to select **PRESET** then press **ENTER**.

- 4 Use **↑/↓** (cursor up/down) to select the first letter of the brand name of your component then press **ENTER**.

This should be the manufacturer's name (for example, **P** for Pioneer).

- 5 Use **↑/↓** (cursor up/down) to select the manufacturer's name from the list then press **ENTER**.

- 6 Use **↑/↓** (cursor up/down) to select the proper code from the list, then try using this remote control with your component.

The code should start with the component type (for example, **DVD 009**). If there is more than one, start with the first one.

To try out the remote control, switch the component on or off (into standby) by pressing **SOURCE**  $\phi$ . If it doesn't seem to work, select the next code from the list (if there is one).

- If you can't find or properly enter a preset code, you can still teach the remote individual commands from another remote control (see *Programming signals from other remote controls* below).

- 7 If your component is controlled successfully, press **ENTER** to confirm.

The remote LCD display shows **OK**.

## Programming signals from other remote controls

If the preset code for your component is not available, or the available preset codes do not operate correctly, you can program signals from the remote control of another component. This can also be used to program additional operations (buttons not covered in the presets) after assigning a preset code.

### 1 While pressing the RECEIVER button, press and hold the 1 button.

The remote LCD display shows **SETUP**.

### 2 Press the MULTI CONTROL button for the component you want to control.

The LCD on the remote displays the component you want to control.

- You can't assign the **RECEIVER** button.

### 3 Use ←/→ (cursor left/right) to select LEARN then press ENTER.

**PRES KEY** shows in the LCD display.

- To exit or cancel press **RECEIVER**.

### 4 Point the two remote controls towards each other then press the button that will be doing the learning on this receiver's remote control.

**PRES KEY** starts flashing to indicate the remote is ready to accept a signal.

- The remote controls should be 3–5 cm apart.

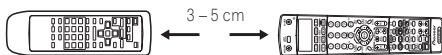

### 5 Press the corresponding button on the other remote control that is sending (teaching) the signal to this receiver's remote control.

For example, if you want to learn the playback control signal, press and hold **▶** for a couple of seconds. The LCD display will show **OK** if the operation has been learned.

If for some reasons the operation hasn't been learned the LCD will display **ERROR** briefly and then display **PRES KEY** again. If this happens, keep pressing the (teaching) button as you vary the distance between the two remotes, until the LCD display shows **OK**.

Certain buttons represent operations that cannot be learned from other remote controls. The buttons available are shown below:

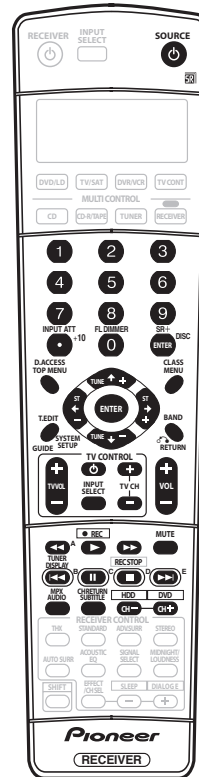

### 6 To program additional signals for the current component repeat steps 4 and 5.

To program signals for another component, exit and repeat steps 1 through 5.

### 7 Press the RECEIVER button to exit and store the operation(s).

#### Note

- Some commands from other remote controls cannot be learned, but in most cases the remotes just need to be moved closer together or farther apart.
- If the remote LCD shows **ERROR**, it may also mean the memory is full. See *Erasing one of the remote control button settings* below to erase a programmed button you're not using to free up more memory.
- TV CONTROL** buttons (**TV**, **TV VOL +/-**, **TV CH +/-** and **INPUT SELECT**) can only be learned after selecting **TV CONT**.

## Erasing one of the remote control button settings

This erases one of the buttons you have programmed and restores the button to the factory default.

### 1 While pressing the RECEIVER button, press and hold the 1 button.

The remote LCD display shows **SETUP**.

### 2 Press the MULTI CONTROL button corresponding to the button setting to be erased.

The LCD on the remote displays the component.

### 3 Use ←/→ (cursor left/right) to select ERASE then press ENTER.

The LCD display flashes **PRES KEY**.

### 4 Press and hold the button to be erased for two seconds.

The LCD display shows **OK** or **NO CODE** to confirm the button has been erased.

### 5 Repeat step 4 to erase other buttons.

### 6 Press the RECEIVER button when you're done.

## Erasing all of the remote control presets

This will erase all preset remote control preset codes and programmed buttons.

### 1 While pressing the RECEIVER button, press and hold the 1 button.

The remote LCD display shows **SETUP**.

### 2 Press the DVD/LD MULTI CONTROL button.

### 3 Use ←/→ (cursor left/right) to select RESET then press and hold ENTER for about two seconds.

The LCD shows **OK** to confirm the remote presets have been erased.

## Direct function

- Default setting: **ON**

You can use the direct function feature to control one component using the remote control while at the same time, using your receiver to playback a different component. This could let you, for example, use the remote control to set up and listen to a CD on the receiver and then use the remote control to rewind a tape in your VCR while you continue to listen to your CD player.

When direct function is on, any component you select (using the **MULTI CONTROL** buttons) will be selected by both the receiver and the remote control. When you turn direct function off, you can operate the remote control without affecting the receiver.

### 1 While pressing the RECEIVER button, press and hold the 1 button.

The remote LCD display shows **SETUP**.

### 2 Press the MULTI CONTROL button for the component you want to control.

The LCD on the remote displays the component you want to control.

### 3 Use ←/→ (cursor left/right) to select DIRECT F then press ENTER.

The LCD on the remote displays the component you want to control.

### 4 Use ↑/↓ (cursor up/down) to switch direct function ON or OFF then press ENTER.

The LCD shows **OK** to confirm the setting.



#### Note

- You can't use direct function with the **TV CONT** function.

## Confirming preset codes

Use this feature to check which preset code is assigned to a **MULTI CONTROL** button.

### 1 While pressing the RECEIVER button, press and hold the 1 button.

The remote LCD display shows **SETUP**.

### 2 Press the MULTI CONTROL button of the component for which you want to check the preset code.

### 3 Use ←/→ (cursor left/right) to select READ ID then press ENTER.

The brand name and preset code appears in the display for three seconds.



## Controls for TVs

This remote control can control components after entering the proper codes or teaching the receiver the commands (see *Setting the remote to control other components* on page 54 for more on this). Use the **MULTI CONTROL** buttons to select the component.

Button(s)	Function	Components
TV	Press to switch the component assigned to the <b>TV CONT</b> button on or off.	Cable TV/Satellite TV/TV
<b>INPUT SELECT</b>	Switches the TV input. (Not possible with all models.)	TV
<b>TV CH +/-</b>	Selects channels.	Cable TV/Satellite TV/TV
<b>TV VOL +/-</b>	Adjust the TV volume.	Cable TV/Satellite TV/TV
<b>SOURCE</b>	Switches the TV or CATV between standby and on.	Cable TV/Satellite TV/TV
	Use to choose the 'A' commands on a Satellite TV menu.	Satellite TV
	Use to choose the RED/B commands on a Satellite TV/TV menu.	Satellite TV/TV
	Use to choose the CYAN/E commands on a Satellite TV/TV menu.	Satellite TV/TV
	Use to choose the GREEN/C commands on a Satellite TV/TV menu.	Satellite TV/TV
	Use to choose the YELLOW/D commands on a Satellite TV/TV menu.	Satellite TV/TV
<b>AUDIO</b>	Use to switch audio tracks.	Satellite TV/TV
<b>CH RETURN</b>	Use to return to the previously selected channel.	Cable TV/Satellite TV/TV
<b>GUIDE</b>	Use as the <b>GUIDE</b> button for navigating.	Cable TV/Satellite TV/TV
	Switches <b>TEXT OFF</b> for TVs.	TV
<b>RETURN</b>	Use to select <b>RETURN</b> or <b>EXIT</b> .	Satellite TV/TV
Number buttons	Use to select a specific TV channel.	Cable TV/Satellite TV/TV
<b>+10</b> button	Use to add a decimal point when selecting a specific TV channel.	Satellite TV/TV
<b>ENTER/DISC</b>	Use to enter a channel.	Cable TV/Satellite TV/TV
<b>MENU</b>	Select the menu screen.	Cable TV/Satellite TV/TV
<b>ENTER</b>	Press to select or adjust and navigate items on the menu screen.	Cable TV/Satellite TV/TV
<b>TOP MENU</b>	Switches <b>TEXT ON</b> for TVs.	TV



### Note

- The **TV CONTROL** buttons on the remote control are dedicated to control the TV assigned to the **TV CONT** button. Thus if you only have one TV to hook up to this system assign it to the **TV CONT (MULTI CONTROL)** button. If you have two TVs, assign the main TV to the **TV CONT** button.

## Controls for other components

This remote control can control these components after entering the proper codes or teaching the receiver the commands (see *Setting the remote to control other components* on page 54 for more on this). Use the **MULTI CONTROL** buttons to select the component.

Button (s)	Function	Components
<b>SOURCE</b>	Press to switch the component between standby and on.	CD/MD/CD-R/VCR/DVD/LD/DVR player/Cassette deck
	Press to return to the start of the current track or chapter. Repeated presses skips to the start of previous tracks or chapters.	CD/MD/CD-R/DVD/LD player
	Go back channels (channel -).	DVR/VCR
	Press to advance to the start of the next track or chapter. Repeated presses skips to the start of following tracks or chapters.	CD/MD/CD-R/DVD/LD player
	Go forward channels (channel +).	VCR
	Pause playback or recording.	CD/MD/CD-R/VCR/DVD/LD/DVR player/Cassette deck
	Start playback.	CD/MD/CD-R/VCR/DVD/LD/DVR player/Cassette deck
	Hold down for fast forward playback.	CD/MD/CD-R/VCR/DVD/LD/DVR player/Cassette deck
	Hold down for fast reverse playback.	CD/MD/CD-R/VCR/DVD/LD/DVR player/Cassette deck
	Stops playback (on some models, pressing this when the disc is already stopped will cause the disc tray to open).	CD/MD/CD-R/VCR/DVD/LD/DVR player/Cassette deck
<b>REC</b> ( <b>SHIFT</b> +)	Starts recording. To prevent accidental recording, this button must be pressed twice to take effect (the second press must be within 10 seconds of the first).	MD/CD-R/VCR/ DVR player/Cassette deck
<b>REC STOP</b> ( <b>SHIFT</b> +)	Stops recording.	DVR player
Number buttons	Directly access tracks on a program source.	CD/MD/CD-R/VCR/LD player
	Use the number buttons to navigate the on-screen display.	DVD/DVR player
<b>+10</b> button	Selects tracks higher than 10. (For example, press <b>+10</b> then <b>3</b> to select track 13.)	CD/MD/CD-R/VCR/LD player
<b>ENTER/DISC</b>	Chooses the disc.	Multiple CD player
	Ejects the disc.	MD player
	Use as the <b>ENTER</b> button.	VCR
	Use as the <b>CLEAR</b> button.	DVD
	Displays the setup screen for DVR players.	DVR player
	Changes sides of the LD.	LD player
<b>TOP MENU</b>	Displays the disc 'top' menu of a DVD player.	DVD/DVR player
<b>MENU</b>	Displays menus concerning the current DVD or DVR you are using.	DVD/DVR player

Button (s)	Function	Components
⏸	Pauses the tape.	Cassette deck
⏹	Stops the tape.	Cassette deck
<b>ENTER</b>	Starts playback.	Cassette deck
⏮/⏭	Fast rewinds/fast forwards the tape.	Cassette deck
⏪⏩⏮⏭ & <b>ENTER</b>	Navigates DVD menu/options.	DVD/DVR Player
<b>GUIDE</b>	Press to access the DVD player setup screen.	DVD/DVR Player
<b>CH +/-</b>	Selects channels.	VCR/DVD/DVR Player
	Selects tracks.	CD/MD/CD-R/Cassette deck
<b>AUDIO</b>	Changes the audio language or channel.	DVD/DVR Player
<b>SUBTITLE</b>	Displays/changes the subtitles on multilingual DVDs.	DVD/DVR Player
<b>HDD (SHIFT + CH-)</b>	Switches to the hard disk controls when using a DVD/HDD recorder.	DVR Player
<b>DVD (SHIFT + CH+)</b>	Switches to the DVD controls when using a DVD/HDD recorder.	DVR Player

## Chapter 10: Other connections

### Caution

- Before making or changing the connections, switch off the power and disconnect the power cord from the power outlet. Plugging in components should be the last connection you make with your system.
- Be careful not to allow any contact between speaker wires from different terminals.
- You can use speakers with a nominal impedance between 6–16Ω (please see *Switching the speaker impedance* on page 73 if you plan to use speakers with an impedance of less than 8Ω).

### Second Zone speaker B setup

After selecting **Second Zone** in *Surround back speaker setting* on page 40, you can use the speakers connected to the (surround back) B speaker terminals on the rear panel to listen to stereo playback in another room. See *Switching the speaker system* below for the listening options with this setup.

#### 1 Connect a pair of speakers to the surround back speaker terminals on the rear panel.

Connect them the same way you connected your speakers in *Connecting the speakers* on page 20. Make sure to review *Hints on speaker placement* on page 21 when placing the speakers in another room.

#### 2 Select 'Second Zone' from the 'Surr Back System' menu.

See *Surround back speaker setting* on page 40 to do this.

### Switching the speaker system

If you selected **Second Zone** in *Surround back speaker setting* on page 40, three speaker system settings are possible using the **SPEAKERS** button. If you selected **Normal (SB)** or **Front Bi-Amp**, the button will simply switch your main speaker system on or off. The options below are for the **Second Zone** setting only.

#### • Use the **SPEAKERS** button on the front panel to select a speaker system setting.

As mentioned above, if you have selected **Normal (SB)**, the button will simply switch your main speaker system (A) on or off.

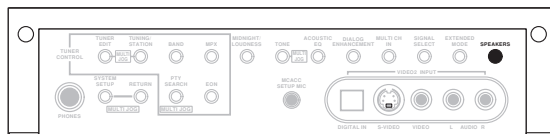

Press repeatedly to choose a speaker system option:

- **SP▶A** – Sound is output from speaker system A and the same signal is output from the pre-out terminals.
- **SP▶B** – Sound is output from the two speakers connected to speaker system B. Multichannel sources will not be heard. The same signal is output from the surround back channel pre-out terminals.
- **SP▶AB** – Sound is output from speaker system A (up to 5 channels, depending on the source), the two speakers in speaker system B, and the subwoofer. The sound from speaker system B will be the same as the sound from speaker system A (multichannel sources will be downmixed to 2 channels).
- **SP▶(off)** – No sound is output from the speakers. The same sound is output from the pre-out terminals (including from your subwoofer, if connected) as when selecting speaker system A (above).

### Note

- The subwoofer output depends on the settings you made in *Manual speaker setup* on page 45. However, if **SP▶B** is selected above, no sound is heard from the subwoofer (the LFE channel is not downmixed).
- Depending on the settings in *Surround back speaker setting* on page 40 output from the surround back pre-out terminals may change.
- All speaker systems (except **Second Zone** connections) are switched off when headphones are connected.

## Bi-amping your front speakers

Bi-amping is when you connect the high frequency driver and low frequency driver of your speakers to different amplifiers (in this case, to both front and surround back terminals) for better crossover performance. Your speakers must be bi-ampable to do this (having separate terminals for high and low) and the sound improvement will depend on the kind of speakers you're using.

### 1 Connect your speakers as shown below.

This illustration below shows the connections for bi-amping your front left speaker. Hook up your front right speaker in the same way.

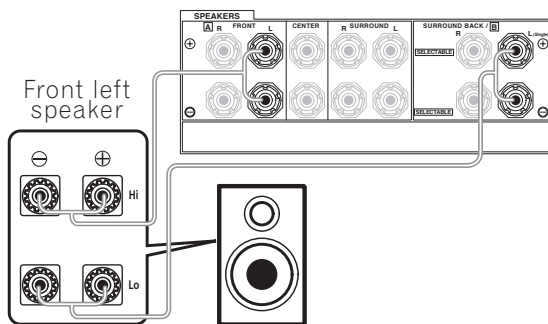

Since both front and surround back speaker terminals output the same audio, it doesn't matter which set (front or surround back) is powering which part (**Hi** or **Low**) of the speaker.

- Make sure that the + / - connections are properly inserted.

### 2 Select the 'Front Bi-Amp' setting from the 'Surround Back System' menu.

See *Surround back speaker setting* on page 40 to specify how you're using the surround back speaker terminals.

#### Caution

- Most speakers with both **Hi** and **Low** terminals have two metal plates that connect the **Hi** to the **Low** terminals. These must be removed when you are bi-amping the speakers or you could severely damage the amplifier. See your speaker manual for more information.
- If your speakers have a removable crossover network, make sure you do not remove it for bi-amping. Doing so may damage your speakers.

## Bi-wiring your speakers

The reasons for bi-wiring are basically the same as bi-amping, but additionally, interference effects within the wire could be reduced, producing better sound. Again, to do this your speakers must be bi-wireable (that is they must have separate terminals for the high and low frequencies). When bi-wiring, make sure you've selected **Normal (SB)** or **Second Zone** in *Surround back speaker setting* on page 40.

- To bi-wire a speaker, connect two speaker cords to the speaker terminal on the receiver.

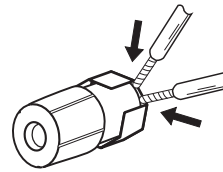

#### Caution

- Make sure you use a parallel (not series, which are fairly uncommon) connection when bi-wiring your speakers.
- Don't connect different speakers from the same terminal in this way.

## Connecting additional amplifiers

This receiver has more than enough power for any home use, but it's possible to add additional amplifiers to every channel of your system using the pre-outs. Make the connections shown below to add amplifiers to power your speakers.

### Important

- Before making or changing the connections, switch off the power and disconnect the power cord from the AC outlet.

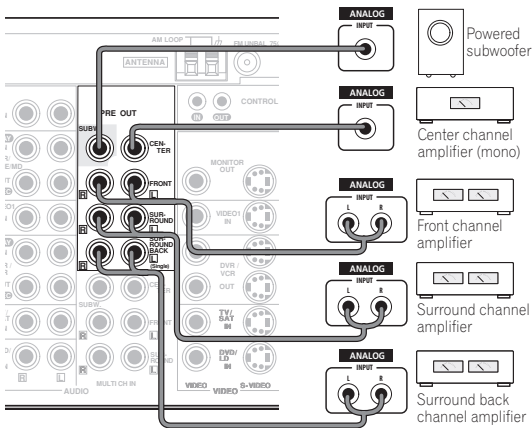

- You can use the additional amplifier on the surround back channel pre-outs for a single speaker as well. In this case plug the amplifier into the left (**L (Single)**) terminal only.
- The sound from the surround back terminals will depend on how you have configured the *Surround back speaker setting* on page 40.
- To hear sound only from the pre-outs, switch the speaker system to **OFF**, or simply disconnect any speakers that are connected directly to the receiver.
- If you're not using a subwoofer, change the front speaker setting (see *Speaker Setting* on page 46) to large.

## Using this receiver with a Pioneer plasma display

If you have a Pioneer plasma display, you can use an SR+ cable (see note below) to connect it to this unit and take advantage of various convenient features, such as automatic video input switching of the plasma display when the input is changed.

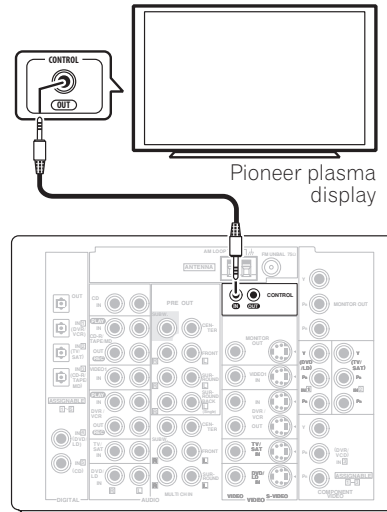

### Important

- If you connect to a Pioneer plasma display using an SR+ cable, you will need to point the remote control at the plasma display remote sensor to control the receiver. In this case, you won't be able to control the receiver using the remote control if you switch the plasma display off.

- Use a 3-ringed miniplug SR+ cable to connect the **CONTROL IN** jack of this receiver with the **CONTROL OUT** jack of your plasma display.

Before you can use the extra SR+ features, you need to make a few settings in the receiver. See *SR+ Setup for Pioneer plasma displays* on page 67 for detailed instructions.

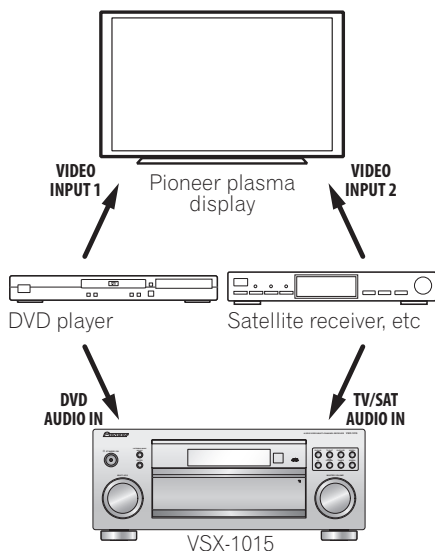

To make the most of the SR+ features, you should connect your source components (DVD player, etc.) in a slightly different way to that described in this chapter. For each component, connect the video output directly to the plasma display, and just connect the audio (analog and/or digital) to this receiver.

#### Note

- This receiver is compatible with all SR+ equipped Pioneer plasma displays from 2003 onward.
- The 3-ringed SR+ cable from Pioneer is commercially available under the part number ADE7095. Contact the Pioneer Customer Support division for more information on obtaining an SR+ cable (you can also use a commercially available 3-ringed mini phone plug for the connection).

## Using the SR+ mode with a Pioneer plasma display

When connected using an SR+ cable, a number of features become available to make using this receiver with your Pioneer plasma display even easier. These features include:

- On-screen displays when making receiver settings, such as speaker setup, MCACC setup, and so on.
- On-screen volume display.
- On-screen display of listening mode.
- Automatic video input switching on the plasma display.
- Automatic volume muting on the plasma display.

See also *SR+ Setup for Pioneer plasma displays* on page 67 for more on setting up the receiver.



- 1 Make sure that the plasma display and this receiver are switched on and that they are connected with the SR+ cable.

See *Using this receiver with a Pioneer plasma display* above for more on connecting these components.

- 2 To switch SR+ mode on/off, press **RECEPTOR**, then the **SR+** button.

The front panel display shows **SR+ ON** or **SR+ OFF**.

#### Note

- The automatic volume muting feature is enabled separately; see *SR+ Setup for Pioneer plasma displays* on page 67.

## Chapter 11: Other Settings

### The Input Assign menu

You only need to make settings in the Input Assign menu if you didn't hook up your digital equipment according to the default settings for the digital inputs, or if you have connected equipment using component video cables.



#### 1 Switch on the receiver and your TV.

Use the **RECEIVER** button to switch on.

#### 2 Press **RECEIVER** on the remote control, then press the **SYSTEM SETUP** button.

An on-screen display (OSD) appears on your TV. Use the **↑/↓/←/→** buttons and **ENTER** on the remote control to navigate through the screens and select menu items. Press **RETURN** to confirm and exit the current menu.

#### 3 Select 'Input Assign' from the System Setup menu.

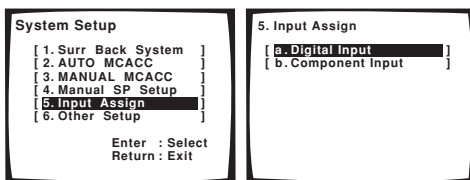

### Assigning the digital inputs

- Default settings:

**Digital-1** (optical) – **DVR**

**Digital-2** (optical) – **TV/SAT**

**Digital-3** (optical) – **CD-R**

**Digital-4** (coaxial) – **DVD/LD**

**Digital-5** (coaxial) – **CD**

You only need to do this if you didn't hook up your digital equipment according to the default settings for the digital inputs (see above). This setting tells the receiver what digital equipment is hooked up to which terminal so the buttons on the remote correspond to what you have hooked up.

#### 1 Select 'Digital Input' from the Input Assign menu.

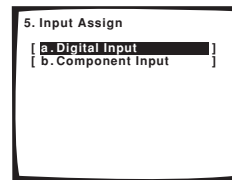

#### 2 Select the number of the digital input to which you've connected your digital component.

The numbers correspond with the numbers beside the inputs on the back of the receiver.

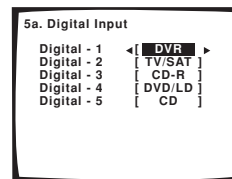

#### 3 Select the component that corresponds with the one you connected to that input.

Select between **DVD/LD**, **TV/SAT**, **DVR**, **VIDEO1**, **CD-R**, **CD** or **OFF**.

- Use the **←/→** (cursor left/right) buttons and **ENTER** to do this.

- If you assign a digital input to a certain function (for example, **DVD/LD**) then any digital inputs previously assigned to that function will automatically be switched off.

#### 4 When you're finished, press **RETURN**.

You will return to the Input Assign menu.



## Assigning the component video inputs

- Default settings:
  - Component 1 – DVD/LD**
  - Component 2 – TV/SAT**
  - Component 3 – DVR**

If you used component video cords to connect your video equipment you must tell the receiver which device it is, or else you may see the S-video or composite video input instead of the component video signal.

### 1 Select 'Component Input' from the Input Assign menu.

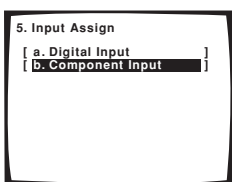

### 2 Select the number of the component video input to which you've connected your video component. Select between DVD/LD, TV/SAT, DVR, VIDEO1 or OFF.

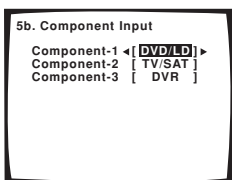

- The numbers correspond with the numbers beside the inputs on the back of the receiver.
- ### 3 Select the component that corresponds with the one you connected to that input.
- Use the ←/→ (cursor left/right) buttons and ENTER to do this.
  - Make sure you have connected the audio from the component to the corresponding inputs on the rear of the receiver.
  - If you connect any source component to the receiver using a component video input, you should also have your TV connected to this receiver's component video MONITOR output.

### 4 When you're finished, press RETURN.

You will return to the Input Assign menu.

## The Other Setup menu

The Other Setup menu is where you can make customized settings to reflect how you are using the receiver.



### 1 Switch on the receiver and your TV. Use the RECEIVER button to switch on.

### 2 Press RECEIVER on the remote control, then press the SYSTEM SETUP button.

An on-screen display (OSD) appears on your TV. Use the ↑/↓/←/→ buttons and ENTER on the remote control to navigate through the screens and select menu items. Press RETURN to confirm and exit the current menu.

### 3 Select 'Other Setup' then press ENTER.

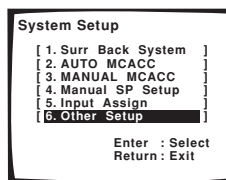

#### 4 Select the setting you want to adjust.

If you are doing this for the first time, you may want to adjust these settings in order:

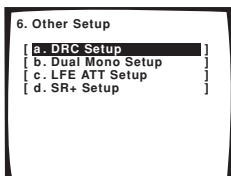

- **DRC Setup** – Specify the amount of dynamic range adjustment to Dolby Digital soundtracks (see *Dynamic Range Control Setup* below).
- **Dual Mono Setup** – Isolate one channel when listening to discs with dual mono encoding (see *Dual Mono Setup* below).
- **LFE ATT Setup** – Choose the attenuator level for the LFE channel (*LFE Attenuator Setup* below).
- **SR+ Setup** – Specify how you want to control your Pioneer plasma display (*SR+ Setup for Pioneer plasma displays* on page 67).

5 Make the adjustments necessary for each setting, pressing RETURN to confirm after each screen.

#### Dynamic Range Control Setup

- Default setting: **OFF**

This setting specifies the amount of dynamic range adjustment to Dolby Digital and DTS movie soundtracks. You may want to use this when listening to surround sound at low volumes.

1 Select 'DRC Setup' from the Other Setup menu.

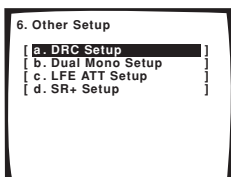

2 Choose the setting that you want.

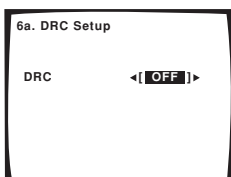

- **OFF** – No dynamic range adjustment (use when listening at higher volume).
- **MID** – Mid setting.

- **MAX** – Dynamic range is reduced (loud sounds are reduced in volume while quieter sounds are increased).

3 When you're finished, press RETURN.

You will return to the Other Setup menu.

#### Dual Mono Setup

- Default setting: **CH1**

You can specify how dual mono encoded Dolby Digital soundtracks should be played. Dual mono is not widely used, but is sometimes necessary when two languages need to be sent to separate channels.

1 Select 'Dual Mono Setup' from the Other Setup menu.

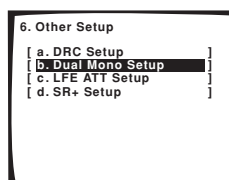

2 Choose the setting that you want.

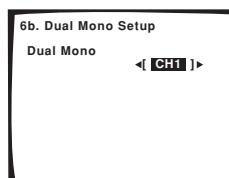

- **CH1** – Only channel 1 is played
- **CH2** – Only channel 2 is played
- **CH1 CH2** – Both channels are played through the front speakers

3 When you're finished, press RETURN.

You will return to the Other Setup menu.

#### Note

- This setting works only with dual mono encoded Dolby Digital and DTS soundtracks.

#### Tip

- While the receiver is in standby (using the front panel), press the **STANDBY/ON** button while holding down the **TUNER EDIT** button to change the dual mono setting.

### LFE Attenuator Setup

- Default setting: **ATT 0 dB**

Some Dolby Digital and DTS audio sources include ultra-low bass tones. Set the LFE attenuator as necessary to prevent the ultra-low bass tones from distorting the sound from the speakers.

#### 1 Select 'LFE ATT Setup' from the Other Setup menu.

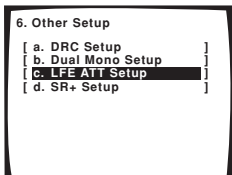

#### 2 Choose the setting that you want.

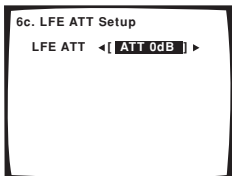

- **ATT 0dB** – No limiting (recommended setting)
- **ATT 10dB** – 10dB of limiting
- **LFE OFF** – No sound from LFE channel

#### 3 When you're finished, press RETURN.

You will return to the Other Setup menu.

### SR+ Setup for Pioneer plasma displays

Make the following settings if you have connected a Pioneer plasma display to this receiver using an SR+ cable. Note that the number of function settings available will depend on the plasma display you've connected.

See also *Using this receiver with a Pioneer plasma display* on page 62 and *Using the SR+ mode with a Pioneer plasma display* on page 63.

#### 1 Select 'SR+ Setup' from the Other Setup menu.

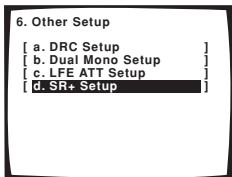

#### 2 Select the 'PDP Volume Control' setting you want.

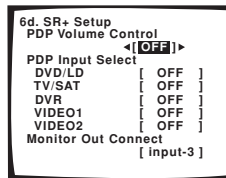

- **OFF** – The receiver does not control the volume of the plasma display
- **ON** – When the receiver is switched to one of the inputs that use the plasma display (**DVD/LD**, or another one of functions below), the volume on the plasma display is muted so only sound from the receiver is heard.

#### 3 Assign any input source connected to the plasma display to the corresponding input number.

This matches the receiver's input source with a numbered video input on the plasma display. For example, assign **DVD/LD** to **input-2** if you have connected the your DVD video output to video input 2 on the plasma display.

- The **Monitor Out Connect** should be set to the input that you've used to connect this receiver to your plasma display.

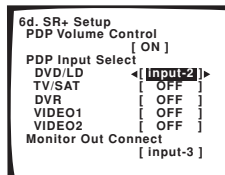
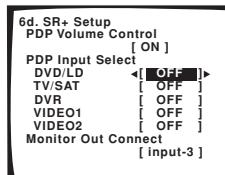

#### 4 When you're finished, press RETURN.

You will return to the Other Setup menu.

## Chapter 12:

## Additional information

## Troubleshooting

Incorrect operations are often mistaken for trouble and malfunctions. If you think that there is something wrong with this component, check the points below. Sometimes the trouble may lie in another component. Investigate the other components and electrical appliances being used. If the trouble cannot be rectified even after exercising the checks listed below, ask your nearest Pioneer authorized independent service company to carry out repair work.

## Power

Symptom	Cause	Remedy
The power does not turn on.	<ul style="list-style-type: none"> <li>The power plug is disconnected.</li> <li>The protection circuit may have been activated.</li> </ul>	<ul style="list-style-type: none"> <li>Connect the power plug to the wall outlet.</li> <li>Disconnect the power plug from the outlet, and insert again.</li> </ul>
The receiver suddenly switches off.	<ul style="list-style-type: none"> <li>The speaker wires are frayed or sticking out of the jack, and are touching the back of the receiver or another set of wires.</li> <li>The receiver has a serious problem.</li> </ul>	<ul style="list-style-type: none"> <li>Reinsert the speaker wires, making sure there are no stray strands of wire and that they are inserted fully.</li> <li>Unplug the receiver from the wall and call a Pioneer authorized independent service company.</li> </ul>
During loud playback the power suddenly switches off.	<ul style="list-style-type: none"> <li>The protection circuit has been activated because the lowest actual impedance of the speakers (as opposed to the speakers rated impedance) is dangerously low.</li> </ul>	<ul style="list-style-type: none"> <li>Turn down the volume.</li> <li>When it's convenient, go to <i>Acoustic Calibration EQ</i> on page 43 and lower the 40 Hz and 125 Hz equalizer levels using the manual setting.</li> <li>Turning the digital safety feature on may allow you to turn up the volume a little more. To switch between <b>SAFETY ON</b> and <b>SAFETY OFF</b>, put the receiver into standby, then press the <b>STANDBY/ON</b> button while holding down the <b>SYSTEM SETUP</b> button on the front panel.</li> </ul>
The unit does not respond when the buttons are pressed.	<ul style="list-style-type: none"> <li>Static electricity caused by dry air.</li> </ul>	<ul style="list-style-type: none"> <li>Switch the unit off, then on again.</li> <li>Disconnect the power plug from the outlet, and insert again.</li> </ul>
<b>AMP ERR</b> blinks in the display, then the power automatically switches off. The <b>MCACC</b> blinks and the power does not turn on.	<ul style="list-style-type: none"> <li>The receiver has a serious problem.</li> </ul>	<ul style="list-style-type: none"> <li>Do not try to turn on the receiver. Contact a Pioneer authorized independent service company for assistance.</li> </ul>
<b>FAN STOP</b> blinks in the display, then the power automatically switches off.	<ul style="list-style-type: none"> <li>Something is obstructing the fan.</li> <li>The fan is malfunctioning.</li> </ul>	<ul style="list-style-type: none"> <li>Remove the obstruction and try switching the receiver back on. If the fan is still not working, or you can't remove the object, unplug the receiver from the wall and call a Pioneer authorized independent service company.</li> <li>Unplug the receiver from the wall and call a Pioneer authorized independent service company.</li> </ul>
<b>OVERHEAT</b> blinks in the display then the power automatically switches off.	<ul style="list-style-type: none"> <li>The internal temperature of the unit has become too high.</li> </ul>	<ul style="list-style-type: none"> <li>After allowing the unit to cool down in a well-ventilated place, try switching the receiver back on. Make sure you follow the guidelines for improving heat dispersal in <i>Ventilation</i> on page 2.</li> </ul>

No sound

Symptom	Cause	Remedy
No sound is output when an input source is selected. No sound output from the front speakers.	<ul style="list-style-type: none"> <li>Improper connections.</li> </ul>	<ul style="list-style-type: none"> <li>Make sure you have properly connected the component to the corresponding input on the back of the receiver (see <i>Connecting up</i> on page 14).</li> </ul>
	<ul style="list-style-type: none"> <li>Sound is muted or the volume is turned down.</li> </ul>	<ul style="list-style-type: none"> <li>Press <b>MUTE</b> or adjust the volume accordingly.</li> </ul>
	<ul style="list-style-type: none"> <li>Speakers are turned off or selected improperly with the <b>SPEAKERS</b> switch.</li> </ul>	<ul style="list-style-type: none"> <li>Press <b>SPEAKERS</b> to select the proper speaker set (see <i>Switching the speaker system</i> on page 60).</li> </ul>
	<ul style="list-style-type: none"> <li>The input signal type is incorrect.</li> </ul>	<ul style="list-style-type: none"> <li>Press <b>SIGNAL SELECT</b> to select the proper input signal (see <i>Choosing the input signal</i> on page 35).</li> </ul>
	<ul style="list-style-type: none"> <li>The multichannel analog inputs are selected.</li> </ul>	<ul style="list-style-type: none"> <li>Press <b>MULTI CH IN</b> again (see <i>Selecting the multichannel analog inputs</i> on page 39).</li> </ul>
No sound from the surround or center speakers.	<ul style="list-style-type: none"> <li>The front speakers aren't connected properly.</li> </ul>	<ul style="list-style-type: none"> <li>See <i>Connecting the speakers</i> on page 20 to connect them properly.</li> </ul>
	<ul style="list-style-type: none"> <li>Speaker settings are incorrect. (for example, they have been set to <b>NO</b>).</li> </ul>	<ul style="list-style-type: none"> <li>Check you speaker settings in <i>Speaker Setting</i> on page 46.</li> </ul>
	<ul style="list-style-type: none"> <li>The surround and/or center levels are turned down.</li> </ul>	<ul style="list-style-type: none"> <li>Check the levels in <i>Channel Level</i> on page 47.</li> </ul>
	<ul style="list-style-type: none"> <li>The surround and/or center speakers are disconnected.</li> </ul>	<ul style="list-style-type: none"> <li>Check <i>Connecting the speakers</i> on page 20 to make sure the speakers are connected correctly.</li> </ul>
	<ul style="list-style-type: none"> <li>The <b>STEREO</b> listening mode has been selected.</li> </ul>	<ul style="list-style-type: none"> <li>Choose a surround listening mode (see <i>Listening in surround sound</i> on page 31).</li> </ul>
No sound from surround back speakers.	<ul style="list-style-type: none"> <li>Surround back speakers are set to <b>NO</b>.</li> </ul>	<ul style="list-style-type: none"> <li>Set the surround back speakers to <b>LARGE</b> or <b>SMALL</b> (see <i>Speaker Setting</i> on page 46).</li> </ul>
	<ul style="list-style-type: none"> <li>The Extended mode is switched to <b>AUTO</b> or <b>OFF</b>.</li> </ul>	<ul style="list-style-type: none"> <li>Set to <b>Extended ON</b> (see <i>Using the surround back channel (Extended mode)</i> on page 36).</li> </ul>
	<ul style="list-style-type: none"> <li>The source is not a 6.1 channel playback source.</li> </ul>	<ul style="list-style-type: none"> <li>Switch the Extended mode to <b>Extended ON</b> (see <i>Using the surround back channel (Extended mode)</i> on page 36) and choose a surround listening mode (see <i>Listening in surround sound</i> on page 31).</li> </ul>
	<ul style="list-style-type: none"> <li>The surround back speakers are disconnected.</li> </ul>	<ul style="list-style-type: none"> <li>Check <i>Connecting the speakers</i> on page 20 to make sure the speakers are connected correctly.</li> </ul>
	<ul style="list-style-type: none"> <li>The surround back channel is on the 1 speaker setting, and your speaker is connected to the right channel output.</li> </ul>	<ul style="list-style-type: none"> <li>Connect the speaker to the surround back left channel output (<i>Connecting the speakers</i> on page 20).</li> </ul>
	<ul style="list-style-type: none"> <li>The Extended mode is switched to <b>AUTO</b> and the Dolby Surround EX / DTS ES software you're playing has no flag to indicate it is 6.1 compatible.</li> </ul>	<ul style="list-style-type: none"> <li>You can still listen with surround back sound by setting to <b>Extended ON</b> (<i>Using the surround back channel (Extended mode)</i> on page 36).</li> </ul>
	<ul style="list-style-type: none"> <li>The subwoofer is disconnected or switched off.</li> </ul>	<ul style="list-style-type: none"> <li>Connect or switch on the subwoofer (see <i>Connecting the speakers</i> on page 20).</li> <li>Make sure the sleep function on your subwoofer isn't activated.</li> </ul>
No sound from subwoofer.	<ul style="list-style-type: none"> <li>The subwoofer's settings are incorrect.</li> </ul>	<ul style="list-style-type: none"> <li>Set the subwoofer (see <i>Speaker Setting</i> on page 46) to <b>YES</b> or <b>PLUS</b>.</li> </ul>
	<ul style="list-style-type: none"> <li>The crossover frequency is set too low.</li> </ul>	<ul style="list-style-type: none"> <li>Set the crossover frequency to a (higher) frequency that matches your speaker characteristics (see <i>Crossover Network</i> on page 47)</li> </ul>
	<ul style="list-style-type: none"> <li>There is very little low frequency information in your source.</li> </ul>	<ul style="list-style-type: none"> <li>Change your subwoofer setting to one of the following in the <i>Speaker Setting</i> on page 46: Front: <b>SMALL</b> / Subwoofer: <b>YES</b> Front: <b>LARGE</b> / Subwoofer: <b>PLUS</b></li> </ul>
	<ul style="list-style-type: none"> <li>The LFE channel is switched off.</li> </ul>	<ul style="list-style-type: none"> <li>See <i>LFE Attenuator Setup</i> on page 67 to adjust the setting.</li> </ul>
	<ul style="list-style-type: none"> <li>The subwoofer's levels are too low.</li> </ul>	<ul style="list-style-type: none"> <li>See <i>Channel Level</i> on page 47 to check the speaker levels.</li> <li>Check the volume control on the subwoofer to make sure it is turned up.</li> </ul>

Symptom	Cause	Remedy
No sound from one speaker.	<ul style="list-style-type: none"> <li>The speaker setting has been set to <b>NO</b>.</li> <li>The speaker level is too low.</li> <li>The speaker isn't connected properly.</li> </ul>	<ul style="list-style-type: none"> <li>Change the setting in <i>Speaker Setting</i> on page 46.</li> <li>Check the level in <i>Channel Level</i> on page 47.</li> <li>Check <i>Connecting the speakers</i> on page 20 to make sure the speaker is connected correctly.</li> </ul>
Sound is produced from analog components, but not from digital ones (DVD, LD, CD-ROM etc.).	<ul style="list-style-type: none"> <li>The digital input assignment is wrong.</li> <li>The digital components aren't connected properly.</li> <li>The player is not compatible with the source you're using, or the player settings are incorrect.</li> <li>The digital output level has been turned down on a CD recorder or other component equipped with digital output level adjustment capability.</li> <li>The multichannel analog inputs are selected.</li> <li>The input signal type is set to <b>ANALOG</b>.</li> </ul>	<ul style="list-style-type: none"> <li>By choosing an advanced effect listening mode (see <i>Listening in surround sound</i> on page 31), you may be able to create an extra channel for the speaker.</li> <li>Assign the digital inputs correctly (see <i>Assigning the digital inputs</i> on page 64).</li> <li>Make sure you have properly connected the digital component to the corresponding input on the back of the receiver (see <i>Connecting up</i> on page 14).</li> <li>Choose a compatible source, or check the component's manual for the correct settings.</li> <li>Set the digital volume level of the player to full, or to the neutral position.</li> <li>Press <b>MULTI CH IN</b> again (see <i>Selecting the multichannel analog inputs</i> on page 39).</li> <li>Set the input signal type to <b>DIGITAL</b> (see <i>Choosing the input signal</i> on page 35).</li> </ul>
No sound is output or a noise is output when Dolby Digital/DTS software is played back.	<ul style="list-style-type: none"> <li>A DVD player not compatible with Dolby Digital/DTS is being used.</li> <li>The settings on the DVD player are incorrect and/or the DTS signal output is turned off.</li> <li>The digital output level is turned down on a CD player or other component equipped with digital output level adjustment capability. (The DTS signal has been altered by the player, and cannot be read.)</li> </ul>	<ul style="list-style-type: none"> <li>Make sure your DVD player is compatible with Dolby Digital/DTS.</li> <li>Make sure the player's settings are correct and/or the DTS signal out is on. Refer to the instruction manual supplied with the DVD player.</li> <li>Set the digital volume level of the player to full, or to the neutral position.</li> </ul>

## Other audio problems

Symptom	Cause	Remedy
Broadcast stations cannot be selected automatically, or there seems to be considerable noise in radio broadcasts.	<p><b>FM broadcasts</b></p> <ul style="list-style-type: none"> <li>The FM antenna is not fully extended or is poorly positioned.</li> <li>Weak radio signals.</li> </ul> <p><b>AM broadcasts</b></p> <ul style="list-style-type: none"> <li>The AM antenna is poorly positioned.</li> <li>Weak radio signals.</li> <li>Interference caused by other equipment (fluorescent lamp, motor, etc.).</li> </ul>	<ul style="list-style-type: none"> <li>Fully extend the FM wire antenna, position for best reception, and secure to a wall.</li> <li>Connect an outdoor FM antenna (see page 19).</li> <li>Adjust the direction and position for best reception.</li> <li>Connect an additional internal or external AM antenna (see page 19).</li> <li>Turn off the equipment causing the noise or move it away from the receiver.</li> <li>Place the antenna farther away from the equipment causing the noise.</li> </ul>
A multi channel DVD source appears to be downmixed from 2 channels during playback.	<ul style="list-style-type: none"> <li>The source is coming from something other than the <b>MULTI CH IN</b> jacks (for example, digital PCM output, etc.)</li> </ul>	<ul style="list-style-type: none"> <li>Check the <b>MULTI CH IN</b> connections (see <i>Connecting multichannel analog components</i> on page 17) and select the multichannel analog inputs with the <b>MULTI CH IN</b> button (see <i>Selecting the multichannel analog inputs</i> on page 39).</li> </ul>
Noise is output when scanning a DTS CD.	<ul style="list-style-type: none"> <li>The scan function performed by the player slightly alters the digital information, making it unreadable.</li> </ul>	<ul style="list-style-type: none"> <li>This is not a malfunction, but be sure to turn the volume down to prevent the output of loud noise from your speakers.</li> </ul>
When playing a DTS format LD there is audible noise on the soundtrack.	<ul style="list-style-type: none"> <li>The input signal type is set to <b>ANALOG</b>.</li> </ul>	<ul style="list-style-type: none"> <li>Set the input signal type to <b>DIGITAL</b> (see <i>Choosing the input signal</i> on page 35).</li> </ul>

Symptom	Cause	Remedy
Can't record audio.	<ul style="list-style-type: none"> <li>You are trying to make an analog recording from a digital signal, or a digital recording of an analog source.</li> <li>The digital source is copy protected.</li> <li>The analog <b>REC</b> jacks have not been connected properly.</li> </ul>	<ul style="list-style-type: none"> <li>You can only record analog to analog, or digital to digital.</li> <li>You can't record digital sources that have been copy protected.</li> <li>Check your analog connections (see <i>Connecting analog audio components</i> on page 17).</li> </ul>
Subwoofer output is very low.	<ul style="list-style-type: none"> <li>The speaker settings result in very little audio signal being sent to the subwoofer.</li> </ul>	<ul style="list-style-type: none"> <li>To route more audio signal to the subwoofer, set it to <b>PLUS</b>, or select <b>SMALL</b> for the front speaker setting (see <i>Speaker Setting</i> on page 46).</li> </ul>
Everything seems to be set up correctly, but the playback sound is odd.	<ul style="list-style-type: none"> <li>The speakers are out of phase.</li> </ul>	<ul style="list-style-type: none"> <li>Check that the positive/negative speaker terminals on the receiver are matched with the corresponding terminals on the speakers (see <i>Connecting the speakers</i> on page 20).</li> </ul>
Noise or hum can be heard even when there is no sound being input.	<ul style="list-style-type: none"> <li>There is electrical interference from another component or appliance.</li> </ul>	<ul style="list-style-type: none"> <li>Check that personal computers or other digital components connected to the same power source are not causing interference.</li> </ul>
There seems to be a time lag between the speakers and the output of the subwoofer.	<ul style="list-style-type: none"> <li>The subwoofer channel can be delayed slightly if run through a low-pass filter.</li> </ul>	<ul style="list-style-type: none"> <li>See <i>Automatically setting up for surround sound (MCACC)</i> on page 11 to set up your system again using MCACC (this will automatically compensate for a delay in the subwoofer output).</li> </ul>
The maximum volume available (shown in the front panel display) is lower than the <b>+12dB</b> maximum.	<ul style="list-style-type: none"> <li>The channel levels may have been adjusted.</li> </ul>	<ul style="list-style-type: none"> <li>This is not a malfunction. If the levels in <i>Channel Level</i> on page 47 have been adjusted, the maximum volume will change accordingly.</li> </ul>

## Video

Symptom	Cause	Remedy
No image is output when an input is selected.	<ul style="list-style-type: none"> <li>The video connections are incorrect.</li> <li>You are using component video connections and the component video inputs are assigned incorrectly.</li> <li>The DVD/video player settings are incorrect.</li> <li>The video input selected on the TV monitor is incorrect.</li> <li>The component video inputs are assigned to a video component connected only to the composite or S-Video terminals.</li> </ul>	<ul style="list-style-type: none"> <li>Make sure the video component is connected correctly (see page 18).</li> <li>Check <i>Assigning the component video inputs</i> on page 65 to make sure you're assigned the correct input.</li> <li>Set correctly. Refer to the instruction manual supplied with the DVD/video player.</li> <li>Set correctly. Refer to the instruction manual supplied with the TV.</li> <li>Check <i>Assigning the component video inputs</i> on page 65 to make sure the component video assign for that video component is switched to <b>OFF</b>.</li> </ul>
The <b>System Setup</b> screen doesn't appear.	<ul style="list-style-type: none"> <li>Some TVs connected to the receiver with component video cables do not display the <b>System Setup</b> screen when the Color Burst feature is on.</li> </ul>	<ul style="list-style-type: none"> <li>When the receiver is in standby, switch to <b>COLOR BURST OFF</b> by holding down the front panel <b>ACOUSTIC EQ</b> button and pressing <b>⏻ STANDBY/ON</b>. (the current setting appears in the display).</li> </ul>
Can't record video.	<ul style="list-style-type: none"> <li>You are trying to record a source connected to the component video jacks.</li> <li>The source is copy protected.</li> <li>The recorder's video input is hooked up using a different type of cable to the source video output.</li> </ul>	<ul style="list-style-type: none"> <li>Connect the source component to either the composite video or the S-video jacks (see <i>Connecting video components</i> on page 18).</li> <li>You can't record sources that have been copy protected.</li> <li>Hook up the source and the recorder using the same type of video cable (see <i>Making an audio or a video recording</i> on page 53).</li> </ul>

## Settings

Symptom	Cause	Remedy
The Auto MCACC Setup continually shows an error.	<ul style="list-style-type: none"> <li>The ambient noise level in the room is too high, or obstacles are blocking the setup microphone.</li> </ul>	<ul style="list-style-type: none"> <li>Keep the noise level in the room as low as possible when using the Auto MCACC Setup (see <i>Other problems when using the Auto MCACC Setup</i> on page 13 for more on this). If the noise cannot be kept low enough, you will have to set up the surround sound manually (page 45).</li> </ul>
After using the Auto MCACC Setup, the speaker size setting ( <b>LARGE</b> or <b>SMALL</b> ) is incorrect.	<ul style="list-style-type: none"> <li>There was some inaudible low-frequency noise in the room.</li> </ul>	<ul style="list-style-type: none"> <li>The low-frequency noise could have been caused by an air conditioner or motor. Switch off all appliances in the room and rerun the Auto MCACC Setup.</li> </ul>

## Display

Symptom	Cause	Remedy
The display is dark or off.	<ul style="list-style-type: none"> <li>The display is set to dark or off.</li> </ul>	<ul style="list-style-type: none"> <li>Press <b>FL. DIMMER</b> on the remote control repeatedly to select a different brightness.</li> </ul>
After making an adjustment the display goes off.	<ul style="list-style-type: none"> <li>The display is set to off.</li> </ul>	<ul style="list-style-type: none"> <li>Press <b>FL. DIMMER</b> on the remote control repeatedly to select a different brightness.</li> </ul>
You can't get <b>DIGITAL</b> to display when using the <b>SIGNAL SELECT</b> button.	<ul style="list-style-type: none"> <li>There is a problem with the digital connections or the digital input is assigned incorrectly.</li> <li>The multichannel analog inputs are selected.</li> </ul>	<ul style="list-style-type: none"> <li>Check your digital connections and/or assign the digital inputs correctly (see <i>Assigning the digital inputs</i> on page 64).</li> <li>Press <b>MULTI CH IN</b> again (see <i>Selecting the multichannel analog inputs</i> on page 39).</li> </ul>
The Dolby/DTS indicator doesn't light when playing Dolby/DTS software.	<ul style="list-style-type: none"> <li>The player is paused.</li> <li>The player's sound output settings are wrong.</li> </ul>	<ul style="list-style-type: none"> <li>Press play.</li> <li>Set the player correctly (consult the manual that came with the player, if necessary).</li> </ul>
When playing a DVD-Audio disc, the DVD player display shows <b>96 kHz</b> . However, the receiver's display does not.	<ul style="list-style-type: none"> <li>The audio from these discs is output from the analog audio jacks of the DVD player only; the receiver does not show the sampling rate of the input signal through the analog inputs.</li> </ul>	<ul style="list-style-type: none"> <li>This is not a malfunction. See also the operating instructions that came with your DVD player.</li> </ul>
During playback of a DTS 96/24 source, the display doesn't show <b>96kHz</b> .	<ul style="list-style-type: none"> <li>The receiver's input signal type is set to analog.</li> </ul>	<ul style="list-style-type: none"> <li>Set the receiver to <b>AUTO</b> or <b>DIGITAL</b> (see <i>Choosing the input signal</i> on page 35).</li> </ul>
When playing Dolby Digital or DTS sources, the receiver's format indicators do not light.	<ul style="list-style-type: none"> <li>No digital connection, or the digital connection is incorrect.</li> <li>The receiver's input signal type is set to analog.</li> <li>The DVD player is set to output Dolby Digital and/or DTS audio as PCM.</li> <li>The disc has several playback audio tracks; the one currently playing is actually PCM.</li> </ul>	<ul style="list-style-type: none"> <li>Check the digital audio connection (page 16).</li> <li>Set the receiver to <b>AUTO</b> or <b>DIGITAL</b> (see <i>Choosing the input signal</i> on page 35).</li> <li>Check the settings on the player. Set the output for Dolby Digital and DTS (no PCM conversion). See also the operating instructions that came with your DVD player.</li> <li>Switch the playback audio channel on your DVD player. See the operating instructions that came with your DVD player.</li> </ul>
When playing certain discs, none of the receiver's format indicators light.	<ul style="list-style-type: none"> <li>The audio format of the disc is not 5.1/6.1 channel.</li> </ul>	<ul style="list-style-type: none"> <li>This is not a malfunction. Check the disc packaging for details of the audio formats available on the disc.</li> </ul>
When playing a disc, the <b>PL II</b> or <b>Neo:6</b> indicator lights on the receiver.	<ul style="list-style-type: none"> <li>The input signal type is set to analog.</li> <li>A two channel soundtrack is currently playing.</li> <li>The soundtrack currently playing is encoded using Dolby Surround.</li> </ul>	<ul style="list-style-type: none"> <li>Set the receiver to <b>AUTO</b> or <b>DIGITAL</b> (see <i>Choosing the input signal</i> on page 35).</li> <li>This is not a malfunction. Check the disc packaging for details of the audio formats available on the disc.</li> <li>This is not a malfunction. Check the disc packaging for details of the audio formats available on the disc.</li> </ul>
During playback of a Surround EX or DTS ES source on the <b>Extended AUTO</b> setting, the <b>EX</b> and <b>ES</b> indicators don't light, or the signal is not properly processed.	<ul style="list-style-type: none"> <li>The source may be Dolby Surround EX / DTS ES software, but it has no flag to indicate it is 6.1 compatible.</li> </ul>	<ul style="list-style-type: none"> <li>Set to <b>Extended ON</b> (see <i>Using the surround back channel (Extended mode)</i> on page 36) then switch to the THX Surround EX or Standard EX listening mode (see <i>Listening in surround sound</i> on page 31).</li> </ul>



## Remote control

Symptom	Cause	Remedy
Cannot be remote controlled.	• The remote control batteries have worn out.	• Replace the batteries (see <i>Loading the batteries</i> on page 7).
	• Too far away or improper angle of operation.	• Operate within 7 meters and a 30° angle of the remote sensor on the front panel (see <i>Operating range of remote control unit</i> on page 30).
	• There is an obstacle between the receiver and the remote control.	• Remove the obstacle or move to another place.
	• Strong light such as fluorescent light is shining onto the unit's remote control sensor.	• Avoid exposing the remote sensor on the front panel to direct light.
	• Something is plugged into the <b>CONTROL IN</b> jack.	• Unplug the cable from the <b>CONTROL IN</b> jack and use remote normally (see <i>Operating other Pioneer components</i> on page 23).
Other components can't be operated with the system remote.	• The preset code settings are wrong.	• Input the correct preset code.
	• The batteries wore out and the system settings were cleared.	• Reset the proper system settings.
The SR cable is connected, but the connected components can't be operated with the remote.	• The SR cable hasn't been connected properly.	• Reinsert the SR cable, making sure it's connected to the right jack (see <i>Operating other Pioneer components</i> on page 23).
	• The rest of the component connections have not been made.	• Make sure an analog connection has been made between the units.
	• The component you have hooked up is not a Pioneer product.	• This feature only works with Pioneer products.

### Note

- If the unit does not operate normally due to external effects such as static electricity disconnect the power plug from the outlet and insert again to return to normal operating conditions.

## Resetting the main unit

Use this procedure to reset all the receiver's settings to the factory default. Use the front panel controls to do this.

- 1 Switch the receiver into standby.**
- 2 While holding down the TONE button, press and hold the  $\odot$  STANDBY/ON button for about three seconds.**
- 3 When you see RESET? appear in the display, press ENTER.**  
OK? shows in the display.
- 4 Press SYSTEM SETUP to confirm.**  
OK appears in the display to indicate that the receiver has been reset to the factory default settings.

## Switching the speaker impedance

We recommend using speakers of 8Ω with this system, but it is possible to switch the impedance setting if you plan to use speakers with a 6Ω impedance rating.

- **With the receiver in standby, press  $\odot$  STANDBY/ON while holding down the SPEAKERS button.**

Each time you do this, you switch between the impedance settings:

- **SP 6 OHM** – Use this setting if your speakers are rated at 6Ω.
- **SP 8 OHM** – Use this setting if your speakers are rated at 8Ω or more.

## Changing the TV format setting

If the **System Setup** menu is not displayed correctly, it may be that the TV system is set incorrectly for your country or region.

- **With the receiver in standby, press  $\odot$  STANDBY/ON while holding down the SIGNAL SELECT button.**

The display shows the new setting (**PAL** or **NTSC**).

## Surround sound formats

Below is a brief description of the main surround sound formats you'll find on DVDs, satellite, cable and terrestrial broadcasts, and video cassettes.

### Dolby

The Dolby technologies are explained below. See [www.dolby.com](http://www.dolby.com) for more detailed information.



### Dolby Digital

Dolby Digital is a multichannel digital audio coding system widely used in cinemas, and in the home for DVD and digital broadcast soundtracks. It can deliver up to six discrete audio channels, comprising five full range channels and a special LFE (low frequency effects) channel used mainly for deep, rumbling sound effects; hence the term "5.1-channel" Dolby Digital.

In addition to the format features above, Dolby Digital decoders offer downmixing for compatibility with mono, stereo and Dolby Pro Logic audio from a number of bit rates and channels. Another feature, called Dialog Normalization, attenuates programs based on the average level of dialog in a program relative to its peak level (also known as Dialnorm) in order to achieve uniform playback level.

### Dolby Digital Surround EX

Dolby Digital Surround EX (the EX stands for EXtended) is an extension of Dolby Digital encoding whereby a surround back channel is matrixed into the surround left/right channels for 6.1 channel playback. This allows for compatibility with Dolby Digital 5.1 channel decoding, as well as for decoding using Dolby Digital EX.

### Dolby Pro Logic IIx and Dolby Surround

Dolby Pro Logic IIx is an improved version of the Dolby Pro Logic II (and Dolby Pro Logic) *decoding* system. Using the innovative "steering logic" circuit, this system extracts surround sound from sources as follows:

- **Dolby Pro Logic** – 4.1 channel sound (mono surround) from any stereo source
- **Dolby Pro Logic II** – 5.1 channel sound (stereo surround) from any stereo source
- **Dolby Pro Logic IIx** – 6.1 or 7.1 channel sound (stereo surround and surround back) from two channel or 5.1 (and 6.1) channel sources

*With two channel sources, the ".1" subwoofer channel is generated by bass management in the receiver.*

Dolby Surround is an *encoding* system which embeds surround sound information within a stereo soundtrack, which a Dolby Pro Logic decoder can then use for enhanced surround listening with greater sound detail.

*Manufactured under license from Dolby Laboratories. "Dolby", "Pro Logic", and the double-D symbol are trademarks of Dolby Laboratories.*

### DTS

The DTS technologies are explained below. See [www.dtstech.com](http://www.dtstech.com) for more detailed information.



### DTS Digital Surround

DTS Digital Surround is a 5.1-channel audio coding system from Digital Theater Systems Inc. now widely used for DVD-Video, DVD-Audio, 5.1 music discs, digital broadcasts, and video games. It can deliver up to six discrete audio channels, comprising five full range channels, including an LFE channel. Higher sound quality is achieved through the use of a low compression rate, and high rates of transmittance during playback.

### DTS-ES

DTS-ES (the ES stands for Extended Surround) is a decoder that is capable of decoding both DTS-ES Discrete 6.1 and DTS-ES Matrix 6.1 encoded sources. DTS-ES Discrete 6.1 gives 'true' 6.1 channel sound, with a completely separate (discrete) surround back channel. DTS-ES Matrix 6.1 has a surround back channel matrixed into the surround left/right channels. Both sources are also compatible with a conventional DTS 5.1 channel decoder.

### DTS Neo:6

DTS Neo:6 can generate 6.1 channel surround sound from any matrixed stereo source (such as video or TV) and from 5.1 channel sources. It uses both the channel information already encoded into the source, as well as its own processing to determine channel localization (with two channel sources, the ".1" subwoofer channel is generated by bass management in the receiver). Two modes (Cinema and Music) are available using DTS Neo:6 with two channel sources.

### DTS 96/24

DTS 96/24 is an extension of the original DTS Digital Surround which offers high quality 96 kHz/24-bit audio using a DTS 96/24 decoder. This format is also fully backward compatible with all existing decoders. This means that DVD players can play this software using a conventional DTS 5.1 channel decoder.

*"DTS", "DTS-ES", "Neo:6" and "DTS 96/24" are trademarks of Digital Theater Systems, Inc.*

## Windows Media® Audio 9 Professional

Windows Media® Audio 9 Professional (WMA9 Pro) is a discrete surround format developed by Microsoft Corporation.



WMA9 Pro can support up to 5.1/7.1 channel playback with sampling rates up to 24-bit/96kHz. Using the unique WMA compression techniques, WMA9 Pro can deliver multichannel music and soundtracks over high-speed internet networks at low bit rates with minimal audio degradation. Playback may be enjoyed with the Windows Media® Player 9 Series (or other third-party media player) on a personal computer, or with an AV amplifier with on-board WMA9 Pro decoding.

*Windows Media® and the Windows logo are trademarks or registered trademarks of Microsoft Corporation in the United States and/or other countries.*

## About THX

The THX technologies are explained below. See [www.thx.com](http://www.thx.com) for more detailed information.



### THX Cinema processing

THX is an exclusive set of standards and technologies established by the world-renowned film production company, Lucasfilm Ltd. THX grew from George Lucas' personal desire to make your experience of the film soundtrack, in both movie theatres and in your home theatre, as faithful as possible to what the director intended. Movie soundtracks are mixed in special movie theatres called dubbing stages and are designed to be played back in movie theatres with similar equipment and conditions. This same soundtrack is then transferred directly onto Laserdisc, VHS tape, DVD, etc., and is not changed for playback in a small home theatre environment. THX engineers developed patented technologies to accurately translate the sound from the movie theatre environment into the home, correcting the tonal and spatial errors that occur. On this product, when the THX indicator is on, THX features are automatically added in Cinema modes (e.g. THX Cinema, THX Surround EX).

### Re-Equalization

The tonal balance of a film soundtrack will be excessively bright and harsh when played back over audio equipment in the home because film soundtracks were designed to be played back in large movie theaters using very different professional equipment. Re-Equalization restores the correct tonal balance for watching a movie soundtrack in a small home environment.

### Timbre Matching

The human ear changes our perception of a sound depending on the direction from which the sound is coming. In a movie theatre, there is an array of surround speakers so that the surround information is all around you. In a home theatre, you use only two speakers located to the side of your head. The Timbre Matching feature filters the information going to the surround speakers so that they more closely match the tonal characteristics of the sound coming from the front speakers. This ensures seamless panning between the front and surround speakers.

### Adaptive Decorrelation

In a movie theatre, a large number of surround speakers help create an enveloping surround sound experience, but in a home theatre there are usually only two speakers. This can make the surround speakers sound like headphones that lack spaciousness and envelopment. The surround sounds will also collapse into the closest speaker as you move away from the middle seating position. Adaptive Decorrelation slightly changes one surround channel's time and phase relationship with respect to the other surround channel. This expands the listening position and creates—with only two speakers—the same spacious surround experience as in a movie theatre.

### THX Select2

Before any home theatre component can be THX Select2 certified, it must incorporate all the features above and also pass a rigorous series of quality and performance tests. Only then can a product feature the THX Select2 logo, which is your guarantee that the Home Theatre products you purchase will give you superb performance for many years to come. THX Select2 requirements cover every aspect of the product including pre-amplifier and power amplifier performance and operation, and hundreds of other parameters in both the digital and analog domain.

### THX Surround EX

THX Surround EX - Dolby Digital Surround EX is a joint development of Dolby Laboratories and the THX Ltd. In a movie theater, film soundtracks that have been encoded with Dolby Digital Surround EX technology are able to reproduce an extra channel which has been added during the mixing of the program. This channel, called Surround Back, places sounds behind the listener in addition to the currently available front left, front center, front right, surround right, surround left and subwoofer channels. This additional channel provides the opportunity for more detailed imaging behind the listener and brings more depth, spacious ambience and sound localization than ever before. Movies that were created using the Dolby Digital Surround EX technology, when released into the home consumer market may exhibit wording to that effect on the packaging. A list of movies created using this technology can be found on the Dolby web site at [www.dolby.com](http://www.dolby.com).

Only receiver and controller products bearing the THX Surround EX logo, when in the THX Surround EX mode, faithfully reproduce this new technology in the home.

This product may also engage the "THX Surround EX" mode during the playback of 5.1 channel material that is not Dolby Digital Surround EX encoded. In such case the information delivered to the Surround Back channel will be program dependent and may or may not be very pleasing depending on the particular soundtrack and the tastes of the individual listener.

### Advanced Speaker Array (ASA)

ASA is a proprietary THX technology which processes the sound fed to 2 side and 2 back surround speakers to provide the optimal surround sound experience. When you set up your home theater system using all eight speaker outputs (Left, Center, Right, Surround Right, Surround Back Right, Surround Back Left, Surround Left and Subwoofer) placing the two Surround Back speakers close together facing the front of the room as shown in the diagram will provide the largest sweet spot. If for practical reasons you have to place the Surround Back speakers apart, you will need to go THX Audio Set-up screen and choose the setting that most closely corresponds to the speaker spacing, which will re-optimize the surround sound-field.

ASA is used in three new modes; THX Select2 Cinema, THX MusicMode and THX Games Mode.

### THX Select2 Cinema mode

THX Select2 Cinema mode plays 5.1 movies using all 8 speakers giving you the best possible movie watching experience. In this mode, ASA processing blends the side surround speakers and back surround speakers providing the optimal mix of ambient and directional surround sounds. DTS-ES (Matrix and 6.1 Discrete) and Dolby Digital Surround EX encoded soundtracks will be automatically detected in Select2 Cinema mode if the appropriate flag has been encoded.

Some Dolby Digital Surround EX soundtracks are missing the digital flag that allows automatic switching. If you know that the movie that you are watching is encoded in Surround EX, you can manually select the THX Surround EX playback mode, otherwise THX Select2 Cinema mode will apply ASA processing to provide optimum replay.

### THX MusicMode

For the replay of multi-channel music the THX MusicMode should be selected. In this mode THX ASA processing is applied to the surround channels of all 5.1 encoded music sources such as DTS, Dolby Digital and DVD-Audio to provide a wide stable rear soundstage.

### THX Games Mode

For the replay of stereo and multi-channel game audio the THX Games Mode should be selected. In this mode THX ASA processing is applied to the surround channels of all 5.1 and 2.0 encoded game sources such as analog, PCM, DTS and Dolby Digital. This accurately places all game audio surround information, providing a full 360 degree playback environment. THX Games Mode is unique as it gives you a smooth transition of audio in all points of the surround field.

*THX is a trademark or registered trademark of THX Ltd. Surround EX is a jointly developed technology of THX and Dolby Laboratories and is a trademark of Dolby Laboratories. Used under authorization. All rights reserved.*

## Specifications

### Amplifier section

#### Continuous Power Output (Stereo)

Front. . . . . 150 W + 150 W (DIN 1 kHz, THD 1 %, 6 Ω)  
120 W + 120 W (DIN 1 kHz, THD 1 %, 8 Ω)

#### Continuous Power Output (Multichannel)

Front. . . . . 150 W + 150 W (DIN 1 kHz, THD 1 %, 6 Ω)  
120 W + 120 W (DIN 1 kHz, THD 1 %, 8 Ω)

Center . . . . . 150 W (DIN 1 kHz, THD 1 %, 6 Ω)  
120 W (DIN 1 kHz, THD 1 %, 8 Ω)

Surround . . . . . 150 W + 150 W (DIN 1 kHz, THD 1 %, 6 Ω)  
120 W + 120 W (DIN 1 kHz, THD 1 %, 8 Ω)

Surround back 150 W + 150 W (DIN 1 kHz, THD 1 %, 6 Ω)  
120 W + 120 W (DIN 1 kHz, THD 1 %, 8 Ω)

Rated Power Output (Stereo). . . . . 140 W + 140 W  
(20 Hz–20 kHz, 0.09 %, 6 Ω)

Rated Power Output. . . . . 110 W + 110 W  
(20 Hz–20 kHz, 0.09 %, 8 Ω)

- The above specifications are applicable when the power supply is 230 V.

### Audio Section

#### Input (Sensitivity/Impedance)

LINE. . . . . 335 mV/47 kΩ

#### Frequency Response

LINE. . . . . 5 Hz to 100,000 Hz  $\pm 3$  dB

#### Output (Level/Impedance)

REC . . . . . 335 mV/2.2 kΩ

#### Tone Control

BASS . . . . .  $\pm 6$  dB (100 Hz)

TREBLE . . . . .  $\pm 6$  dB (10 kHz)

LOUDNESS. . . . . +4/+2 dB (100 Hz/10 kHz)  
(at volume position -40 dB)

#### Signal-to-Noise Ratio (IHF, short circuited, A network)

LINE. . . . . 103 dB

#### Signal-to-Noise Ratio

[DIN (continuous rated power output/50mW)]

LINE. . . . . 92/65 dB

### Composite Video / S-Video Section

Input (Sensitivity/Impedance) . . . . . 1 V<sub>p-p</sub>/75 Ω

Output (Level/Impedance) . . . . . 1 V<sub>p-p</sub>/75 Ω

Signal-to-Noise Ratio . . . . . 65 dB

Frequency Response . . . . . 5 Hz to 10 MHz  $\pm 3$  dB

### Component Video Section

Input (Sensitivity/Impedance) . . . . . 1 V<sub>p-p</sub>/75 Ω

Output (Level/Impedance) . . . . . 1 V<sub>p-p</sub>/75 Ω

Signal-to-Noise Ratio . . . . . 65 dB

Frequency Response . . . . . 5 Hz to 100 MHz  $\pm 3$  dB

### FM Tuner Section

Frequency Range . . . . . 87.5 MHz to 108 MHz

Usable Sensitivity . . . . . Mono: 15.2 dBf, IHF (1.6 μV/75 Ω)

50 dB Quieting Sensitivity . . . . . Mono: 20.2 dBf

Stereo: 41.2 dBf

Sensitivity (DIN) . . . . . Mono: 1.1 μV (S/N 26 dB)

Stereo: 50 μV (S/N 46 dB)

Signal-to-Noise Ratio . . . . . Mono: 76 dB (at 85 dBf)

Stereo: 72 dB (at 85 dBf)

Signal-to-Noise Ratio (DIN). . . . . Mono: 62 dB

Stereo: 58 dB

Distortion . . . . . Stereo: 0.6% (1 kHz)

Alternate Channel Selectivity . . . . . 70 dB (400 kHz)

Stereo Separation . . . . . 40 dB (1 kHz)

Frequency Response . . . . . 30 Hz to 15 kHz  $\pm 1$  dB

Antenna Input . . . . . 75 Ω unbalanced

### AM Tuner Section

Frequency Range . . . . . 531 kHz to 1,602 kHz (9 kHz step)

Sensitivity (IHF, Loop antenna) . . . . . 350 μV/m

Selectivity . . . . . 30 dB

Signal-to-Noise Ratio . . . . . 50 dB

Antenna . . . . . Loop antenna

### Miscellaneous

Power Requirements. . . . . AC 220–230 V, 50/60 Hz

Power Consumption . . . . . 430 W

In standby . . . . . 0.52 W

AC Outlet . . . . . (switched) 100 W MAX.

Dimensions . . . . . 420 (W) x 173 (H) x 465 (D) mm

Weight (without package). . . . . 15.4 kg

### Furnished Parts

Microphone (for Auto MCACC setup). . . . . 1

AA/LR6 dry cell batteries . . . . . 2

Remote control . . . . . 1

AM loop antenna . . . . . 1

FM wire antenna . . . . . 1

These operating instructions



#### Note

- Specifications and the design are subject to possible modifications without notice, due to improvements.

### Cleaning the unit

- Use a polishing cloth or dry cloth to wipe off dust and dirt.
- When the surface is dirty, wipe with a soft cloth dipped in some neutral cleanser diluted five or six times with water, and wrung out well, and then wipe again with a dry cloth. Do not use furniture wax or cleansers.
- Never use thinners, benzene, insecticide sprays or other chemicals on or near this unit, since these will corrode the surface.



Published by Pioneer Corporation.  
Copyright © 2005 Pioneer Corporation.  
All rights reserved.

---

**PIONEER CORPORATION**

4-1, Meguro 1-Chome, Meguro-ku, Tokyo 153-8654, Japan

**PIONEER ELECTRONICS (USA) INC.**

P.O. BOX 1540, Long Beach, California 90810-1540, U.S.A. TEL: (800) 421-1404

**PIONEER ELECTRONICS OF CANADA, INC.**

300 Allstate Parkway, Markham, Ontario L3R OP2, Canada TEL: 1-877-283-5901

**PIONEER EUROPE NV**

Haven 1087, Keetberglaan 1, B-9120 Melsele, Belgium TEL: 03/570.05.11

**PIONEER ELECTRONICS ASIACENTRE PTE. LTD.**

253 Alexandra Road, #04-01, Singapore 159936 TEL: 65-6472-7555

**PIONEER ELECTRONICS AUSTRALIA PTY. LTD.**

178-184 Boundary Road, Braeside, Victoria 3195, Australia, TEL: (03) 9586-6300

**PIONEER ELECTRONICS DE MEXICO S.A. DE C.V.**

Bldv.Manuel Avila Camacho 138 10 piso Col.Lomas de Chapultepec, Mexico,D.F. 11000 TEL: 55-9178-4270

## Free Manuals Download Website

<http://myh66.com>

<http://usermanuals.us>

<http://www.somanuals.com>

<http://www.4manuals.cc>

<http://www.manual-lib.com>

<http://www.404manual.com>

<http://www.luxmanual.com>

<http://aubethermostatmanual.com>

Golf course search by state

<http://golfingnear.com>

Email search by domain

<http://emailbydomain.com>

Auto manuals search

<http://auto.somanuals.com>

TV manuals search

<http://tv.somanuals.com>