

Pioneer *sound.vision.soul*

DVD-V5000

Industrial DVD Player

RS-232C

COMMAND PROTOCOL MANUAL

Manual Version 1.00

June 30, 2004

(Updated Dec 2005)

Pioneer Corporation
Pioneer Electronics (USA) Inc.
Business Solutions Division

This manual is copyrighted with all rights reserved. No part of this document may be reprinted, produced, translated or utilized in any form or by any means now known or hereafter invented including, but not limited to, any electronic, mechanical, photocopying and recording or information storage and retrieval system means, without the express written permission from Pioneer Electronics (USA), Inc.

Every effort has been made to ensure that the information in this manual is accurate. Pioneer is not responsible for printing or clerical errors.

Information in this document is subject to change without notice.

Copyright (c) 2004-2005 Pioneer Electronics (USA) Inc.

Document No. V5000_RS232_CPM-100

Printed in the United States of America.

Mention of third-party products is for informational purposes only and contributes neither an endorsement nor a recommendation. Pioneer assumes no responsibility with regard to the performance or use of these products.

No investigation has been made of common-law trademark rights in any word. Words that are known to have current registrations are shown with an initial capital. Many, if not all, hardware and/or software products referenced in this manual are identified by their trade names. Most, if not all, of these designations are claimed a legally protected trademarks by the companies that make the product. It is not Pioneer's intent to use any of these names generically and cautions the reader to investigate any claimed trademark before using it for any purpose other than to refer to the product to which the trademark is attached.

Pioneer makes no warranty of any kind, expressed or implied, about the contents of this manual, the merchantability of the product or the product's fitness for any particular purpose.

Every precaution has been taken in the preparation of this manual. Although we tried to thoroughly check that all instructions and information in this manual are accurate and correct, Pioneer can not be and is not responsible, in whole or in part, for any damage or loss to your data and/or equipment that results from your use of this document or from any information contained herein including, but not limited to, any errors, omissions or typos that may have resulted in an incorrect operation or installation.

FCC INFORMATION

The equipment described in this manual has been tested and found to comply with the limits for a Class B digital device in accordance with the specifications in Part 15 of FCC rules. These specifications are designed to provide reasonable protection against radio and television reception interference in a residential installation. There is no guarantee that interference will not occur in a particular installation.

To determine if your player is causing interference, turn the device OFF. If the player is causing the interference, try one or more of the following corrective measures:

- verify the cables and connectors between components are shielded.
- increase separation between the player and components.
- connect the changer into an outlet or circuit different from that which the components are connected.
- consult dealer or experienced radio/television technician for help.

The Federal Communications Commission offers a handbook that may help you with eliminating interference. The handbook is titled *Interference Handbook* (stock number 004-000-00493-1) and may be ordered from the U.S. Government Printing Office, Washington, D.C. 20402.

Warning: Any changes or modifications to this product that are not authorized by Pioneer could void the FCC Certification and negate the user's authority to operate the equipment.

DOC CLASS B COMPLIANCE

This digital apparatus does not exceed the Class B limits for radio noise emissions from digital apparatus set out in the radio interference regulations of the Canadian Department of Communications.

SAFETY CAUTION

Care should always be taken when working with electronic devices. To protect you and your DVD-V5000 player from damage or harm, it is important that you first read and then carefully follow the instructions in this documentation. Take particular care to heed all warnings and cautions marked on the unit and outlined in this document and the accompanying *DVD-V5000 Industrial Player Operating Instructions*. **IGNORING ANY OR ALL INSTRUCTIONS AND WARNINGS MAY CAUSE INJURY TO THE PERSON(S) OPERATING THE EQUIPMENT, DAMAGE TO THE PRODUCT OR BOTH.**

Table of Contents

1.	INTRODUCTION.....	1
2.	INTERFACE.....	2
2.1	Interface Connector	2
2.2	Serial Interface Pin Specification	2
2.3	Computer Control Functions	3
2.3.1	Serial Control (see Chapters 3, 4, 5 and 6)	3
2.3.2	Extend Terminal Control (see Chapter 9).....	3
2.3.3	External Power Control.....	3
3.	SERIAL CONTROL	5
3.1	Serial Interface Specifications.....	5
3.1.1	Signal Interface.....	5
3.1.2	Data Type	5
3.1.3	Data Transfer Speed (Baud Rate).....	5
3.2	Communication with a Computer.....	5
3.3	Command and Status	6
3.4	Error Messages	8
3.5	Initial Setting	8
4.	COMMAND STRUCTURE.....	9
4.1	Command Mnemonic.....	11
4.2	Argument	11
4.3	Command String.....	11
4.4	Status Returns	12
4.5	Error Message	12
4.6	Request Status Return	12
4.7	Timing	13
5.	COMMAND DESCRIPTIONS	14
5.1	Open	14
5.2	Close.....	14
5.3	Reject.....	14
5.3.1	Reject.....	15
5.4	Start	15
5.5	Play	16
5.6	Pause.....	17
5.7	Still (DVD, VCD)	17
5.8	Step Forward or Reverse (DVD).....	18
5.9	Scan Forward, Reverse, or Stop.....	18
5.10	Multi-Speed Forward or Reverse (DVD)	19

5.11	Speed (DVD, VCD).....	20
5.12	Search	21
5.13	Search & Play	22
5.14	Stop Marker	23
5.15	Lead-Out Symbol.....	24
5.16	Clear	25
5.17	Frame (DVD).....	26
5.18	Block Number (CD).....	26
5.19	Time (excludes discs without Time Codes)	26
5.20	Chapter (DVD)	27
5.21	Title (DVD)	27
5.23	Index (CD)	28
5.24	TRACK (CD, VCD).....	28
5.25	Select Subtitle (DVD)	28
5.26	Select Audio (DVD).....	29
5.27	Select Aspect (DVD).....	29
5.28	Select Angle (DVD).....	29
5.29	Select Parental-Level (DVD).....	30
5.30	Audio Control (DVD, CD, VCD)	30
5.31	Video Control	31
5.32	Display Control	32
5.33	Key Lock	33
5.34	Stack Group Set (DVD).....	34
5.35	Barcode /Command Stack Play (DVD).....	34
5.36	Stack Data Upload.....	35
5.37	Stack Data Download	38
6.	CURRENT PLAYER CONDITION REQUEST Descriptions.....	39
6.1	P-Block Number Request	39
6.2	Title/Track Number Request.....	39
6.3	Chapter Number Request (DVD).....	40
6.4	Time Code Request.....	40
6.5	Block Number Request (CD)	41
6.6	Frame Number Request (DVD)	41
6.7	Index Number Request (CD)	42
6.8	Total Frame Request (DVD)	42
6.9	TOC Information Request (CD/VCD).....	42
6.10	Disc Region Code Request (DVD).....	43
6.11	DVD Disc Status Request.....	43
6.12	CD Disc Status Request	44
6.13	Register A Set.....	45

6.14	Register D Set	47
6.15	Print Character.....	47
6.16	Clear Screen.....	48
6.17	Advanced Setup	49
6.18	Communication Control Set.....	50
6.19	Player Active Mode Request.....	50
6.20	Player Model Name Request.....	51
6.21	Advanced Setup Request	51
6.22	Player Region Code Request	52
6.23	CCR Mode Request.....	52
6.24	Input Number Request.....	52
6.25	Error Code Request	53
6.26	Input Unit Request.....	53
6.27	Input Barcode Data Request.....	54
6.28	Register A Request.....	54
6.29	Register D Request	54
6.30	Menu Call (DVD).....	55
6.31	Numeric Button (DVD)	56
6.32	Button Select (DVD)	56
6.33	Enter Button (DVD).....	57
6.34	Get Information (DVD)	58
6.35	Memory Data Upload.....	60
6.36	Return Firmware Version.....	61
7.	OPERATING MODES.....	62
7.1	Open	62
7.2	Park	62
7.3	Setup	62
7.4	Random Access.....	62
7.5	Reject.....	63
8.	DVD-V5000 INTERNAL REGISTERS	64
8.1	Current Time/Frame	64
8.2	P-TIME.....	64
8.3	Current Title/Track (Current Chapter).....	64
8.4	Current Index	64
8.5	Serial Digit Buffer.....	64
8.6	Remote Control Use Address Flag.....	64
8.7	Remote Control Digit Buffer	64
8.8	Remote Control Data Register.....	65
8.9	Laser Barcode Buffer	65
8.10	Serial Use Address Flag	65

8.11	Search Time/Frame	65
8.12	Search Title/Track (Search Chapter)	65
8.13	Search Index.....	65
8.14	Mark Time/Frame	65
8.15	Mark Title/Track (Mark Chapter).....	66
8.16	Mark Index	66
8.17	Video Control	66
8.18	Audio Control	66
8.19	Display Control	66
8.20	Registers.....	66
9.	EXTEND TERMINAL CONTROL	68
9.1	Function Assignment	69
9.2	Function User Setting	71
9.3	Controller	75
9.3.1	Simple Circuit	75
9.3.2	Diode Matrix Circuit	76
10.	ADDITIONAL NOTES.....	77
	Appendix A - Complete Command List by Name	78
	Appendix B - Complete Command List by Mnemonic.....	80
	Appendix C - DVD Command List	82
	Appendix D - CD Command List.....	84
	Appendix E - VCD Command List	86
	Appendix F - Error Codes	88

1. INTRODUCTION

This document defines the RS-232C command protocol for the Pioneer DVD-V5000 Industrial DVD Player.

The DVD-V5000 is capable of playing DVD, CD and VCD discs. The device has three control methods, front panel, remote control or computer interface through the RS-232C serial port.

This manual addresses the various commands and precautions required when using the Pioneer DVD-V5000 player with a computer. Please refer to the *DVD-V5000 Operating Instructions* for details on operating the unit via the front panel and/or remote control.

Chapter Number	Description
Chapter 2	describes the Interface Connector Specifications and the computer control features of the DVD-V5000
Chapter 3	discusses Baud Rate Settings, Interface Operation, Control Protocol, and Internal Operation via computer
Chapter 4	explains the Player Command Structure in detail
Chapter 5	reviews each command in detail
Chapter 6	defines Address and Player Condition requests
Chapter 7	relates to the various operating modes
Chapter 8	discusses the internal registers
Chapter 9	details the extend terminal control functions

CAUTION: The material in this manual is subject to change without notice.

2. INTERFACE

2.1 Interface Connector

A computer may be connected to the DVD-V5000 using a 15-pin D-Sub connector (e.g., a JAE DALC-J15SAF connector with suitable plug such as the JAE DA-15PF-N) to the RS-232C serial port or to the parallel port.

This unit is also equipped with 9pin connector for serial control.

In advanced setup user can choose which port to be used for serial control depends on the cable availability.

Either 9pin cross cable or conventional 15pin cable (same cable to be used with DVD-V7400).

The factory default setup is 15pin.

The pins are identified below:

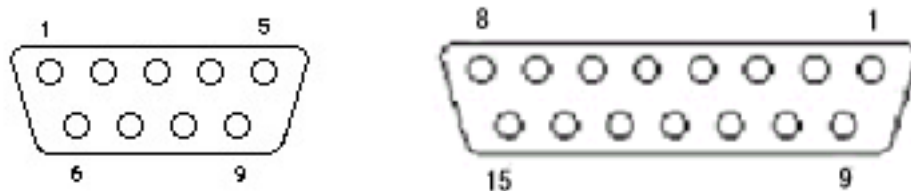

2.2 Serial Interface Pin Specification

15-pin D-Sub connector

Pin #	Terminal	Input/Output	Function
1	GND	--	ground
2	RxD	Input	receive data
3	TxD	Output	send data
4	DTR	Output	enable data receiving
5	POWER	Input	external power control
6	SW1	Input	
7	SW2	Input	
8	SW3	Input	
9	SW4	Input	
10	SW5	Input	
11	SW6	Input	
12	SW7	Input	
13	SW8	Input	
14	DLTST	Input	used only for servicing the unit – do not connect
15		NC	

9-pin D-Sub connector

Pin #	Terminal	Input/Output	Function
1	NC		
2	TxD	Output	send data
3	RxD	Input	receive data
4	DTR	Output	enable data receiving
5	GND	--	ground
6	DSR	Input	data set ready
7	RTS	Output	request to send
8	CTS	Input	clear to send
9	NC		

2.3 Computer Control Functions

2.3.1 Serial Control (see Chapters 3, 4, 5 and 6)

The player and computer are based upon the RS-232C protocol and are connected through the TxD, RxD, DTR and GND terminals.

2.3.2 Extend Terminal Control (see Chapter 9)

Control the player with the Extend Terminal Switches (SW#).

Even if the Key Lock is set (active), the extend terminal control is available.

2.3.3 External Power Control

Control the player's power with the Power Pin within the Interface Connector.

If the player detects a high signal throughput (100m/sec or more) during the Standby mode, the player powers ON. If the player detects the same signal during the Power ON mode, the player powers OFF and switches to the Standby mode.

The specifications for the Power pin are as follows:

Maximum Input Voltage	Less Than 12V
High Level Signal	More Than 4.5V
Low Level Signal	Less Than 0.5V

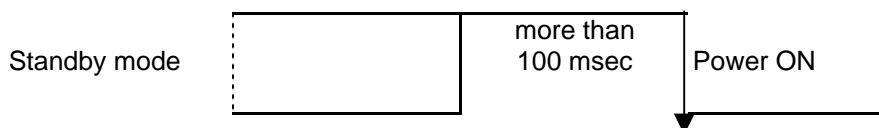

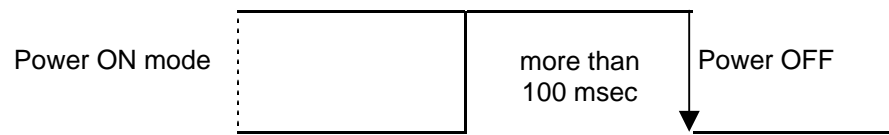

Check the Key Lock condition. If the Key Lock mode is active, the player ignores the control (refer to the Key Lock command description).

3. SERIAL CONTROL

3.1 Serial Interface Specifications

3.1.1 Signal Interface

The signal interface is a standard RS-232C connection.

3.1.2 Data Type

Data Length: 8 bit

Stop Bit: 1 bit

Parity bit: No Parity

3.1.3 Data Transfer Speed (Baud Rate)

The data transfer speed may be set to either 19200 or 9600 baud through the Advanced Setup Menu screen or with the Advanced Feature Menu Set command (refer to the DVD-V5000 Operating Instructions for command description).

NOTE: The factory default is 19200 baud; however, the player memorizes the transfer speed each time the power is cycled.

3.2 Communication with a Computer

The DVD-V5000 communicates to the computer through the RS-232C port using pins 2 and 3 for communication and Pin 1 for grounding in case of using 15-pin D-sub connector or Pin 5 for grounding when using 9-pin D-sub connector. Control or “handshaking” lines other than the TxD and RxD connections are not required. Please refer to the diagram below for clarification.

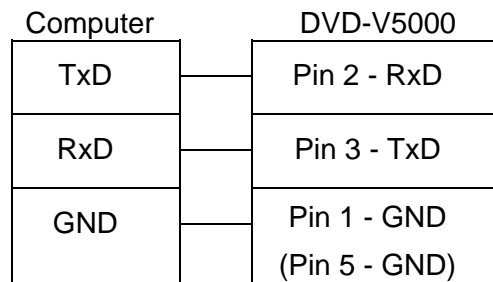

Some computers require the CTS port to be set to HIGH during communication. It is best to connect the CTS and DSR port on the computer to the DTR port on the player. During normal operation the player's DTR is set to HIGH thus the unit is able to receive a command at any time.

3.3 Command and Status

During normal operation, when a computer transmits commands to a DVD-V5000, the player responds with the status message, 'execution complete'.

Example

<u>COMPUTER</u>		<u>DVD-V5000</u>
(1) "Search to Frame 1000"	⇒	(2) Search Execution
	⇐	(3) Complete
(4) "Play to Frame 2000"	⇒	(5) Play Execution
	⇐	(6) Complete

NOTE: The length of a command string is limited to 32 characters. Please refer to COMMAND STRUCTURE for additional information.

When using a computer to control the DVD-V5000 player, follow the command protocols listed below:

- ASCII characters are used for actual commands and status response
- Command mnemonic is expressed as two (2) ASCII characters
- Uppercase letters are recommended; however, usually there are no distinctions between the uppercase and lowercase letters
- Some commands require an argument (e.g. Chapter number or speed)
- Use a command as the terminator of an argument

The player executes a command as soon as the carriage return <CR> is received. The <CR> acts as the command line terminator.

Example

CH<CR> : Set Chapter for address mode
10SE<CR> : Search to Chapter 10

The player has a command buffer, which stores a command string of up to 32 characters in length.

Example

10SE 20PL<CR> : Search to Chapter 10 then play to 20

The command string enters the buffer with the first character and continues sequentially from left to right. When the <CR> is entered, the commands are executed sequentially beginning with the first command in the buffer. In the example above, the first command is 10SE.

NOTE: The player ignores codes in the command string such as <SPACE> or <LF> (line feed) that have no affect on the player.

NOTE: Some commands, sent after a specialty command that includes an AUTOSTOP setting, (PL, MF, MR, etc.), cause the player to execute the new command before the AUTOSTOP is enacted (see Chapter 5, Command Descriptions).

When all the commands in a string have finished executing, the player transmits or *returns* the "complete" message that is represented by the capital letter **R**.

The player returns an R after a command has been executed. This response is called the Automatic Status. The Automatic Status signals the computer program to send the next command. If this function is not used, the command processing Time must be taken into consideration before the next command is sent.

If an error occurs, the player returns an error message such as E04. The message indicates an error has occurred as well as the type of error. Error messages are in the form of EXX where XX represents a 2-digit error code.

In some cases, an incorrect command sends the player to Search within a non-recorded area and the player returns an error message. Use the *Request Status* function to determine current status (actual player hardware failures are rare).

- ?P to determine the Active mode of the player
- ?X, ?M, ?H, ?S to determine the player information, model name, player region code, the setting of Advanced Setup Menu, etc.
- ?F, ?T, ?C, or ?R to determine the current Frame, Time, Chapter, Title/Track number, respectively.
- ?V, ?K, ?G, ?Y, or ?Q to determine the disc information, disc type, total Frame number, TOC information, etc.

The status functions are summarized below:

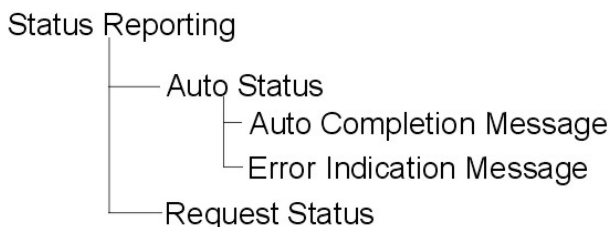

3.4 Error Messages

If an error occurs during a command execution, the player returns an error code. The table below lists each code with a description of the error:

Code	Message	Description
E00	Communication error	<i>Communication Line Error due to framing error or buffer overflow</i>
E04	Feature not available	<i>Non-Usable Function has been tried – either the command mnemonic is wrong or the command can not be used in this mode</i>
E06	Missing argument	<i>Correct parameter is not specified</i>
E11	Disc does not exist	<i>There is no disc in the tray</i>
E12	Search error	<i>Search address is missing</i>
E15	Picture stop	<i>Playback has been stopped by VOBU Still while in the Auto Play mode</i>
E16	Interrupt by other device	<i>The command(s) sent via the serial line were not executed before commands were sent from the front panel buttons and/or remote control</i>
E99	Panic	<i>Unrecoverable Error occurred – possible that a disc cannot be loaded and/or playing does not continue</i>

3.5 Initial Setting

The following table provides the default internal register and switch settings. Take care when setting the required parameters for an application program.

Register/Switch	Setting at Power ON
Video Switch	1 : ON
Audio Switch	3 : Audio 1
Display Switch	0 : OFF
Address mode	1 : Time
Speed Parameter	15 : 1/4 Speed
CCR	3 : Mode 3
Register A	3 : Title/Chapter and Frame Display (DVD) Track/Time Display (CD, VCD)
Register D	0 : CR

4. COMMAND STRUCTURE

The DVD-V5000 supports the commands listed below.

COMMAND		SUPPORTING FORMATS		
Name	Mnemonic	DVD	CD	VCD
Open	OP	X	X	X
Close	CO	X	X	X
Reject	RJ	X	X	X
Start	SA	X	X	X
Play	(adrs) PL	X	X	X
Pause	PA	X	X	X
Still	ST	X		X
Step Forward	SF	X		X
Step Reverse	SR	X		
Scan Forward	NF	X	X	X
Scan Reverse	NR	X	X	X
Scan Stop	NS	X	X	X
Multi-Speed Forward	(adrs) MF	X		X
Multi-Speed Reverse	(adrs) MR	X		
Speed	arg SP	X		X
Search	adrs SE	X	X	X
Search & Play	adrs SL	X	X	X
Stop Marker	adrs SM	X	X	X
Lead Out Symbol	LO	X	X	X
Clear	CL	X	X	X
Frame	FR	X		
Time	TM	X	X	X
Chapter	CH	X		
Title	TI	X		
Track	TR		X	X
Select Subtitle	arg SU	X		
Select Audio	arg AU	X		
Select Aspect	arg AP	X		
Select Angle	arg AG	X		
Select Parental-Level	arg PT	X		
Audio Control	arg AD	X	X	X
Video Control	arg VD	X	X	X
Display Control	arg DS	X	X	X
Keylock	arg KL	X	X	X
Stack Group Set	arg GP	X		
Barcode / Command Stack Play	arg BS	X		
Command Stack Data Upload	BU	X	X	X
Command Stack Data Download	BD	X	X	X
Block Number	BK		X	
Index	IX		X	

COMMAND		SUPPORTING FORMATS		
Name	Mnemonic	DVD	CD	VCD
P-Block Number Request	?A	X	X	X
Title/Track Number Request	?R	X	X	X
Chapter Number Request	?C	X		
Time Code Request	?T	X	X	X
Frame Number Request	?F	X		
Total Frame Request	?Y	X		
TOC Information Request	?Q		X	X
Disc Region Code Request	?G	X		
DVD Disc Status Request	?V	X		
CD Disc Status Request	?K		X	X
Block Number Request	?B		X	
Index Number Request	?I		X	
Register A Set (Display)	arg RA	X	X	X
Register D Set (TxD Term)	arg RD	X	X	X
Print Character	arg PR	X	X	X
Clear Screen	CS	X	X	X
Advanced Setup	arg MS	X	X	X
Communication Control Set	arg CM	X	X	X
Player Active Mode Request	?P	X	X	X
Player Model Name Request	?X	X	X	X
Advanced Setup Request	?S	X	X	X
Player Region Code Request	?H	X	X	X
CCR Mode Request	?M	X	X	X
Input Number Request	?N	X	X	X
Error Code Request	?E	X	X	X
Firmware Version Request	?Z	X	X	X
Input Unit Request	#I	X	X	X
Input Barcode Data Request	#B	X	X	X
Register A Request	\$A	X	X	X
Register D Request	\$D	X	X	X
Menu Call	arg MC	X		
Numeric Button	arg NB	X		
Button Select	arg CU	X		
ENTER Button	(arg) ET	X		
Get Information	arg GI	X		
Memory Data Upload *1	MU	X	X	X

NOTE: arg (argument) or ards (address) prefaces a command with an argument or address parameter. If the arg or ards is in parentheses (), the parameter is optional.

4.1 Command Mnemonic

Each command is expressed as two (2) ASCII characters. There is no distinction between uppercase and lowercase letters except when the Character strings are in a PR command.

4.2 Argument

An Argument, expressed in either ASCII characters or ten digits, consists of either an address or an integer. A Control Register uses an integer value to set a specified value or condition.

If a command requires an argument, it is always placed before the command.

Example : $N_1N_2N_3$
 Minimum 000 ~ Maximum 300 (except MS command)
 Minimum 000 ~ Maximum 2047 (Only MS command)

NOTE: If a command requires an argument but one is not supplied, the player returns an error message.

An Address can be a Title, a Chapter, a Track, a Frame Number, or a Time Code depending upon how the address flag is set. The Address must not exceed ten characters and/or digits.

Address Type	Media Type	Format	Range (Min-Max)
Title Number	DVD	N_1N_2	1 ~ 99
Chapter Number	DVD	N_1N_2	1 ~ 99
Frame Number	DVD	$N_1N_2N_3N_4N_5N_6$	1 ~ 999999
Time Code	DVD	$N_1N_2N_3N_4N_5^a$	0 ~ 599:59
	CD/VCD	$N_1N_2N_3N_4^b$	0 ~ 99:59
Track Number	CD/VCD	N_1N_2	1 ~ 99
Block Number	CD	$N_1N_2N_3N_4N_5N_6^c$	0 ~ 995974

4.3 Command String

A command string consists of multiple commands on one line. The maximum length of a command string is 32 characters. All command strings are terminated by the Carriage Return <CR> code (0DH hex).

Example : FR2000SE 2300PL<CR>

NOTE: Assign the following commands individually.

- Print Character [PR]

^a $N_1N_2N_3$ minutes N_4N_5 seconds.

^b N_1N_2 minutes N_3N_4 seconds.

^c N_1N_2 minutes N_3N_4 seconds N_5N_6 Block.

- Stack Data Upload [BU]
- Stack Data Download [BD]
- Memory Data Upload [MU]

Once the <CR> termination command is added to the string, the command string is executed from left to right in sequential order.

If an error occurs during the execution of a String, the remainder of the string following that command is ignored.

If a new command string is input before the current string executes completely, the current string is aborted and the remaining commands are cleared.

To cancel an executing string, send the termination command <CR> alone.

If a new command without [?*], [#*] or [\$*] is input while playing the current command stack, the remaining commands are cleared.

The DVD-V5000 does not accept other commands during the execution of a Search command, returning an E04 error message. After issuing a Search command, wait until the Return (R) status appears before issuing another command. An exception to this rule is the Mark Frame Play command (i.e. FR1200PL), when it is unnecessary to wait for the R status before sending additional commands.

4.4 Status Returns

The completion message used in the Automatic Status is **R**.

Example: R<CR>

4.5 Error Message

An error message consists of an **E** followed by a two-character error code.

Example: EN₁N₂<CR>

The error message occurs when the given command cannot be processed.

4.6 Request Status Return

In response to a single request command, the status returns as a line of letters terminated by <CR>.

5. COMMAND DESCRIPTIONS

5.1 Open

Function : Door Opens (Tray Ejects)

Format : OP

Explanation : If the command is sent while the player is in the Park mode, the tray ejects and the player enters the Open mode. After the tray is ejected, the player returns a completed status message.

If the player is in any mode other than Open or Park, the disc stops, the player enters Open mode and the door opens.

If the player is already in Open mode, an error message is returned.

Execution:

String	Status Return	DVD player
OP<CR>	R<CR>	Park mode to Open mode

5.2 Close

Function : Door closes (Tray closes)

Format : CO

Explanation : If the command is sent while the player door is open, the door closes then the player enters the Park mode. After the door closes, the player returns the completed status message.

If the player is in any mode other than Open or if the player door is already closed, an error message is returned.

Execution :

String	Status Return	DVD player
CO<CR>	R<CR>	Open mode to Park mode

5.3 Reject

Function : Disc rotation stops

Format : RJ

Explanation : If the command is sent while the player is in Random Access mode or Setup mode, the player enters Reject mode and the disc stops

rotating. Once the disc completely stops, the player enters Park mode and returns the completed status message.

If the command is sent while the player is in Park mode, the player enters the Open mode and the tray extends.

Execution :

String	Status Return	DVD player
RJ<CR>	R<CR>	Random Access mode to Park mode

NOTE: Sending a second Eject command causes the player to open the tray.

5.3.1 Reject

Function : Disc rotation stops

Format : 99RJ

Explanation : If the command is sent while the player is in Random Access mode or Setup mode, the player enters Reject mode and the disc stops rotating. Once the disc completely stops, the player enters Park mode and returns the completed status message.

If the command is sent while the player is in Park mode, the player returns the completed status message immediately without entering Open mode.

5.4 Start

Function : Disc rotation starts

Format : SA

Explanation : If the command is sent while the player is in Open, Park or Reject mode, the player immediately enters Setup and the disc begins spinning up. The player is ready for playback when the device reaches the beginning of the program (DVD, CD or VCD disc pauses or stills at the first Track). The player returns the completed status when the disc pauses or stills.

If the player receives the command while playing a menu, the player returns an error message. However, if the disc program does not allow new commands once playback begins, the player ignores the command.

Execution :

String	Status Return	DVD player
SA<CR>	R<CR>	Park mode to Pause mode
SA<CR>	E11<CR>	Open mode to Park mode <i>Error – No disc in tray</i>

5.5 Play

Function : Pictures and sound are reproduced (Option - Auto Stop)

Format : (Address)PL

Explanation : If the command is sent while the player is in Open mode, a DVD disc plays according to the menu selection or from the first Title if a menu is absent. If the command is sent while the player is in Park, or Reject mode, a DVD disc plays from the first Title. A CD/VCD disc plays from the first Track. The player returns the completed status message after playback begins.

If the player is in Random Access mode when the Play command is sent, the player enters Play mode and returns the completed status message. The Play is the only mode in which audio plays back simultaneously with video.

If an address is specified, an Auto Stop occurs on the selected sequence. The specified address is written as a Mark Frame or Mark Time and is compared with the current address. If the current address matches the specified address, the player enters Still mode and returns the completed status message.

If the Frame count difference is less than 24 Frames between the present Frame and the specified Frame, the player returns an E06 error message and the marker is not set.

The Auto Stop command is canceled if another command is sent before the player reaches the specified address. When this occurs, the player enters normal Play mode (the Stop Marker command is similar in function to Auto Stop).

If a VOB Still is detected before the player reaches the specified address, the player enters Still mode and returns an error message. However, if the disc program does not allow a stop, the player ignores the command and it returns an error message.

The available address modes are listed below:

Address Mode	DVD	CD	VCD
FR (Frame)	X		
TM (Time)	X	X	X
CH (Chapter)	X		
TI (Title)	X		
BK(Block)		X	
IX(Index)		X	
TR (Track)		X	X

Execution :

String	Status Return	DVD player
PL<CR>	R<CR>	Park mode to Play mode
TM0325PL<CR>	<i>plays to 3 minutes 25 seconds</i> R<CR>	Pause mode to Play mode Play mode to Still mode

5.6 Pause

Function : Playback ceases temporarily

Format : PA

Explanation : If the command is sent while the player is in Random Access mode, the pause occurs at the current disc location. The player returns the completed status message immediately.

In Pause mode, Still and Video Squelch are ACTIVE. However, if the disc program does not allow a pause, the player ignores the command and returns an error message (E04).

Execution :

String	Status Return	DVD player
PA<CR>	R<CR>	Play mode to Pause mode
PL<CR>	R<CR>	Return to Play mode

5.7 Still (DVD, VCD)

Function : Playback is stopped on a selected visual

Format : ST

Explanation : If the command is sent while the player is in Random Access mode, playback stops at the current disc position and the player enters Still mode. The player returns the completed status message immediately.

However, if the disc program does not allow a pause, the player ignores the command and returns an error message (E04).

Execution :

String	Status Return	DVD player
ST<CR>	R<CR>	Play mode to Still mode
PL<CR>	R<CR>	Return to Play mode

5.8 Step Forward or Reverse (DVD)

Function : Playback is moved forward or in reverse by one Frame

Format : SF (Step Forward)
SR (Step Reverse)

Explanation : If the command is sent while the player is in Random Access mode, the picture moves one Frame forward or one Frame in reverse. After the move is accomplished, the player enters Still mode and returns the completed status message.

If the disc program does not allow a pause, the player ignores the command and returns an error message (E04).

NOTE: A Video CD disc does not support the Step Reverse command

Execution :

String	Status Return	DVD player
SF<CR>	<i>Moves 1 Frame forward</i>	Play mode
	R<CR>	Still mode
SRSRSR<CR>	<i>Moves 3 Frames backwards</i>	Play mode
	R<CR>	Still mode

5.9 Scan Forward, Reverse, or Stop

Function : Playback moves quickly forward or in reverse

Format : NF (Quick Forward scanning of the disc)
NR (Quick Reverse scanning of the disc)
NS (Stop Quick Forward/Reverse scanning and return to normal playback)

Explanation : If the command is sent while the player is in Random Access mode, the screen proceeds forward (NF) or in reverse (NR) quickly. When

scanning is finished, the player resumes the Random Access mode and returns the completed status message.

If the SCAN command is sent while the player is in Fast Forward or Reverse Playback, the player enters Scan mode.

Once the NS command is sent, the player resets to the normal Playback mode and returns the completed status message.

Execution :

String	Status Return	DVD player
NF<CR> or NR<CR>	R<CR>	Play mode to Scan mode
NS<CR>	R<CR>	Return to Play mode

5.10 Multi-Speed Forward or Reverse (DVD)

Function : Playback occurs at the speed specified in the Speed Register
(Option - Auto Stop)

Format : (Address)MF (Multi-Speed Forward)
(Address)MR (Multi-Speed Reverse) (Address > 0)

Explanation : If the player is in Random Access mode when the command is executed, the player enters Multi-Speed mode and returns the completed status message immediately.

While in Multi-Speed mode, pictures are reproduced at the speed specified by the Speed Register. No audio tracks are played during Multi-Speed playback.

NOTE: These speeds are approximate values only.

If an address is specified, an Auto Stop occurs on the selected sequence. The specified address is written as a Mark Frame or Mark Time and is compared with the current address. If the current address matches the specified address, the player enters Pause or Still mode and returns the completed status message. This command functions in a similar manner as the Stop Marker command.

If another command is issued before the player reaches the specified Address, the Auto Stop command is canceled and the player enters normal Multi-Speed mode. However, if the disc program does not allow a pause, the player ignores the command.

NOTE: DVD offers only fixed speed reverse.

VCD offers 1/2 to 1/16 speed forward only. Sometimes, depending on its forward speed, VCD Multi-Speed Forward may finish several frames earlier than the target address because playback does not rely on Frame counts.

Sometimes an Auto Stop command within a Multi-Speed command misses the specific address. Depending upon when the command is sent, a playback address may be missed by a maximum of ten-Blocks.

The available address modes in each disc type are listed below:

Address Mode	DVD	CD	VCD
FR (Frame)	X		
TM (Time)	X		X
CH (Chapter)	X		
TI (Title)			
TR (Track)			X

Execution :

String	Status Return	DVD player
MF<CR>	R<CR>	Play to Multi-Speed mode
TM0325MF<CR>	<i>plays to 3 min. 25 secs</i> R<CR>	Pause to Multi-Speed mode Pause mode

5.11 Speed (DVD, VCD)

Function : Specifies the speed for Multi-Speed playback

Format : Integer SP

Explanation : The command rewrites the contents of the Speed Register and returns the completed status message. The current mode of the player remains the same.

The speed parameter indicates the number of fields per second. The range is 0 through 90 with a default value of 15. The relationship between the integer, speed parameter and the actual speed of the player is as follows:

Integer	Speed Parameter	Speed
60	46~90	1/1
30	23~45	1/2
15	12~22	1/4
7	6~11	1/8
4	3~5	1/16
1	0~2	1/30

NOTE: DVD only offers fixed reverse speeds that varies from about 1/8 to about 1/16 depending on the transfer rate.

NOTE: VCD only offers 1/2 to 1/16 forward speeds. Reverse speed is not available for VCD. Speeds are approximate values only.

Execution :

String	Status Return	DVD player
4SPMF<CR>	R<CR>	Play mode to 1/16 speed forward
30SP<CR>	R<CR>	Multi-Speed to 1/2 Multi-Speed
4SPMR<CR>	R<CR>	Slow speed reverse

5.12 Search

Function : Search to specified address

Format : Address SE

Explanation : The specified address is written into the Search Register in accordance with the current Search address mode.

When the Search command is sent to the player, the specified address is compared with the current address. The pick-up is moved so that the difference becomes 0.

Upon reaching the specified address, the player enters the Pause mode for a CD or the Still mode for others disc types. The player then returns the completed status message. If the player misses the specified address or cannot find it, an error message (E06 or E12) is returned. However, if the disc program disallows a Time, Chapter or Title Search, the player ignores the command and an error message (E04) is returned. In addition, if the disc program blocks the Pause command, the player ignores the command.

The DVD-V5000 does not accept other commands during the execution of a Search command, returning an E04 error message. After issuing a Search command, wait until the Return (R) status appears before issuing another command. An exception to this rule is the Mark Frame Play command (i.e.

FR1200PL), when it is unnecessary to wait for the R status before sending additional commands.

The available address modes are listed below:

Address Mode	DVD	CD	VCD
FR (Frame)	X		
TM (Time)	X	X	X
CH (Chapter)	X		
TI (Title)	X		
BK(Block)		X	
IX(Index)		X	
TR (Track)		X	X

Execution :

String	Status Return	DVD player
FR4500SE<CR>	<i>Search to Frame 4500 R<CR></i>	Play mode <i>Address Mode set = Frame</i> Still mode (DVD)
CH5SE<CR>	<i>Search to Chapter 5 R<CR></i>	Play mode <i>Address mode set = Chapter</i> Still mode
TR2SE<CR>	<i>Searches to Track 2 R<CR></i>	Play mode <i>Address mode set = Track</i> Still mode (VCD)

5.13 Search & Play

Function : Searches to specified address and starts to play immediately

Format : (Address) SL

Explanation : The specified address is written into an appropriate register according to the Address. The player then compares the address with the current address. The pick-up moves so that the difference becomes 0.

The player plays a disc immediately after reaching the specific address. In case the player misses or fails to locate the address, it returns an error code (E06 or E12). If Frame is selected in Address Mode, the player ignores the command.

The available address modes are listed below:

Address Mode	DVD	CD	VCD
FR (Frame)			
TM (Time)	X	X	X
CH (Chapter)	X		
TI (Title)	X		
BK(Block)		X	
IX(Index)		X	
TR (Track)		X	X

Execution :

String	Status Return	DVD player
CH5SL<CR>		Play mode
	R<CR>	Search Chapter 5 and Play
TR2SL<CR>		Search Track 2 and Play
	R<CR>	Search Track 2 and Play

5.14 Stop Marker

Function : Stop Marker is set to the specified address

Format : Address SM

Explanation : The specified address is written into the Mark-Frame Register or Mark-Chapter Register in accordance with the address specification flag. The player returns the completed status message immediately.

The Stop Marker is cleared when the player reaches the marked address via a Play command, a Multi-Speed operation or other action. The player enters the Pause mode (CD) or the Still mode (other disc types) with no messages returned. However, if the disc program does not allow a pause, the player ignores the command.

If the Frame count difference is less than 24 Frames between the present Frame and the stop marker address, the player returns an E06 error message and the marker is not set.

A Time Code or Chapter Number request notes if the player reaches the marked address. The Clear and Reject commands remove the marker.

The Stop Marker is the same in functionality as the Play (or Multi-Speed) Auto Stop commands. The primary difference is when the player return a status message. The Auto Stop command returns the completed status message when the player reaches the marked address. The Stop Marker command returns the message as soon as the Stop Marker is set.

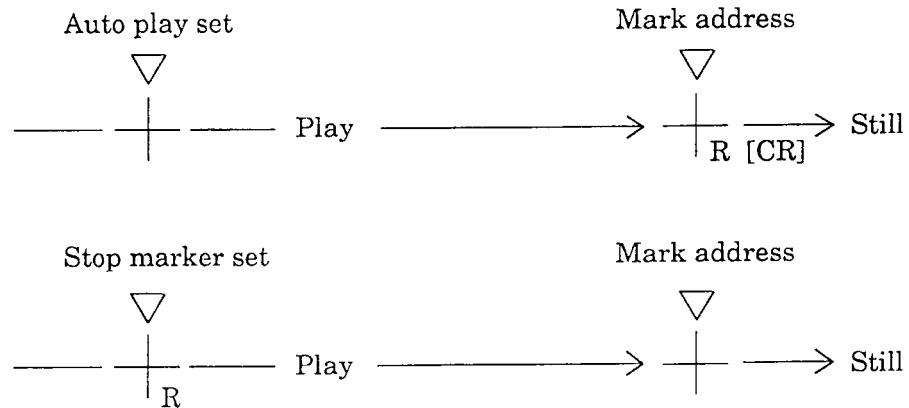

The available address modes are listed below:

Address Mode	DVD	CD	VCD
FR (Frame)	X		
TM (Time)	X	X	X
CH (Chapter)	X		
TI (Title)	X		
BK(Block)		X	
IX(Index)		X	
TR (Track)		X	X

Execution :

String	Status Return	DVD player
TM0325SMPL<CR>	R<CR>	Pause mode to Play mode
MF<CR>	R<CR>	Multi-Speed mode
PL<CR>	R<CR>	Play mode plays to 3 minutes 25 seconds ⇒ Still mode

5.15 Lead-Out Symbol

Function : Lead-Out is set for an address
Format : LO Command <CR>

Explanation : This symbol can be used in place of a Time Code or a Frame number as a target address for the Search or Auto Stop functions.

If the player has read the Table of Contents (TOC) from a disc, the Lead-Out Address or Frame Number can be translated into the lead-out Time.

The Lead-Out Search command on a CD or VCD disc stops the player at the end of a program area prior to the read-out area while the Lead-Out Search command on a DVD disc stops the player at the end of this Title.

NOTE: On a VCD disc, the Search address is set several seconds prior to the lead-out point because the Lead-Out command requires the player to read video data in advance.

Execution :

String	Status Return	DVD player
LOSE<CR>	R<CR>	Search to Still mode
?T<CR>	13642<CR>	<i>Time code in program end area</i>
LOPL<CR>	R<CR>	<i>Continue playing to lead-out and then return R<CR></i>

5.16 Clear

Function : Clears the digit buffer or mode

Format : CL

Explanation : The command clears the digit buffer content (input value) and returns the completed status message immediately.

The command releases the Auto Stop or the Stop Marker modes and returns the completed status message immediately. After the commands are released, the player begins normal playback. But the command does not release the Multi Speed command.

The Clear command releases the Repeat mode and erases the Command Stack selections.

Execution :

String	Status Return	DVD player
FR22000CL2300SE<CR>	<i>searches to Frame 2300</i> R<CR>	Play mode Still mode
TM500SMPL<CR>	R<CR>	Play with Stop Marker
CL<CR>	R<CR>	<i>Stop Marker is released and player begins normal playback</i>

5.17 Frame (DVD)

Function : Address specification flag is set to Frame

Format : FR

Explanation : Address assignment proceeds Frame by Frame. All subsequent addresses are handled as a Frame number.

NOTE: The player returns E04 when playing Video Recording format DVD.

Execution :

String	Status Return	DVD player
FR123450SE<CR>	<i>searches to Frame 123450</i>	Play to Search mode
	R<CR>	Still mode

[maximum number of Frames is 6-digits in length (999999)]

5.18 Block Number (CD)

Function : Address specification flag is set to Block

Format : BK

Explanation : Address assignment proceeds by Block. All subsequent addresses are handled as a Block number.

1 second consists of 75 Blocks.

The player is unable to Search to a Block Number on VCD disc.

Execution :

String	Status Return	DVD player
BK243020SE<CR>	<i>searches to 24 min, 30 secs, 20 Blocks</i>	Play to Search mode
	R<CR>	Pause mode

5.19 Time (excludes discs without Time Codes)

Function : Address specification flag is set to Time

Format : TM

Explanation : Address assignment proceeds by Time Code. All subsequent addresses are handled as a Time Code.

(please refer to section 8.10 Serial Use Address Flag)

Execution :

String	Status Return	DVD player
TM12345SE<CR>	<i>Search to 123 min, 45 secs</i>	Play to Search mode
R<CR>		Still mode

[maximum number for time is 5-digits in length (99959)]

5.20 Chapter (DVD)

Function : Address flag is set to Chapter

Format : CH

Explanation : Address assignment proceeds by Chapter number. All subsequent addresses are handled as a Chapter number. If the Chapter number is not recorded on the disc, an error message is returned.

(please refer to section 8.10 Serial Use Address Flag)

Execution :

String	Status Return	DVD player
CH23SE<CR>	<i>Search to Chapter 23</i>	Play to Search mode
R<CR>		Still mode

5.21 Title (DVD)

Function : Address flag is set to Title

Format : TI

Explanation : Address assignment proceeds by Title. All subsequent addresses are handled as a Title number.

(please refer to section 8.10 Serial Use Address Flag)

Execution :

String	Status Return	DVD player
TI5SE<CR>	<i>Search to Title 5</i>	Play to Search mode
R<CR>		Still mode

5.23 Index (CD)

Function : Address flag is set to Index

Format : IX

Explanation : Address assignment proceeds by Index. All subsequent addresses are handled as an Index number.

(please refer to 8.10 Serial Use Address Flag)

Execution :

String	Status Return	DVD player
IX1204SE<CR>	<i>Search to Index 4, Track 12</i>	Play to Search mode
	R<CR>	Pause mode (CD)

5.24 TRACK (CD, VCD)

Function : Address flag is set to Track

Format : TR

Explanation : Address assignment proceeds by Track. All subsequent addresses are handled as a Track number.

(please refer to section 8.10 Serial Use Address Flag)

Execution :

String	Status Return	DVD player
TR15SE<CR>	<i>Search to Track 15</i>	Play to Search mode
	R<CR>	Pause mode

5.25 Select Subtitle (DVD)

Function : Set Subtitle

Format : Integer SU

Explanation : The command sets the Subtitle (caption). The player allows up to 32 subtitles for playback. If an unavailable number is selected, the player returns an E06 error message.

Execution :

String	Status Return	DVD player
0SU<CR>		Play mode
	R<CR>	Subtitle off

5.26 Select Audio (DVD)

Function : Select Audio

Format : Integer AU

Explanation : The command selects the audio channel (Audio Track). The player allows up to 8 audio channels for playback. If an unavailable number is selected, the player returns an E06 error message.

NOTE: If the setting is 0, the Audio Mute is ON.

Execution :

String	Status Return	DVD player Play mode
0AU<CR>	R<CR>	Audio Mute ON

5.27 Select Aspect (DVD)

Format : Select Aspect Ratio

Function : Integer AP

Explanation : The command sets the Aspect Ratio for playback. The three ratios are Pan & Scan, Letter Box or Wide. If a disc does not offer video output options, the player returns an E04 error message.

Argument	Aspect Ratio (Video output)
1	Pan & Scan
2	Letter Box
3	Wide

5.28 Select Angle (DVD)

Function : Select Angle

Format : Integer AG

Explanation : The command selects a viewing angle. The player allows up to 9 angles (1AG through 9AG) for playback. If an unavailable angle is selected, the player returns an error message (E04 or E06).

Execution :

String	Status Return	DVD player Play mode
1AG<CR>	R<CR>	Angle is changed

5.29 Select Parental-Level (DVD)

Function : Set Parental Level

Format : Integer PT

Explanation : The command sets the parental level. The player allows up to 8 levels for playback. If an unavailable level is selected, the player returns an error message.

Note: The player accepts this command only when playing a DVD disc.

5.30 Audio Control (DVD, CD, VCD)

Function : Control Audio Output

Format : Integer AD

Explanation : The command allows changes to the audio output from the default value then returns the completed status message. The player resets to the default value when the tray opens or when the power cycles.

NOTE: The player automatically resets the audio control to 3 (Audio 1), when it is powered ON. And the player resets the audio control to 7 when CD or VCD is loaded.

The output channel assignment for each integer (argument) is listed below:

<u>Argument</u>	<u>DVD</u>	<u>CD¹</u>	<u>VCD</u>
0	Off	Off	Off
1	Audio 2	---	---
2	Audio 3	---	---
3	Audio 1	---	---
4	Off	Off	Off
5	Audio 5	L	L
6	Audio 6	R	R
7	Audio 4	Stereo	Stereo

When playing DVD VR with bilingual audio, the output channel assignment for each integer (argument) is listed below:

Argument DVD VR with bilingual

0	Off
1	---
2	---
3	---
4	Off
5	Main
6	Sub
7	Main + Sub

Execution :

String	Status Return	DVD player
5AD<CR>	R<CR>	audio output = Stereo becomes audio output = Audio 5, L-ch

5.31 Video Control

Function : Video switch is turned ON / OFF

Format : Integer VD

Explanation : The command switches the video output ON or OFF then returns the completed status message. The default is 1 (video ON).

The squelch switch adjusts the video output when the video control is ON (during playback). If the player is in Park or Pause mode, the video output is OFF and the color background is displayed.

When the Video Control is set to 0 (OFF), the video is squelched at all times.

Argument	Function	Video Switch
0	OFF	OFF
1	ON	ON

Execution :

String	Status Return	DVD player
0VD<CR>	R<CR>	Video Switch = ON to Video Switch = OFF

5.32 Display Control

Function : Character display is turned ON / OFF

Format : Integer DS

Explanation : The player rewrites the Display Control Register (argument) then returns the completed status message. The default register value is 0 (display switched OFF). Arguments can display User's Area Characters, Title Number, Time Code, Chapter Number and Audio Output information.

Display changes are restricted when Argument 1 is set through the serial connection. The remote control is blocked from changing the on-screen display.

NOTE: The displayed Frame number attempts to auto-correct to the actual Frame number, however, Frames continue to advance during playback.

Argument	Function
0	OFF
1	Displays user's area that is set by Register A
2	When playing DVD: Title, Number of total Title, play time Remain time and total time based on each Title Audio, Subtitle, Angle When playing CD/VCD: Track, Number of total Track, play time Remain time and total time based on each Title
3	When playing DVD: Chapter, Number of total Chapter, play time Remain time and total time based on each Chapter Transfer rate When playing CD/VCD: Play time, remain time and total time based on Disc

Execution :

String	Status Return	DVD player
1DS<CR>	R<CR>	Display Switch = OFF to Display Switch = ON <i>Display condition is set on Register A</i>
3DS<CR>	R<CR>	Display condition = 3
DS<CR>	R<CR>	Display Switch = OFF

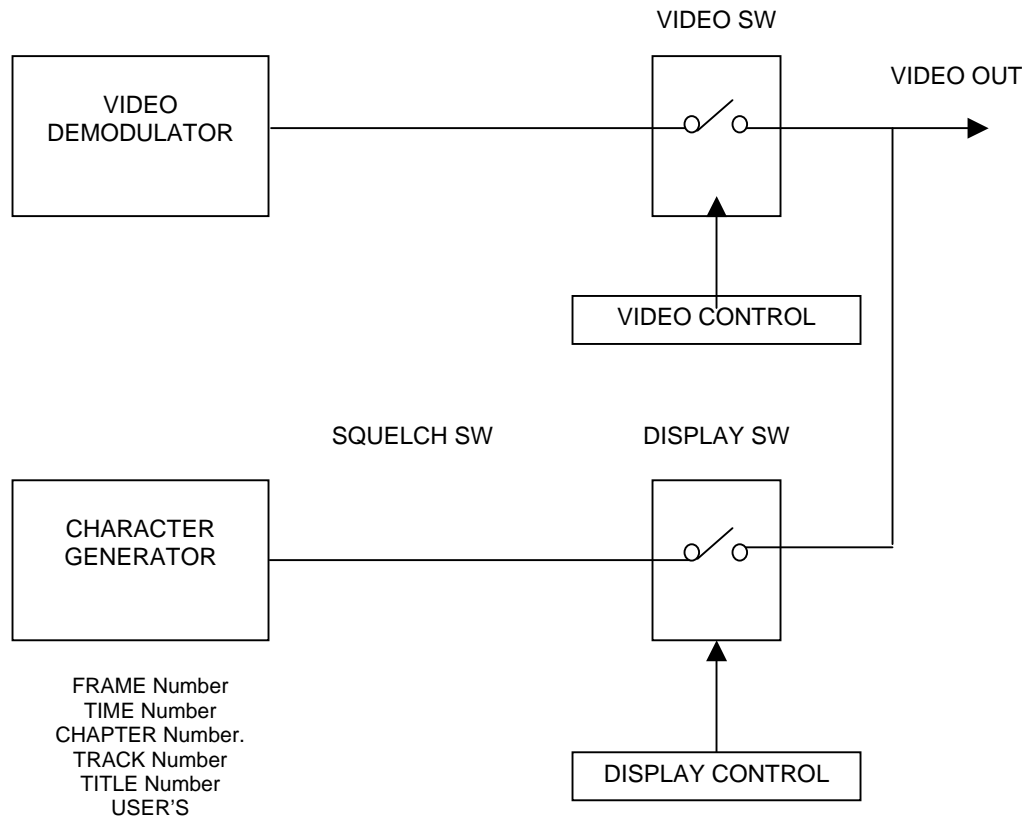

5.33 Key Lock

Function : The key lock switches ON / OFF

Format : Integer KL

Explanation : The command enables/disables the remote control and access through the front panel. The default value is 0 (OFF) thus the player is unlocked.

If the key lock switch is set to 1, all buttons (front panel and remote control) including the power control are disabled and IR and FRONT in ADV.SETUP is set to Disable. Use this setting for a PC-controlled player to lessen interference from outside sources such as remote controls.

If the key lock switch is set to 2, only the tray open button/key is disabled and the OP command no longer controls the tray. And the setting of TRY LOCK in ADV.SETUP is set to ON. Thus, after powering OFF the player, the locked tray protects the disc from unauthorized personnel.

Argument	Function
0	Unlock
1	Locks all keys include power
2	Locks only tray open

Execution :

String	Status Return	DVD player
1KL<CR>	R<CR>	Key Lock ON
OKL<CR>	R<CR>	Key Lock OFF (unlocked)
2KL<CR>	R<CR>	Tray Open Lock ON

5.34 Stack Group Set (DVD)

Function : Set the Command Stack Group

Format : Integer GP

Explanation : The command sets the stack group for execution or access. It is added in conjunction with the [BS] (BARCODE/COMMAND STACK PLAY) command.

1 to 300, decimal system integer number is used in the argument.

5.35 Barcode /Command Stack Play (DVD)

Function : Execute Barcode/Command Stack

Format : Integer BS

Explanation : The command executes the Barcode/Command stack group after specifying the group number with the GP command.

The player returns an E06 error message if the BS command is issued with an unknown or unspecified group/step number.

1 to 300, decimal system integer number is used in the argument.

Execution :

String	Status Return	DVD player
25GP16BS<CR>	R<CR>	Execute from group 25/step 16

5.36 Stack Data Upload

Function : Reads the data in the player: Command Stack data

Format : BU

Explanation : The player, while in Park mode, sends the data to the computer after sending the command.

The Communication flows as shown below.

(N=9320)

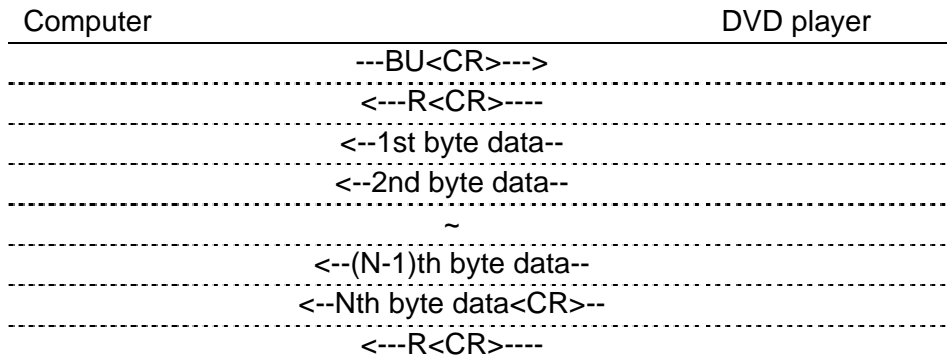

Format of the data:

BP	Contents	Numbers of bytes
0 - 1	(1) Total number of the transfer data (fixed number = 2468H)	2 bytes
2 - 3	(2) The version of this data format (fixed value)	2 bytes
4 - 5	(3) Barcode #1 Search Pointer	2 bytes
6 - 7	Barcode #2 Search Pointer	2 bytes
~	~	~
600 - 601	Barcode #299 Search Pointer	2 bytes
602 - 603	Barcode #300 Search Pointer	2 bytes
604 - 605	(4) Number of Next Barcode Data	2 bytes
606 - 607	(5) Number of Next Barcode Group	2 bytes
608 - 1207	(6) fixed data ffH	600 bytes
1208 - 1213	(7) fixed data ffH	6 bytes
1214 - 1215	(8) Next Data Address	2 bytes
1216 - 9315	(9) Command Stack Data	8100 bytes
9316 - 9319	(10) Checksum	4 bytes

- (1) Fixed data:
indicates the total data bytes of this transfer with HEX digits
2468H = 9320
- (2) Fixed data:
indicates the version of this data format is (0200H) now
To avoid errors, this code must remain intact. Do not change any digits within this code.
- (3)
indicates the head address of the #Nth Command Stack data
The head address is a relative address. The base address is (BP = 1216) and (BP = 1216) is the head byte of the Command Stack Data in this format.
(N = 1 ~ 300)
If the data of #Nth is invalid, it shows (ffffH).
- (4)
indicates the numbers of the registered Command Stacks
It is available from 0 to 299 in a HEX digit format.
- (5)
indicates the group number of the next Command Stack
It is available from 0 to 299 in a HEX digit format.
- (6) Fixed data:
- (7) Fixed data:
- (8)
indicates the head address of the next Command Stack data
The head address is a relative address. The base address is (BP = 1216) and (BP = 1216) is the head byte of the Command Stack Data in this format.
- (9)
Comprises the body of the data
- (10)
checksum of the data that indicates the result of adding up BP 0 through BP 9315 and shows in HEX (double word) format

Format of Barcode / Command Stack data in the data:

The length of Command Stack data is 16 bytes. This is a fixed length. Each byte is made up of aH (upper nibble) and one digit of the Barcode Command (lower nibble). The Barcode Command length is available up to 16 digits. If the command length is less than 16 digits, it fills with (00H).

Example:

Segment Play Command : Title 02, from Frame 3600 to Frame 4800
> 4020036000048007

BP	Data	Explanations
1216 + BARCODE_SRP #n	a4H	
+ 1	a0H	
+ 2	a2H	
+ 3	a0H	
+ 4	a0H	
+ 5	a3H	
+ 6	a6H	
+ 7	a0H	
+ 8	a0H	
+ 9	a0H	
+ 10	a0H	
+ 11	a4H	
+ 12	a8H	
+ 13	a0H	
+ 14	a0H	
+ 15	a7H	

*BARCODE_SRP #n : Barcode #n Search Pointer

Outline of Barcode Command : Barcode Command has these formats as follows.

DVD 4 digits command (sets the player, the video and the audio control)

DVD 6 digits command (sets the attribute control)

DVD 10 digits command (Chapter Search Command)

DVD 12-digit command (Chapter Segment Play)

DVD 14-digit command (Frame Search)

DVD 16-digit command (Segment Play)

The following four command functions in Command Stack are not regulated in Barcode Format. These commands are regulated as follows.

- 1) End of Group mark: The first byte is (ffH), the others are (00H)
- 2) REPEAT: (49a3H)
- 3) WAIT: (4bxxxxH)
- 4) GOTO: (4axxxxH)

*Refer to the Barcode Format

Execution :

String	Status Return	DVD player
BU<CR>		Park mode
	R<CR>	Receives the command and starts the transfer of the data, 9320 bytes (ends with <CR>)
	20e40010....026743<CR>	
	R<CR>	

5.37 Stack Data Download

Function : Sends the following data to the player; Command Stack data

Format : BD

Explanation : The computer sends Command Stack data to the Parked player if a disc is in the tray.

Refer to the descriptions of Command Stack Data Upload.

The Communication flows as follows.

(N=9320)

Computer	DVD player
	---BD<CR>--->
	<---R<CR>----
	--1st byte data-->
	--2nd byte data-->
	~
	--(N-1)th byte data-->
	--Nth byte data<CR>-->
	<---R<CR>----

Execution :

String	Status Return	DVD player
BD<CR>		Park mode
	R<CR>	Receives the command and starts the receiving data, 9320 bytes. It ends with <CR>.
20e40010....026743<CR>		
	R<CR>	

6. CURRENT PLAYER CONDITION REQUEST DESCRIPTIONS

6.1 P-Block Number Request

Function : The command returns information for the following groups:
 DVD – Title Numbers, Chapter Numbers, Time
 CD/VCD – Track Numbers, Index Numbers, Block Numbers, Time
 Format : ?A

Explanation : If the P-Block Number Request command is sent to a DVD disc, Title numbers, Chapter numbers and Time Code information are grouped together then the data is returned in a single report. A request sent to a CD/VCD disc returns Track numbers, Index numbers, Block numbers and Time Codes.

The continuous Frame count information may be missing from a report if the P-Block Number Request is sent while the player is in normal playback mode. The player does not update Frame counts while processing this command. Rather than returning an incorrect Frame count, the player ignores the request.

If the player is in Random Access Mode, the report contains correct values.

NOTE: The Time Code shows the elapsed time based on the chapter when playing DVD Video disc. And it shows the elapsed time based on the title when playing DVD VR disc.

Execution :

String	Status Return	DVD player
?A<CR>	1201033545<CR>	Play mode (CD) <i>Track 12, Index 1, 3 minutes, 35 seconds 45 Blocks</i>
?A<CR>	0135001247<CR>	Play mode (DVD) <i>Title 1, Chapter 35, 12 minutes, 47 seconds</i>

6.2 Title/Track Number Request

Function : Returns the current Title/Track number
 DVD : Title
 CD/VCD : Track

Format : ?R

Explanation : The player returns the contents of the Title/Track Number Register. The Track number is a 2-digit integer. Correct values show only when the player is in Random Access Mode.

Execution :

String	Status Return	DVD player
		Play mode (CD)
?R<CR>	12<CR>	<i>Player plays Track 12</i>

6.3 Chapter Number Request (DVD)

Function : Returns the current Chapter number

Format : ?C

Explanation : The player returns the contents of the Chapter Number Register. The Chapter number is a 2-digit integer. If a disc does not have Chapter numbers, the player returns an error message (E04). Correct values show only when the player is in Random Access Mode.

Execution :

String	Status Return	DVD player
		Play mode (DVD)
?C<CR>	12<CR>	<i>Player plays Chapter 12</i>

6.4 Time Code Request

Function : Returns the current Time Code

Format : ?T

Explanation : The player returns the contents of the Current Time/Frame Register.

If a DVD disc is playing, a 3-digit number is assigned for minutes and a 2-digit number is assigned for seconds.

If a CD or VCD disc is playing, a 1-digit number is assigned for hours (fixed 0), a 2-digit number is assigned for minutes and a 2-digit number is assigned for seconds.

If the player is in Random Access mode, the returned value is current.

If a disc lacks Time information, the player returns error message E04.

If a disc Time Code fails to be read correctly, the player retains the previous Time Code.

Execution :

String	Status Return	DVD player
		Play mode
?T<CR>	03213<CR>	32 minutes, 13 seconds(CD/VCD)
?T<CR>	11742<CR>	117 minutes, 42 seconds(DVD)

6.5 Block Number Request (CD)

Function : Returns the current Block number

Format : ?B

Explanation : The player returns the value of the current Block number as a 7-digit integer. Correct values show only when the player is in Random Access mode.

If a Block number is unavailable, the player retains the previous value.

Execution :

String	Status Return	DVD player
?B<CR>	0115310<CR>	Play mode 11 min, 53 sec, 10 Blocks

6.6 Frame Number Request (DVD)

Function : Returns the current Frame number

Format : ?F

Explanation : The player returns the contents of the Current Frame Register.

The player may experience a conflict between the command receiving/handling and the Frame number updating. Thus, continuous Frame numbers may be unavailable when the system is in Playback mode.

If the command is sent to a disc without Frame numbers, the player returns error message E04.

Accurate, current values are available when the player is in Random Access mode.

If a disc Frame number is unavailable, the player retains the previous value.

Execution :

String	Status Return	DVD player
?F<CR>	0002047<CR>	Play mode <i>Frame 2047</i>
?F<CR>	0095010<CR>	Play mode <i>Frame 95010</i>

6.7 Index Number Request (CD)

Function : Returns the current Index number

Format : ?I

Explanation : The player returns the current Index number as a 4-digit integer.
Correct values show only when the player is in Random Access Mode.

Execution :

String	Status Return	DVD player
?I<CR>	0102<CR>	Play mode <i>Track 1, Index 2</i>

6.8 Total Frame Request (DVD)

Function : Returns the total Frame number of the current Title

Format : ?Y

Explanation : The player returns the total Frame number of the current Title.

Execution :

String	Status Return	DVD player
?Y<CR>	0124832<CR>	Play mode <i>Frame 124832</i>

6.9 TOC Information Request (CD/VCD)

Function : Returns the Table of Contents (TOC) information

Format : ?Q

Explanation : The player returns the Track number of the first Track, the Track number of the last Track and the absolute time of starting lead-out.

Status information is returned in the following format:

C₁C₂C₃C₄C₅C₆C₇C₈C₉C₁₀<CR>

C ₁ C ₂	first Track number
C ₃ C ₄	last Track number
C ₅ C ₆ C ₇ C ₈ C ₉ C ₁₀	absolute Time of starting lead-out

Execution :

String	Status Return	DVD player
?Q<CR>	0109665544<CR>	Play mode <i>first Track is 1, last Track is 9, lead-out Time is 66 min, 55 sec, 44 Blocks</i>

6.10 Disc Region Code Request (DVD)

Function : Returns the region code of the disc

Format : ?G

Explanation : The player returns the approved region code(s) designated on the disc. Each bit indicates a region in a returned byte from the player. Bit 0 (LSB) indicates region 1, bit 1 indicates region 2, ..., bit 5 indicates region 6. Value 0 shows the disc as playable in its region.

Execution :

String	Status Return	DVD player
?G<CR>	F9<CR> (=11111001B)	Play mode <i>Region code 2 and 3</i>
?G<CR>	C0<CR> (=11000000B)	Play mode <i>Region code 1, 2, 3, 4, 5 and 6 (ALL)</i>

6.11 DVD Disc Status Request

Function : Returns the attributes of the DVD disc being played

Format : ?V

Explanation : The player returns the attributes of a DVD disc. Discs other than DVD, cause the player to return an error message (E04).

Status information is returned in the following format:

C₁C₂C₃C₄C₅<CR>

C ₁	Disc Mount	0 = No	1 = Yes	X = Unknown
C ₂	Layer Structure	0 = Single	1 = Dual	X = Unknown
C ₃	Path Type	0 = Parallel	1 = Opposite	X = Unknown
C ₄	Chapter Search	0 = Disable	1 = Available	X = Unknown
C ₅	Time Search	0 = Disable	1 = Available	X = Unknown

Execution :

String	Status Return	DVD player
?V<CR>	0XXXX<CR>	<i>Disc is not mounted</i>
?V<CR>	10010<CR>	<i>available Chapter Search but disable Time Search</i>
?V<CR>	E04<CR>	<i>Error – except DVD disc loaded</i>

6.12 CD Disc Status Request

Function : Returns the attributes of the CD disc being played

Format : ?K

Explanation The player returns the attributes of the CD disc. If the disc is other than a CD, the player returns an error message (E04).

Status information is returned in the following format:

C₁C₂C₃C₄C₅C₆C₇C₈<CR>

C ₁	Disc Mount	0 = No	1 = Yes	X = Unknown
C ₂	Not Used	X (fixed)		
C ₃	Not Used	X (fixed)		
C ₄	Not Used	X (fixed)		
C ₅	Not Used	X (fixed)		
C ₆	VCD	0 = No	1 = Yes	X = Unknown
C ₇	Reserved	X (fixed)		
C ₈	Reserved	X (fixed)		

Execution :

String	Status Return	DVD player
?K<CR>	0XXXXXXXX<CR>	<i>Disc is not mounted</i>
?K<CR>	1XXXX1XX<CR>	<i>VCD</i>
?K<CR>	E04<CR>	<i>DVD</i>

6.13 Register A Set

Function : The current setting of Resister A is rewritten

Format : Integer RA

Explanation : The command rewrites detailed display attributes into Register A.

The player offers three settings:

- Frame Number/Time code
- Title, Chapter Number/Track Number
- User's Area

NOTE: The displayed Frame number attempts to auto-correct to the actual Frame number, however, Frames continue to advance during playback.

Note: When selecting Frame Number/Time code while playing a DVD disc, the Frame Number is displayed on the screen. However, when playing back a DVD disc and selecting Time Code(DVD), Time Code is displayed. Time Code is displayed when playing back a CD or VCD disc.

The available display combinations are listed in the following table (Default value is 3):

Arg	Function	User's	T&CH / Track	Frame / Time	Time (DVD)
0	Display OFF	0	0	0	0
1	Frame Number (DVD)/Time Code (CD,VCD)	0	0	1	0
2	Title & Chapter Number/Track Number	0	1	0	0
3 (default)	Frame Number (DVD) / Time Code (CD, VCD) + Title, Chapter, Frame/Track, Time	0	1	1	0
4	User's area	1	0	0	0
5	User's area + Argument 1	1	0	1	0
6	User's area + Argument 2	1	1	0	0
7	User's area + Argument 3	1	1	1	0
11	Time Code (DVD, CD, VCD)	0	0	1	1
13	Time Code (DVD, CD, VCD) + Title & Chapter Number/Track Number	0	1	1	1
15	Time Code (DVD, CD, VCD) + User's Area	1	0	1	1
17	Time Code (DVD, CD, VCD) + Title & Chapter Number/Track Number + User's Area	1	1	1	1

The Display Control command turns the character display ON or OFF. The Register A Set command specifies what is displayed on the screen.

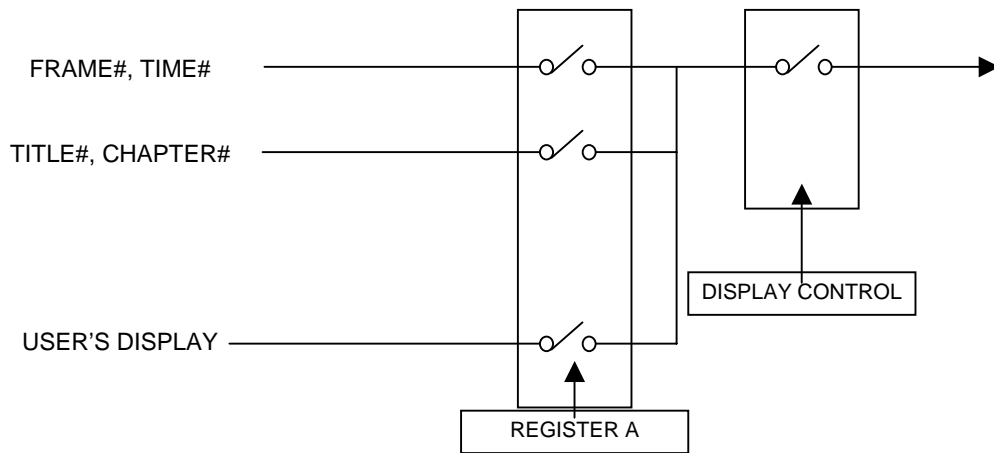

The screen display positions are pictured below.

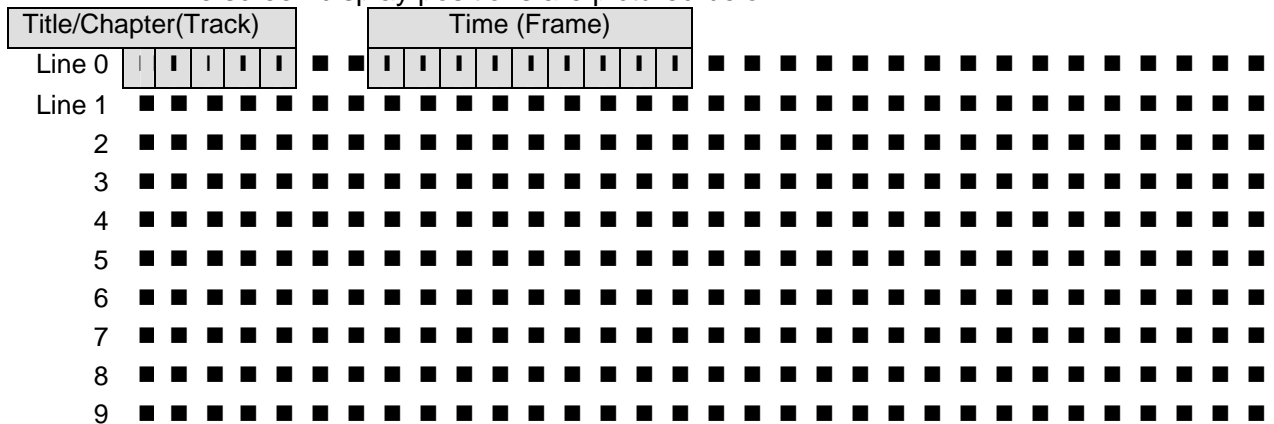

Line 0 displays the Time Code/Frame Number and/or Title/Chapter/Track Number(s).

The user's area has lines numbered from 0 to 9 with a total of 10 lines available. If line 0 is designated to show system information, all following lines are hidden.

The player allows/displays up to 320 characters (32 characters per line with 10 lines available). Follow the instructions below to create a User's Display:

1. Select User's Display in Register A
2. Set the display data using a print character command
3. Turn display switch ON

Execution :

String	Status Return	DVD player
1DS<CR>	R<CR>	Display Off to Display On
1RA<CR>	R<CR>	<i>Only Frame number is displayed</i>

6.14 Register D Set

Function : current setting of Register D is rewritten

Format : Integer RD

Explanation : Register D contains the termination setting of the serial communication (RS232). There are two choices, "CR" or "CR + LF". The default for Register D is 0.

Argument	Function
0 (default)	CR
64	CR + LF

6.15 Print Character

Function : Characters are written into the User's Display Area
(Not to be issued simultaneously with other commands)

Format : Integer PR <CR>
Character string <CR>

Explanation : The command writes a character string for one line into the User Display Area (turn ON the User Display Specification in Register A).

Follow the instructions listed below to create printed characters.

1. Specify the line number using an integer in the range 0 ~ 9

2. Enter the command character PR
3. Enter the terminate code <CR>
4. Specify the character string to enter in the next command string
(enter a character string up to 32 characters in length)

Available characters are shown in the table below (from 20h through 9Fh):

	0	1	2	3	4	5	6	7	8	9	A	B	C	D	E	F
2		!	"	#	\$	%	&	'	()	*	+	,	-	.	/
3	0	1	2	3	4	5	6	7	8	9	:	;	<	=	>	?
4	@	A	B	C	D	E	F	G	H	I	J	K	L	M	N	O
5	P	Q	R	S	T	U	V	W	X	Y	Z	[¥]	^	_
6	'	a	b	c	d	e	f	g	h	i	j	k	L	m	n	o
7	p	q	r	s	t	u	v	w	x	y	z	{		}	~	*1
C	À	Á	Â	Ã	Ä	Å	Æ	Ç	È	É	Ê	Ë	Ì	Í	Î	Ï
D	Ð	Ñ	Ò	Ó	Ô	Õ	Ö	×	Ø	Ù	Ú	Û	Ü	Ý	Þ	ß
E	à	á	â	ã	ä	å	æ	ç	è	é	ê	ë	ì	í	î	ï
F	ð	ñ	ò	ó	ô	õ	ö	÷	ø	ù	ú	û	ü	ý	þ	ÿ

*1 cannot be used

Execution :

String	Status Return	DVD player
4RA1DS<CR>	R<CR>	Register A and Display control set
4PR<CR>	R<CR>	Select Line 4
*** DVD player ***<CR>	R<CR>	Displays the characters like this ***DVD player***

6.16 Clear Screen

Function : Clears the characters shown in the User Display Area

Format : CS

Explanation : The player clears all characters from the User Display area. To clear only a particular line, use the PR command to overwrite the line with spaces.

Execution :

String	Status Return	DVD player
CS<CR>	R<CR>	All lines are cleared
3PR<CR>	R<CR>	Select line 3
HELLO!<CR>	R<CR>	Write letters on line 3, HELLO!

6.17 Advanced Setup

Function : current setting of Advanced Setup Menu is rewritten

Format : Integer MS

Explanation : The command rewrites the Advanced Setup Menu settings, which is expressed as an integer. The integer value is made up of the sum of the selected arguments. The player returns an error code if the command is issued while the Advanced Setup Menu is on the screen. The factory default value is 0.

The Advanced Feature Menu Request command (?S) reveals the current setting.

Argument	Function	Description	
		0	1
1	Reserved		
2	POWER ON START	OFF	ON
4	TITLE PLAY MODE	SINGLE	ALL
8	REPEAT MODE	(0) OFF, (8) CHAPTER (16) TITLE, (24) DISC *1)	
16			
32	BAUD RATE	19200bps	9600bps
64	TRAY LOCK	OFF	ON
128	IR LOCK	OFF	ON
256	FRONT LOCK	OFF	ON
512	SYNC OUT(DURING SQ)	OFF	ON
1024	EXTEND TERMINAL	Standard	User

*1): (Available when Title Play Mode is set to ALL)

The setting value is calculated as follows.

The value = $1 * (0 \text{ or } 1) + 2 * (0 \text{ or } 1) + 4 * (0 \text{ or } 1) + (0 \text{ or } 8 \text{ or } 16 \text{ or } 24) + 32 * (0 \text{ or } 1) + 64 * (0 \text{ or } 1) + 128 * (0 \text{ or } 1) + 256 * (0 \text{ or } 1) + 512 * (0 \text{ or } 1) + 1024 * (0 \text{ or } 1)$

Execution :

String	Status Return	DVD player
112MS<CR>	R<CR> (return rate is 9600bps)	<i>Title repeat mode (16)</i> <i>Baud rate is 9600bps (32)</i> <i>Tray lock on (64)</i>

6.18 Communication Control Set

Function : Selects the communication mode

Format : Integer CM

Explanation : command rewrites the contents of the Communication Control Register (CCR)

The CCR default value is set to Mode 3 (ON); however, the CCR Automatic Status may be switched OFF. Use the command to toggle the register ON or OFF.

Argument	Mode	Auto Status
2	Mode-2	OFF
3	Mode-3	ON

Execution :

String	Status Return	DVD player
2CM<CR>		CCR = 3 (<i>Default Communication Mode</i>) to CCR = 2 (<i>Communication Mode-2</i>)

6.19 Player Active Mode Request

Function : returns the player's current activity mode

Format : ?P

Explanation : The command confirms whether the player is running in the Random Access mode. The player returns an Active mode classification (refer to the table below).

Mode	Status
P00	Open
P01	Park
P02	Setup
P03	Unload
P04	Play

Mode	Status
P05	Still
P06	Pause
P07	Search
P08	Scan
P09	Multi-speed

The following table provides fuller explanations for each Active mode:

P00 (Open)	Disc tray is open
P01 (Park)	Disc rotation is stopped
P02 (Setup)	Preparation is being made for playback
P03 (Unload)	Disc rotation stops and disc tray opens
P04 (Play)	Audio and video are played at normal speed
P05 (Still)	Playback stops with video held on screen
P06 (Pause)	Playback stops and video is erased from screen
P07 (Search)	A specified address is searched for, a multi-track jump is in progress, or a Search for user's code is in progress
P08 (Scan)	Fast forward/reverse is in progress
P09 (Multi-speed)	Playback occurs at any one of several speeds

Execution :

String	Status Return	DVD player
?P<CR>	P04<CR>	Play mode
ST<CR>	R<CR>	Still mode
?P<CR>	P05<CR>	Still mode

6.20 Player Model Name Request

Function : Returns player model name

Format : ?X

Explanation : The command returns the player's name as P1570XX where P1570 is the series name and XX is a 2-digit serial code (not the product serial number).

Execution :

String	Status Return	DVD player
?X<CR>	P157001<CR>	<i>Series name P1570 and code 01</i>

6.21 Advanced Setup Request

Function : Returns the current setting of Advanced Setup Menu.

Format : ?S

Explanation : The player returns the current setting of the Advanced Setup Menu. The return is expressed as an integer value. The value is made up of the sum of the selected arguments. The factory default is set to 0. The player returns an error code if the command is issued when the player is showing

Advanced Setup Menu on the screen. See the description of Advanced Setup (MS).

NOTE: E04 is returned from a player when the command is issued while the Advanced Setup Menu is displayed.

Execution :

String	Status Return	DVD player
?S<CR>	112<CR>	<i>Title repeat mode (16)</i> <i>Baud rate is 9600bps (32)</i> <i>Tray lock on (64)</i>

6.22 Player Region Code Request

Function : Returns player region code

Format : ?H

Explanation : The command returns the player's region code.

Execution :

String	Status Return	DVD player
?H<CR>	02<CR>	<i>Region Code 2</i>

6.23 CCR Mode Request

Function : Returns the current communication mode

Format : ?M

Explanation : The command returns the contents of the Communication Control Register (CCR).

The CCR default value is set to Mode 3 (ON).

CM2	Mode-2
CM3	Mode-3

Execution :

String	Status Return	DVD player
?M<CR>	CM3<CR>	<i>CCR = 3 (Default Communication Mode)</i>

6.24 Input Number Request

Function : returns input numbers

Format : ?N

Explanation : The player waits the input of number from the remote controller and returns the input number.

Execution :

String	Status Return	DVD player
?N<CR>		<i>Waits to input the numeric numbers</i>
7<CR>	7<CR>	<i>7 entered from remote controller</i>

6.25 Error Code Request

Function : returns the latest error code

Format : ?E

Explanation : The player returns the most recent error codes. The report consists of Error Codes logged since the player was powered ON.

6.26 Input Unit Request

Function : returns a code for data input through a Remote control

Format : #I

Explanation : The player returns a four-digit ASCII-Hex code that represents commands sent through the remote control.

There are two code types, either a four-digit or eight-digit code (Extension code). When the input command data is two words (eight-digit) in length, the player truncates or shortens the information. A truncated code consists of an Upper Byte from the first code and a Lower Byte from the second code. The player creates a Returning Code or Double Code from these two bytes.

Once the player returns an Input Code, a FFFFh Code (no reactions from the remote control) repeats until a new code is sent from the remote control.

Execution :

String	Status Return	DVD player
#I<CR>	A39F<CR>	<i>Receives the Pause Key command -A39F</i>
#I<CR>	FFFFh<CR>	
#I<CR>	A3BE<CR>	<i>Receives the Audio Key command - A399_A3BE</i>
#I<CR>	FFFFh<CR>	

6.27 Input Barcode Data Request

Function : returns input data through a Barcode Reader

Format : #B

Explanation : The player returns an ASCII code that represents commands sent from a barcode reader.

NOTE: When the input data is unacceptable for the current disc type, the player returns an invalid code.

Execution :

String	Status Return	DVD player
#B<CR>	4307<CR>	<i>Receives a Play code about DVD disc</i>

6.28 Register A Request

Function : returns the contents of Register A

Format : \$A

Explanation : The player returns a detailed list of the Register A attributes.

Status information is returned in the following format:

AC₈C₇C₆C₅C₄C₃C₂C₁<CR>

C ₈ , C ₇ , C ₆	(Fixed 0)		
C ₅	Displays Time Code when playing DVD	0 = Off	1 = On
C ₄	(Fixed 0)		
C ₃	Displays User's Area	0 = Off	1 = On
C ₂	Displays Title & Chapter Numbers	0 = Off	1 = On
C ₁	Displays Frame Number (DVD) or Time Code (CD, VCD)	0 = Off	1 = On

Execution :

String	Status Return	DVD player
3RA<CR>	R<CR>	<i>Sets to Register A</i>
\$A<CR>	A00000011<CR>	<i>Requests information from Register A</i>

6.29 Register D Request

Function : returns the contents of Register D

Format : \$D

Explanation : The player returns the TxD termination setting from Register D

Status information is returned in the following format:

DC₈C₇C₆C₅C₄C₃C₂C₁<CR>

C ₈	Fixed 0		
C ₇	TxD termination	0 = CR	1 = CR + LF
C ₆	Fixed 0		
C ₅	Fixed 0		
C ₄	Fixed 0		
C ₃	Fixed 0		
C ₂	Fixed 0		
C ₁	Fixed 0		

Execution :

String	Status Return	DVD player
64RD<CR>	R<CR>	<i>Sets the Register D</i>
\$D<CR>	D01000000<CR>	<i>Requests information from Register D</i>

6.30 Menu Call (DVD)

Function : calls a disc menu or goes back to the former address

Format : Integer MC

Explanation : If the disc has a disc menu, the root menu or the Title menu comes up on the screen. If the screen is Still or if it is playing, these menus come up on the display. The command specifies the menu type with two integer numbers.

Integer	Menu type
1	Title
2	Root

If the player receives the command without an integer (while playing a menu), the player reverts to the previous Stilled or played address.

If the command is valid for the situation, the player immediately returns "R<CR>".

If the disc is missing the requested menu, [1 or 2 MC<CR>], the player returns an error message (E04).

*: However, the command is held or incompletely executed.

Execution :

String	Status Return	DVD player
		Plays some video Title
2MC<CR>	R<CR>	Shows the root menu
MC<CR>	R<CR>	Reverts back to the previously played Title

6.31 Numeric Button (DVD)

Function : Selects the button and executes by number

Format : Integer NB

Explanation : The command selects the menu button highlighted on the screen and executes the action assigned to the button. The command emulates the "digit" key on the remote control while the button resides on the display.

If the command is valid for the current player activity, the player immediately returns "R<CR>".

If the disc that is being played does not have the button in that screen when the command is issued, an error message (E06) is returned.

* However, this does not confirm that the command is executed completely.

Execution :

String	Status Return	DVD player
		Shows the disc menu
3NB<CR>	R<CR>	Selects and executes the button #3

6.32 Button Select (DVD)

Function : Selects the button (arrow key emulation)

Format : Integer CU

Explanation : The command selects the menu button displayed on the screen. The command emulates the "arrow" key on the remote control while the button exists on the screen. The command specifies the direction using four numbers:

Integer	directions
1	Up
2	Down
3	Left
4	Right

If the command is valid for the situation, the player immediately returns "R<CR>".

If there are no buttons on the screen when the command is issued, an error message (E04) is returned.

*: However, this does not confirm that the command is executed completely.

Execution :

String	Status Return	DVD player
		Shows the disc menu
2CU<CR>	R<CR>	Moves the cursor down to the next button

6.33 Enter Button (DVD)

Function : sets the button and executes

Format : (Integer) ET

Explanation : The command fixes the button on the screen after executing the CU command with an integer. The player executes the program that is assigned to that button. This command emulates the "enter" key on the remote control while the button is on the screen.

If the command is appropriate for the situation, the player returns immediately "R<CR>".

If there are no buttons on the screen when the command is issued, an error message (E04) is returned.

*: However, this does not confirm that the command is executed completely.

Execution :

String	Status Return	DVD player
		Shows the disc menu
2CU<CR>	R<CR>	Moves to the below button from the prior one
ET<CR>	R<CR>	Fixes the selection and executes the program that is assigned on it

Function : emulates the "left" click of the mouse

Format : argument1, argument2 ET

Explanation : The command emulates the “left” click of the mouse while the cursor is on the screen. The command specifies the position of the cursor with two arguments. The upper left on the screen is (0,0), the lower right on the screen is (719, 479) for NTSC playback, or (719, 575) for PAL. The format is stated below.

Argument1	Argument 2	Position
000000		Upper left limitation on the screen
	719479	Lower right limitation on the screen
X ₁ X ₂ X ₃ Y ₁ Y ₂ Y ₃		Anywhere on the screen

If the arguments are available, the player immediately returns “R<CR>”*.

If the argument number is unavailable, an error message (E06) is returned.

* The return “R<CR>” refers only to checking for an argument number. The player is incapable of verifying the existence of a button with this command.

Execution :

String	Status Return	DVD player
256384ET<CR>	R<CR>	Emulates the “left” click at the point (256,384) on the screen

6.34 Get Information (DVD)

Function : gets the disc information

Format : Integer GI

Explanation : The command, combined with a 4-digit ID and a 4-digit Sub-ID, returns the requested information to the player.

Integer = XXXXYYYY

ID (XXXX)	Sub-ID (YYYY)	Return Data from the Player
0000	Any number	E06 (argument error)
0001	0000 to 0023	System Parameter Info (4-digit)
0001	More than 0023	E06 (argument error)
00002 or more	Any number	E06 (argument error)

The player only returns system parameter information in cases where ID = 0001, otherwise the player returns error message E06.

Below is a list of the (SPRM) System Parameter. For more information, refer to "Table 4.6.1.2-1: System Parameters (SPRMs) in the DVD Specifications for a Read-Only Disc, (Part 3 VIDEO SPECIFICATIONS).

SPRM	Explanation
0	Menu Description Language Code (M_LCD)
1	Audio stream number (ASTN) for TT_DOM
2	Sub-picture stream number (SPSTN) & TT_DOM On/Off flag
3	Angle number (AGLN) for TT_DOM
4	Title number (TTN) for TT_DOM
5	VTS Title number (VTS_TTN) for TT_DOM
6	Title PGC number (TT_PGCN) for TT_DOM
7	Part_of_Title number (PTTN) for One_Sequential_PGC_Title
8	Highlighted Button number (HL_BTNN) for Selection state
9	Navigation Timer (NV_TMR)
10	TT_PGCN for NV_TMR
11	Player Audio Mixing Mode (P_AMXMD) for Karaoke
12	Country Code (CTY_LVL) for Parental Management
13	Parental Level (PTL_LVL)
14	Player Configuration (P_CFG) for Video
15	P_CFG for Audio
16	Initial Language Code (INI_LCD) for AST
17	INI_LCD_EXT for AST
18	INI_LCD for SPST
19	(INI_LCD_EXT) Initial Language Code extension for SPST
20	Player Region Code
21	reserved
22	reserved
23	reserved for extended playback mode

For example

SPRM(8): Highlighted Button number (HL_BTNN) for Selection state

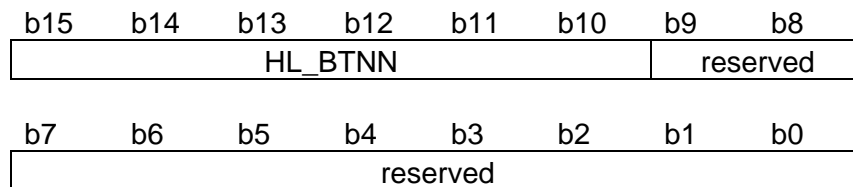

HL_BTNN.....	1 to 36:	HL_BTNN value
	Others:	reserved

Execution :

String	Status Return	DVD player
00010008GI<CR>	1400<CR>	Selecting button #5 now

6.35 Memory Data Upload

Function : reads the data from internal memory in a player

Format : MU

Explanation : The player, while in Park mode, sends the data to the computer with the total bytes equaling 11,134bytes

* 1,796bytes in data composed of Condition, Last memory (SETUP, ADV.SETUP, Error History, Program area, etc.)

* 9,332 bytes data such as Command Stack data

Both sets of information can be read at the same time.

The Communication flows as shown below.

(N=11,134)

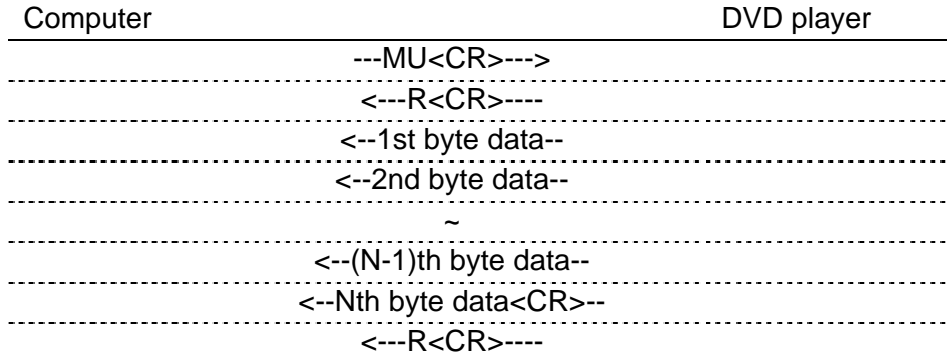

Format of the data:

BP	Contents	Numbers of bytes
0 - 1	(1) Total number of the transfer data (fixed number = 2B7EH)	2 bytes
2 - 5	(2) 00000000	4 bytes
6 - 9	(3) Player ID (501570XX)	4 bytes
10 - 9,333	(4) Command Stack Data	9,324 bytes
9,334-9,361	(5) All FF	28 bytes
9,362 – 11,049	(6) Setup data	1688 bytes
11050 – 11065	(7) ADV.SETUP setting data	16 bytes
11,066 – 11,129	(8) Extend Terminal user setting data	64bytes
11130 – 11133	(9) check sum	4 bytes

Execution :

String	Status Return	DVD player
MU<CR>	R<CR> ...(11,134 bytes)...<CR>	Park mode Receives the command and starts the transfer of the data, 11,134 bytes (ends with <CR>)
	R<CR>	

6.36 Return Firmware Version

Function : Returns player firmware version

Format : ?Z

Explanation : The command lists a number on the monitor that is the player's current firmware version.

Execution :

String	Status Return	DVD player
?Z<CR>	1.026	<i>Returns current firmware version</i>

7. OPERATING MODES

The Operating or Active mode consists of five sub-modes; Open, Park, Setup, Random Access and Reject. A command causes the player to change from one sub-mode to another. The five sub-modes are described below.

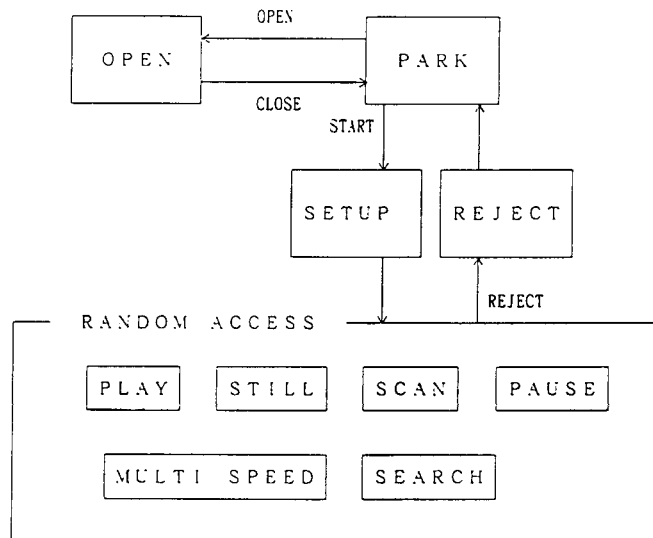

7.1 Open

The disc tray is open.

7.2 Park

The player enters the Park mode when the tray is closed.

7.3 Setup

If the Start command is sent while a disc is in the player, the disc spins up and the player proceeds to the Setup mode.

7.4 Random Access

The player enters the Random Access mode when the disc is ready for playback.

The Random Access mode is divided into six sub-modes; Play, Still, Scan, Pause, Multi Speed and Search. Various picture controls in the Random Access mode are available when playing a DVD or VCD disc. The effects are achieved

through highly detailed mode transfers. Refer to the previous figure for mode relationship information.

7.5 Reject

When the Reject command is sent to the player, video playback stops. Once the disc rotation has stopped, the player enters the Park mode.

8. DVD-V5000 INTERNAL REGISTERS

When arguments (e.g., Title number, Chapter number, Time Code, etc.), accompany commands to the player, argument values are set in the appropriate player registers. This Chapter describes each internal register of the player.

8.1 Current Time/Frame

The register contains the current time while a DVD disc is playing. A CD/VCD disc provides both a current Time Code and a Block number within the register.

8.2 P-TIME

The P-TIME Register contains the elapsed time within a Track or a Chapter.

8.3 Current Title/Track (Current Chapter)

The register contains the current Title/Track Number (Chapter Number).

8.4 Current Index

The register contains the current Index number.

8.5 Serial Digit Buffer

The register contains the command argument values. The commands are placed in a separate, exclusive register.

When the player evaluates a command, the contents of the buffer are transferred to a specified register.

8.6 Remote Control Use Address Flag

When a Search command is sent through the remote control to the player, a flag specifies if the address assigned is a Title/Track, Chapter, Time or Frame.

8.7 Remote Control Digit Buffer

The register contains the numbers input through the remote control.

8.8 Remote Control Data Register

The register contains the temporary data input through the remote control.

8.9 Laser Barcode Buffer

The register contains the compatible Laser Barcode data transmitted via the remote control.

8.10 Serial Use Address Flag

When the Serial Interface controls the player, a flag specifies if the address assigned is a Title/Track, Chapter, Time or Frame.

8.11 Search Time/Frame

The register contains a goal Frame number or Time Code.

8.12 Search Title/Track (Search Chapter)

The register contains a goal Title/Track number (Chapter number) during a Search.

This function is identical to the Search Time/Frame (refer to 8.10).

8.13 Search Index

The register contains a goal Index number during a Search.

This function is identical to the Search Time/Frame command (refer to 8.11).

8.14 Mark Time/Frame

The register contains a marker (representing the Frame number to Time Code or Block number) that indicates the end point of an Auto Play.

When the player performs an Auto Play, the contents of the Mark Time/Frame and the Current Time/Frame are compared.

8.15 Mark Title/Track (Mark Chapter)

The register contains the Title/Track (mark Chapter) as a marker.

The function is identical to the Mark Time/Frame (refer to 8.12).

8.16 Mark Index

The register contains the Index number as a marker.

The function is identical to the Mark Time/Frame command (refer to 8.14).

8.17 Video Control

The player uses the register to control the Video ON/OFF switch.

8.18 Audio Control

The player uses the register to select the audio output.

8.19 Display Control

The player uses the register to toggle the Character Display switch ON/OFF.

The Character Display tracks on-screen information such as Time/Frame number, Title/Track number, etc.

8.20 Registers

There are two registers, A and D. The registers are reserved exclusively for CPU internal operations.

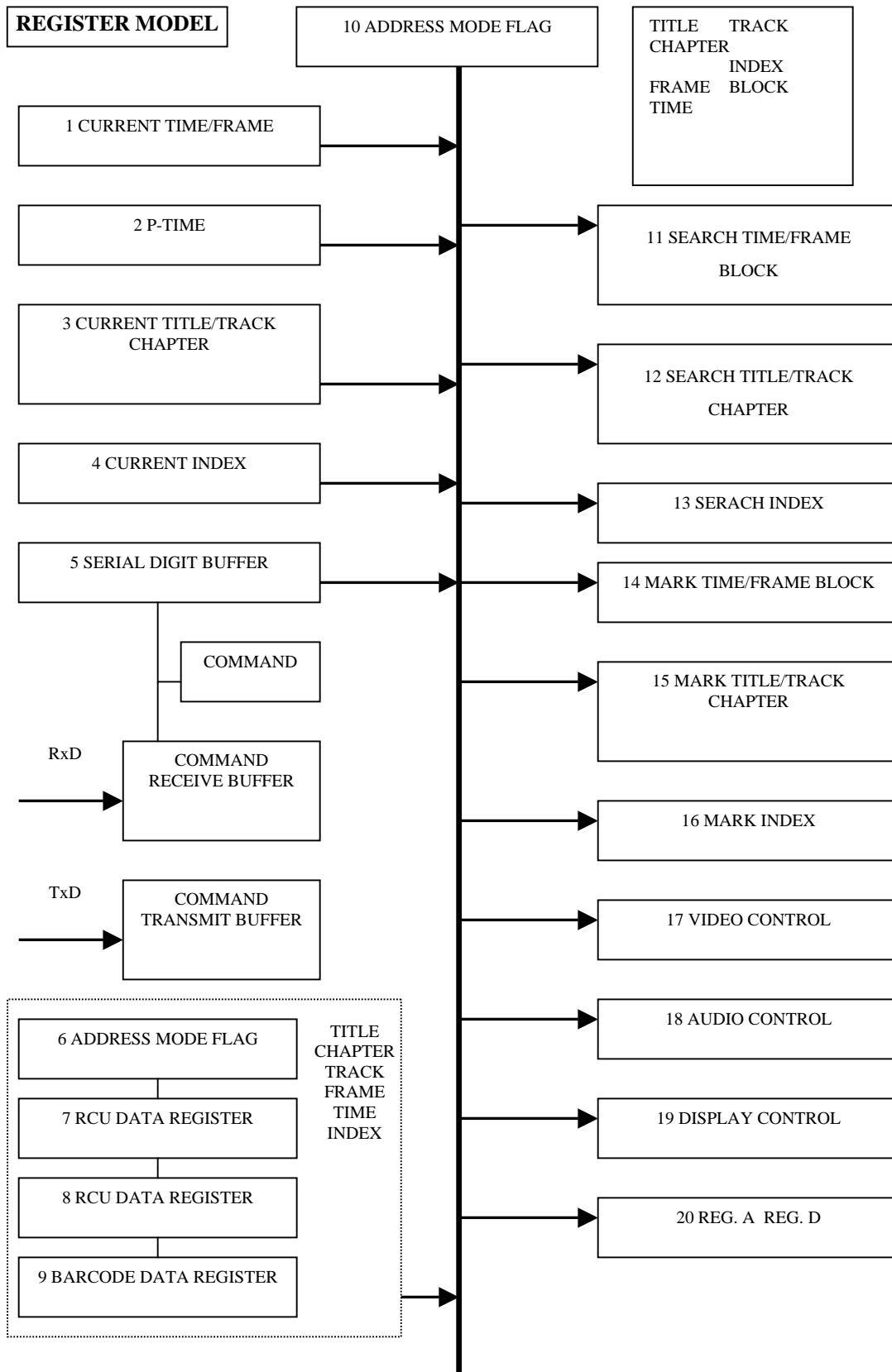

9. EXTEND TERMINAL CONTROL

To activate a function, create a switch contact with an electrical ground (Pin 1). Check Chapter 2 to verify pin (Pin 6 through Pin 13) and terminal (SW1 ~ SW8) assignments.

There are three SW functions in the EXTEND TERMINAL CONTROL.

1. To recall Barcode/Command Stacks and execute

The function, STACK GROUP 1 to STACK GROUP 27, is similar to a combination of remote control buttons to recall and execute a stack.

2. To execute the function as a remote control command

The function acts the same as the buttons (ENTER, PLAY, STOP, etc.) on a remote control excluding SCAN FWD/REV.

DVD-V5000 continues execute SCAN FWD/REV even when the button on the remote control is released. But in case of EXTEND TERMINAL CONTROL, it stops to execute SCAN FWD/REV when button is released.

(In case of remote control "releasing SCAN button" will not discontinue the SCAN.

But in case of EXTEND TERMINAL, releasing SCAN switch will terminate SCAN operation.)

3. To execute as an advanced remote control button

Advanced remote control commands such as numbers from 10 to 20 may be sent as a switch control command.

Note: for additional assistance, please refer to Product Information Bulletin (PIB) 152601 DVD-V7400 and Jama Port Control available on the Pioneer Electronics website under Service & Support – Business Solutions Products.

9.1 Function Assignment

Create a Circuit Controller or a Diode Matrix Circuit (refer to the table below).

Diode Assignment List (Standard setting and User default setting)

No.	SW1 ↑	SW2 ↓	SW3 ←	SW4 →	SW5 ENTER	SW6 X	SW7 Y	SW8 Z	Function
1	X								↑
2		X							↓
3			X						←
4				X					→
5					X				ENTER
6						X			STACK GROUP1
7							X		STACK GROUP2
8								X	STACK GROUP3
9		X						X	10
10			X					X	11
11				X				X	12
12	X	X							OPEN/CLOSE
13			X	X					DISPLAY
14	X					X			1
15		X				X			2
16			X			X			3
17				X		X			4
18	X						X		5
19		X					X		6
20	X			X					↗
21		X		X					↘
22		X	X						↙
23	X		X						↖
24					X	X			PLAY
25					X		X		STOP
26					X			X	PAUSE
27							X	X	TOP MENU
28			X				X		7
29				X			X		8
30	X							X	9
31					X	X	X		STEP FWD
32					X	X		X	STEP REV
33					X		X	X	RETURN
34	X	X	X						SCAN FWD
35	X	X		X					SCAN REV
36	X		X	X					SKIP FWD
37		X	X	X					SKIP REV
38			X			X	X		STACK GROUP4
39				X		X	X		STACK GROUP5
40	X	X					X		STACK GROUP6
41	X	X				X			13
42	X		X			X			14

43	X			X		X			15
44		X	X			X			16
45		X		X		X			17
46			X	X		X			18
47	X					X	X		19
48		X				X	X		20
49	X		X				X		STACK GROUP7
50	X			X			X		STACK GROUP8
51		X	X				X		STACK GROUP9
52		X		X			X		STACK GROUP10
53			X	X			X		STACK GROUP11
54	X						X	X	STACK GROUP12
55		X					X	X	STACK GROUP13
56			X				X	X	STACK GROUP14
57				X			X	X	STACK GROUP15
58	X	X						X	STACK GROUP16
59	X		X					X	STACK GROUP17
60	X			X				X	STACK GROUP18
61		X	X					X	STACK GROUP19
62		X		X				X	STACK GROUP20
63			X	X				X	STACK GROUP21
64	X					X		X	STACK GROUP22
65		X				X		X	STACK GROUP23
66			X			X		X	STACK GROUP24
67				X		X		X	STACK GROUP25
68						X	X		STACK GROUP26
69						X		X	STACK GROUP27
70						X	X	X	MENU
71	X				X	X			RECALL
72	X				X		X		HOME MENU
73	X				X			X	MEMORY
74		X			X	X			>10
75		X			X		X		REPEAT
76		X			X			X	REPEAT A-B
77			X		X	X			AUDIO
78			X		X		X		ANGLE
79			X		X			X	SUBTITLE
80				X	X	X			TITLE/CHP/FRM/TIME
81				X	X		X		0
82				X	X			X	CLEAR

9.2 Function User Setting

Function assignment for Numbers1 through 30 can be changed in Advanced Setup.

The procedure is given below for an example of GROUP 3 setting change to "MENU".

- Open ADV SETUP and switch EXTEND TERMINAL to User and press Enter.
- And then the following window opens.

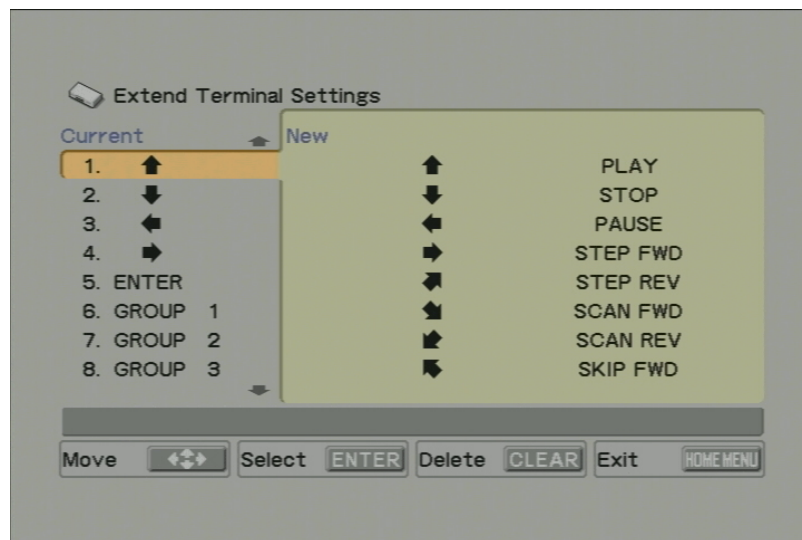

- DOWN button to select "GROUP 3"



- RIGHT Button

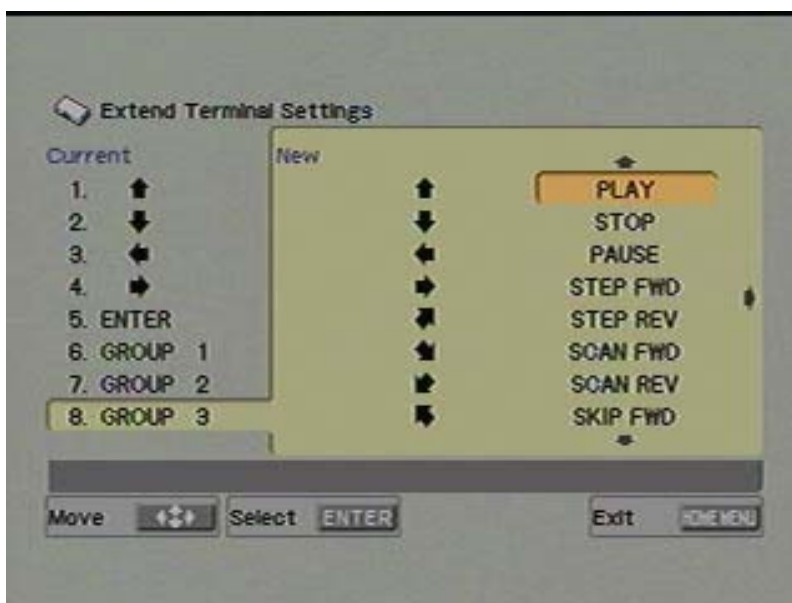

- DOWN Button to select "MENU"

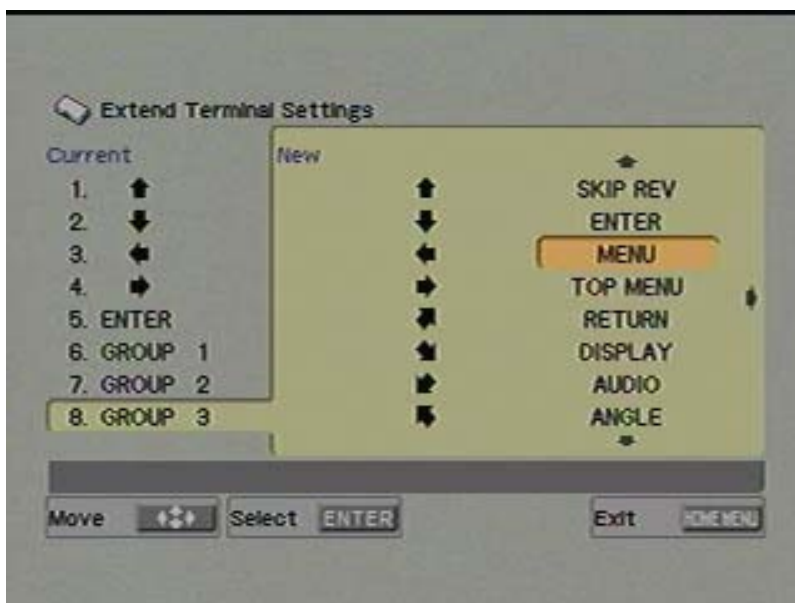

- ENTER button to change the function of switch 8 to MENU

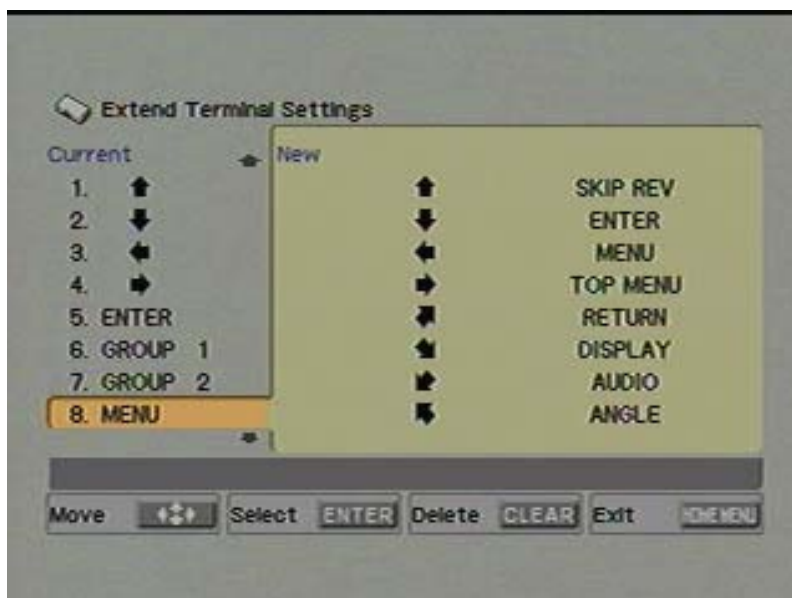

In order to DISABLE the switch function, please select the switch and Press the “CLEAR” button. The switch displays “nothing” as shown below.

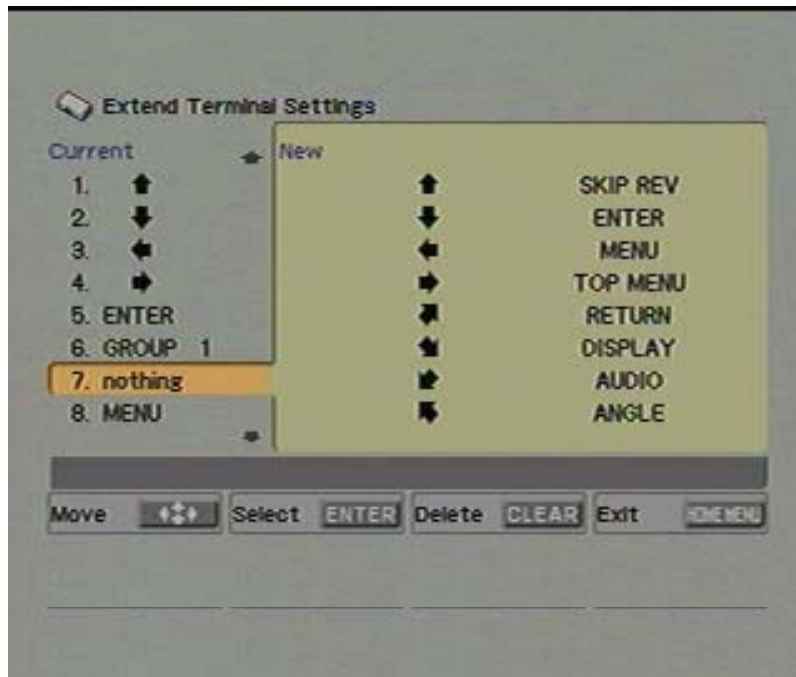

The modification of the switch setting will be reserved within memory area even with power-off.

In order to recover the initial factory setting, please select “Default Setting” and press ENTER.

For an initial setting, Standard and User are the same.

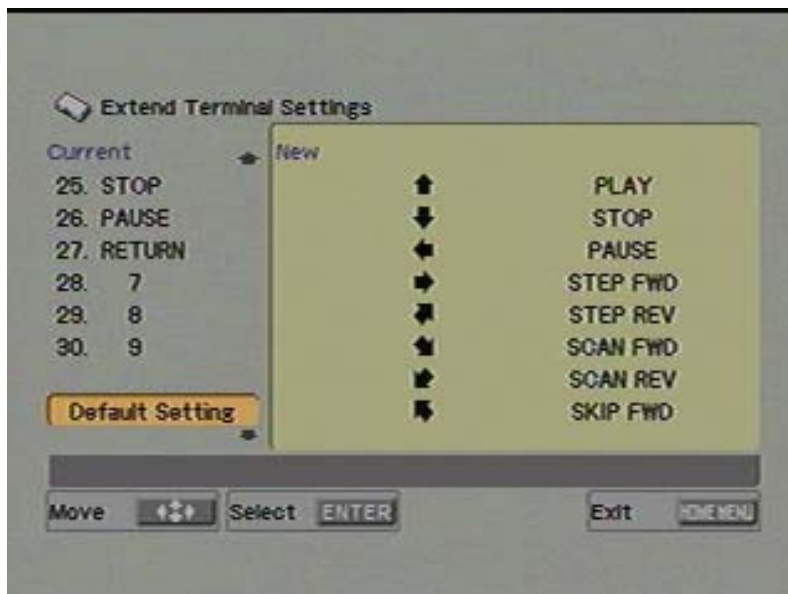

9.3 Controller

Examples of Switch and Diode specifications are charted below.

Switch Specifications

On Resistance	Less than 1 ohm
Off Resistance	More than 1 M ohm
Type	Non-Locking

Diode Specifications

Forward Voltage Drop (VF)	Less than 0.7 (IF 1ma)
Surge Forward Current (IFSM)	Less than 100ma
Forward Current	Less than 10µa

9.3.1 Simple Circuit

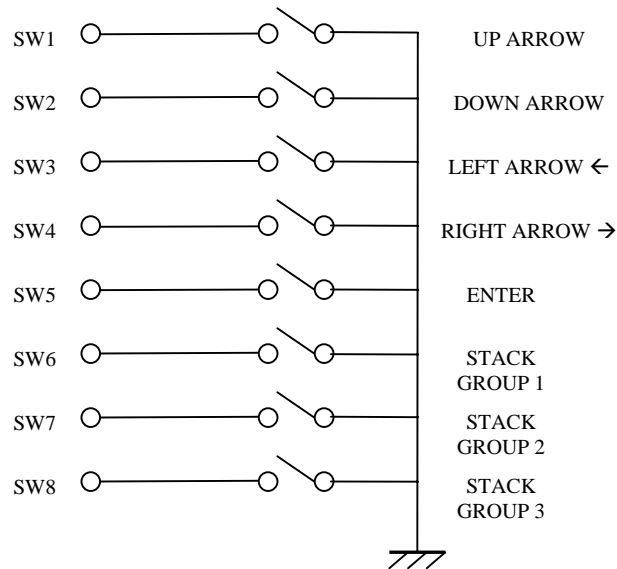

9.2.2 Diode Matrix Circuit

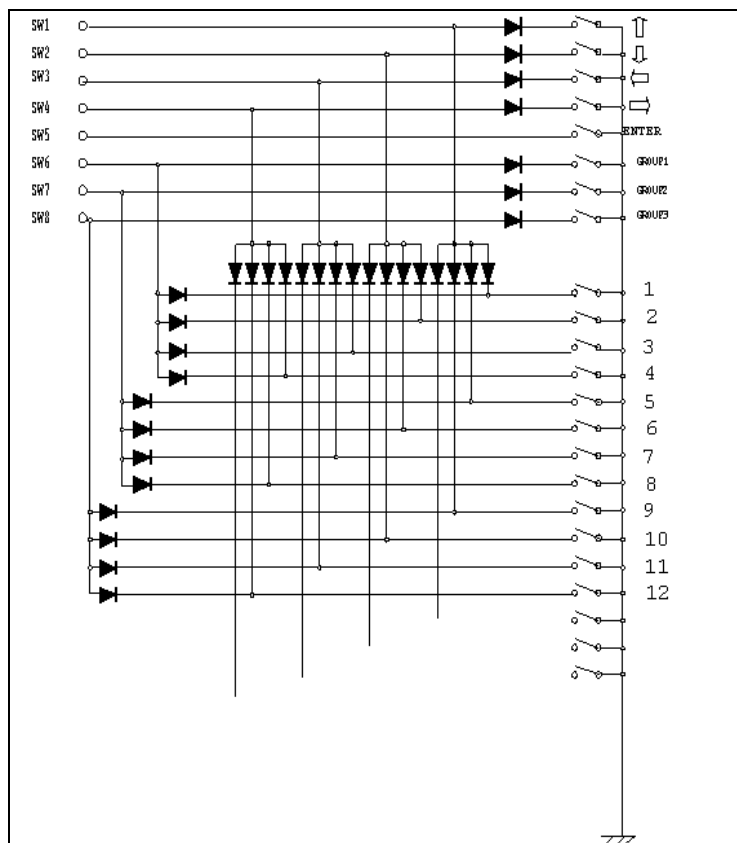

10. ADDITIONAL NOTES

1. If a video has a picture stop code, when the player reaches the stop code point, it enters the Still mode.
2. If Prohibit Pause is set for Stop Marker playback, an error is issued at any Stop Marker Point.
3. When a computer is controlling the player, send the KEY LOCK command to eliminate possible interference from the front panel buttons and/or the remote control.
4. If an invalid address is set within a command for a CD or VCD disc, the player returns an E04 error.

APPENDIX A - COMPLETE COMMAND LIST BY NAME

NOTE: arg or ards (argument or address) prefaces commands with an argument or an address parameter. If arg or ards is in (), then the parameter is optional.

COMMAND		SUPPORTING FORMATS		
Name	Mnemonic	DVD	CD	VCD
Audio Control	arg AD	x	x	x
Block Number	BK		x	
Block Number Request	?B		x	
Barcode Stack Play	arg BS	x		
CCR Mode Request	?M	x	x	x
CD Disc Status Request	?K		x	x
Chapter	CH	x		
Chapter Number Request	?C	x		
Clear	CL	x	x	x
Clear Screen	CS	x	x	x
Close	CO	x	x	x
Command Stack Data Download	BD	x	x	x
Command Stack Data Upload	BU	x	x	x
Communication Control Set	arg CM	x	x	x
Current Address Request	?A	x	x	x
Disc Region code Request	?G	x		
Display Control	arg DS	x	x	x
DVD Disc Status Request	?V	x		
Error Code Request	?E	x	x	x
Frame	FR	x		
Frame Number Request	?F	x		
Index	IX		x	
Index Number Request	?I		x	
Input Barcode Data Request	#B	x	x	x
Input Number Request	?N	x	x	x
Input Unit Request	#I	x	x	x
Key Lock	arg KL	x	x	x
Lead Out Symbol	LO	x	x	x
LVP Model Name Request	?X	x	x	x
Multi-Speed Forward	(ards) MF	x		x
Multi-Speed Reverse	(ards) MR	x		
Open	OP	x	x	x
Pause	PA	x	x	x
Play	(ards) PL	x	x	x

COMMAND		SUPPORTING FORMATS		
Name	Mnemonic	DVD	CD	VCD
Print Character	arg PR	x	x	x
Register A Request	\$A	x	x	x
Register A Set (Display)	arg RA	x	x	x
Reject	RJ	x	x	x
Scan Forward	NF	x	x	x
Scan Reverse	NR	x	x	x
Scan Stop	NS	x	x	x
Search	adrs SE	x	x	x
Select Angle	arg AG	x		
Select Aspect	arg AP	x		
Select Audio	arg AU	x		
Select Subtitle	arg SU	x		
Speed	arg SP	x		x
Stack Group Set	arg GP	x		
Start	SA	x	x	x
Step Forward	SF	x		x
Step Reverse	SR	x		
Still	ST	x		x
Stop Marker	adrs SM	x	x	x
Time	TM	x	x	x
Time Code Request	?T	x	x	x
Title	TI	x		
Title/Track Number Request	?R	x	x	x
TOC Information Request	?Q		x	x
Track	TR		x	x
Video Control	arg VD	x	x	x

APPENDIX B - COMPLETE COMMAND LIST BY MNEMONIC

NOTE: arg or ards (argument or address) prefaces commands with an argument or an address parameter. If arg or ards is in (), then the parameter is optional.

COMMAND		SUPPORTING FORMATS		
Mnemonic	Name	DVD	CD	VCD
#B	Input Barcode Data Request	x	x	x
#I	Input Unit Request	x	x	x
\$A	Register A Request	x	x	x
?A	Current Address Request	x	x	x
?B	Block Number Request		x	
?C	Chapter Number Request	x		
?E	Error Code Request	x	x	x
?F	Frame Number Request	x		
?G	Disc Region code Request	x		
?H	Player Region Code Request	x	x	x
?I	Index Number Request		x	
?K	CD Disc Status Request		x	x
?M	CCR Mode Request	x	x	x
?N	Input Number Request	x	x	x
?P	Player Active Mode Request	x	x	x
?Q	TOC Information Request		x	x
?R	Title/Track Number Request	x	x	x
?T	Time Code Request	x	x	x
?V	DVD Disc Status Request	x		
?X	LVP Model Name Request	x	x	x
?Z	Firmware Version Request	x		
arg AD	Audio Control	x	x	x
arg AG	Select Angle	x		
arg AP	Select Aspect	x		
arg AU	Select Audio	x		
BD	Command Stack Data Download	x	x	x
BK	Block Number		x	
arg BS	Barcode Stack Play	x		
BU	Command Stack Data Upload	x	x	x
CH	Chapter	x		
CL	Clear	x	x	x
arg CM	Communication Control Set	x	x	x
CO	Close	x	x	x
CS	Clear Screen	x	x	x
arg DS	Display Control	x	x	x
FR	Frame	x		
arg GP	Stack Group Set	x	x	x
IX	Index		x	
arg KL	Key Lock	x	x	x

COMMAND		SUPPORTING FORMATS		
Mnemonic	Name	DVD	CD	VCD
	LO	x	x	x
(adrs)	MF	x		x
(adrs)	MR	x		
	NF	x	x	x
	NR	x	x	x
	NS	x	x	x
	OP	x	x	x
	PA	x	x	x
(adrs)	PL	x	x	x
arg	PR	x	x	x
arg	RA	x	x	x
	RJ	x	x	x
	SA	x	x	x
adrs	SE	x	x	x
	SF	x		x
adrs	SM	x	x	x
arg	SP	x		x
	SR	x		
	ST	x		x
arg	SU	x		
	TI	x		
	TM	x	x	x
	TR		x	x
arg	VD	x	x	x

APPENDIX C - DVD COMMAND LIST

NOTE: arg or ards (argument or address) prefaces commands with an argument or an address parameter. If arg or ards is in (), then the parameter is optional.

COMMAND	
Name	Mnemonic
Audio Control	arg AD
Command Stack Data Download	BD
Command Stack Data Upload	BU
Barcode Stack Play	arg BS
CCR Mode Request	?M
Chapter	CH
Chapter Number Request	?C
Clear	CL
Clear Screen	CS
Close	CO
Communication Control Set	arg CM
Current Address Request	?A
Disc Region code Request	?G
Display Control	arg DS
DVD Disc Status Request	?V
Error Code Request	?E
Firmware Version	?Z
Frame	FR
Frame Number Request	?F
Input Barcode Data Request	#B
Input Number Request	?N
Input Unit Request	#I
Key Lock	arg KL
Lead Out Symbol	LO
LVP Model Name Request	?X
Multi-Speed Forward	(adrs) MF
Multi-Speed Reverse	(adrs) MR
Open	OP
Pause	PA
Play	(adrs) PL
Player Active Mode Request	?P
Player Region Code Request	?H
Print Character	arg PR
Register A Request	\$A
Register A Set (Display)	arg RA

COMMAND	
Mnemonic	Name
Reject	RJ
Scan Forward	NF
Scan Reverse	NR
Scan Stop	NS
Search	adrs SE
Select Angle	arg AG
Select Aspect	arg AP
Select Audio	arg AU
Select Subtitle	arg SU
Speed	arg SP
Stack Group Set	arg GP
Start	SA
Step Forward	SF
Step Reverse	SR
Still	ST
Stop Marker	adrs SM
Time	TM
Time Code Request	?T
Title	TI
Title/Track Number Request	?R
Video Control	arg VD

APPENDIX D - CD COMMAND LIST

NOTE: arg or ards (argument or address) prefaces commands with an argument or an address parameter. If arg or ards is in (), then the parameter is optional.

COMMAND	
Name	Mnemonic
Audio Control	arg AD
Block Number	BK
Block Number Request	?B
Command Stack Data Download	BD
Command Stack Data Upload	BU
CCR Mode Request	?M
CD Disc Status Request	?K
Clear	CL
Clear Screen	CS
Close	CO
Communication Control Set	arg CM
Current Address Request	?A
Display Control	arg DS
Error Code Request	?E
Index	IX
Index Number Request	?I
Input Barcode Data Request	#B
Input Number Request	?N
Input Unit Request	#I
Key Lock	arg KL
Lead Out Symbol	LO
LVP Model Name Request	?X
Open	OP
Pause	PA
Play	(adrs) PL
Player Active Mode Request	?P
Player Region Code Request	?H
Print Character	arg PR
Register A Request	\$A
Register A Set (Display)	arg RA
Reject	RJ
Scan Forward	NF
Scan Reverse	NR
Scan Stop	NS
Search	adrs SE
Stack Group Set	arg GP
Start	SA
Stop Marker	adrs SM
Time	TM

Time Code Request	?T
Title/Track Number Request	?R
TOC Information Request	?Q
Track	TR
Video Control	arg VD

APPENDIX E - VCD COMMAND LIST

NOTE: arg or ards (argument or address) prefaces commands with an argument or an address parameter. If arg or ards is in (), then the parameter is optional.

COMMAND	
Name	Mnemonic
Audio Control	arg AD
Command Stack Data Download	BD
Command Stack Data Upload	BU
CCR Mode Request	?M
CD Disc Status Request	?K
Clear	CL
Clear Screen	CS
Close	CO
Communication Control Set	arg CM
Current Address Request	?A
Display Control	arg DS
Error Code Request	?E
Input Barcode Data Request	#B
Input Number Request	?N
Input Unit Request	#I
Key Lock	arg KL
Lead Out Symbol	LO
LVP Model Name Request	?X
Multi-Speed Forward	(ards) MF
Open	OP
Pause	PA
Play	(ards) PL
Player Active Mode Request	?P
Player Region Code Request	?H
Print Character	arg PR
Register A Request	\$A
Register A Set (Display)	arg RA
Reject	RJ
Scan Forward	NF
Scan Reverse	NR
Scan Stop	NS
Search	ards SE
Speed	arg SP
Stack Group Set	arg GP
Start	SA
Step Forward	SF
Still	ST

COMMAND	
Mnemonic	Name
Stop Marker	adrs SM
Time	TM
Time Code Request	?T
Title/Track Number Request	?R
TOC Information Request	?Q
Track	TR
Video Control	arg VD

APPENDIX F - ERROR CODES

Code	Message	Description
E00	communication error	Communication Line Error due to framing error or buffer overflow.
E04	feature not available	Non-Usable Function has been tried. Either the command mnemonic is wrong or the command cannot be used in this mode.
E06	missing argument	Necessary parameter is not specified.
E11	disc does not exist	There is no disc in the tray.
E12	Search error	Search address cannot be found.
E15	picture stop	Playback has been stopped by VOBU Still while in auto play mode.
E16	interrupt by other device	The command(s) sent via the serial line were not executed before commands were sent from the front panel buttons and/or remote control.
E99	panic	Unrecoverable Error occurred. Is possible a disc cannot be loaded and/or playing cannot continue.

DVD-V5000

Industrial DVD Player RS-232 Command Protocol

Pioneer Electronic Corporation

4-1, Meguro 1-chome
Meguro-ku, Tokyo 153
JAPAN

<http://www.pioneer.co.jp>

Pioneer Electronics (USA) Inc.

Business Solutions Division
2265 East 220th Street
Long Beach, California 90810
United States of America
(310) 952-2000

<http://www.pioneerelectronics.com>

Free Manuals Download Website

<http://myh66.com>

<http://usermanuals.us>

<http://www.somanuals.com>

<http://www.4manuals.cc>

<http://www.manual-lib.com>

<http://www.404manual.com>

<http://www.luxmanual.com>

<http://aubethermostatmanual.com>

Golf course search by state

<http://golfingnear.com>

Email search by domain

<http://emailbydomain.com>

Auto manuals search

<http://auto.somanuals.com>

TV manuals search

<http://tv.somanuals.com>