



IMPORTANT FOR FUTURE REFERENCE

Please complete this information and retain this manual for the life of the equipment:

Model #: _____

Serial #: _____

Date Purchased: _____

Operations Manual

Covering

Compact Pasta Control

Pitco p/n 60143701

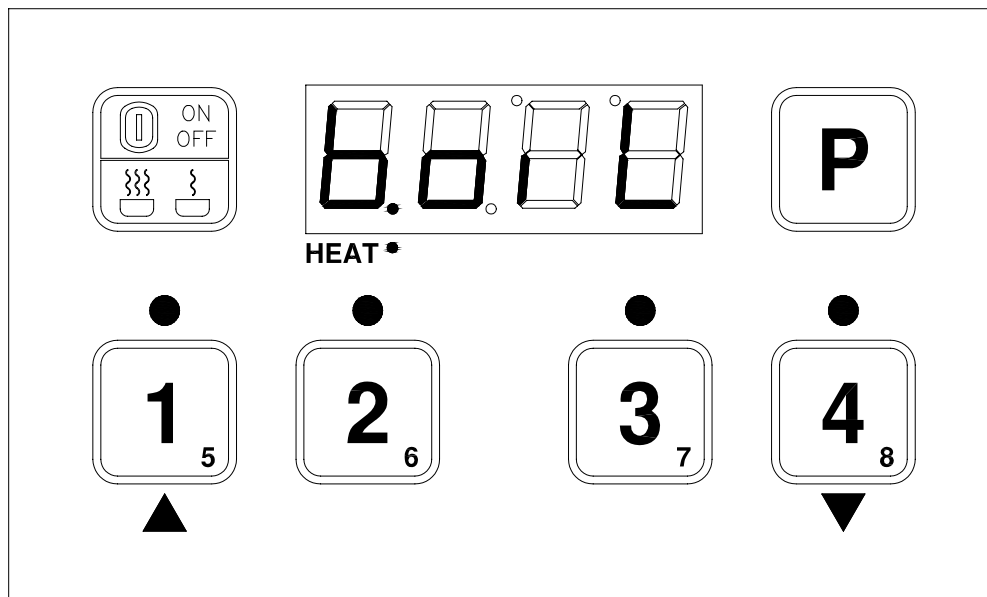
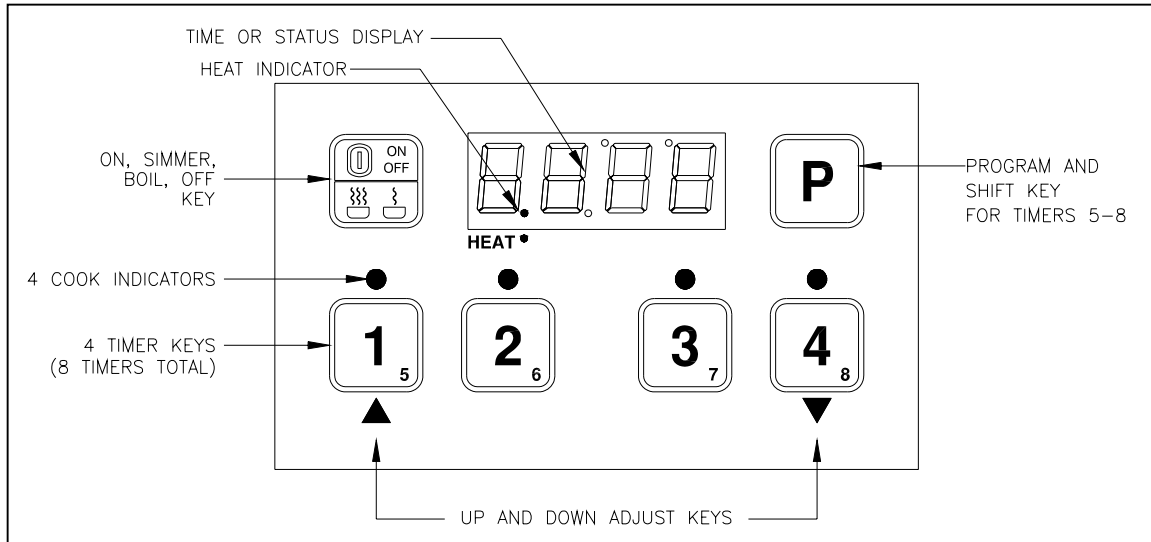

Table of Contents

Keypad and Display Functions:	3
Operation:	3
2.1 To Turn Control ON:	3
2.2 To Turn Control OFF:	3
2.3 To Start a Cook:	3
2.4 To Cancel a Cook:	3
2.5 To Change from Boil to Simmer, or, Simmer to Boil:	3
Programming:	4
3.1 To Unlock	4
3.2 To Change Simmer Temperature	4
3.3 To Change Timers 1-4:	4
3.4 To Change Timers 5-8:	4
4 Other Displays:-	5
4.1 Low Vat Temperature:	5
4.2 Drain Valve Open:	5
4.3 Equipment Fault Displays	5

1 Keypad and Display Functions:



2 Operation:

2.1 To Turn Control ON:

When power is applied to the appliance, display will show [OFF]. Press the [ON/OFF] key. Display will show one of three possible displays depending on the water temperature; [bOIL], [Sim], or [__°F].



2.2 To Turn Control OFF:

With display showing [bOIL], [Sim], or [__°F], press and hold the [ON/OFF] key. Display will show [OFF].



2.3 To Start a Cook:

Press a timer key (1-4) to start a cook timer in this group.

To activate a timer in the 5-8 group, press the [P] key first, then a timer key.

Multiple timers may run together, but only one timer for a key. The shortest time running will display in minutes and seconds format [MM:SS] with a flashing cook indicator.



2.4 To Cancel a Cook:

Press and hold the timer key until the cook indicator light above the key is off.

2.5 To Change from Boil to Simmer, or, Simmer to Boil:

With display showing [bOIL], or [Sim], momentarily press the [ON/OFF] key. Display will change to the alternate setting.

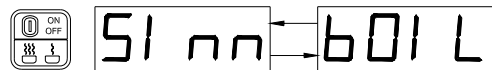

3 Programming:

To enter the programming menu, press the [P] key for 3 seconds. Display will show one of two possible displays; [Pr--] for Program entry or [Loc] for locked entry.



3.1 To Unlock

If control is displaying [Pr--] skip this step. While display is showing [Loc], press the Down arrow key once followed by the Up arrow key. Display will show [Pr--]. Control is now unlocked ready for programming.

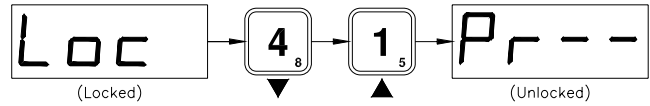

3.2 To Change Simmer Temperature

With display showing [PR--]. Press the [P] key, display will show [tEnP]. Press the down arrow key to display the current simmer temperature setting as [xxxF], or [xxxC]. To change this setting, use the Up and Down arrow keys to adjust temperature. Press the [P] key to save value. Display will show [tEnP]. Continue to the next step.

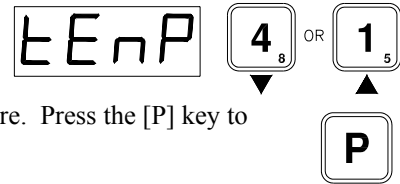

3.3 To Change Timers 1-4:

3.3.1 With display showing [tEnP], press the [P] key once. Display will show [1234] to indicate that timers 1 through 4 may be selected.

3.3.2 Press the timer key needing adjustment. The indicator above that key will illuminate, and the display will show the current timer setting for this key in minutes and seconds format [MM:ss].

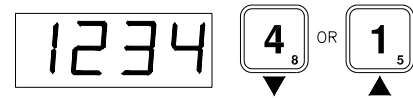

3.3.3 Use the Up and Down arrow keys to adjust timer setting, then press the [P] key to save value for this key.

3.3.4 Display returns to [1234]. Repeat from step 3.3.2 for other timer keys in this group.

3.3.5 When all keys in this group are set, press the [P] key to continue.



3.4 To Change Timers 5-8:

3.4.1 Display will show [5678] to indicate that timers 5 through 8 may be selected.

3.4.2 Press the timer key needing adjustment. The indicator above that key will illuminate, and the display will show the current timer setting for this key in minutes and seconds format [MM:ss].

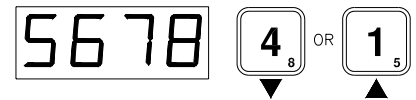

3.4.3 Use the Up and Down arrow keys to adjust timer setting, then press the [P] key to save value for this key.

3.4.4 Display returns to [5678]. Repeat from step 3.4.2 for other timer keys in this group.

3.4.5 When all keys in this group are set, press the [P] key to exit programming to normal operations.



4 Other Displays:-

4.1 **Low Vat Temperature:**

When tank temperature is below 150°F (65°C), the display will show as blanks. This is normal for cold start-ups. **Heat Demand** indicator is located between the first and second digits of display.

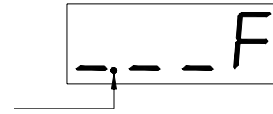

4.2 **Drain Valve Open:**

When drain valve is detected open, normal operations are suspended. The display will show Drain-Turn-Off message until reset. To reset, CLOSE the drain valve, turn the control OFF, then ON. Note: some applications do not use the drain valve input.

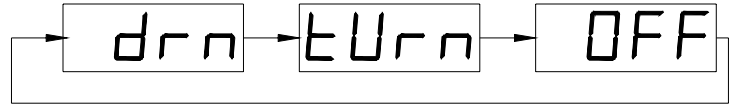

4.3 **Equipment Fault Displays**

This control will detect faulty probe conditions. If temperature probe faults are detected, display will show one of two possible conditions. All other functions are disabled. To reset, turn control OFF, then ON.



Open Probe

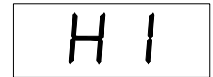

Shorted Probe or
High Temperature Limit

Free Manuals Download Website

<http://myh66.com>

<http://usermanuals.us>

<http://www.somanuals.com>

<http://www.4manuals.cc>

<http://www.manual-lib.com>

<http://www.404manual.com>

<http://www.luxmanual.com>

<http://aubethermostatmanual.com>

Golf course search by state

<http://golfingnear.com>

Email search by domain

<http://emailbydomain.com>

Auto manuals search

<http://auto.somanuals.com>

TV manuals search

<http://tv.somanuals.com>