

Digital Mailing System

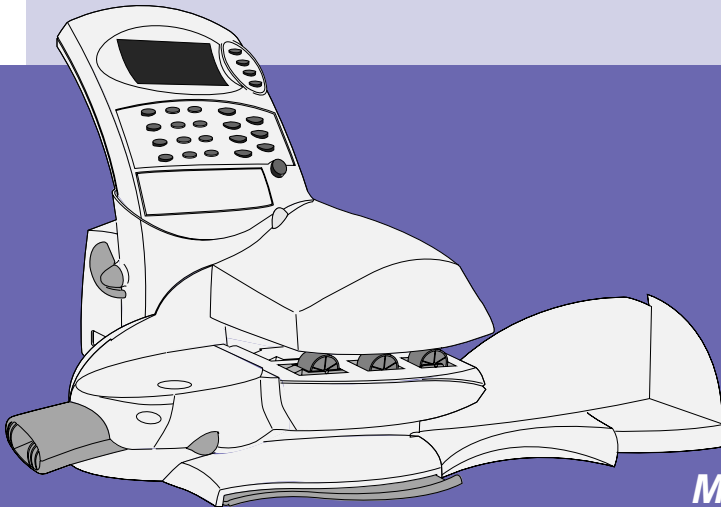

*Models
DM225 and DM300*

Contents

ABOUT THIS GUIDE

These instructions assume that your Digital Mailing System has already been installed by yourself, using the Quick Install Guide supplied.

Used after initial installation, this Guide will act as a 'refresher' and provide additional information on operating techniques.

Later, it will act as a reference when you wish to perform an operation which is only carried out occasionally (such as changing the meter setup etc.).

1. INTRODUCTION

Gives basic details of your new system, important safety information and acquaints you with the different parts of the system...

About your new system	1-1
Safety and Compliance	1-2
Machine Identification	1-4

2. OPERATION

Explains how to perform the meter functions you'll use most often...

About this Chapter	2-1
Operating Checklist	2-1
Unlocking and Locking the Meter	2-1
Error Messages	2-1
Sleep Mode	2-2
Ready Screen	2-2
Checking Funds Available	2-2
Checking/Setting the Date	2-3
Selecting an Advertising Slogan	2-3
Selecting an Account	2-4
Selecting a Value	2-4
Printing Postage	2-6
Printing Tapes	2-7
Account/Batch Totals	2-8
Postage Meter Information	2-9

Contents

3. CONFIGURING YOUR SYSTEM

Shows you how to setup the system to suit your own mailing operation...

The Options Key	3-1
Navigating the Menus	3-1
The Menu Structure	3-3
Menu Options:	
Postage Mode	3-4
Seal Only	3-4
Ink Functions	3-4
Maintenance (Purging the Print Head)	3-4
Print Test	3-5
Fill Ink Reservoir	3-5
Reports	3-6
Meter Setup Report	3-6
Refill Summary	3-6
Account Reports	3-7
Detailed Report	3-7
Summary Report	3-8
Configuration Report	3-8
Error Report	3-8
Setup Menu	3-9
Basic Settings	3-9
Display Contrast	3-9
Low Funds Warning	3-10
High Value Warning	3-10
Refill Setup	3-10
Default Refill Amount	3-11
Refill Mode	3-11
Dialling Prefix	3-12
PB Phone Number	3-12
PB Account Number	3-13
Modem Type	3-13
Print Position	3-14
Lock Code	3-14
Supervisor Password	3-15
Time of Day	3-15
British Summer Time (BST)	3-16
Meter Clock Time	3-16
Presets – normal/custom	3-16
Edit Normal Preset	3-17
Edit Custom Preset	3-18
Delete Custom Preset	3-19

Contents

Accounting Setup	3-19
Enable/Disable Account	3-20
Create Account	3-21
Delete Account	3-22
Change Account	3-22
Clear All Accounts	3-23
Enable Passwords	3-23
Enable Clear Individual Accounts	3-24
Meter Graphics	3-24
New Ad	3-25
New Town Circle	3-26
Advanced Functions	3-26
Enable Features	3-27
Scale/Printer Cfg	3-27
Replace Print Head	3-28
Tape Calibration	3-28

4. ADDING POSTAGE

Tells you about the Pitney Bowes Postage by Phone system and how to refill your meter with postage funds...

About the Postage by Phone System	4-1
Types of Refill	4-1
Connecting to a Telephone Line	4-2
Checking your Postage by Phone Account Balance	4-3
Performing an Auto-Refill	4-4
Performing a Contingency Refill	4-5
Refitting the Postage Meter	4-6

5. MAINTENANCE

Explains how to refill your system with 'consumables' and how to maintain the moistener unit...

Filling the Moistener	5-1
Maintaining the Moistener	5-1
Loading the Tape Strip Feeder	5-3
Replacing the Ink Cartridge	5-4

Contents

6. PROBLEMS?

Tells you what to do if things go wrong...

Getting Help	6-1
Power Problems	6-2
Envelope Feeding Problems	6-2
Tape Feeding Problems	6-3
Printing Problems	6-4
Display Problems	6-4
Moistening Problems	6-5
Refill Problems	6-6
Display Messages	6-7
Blink Codes	6-12

7. REFERENCE

Gives information on functions you may only need occasionally...

Specifications	7-1
Supplies and Accessories	7-2
Options	7-3
Changing Address?	7-3
Hints and Tips (to ensure optimum performance)	7-4

1. INTRODUCTION

About your new system

Your new DM225/DM300 is a full-featured, programmable postage system that lets you tailor its operation to your own unique requirements.

Your system comprises of a **Postage Meter**, which holds your postage and accounting information and a **Mailing Machine** which transports and prints your envelopes/tapes with postage.

The DM300 system uses the Model **F9MM Mailing Machine** which offers a postage tape facility and envelope moistening. The DM225 system uses the **F8MM Mailing Machine** which is slightly slower and does not offer postage tapes or moistening. Both systems use the same Model **F921 Postage Meter**.

The system's advanced features include:

- Space-saving, compact footprint
- ENERGY STAR® compliant design lowers operating costs and helps preserve the environment
- Large, easy-to-read graphic display shows the meter's status and prompts you through all setup operations
- Easily removable meter
- Automatic date advance
- Daily piece count printing
- Keyboard selectable ads (slogans)
- Easy addition of optional ad slogans
- Convenient, one-button funds refill via Postage by Phone
- Ink jet printing provides clear, crisp meter imprints
- Versatile accounting feature stores postage costs for 10 (standard) or up to 100 (optional) departmental accounts
- Password protection limits access to authorised personnel
- Standard moistener (DM300 only) offers seal and no-seal options
- Built-in tape strip feeder holds 50 self-adhesive tapes (DM300 only)
- Communications port for an optional Pitney Bowes 'N' Series electronic scale or other external device
- Report printing capability provides hard-copy records

Introduction

Safety and Compliance

Mains Connection

In most countries your system is supplied with a moulded mains lead and plug. In other countries, or if the supplied lead is not used, the following information applies:

1. An approved mains lead for the country concerned must be used.
2. As the colours of the wires in the mains lead of this equipment may not correspond with the coloured markings identifying the terminals in your plug, proceed as follows:
 - The wire which is coloured green and yellow must be connected to the terminal in the plug which is marked with the letter "E" or by the earth symbol \perp or coloured green or green and yellow.
 - The wire which is coloured blue must be connected to the terminal which is marked with the letter "N" or coloured black.
 - The wire which is coloured brown must be connected to the terminal which is marked with the letter "L" or coloured red.
3. The wires in the supplied mains lead are coloured in accordance with the following code:

Green and Yellow	-	Earth
Blue	-	Neutral
Brown	-	Live

WARNING:

THE DIGITAL MAILING SYSTEM MUST BE EARTHED

The socket outlet should be near to the equipment and should be easily accessible.

Do not route the power cord over sharp edges or trap it between pieces of furniture.

Make sure there is no strain on the power cord.

In case of an ink spill, leaking ink, or excessive ink accumulation, immediately disconnect power cord from wall plug and call your Pitney Bowes office for assistance.

Introduction

General

To comply with health and safety standards, operators must observe all local standard safety precautions relating to the operation of office equipment. In particular DO NOT remove covers from the machine.

Keep fingers, long hair, jewellery and loose clothing away from moving parts at all times.

In order to comply with Post Office regulations, DO NOT tamper in any way with Post Office seals.

Compliance

This is a Class A product. In a domestic environment this product may cause interference in which case the user may be required to take adequate measures.

In order to comply with Class A limits, the power cord must be 3 metres in length.

 Pitney Bowes certifies that the F921 Postage Meter, F8MM Mailing Machine and F9MM Mailing Machine complies with the essential requirements of the Low Voltage Directive 73/23/EEC, EMC Directive 89/336/EEC and the R&TTE Directive 1999/5/EC.

The F8XX and F9XX series Postage Meters have been designed to work on all Pan-European Analogue Telecommunication Networks.

For a formal Declaration of Conformity please contact Compliance Engineering on +44 (0)1279 426731.

Introduction

Machine Identification

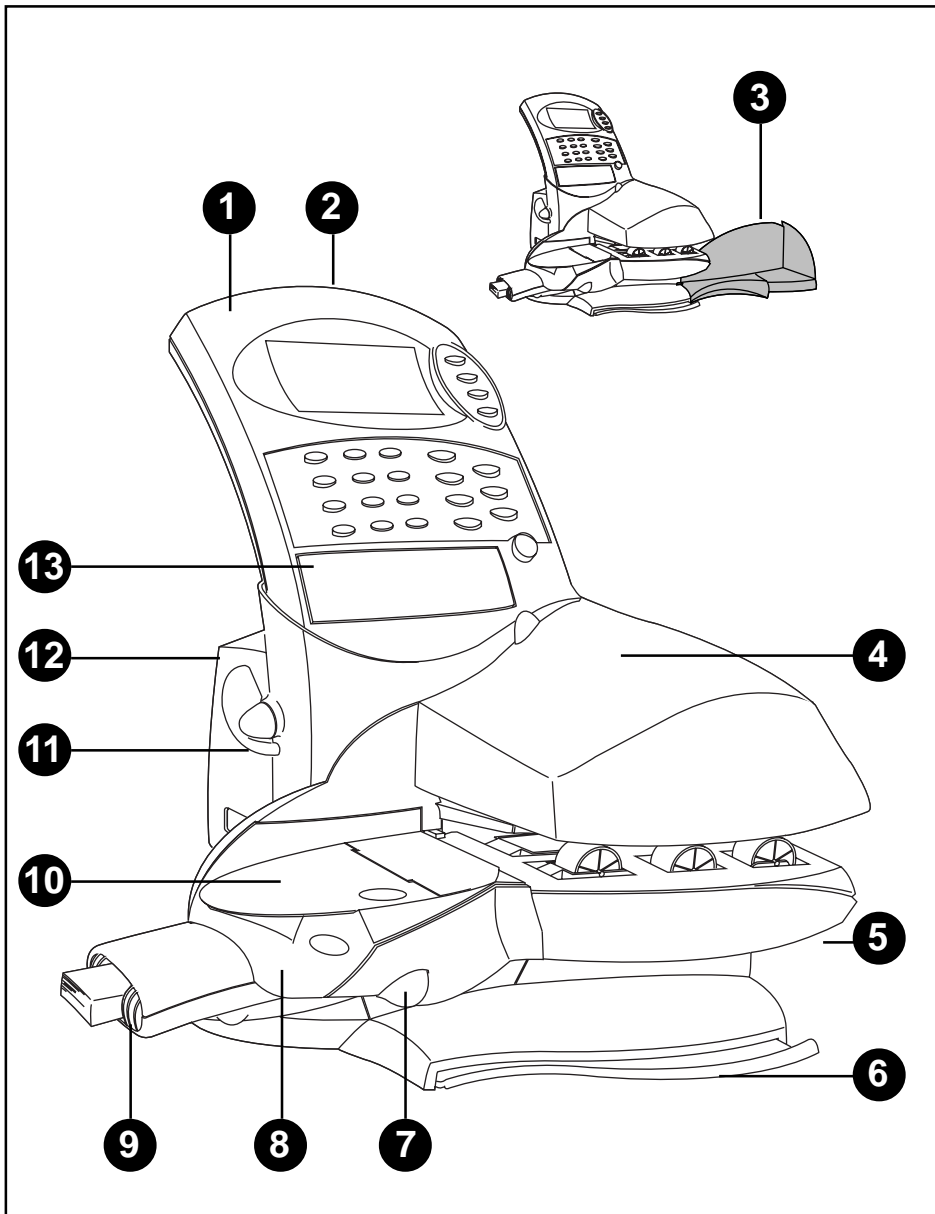

Introduction

- 1. Postage Meter** Stores and controls your postage. You can remove the Postage Meter from the Mailing Machine if you need to.
- 2. Card Slot** This slot accepts 'smartcards' which can contain new or updated Town Circle and/or Ad (slogan) information.
- 3. Stacker** Finished mailpieces are neatly stacked here.
- 4. Front Access Cover** Open to allow access to the print head. The Postage Meter has to be removed before this cover will open. The cover must be closed before the Mailing Machine will operate.
- 5. Transport Release Lever** Pull the release lever forward to lower the transport deck and clear a stalled mailpiece. The transport deck is interlocked; the Mailing Machine won't run when it's open.
- 6. Quick Reference Card** This card has brief instructions describing how to 'frank' and seal an envelope. It can act as a reminder, or can help an occasional operator use the system.
- 7. Moistener Release Button** Press to remove the moistener from the Mailing Machine (DM300 system only).
- 8. Moistener** Applies sealing fluid to the envelope flap. You can seal envelopes or leave them unsealed, depending on how you feed them (DM300 system only).
- 9. Tape Feeder** Holds 50 tape strips for use on oversize letters and packages. You can print tape strips individually or up to 25 strips with the same postage value (DM300 system only).
- 10. Feed Deck** Supports your envelope as it passes under the meter stamp printer.
- 11. Meter Release Lever** Turn the lever anticlockwise to remove the meter from the mailing machine. This automatically turns off power to the meter.
- 12. Power Indicator** Lights when the mailing machine is on. Also flashes to indicate an error condition.
- 13. Alpha Keypad Cover** Open the cover to use the alpha keypad. You'll use the alpha keypad to set up accounts and custom presets.

Introduction

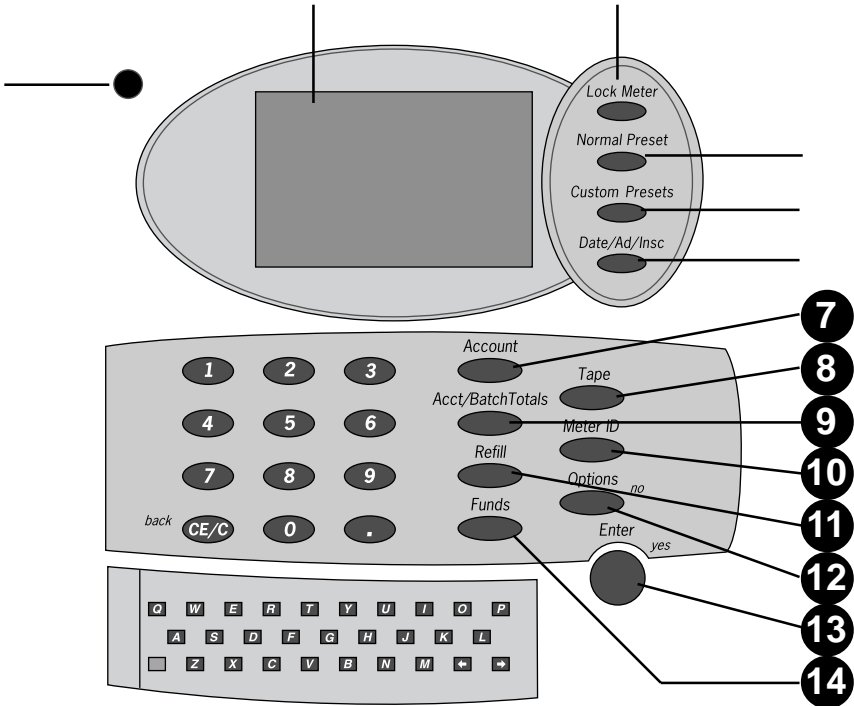

- 1. LED** Lights green when your meter is on. Turns orange when your meter is in sleep mode.
- 2. Operator Display** Shows the current status of your meter. It normally shows the settings you use most often. You can display the postage used and postage available as well as your current ad and date selections. The display also prompts you through setup operations.
- 3. Lock Meter** When enabled, this feature prevents unauthorised use of your meter by requiring a four-digit code (password) to unlock the meter. Your system is delivered with this feature turned off.

Introduction

- 4. Normal Preset** Press to return to the meter settings you use most often.
- 5. Custom Presets** Press to select from a list of up to 10 custom meter settings. Each preset can include a name, a postage value, an ad, and an account number.
- 6. Date/Ad/Insc.** Press to change the date or choose the ad you want to print.
- 7. Account** Press to see and select from a list of accounts. The meter charges the postage used to the account you select and stores the information for report printing. The meter is supplied with the accounting feature turned off. If required, it can be turned on as described on page 3-20.
- 8. Tape** Press to print a tape strip. Apply tape strips to oversize envelopes and packages (DM300 system only).
- 9. Acct/Batch Totals** Press to see the total postage used and number of pieces charged to an account. If the meter's accounting feature is turned off, the display shows the total postage used and number of mailpieces processed since the batch register was last reset.
- 10. Meter ID** Press to see your meter's serial number, Postage by Phone account number, cycle counts and software versions.
- 11. Refill** Press this button to add postage to your meter.
- 12. Options (no)** Press to check print quality, print reports or set your meter up. Also press to answer "No" to a display prompt.
- 13. Enter (yes)** Press to confirm an operation or answer "Yes" to a display prompt.
- 14. Funds** Press to see the postage funds available, funds used and number of mailpieces processed by the meter. You can also print a funds (register) report.
- 15. Alpha Keypad** Use this to type in account names and other information when you set your meter up.
- 16. Numeric Keypad** Use this to key in postage values, refill amounts and other numerical information. Press CE/C to clear an entry or move back through the setup menus to exit them.

Introduction

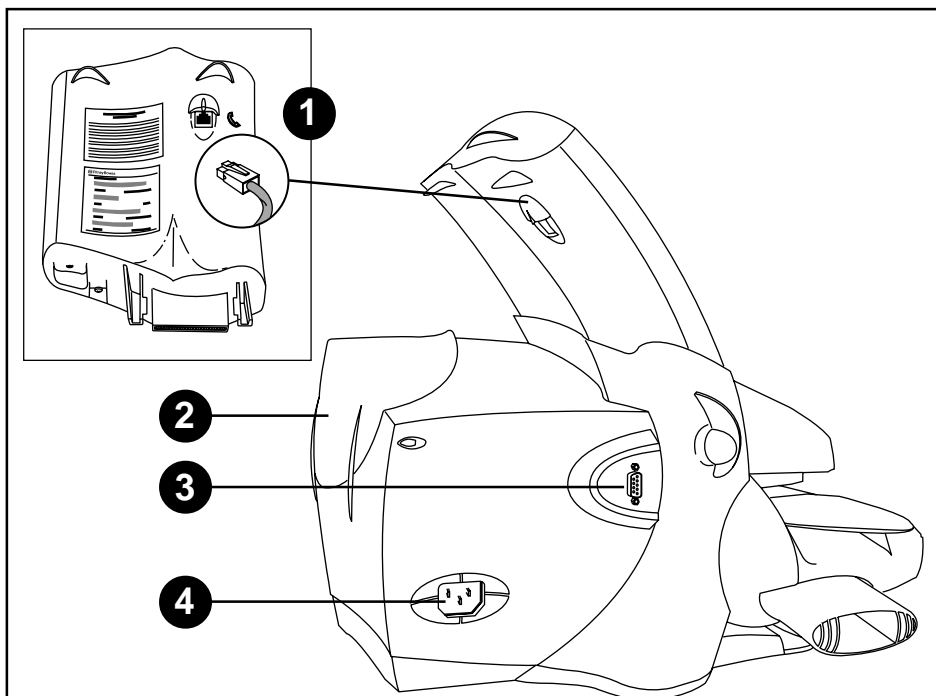

- 1. Phone Socket** Plug an analogue telephone line into this socket. This allows you to add postage automatically using the one-button refill facility (see Chapter 4).
- 2. Rear Cover** Open this cover to replace the Ink Cartridge (see Chapter 5).
- 3. Communications Port** This is used to connect your system to an external device like a Pitney Bowes 'N' Series electronic postal scale or a printer. This is a standard RS-232 serial port.
- 4. Power Inlet** Plug the power cord in here. Make sure you have read the safety information on page 1-2 before connecting power.

IMPORTANT INFORMATION

The machine should be left connected and turned ON at all times. Turning the machine ON and OFF will result in increased ink consumption and associated running costs. Leaving the machine turned OFF for an extended period of time (over 30 days) may result in damage to the print head which will not be covered by your warranty or maintenance agreement.

2. OPERATION

About this Chapter

This chapter explains how to perform the functions you'll use most often. It assumes you've installed the equipment correctly and set it up the way you want. If you haven't yet set up your system, or you'd like to change one or more setup options, follow the instructions in Chapter 3.

Operating Checklist

Before operating the system, check the following:

- Make sure the Postage Meter is correctly fitted to the Mailing Machine (see page 4-6).
- Make sure the system is plugged into a suitable mains wall socket and the socket is turned ON. Follow the safety precautions in Chapter 1.
- Check the level of sealing solution in the moistener (DM300 system only). See Chapter 5.
- If you plan on printing tape strips (DM300 system only), make sure you've loaded an adequate supply. See Chapter 5.
- Check that you have enough postage to handle your job (press **Funds** to view the postage available). If you don't, refill the meter (Chapter 4).

Unlocking and Locking the Meter

Your Postage Meter *may* require you to enter a four-digit code (password) to unlock it, depending on how it's set up. If a code is needed, key it in and press **Enter**. When you've finished using the meter, press the **Lock Meter** button to prevent unauthorised use.

If your meter is set up with accounting passwords, it prompts you for a password each time you select an account.

Error Messages

Your meter may occasionally display a message telling you that something needs attention or that an error condition occurred. These messages usually tell you how to fix whatever's wrong. See Chapter 6 for a complete listing of error messages.

Operation

Sleep Mode

Your DM225/DM300 is ENERGY STAR® Compliant. It automatically enters a low power ("sleep") mode after 10 minutes of inactivity. This saves energy costs and helps preserve the environment. When the system enters the sleep mode, the display goes blank and the LED switches from green to orange. Press any key to wake the system. The system will revert to the normal preset settings and will 'lock' itself if the Meter Lock function is in use.

Ready Screen

Your meter is ready to use when you see a display similar to this, with the 'Ready to Print' prompt displayed.

This is the Ready Screen. The screen you actually see may look slightly different, depending on how your meter is set up.



Checking Funds Available

Press the **Funds** key to check the postage funds available, the postage funds used and the total number of mailpieces printed.

To print a record of this information, including batch totals, place a spare envelope on the feed deck. Guide it towards the back of the meter and then to the right. Press **Enter (yes)** to print the following report:

-Total Meter Funds-	
Unused	£99.19
Used	£300000.81
Pieces	5
Control Sum	£300100.00
Exit . . .CE/C key	
Report . . .Insert envelope	

Register Report	Used:	£300000.81	PB370000
	Unused:	£99.19	14.09.00
	Total Pieces:	5	1:30
	Control Sum:	£300100.00	Batch Value: £0.81
		Batch Pieces: 4	

When printing finishes, the meter will return to the Ready Screen.

Checking/Setting the Date

The Ready Screen will show the date that is set to print on your mail (today's date). If you wish, you can advance the date:

Advancing the Date

1. Press the **Date/Ad/Insc** key.
2. Press **1** (Date).
3. Press **1** (Advance Date).
4. Press the **Date/Ad/Insc** key to advance the date one day at a time or key in the number of days you want to advance the date by.

NOTE: You can't advance the mail submission date by more than 30 days. The meter will display an error message if you try. Press **CE/C** to clear the message.

5. Press **Enter**. The meter displays the advance date and returns to the date selection menu.
6. Press **CE/C** to return to the Ready Screen.

Returning to Today's Date

The quickest way to return to today's date is to simply press the **Normal Preset** key. Your meter will return to the settings you use most often and the date will return to today's date. Alternatively, you can...

1. Press the **Date/Ad/Insc** key.
2. Press **1** (Date).
3. Press **1** (Advance Date).
4. Press the **CE/C** key. The date advance returns to zero.
5. Press **Enter**. The meter displays the current date and returns to the date selection menu.
6. Press **CE/C** to return to the Ready Screen.

Selecting an Advertising Slogan

If you have purchased ads for your meter (see page 7-2 for details), the Ready Screen shows the current ad. "None" means no ad is selected.

To change the ad:

1. Press the **Date/Ad/Insc** key.
2. Press **2** (Ad).
3. Press the number of the ad you want.
4. Press **Enter**. The meter confirms your choice and displays the ad name on the Ready Screen.

Operation

Selecting an Account

If you're using the meter's accounting feature, you will have to select an account before you can print postage. The meter prompts "No Account Selected" as shown in the example:

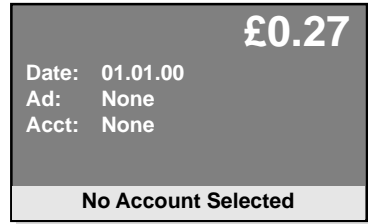

If you know the number of the Account you want...

Simply key in the Account number, then press the **Account** key.

or, if you don't know the number of the Account you want...

1. Press the **Account** key to see a list of accounts. If your meter has more than six accounts available, press the **Account** key repeatedly to see more.
2. Key in the account number you want.
3. Press **Enter**.

In either case, if no account password is needed, the display briefly shows the account you selected and returns to the Ready Screen.

The display prompts you if an account password is needed. If it is, key in the four-digit password and press **Enter**. The display shows the account you selected and returns to the Ready Screen.

Selecting a Value

You can set the postage value in one of four ways:

- Key in the postage value you want.
- Select the Normal Preset.
- Select a Custom Preset.
- Using a Pitney Bowes 'N' Series Postal Scale

Each method is explained below.

Keying In the Postage Value

At the Ready Screen, key in the postage value you want, followed by **Enter**.

When selecting values in pounds and pence, you don't need to use the decimal point.

For example, for 27p enter:

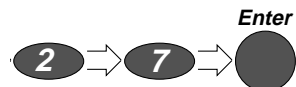

and for £2.70 enter:

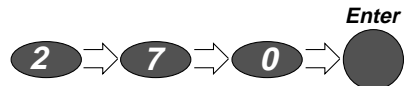

A short-cut to enter whole pound values is to enter the value in pounds followed by the decimal point.

For example, £11.00 can be entered:

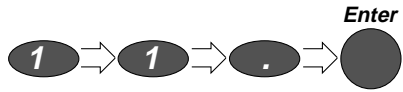

NOTE: If 'High Value' displays, you have entered a large postage value. The meter checks if you want to continue. Press **yes** to accept the value.

To change the postage value you keyed in, press Clear (**CE/C**) and re-enter the value you want.

Selecting the Normal Preset

1. At the Ready Screen, press the **Normal Preset** key.
2. The display shows the preset values. These are normally the meter settings you use most often. What you see depends on how the meter was set up. The normal preset includes a postage value and may include an ad.

If you'd like to change the normal preset values, see the instructions in Chapter 3.

Selecting a Custom Preset

If you know the number of the Preset you want...

Simply key in the Preset number, then press the **Custom Presets** key.

or, if you don't know the number of the Preset you want...

1. At the Ready Screen, press the **Custom Presets** key. The display lists all presets. "Empty" means no values are assigned to the preset.
2. Press the **Custom Preset** key repeatedly until you see the preset you want or simply key in the Preset's number.
3. Press **Enter** to select the preset.

In either case, if the preset includes a password protected account, the display prompts you to enter the four-digit account password. Key it in, then press **Enter**. The meter confirms your choice and returns to the Ready Screen, with the Preset loaded.

If you'd like to set up custom preset values or change them, see Chapter 3.

Using a Pitney Bowes 'N' Series Postal Scale

If your system is linked to a Pitney Bowes 'N' Series electronic postal scale, you can set the value automatically from the scale. This is described in the Operating Guide supplied with your scale.

Operation

Printing Postage

To print an envelope without sealing...

1. Hold the envelope by its bottom edge.
2. Place the envelope ADDRESS SIDE UP on the feed deck.
3. Push the envelope to the rear (**A**) so its top edge is up against the Mailing Machine's back wall.
4. Slide the envelope to the right (**B**) until the machine draws it in. The envelope will be printed and ejected into the stacker.

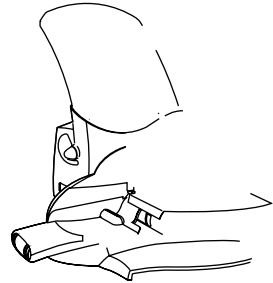

IMPORTANT NOTE:

Always ensure that your prints are clear and complete. Poor prints may be rejected by Royal Mail. If you notice missing lines in the print as shown in the illustration, perform printer maintenance as described on page 3-4 of this guide.

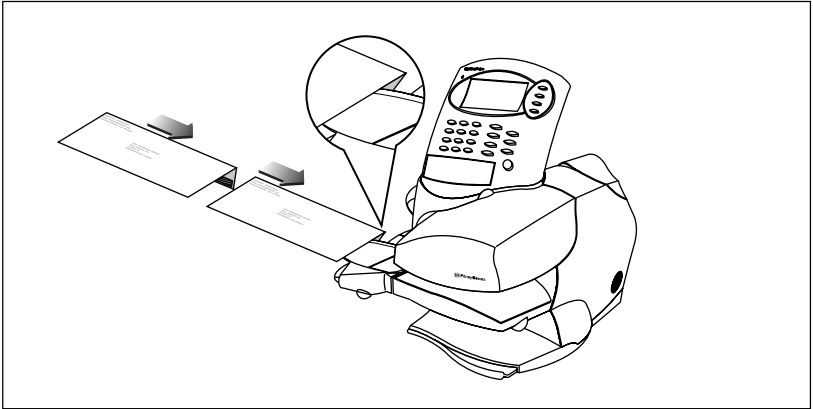

5. To complete sealing, compress the envelope stack after moistening to ensure proper glue adhesion.
See Chapter 5 for instructions on refilling and maintaining the moistener.

Printing Tapes

Use tapes to apply postage to larger envelopes or parcels. On the DM225, individual tape sheets can be printed in the same way as envelopes. On the DM300, you can print tape strips one at a time or in batches of up to 25:

Printing one tape on the DM300...

1. Enter the postage value you want.
2. Press the **Tape** key.
3. Press **Enter**. The system feeds and prints a single tape strip with the postage value you selected.

Printing more than one tape on the DM300...

1. Enter the postage value you want. The system will imprint every tape in the batch with the same value.
2. Press the **Tape** key.
3. Key in the number of tapes you want. You can key in any number, up to a maximum of 25.
4. Press **Enter**. The system automatically feeds and prints the number of tapes you entered with the postage value you selected. The display says "Printing..." and shows the number of tapes remaining to print.

See Chapter 5 for detailed instructions on loading the tape feeder.

Operation

Account/Batch Totals

Viewing the Totals

1. Press the **Acct/Batch Totals** key.
2. If you don't use your meter's accounting feature, the display shows the total postage used and the total number of pieces processed.

If you use the accounting feature, the display shows the batch value and number of pieces printed for the *currently selected account*.

Batch

Value: £00.81
Pieces: 4

Exit . . .CE/C Key
Report . . .Insert Envelope
or Press TAPE key

Printing a Batch Register Report

1. With the Account/Batch Totals displayed, place an envelope on the feed deck and guide it to the rear and right; or, on the DM300 press **Tape**.
2. The display prompts: "Print Account Report? (yes/no)."
3. Press **yes** (Enter) to print. The display says "Printing...Please Wait" as the system prints the report.

A report example with accounting turned off:

Register Report	Used:	£300000.81	PB370000 14.09.00 1:30
	Unused:	£99.19	
	Total Pieces:	5	Batch Value: £0.81
	Control Sum:	£300100.00	Batch Pieces: 4

A report example with an account selected:

Account Report	Account No:	1	PB370000 14.09.00 1:30
	Account Name:	A Name	
	Pieces:	3	
	Postage:	£0.81	

When printing finishes, the meter will return to the Ready Screen.

Clearing the Account/Batch

To clear the accumulated postage value and piece count information from the batch register or currently selected account:

1. Press the **Acct/Batch Totals** key, and while holding it down, press Clear (**CE/C**).
2. The account or batch value and piece registers return to zero.



CAUTION: Make sure you really want to clear the account or batch register; once you do, you can't restore the information.

HINT: To clear an individual account in this way, the 'Enable Clear Individual Accounts' feature must be enabled as described on page 3-24.

Postage Meter Information

You may need to supply certain information about your postage meter when you call for help or add postage.

1. Press the **Meter ID** key. The display shows information on two screens. Screen 1 shows the meter's model number, meter serial number, your Postage by Phone account number, and the total number of mailpieces processed by the meter and the mailing machine base.
2. Press the **Meter ID** key again to see the second screen. Screen 2 shows software revision levels for various meter components. This information is for use by the Pitney Bowes National Service Centre and our field service representatives.
3. Press the **back** (CE/C) key to return to the Ready Screen.

Model: F921

Meter Serial #: 06370000
PBP Account#: 12345678
Meter Count: 10
Base Count: 20

More . . . METER ID key

Version Numbers

UIC: 5.04
PHC: 3.01
Vault: 2B
PMC: 05172000 AAA F9MM
Flash: G

Indicia Serial#: PB370000

Operation

3. CONFIGURING YOUR SYSTEM

The Options Key

The **Options** key is the gateway to all your meter's setup options. When you press **Options**, you'll have access to the menu selections shown on the next page. Using these options, you can easily customize your meter to satisfy the unique requirements of your business.

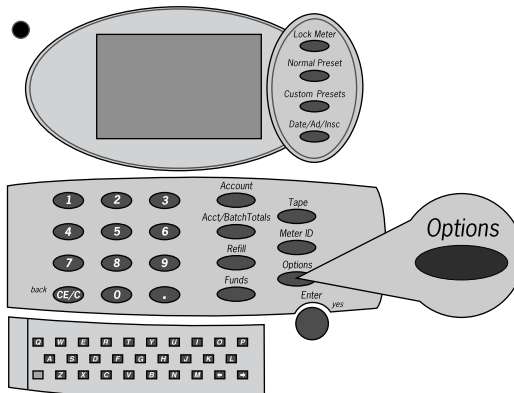

Navigating the Menus

- To get to a menu item; key in its number.
- Press **CE/C** to back-out of a menu or clear an entry.
- Press **Enter (yes)** to answer yes to a menu prompt; press **Options (no)** to answer no.
- Use the meter's alpha keyboard to type in account and preset names.
- All menus are self prompting – they'll tell you what to do. This chapter provides more detailed instructions in case you need them.
- Throughout this chapter you'll see information presented in the form "Select: Options > Ink Functions > Maintenance". This is simply the sequence needed to reach the menu item. In this example, select **Options**, then choose **Ink Functions**, then choose **Maintenance**.
- Some menu items will be displayed with dashes instead of a number beside them. These items are unavailable on your particular model of Postage Meter and cannot be selected.

Configuration

Options



Postage Mode

(page 3-4)

Seal Only

(page 3-4)

Ink Functions

(page 3-4)

Reports

(page 3-6)

Setup Menu

(page 3-9)

Meter Setup Report (page 3-6)

Refill Summary (page 3-6)

Account Reports (page 3-7)

Configuration Report (page 3-8)

Error Report (page 3-8)

Maintenance (page 3-4)

Print Test (page 3-5)

Fill Ink Reservoir (page 3-5)

Detailed Report (page 3-7)

Summary Report (page 3-8)

Basic Settings

(page 3-9)

Time of Day

(page 3-15)

Presets—normal/custom

(page 3-16)

Accounting Setup

(page 3-19)

Meter Graphics

(page 3-24)

Advanced Functions

(page 3-26)

A

British Summer Time (page 3-16)

Meter Clock Time (page 3-16)

Edit Normal Preset (page 3-17)

Edit Custom Preset (page 3-18)

Delete Custom Preset

(page 3-19)

Enable/Disable Account

(page 3-20)

Create Account (page 3-21)

Delete Account (page 3-22)

Change Account (page 3-22)

Clear All Accounts (page 3-23)

Enable Passwords (page 3-23)

Enable Clear Indv Acct

(page 3-24)

New Ad (page 3-25)

New Town Circle (page 3-26)

Enable Features (page 3-27)

Scale/Printer Cfg (page 3-27)

Replace Print Head (page 3-28)

Tape Calibration (page 3-28)

A

Display Contrast (page 3-9)

Low Funds Warning (page 3-10)

High Value Warning (page 3-10)

Refill Setup (page 3-10)

Print Position (page 3-14)

Lock Code (page 3-14)

Supervisor Password (page 3-15)

Default Refill Amount (page 3-11)

Refill Mode (page 3-11)

Dialling Prefix (page 3-12)

PB Phone Number (page 3-12)

PB Account Number (page 3-13)

Modem Type (page 3-13)

The Menu Structure

This diagram shows the menu structure available when you press the **Options** key.

You will see that the menus follow a logical structure with similar functions being grouped together.

Use this diagram as a quick reference to find the function(s) you want, then jump straight to the relevant page in this chapter.

Configuration

Postage Mode

- What is it?** Selects the meter's standard operating mode. Choose this mode to perform all routine postage printing functions.
- Where is it?** In the Options Menu. Select Options > Postage Mode.
- Action...** The display prompts: "Mode set: Postage Mode" and returns to the Postage Mode Ready Screen.

Seal Only

- What is it?** Only available on the DM300. Select this option when you want to seal envelopes but you don't want to print postage on them. This feature turns off postage printing and lets you use the mailing machine as an envelope sealer.
- Where is it?** In the Options Menu. Select Options > Seal Only.
- Action...** The display prompts: "Mode set: Seal Only Mode" and then displays the Seal Only Mode Ready Screen.

Ink Functions

- What is it?** Select this to bring up a sub-menu of functions which allow you to clean the print head or test print quality.
- Where is it?** In the Options Menu. Select Options > Ink Functions.
- Action...** Allows you to select one of the following options:
- Maintenance
 - Print Test
 - Fill Ink Reservoir

Maintenance (Purging the Print Head)

- What is it?** If you notice missing lines in the meter stamp, perform printer maintenance. Printing an incomplete stamp may waste postage.
- Where is it?** In the Ink Functions Menu.
Select: Options > Ink Functions > Maintenance.
- Action...** Press **yes** (Enter) to perform maintenance; press **no** (Options) to go back to the Ink Functions Menu. If you

pressed Yes, the display prompts "Performing maintenance, Please wait..." this usually takes several minutes.

When the purge is done, insert an envelope on the feed deck or press the **Tape** key (DM300 only) to run a print test. Then examine the print quality as described in 'Print Test' below.

Print Test

What is it?

This function prints a test pattern for you to check for blocked nozzles on the ink jet printing head.

Where is it?

In the Ink Functions Menu.

Action...

Select: Options > Ink Functions > Print Test.

Press **yes** (Enter) to do a test or **no** (Options) to cancel.

If you pressed **yes**, place a spare envelope on the feed deck or press the **Tape** key (DM300 only). The meter prints a test print on the envelope or tape strip.

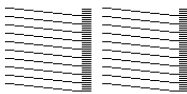

*Good test print
– acceptable*

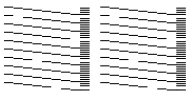

*Incomplete test print
– unacceptable*

Carefully examine the test print. It should be sharp and clear with no gaps in the test pattern.

Press **yes** (Enter) if print quality is OK. The display returns to the Ready Screen.

Press **no** (Options) if print quality is poor. This automatically brings up the printer maintenance menu as described on the previous page.

Perform the maintenance routine and print another test print. Check the test print. If the test print still shows gaps, perform the maintenance routine again and print another test print.

You can purge the print head up to a maximum of *three* times. If print quality remains poor, call Pitney Bowes.

Fill Ink Reservoir

What is it?

Select this option to install a new ink cartridge when the system displays 'Low Ink' or 'Ink Cartridge Empty'.

Where is it?

In the Ink Functions Menu.

Action...

Select: Options > Ink Functions > Fill Ink Reservoir.

Follow the on-screen prompts and/or refer to page 5-4 of this guide for detailed instructions.

Configuration

Reports

What is it?	Select this menu when you'd like to print a record of certain information.
Where is it?	In the Options Menu. Select: Options > Reports.
Action...	You'll see the following menu choices available: <ul style="list-style-type: none">Meter Setup ReportRefill SummaryAccount ReportsConfiguration ReportError Report

Key in the number of the report you want to print.
Your meter prints short reports on an envelope or tape strip. You'll need an external printer to generate a Meter Setup or Detailed Accounting Report.

Meter Setup Report

What is it?	A printed report of how your meter is setup. The report shows register information, warning and timeout values, clock settings, available ad slogans, custom preset and accounting settings and a list of enabled features.
Where is it?	In the Reports Menu. Select: Options > Reports > Meter Setup Report.
Special Note:	Your meter must be connected to an external printer to generate this report.

Refill Summary

What is it?	A printed statement of previous refills of your meter.
Where is it?	In the Reports Menu. Select: Options > Reports > Refill Summary.

Configuration

Action...

Place an envelope on the feed deck and guide it to the rear and right; or, on the DM300 press **Tape**. The meter prints the report.

If the information can't fit on one envelope/tape, the meter will ask for a second envelope or tape to be printed.

Refill Statement	Date of Refill	Time	Refill Amount	Account No.: 12345678
	29.12.99	16:57	200.00	Meter No.: 6370000
	15.12.99	15:09	200.00	Printed: 14.09.00
	26.11.99	14.35	200.00	Page 1 of n

Account Reports

What is it?

Select this to bring up a sub-menu of accounting reports available.

Where is it?

In the Reports Menu.

Select: Options > Reports > Account Reports.

Action...

Allows you to select one of the following options:

Detailed Report
Summary

Detailed Report

What is it?

A detailed report of your accounting information.

Where is it?

In the Account Reports Menu.

Select: Options > Reports > Account Reports > Detailed Report.

Special Note:

Your meter must be connected to an external printer to generate this report.

If you don't have a printer, print a Summary Report as described on the following page.

Configuration

Summary Report

- What is it?** A summary report of your accounting information.
- Where is it?** In the Account Reports Menu.
- Action...** Select: Options > Reports > Account Reports > Summary.
Place an envelope on the feed deck and guide it to the rear and right; or, on the DM300 press **Tape**. The meter prints the report. If the information can't fit on one page, the meter will ask for a second envelope or tape.

Accounts Summary	Acct	Pieces	Postage	PB370000
	1	12345678	£123456789	14.09.00
	2	12345678	£123456789	1:30
	3	12345678	£123456789	
	4	12345678	£123456789	Page 1 of n

Configuration Report

- What is it?** A report showing key information about your equipment. Prints your meter serial/account numbers and software levels.
- Where is it?** In the Reports Menu.
- Action...** Select Options > Reports > Configuration Report.
Place an envelope on the feed deck and guide it to the rear and right; or, on the DM300 press **Tape**. The meter prints the report. If the information can't fit on one page, the meter will ask for a second envelope or tape.

Error Report

- What is it?** A report showing information useful to our service representatives in the unlikely event that you should encounter problems with your meter.
- Where is it?** In the Reports Menu.
- Action...** Select Options > Reports > Error Report.
Place an envelope on the feed deck and guide it to the rear and right; or, on the DM300 press **Tape**. The meter prints the report. If the information can't fit on one page, the meter will ask for a second envelope or tape.

Configuration

Setup Menu

- What is it?** Select this to bring up a sub-menu of setup options available.
- Where is it?** In the Options Menu.
- Action...** Select: Options > Setup Menu.
Allows you to select one of the following options:
- Basic Settings
 - Time of Day
 - Presets – normal/custom
 - Accounting Setup
 - Meter Graphics
 - Advanced Functions

Basic Settings

- What is it?** Select this to bring up a sub-menu of various system settings available.
- Where is it?** In the Setup Menu.
- Action...** Select: Options > Setup Menu > Basic Settings.
Allows you to select one of the following options:
- Display Contrast
 - Low Funds Warning
 - High Value Warning
 - Refill Setup
 - Print Position
 - Lock Code
 - Supervisor Password

Display Contrast

- What is it?** Allows you to change display contrast to compensate for different lighting conditions.
- Where is it?** In the Basic Settings Menu.
Select: Options > Setup Menu > Basic Settings > Display Contrast
- Action...** Select the contrast level you want: 1 is the lowest; 5 is the highest. The display changes contrast as you press each number. Press **Enter** to confirm your setting. The meter display returns to the Basic Settings Menu.

Configuration

Low Funds Warning

- What is it?** The meter tells you when the postage remaining reaches a certain level. This amount is set at the factory to £10.00. If you wish, you can change the value using this function.
- Where is it?** In the Basic Settings Menu.
Select: Options > Setup Menu > Basic Settings > Low Funds Warning
- Action...** Key in the value you want, then press **Enter**. The display shows the value you entered and returns to the Basic Settings Menu.

High Value Warning

- What is it?** The display warns you when you enter a postage value that's more than a preset amount. This prevents you from accidentally printing a postage value that's more than you need. The high value warning is factory set at £1.00. If you wish, you can change the value using this function.
- Where is it?** In the Basic Settings Menu.
Select: Options > Setup Menu > Basic Settings > High Value Warning
- Action...** Key in the value you want, then press **Enter**. The display shows the value you entered and returns to the Basic Settings Menu.

Refill Setup

- What is it?** Select this to bring up a sub-menu of settings that instruct the meter how to add postage.
- Where is it?** In the Basic Settings Menu.
Select: Options > Setup Menu > Basic Settings > Refill Setup
- Action...** Allows you to select one of the following options:
Default Refill Amount
Refill Mode
Dialling Prefix
PB Phone Number
PB Account Number
Modem Type

Default Refill Amount

- What is it?** When you press the **Refill** key, the meter display automatically shows a suggested refill amount. This value is factory set at £200.00. You can change it to your own usual refill amount (the “default” value) using this function.
- Where is it?** In the Refill Setup Menu.
Select: Options > Setup Menu > Basic Settings > Refill Setup > Default Refill Amount
- Action...** Key in the postage refill amount you usually add to the meter. This is the normal or “default” value. You can enter a value up to £9,950. Make sure the value you enter is a multiple of £50, as this is a requirement of the Postage by Phone system.
Press **Enter**. The display shows the value you entered and returns to the Refill Setup Menu.

Refill Mode

- What is it?** Allows you to set your meter to refill automatically by modem or in exceptional circumstances, manually via the keypad.
- Where is it?** In the Refill Setup Menu.
Select: Options > Setup Menu > Basic Settings > Refill Setup > Refill Mode
- Action...** Under normal circumstances, with your meter connected to an analogue phone line, select **Auto-Refill**.
In exceptional circumstances, such as if there is a problem with the auto-refill process, select **Contingency Refill**.
-
- NOTE:** It is essential that you normally use the auto-refill mode. Only use the contingency refill if there is a problem with the auto-refill process.
-
- Press **Enter**. The display shows your selection and goes back to the Refill Setup Menu.

Configuration

Dialling Prefix

- What is it?** Some phone systems require you to dial a prefix number (like 9) to get an outside line. Some systems also require a pause between the prefix and the phone number you're dialling. This function allows you to set these parameters.
- Where is it?** In the Refill Setup Menu.
Select: Options > Setup Menu > Basic Settings > Refill Setup > Dialling Prefix
- Action...** Key in the prefix number you want. (To enter a # sign, press the Funds key; to enter an *, press the Refill key).
To have the meter pause after dialling the prefix, press the decimal point (.) key.
Press **Enter**. The display shows the prefix you entered, including the pause if you entered one, and goes back to the Refill Setup Menu.

PB Phone Number

- What is it?** This function sets the number your meter calls to add postage. For Postage by Phone in the U.K. it is factory set to dial **08705 143492**.
-
- IMPORTANT!** DO NOT change this number unless you receive instructions from Pitney Bowes to do so.
-
- Where is it?** In the Refill Setup Menu.
Select: Options > Setup Menu > Basic Settings > Refill Setup > PB Phone Number
- Action...** Key in the phone number, including the area code. Make sure it's correct.
Press **Enter**. The display shows the phone number you entered and returns to the Refill Setup Menu.

PB Account Number

- What is it?** This function sets your Postage by Phone account number which is necessary to be able to refill your meter with postage funds.
Your Postage by Phone account number is the **8 digit number** supplied in your Information Pack. DO NOT confuse this account number with your general Pitney Bowes account for purchase of machines, etc.
- Where is it?** In the Refill Setup Menu.
Select: Options > Setup Menu > Basic Settings > Refill Setup > PB Account Number
- Action...** Type in your 8 digit Postage by Phone account number. Double-check the number to make sure it's correct.
Press **Enter**. The meter display shows the account number you entered and returns to the Refill Setup Menu.

Modem Type

- What is it?** The modem is the device your meter uses to communicate over the phone lines with the Pitney Bowes Postage by Phone system.
You can set the meter to use either its built-in modem or an external modem. In the majority of cases the internal modem will be used. However, there may be cases, such as if you are using ISDN, where an external modem may be required.
- Where is it?** In the Refill Setup Menu.
Select: Options > Setup Menu > Basic Settings > Refill Setup > Modem Type
- Action...** Select **Internal Modem** or **External Modem**. Choose External Modem only if the internal modem is unavailable or unsuitable.
Press **Enter**. The meter display confirms your choice and returns to the Refill Setup Menu.

Configuration

Print Position

- What is it?** Allows you to adjust the position of the meter impression with respect to the right edge of the envelope. You might do this to compensate for thick envelopes that present a stepped edge to the print head.
- Where is it?** In the Basic Settings Menu.
- Action...** Select Options > Setup > Basic Settings > Print Position
Press **1** to shift the print position slightly to the left. Press again to shift it more to the left.
Press **2** to shift the print position slightly to the right.
Press **Enter** when you're done. The display shows the print position you selected and returns to the Basic Settings Menu.

HINT: Test your setting by printing a zero (0.00) meter stamp on a sample mailpiece. Check print quality and make sure the imprint is where you want it.

Lock Code

- What is it?** This option allows you to set or change the meter's Lock Code. The Lock Code prevents unauthorised use of your meter by requiring a four-digit code (password) to unlock the meter.
- Where is it?** In the Basic Settings Menu.
Select: Options > Setup Menu > Basic Settings > Lock Code
- Action...** If a lock code already exists, the meter asks you to key it in. Type in your current four-digit lock code and press **Enter**.
Type in the new four-digit lock code. If you don't want to use the lock feature, type 0000.
Press **Enter**.
Type the new code again to confirm it and press **Enter**. The display shows the status of the lock feature —“Lock Code Set” or “Lock Feature Disabled” — and returns to the Basic Settings Menu.

Supervisor Password

- What is it?** This option allows you to set or change the supervisor password. The password prevents unauthorised access to the meter's accounting setup functions.
- Where is it?** In the Basic Settings Menu.
Select: Options > Setup Menu > Basic Settings > Supervisor Password
- Action...** Type in your current supervisor password and press **Enter**.
Type in the new supervisor password. If you don't want to use the supervisor password feature, type 0000.

NOTE: The meter won't let you disable the supervisor password if account passwords are in use.

Press **Enter**.

Type in the new code again to confirm it. Press **Enter**. The display shows the status of the lock feature — “Supervisor Password Set” or “Supervisor Password Disabled”—and returns to the Basic Settings Menu.

Time of Day

- What is it?** Select this to bring up a sub-menu of settings which relate to the meter's internal clock.
- Where is it?** In the Setup Menu.
Select: Options > Setup Menu > Time of Day
- Action...** Allows you to select one of the following options:
British Summer Time
Meter Clock Time

Configuration

British Summer Time (BST)

What is it?	This function lets you advance the meter's clock by one hour during British Summer Time.
Where is it?	In the Time of Day Menu. Select: Options > Setup Menu > Time of Day > British Summer Time
Action...	The display shows the current time and tells you if 'summer time' is On or Off. It also asks if you want to change the setting. Press no (Options) if you don't want to change the setting. Press yes (Enter) if you do. The display shows the setting you chose and returns to the Time of Day Menu.

Meter Clock Time

What is it?	This function lets you adjust the meter's clock if it is showing the incorrect time.
Where is it?	In the Time of Day Menu. Select: Options > Setup Menu > Time of Day > Meter Clock Time
Action...	Key in the correct time in 24 hour format. Press Enter . The display shows the time set and returns to the Time of Day Menu.

NOTE: The clock adjustment is limited. If you go beyond this limit, the meter displays an error message.

Presets – Normal/Custom

What is it?	Your meter stores settings for one normal and 10 custom presets. Select this option to bring up a sub-menu of functions which relate to presets. You can assign the settings below to each preset: <ul style="list-style-type: none">• A name up to eight alphanumeric characters long (does not apply to the normal preset).• A postage value
--------------------	---

Configuration

- An ad (if you have ads in your meter).
- A department account number to custom presets only (if your meter's accounting feature is enabled).

IMPORTANT!

1. You can't specify a preset postage value that's equal to or greater than the maximum settable limit.
 2. Preset postage values are subject to the high value warning.
 3. If the ad slogan specified by a preset is not available at the time of recall, the meter displays an error message.
-

Where is it?

In the Setup Menu.

Action...

Select: Options > Setup Menu > Presets—normal/custom

Allows you to select one of the following options:

- Edit Normal Preset
- Edit Custom Preset
- Delete Custom Preset

Edit Normal Preset

What is it?

The **Normal Preset** key on the control panel lets you select the meter settings you use most often at the push of a button. Use this option to assign meter settings (postage value and ad) to this key.

Where is it?

In the Presets—normal/custom Menu.

Select Options > Setup Menu > Presets—normal/custom > Edit Normal Preset

Action...

The display prompts you to for the postage value you want.

Key in the postage value you want to assign to the normal preset and press **Enter**. The display shows the value you entered and, if your meter has ads, prompts you to select an ad from the list.

Key in the number of the ad you want, and press **Enter**. If your meter has more ads than the display can show at one time, press the **Date/Ad/Insc** key to see them. If you don't want to assign an ad, key in **0** (None) and press **Enter**.

The display shows the choices you made. Press **Enter** to accept them or **back** (CE/C) to go back if they are wrong. If everything was OK and you pressed **Enter**, the meter will return to the Presets—normal/custom Menu.

Configuration

Edit Custom Preset

What is it?

The **Custom Presets** key on the control panel lets you select from a list of presets of the meter settings you use most often. Use this option to assign meter settings (postage value, ad and account) to a custom preset.

Where is it?

In the Presets–normal/custom Menu.

Select Options > Setup Menu > Presets–normal/custom > Edit Custom Preset

Action...

The display shows a list of presets numbered from 0 (Normal Preset) to 10.

To select a preset to edit, press the number next to its name and press **Enter**. “Empty” presets are not currently in use.

The display asks you to enter a name for the preset. Type in a name up to eight characters long using the meter’s alpha and numeric keyboards. When you’re done, press **Enter**. The display shows the preset name and prompts you to enter a postage value you want.

Key in the postage value you want to assign to the custom preset and press **Enter**. The display shows the value you entered and, if your meter has ads, prompts you to select an ad from the list.

Key in the number of the ad you want and press **Enter**. If your meter has more ads than the display can show at one time, press the **Date/Ad/Insc** key to see them. If you don’t want to assign an ad, key in **0** (None) and press **Enter**.

If accounting is enabled, the display now prompts you to select an account.

NOTE: If you want to use a different ad than the one you selected, press the **back** (CE/C) key to choose another.

Key in the number of the account you want and press **Enter**. If you don’t want to assign an account, key in **0** and press **Enter**.

The display shows all the choices you made. Press **Enter** to accept them or **back** (CE/C) to go back if they are wrong.

At this point the display shows a list of all presets. You can:

- Select another preset to edit.
- Press **back** to return to the Setup Options Menu.
- Press **back** again to return to the Ready Screen.



Delete Custom Preset

What is it? Deleting a custom preset removes all the values assigned to it. These include the preset name, postage value, ad and account. Once deleted, the preset name is "EMPTY."

CAUTION! Once you delete a preset, its values are gone forever. Make sure you really want to delete it.

Where is it? In the Presets–normal/custom Menu.
Select Options > Setup Menu > Presets–normal/custom > Delete Custom Preset

Action... The display lists all the presets. Key in the number next to the preset you want to delete and press **Enter**.
The display asks if you want to delete the selected preset. Press **yes** (Enter) if you do; press **no** (Options) if you don't.
If you pressed **yes**, the display tells you the preset is deleted and returns to the Presets–normal/custom Menu. You can edit or delete more presets or press **back** (CE/C) to return to the Setup Menu. Press **back** again to return to the Ready Screen.
If you pressed **no**, the display returns to the preset list. Either select the preset you want to delete or press **back** (CE/C) to return to the Setup Menu. Press **back** again to return to the Ready Screen.

Accounting Setup

What is it? Select this to bring up a sub-menu of options which enable you to administer the accounting functions in your meter. You can set your meter up to track postage costs incurred by individuals or departments in your organisation (e.g., engineering, marketing, human resources). Your meter stores the following information for each account:

- A name up to 15 alphanumeric characters long
- An account ID number
- The item total. This is the total number of mailpieces charged to an account since it was last cleared.
- The value total. This is the total amount of postage charged to an account since it was last cleared.
- An account password

Configuration

	Your meter stores information for 10 accounts as standard. This can be increased to 50 or 100 accounts as an optional feature.
Where is it?	In the Setup Menu. Select Options > Setup Menu > Accounting Setup
	NOTE: The display may prompt you to enter a supervisor password, depending on how your meter is set up. This limits accounting access to authorised personnel.
Action...	Allows you to select one of the following options: Enable/Disable Account Create Account Delete Account Change Account Clear All Accounts Enable Passwords Enable Clear Individual Account

Enable/Disable Account

What is it?	This function allows you to turn all the accounting functions within your meter on or off.
Where is it?	In the Accounting Setup Menu. Select Options > Setup Menu > Accounting Setup > Enable/Disable Account
Action...	If a Supervisor Password has been set, you must enter this before you can gain access to the Accounting Setup Menu. Key in the four-digit password followed by Enter . When you select Enable/Disable Account the display shows you whether accounting is enabled (on) or disabled (off). Press 1 to enable accounting; 2 to disable accounting. Press Enter . The display shows your choice and returns to the Accounting Setup Menu.

Create Account

What is it?

This function enables you to create a new account.

Where is it?

In the Accounting Setup Menu.

Select Options > Setup Menu > Accounting Setup > Create Account

Action...

If a Supervisor Password has been set, you must enter this before you can gain access to the Accounting Setup Menu. Key in the four-digit password followed by **Enter**.

When you select Create Account, you will be asked to type a name for the new the account. It can be up to 15 alphanumeric characters long. Use the alpha keypad to type letters.

Press **Enter**. The display prompts you to enter a password for the account.

HINT: If account passwords are not enabled, the display won't prompt you for a password.

Type in a password, up to four alphanumeric characters long, and press **Enter**. If you don't want to protect the account with a password, just press **Enter**.

NOTE: If your mailing system includes a Pitney Bowes 'N series' Scale, use only numeric account passwords.

The display shows the account name and password (if you entered one).

If you want to change the information you just entered, press **no** (CE/C) and re-enter the account name and password.

If OK, press **yes** (Enter) to confirm the information you just typed.

The display asks if you want to create another account. This is a good idea if you're creating accounts for the first time.

Press **yes** (Enter) to create another account. Then follow the steps above.

Press **no** (Options) to return to the Accounting Setup Menu.



Configuration

Delete an Account

- What is it?** This function enables you to delete (erase) an existing account. **Use this function with caution – if you delete an account, the account and all its contents are lost.**
- Where is it?** In the Accounting Setup Menu.
Select Options > Setup Menu > Accounting Setup > Delete Account
- Action...** If a Supervisor Password has been set, you must enter this before you can gain access to the Accounting Setup Menu. Key in the four-digit password followed by **Enter**.
The display shows a list of accounts. If there are more accounts than the display can show, press the **Account** key to see them. Select the account you want to delete.
Press **Enter**. The display shows the account you want to delete and asks you to confirm the deletion. Remember, once you delete the account, all the information associated with it is gone forever.
Press **CE/C** if you don't want to delete. The display returns to the Accounting Setup menu.
Press **Enter** to delete the account. The display shows the name of the account you deleted and returns to the Accounting Setup menu.

Change Account

- What is it?** This function allows you to modify the setup of an existing account.
- Where is it?** In the Accounting Setup Menu.
Select Options > Setup Menu > Accounting Setup > Change Account
- Action...** If a Supervisor Password has been set, you must enter this before you can gain access to the Accounting Setup Menu. Key in the four-digit password followed by **Enter**.
The display shows a list of accounts from which to choose. If there are more accounts than the display can show, press the **Account** key to see them.
Select the account you want to change and press **Enter**. Follow the steps in Creating an Account on page 3-21.

Clear All Accounts

- What is it?** Use this function when you wish to clear the contents of all your accounts but leave the accounts themselves intact.
- Where is it?** In the Accounting Setup Menu.
Select Options > Setup Menu > Accounting Setup > Clear All Accounts
- Action...** If a Supervisor Password has been set, you must enter this before you can gain access to the Accounting Setup Menu. Key in the four-digit password followed by **Enter**.
The display asks if you want to reset the value of all accounts to zero.

CAUTION: Make sure you really want to clear all account data. Once you do, the account information is gone forever.

Press **yes** (Enter) to clear all accounts; press **no** (Options) to leave the account data untouched.

Enable Passwords

- What is it?** Use this menu option to turn the account password feature on (enabled) or off (disabled). If the feature is on, you can protect each account from unauthorised access by assigning it a unique four-digit code (password).

NOTE: Disabling the account passwords does not disable the supervisor password. See page 3-13 for instructions on enabling and disabling the supervisor password.

- Where is it?** In the Accounting Setup Menu.
Select Options > Setup Menu > Accounting Setup > Enable Passwords
- Action...** The display tells you if passwords are enabled or disabled. Select **1** to turn account passwords on; select **2** to turn them off. Press **Enter**.
If you turned account passwords on and there is no current supervisor password, the display prompts you to enter one. Key in a four-digit, numeric password and press **Enter**. Confirm it by keying it in again followed by **Enter**.
The display shows your selection and returns to the Accounting Setup menu.

Configuration

Enable Clear Individual Accounts

- What is it?** When this feature is on you can clear all the information stored for a particular individual account.
- Where is it?** In the Accounting Setup Menu.
Select Options > Setup Menu > Accounting Setup > Enable Clear Indv Acct
- Action...** If a Supervisor Password has been set, you must enter this before you can gain access to the Accounting Setup Menu. Key in the four-digit password followed by **Enter**.
The display tells you if the clear individual account function is enabled (on) or disabled (off).
Select **1** to turn the feature on; select **2** to turn it off.
Press **Enter**. The display confirms your selection and returns to the Accounting Setup menu.

Meter Graphics

- What is it?** Select this to bring up a sub-menu of functions which relate to installation of Ads and Town Circles.
- Where is it?** In the Setup Menu.
Select Options > Setup Menu > Meter Graphics
- Action...** Allows you to select one of the following options:
New Ad
New Town Circle

New Ad

What is it?

Pitney Bowes offers a wide variety of standard and customised meter ads that can help turn your mailpiece into a powerful promotional tool.

Your meter holds up to 10 ads in total. There are 5 internal 'standard' ads and a maximum of 5 'custom' ads which can be made to your own requirements.

The two kinds of ads are loaded in different ways. This section explains how to load your own 'custom' ads using an Ad Smartcard.

'Standard' ads can be purchased and 'enabled' by entering a code supplied by Pitney Bowes. To enable an ad via a code, see "Enable Features" on page 3-27.

Where is it?

In the Meter Graphics Menu.

Action...

Select Options > Setup Menu > Meter Graphics > New Ad

If your meter already has 10 ads loaded, the display prompts you to delete an ad:

Key in the number next to the ad you want to delete. The display shows the ad you selected.

Either press **Enter** to confirm your choice or press **CE/C** if you don't want to delete this ad. The display returns to the Meter Graphics menu.

Loading an ad from a Smartcard

When 'New Ad' is selected, the display prompts: "Insert card in slot."

Place the card into the slot in the top edge of the meter. Hold the card with the gold, oval shaped microprocessor facing you and near the bottom. Push the card down as far as it will go.

The cursor tells you that loading is in progress.

The meter will prompt you when installation is complete.

Remove the card and store it safely in case you need to reuse it in the future.



Configuration

New Town Circle

What is it?

Use this function to load new Town Circle information into your meter. There may be an occasion, such as if you change address, when Pitney Bowes will supply you with an update Town Circle Smartcard.

Where is it?

In the Meter Graphics Menu.

Select Options > Setup Menu > Meter Graphics > New Town Circle

Action...

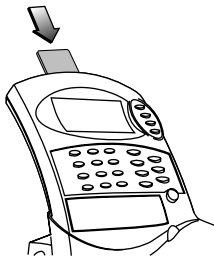

The display prompts: "Insert card in slot."

Place the card into the slot in the top edge of the meter.

Hold the card with the gold, oval shaped microprocessor facing you and near the bottom. Push the card down as far as it will go.

The cursor tells you that loading is in progress.

The meter will prompt you when installation is complete.

Remove the card and take a test print at zero value.

If the new town circle print is OK, return the Smartcard to Pitney Bowes.

Advanced Functions

What is it?

Select this to bring up a sub-menu of 'special' functions.

Where is it?

In the Setup Menu.

Select Options > Setup Menu > Advanced Functions

Action...

Allows you to select one of the following options:

Enable Features

Scale/Printer Cfg

Replace Print Head

Tape Calibration

Configuration

Enable Features

- What is it?** This function allows you to add optional meter features, such as expanded account capacity or standard ads. You activate the option by entering a special feature code that Pitney Bowes provides when you buy the option.
- Where is it?** In the Advanced Functions Menu.
Select Options > Setup Menu > Advanced Functions > Enable Features
- Action...** The display prompts "Enter code:"
Key in the feature code Pitney Bowes gave you. Press **Enter**.
The display prompts "Feature Enabled" and returns to the Advanced Functions Menu.

Scale/Printer Cfg

- What is it?** This function allows you to tell your system whether an external printer is attached or not.
- Where is it?** In the Advanced Functions Menu.
Select Options > Setup Menu > Advanced Functions > Scale/Printer Cfg
- Action...** Select **1** if you don't have a printer.
Select **2** if you have a printer directly connected.
Select **3** if you have a printer and scale connected via the optional A/B Switch Box.
Press **Enter** to confirm your selection.

NOTES:

If you have a printer, always make sure it is turned on and is 'on-line/ready' before you attempt to print an external report.

If you use the A/B Switch Box always make sure the box is switched to 'Printer' before you attempt to print an external report.

Configuration

Replace Print Head

- What is it?** This function allows a Pitney Bowes Service Engineer to install a replacement print head into your machine.
- Where is it?** In the Advanced Functions Menu.
Select Options > Setup Menu > Advanced Functions > Replace Print Head
- Action...** **This is not an Operator function.** If you inadvertently select this option, press **CE/C** to exit.

Tape Calibration

- What is it?** This menu option is available on the DM300 only. It allows the machine to be set for the tape strip length being used. In the U.K. this option should be left in its factory supplied condition or the condition set by a Pitney Bowes service engineer.
- Where is it?** In the Advanced Functions Menu.
Select Options > Setup > Advanced Functions > Tape Calibration
- Action...** **This is not an Operator function.** If you inadvertently select this option, press **CE/C** to exit.

4. ADDING POSTAGE

About the Postage by Phone System

The Pitney Bowes Postage by Phone System allows you to obtain postage funds for your Pitney Bowes Postage Meter without leaving your office – all you need is a telephone line.

How does the system operate?

The system consists of a central computer situated in our Data Centre at Harlow which holds details of the funds available in your Postage by Phone account. Your meter communicates with the Data Centre over the telephone line and transfers funds from your Postage by Phone account into your meter.

Postage by Phone is a prepaid system, you should have sufficient money in your postage account before attempting to refill your meter. After the transaction, an invoice/statement will be sent to your company automatically.

When can I refill my meter?

In the U.K. auto-refill using the meter's modem is available from 7.00am to 8.00pm Monday to Saturday, including Bank Holidays.

What if I have difficulties?

If you have any problems regarding the Postage by Phone service in the U.K. you can call our **Customer Assistance** operators direct on Harlow (01279) 641144.

Please do not use this line for normal refill requests or balance enquiries.

Customer Assistance is available Monday to Friday except Bank Holidays.

Types of Refill

There are two ways to add postage to your meter:

Auto-Refill

The meter will automatically contact our Data Centre over the phone line using its internal Modem. This is the normal method you should use to refill your meter. Your meter must be connected to an analogue phone line and must have been set up for Auto-Refill as described on page 3-11.

Contingency Refill

Only use the Contingency Refill in exceptional circumstances, such as if there is a problem with the auto-refill process.

Refill

Connecting to a Telephone Line

Check first that you have an analogue phone line. Virtually all phone lines in the UK can be used. The line is OK if...

- It is a normal residential line.
- The telephone line is connected to your facsimile machine.
- You hear a change in tone pitch when buttons are pressed.
- There is a label or inscription on your phone giving the "BAPT Ringer Equivalence Number (REN)".

The meter cannot be used with digital ISDN lines or if your line uses pulse (LD) dialling. In these cases, call Pitney Bowes for advice.

Connect the phone cord to the telephone wall socket. You may need a two way adapter (splitter) if you are using the same socket as your fax machine or telephone handset.

The meter can be refilled either in place on the mailing base (preferred), or if the phone socket is too far from the system, removed from the base.

When fitted onto the Mailing Base...

Plug the telephone line into the connector **(A)** on the back of the meter.

Make sure mains power is connected to the Mailing Base at point **(B)**.

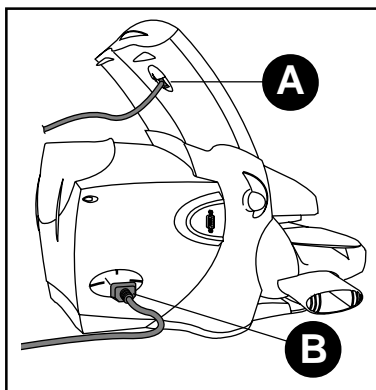

If you need to remove the meter...

1. Push back on the meter release lever **(A)** until the bottom of the lever points to the Remove position . This automatically turns off power to the meter.
2. Carefully lift the meter from the Mailing Machine **(B)**. If you feel any resistance, make sure the release lever is all the way back.

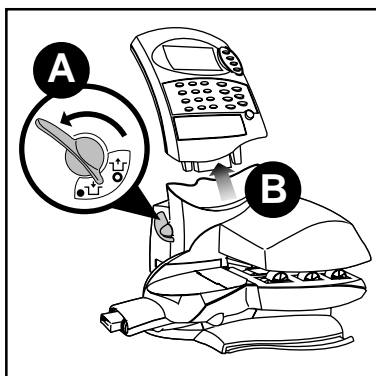

Refill

3. Connect the phone line to the socket **(A)** on the back of the meter.
4. Connect the AC adapter cord to the meter **(B)**. Plug the adapter into a suitable wall power outlet.



WARNING!

Only use the AC adapter supplied by Pitney Bowes. Other adapters could damage your meter.

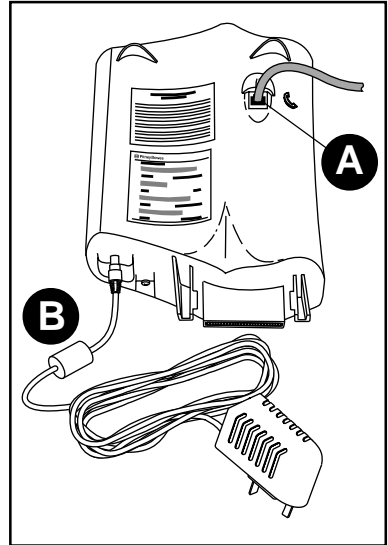

Checking your Postage by Phone Account Balance

IMPORTANT! You should always have adequate funds in your Postage by Phone account before you attempt to add postage to your meter. To check your account balance, your meter must be connected to a phone line.

1. Press **Refill**.
2. Key in **0** (zero value), then press **Enter**.
3. Press **Enter** to confirm the phone line is connected.
4. The meter calls the Postage by Phone Data Centre and displays your account balance.
5. Press **back** (CE/C) to return to the Ready Screen.

Refill

Performing an Auto-Refill

1. Press **Refill**.
2. The meter displays the normal refill amount. You can press **Enter** to accept the normal refill amount; or key in the value you want and press **Enter**.
The refill amount can be up to £9,950.00 and must be in £50 increments.
3. Make sure the phone line is connected (see page 4-2) and press **Enter**.
4. The meter dials the Postage by Phone Centre. You'll see these messages on the display during the refill:
 - The phone number the meter is dialling.
 - *"Connecting...Please Wait."*
 - *"Processing...Please Wait."* This message tells you the meter made a successful connection to the Data Centre and the refill is in progress. You may also see moving dots; this tells you the meter is working.
 - *"Refill Successful."* The display tells you how much was added to the meter and the postage amount now available.
5. Print out a refill receipt.
If you removed the meter from the Mailing Machine, put it back (see page 4-6) to print the receipt.
Insert a spare envelope on the deck or press the **Tape** key (DM300 only).
The receipt contains the following information:

Refill Receipt	Date: 14.09.00 12:00	Account No.: 12345678
	Refill Amt: £200.00	Meter No.: PB370000
	Funds Available in Meter: £410.00	
	Total Account Balance at Pitney Bowes: £300.00	

If the refill wasn't successful, see the troubleshooting instructions in Chapter 6.

Performing a Contingency Refill

IMPORTANT! Make sure your meter is set up to perform a Contingency Refill before you follow the instructions below. See page 3-11, Selecting the Refill Mode.

1. Press **Refill**.
2. The meter displays the normal refill amount. You can press **Enter** to accept the normal refill amount; or key in the value you want and press **Enter**.
The refill amount can be up to £9,950.00 and must be in £50 increments.
The display will prompt you to print refill instructions.
3. Feed a spare envelope into the feed deck or press the **Tape** key (DM300 only) to print refill instructions. The printout has all the information you need to have at hand when you call the Postage by Phone Data Centre:

Refill Instructions	Call Data Ctr:	01279 641144	Serial #: PB370000	14.09.00
	PBP Account #:	12345678		12:00
	Used:	£300001.08	Write in Combination:	
	Unused:	£98.92		
	Refill Amount:	£200.00		

4. Take the refill instructions to the phone and call the Postage by Phone Data Centre. In the U.K., dial the following number:



01279 641144

5. You will be connected to one of our Customer Assistance specialists who will guide you through the refill process.

Refill

Refitting the Postage Meter

If you removed the Postage Meter to carry out a refill, refit it to the Mailing Base in the following way:

1. Push back on the meter release lever so that the bottom of the lever points to the Remove position .
2. Slide the Postage Meter into its slot making sure it is correctly seated.
3. Turn the meter release lever so that the bottom of the lever clicks into the Operate position . The lever may be quite stiff and moderate force may be required.

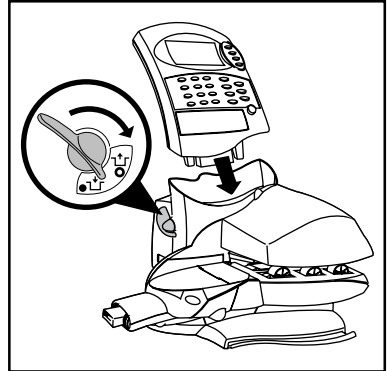

Filling the Moistener

The moistener unit is only fitted to the DM300 system.

1. Check the moistener tank to see how much sealing solution is left.
2. Add enough E-Z Seal® to bring the sealant level up to the top of the moistener tank. We recommend E-Z Seal because it helps keep your moistener clean and improves sealing efficiency.
3. If the tank was empty, allow 30 minutes for the moistener pad to get completely wet.

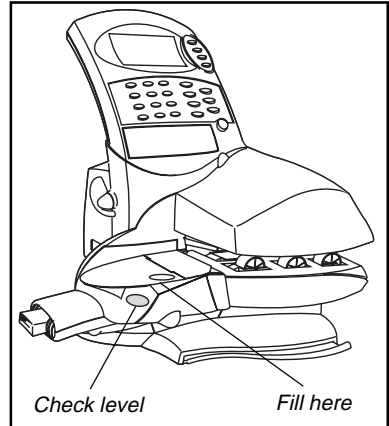

CAUTION! Don't overfill the moistener tank.

Maintaining the Moistener

If you notice incomplete or poor sealing and the moistener tank is full, the moistener brush or wick may need cleaning. If seal quality doesn't improve after cleaning, you can easily replace the moistener brush or wick as needed.

See Chapter 7 for instructions on ordering supplies for your Mailing Machine.

Removing the Moistener

1. Squeeze the release lever.

Maintenance

Maintaining the Moistener (continued)

Removing and Cleaning the Brush

1. Lift the brush holder up.
2. Slide the brush out towards the front of the moistener tank.
3. Clean the brush in a mild soap solution. Rinse thoroughly in plain water.

Reinstalling the Brush

1. Position the brush as shown in the top illustration so the brush's bottom edge is under the mounting tabs.
2. Slide the brush back towards the rear of the moistener tank.
3. Close the brush holder, press down on it firmly, and reinstall the moistener tank (see next page).

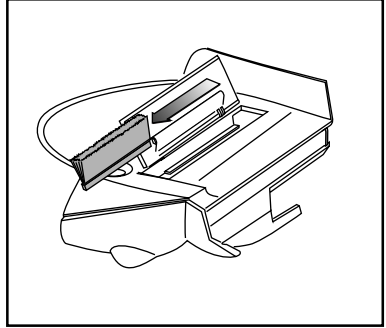

Removing and Cleaning the Moistener Wick

1. Open the brush holder.
2. Press down on the wick assembly; lift it up and out of the moistener (**A**).
3. Slide the wick out of the holder (**B**).
4. Clean the wick in a mild soap solution. Rinse thoroughly in plain water.

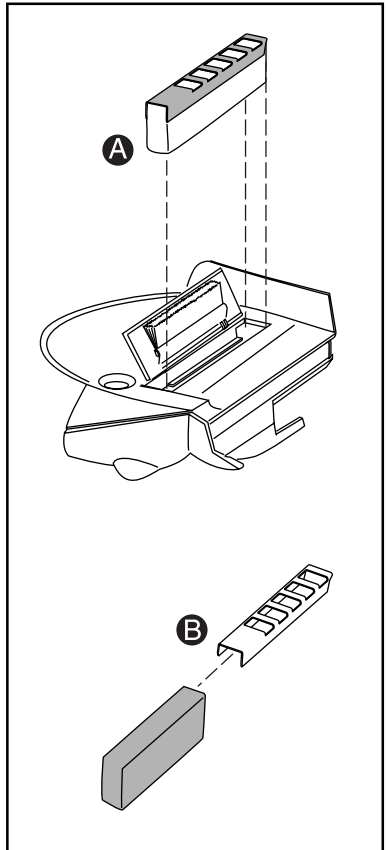

Reinstalling the Wick

1. Place the wick in the holder (**B**).
2. Reinstall the wick assembly (**A**).
3. Close the brush holder, press down on it firmly, and install the moistener tank.

Reinstalling the Moistener

1. Line up the yellow tab with the yellow slot.
2. Slide the moistener tank into position on the Mailing Machine until the release lever snaps into position.
3. Resume operation.



Loading the Tape Strip Feeder

The tape strip feeder is only fitted to the DM300 system.

To load the tape feeder:

1. Remove any tape strips already in the feeder by pulling them straight out.
2. Load the new tape strips print side (white surface) UP.

Take up to a maximum of 50 strips and push them into the feeder as far as they'll go.

You'll feel a slight resistance before they're all the way in.

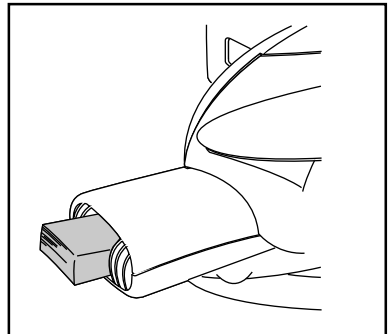

See page 2-7 for instructions on printing tape strips.

If a tape strip jams in the feeder, see the troubleshooting instructions in Chapter 6.

Maintenance

Replacing the Ink Cartridge

Your actual ink usage will vary, depending on whether you routinely print ads, how many mailpieces you print a day and other factors.

The meter display tells you when the ink supply is low or exhausted:

“Low Ink”

Replace the ink cartridge soon. You can print about another 300 meter impressions or leave the meter running for six days without printing. If you don't have a replacement cartridge on hand, you should order one now. See Chapter 7 for ordering instructions.



CAUTION:

Replace the ink cartridge as soon as you see the “Low Ink” alert. Always ensure that your prints are clear and complete. Poor prints may be rejected by Royal Mail.

“Out of Ink”

Replace the ink cartridge immediately. The ink supply is gone; you won't be able to print.

1. Open the rear cover of the mailing machine.
2. Grasp the ink cartridge firmly and pull it straight up and out of the machine. Discard the old cartridge.
3. Remove the new cartridge from its box.
4. Orient the cartridge so the label faces forward, and push the cartridge down into the well as far as it will go. The cartridge is designed so you can't install it the wrong way.
5. Close the rear cover.
6. Press the **Options** key.
7. Select **Ink Functions** from the menu.
8. Select **Fill Ink Reservoir** from the menu.
9. Press the **Enter** key. You can resume operation when the cartridge initialization process is complete.



6. PROBLEMS?

Getting Help

There may be times when you need help to solve a problem, or you may want more information about how your Postage Meter and Mailing Machine work. Pitney Bowes provides several information resources.

This Guide

Please read the troubleshooting information in this chapter. In many cases, it should help you resolve the problem.

The World Wide Web

We encourage you to visit our support web site at:

www.pitneybowestsg.com

You'll find the latest support information about our products and services as well as answers to frequently asked questions.

By Phone



If you cannot clear the fault yourself, you can arrange for one of our engineers to visit by calling the Pitney Bowes National Service Centre on:

08705 12 13 14

Before You Call...

If you need to call, please have the following information at hand:

- Product name: **DM300** (F921 Postage Meter/F9MM Mailing Machine)
or **DM225** (F921 Postage Meter/F8MM Mailing Machine)
- Serial number: See the left side of the meter or press the **Meter ID** key and write down what you see on the display.
- Nature of problem: What happens and when does it happen? Did the meter display an error message? Did the Mailing Machine power lamp display a blink code? (see page 6-12).
- The steps you've already taken to solve the problem and the results.

HINT: You can often restore normal operation by pressing the **CE/C** key or turn the meter release lever to the Remove position , wait a moment or two, and turn it back to the Operate position .

Problems?

Power Problems

No display on Postage Meter; meter won't run

- Is the power cord plugged into both the Mailing Machine and wall outlet? Make sure the power cord is not connected to a switched wall outlet which has been turned off.
- Check the power lamps on the Mailing Machine and the Postage Meter. Both should be on.
- If the Mailing Machine power lamp is on, and the Postage Meter power lamp is off, the meter is not firmly seated. Press down firmly on the meter and turn the meter lock knob clockwise to the Operate \downarrow position.
- The Postage Meter may be in sleep mode. Press any key to wake it.

Envelope Feeding Problems

Envelope jams on transport deck

To clear a jam:

1. Pull the feed deck release knob forward (**A**) and lower the deck as shown.
2. Carefully pull the envelope out from the right (**B**).
3. Make sure the deck is clear of paper fragments.
4. Close the deck.

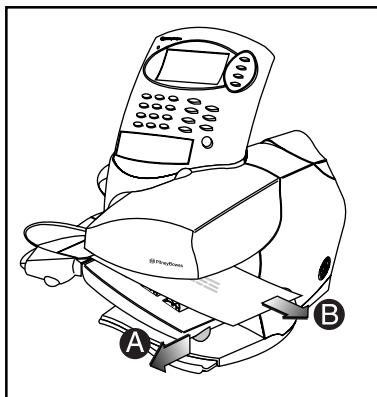

To avoid jams:

- Make sure your envelopes meet our published specifications. See page 7-1.
- Feed envelopes correctly. See the instructions on page 2-6. Don't try to feed oversize envelopes through the machine – use tapes instead.

HINT: If the meter display prompts “Remove Env” but no envelope is present, check if there is a partially fed tape on the feed deck.

Problems?

Tape Feeding Problems

Improper Loading (DM300 only)

Load tape strips print side up and guide them all the way into the feeder—push them in as far as they'll go.

HINT: Always remove remaining tape strips before you add a new stack.

Tape or Paper Fragments in Feeder (DM300 only)

Clean tape strip feeder:

1. Remove the moistener (see page 5-1).
2. Slide the tape strip feeder cover to the left and remove.
3. Remove the tapes. Inspect the feeder and clean out any debris. Push down on the spring-loaded pressure plate and remove any paper from under the feed roller or tape guide.
4. Slide the tape strip feeder cover back into position.
5. Reinstall the moistener (see page 5-3).
6. Load tape strips and resume normal operation.

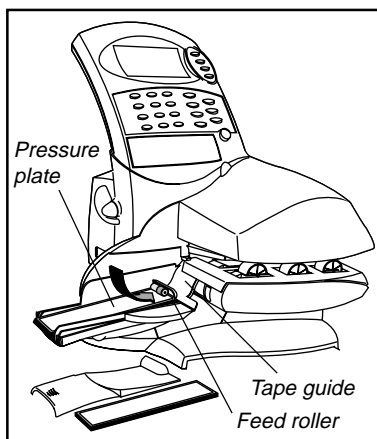
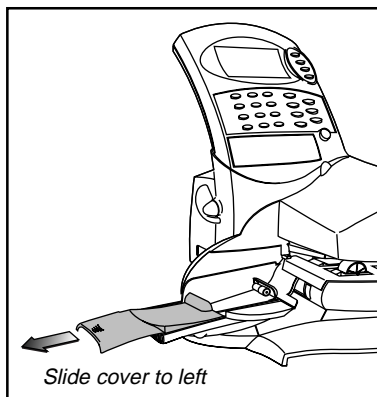

Problems?

Printing Problems

Meter stamp is incomplete or streaked; poor print quality

Print nozzles clogged.

Always ensure that your prints are clear and complete. Poor prints may be rejected by Royal Mail. If you notice missing lines in the print as shown in the illustration, perform printer maintenance as described on page 3-4 of this guide.

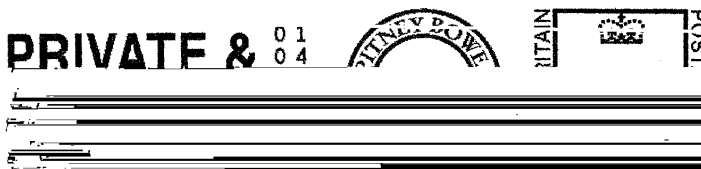

You can repeat printer maintenance up to three times until you obtain a good test print:

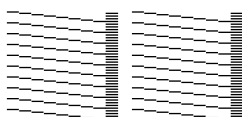

good test print

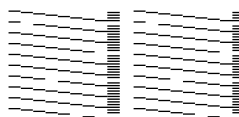

bad test print

If printer maintenance fails to correct the problem, call for service (see page 6-1).

Display Problems

Display hard to read

Display contrast needs adjustment:

1. Press **Options**.
2. Select the option **Setup Menu**.
3. Select the option **Basic Settings**.
4. Select the option **Display Contrast**.
5. Select the contrast level you want: 1 is the lowest; 5 is the highest.
6. Press **Enter**.
7. Press **back** (CE/C) twice to return to the Ready Screen.

Moistening Problems

Envelopes don't seal (DM300 only)

Incorrect feeding

Make sure you slide the envelope flap under the blue edge of the feed deck. If you don't, the moistener can't wet the flap.

Low sealant level

Check the sight glass on the moistener. If the sealant level is low, refill the moistener with E-Z Seal solution. See the instructions on page 5-1.

Dry moistener brush

Try wetting the moistener brush. If the brush dries out quickly, replace the moistener wick as explained on page 5-2.

Dirty moistener brush

Remove the moistener brush and clean it in a mild soap and water solution. Rinse thoroughly in plain water.

Worn moistener brush

Replace the moistener brush. See page 5-2 for instructions.

Problems?

Refill Problems

The display shows a series of messages during the auto-refill process

This is normal. The meter is designed to display the progress of the refill. If the refill fails for any reason, the display tells you why. See pages 6-7 to 6-11 for an alphabetical listing and explanation of all display messages.

Meter fails to connect to Postage by Phone Data Centre—no dial tone

Meter not connected to analogue phone line

Make sure you've connected your meter to a working analogue phone line. Also make sure the phone line connectors are firmly seated in their sockets.

Incorrect refill setup

One or more of the refill setup options may be wrong. Go to the refill setup instructions on the pages noted and check the following:

- Does your phone system require you to dial a prefix number (and possibly insert a pause) to get an outside phone line? Make sure to include these in the setup if needed. See page 3-12.
- Is the refill mode set to Auto-Refill? If it isn't, you can't perform a modem refill. See page 3-11.

Refill Failed—Invalid Account Number

- The Postage by Phone account number you used isn't correct. Check the Information Pack that came with your system for your Postage by Phone Account Number.
- Make sure you entered the right account number during setup, as described on page 3-13.

Display Messages

From time to time your meter will display an alert or error message. An alert tells you that something needs attention; an error message usually tells you about a fault condition you can fix. In rare instances you may have to call for service. We've listed the messages below, arranged alphabetically.

Account Balance Low

There's not enough money in your Postage by Phone account to refill the meter with the amount you requested. Request a smaller refill amount or make a deposit to your account. Also, see the Postage by Phone information on page 4-1 of this guide.

Account not recognised by Postage by Phone Data Centre

The account number you used is wrong or invalid. Check the Information Pack that came with your meter for your Postage by Phone account number. See page 3-13 to set up automatic (modem) refill with the correct account number.

Ad Not Found

A memory preset requires an ad that's no longer in the meter. No ad is set when the meter returns to the Ready Screen. Press **CE/C** to clear this message.

Ad Not Installed

- You inserted a smartcard that doesn't have an ad. Did you inadvertently insert a town circle card?
- You inserted the smartcard the wrong way. Place the card in the slot with the microprocessor facing you and at the bottom.

Remove the card and press **Enter** to cancel the ad installation. Try to load the ad again. If you see the same error message again, call Pitney Bowes for help.

Cannot Initialise Modem

There is a connection problem when using an external modem. Check all connections and that the modem is connected to power and turned on.

Cannot Reach Postage by Phone

The meter called the Postage by Phone Data Centre but failed to connect. This could be due to a communications problem or a modem setup problem. Repeat the call. If you still have problems, check all the refill setup instructions (in particular, the dialling prefix) on pages 3-10 to 3-13 of this guide.

Problems?

Display Messages (continued)

Clock Adjustment Exceeded

You tried to adjust the meter's clock beyond the limit allowed. Press **CE/C** to set clock time again.

Connection Lost

The meter lost the phone connection with the Postage by Phone Data Centre during a refill. Press **yes** to repeat the call.

Date Adjustment Exceeded

You tried to advance the date by more than the 30 days maximum permitted. Press **CE/C** to return to the last valid advance date.

Digital Phone Line Detected

The meter can only be connected directly to an analogue phone line. See page 4-2 for details.

Envelope Skewed

The mailpiece is crooked on the feed deck. The meter won't print when this happens. Instead, the mailpiece exits the meter automatically. Press **CE/C** to clear the error and then reinsert the mailpiece.

Make sure you're feeding envelopes properly. Follow the instructions on page 2-6 of this guide.

High Value

The postage value you entered is more than the high value limit set for your meter. This is a warning; it doesn't stop you from using the meter. Press **Enter** to accept the value and print postage on your envelope or tape.

Incorrect Code

You entered an invalid lock code (password). Press Clear (**CE/C**) and enter the correct code. If you forgot the code, call Pitney Bowes (see page 6-1 for phone number).

Incorrect Combination Code

You entered an incorrect combination number during a Contingency refill. Press **CE/C** to continue and enter the number the Pitney Bowes Data Centre gave you. If you've lost or forgotten it, repeat the refill process.

Ink Cartridge Empty

The ink supply is used up. Replace the ink cartridge (see page 5-4).

Inspection Due

This message displays if you haven't refilled your meter for 60 days. You can still operate your meter normally. The Data Centre normally performs this inspection during a routine modem (auto) refill by checking the funds used and the funds available. Either complete a modem (auto) refill, or If you don't need to add funds at this time, just check you Postage by Phone account balance (see page 4-3) – this satisfies the inspection requirement.

Inspection Required

This message is similar to **Inspection Due**, with two important differences:

1. It appears if you haven't refilled your meter by modem for 90 days.
2. You will NOT be able to use your meter until you perform a modem (auto) refill for **£0.00** by following 'Checking your Postage by Phone Account Balance' on page 4-3. Due to Post Office security requirements, you will not be able to add funds until you have performed this function.

Your meter must be set up to perform a modem (auto) refill, if necessary you can go into the setup menu and change it. See the instructions on pages 3-10 to 3-13.

Insufficient Funds

There's not enough postage left in your Postage by Phone account to refill with the amount selected. The meter will show the maximum funds available. Carry out another Auto-Refill for an amount that can be met by the available funds.

Insufficient Funds - Refill

There's not enough postage left in the meter to print a stamp with the value you entered. Refill the meter (see Chapter 4) or enter a lower value.

Invalid Selection (Amount/Preset/Ad/Account)

You entered an invalid value i.e. impossible monetary value or unallocated Preset, Ad or Account number. Press **CE/C** to return to normal operation.

Lower Transport Deck is Open

Raise the lower transport and latch it in position (see item 5, page 1-4). Then press **CE/C** to clear the error message.

Low Funds

The funds remaining in your meter are now below the Low Funds Warning level. Refill with postage soon (see Chapter 4).

Problems?

Display Messages (continued)

Low Ink

The ink cartridge will need replacement soon. If you don't have a replacement cartridge on hand, you should order one now (see Chapter 7 for ordering instructions). You can still print postage when this message appears.

Meter Error XXXX

A four-digit error code displays. Follow the instructions on the meter display. In some cases you may be unable to clear the error. When this happens, the display prompts "Call for service." The phone number is on page 6-1.

Name Conflict

The name you chose is already assigned to another preset. The meter will return to the enter preset name menu after two seconds. Enter a name that's not in use.

Need Account

When the meter's accounting feature is on, you must enter a valid account number before the meter allows you to select a postage value. Select an account as described on page 2-4.

No Account Selected

A memory preset requires an account that's no longer in the meter. No account is set when the meter returns to the Ready Screen. Select a valid account and/or edit the preset to select a valid account in future.

No Dial Tone

The meter tried to call the Postage by Phone Data Centre but couldn't detect a dial tone. Repeat the call. If the problem persists, check the dialling prefix setup (page 3-12).

Number of Tapes Exceeds Limit

DM300 only – you can print up to 25 tapes in a single operation.

Postage Value Exceeds Limit

You entered a postage amount that's more than the meter can accept. The meter will tell you what the maximum postage value is. Press **CE/C** to clear this error message.

Postage by Phone is Busy

- All lines to the Postage by Phone Data Centre are currently busy. Try again later.
 - Check all the refill setup instructions (in particular, the dialling prefix) on pages 3-10 to 3-13 of this guide.
-

Printer Error

- The printer needs maintenance. Follow the prompts to test the printer. See the detailed instructions on pages 3-4 and 3-5.
 - You tried to print a report to an external printer and the printer is not connected or turned on/ready/on-line.
-

Refill Failed—Check Account Number

The account number you used is wrong or invalid. Check the Information Pack that came with your meter for your Postage by Phone account number. See page 3-13 to set up automatic (modem) refill with the correct account number.

Refill Must be a Multiple of £50

You entered an invalid refill amount. Enter an amount that is a multiple of £50.

Refill Too High

The meter can't hold the refill amount you asked for plus the funds already in it. Enter a smaller refill amount.

Refill Too Low

The minimum refill amount is £50. You can refill up to £9,950 in £50 increments.

Remove Envelope/ Remove Stalled Material/Remove Mailpiece

Clear the stalled material as described on pages 6-2 and 6-3 of this guide.

Tape: Failed to Feed

Reload tape strips (see page 5-3) and check for a tape stoppage (see page 6-3).

Town Circle Graphic Not Installed

- You inserted a smartcard that doesn't have a town circle. Did you inadvertently insert an ad card?
- You inserted the smartcard the wrong way. Place the card in the slot with the microprocessor facing you and at the bottom.

Remove the card and press **Enter** to cancel the installation. Try to load the town circle again. If you see the same error message again, call Pitney Bowes for help.

Problems?

Blink Codes

The power lamp on the left side of the Mailing Machine blinks when the system detects an internal error. The number of blinks tells you what kind of problem occurred.

You may be able to fix some problems by unplugging the Mailing Machine, waiting a few minutes, and then plugging it back in. If this doesn't fix the problem, see the chart below for an explanation of the blink codes.

Note the number of blinks. The lamp blinks a certain number of times, pauses, and then blinks the same number of times. This pattern, called a blink code, repeats until the problem is fixed.

When you call for assistance, tell the Pitney Bowes telephone service representative what blink code you saw. This helps to isolate the problem and gets your meter up and running faster.

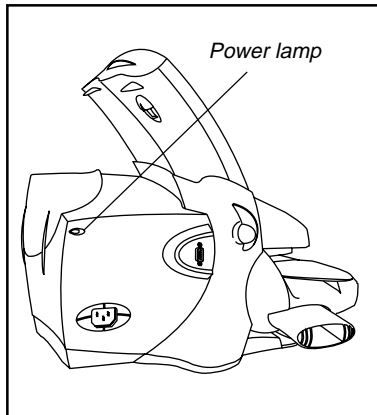

1 Blink—Low ink

Replace the ink cartridge. (The meter display normally tells you when it's time to replace the ink cartridge.)

2 Blinks—Ink out

Replace the ink cartridge. See page 5-4.

3 Blinks—High transport motor temperature

This error can occur if you exceed the Mailing Machine's maximum use specification. Wait a few minutes for the motor to cool. If this error happens often, call the National Service Centre. See page 6-1.

4 Blinks—High tape motor temperature

Wait a few minutes for the motor to cool. If this error happens often, call the National Service Centre. See page 6-1.

5 Blinks—High valve, carriage or purge motor temperature

Wait a few minutes for the motor to cool. If this error happens often, call the National Service Centre. See page 6-1.

6 Blinks—Circulation valve home position sensor

Call the National Service Centre. See page 6-1.

7 Blinks—Carriage home position sensor

Call the National Service Centre. See page 6-1.

8 Blinks—Home position error

Call the National Service Centre. See page 6-1.

9 Blinks—Fan error

Call the National Service Centre. See page 6-1.

10 Blinks—Serial communications error

You may need to replace the print head. Call the National Service Centre. See page 6-1.

11 Blinks—Print head not installed

Problems with the print head. If this error continues, call the National Service Centre. See page 6-1.



12 Blinks—Ink sensor error

Call the National Service Centre. See page 6-1.

13 Blinks—Jam in stand-alone mode

Remove envelope and restart machine.

14 Blinks—Skew in stand-alone mode

Remove envelope; then reset meter by turning meter release lever to the Remove  position, waiting a moment or two, then turning it back to Operate .

15 Blinks—EEPROM failure

Call the National Service Centre. See page 6-1.

16 Blinks—Motor Drive IC error

Call the National Service Centre. See page 6-1.

17 Blinks—Meter serial communication error

Make sure the Postage Meter is installed properly onto the Mailing Machine. Restart machine. If error recurs, call the National Service Centre. See page 6-1.

18 Blinks—Print head drive voltage error

Call the National Service Centre. See page 6-1.

Problems?

3. REFERENCE

Specifications

Equipment

Size (without stacker):	DM300: 356mm L x 368mm W x 381mm H DM225: 300mm L x 368mm W x 381mm H
Weight:	8kg approximate
Power Requirements:	100-240VAC, 50/60 Hz, 0.65-0.3A
Compliance:	See page 1-3 of this guide
Operating Temperature:	4°C to 43°C
Average Throughput:	DM300: 65 letters per minute maximum. DM225: 40 letters per minute maximum. (Depends on material and operator skill)
Ink Cartridge Life (letters):	low usage: 2,000, moderate usage: 5,000, high usage: 7,000. We recommend you replace the cartridge every six months, regardless of usage.
Tape Strip (DM300 only):	Self-adhesive type. Capacity: 50 tapes
Internal Ad Slogan Storage:	5 programmable; 5 pre-programmed
Accounting:	10 accounts standard; 50 or 100 accounts optional

Material

Minimum Size:	89mm x 105mm moistening (DM300 only) 76mm x 105mm non-moistening
Maximum Size:	297mm x 340mm
Envelope Flap Depth:	25mm to 76mm
Thickness:	0.2mm to 8mm

IMPORTANT: For best results, make sure your material meets our specifications.

Meter

Maximum Imprint:	£99.99
Maximum Credit Setting:	£9,950.00 in £50 increments
Reset Type:	Postage by Phone
Piece Count:	Up to 8 digits (nonresettable)

All Pitney Bowes postage meters are manufactured in accordance with Royal Mail's 2002 Franking Machine Standards. This includes ascending register security, which will lock the ascending registers when the first frank takes the most significant digit of the ascending register to 9.

Reference

Supplies and Accessories

Order Numbers

Ink Cartridges

Ink Cartridge, Red Non-Fluorescent

Reference

766-E

Tape

Pack of 300 Tape Strips (for DM300)

625-E

Pack of 1000 Double Label Sheets (for DM225)

SV83025

Pack of 500 Double Label Sheets (for DM225)

SV83019

E-Z Seal™

Pack of 4 Flip Top Bottles

601-9E

Dab it Bottle

H601-7

1/2 Gallon Bottle

SV92278

Late Night Posting Envelopes

Pack of 200

SV92034

IMPORTANT INFORMATION

Always use Pitney Bowes ink. Use of other ink may damage the print head which will not be covered by your warranty or maintenance agreement. Use of unapproved ink may also contravene Royal Mail regulations for use of a postage meter.

Advertising Slogans (Ads)

Pitney Bowes offers a wide range of standard and custom ad slogans. These give your mail a professional appearance and can turn your mailings into a powerful promotional tool.

Your F921 postage meter holds up to 5 programmable ads. Pitney Bowes makes optional ads available on convenient art cards, so you can easily install them whenever you like.

How to Order

You can order supplies on-line from our website at:

www.pitneybowes.co.uk/buy_supplies

Alternatively, phone **PB Direct**. The phone number will be on the catalogue supplied with your system, or in the Information Pack. Our representatives will be happy to answer your questions and take your order.

Options

Pitney Bowes offers a number of flexible options so you can tailor your mailing system to meet your exact needs today, and expand it as your business grows.

Accounting

Your system's standard accounting feature tracks postage costs for up to 10 separate accounts. You can easily expand this feature to handle 50 or 100 accounts.

Printing

Your meter has several report functions, some of which require an external serial printer. Pitney Bowes offers serial printers to complement your meter.

Weighing

Your Postage Meter and Mailing Machine are designed to work with the current family of Pitney Bowes 'N' Series electronic postal scales. When combined, they form a complete mailing system that:

- Accurately weighs the mailpiece.
- Calculates rates and fees.
- Allows you to control and display certain other meter functions directly from the scale's control panel.
- Saves you money because you don't waste postage.

See the operator guide supplied with your scale for complete instructions on using it with your Postage Meter and Mailing Machine.

Changing Address?

If changing your name and address, inform Pitney Bowes as early as possible. The necessary paperwork and changes to your meter can then be carried out at the time required.

Reference

Hints and Tips

...to ensure optimum performance of your Digital Mailing system.

Useful Installation Hints and Tips

- Follow ALL the steps in the 'Quick Install Guide'.
- When installing the ink cartridge ensure it is fully pushed down.
- When the machine requests you to 'Enter Account Number' use your unique Postage by Phone (PbP) account number found in the top right-hand corner of your welcome letter.
- If during the Postage by Phone refill the machine displays 'Cannot Reach Data Centre' you may need to enter a Dialling Prefix, i.e. (9) if using an extension telephone. The machine will prompt you for a Prefix.
- Your machine needs an *Analogue* telephone line. Most Fax machines require an analogue telephone line, use the splitter provided to attach your machine to the Fax telephone line if another suitable line is unavailable.

Print Quality and Machine performance

- Your Digital Mailing system utilises the latest Ink Jet technology and carries out its own printer maintenance. **To ensure optimum performance and maximum ink cartridge life, ensure the machine remains plugged in and turned on at all times.** The machine is equipped with a power saving sleep mode for safety and economy.
- Always ensure you have a spare ink cartridge available and replace the cartridge when the machine displays 'Low Ink'. Step by Step instructions for replacing the ink cartridge are in chapter 5 of this guide. Once the 'Low Ink' warning is displayed, the ink cartridge is *empty* and can be replaced immediately.
Using the 'Options' menu, 'Ink Functions' menu and 'Fill Ink Reservoir' when replacing the ink cartridge will ensure optimum print quality and a professional image every time.
- Printer Maintenance may be required if lines are missing in the meter stamp. Printer maintenance guidelines can be found in this Guide.

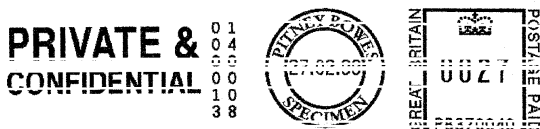

Example of missing lines in meter stamp

- Only use genuine Pitney Bowes Ink and Ink Cartridges in your machine. The ink is approved by Royal Mail and designed to ensure optimum performance. The use of non Pitney Bowes ink may cause irreparable damage to the machine.

We have made every reasonable effort to assure the accuracy and usefulness of this guide, however we cannot assume responsibility for errors or omissions or liability for the misuse or misapplication of our products.

FOR SERVICE AND SUPPLIES:



The Pinnacles, Harlow,
Essex, CM19 5BD, U.K.

V5.04 software

Free Manuals Download Website

<http://myh66.com>

<http://usermanuals.us>

<http://www.somanuals.com>

<http://www.4manuals.cc>

<http://www.manual-lib.com>

<http://www.404manual.com>

<http://www.luxmanual.com>

<http://aubethermostatmanual.com>

Golf course search by state

<http://golfingnear.com>

Email search by domain

<http://emailbydomain.com>

Auto manuals search

<http://auto.somanuals.com>

TV manuals search

<http://tv.somanuals.com>