

IMPORTANT - READ THIS FIRST

before plugging in your scale

These instructions describe how to quickly unpack and setup your N series scale.

Follow them carefully to install the scale, then refer to the Operating Guide for full details of how to operate the machine.

**For the N421 (2kg)
scale...**



go to page **2**

For the N521 (2kg), N621/N620 (5kg), N721/N720 (12kg) scales...



go to page **6**

**For the N921/N920 (35kg)
scales...**



go to page **11**

Use these instructions if you have a N421, 2kg scale

The scale looks like this:



1. Make sure you have:

- ✓ Scale
- ✓ Power Supply Unit (in its own box)
- ✓ User Guide
- ✓ Rates PROM (You may or may not be supplied with a Rates PROM. If one is supplied, fit it at step 4 or your scale may display incorrect rates. If one is not supplied, your scale has been pre-programmed with the current rates and will function without one until the next postage rate change).
- ✓ Meter Cable (only supplied if you ordered a Pitney Bowes Postage Meter at the same time as your scale)

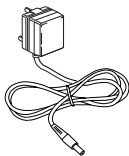

Power Supply Unit

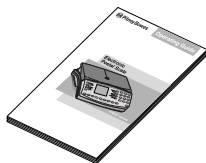

User Guide

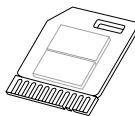

Rate PROM (if supplied)

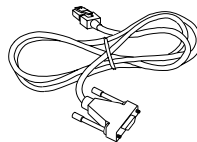

Meter Cable

2. Place your scale on a level surface

Place the scale near a wall outlet and within cable reach of your postage meter (if you have one). Ensure the scale location is a flat, stable surface free of draughts and the scale is not touching objects that may affect the weight reading.

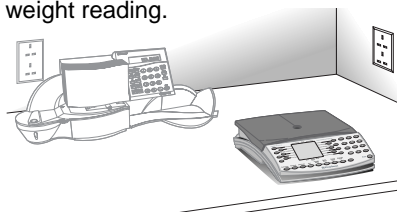

3. Remove packing

Lift the platform and remove the packing material.

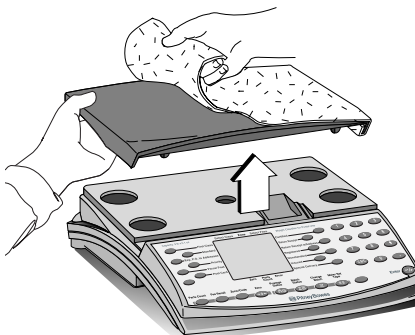

4. Install the Rate PROM

If you have been supplied with a PROM, slide it into its slot ensuring the opening in the PROM handle is in the top right corner. Press it firmly until it snaps into place. Refit platform.

If a rate PROM has not been supplied, you can omit this stage.



5. Locate the plug ports

Locate the plug ports under the front of the scale and plug in the small end of the power cable.

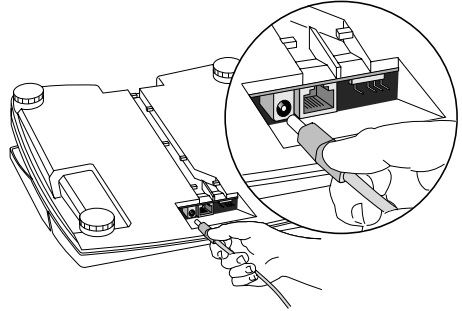

6. Connect the postage meter cable

If using a Postage Meter, plug the small end of the meter cable into the scale.

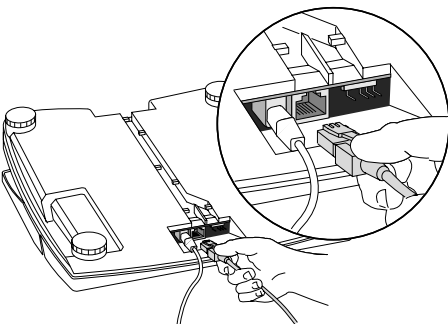

7. Tuck the cable(s) into the cable guides

Tuck the cable(s) under the guides on the bottom of the scale.

Turn the scale back onto its feet.

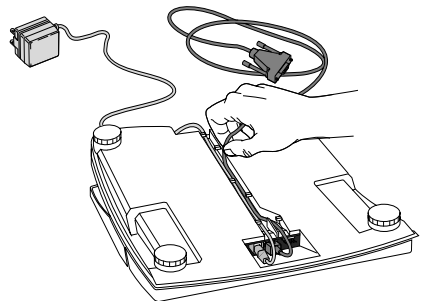

8. Level the scale

Level the scale by turning the scale feet until the levelling bubble is centred and the scale does not wobble.



9. Connect the meter cable to the postage meter

If using a postage meter, connect the large end of the meter cable to the meter as shown. Tighten the thumbscrews securely.

If your postage meter is fitted with an optional Datalink unit, connect the large end of the meter cable to the **lower** connector on the Datalink unit. Tighten the thumbscrews securely.

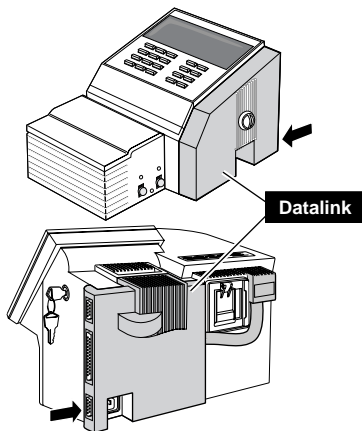
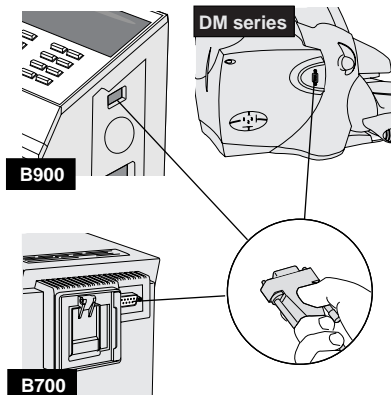

10. Plug power supply unit into outlet

Plug the power supply unit into the wall outlet and turn power on. After a short power-up sequence, the display appears as shown.

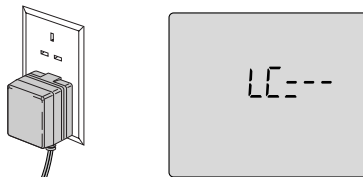

Note: If the scale does not power-up, check that the power cable is firmly attached to the scale. Also check that the wall outlet you are using has power by plugging in another device.

11. Enter your scale location code

Note: Your scale will not work unless you perform this step.

- Find the location code corresponding to your location on the map.
- Enter the code via the numeric keys.
- Ensure that the code on the display matches your location code.
- Press Enter.

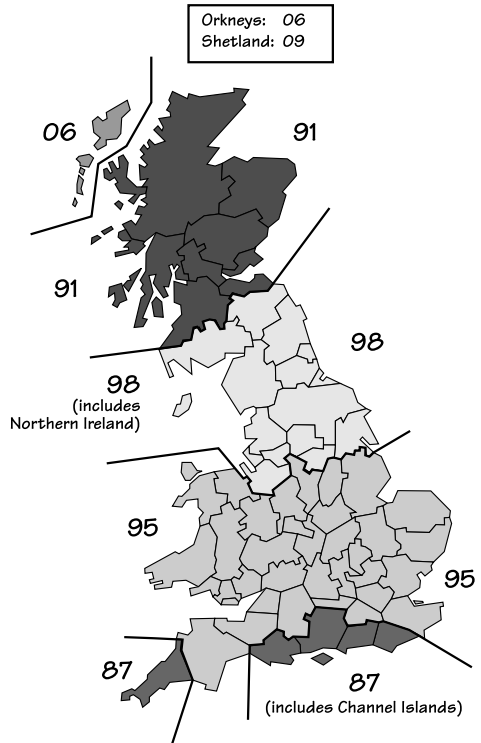

12. The scale is now 'ready'

After entry of the location code, the scale goes through a short test sequence, then displays **0000g** and the Select Category arrow flashes. This is the ready mode.

If your postage meter has an optional Datalink unit fitted, configure it now as described in the Datalink Operating Guide.

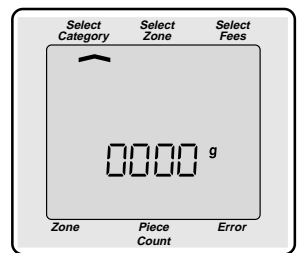

Scale ready mode

Congratulations!

You have successfully installed your Pitney Bowes Scale.
For information on using the scale, refer to the Operating Guide.

If you have existing Pitney Bowes equipment that needs to be returned, follow the instructions included in your 'Information Pack' now.

Use these instructions if you have a N521 (2kg), N620/N621 (5kg) or a N720/N721 (12kg) scale

The scales look like this:



N521



N620, N621, N720, N721

1. Make sure you have:

- ✓ Scale
- ✓ Power Supply Unit (in its own box)
- ✓ User Guide
- ✓ Rate PROM
- ✓ Meter Cable (only if you ordered a Pitney Bowes Postage Meter at the same time as your scale)

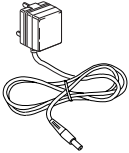

Power Supply
Unit



User Guide

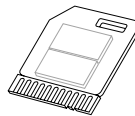

Rate PROM

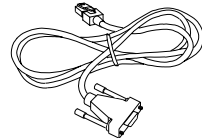

Meter Cable

2. Place your scale on a level surface

Place the scale near a wall outlet and within cable reach of your postage meter (if you have one). Ensure the scale location is a flat, stable surface, free of draughts and the scale is not touching objects that may affect the weight reading.

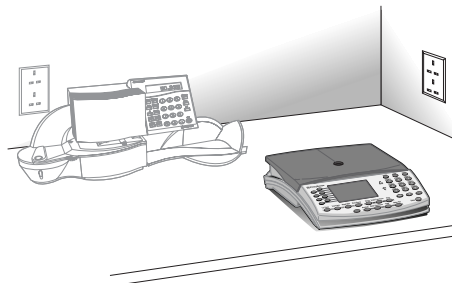

3. Remove packing

Lift the platform and remove the packing material.

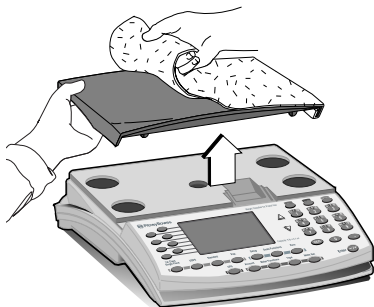

4. Install the Rate PROM

Slide the Rate PROM into its slot ensuring the opening in the PROM handle is in the top right corner. Press it firmly until it snaps into place. Refit platform.

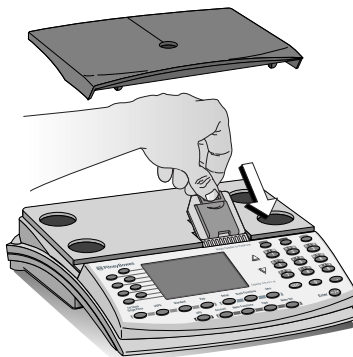

5. Locate the plug ports

Locate the plug ports under the front of the scale and plug in the small end of the power cord.

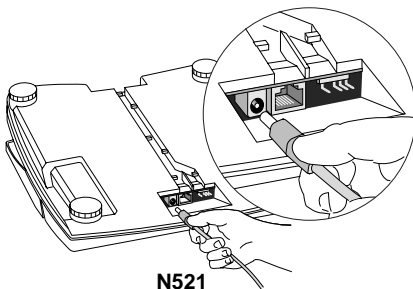

6. Connect the postage meter cable

If using a Postage Meter, plug the small end of the meter cable into the scale.

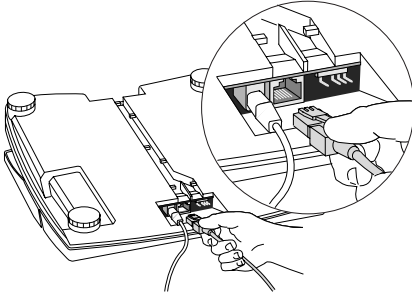

N521

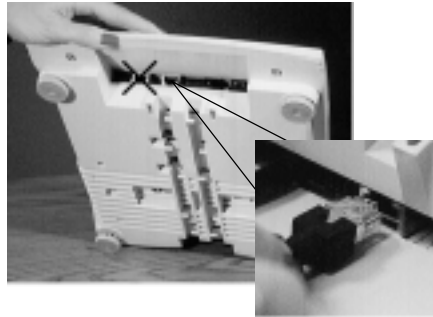

N620, N621, N720, N721

7. Tuck the cable(s) into the cable guides

Tuck the cable(s) under the guides on the bottom of the scale. Turn the scale back onto its feet.

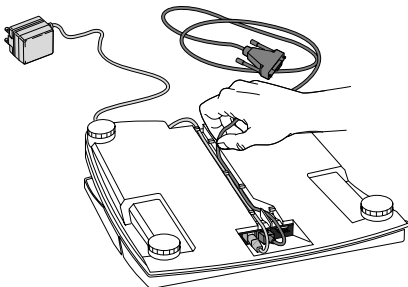

N521



N620, N621, N720, N721

8. Level the scale

Level the scale by turning the scale feet until the levelling bubble is centred and the scale does not wobble.

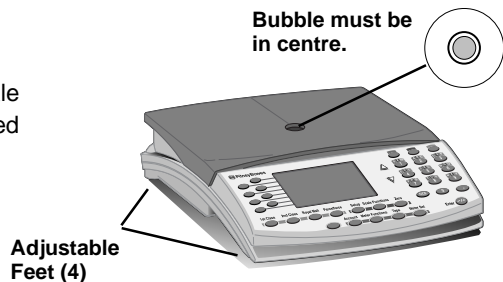

Bubble must be
in centre.

Adjustable
Feet (4)

9. Connect the meter cable to the postage meter

If using a postage meter, connect the large end of the meter cable to the meter as shown. Tighten the thumbscrews securely.

If your postage meter is fitted with an optional Datalink unit, connect the large end of the meter cable to the **lower** connector on the Datalink unit. Tighten the thumbscrews securely.

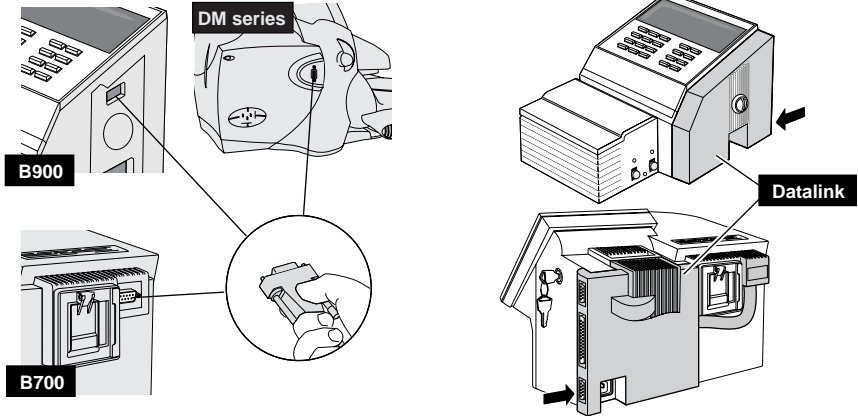

10. Plug power supply unit into outlet

Plug the power supply unit into the wall outlet and turn power on. After a short power-up sequence, the display appears as shown.

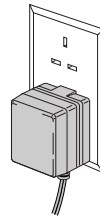

Note: If the scale does not power-up, check that the power cable is firmly attached to the scale. Also check that the wall outlet you are using has power by plugging in another device.

11. Enter your scale location code

Note: Your scale will not work unless you perform this step.

- Find the location code corresponding to your location on the map.
- Enter the code via the numeric keys.
- Ensure that the code on the display matches your location code.
- Press Enter.

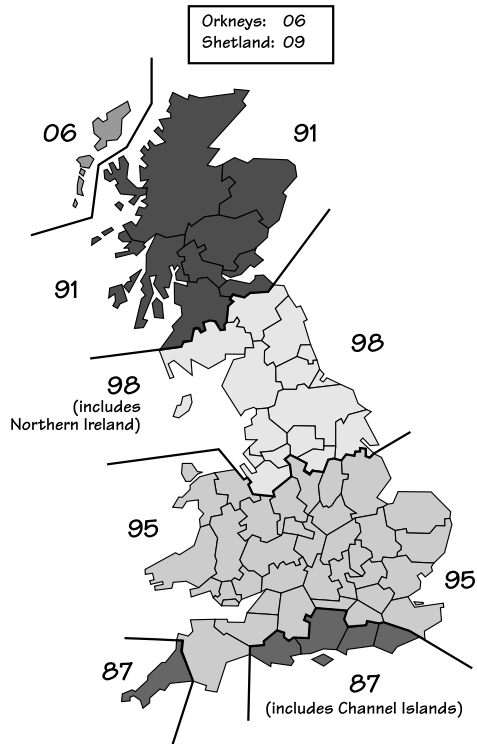

12. The scale is now 'ready'

After entry of the location code, the scale goes through a short test sequence, then displays **0g** and the Select Category message. This is the ready mode.

If your postage meter has an optional Datalink unit fitted, configure it now as described in the Datalink Operating Guide.

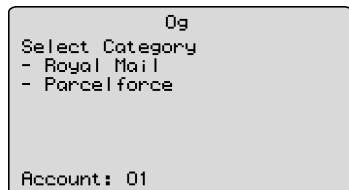

Congratulations!

You have successfully installed your Pitney Bowes Scale.
For information on using the scale, refer to the Operating Guide.

If you have existing Pitney Bowes equipment that needs to be returned, follow the instructions included in your 'Information Pack' now.

Use these instructions if you have a N921, 35kg scale

The scale looks like this:

Note: The weighing platform and control module are separate units connected by a single cable.



1. Make sure you have:

- ✓ Scale control module and platform
- ✓ Power Supply Unit (in its own box)
- ✓ User Guide
- ✓ Rate PROM
- ✓ Meter Cable (only if you ordered a Pitney Bowes Postage Meter at the same time as your scale)

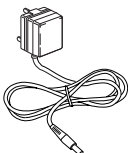

Power Supply Unit



User Guide

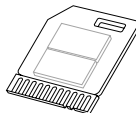

Rate PROM

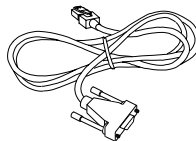

Meter Cable

2. Locate and level the weighing platform

Place the platform within cable reach of the Control Module. Ensure the platform location is a flat, stable surface, free of draughts and the platform is not touching objects that may affect the weight reading.

Lift the cover straight up from the platform unit. Level the platform by turning its feet until the levelling bubble is centred and the platform doesn't wobble.

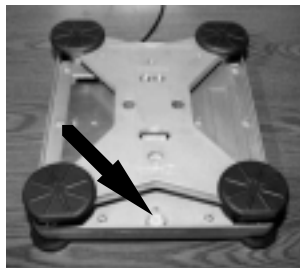

X

✓

3. Assemble the weighing platform

Place the cover on the weighing platform. Press down on each corner to be sure it is completely seated.



4. Remove the control module cover

Remove the cover from the top rear of the control module and set aside.



5. Install the Rate PROM

Slide the Rate PROM into the slot with the unlabelled side facing you. Press it firmly until it snaps into place. Refit cover.



6. Connect weighing platform to control module

Turn the control module over and plug the small end of the weighing platform cable into the back of the module.

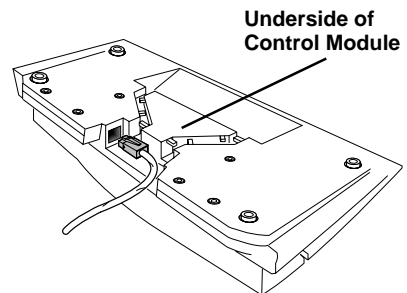

7. Locate the plug ports

Locate the plug ports under the front of the control module and plug in the small end of the power cable.



8. Connect the postage meter cable

If using a Postage Meter, plug the small end of the meter cable into the control module.

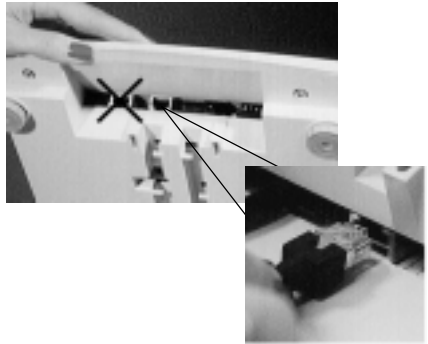

9. Tuck the cable(s) into the cable guides

Tuck the cable(s) under the guides on the bottom of the control module.
Turn the module back onto its feet.

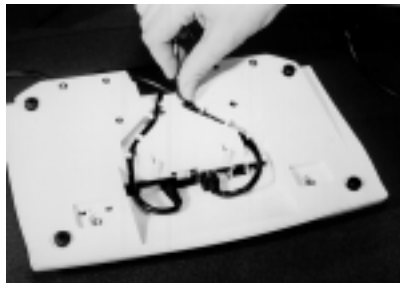

10. Connect the meter cable to the postage meter

If using a postage meter, connect the large end of the meter cable to the meter as shown. Tighten the thumbscrews securely.

If your postage meter is fitted with an optional Datalink unit, connect the large end of the meter cable to the **lower** connector on the Datalink unit. Tighten the thumbscrews securely.

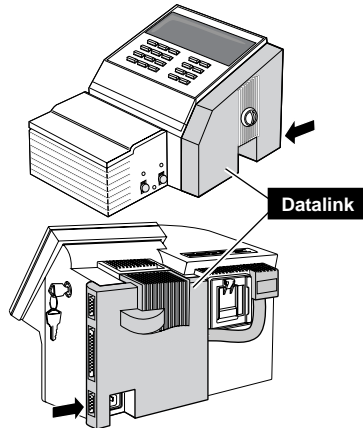
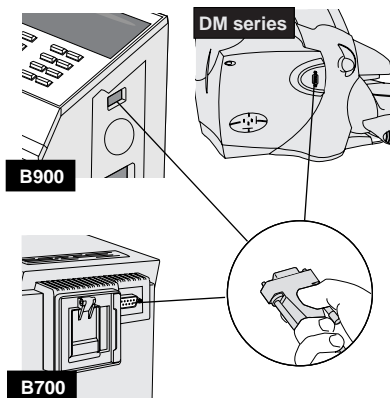

11. Plug power supply unit into outlet

Plug the power supply unit into the wall outlet and turn power on. After a short power-up sequence, the display appears as shown.

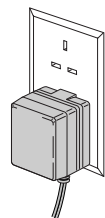

Enter Location Code:

Note: If the scale does not power-up, check that the power cable is firmly attached to the control module. Also check that the wall outlet you are using has power by plugging in another device.

12. Enter your scale location code

Note: Your scale will not work unless you perform this step.

- Find the location code corresponding to your location on the map.
- Enter the code via the numeric keys.
- Ensure that the code on the display matches your location code.
- Press Enter.

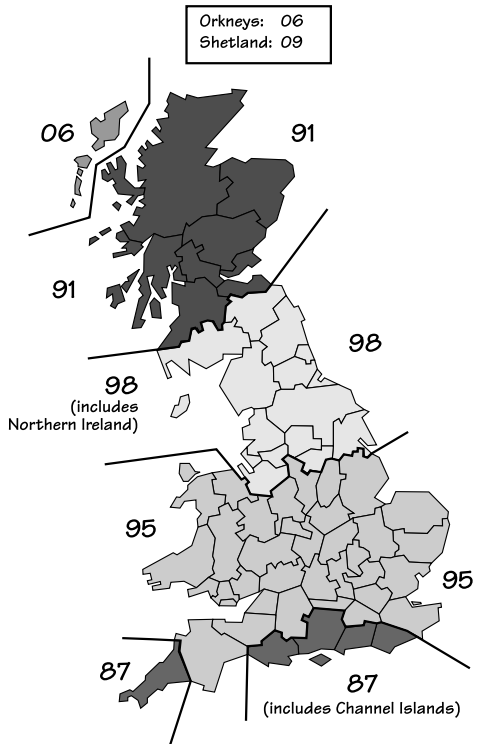

13. The scale is now 'ready'

After entry of the location code, the scale goes through a short test sequence, then displays **0g** and the Select Category message. This is the ready mode.

If your postage meter has an optional Datalink unit fitted, configure it now as described in the Datalink Operating Guide.

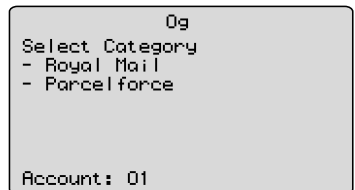

Congratulations!

You have successfully installed your Pitney Bowes Scale.
For information on using the scale, refer to the Operating Guide.

If you have existing Pitney Bowes equipment that needs to be returned, follow the instructions included in your 'Information Pack' now.

Problems?

- If you experience any problems installing your equipment, refer to the Troubleshooting section in the Operating Guide supplied with the machine.
- If you want to configure the scale to more closely match your personal requirements, refer to the section 'Changing/Selecting Setup Options' in the Operating Guide.
- Installation help and other useful information is available on our support web site at:

<http://www.pitneybowestsg.com/public/cinstall.htm>

- You can also telephone one of our specialists for advice on:

09068 181 181

Calls are charged at 60p per minute



The Pinnacles, Harlow,
Essex, CM19 5BD

Free Manuals Download Website

<http://myh66.com>

<http://usermanuals.us>

<http://www.somanuals.com>

<http://www.4manuals.cc>

<http://www.manual-lib.com>

<http://www.404manual.com>

<http://www.luxmanual.com>

<http://aubethermostatmanual.com>

Golf course search by state

<http://golfingnear.com>

Email search by domain

<http://emailbydomain.com>

Auto manuals search

<http://auto.somanuals.com>

TV manuals search

<http://tv.somanuals.com>