



PXL2471MW
LED LCD Monitor

USER'S GUIDE

www.planar.com

Content

Operation Instructions.....	1
Unpacking Instructions	3
Safety Precautions	3
Package Overview	5
First Setup.....	6
Front View of the Product	7
Rear View of the Product	8
Quick Installation	9
Basic Operation and Calibration/Reset Instructions.....	10
Advanced Operation—OSD Menu.....	12
About the Stand	15
Supporting Timing Modes	16
Technical Information	17
Wall-Mount Installation Instructions	18
Troubleshooting.....	19
Planar Support	20

Operation Instructions

Thank you for purchasing the PXL2471MW LED LCD monitor. Please read this guide thoroughly before installation.

FCC RADIO FREQUENCY INTERFERENCE STATEMENT

WARNING: (FOR FCC CERTIFIED MODELS)

This LED LCD Monitor has been tested and found compliant with the limits for a Class B digital device, pursuant to part 15 of the FCC Rules. These limits are designed to provide proper protection against harmful interference to a residential installation. This LED LCD Monitor generates, uses, and can radiate radio frequency energy. Harmful interference to radio communication may be the result if it's not properly installed and used. However, there is no guarantee that interference will not occur in a particular installation. If this LED LCD Monitor does cause serious interference to radio or television reception, resetting may correct it. Moreover, users are encouraged to reduce interference by doing one or more of the following:

- Reorient or relocate the receiving antenna.
- Move the LED LCD Monitor and the receiver further away from each other.
- Connect the LED LCD Monitor into an outlet on a circuit different from that to which the receiver is connected.
- Consult your local dealer or a qualified technician.

FCC Warning:

To assure a continued FCC compliance, a user must use a grounded power supply cord and the provided shielded video interface cable with bonded ferrite cores. Also, any unauthorized changes or modifications to this LED LCD Monitor would void the user's authority to operate this device.

Note: If necessary, shielded interface cables and AC power cord must be used to meet the emission level limits.



According to WEEE regulation, this LED LCD Monitor can't be handled as normal trash in Europe when it is out of usage. Please refer to the recycle information on Planar's website to handle it.

For more information on how to recycle your product, please visit <http://www.planar.com/about/green/>

COMMUNIQUE D'AVERTISSEMENT DE LA FCC CONCERNANT LES INTERFERENCE DE FREQUENCE RADIO: (SEULEMENT POUR MODELES CERTIFIE PAR LA FCC)

Ce moniteur a été testé et à été trouvé conforme aux limites pour un appareil numérique de Classe B, suivant la partie 15 des règlements de la FCC. Ces limites ont été développées pour offrir une protection satisfaisante contre les interférences nuisibles dans une installation résidentielle. Ce moniteur génère, utilise et peut radier de l'énergie de fréquence radio. Ceci peut causer des interférences nuisibles à des communication radio si l'appareil n'est pas convenablement installé et utilisé. Il n'y a néanmoins aucune garantie que des interférences n'apparaîtront pas dans une installation particulière. Si ce moniteur cause de sérieuses interférences à la réception de signaux radios ou télévisées, une possibilité est de réinitialiser le moniteur. Les usagers sont aussi encouragés à corriger les interférences en appliquant une ou plusieurs des démarches suivantes:

- Réorientez ou déplacez l'antenne de réception.
- Placez le moniteur et le récepteur plus loin l'un de l'autre.
- Connectez le moniteur à une prise différente de celle à laquelle le récepteur est connecté.
- Consultez votre revendeur local ou un technicien qualifié.

Avertissement de la FCC:

Pour assurez une conformité continue au règlements de la FCC, l'utilisateur doit utiliser un cordon d'alimentation mis à terre et le câble d'interface vidéo protégé avec noyaux en ferrite, fourni avec l'appareil. Chaque modification ou changement non-autorisé appliqué à ce moniteur peut faire perdre à l'utilisateur sont droit d'opération de cet appareil.

Note: Si nécessaire, des câbles d'interface protégés et un cordon d'alimentation alternante doivent être utilisé pour être conforme aux limites d'émission.

Unpacking Instructions

- Remove the LED LCD Monitor out of the package and take off the plastic bag and Polystyrene Foam.
- Remove base from plastic bag and attach to base.
- Adjust the display between -5° and 15°.

Safety Precautions

Follow all warnings, precautions and maintenance as recommended in this user's manual to maximize the life of your unit.

Do:

- Turn off the product before cleaning.
- Surface may be cleaned using a soft clean cloth moistened with mild window glass commercial cleaners or 50/50 mixture of water and isopropyl alcohol.
- Use a soft cloth moistened with mild detergent to clean the display housing.
- Disconnect the power plug from AC outlet if the product is not going to be used for an extended period of time.

Don't:

- Do not touch the LED display screen surface with sharp or hard objects.
- Do not use abrasive cleaners, waxes or solvents for your cleaning.
- Do not operate the product under the following conditions:
 - Extremely hot, cold or humid environment.
 - Areas susceptible to excessive dust and dirt.
 - Near any appliance generating a strong magnetic field.
 - In direct sunlight.
- If smoke, abnormal noise or odor emits from your LED LCD Monitor, remove the power cord immediately and call your service center.
- Never remove the rear cover of your LED LCD Monitor. The display unit inside contains high-voltage parts and may cause electric shock.
- Never try to repair your LED LCD Monitor yourself. Always call your service center or a qualified technician to fix it.
- Due to safety concerns, if the VESA mounting kit is purchased separately, please make sure the mounting kit is UL-listed, and replaceable only by service personnel.

Consignes de sécurité

Respectez tous les avertissements, les précautions et conseils d'entretien recommandés dans ce manuel de l'utilisateur pour maximiser la durée de vie de votre appareil.

A faire :

- Éteindre le produit avant de le nettoyer.
- La surface de l'écran tactile peut être nettoyée avec un chiffon doux et propre imprégné d'un nettoyant doux du commerce pour vitres ou d'un mélange à 50/50 d'alcool isopropylique et d'eau.
- Utilisez un chiffon doux imprégné d'un détergeant doux pour nettoyer le carter de l'affichage.
- Débranchez la fiche d'alimentation de la prise de courant secteur si le produit ne doit pas être utilisé pendant une période prolongée.

A ne pas faire :

- Ne touchez pas la surface de l'écran LED avec des objets coupants ou durs.
- N'utilisez pas des produits de nettoyage abrasifs, de la cire ou des solvants pour le nettoyage.
- N'utilisez pas le produit dans les conditions suivantes :
 - Environnement extrêmement chaud, froid ou humide.
 - Endroits poussiéreux ou sales.
 - Près d'appareils générant un fort champ magnétique.
 - Sous la lumière directe du soleil.
- Si de la fumée, un bruit anormal ou une odeur s'échappait de votre moniteur LCD LED, débranchez immédiatement le cordon d'alimentation et appelez votre centre de réparation.
- Ne retirez jamais le couvercle arrière de votre moniteur LCD LED. L'unité d'affichage contient des éléments où circule un voltage élevé et présentant un risque d'électrocution.
- N'essayez jamais de réparer vous-même votre moniteur LCD LED. Faites toujours appel à votre centre de service ou à un technicien qualifié pour toute réparation.
- Pour des raisons de sécurité, si vous achetez séparément le kit de fixation VESA, assurez-vous que celui-ci est certifié UL, et qu'il peut être remplacé uniquement par un technicien qualifié.

Package Overview

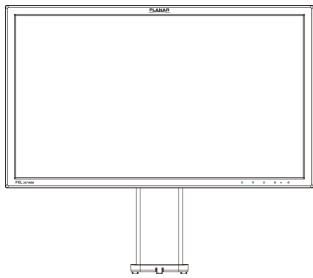

LED LCD Monitor

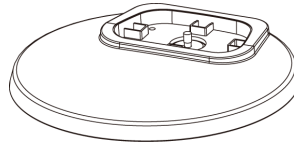

Base

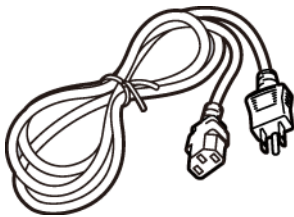

Power Cord

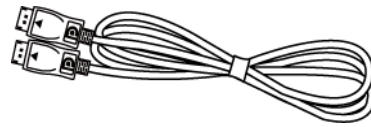

VGA Cable

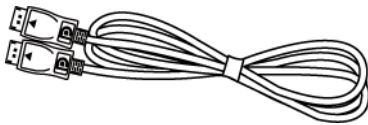

Display Port Cable



Audio Cable



User's Guide

First Setup

Install the stand base

1. Lay the LED LCD Monitor flat on a table with the LED screen face down. To prevent the LED LCD Monitor from being scratched, put a piece of soft cloth on the table on which the screen will be set.
2. Unpack the base, one hand hold the monitor, the other hand to pivot the stand.
3. Turn the screw clockwise to attach the base to the monitor.
4. Stand the LED LCD Monitor up.

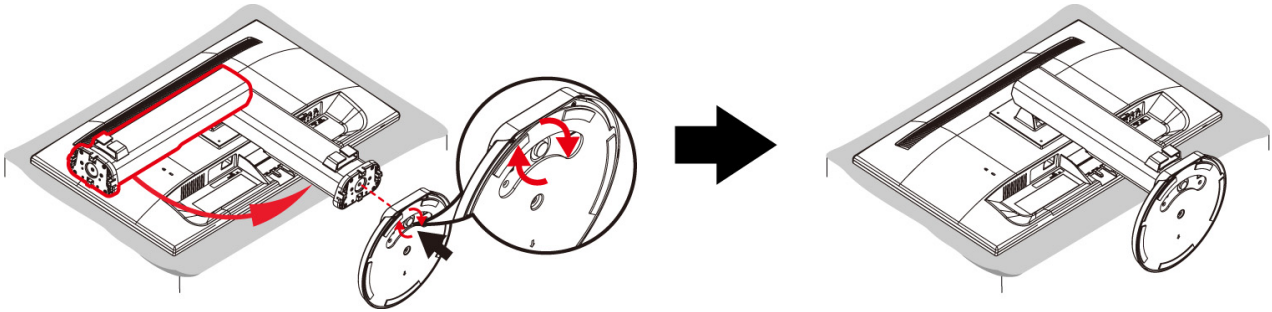

Disconnecting the stand base

1. Lay the LED LCD Monitor flat on a table with the LED screen face down. To prevent the LED LCD Monitor from being scratched, put a piece of soft cloth on the table on which the screen will be set.
2. Hold the monitor down with one hand. With the other hand, turn the screw counterclockwise to remove the screw that holding your monitor to the base.
3. Remove the base from the stand.

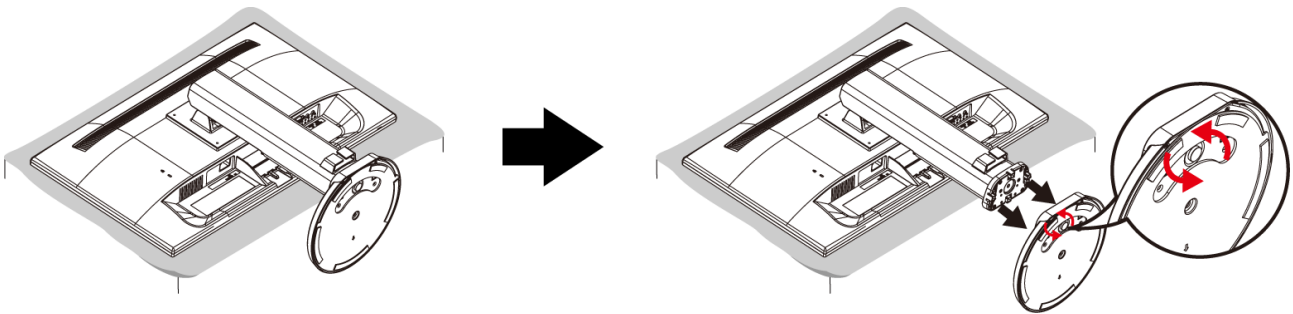

Front View of the Product

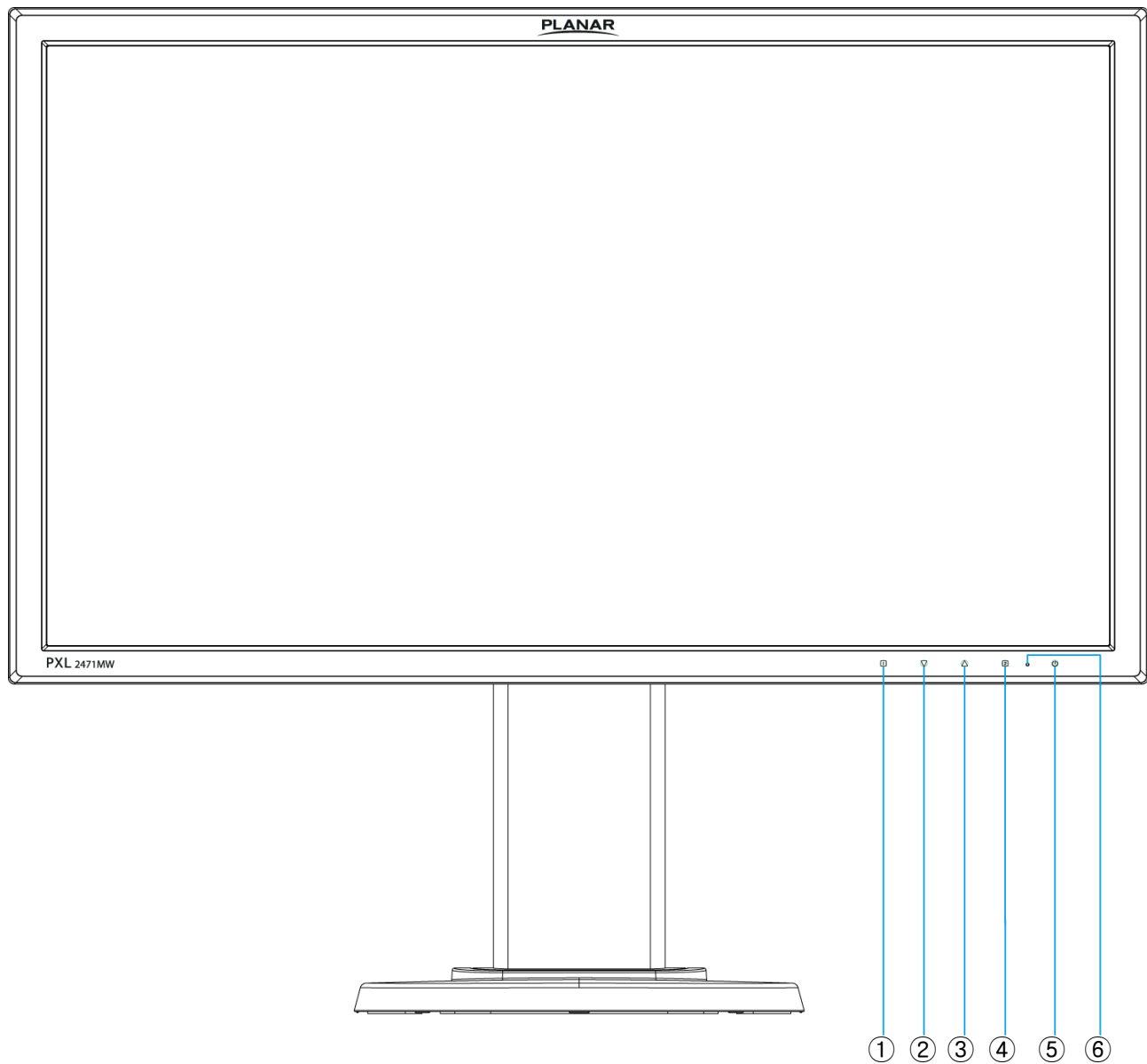

①	OSD Turn On/ Off
②	Scroll Down/ Adjust Decrease/ Audio Adjust/ Auto *
③	Scroll UP/ Adjust Increase/ Picture Mode *
④	Input select/ Confirm Selection
⑤	Power On/ Off
⑥	LED Indicator

* Hot keys Instructions please see "Using the OSD Menu" on page 10.

Rear View of the Product

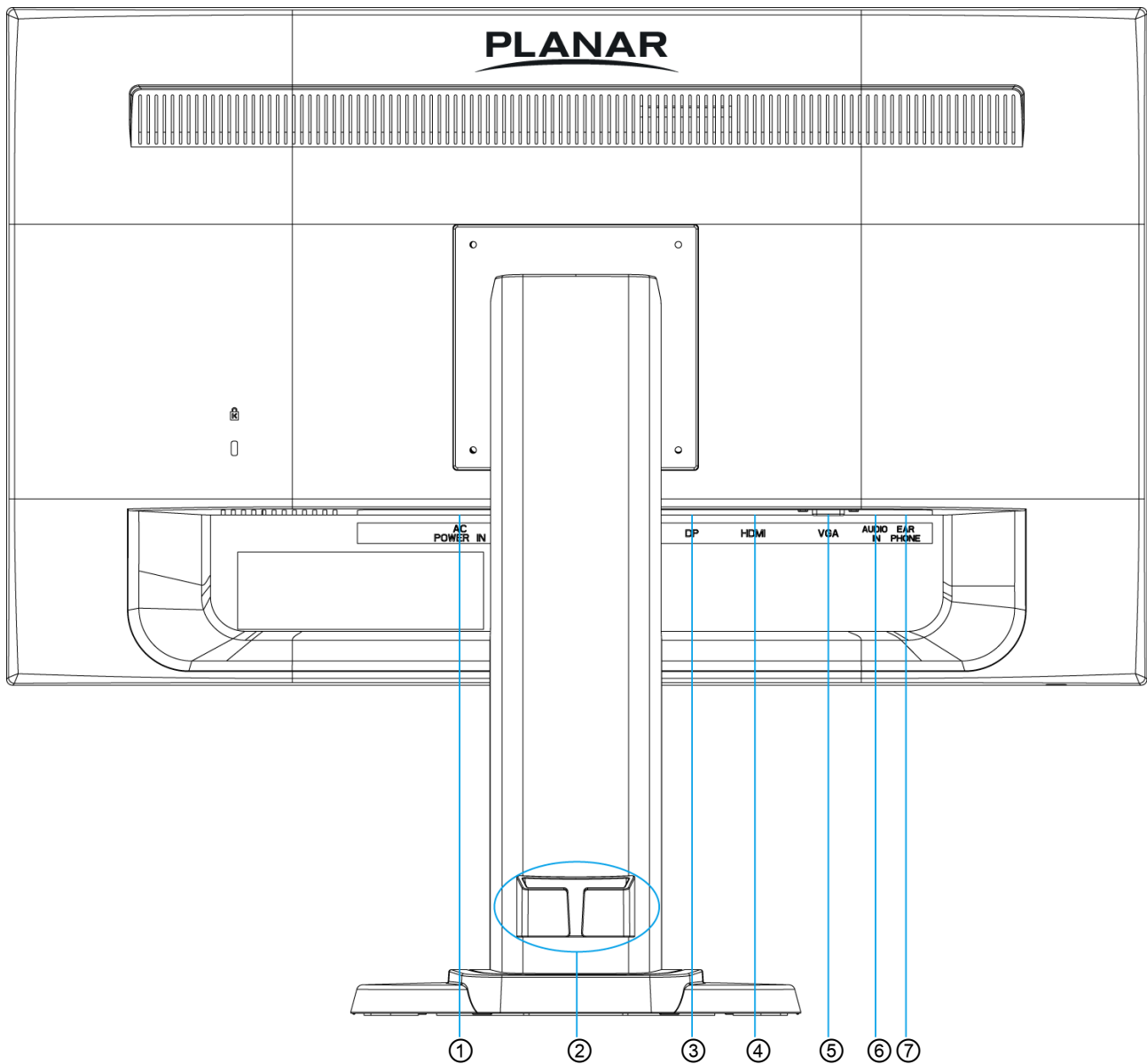

①	Power Input
②	Cable Management
③	DisplayPort Input (DisplayPort 20 pin)
④	HDMI input (HDMI 19 pin)
⑤	VGA Input (D-Sub 15 pin)
⑥	Audio Input
⑦	Headphone Jack

Quick Installation

1. Connect either VGA, HDMI or DisplayPort Video Source from the monitor to the computer. Make sure both monitor and computer are powered OFF. Please note. The monitor ships with DisplayPort and HDMI cables only. VGA cable may be sourced separately from a cable supplier.
2. Connect the audio cable from audio output of computer to the audio input of the monitor.
3. Connect the earphone to the earphone output terminal of the monitor. (Earphone sold separately).
4. Connect power cord to a properly grounded AC outlet, and then to the monitor.
5. Power-ON computer and then POWER-ON the monitor.
6. Set the timing mode on your computer. Recommended resolution and refresh rate is 1920 x 1080 @ 60Hz.

Figure:

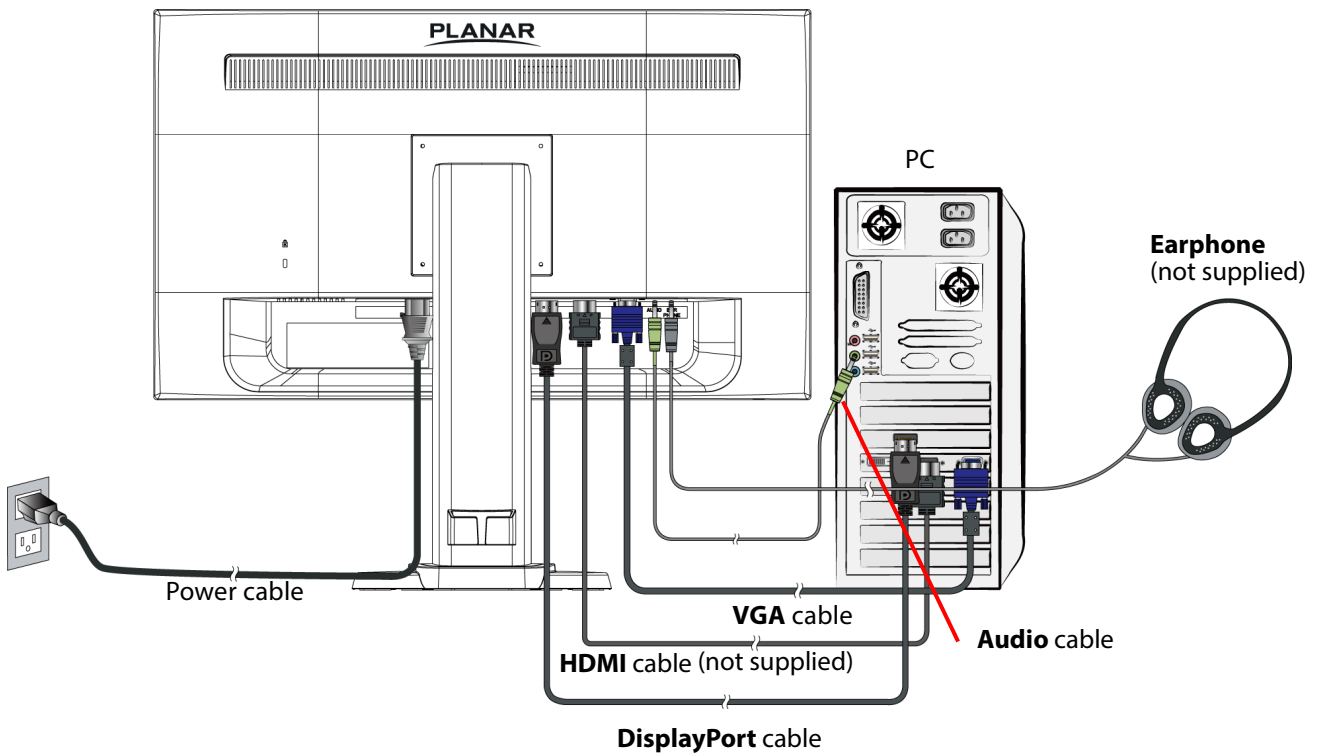

Basic Operation and Calibration/Reset Instructions

Before using the LED LCD Monitor:

- Connect external equipment properly.
- Insert the power plug, and the power LED indicator will light orange.

Power On/Off

To turn the LED LCD Monitor on/off:

Press  button on the front. The power LED indicator light will be blue when the LED LCD Monitor is on.

Using the OSD Menu

Use OSD menus to adjust settings by using the menu button on the front of the LED LCD Monitor.

1	Displays main menu
	Exits from OSD menu
2	Selects between VGA, HDMI, DisplayPort or Auto mode
▼	Select the desired item when in OSD menu
	When not in OSD menu, directly enters Audio Adjust menu, press 3 seconds activates Auto Image Adjust.
▲	Select the desired item when in OSD menu
	When not in OSD menu, directly enters Picture Mode
▼ + ▲	Recalls both Contrast and Brightness (when not in OSD menu)

OSD Lock Out Function

When LED LCD Monitor is in normal mode, the “OSD Lock Out” function can be enabled.

Option 1: OSD lock – all 4 buttons are locked except the “POWER” button.

Press and hold the  button and the ▲ button for 3 seconds to lock the OSD buttons.

The LED LCD Monitor will show an “OSD Locked” message for 3 seconds and the message will disappear automatically.



OSD LOCKED

Repeat this step to unlock.

Option 2: OSD & Power button lock – all 5 buttons including the “POWER” button are locked. Press and hold the  button and the ▼ button for 3 seconds to lock all 5 buttons.

The LED LCD Monitor will show a “Power Button Locked” message for 3 seconds and the message will disappear automatically.



POWER BUTTON LOCKED

Repeat this step to unlock.

Advanced Operation—OSD Menu

You can use the OSD menu to adjust various settings for your LED LCD Monitor.

Press the  button to display the OSD Menu, and use ▲ or ▼ to select the desired OSD menu.

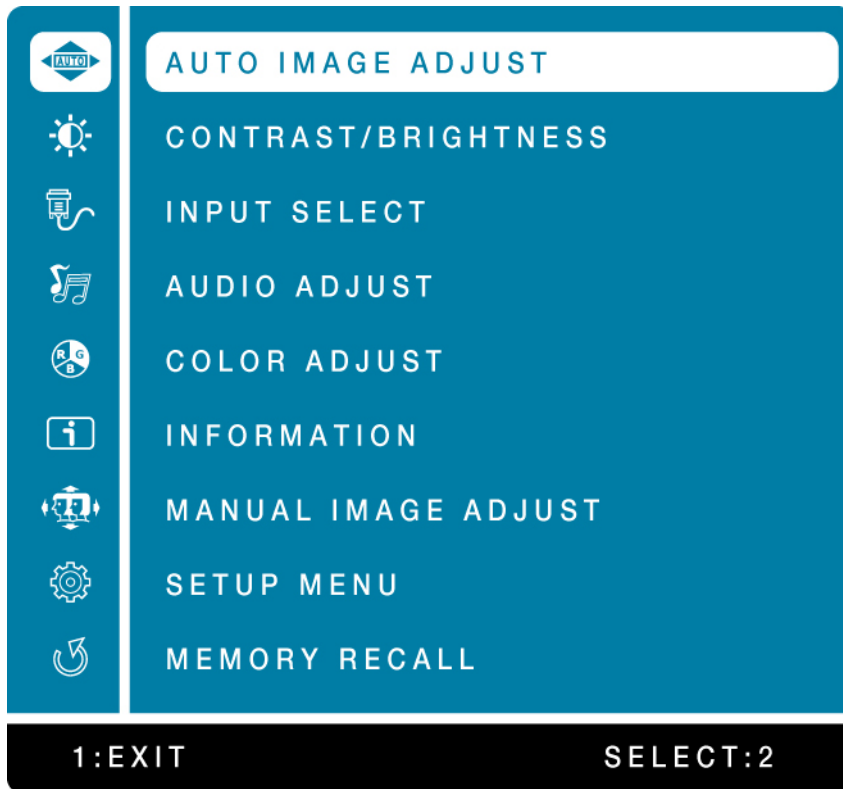

Short Cuts Function from the button(s)



AUTO IMAGE ADJUST: To auto adjust Horizontal Position, Vertical Position, Phase (Fine Tune) and Clock (H. Size) of the screen.



CONTRAST: To adjust the foreground white level of screen image.

▲: increase contrast, ▼: decrease contrast.

BRIGHTNESS: To adjust the luminance of the video.

▲: increase brightness, ▼: decrease brightness.

ECO MODE: Allows the user to change the ECO mode. Contrast and Brightness adjustment will be disabled when ECO is active.

Press ▲ or ▼ key to adjust the ECO Mode in three levels.

OVER DRIVE: Allows the user to change the Over Drive strength. Improve the quality of the motion pictures.

Press ▲ or ▼ key to adjust the Over Drive strength in five levels.



INPUT SELECT: When Input Select is pressed, change Input signal to VGA, HDMI, DISPLAY PORT or AUTO.



AUDIO ADJUST: To adjust the audio functions.

VOLUME: To adjust the volume of speaker output.

MUTE: To turn the Mute ON/OFF.

AUDIO INPUT: When in HDMI input, select where the audio source comes from AUDIO IN or HDMI. When in DisplayPort input, select where the audio source comes from AUDIO IN or DP.



COLOR ADJUST: To select the color for improving brightness and color saturation between COOL, NORMAL, WARM, USER COLOR, and PICTURE MODE.



COOL: Adds blue to screen image for cooler white.

NORMAL: Adds red to screen image for warmer white and richer red.

WARM: Adds green to screen image for a darker color.

USER COLOR: Individual adjustments for red (R), green (G), blue (B).

1. Press button  to select the desired color.

2. Press  or  button to adjust selected color.

PICTURE MODE: Provides an optimum display environment depending on the content displayed. It contains 5 user-selectable presets.

- **STANDARD** is for general windows environment and monitor default setting.
- **GAME** optimized for PC game environment.
- **CINEMA** optimized for movie and video environment.
- **SCENERY** optimized for displaying outdoor scenery images.
- **TEXT** optimized for text editing and viewing in a word processing environment.



INFORMATION: To display the information, regarding the current input signal coming from the graphic card in your computer.

Note: See your graphic card user guide for more information about changing the resolution and refresh rate.



MANUAL IMAGE ADJUST: To manually adjust the H./V. POSITION, HORIZONTAL SIZE, FINE TUNE, SHARPNESS and VIDEO MODE ADJUSTMENT.

H./V. POSITION: To adjust the horizontal and vertical position of the video.

HORIZONTAL POSITION: : move screen to the right, : move screen to the left.



VERTICAL POSITION: : move screen up, : move screen down.

HORIZONTAL SIZE: To adjust the width of the screen image.

: increase the width of screen image, : decrease the width of screen image.

FINE TUNE: To adjust the delay time of data and clock.

Press  or  to adjust to your preference.

SHARPNESS: To adjust the clarity of a non-Full HD Resolution (1920x1080) signal with  or  button.

VIDEO MODE ADJUSTMENT: To select the video mode from FULL SCREEN or ASPECT RATIO.



SETUP MENU: To set up LANGUAGE SELECT, OSD POSITION, OSD TIME OUT, OSD BACKGROUND and LED mode.

LANGUAGE SELECT: To allow users to choose from available languages.

OSD POSITION: Press ▲ or ▼ button to select between horizontal and vertical OSD Position adjustment.

HORIZONTAL POSITION: To horizontally adjust the OSD position.

▲: move OSD to the right, ▼: move OSD to the left.

VERTICAL POSITION: To vertically adjust the OSD position.

▲: move OSD up, ▼: move OSD down.

OSD TIME OUT: To automatically turn off On Screen Display (OSD) after a preset period of time.

OSD BACKGROUND: Allows the user to turn the OSD background On or Off.

LED: Allows the user to turn the LED Indicator On or Off.



MEMORY RECALL: To recall factory settings for Video & Audio controls. Press button **2** to select the Memory Recall menu option.

About the Stand

The stand allows you to easily adjust the height, swivel, tilt, and portrait mode of your monitor to provide maximum ergonomic comfort.

1) Height adjustment

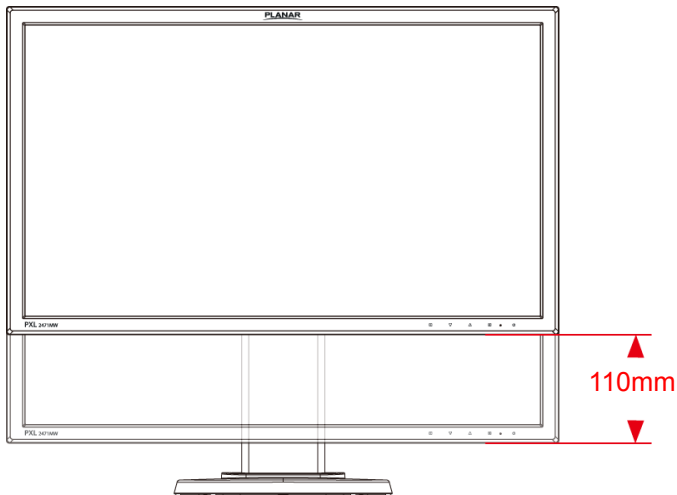

2) Swivel

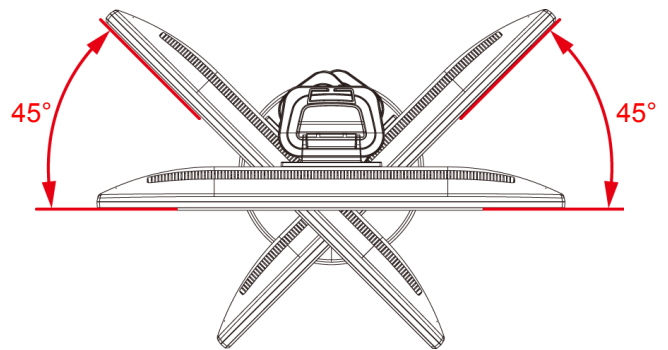

3) Tilt

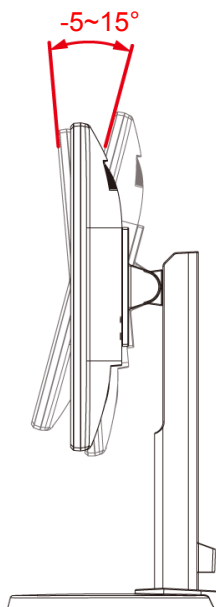

4) Pivot

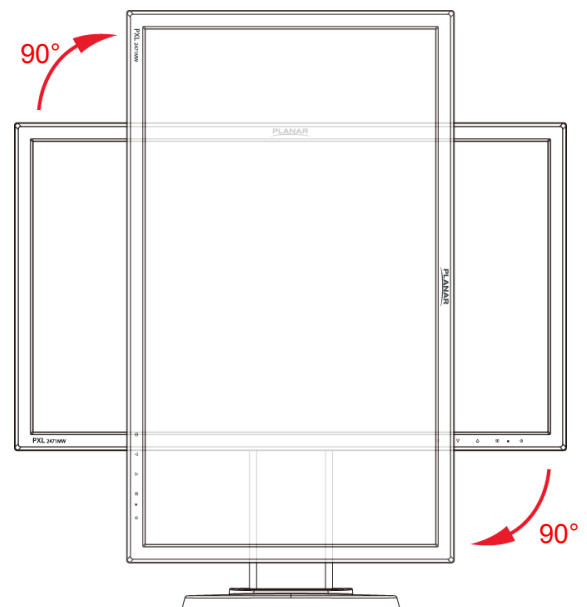

Supporting Timing Modes

STANDARD	RESOLUTION
VGA	720 x 400 @ 70Hz
VGA	640 x 480 @ 60Hz
MAC	640 x 480 @ 67Hz
VESA	640 x 480 @ 72Hz
VESA	640 x 480 @ 75Hz
VESA	800 x 600 @ 56Hz
VESA	800 x 600 @ 60Hz
VESA	800 x 600 @ 72Hz
VESA	800 x 600 @ 75Hz
MAC	832 x 624 @ 75Hz
VESA	1024 x 768 @ 60Hz
VESA	1024 x 768 @ 70Hz
VESA	1024 x 768 @ 75Hz
VESA	1280 x 960 @ 60Hz
VESA	1152 x 864 @ 75Hz
MAC	1152 x 870 @ 75Hz
VESA	1280 x 1024 @ 60Hz
VESA	1280 x 1024 @ 75Hz
VESA	1440 x 900 @ 60Hz
VESA	1440 x 900 @ 75Hz
CVT	1400 x 1050 @ 60Hz
VESA	1600 x 1200 @ 60Hz
VESA	1680 x 1050 @ 60Hz
VESA	1920 x 1080 @ 60Hz

Note:

1. HDMI and DisplayPort supports 480i, 480p, 576i, 576p, 720p, 1080i, and 1080p.
2. Simultaneously press **1** and **2** keys on monitor panel to switch between similar PC timings.

Similar PC Timing on list below:

- 640 x 350 @ 70Hz / 640 x 400 @ 70Hz / 720 x 400 @ 70Hz
- 640 x 480 @ 60Hz / 720 x 480 @ 60Hz
- 1400 x 1050 @ 60Hz / 1680 x 1050 @ 60Hz
- 1440 x 1050 @ 75Hz / 1680 x 1050 @ 75Hz

Warning: Do not set the graphic card in your computer to exceed these maximum refresh rates. Doing so may result in permanent damage to your LED LCD Monitor.

Avertissement : Ne réglez pas la carte graphique de votre ordinateur en dépassant ces taux de rafraîchissement maximaux. Si vous le faites, cela va irrémédiablement détériorer votre moniteur.

Technical Information

Panel	23.6" TFT (with LED backlight)
Power Management	On: 32 Watts (typical), 35 Watts (maximum) Standby Mode: < 0.5 Watt Off: < 0.5 Watt
Displayable Resolution	Full HD 1920 x 1080 max. Vertical Frequency 60Hz max.
Pixel Dimension	0.2715 x 0.2715 mm
Display Color	16.7M
Tilt	-5°~15°
Active Display Area	20.52" x 11.54" (521.28 mm x 293.22 mm)
Temperature	Operating: 0°C ~ +40°C Storage: -20°C ~ + 60°C
Compliance	FCC-B, CE, UL/cUL
Power	Input Voltage AC100-240 V
Audio Output	1W x 2

Wall-Mount Installation Instructions

Preparing to Install the Optional Wall Mount Arm (not included)

This LED LCD Monitor can be attached to a wall mounting arm purchased separately.

Turn the power OFF then disconnect the cables from the LED LCD Monitor before performing the procedure below.

1. Lay the LED LCD Monitor face down on a soft surface.
2. Remove the 4 screws holding the stand to the hinge.
3. Remove the stand.

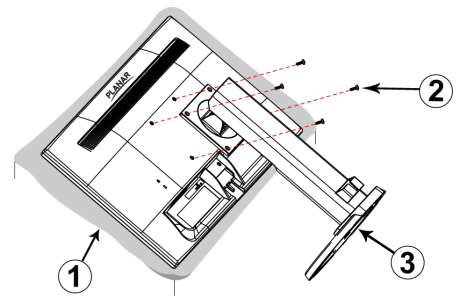

Attaching The Optional Wall Mount Arm (not supplied)

Follow these steps to finish installing the wall mounting arm:

1. Place the wall mounting arm onto the back of the LED LCD Monitor. Line up the holes of the arm with the holes in the back of the monitor.
2. Insert the 4 screws into the holes and tighten.
3. Reconnect the cables. Refer to the User's Guide that came with the optional wall mounting arm for instructions on attaching it to the wall.

NOTE

- 100mmx100mm VESA high hole (n=4), M4, pitch =0.7 mm screw mounting kit not included.

100mm x 100mm Screw
Mounting Options

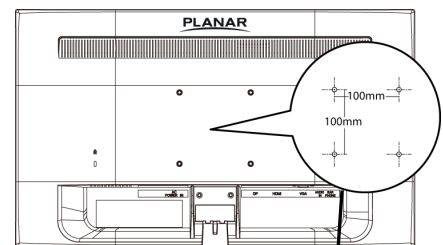

4mm, 0.7 pitch
threaded holes x 4

Troubleshooting

No power

- Make sure A/C power cord is securely connected to the power adapter and the power supply is firmly connected to the LED LCD Monitor.
- Plug another electrical device into the power outlet to verify that the outlet is supplying proper voltage.
- Make sure all signal cables are installed.

Power on but no screen image

- Make sure the video cable supplied with the LED LCD Monitor is tightly secured to the video output port on back of the computer. If not, tightly secure it.
- Adjust brightness.

Wrong or abnormal colors

- If any colors (red, green, blue) are missing, check the video cable to make sure it is securely connected. Loose or broken pins in the cable connector could cause an improper connection.
- Connect the LED LCD Monitor to another computer.

Planar Support

Cables and Accessories

To find cables and accessories for your Planar monitor, touch screen or other Planar products visit our online store at www.PlanarOnline.com.

Technical Support

Visit Planar at <http://www.planar.com/support> for operations manuals, touchscreen drivers, warranty information and access to Planar's Technical Library for online trouble shooting. To speak with Planar Customer Support please have your model and serial number available and dial:

Planar Support

Tel: 1-866-PLANAR1 (866-752-6271) or +1 503-748-5799 outside the US.

Hours: 24 hours a day, 7 days a week.

Toll or long distance charges may apply.

Planar Systems, Inc.

Customer Service

24x7 Online Technical Support: <http://www.planar.com/support>

1195 NW Compton Drive

Beaverton, OR 97006-1992

Tel: 1-866-PLANAR1 (866-752-6271), or +1 503-748-5799 outside the United States,

Hours: 24 hours a day, 7 days a week

©2014 Planar Systems, Inc.

Planar is a registered trademark of Planar Systems, Inc. Other brands and names are the property of their respective owners. Technical information in this document is subject to change without notice.

2001132475T



Free Manuals Download Website

<http://myh66.com>

<http://usermanuals.us>

<http://www.somanuals.com>

<http://www.4manuals.cc>

<http://www.manual-lib.com>

<http://www.404manual.com>

<http://www.luxmanual.com>

<http://aubethermostatmanual.com>

Golf course search by state

<http://golfingnear.com>

Email search by domain

<http://emailbydomain.com>

Auto manuals search

<http://auto.somanuals.com>

TV manuals search

<http://tv.somanuals.com>