



| SA2311W  
3D Ready Monitor

**USER'S GUIDE**

[www.planar3d.com](http://www.planar3d.com)

# Contents

Preface .....	1
Warning.....	1
Safety Precaution.....	3
Installation .....	4
Introduction .....	4
Features .....	4
Unpacking .....	5
Preparing The Monitor For Wall-Mounting .....	6
Screen Position Adjustment .....	8
Connecting Cables .....	9
Settings for Stereoscopic 3D Use .....	10
Display Controls .....	12
Front Panel Controls.....	12
Lock Function .....	13
OSD Operation .....	14
Technical Information .....	16
Specifications .....	16
Supported Timing .....	17
Troubleshooting .....	18
Product Registration and Technical Support .....	19

# Preface

The information contained in this document is subject to change without notice. This document contains proprietary information that is protected by copyright. All rights are reserved. No part of this document may be reproduced, translated to another language or stored in a retrieval system, or transmitted by any means, electronic, mechanical, photocopying, recording, or otherwise, without prior written permission. Windows is registered trademark of Microsoft Inc. Other brand or product names are trademarks of their respective holders.

## FCC Statement Warning

This equipment has been tested and found to comply with the limits for a Class B digital device, pursuant to part 15 of the FCC Rules. These limits are designed to provide reasonable protection against harmful interference in a residential installation. This equipment generates, uses, and can radiate radio frequency energy, and if not installed and used in accordance with the instruction, may cause harmful interference to radio communications. However, there is no guarantee that interference will not occur in a particular installation. If this equipment does cause harmful interference to radio or television reception, which can be determined by turning the equipment off and on, the user is encouraged to try to correct the interference by one or more of the following measures:

- Reposition or relocate the receiving antenna.
- Increase the separation between the equipment and the receiver.
- Connect the equipment into an outlet on a circuit different from that to which the receiver is connected.
- Consult the dealer or an experienced monitor technician for help.

## Warning

Use only shielded signal cables to connect I/O devices to this equipment. You are cautioned that changes or modifications not expressly approved by the party responsible for compliance could void your authority to operate the equipment.

This device complies with part 15 FCC Rules. Operation is subject to the following two conditions(1) This device may not cause harmful interference. (2) This device must accept any interference received, including interference that may cause undesired operation.

## Canadian DOC Notice



This Class B digital apparatus meets all requirements of the Canadian Interference-Causing Equipment Regulations.

Cet appareil numérique de la classe B respecte toutes les exigences du Règlement sur le matériel

## Important Recycle Instruction:



Lamp(s) inside this product contain mercury. This product may contain other electronic waste that can be hazardous if not disposed of properly. Recycle or dispose in accordance with local, state, or federal Laws. For more information, contact the Electronic Industries Alliance at [WWW.EIAE.ORG](http://WWW.EIAE.ORG). For lamp specific disposal information check [WWW.LAMPRECYCLE.ORG](http://WWW.LAMPRECYCLE.ORG).

Contains Mercury, Dispose of Properly



## **Safety Precautions**

Avoid placing the monitor, or any other heavy object, on the power cord to prevent it from fire or electrical shock.

Do not expose the monitor to rain, excessive moisture, or dust to avoid fire or shock hazard.

Do not cover the slots or openings of the monitor for proper heat dissipation.

Always put the monitor in a place where there is adequate ventilation.

For optimal viewing avoid placing the monitor against a bright background or where sunlight or other light sources may reflect on the face of the monitor. Place the monitor just below eye level.

Handle with care when transporting the monitor.

Do not touch the screen except when lightly cleaning it with a soft cloth.

For some individuals, prolonged use of a stereoscopic monitor may cause discomfort. Take a break from stereo viewing if you sense eye fatigue or other symptoms. Individuals who are unaccustomed to using stereoscopic 3D monitors may require a period of adaptation.

## **Cleaning Your Monitor**

Please carefully follow the guidelines below when cleaning the monitor.

Always unplug the monitor before cleaning.

Use a soft cloth to wipe the screen and cabinet front and sides.

## **About Power Cable**

Check first to make sure that the power cord you use is the correct type required for your area.

This monitor has a universal power supply that allows operation in either 100/120V AC or 220/240 V AC voltage area. No user-adjustment is required.

Plug one end of the power cord to the AC Inlet, plug another end to a proper AC outlet.

For unit using at 120 V AC: Use a UL Listed Cord Set, Type SVT wire and plug rated 10 A/125 V.

For unit using at 220/240 V AC (outside of U.S.): Use a Cord Set consisting of H05VV-F cord and plug rated 10 A, 250 V. The cord set should have the appropriate safety approvals for the country in which the equipment will be installed.

# Installation

## Introduction

Congratulations on your purchase of the SA2311W high performance LCD monitor. This 23-inch wide-format monitor is 3D ready with full HD resolution for both professional and entertainment use.

## Features

- \* 23" TFT Color LCD monitor
- \* 16:9 Widescreen
- \* Full HD 3D functionality
- \* NVIDIA 3D vision™ certified
- \* Recommended resolution: 1920 x 1080 @ 60Hz
- \* Direct analog signal input
- \* Direct digital signal input
- \* Direct HDMI signal input
- \* Auto adjustment function
- \* OSD user control
- \* Kensington security slot
- \* 100mm VESA mount
- \* Compact, space saving, sleek cabinet design
- \* Height adjustable stand with tilt and swivel

# Unpacking

Please check that the following items are present when you unpack the box.  
We recommend you save the packaging for future use.

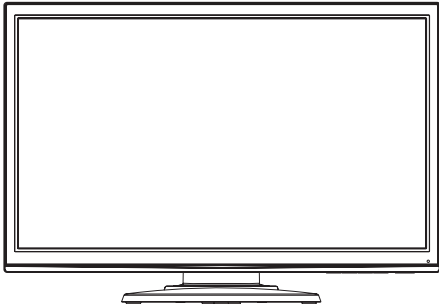

LCD Monitor



User Guide



AC Power Cord



15-pin D-Sub Cable



DVI Cable

## Preparing The Monitor For Wall-Mounting

1. Lay the LCD monitor on a flat surface with the LCD screen face down.  
To prevent the monitor from being scratched, put a soft cloth on the table.
2. Use a screw driver to release the four screws from the stand pedestal as below.

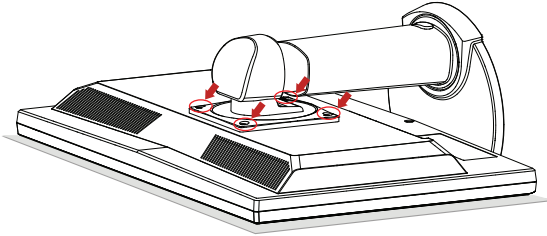

3. Take the stand away from the monitor head.

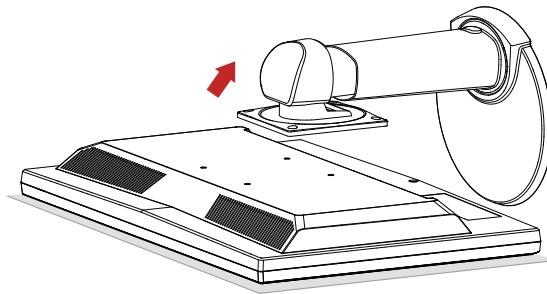

4. Check the stability of the wall-mounting fixture.



5. The rear of this LCD display has 4 integrated 4 mm, 0.7 pitches threaded nuts.

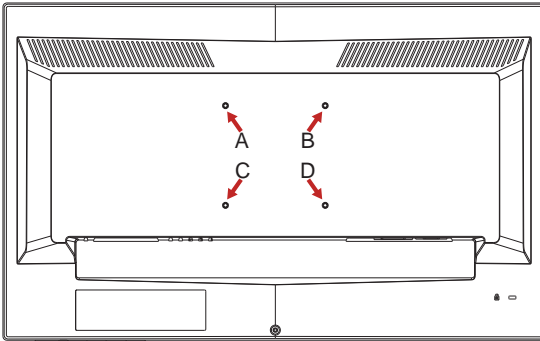

Use the four holes (A), (B), (C), and (D) to attach the swing arm or other mounting fixture to the back of the monitor with screws (not supplied).

**Note:** The wall-mount uses the 100mm x 100mm spacing standard.  
Please use M 4mm x 10mm (L) Screw for this application.

6. Follow the instructions included with the mounting fixture to ensure that the monitor is safely attached.

The four threaded holes that are on the back of the panel are compliant with the VESA standard for mounting flat-panel monitors.

7. Attach a swing arm or other mounting fixture.

## Screen Position Adjustment

In order to optimize the best viewing position, you can adjust the monitor as shown in the figures below.

### Height adjust

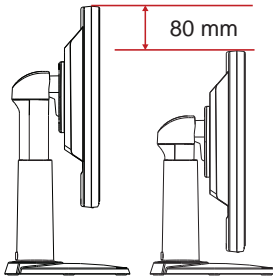

### Tilt

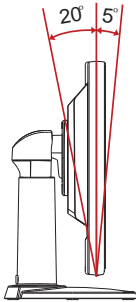

### Swivel

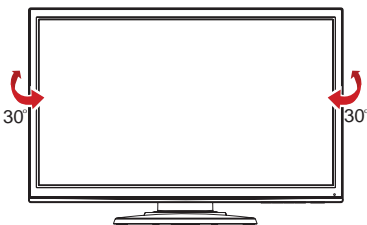

## Connecting Cables

To connect the monitor to your PC, please follow the steps as given below:

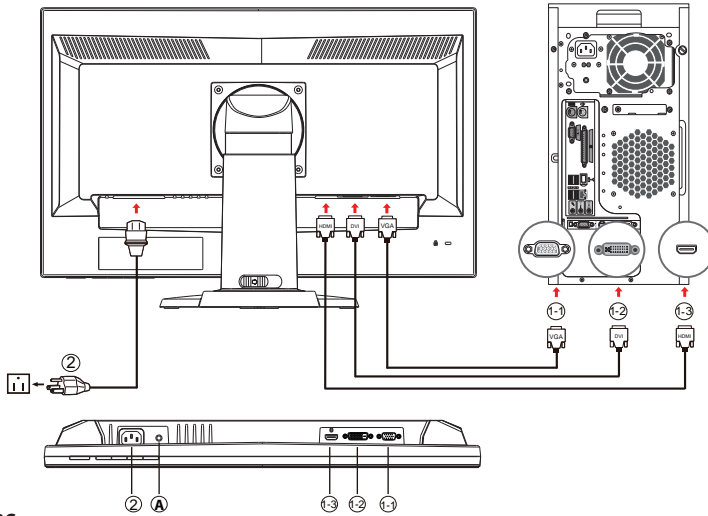

### Steps

1. Connect one of the cables: VGA, DVI or HDMI.  
Make sure both the monitor and computer are turned off.
  - 1-1. Connect VGA Cable  
Connect the blue VGA video cable to the computer.
  - 1-2. Connect DVI Cable  
Connect the white DVI cable to the computer.
  - 1-3. Connect HDMI Cable  
Connect the black HDMI cable to the computer.
2. Connect power cord  
Connect the power cord to the monitor, then to a properly grounded AC outlet.
3. Turn on the monitor and computer  
Turn on the monitor first, then turn on the computer.  
This sequence is very important.
4. If the monitor still does not function properly, please refer to the troubleshooting section to diagnose the problem.

Note: There is also a audio jack labeled "A" which allows you to connect the external headphone or speakers when the input source is HDMI.

## Settings for Stereoscopic 3D Use

Below are the requirements for stereoscopic 3D viewing:

1. Planar SA2311W 3D Ready Monitor with dual link DVI cable.
2. PC with compatible NVIDIA® graphics card. See [http://www.nvidia.com/object/quadro\\_pro\\_graphics\\_boards.html](http://www.nvidia.com/object/quadro_pro_graphics_boards.html) for compatible Quadro® cards and drivers used for professional applications. See [www.nvidia.com/3dvision](http://www.nvidia.com/3dvision) for full list of supported cards for games. Install the latest version of the 3D Vision® USB driver for the appropriate graphics card.
3. For professional applications, use either the 32-bit or 64-bit versions of Microsoft® Windows® XP, Vista, Windows 7 or Linux pre-installed on your computer. For games, use either the 32-bit or 64-bit versions of Microsoft Windows Vista or Windows 7.
4. NVIDIA 3D Vision (or 3D Vision Pro) kit which includes 3D glasses, a wireless transmitter and advanced software.



5. Professional software that supports OpenGL stereo or NVIDIA's 3D Stereoscopic drivers.

Alternatively, visit [www.nvidia.com/3dvision](http://www.nvidia.com/3dvision) for a full list of supported games.

For the Quadro graphics cards, go to the nVidia Control Panel and enable stereo in the "Manage 3D Settings" tab.

When connecting the 3D Vision Ready monitor:

- For boards with the stereo connector, select "On-board DIN connector (with NVIDIA IR Emitter)" and plug in the 3 pin mini-din to 1/8" stereo cable that came with your 3D Vision glasses kit.
- For boards without the mini-din select "Generic Active Stereo (with NVIDIA IR Emitter)."

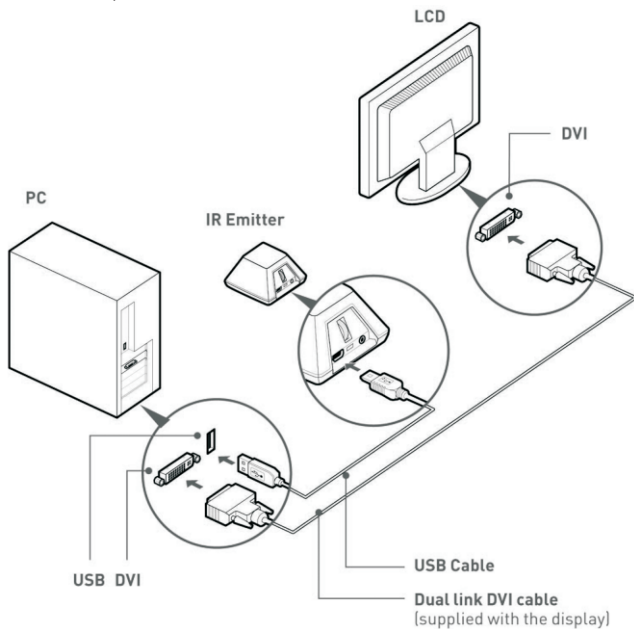



**Note:** Make sure the display refresh rate is set at 110Hz or 120Hz.

# Display Controls

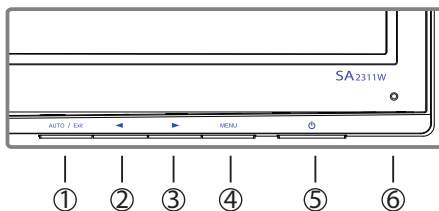
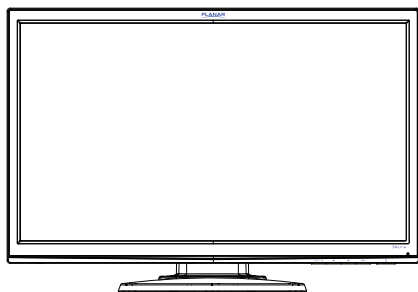
## Front Panel Controls



Icon	Description
1 <b>AUTO / Exit</b>	Auto adjust screen display . Press 5 seconds to auto detect the input source or manually select the input source. Exit from the present OSD menu.
2 	Backward selection of the OSD menu. Decrease the value after sub-menu selected.
3 	Forward selection of the OSD menu. Increase the value after sub-menu selected.
4 <b>MENU</b>	Displays the OSD menu on the screen. Selects the OSD sub-menu.
5 	Turns the monitor on or off .
6 <b>Power LED</b>	Lights up to indicate the power status.

## OSD Lock Function

OSD lock – all 4 buttons are locked except the “POWER” button.

When monitor is in normal condition, press the “Menu” and “◀” buttons more than 10 seconds to lock the OSD function.

Repeat this step to unlock the OSD.

The monitor will show the “OSD Lock” or “OSD Unlock” message for 3 seconds and it will disappear automatically.

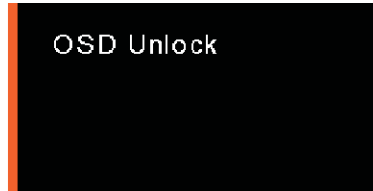
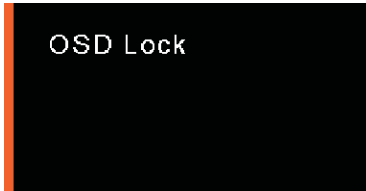

## Power Lock Function

Only Power button is locked.

When monitor is in normal condition, hold “MENU” and “▶” button more than 10 seconds to lock the power keys’ function.

Repeat this step to unlock.

The monitor will show the “Power Lock” or “Power Unlock” for 3 seconds and it will disappear automatically.

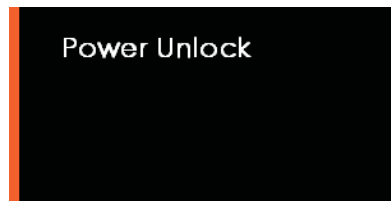
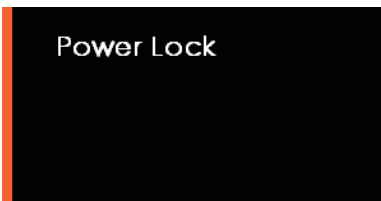

## OSD Operation



Pressing the MENU button brings up the first level menu. This menu button is also used to enter the sub-OSD menu .

Picture	Item	Content
	<b>Brightness</b>	Adjusts brightness.
	<b>Contrast</b>	Adjusts contrast.
	<b>H. position</b>	Adjusts picture's horizontal position.
	<b>V. position</b>	Adjusts picture's vertical position.
	<b>Phase</b>	Adjusts phase to reduce horizontal line noise.
	<b>Clock</b>	Adjusts clock to reduce vertical line noise.
	<b>Color Temp</b>	Adjusts to different color temperatures (6500/7500/9300/User).
	<b>Auto Adjust</b>	Automatically adjusts all image parameters to optimal settings.

OSD	Item	Content
	<b>OSD Timeout</b>	Adjusts how long OSD menu remains open.

Display	Item	Content
	<b>Display Mode</b>	Expands image to full screen or 4:3.
	<b>Opticolor</b>	Selects different color modes.
	<b>ECO</b>	If on, sets the monitor to a decreased backlight value.
	<b>Sharpness</b>	Adjusts clarity and sharpness.
	<b>OD</b>	Enhances gray level response time.

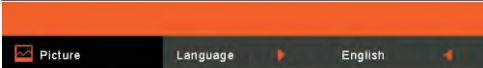
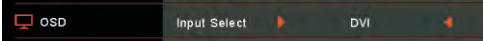
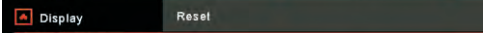
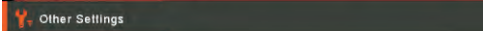
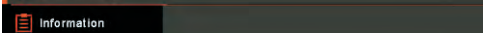
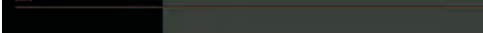
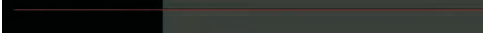
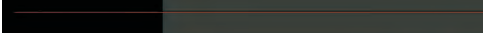

Other Settings	Item	Content
	<b>Language</b>	Select different languages of the OSD.
	<b>Input Select</b>	Select the input source for VGA, DVI or HDMI.
	<b>Reset</b>	Resets monitor to original settings.
		
		
		
		
		
		

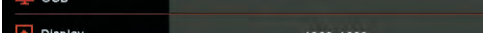
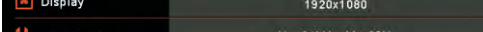
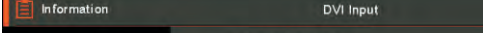
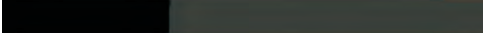
Information	Content
	
	
	
	
	Shows important information about the monitor.
	
	
	
	
	
	

# Technical Information

## Specifications

<b>Model Name</b>	<b>Planar SA2311W</b>
<b>LCD Display</b>	
Display Type	23" TN Type LCD
Display Area	509.76(H)x286.74(V) mm
<b>Input</b>	
Voltage	100-240Vac
Frequency	VGA: F <sub>H</sub> , 30KHz ~ 80kHz F <sub>v</sub> , 55Hz~76Hz
	DVI: F <sub>H</sub> , 30KHz ~ 138kHz F <sub>v</sub> , 56Hz~120Hz
<b>Operational Features</b>	
Display Colors	16.7M
Resolution	1920x1080 @ 60 Hz
Interface	RGB
<b>Input Connector</b>	VGA, DVI, HDMI
<b>Physical Specification</b>	
Dimension (H x W x D)	546 x 400x 212 (mm)
Net Weight	7.08 kg
<b>Power</b>	
Power on Consumption (Blue)	55 W MAX.
Power Saving (Orange)	<2 W
Power DC-Off (No Light)	<1 W
<b>Temperature</b>	
Operating Temperature:	0 - 40°C
Storage Temperature:	-20 - 60°C
<b>Humidity</b>	
Operating Humidity:	20%-80%
Storage Humidity:	10%-90%
<b>Safety &amp; EMI</b>	cTUVus, CCC, CB, FCC-B, CE
<b>Plug and Play</b>	Supports VESA DDC2B functions

\* All specifications are subject to change without notice.

## Supported Timing

NO.	Resolution		H-frequency KHz	V-frequency Hz	Pixel rate MHz
1	VESA	640 x 480	31.469	59.941	25.175
2	MAC	640 x 480	35	66.66	30.24
3	VESA	640 x 480	37.861	72.809	31.5
4	VESA	640 x 480	37.5	75	31.5
5	VESA	720 x 400	31.469	70.087	28.322
6	VESA	800 x 600	35.156	56.25	36
7	VESA	800 x 600	37.879	60.317	40
8	VESA	800 x 600	48.077	72.188	50
9	VESA	800 x 600	46.875	75	49.5
10	MAC	832 x 624	49.722	74.55	57.28
11	VESA	1024 x 768	48.363	60.004	65
12	VESA	1024 x 768	56.476	70.069	75
13	VESA	1024 x 768	60.023	75.029	78.75
14	MAC	1152 x 870	68.681	75.062	100
15	VESA	1152 x 864	67.5	75	108
16	CEA	1280 x 720	44.955	59.94	74.176
17	VESA	1280 x 800	49.702	59.81	83.5
18	VESA	1280 x 960	60	60	108
19	VESA	1280 x 1024	63.981	60.02	108
20	VESA	1280 x 1024	79.976	75.025	135
21	VESA	1360 x 768	47.712	60.015	85.5
22	CVT	1440 x 900	55.935	59.887	106.5
23	VESA	1440 x 900	70.635	75	136.75
24	CVT	1680 x 1050	65.29	59.954	146.25
25	VESA	1600 x 1200	75	60	162
26	CEA	1920 x 1080	67.5	60	148.5
27	CVT-RB	1920 x 1080	66.587	59.934	138.5
28	NVA-3D	1920 x 1080 (3D mode)	113.721	100	236.54
29	NVA-3D	1920 x 1080 (3D mode)	125.668	110	261.39
30	NVA-3D	1920 x 1080 (3D mode)	137.861	120	286.75

# Troubleshooting

Before sending your LCD monitor for servicing, please check the troubleshooting list below to see if you can self-diagnose the problem.

Problems	Current Status	Remedy
No Picture	LED ON	Using OSD, adjust brightness and contrast to maximum or reset to their default settings.
	LED OFF	Check the power switch.
		Check if AC power cord is properly connected to the monitor.
	LED displays amber color	Check if video signal cable is properly connected to the monitor.
Abnormal Picture	Unstable Picture	Check if the power of computer system is ON.
		Check if the specification of graphics adapter and monitor is in compliance which may be causing the input signal frequency mismatch.
	Display is missing, center shift, or too small or too large in display size	Using OSD, adjust RESOLUTION, CLOCK, CLOCK-PHASE, H-POSITION and V-POSITION with non-standard signals.
		Using OSD, in case of missing full-screen image, please select other resolution or other vertical refresh timing.
	Wait for a few seconds after adjusting the size of the image before changing or disconnecting the signal cable or powering OFF the monitor.	
Missing/ Stuck-on Pixels	LCD screen has spots or LCD screen has bright spots	Cycle power on-off. Pixel that is permanently off is a natural defect that can occur in LCD technology.
Geometric Distortion	Screen not centered correctly	Reset the monitor to Factory Settings.
Horizontal/ Vertical Lines	Screen has one or more lines	Reset the monitor to Factory Settings. Perform monitor self-test feature check and determine if these lines are also in self-test mode. Check for bent or broken pins in the video cable connector.
Safety Related Issues	Visible signs of smoke or sparks	Do not perform any troubleshooting steps. Contact <b>PLANAR</b> immediately.

# Product Registration and Technical Support

## **Register Your Planar Products Today**

Thank you for choosing Planar. To assure you receive all the benefits of your Planar product and services, register your Planar product today.

Visit our website to register your product at

[http://www.planar.com/support/product\\_registration.html](http://www.planar.com/support/product_registration.html)

## **Cables, Replacement Lamps, Accessories**

To find cables, replacement lamps and accessories for your Planar projector, LCD monitor, touch screen or other Planar products visit our online store at [www.PlanarOnline.com](http://www.PlanarOnline.com) or find other stores who carry Planar products at <http://www.planar.com/howtobuy>

## **Technical Support**

Visit Planar at <http://www.planar.com/support> for product registration, operations manuals, touch screen drivers, warranty information and access to Planar's Technical Library for online troubleshooting.

To speak with Planar Customer Support please have you model and serial number available and dial:

## **Planar Support**

Tel: 1-866-PLANAR1 (866-752-6271) or +1 503-748-5799 outside the US.

Hours: 24 hours a day, 7 days a week.

**Toll or long distance charges may apply.**

## **Planar Systems, Inc.**

Customer Service

24x7 Online Technical Support: <http://www.planar.com/support>

1195 NW Compton Drive

Beaverton, OR 97006-1992

Tel: 1-866-PLANAR1 (866-752-6271), or +1 503-748-5799 outside the United States,

Hours: 24 hours a day, 7 days a week

©2010 Planar Systems, Inc.

Planar is a registered trademark of Planar Systems, Inc. Other brands and names are the property of their respective owners. Technical information in this document is subject to change without notice.

020-1052-00



49.7J301.002

## Free Manuals Download Website

<http://myh66.com>

<http://usermanuals.us>

<http://www.somanuals.com>

<http://www.4manuals.cc>

<http://www.manual-lib.com>

<http://www.404manual.com>

<http://www.luxmanual.com>

<http://aubethermostatmanual.com>

Golf course search by state

<http://golfingnear.com>

Email search by domain

<http://emailbydomain.com>

Auto manuals search

<http://auto.somanuals.com>

TV manuals search

<http://tv.somanuals.com>