



The Plasmon Enterprise D-Series

**D875 - D2175 Libraries ~ DVD Drive
User Manual**

P/N 97704577 E

PREFACE

Copyright

Copyright 2004 by Plasmon®. All rights reserved. This document and the information contained herein are the property of Plasmon. No part of this document may be reproduced, transmitted, transcribed, stored in a retrieval system, or translated into any language or computer language in any form or by any means, electronic, mechanical, magnetic, optical, chemical, manual, or otherwise, without the express written permission of Plasmon.

United States Office

Plasmon
4425 ArrowsWest Drive
Colorado Springs, CO 80907-3489

European Headquarters. UK

Plasmon Data Limited
Whiting Way
Melbourn, Herts. SG8 6EN

Disclaimer

Plasmon makes no representation or warranties with respect to the contents of this document and specifically disclaims any implied warranties of merchantability or fitness for any particular purpose. Further, Plasmon reserves the right to revise this publication without obligation of Plasmon to notify any person or organization of such revision or changes.

Trademark Notices

Plasmon is a U.S. registered trademark of Plasmon. Rotation Station is a trademark of Plasmon. All other product names are trademarks or registered trademarks of their respective owners.

Revision History

Revision	Date	Description
A	September 2002	Initial release.
B	November 2002	Updated installation information.
C	March 2003	Updated to include Multi Drive.
D	June 2003	Minor updates from Service.
E	October 2004	Updated format and presentation. Added bay packing to Ch 2.

NOTE

The most current information about this product is available on the Plasmon web site (www.plasmon.com, or www.plasmon.co.uk).

Conventions Used

WARNING



A **WARNING** is used to alert the reader to situations or conditions that could potentially result in personal injury, fire hazard, or equipment damage.

CAUTION



A **CAUTION** is used to warn of undesirable procedures, or of situations in which equipment damage could result.

NOTE

A **NOTE** is used to emphasize an area of text or to provide additional information.

Product Warranty

This Plasmon library is warranted free from defects in materials, parts, and workmanship and to conform to the current product specification upon delivery. For the specific details of your warranty, refer to your sales contract or contact the company from which the library was purchased.

The Plasmon quality system is in compliance with and registered to ISO9001:2000. All products are assembled from new or remanufactured parts.

The warranty for the library shall not apply to failures of any unit when:

- The library is repaired by anyone other than Plasmon personnel or approved agent.
- The library is physically abused or is used in a manner that is inconsistent with the operating instructions or product specification defined by Plasmon.
- The library is used with incompatible software and or firmware.
- The library fails because of accident, misuse, abuse, neglect, mishandling, misapplication, alteration, faulty installation, modification, or service by anyone other than the factory service center or its approved agent.
- The library is repaired by anyone, including an approved agent, in a manner that is contrary to the maintenance or installation instructions supplied by Plasmon.
- The Plasmon serial number tag is removed.
- The library is damaged because of improper packaging on return.

CAUTION



Returning the library in unauthorized packaging may damage the unit and void the warranty.

If problems with the library occur, contact your maintenance organization. Do not void the product warranty by allowing untrained or unauthorized personnel to attempt repairs.

WARNING



Untrained personnel operating the library may create dangerous situations. This could lead to physical harm to the operator, data loss, or disabling of the library system.

Please review and observe all safety rules concerning the operation of the library.

TABLE OF CONTENTS

PREFACE	1
Copyright	1
Disclaimer	1
Trademark Notices	1
Revision History	2
Conventions Used	3
Product Warranty	4
LIST OF FIGURES	7
LIST OF TABLES	9
CHAPTER 1	
PRODUCT OVERVIEW	11
General Information	11
Library Models	11
Command Processing	11
Media Movement	11
Bulk Loading and Unloading Media	11
The Magazine	12
Media and Magazine Handling	13
Major Hardware Components	14
Front Access Door	14
Front Panel Display	14
Magazine Access Door	14
Magazine Slots	14
Import/Export Port (I/E)	15
Drive Modules	15
Main Power Switch and Power Cable	15
SCSI Interface	15
Power Supplies	15
Rear Access Door	16
Lift Assembly	16
Media Transport Element (MTE)	16
Rotation Station	16
Storage Slot Map	16
CHAPTER 2	
LIBRARY INSTALLATION	17
Getting Started	17
Unpacking the Library	17
Library Position	17
Library Environment	18
Power Cable and Power Switch	18
Removing Internal Packing Material	18

Library Initialization	19
SCSI Connection	20
Loading Media	21
Identifying Storage Slots	23
D1525 - D2175 Bay Installation	24
Library Packing Instructions	28
Packing Instructions (D1525 - D2175 Expansion Bays)	32
CHAPTER 3	
MENU SYSTEM	39
Navigating the Menu System	39
Power Up Menu Options	41
Main Menu Overview	42
Library Status Menu Overview	44
Set Up Library Menu Overview	47
APPENDIX A	
SPECIFICATIONS	51
Overall Library Specifications	51
Power Cable Specification	53
SCSI Cable Specification	53
SCSI Cables and Connectors	53
SCSI Cable Length	53
SCSI Termination	53
APPENDIX B	
SCSI BUS INFORMATION	55
SCSI Bus Configurations	55
Single Bus Configuration	55
Dual Bus Configuration	56
Triple Bus Configuration	57
SCSI ID Configuration	58
Drive Combinations	59
APPENDIX C	
SAFETY AGENCY STANDARD	61
FCC Notice	61
Industry Canadian Notice per ICES-003	61
Australia / New Zealand	61
Taiwan (BSMI) Class A Warning Statement	62
Laser Safety Notice	62
CDRH Regulations	62
Lithium Battery	62
APPENDIX D	
ERROR CODES	63
INDEX	85
CONTACTING PLASMON	87

LIST OF FIGURES

The Bulk Loading Magazine	12
D875 - D2175 Library, Front View	14
D875 - D2175 Library, Rear View	16
Space Planning for the Library	17
D875 - D2175 Power Connector and Power Switch	18
Removing the Packing Foam from the MTE	19
Connecting the SCSI Interface	20
Magazine Slots	21
Slot Storage Map.	23
Expansion Bay Installation (a)	24
Expansion Bay Installation (b)	25
Expansion Bay Installation (c)	26
Expansion Bay Installation (d)	26
Expansion Bay Installation (e)	27
Expansion Bay Installation (f)	27
Packing the D875 - D2175 Libraries (a)	28
Packing the D875 - D2175 Libraries (b)	29
Packing the D875 - D2175 Libraries (c)	29
Packing the D875 - D2175 Libraries (d)	30
Packing the D875 - D2175 Libraries (e)	30
Packing the D875 - D2175 Libraries (f)	31
Expansion Bay Packing (a)	32
Expansion Bay Packing (b)	33
Expansion Bay Packing (c)	33
Expansion Bay Packing (d)	34
Expansion Bay Packing (e)	34
Expansion Bay Packing (f)	35
Expansion Bay Packing (g)	35
Expansion Bay Packing (h)	36
Expansion Bay Packing (i)	36
Expansion Bay Packing (j)	37
LCD Display Format	39
Power Up LCD Display	41
Main Menu Overview	42
Library Status Menu Options	44
Set Up Library Menu Options	47
Single Bus Configuration	55
Dual Bus Configuration	56
Triple Bus Configuration	57

LIST OF TABLES

D875 - D2175 Library Models	11
Plasmon Pre-loaded Media	12
Magazine Slot LED Indicators	22
Organization of Media in the Library	23
LCD Symbols	40
Power Up LCD Symbols	41
Main Menu Selections	43
Library Status Menu Selections	45
Set Up Library Menu Selections	48
D875 - D2175 Specifications	51
Media Specifications	52
Maximum Allowable SCSI Cable Length (LVD)	53
Factory Default SCSI IDs for the D875 - D2175 Libraries	58
SCSI Bus and Drive Combinations	59
D875 - D2175 Error Codes	64

CHAPTER 1

PRODUCT OVERVIEW

General Information

The D875 - D2175 libraries make multiple CD-R, CD-RW, DVD-R, DVD-RAM, and DVD-RW media available to computer systems for reading and writing using Multi Drive technology. These libraries are scalable with capacities ranging from 750 to 2175 media. A media transport element (MTE) with a dual picker makes rapid media exchanges and provides high performance in a multi-user environment. A patented Rotation Station™ allows use of both single and double sided media.

Library Models

This manual covers the following Plasmon libraries:

Table 1. D875 - D2175 Library Models

Model	Number of Media Slots	Number of Drives
D875	750 to 875	2 to 12
D1525	1400 to 1525	2 to 12
D2175	2050 to 2175	2 to 12

The number of media slots varies because adding a drive module, which holds two drives, subtracts 25 media storage slots.

Command Processing

The library responds to SCSI commands from a host computer system to load and unload drives, and move media within the library.

Media Movement

The media transport element (MTE) is used to move media between the media storage area and the drives or the I/E port. To speed the process, the MTE can hold two pieces of media simultaneously.

Bulk Loading and Unloading Media

Bulk loading and unloading of media is performed by using the ten slot magazines, and the Bulk Load Library and Bulk Unload Library front panel menu options.

The Magazine

The Plasmon D875 - D2175 library uses CD-R, CD-RW, DVD-R, DVD-RAM, and DVD-RW pre-loaded media in a ten slot magazine. Packs of 40 pieces of media are also available. Contact Plasmon for ordering information. In the US, Asia/Pacific, South America, and Canada call 1-800-451-6845. In Europe, Middle East, and Africa call +44 (0) 1763 262 963.

Table 2. Plasmon Pre-loaded Media

Media Type	Capacity
DVD-R	9.4 GB (dual sided)
DVD-R	4.7 GB (single sided)
DVD-RAM	9.4 GB (dual sided)
DVD-RAM	4.7 GB (single sided)
DVD-RAM	2.6 GB (single sided)

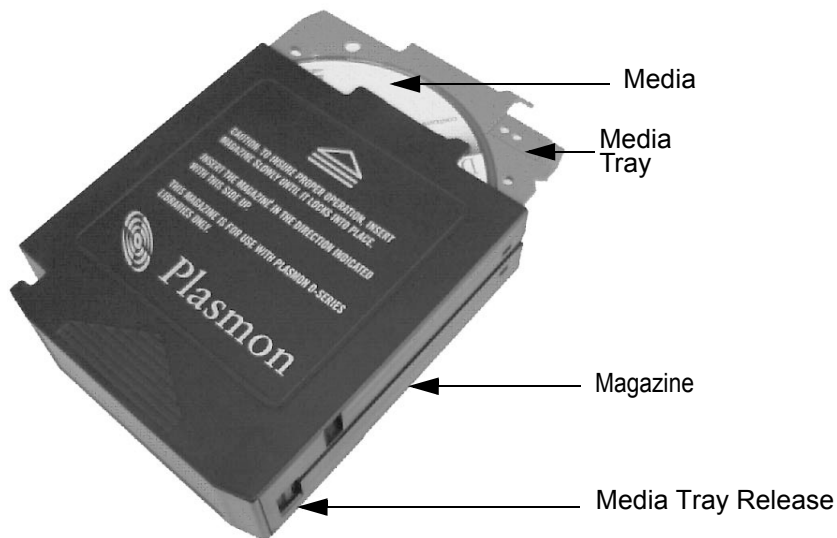

Figure 1. The Bulk Loading Magazine

Media and Magazine Handling

To maintain maximum system reliability, the operator should take the time to inspect and clean each magazine before loading into the library.

CAUTION



Always condition the media to the normal operating temperature of the room before using them.

Improper handling or an inappropriate environment can damage the media, the magazine, or media trays. To ensure continued reliability, observe the following:

- When loading a magazine into the library or when handling a magazine, ensure that the case is clean. Dirty magazines can cause problems in loading or the loss of written data.
- Do not load damaged media trays into a magazine or the library. Damaged media trays can interfere with system robotics.
- Do not expose the media to moisture or direct sunlight.

NOTE

Plasmon can not guarantee error free library operation if media is not purchased from Plasmon.

Plasmon supplied media are packaged in a clean room and quality inspected to ensure error free library operation.

Major Hardware Components

The following figures show the locations of major library hardware components. A brief description of these components appears after each figure.

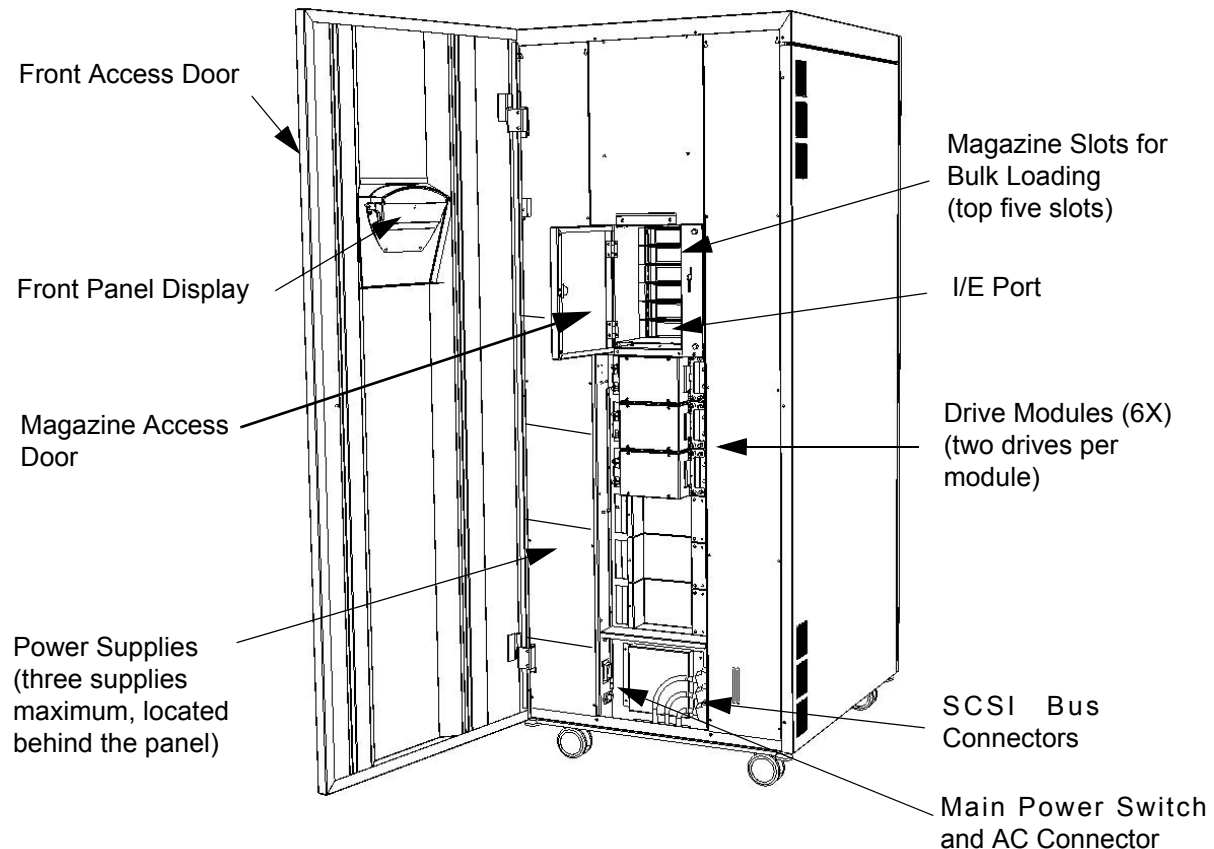

Figure 2. D875 - D2175 Library, Front View

Front Access Door

The front door provides access to the magazine slots and import/export port (I/E port), drive modules, power supplies, main power switch, SCSI connections, and circuit boards.

Front Panel Display

The keypad and display which provide the user interface to the system. It is used to display tests, modes, error codes, and other user related messages.

Magazine Access Door

The magazine access door opens on the magazine slots.

Magazine Slots

There are five magazine slots behind the magazine access door. Each magazine slot holds one magazine containing up to ten pieces of media. These slots are used to bulk load the library. They can also be used as removable storage.

Import/Export Port (I/E)

The Import/Export port (I/E port) holds one magazine containing ten pieces of media. The port is located below the five magazine slots and is used to remove and load media while the library is on-line.

Drive Modules

Each drive module contains two 120 mm Multi Drives which accommodate CD-R, CD-RW, DVD-R, DVD-RAM, or DVD-RW media. The drives allow reading and writing of data to the media. Contact Plasmon for the latest drive updates.

Main Power Switch and Power Cable

The power cable is routed through the bottom of the library to the power connector. The power switch is located just above the power connector.

SCSI Interface

The connection between the library and a host computer. The interface to the library is LVD SCSI using a 68-pin high density connection. The host computer must also be set up for LVD SCSI.

Power Supplies

A maximum of three power supplies may be installed in the library. One power supply can power up to six drives. Two power supplies are required for 12 drives. Three power supplies provide a redundant power supply option for the library. The supplies are hot swappable.

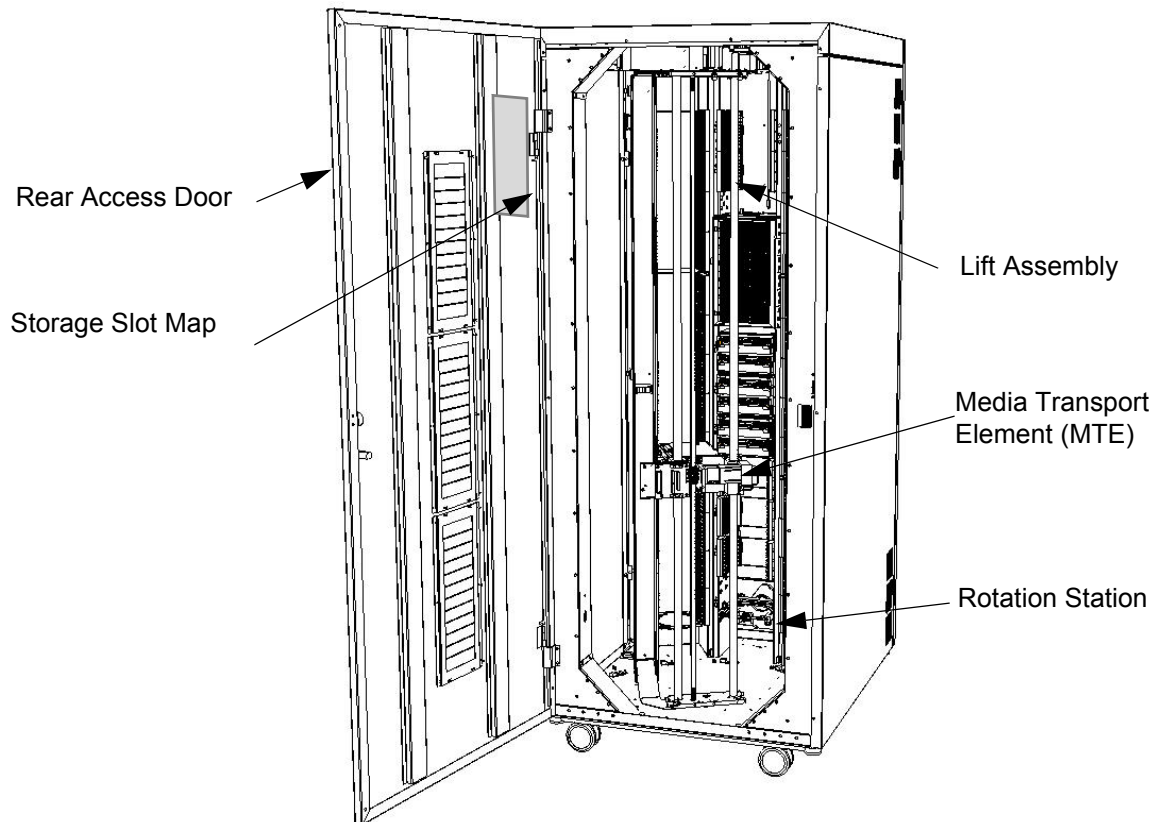

Figure 3. D875 - D2175 Library, Rear View

Rear Access Door

The rear door provides access to the robotic elements and media slots in the library.

Lift Assembly

The lift assembly provides the vertical and pivotal motion for the media transport element (MTE), providing access to all media locations.

Media Transport Element (MTE)

The MTE is the mechanism that picks media and moves it between storage locations and the drives.

Rotation Station

The Rotation Station allows use of double-sided media.

Storage Slot Map

The storage slot map is located on the inside of the rear access door. It identifies the media locations for all D875 - D2175 models.

CHAPTER 2

LIBRARY INSTALLATION

Getting Started

This chapter provides information for installing the Plasmon D875 - D2175 libraries and the procedures necessary to quickly put a library on-line.

Unpacking the Library

Save all packing material in case it is ever necessary to ship the library.

Library Position

Position the library in a location that allows both the front and rear door to open completely without any obstructions. The figure below should be used as a guide for library space planning.

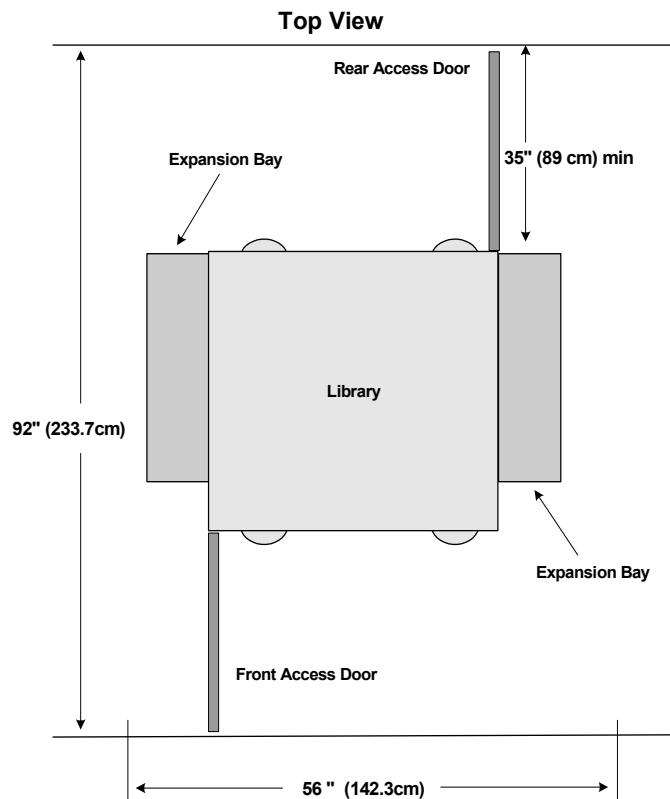

Figure 4. Space Planning for the Library

Allow 3 inches (7.6 cm) behind and 2 inches (5.1 cm) on both sides of the unit for sufficient airflow.

Library Environment

To ensure long term reliability, operate the library only between 10° to 32°C (50° to 90°F) and 10% to 90% relative humidity. The media and drives require a clean environment. Excessive dust and dirt can lead to data loss, and increase service calls.

Power Cable and Power Switch

Open the front door of the library and route the supplied power cable through the access hole in the bottom of the library to the power cable connector.

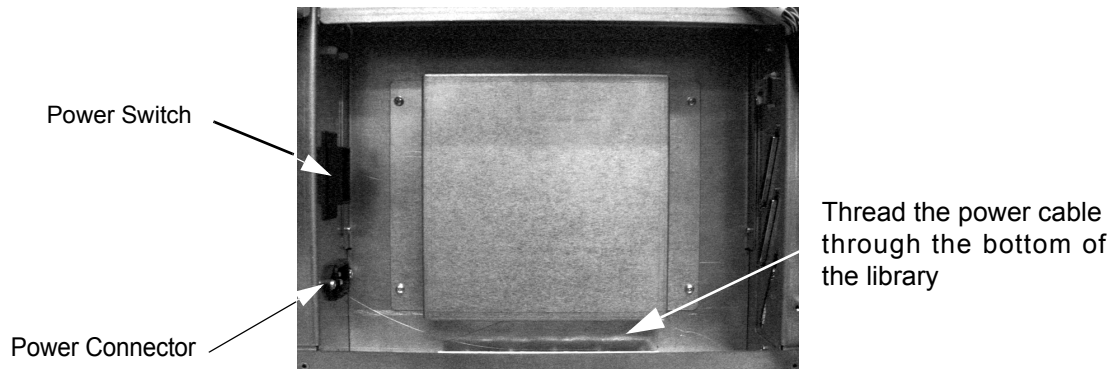

Figure 5. D875 - D2175 Power Connector and Power Switch

Connect the power cable to a suitable AC source. The power switch is located beside the power cable connection. Power on the library.

The front panel display now prompts to remove the protective packaging material.

Removing Internal Packing Material

1. Apply power to the library.
2. Follow the instructions on the front panel display to check the time and date and remove all packing material.
3. Use the supplied key to unlock and open the rear access door. The library is not operable with this door open.
4. Remove the two pieces of MTE protective packing foam. See the figure below.

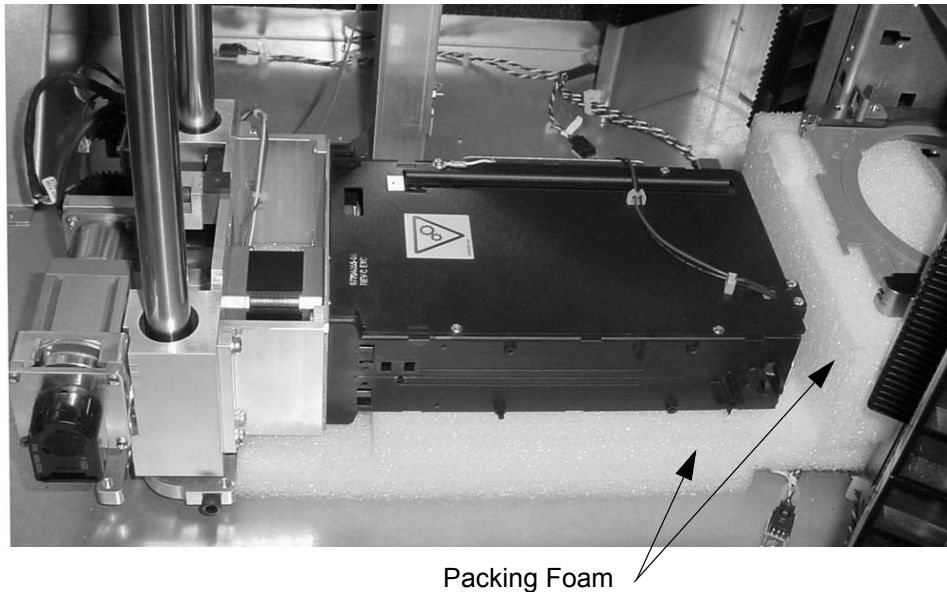

Packing Foam

Figure 6. Removing the Packing Foam from the MTE

Library Initialization

After the protective packaging material is removed the user is prompted on the front panel display to close the rear door. The library now performs a self-calibration and initialization routine.

NOTE

It may be necessary to reboot the host computer for it to recognize the library.

Some modifications to the host hardware or operating system may be necessary for it to recognize the library. These modifications may include patches, driver updates, or modifications to the configuration files. Please consult the host hardware or operating system documentation to see if any of these applications apply.

SCSI Connection

Turn the library's power switch to the off position prior to connecting the SCSI interface.

The library requires a host computer with a dedicated LVD SCSI host bus adapter (HBA). Ensure that the library is powered off prior to connecting the SCSI cables.

The SCSI cable passes through the bottom of the library into the appropriate SCSI connector inside the front door of the library.

CAUTION



Ensure the host computer provides an LVD SCSI interface. HVD SCSI is not compatible with LVD SCSI. If an improper connection is made, damage to the library or connected equipment could result.

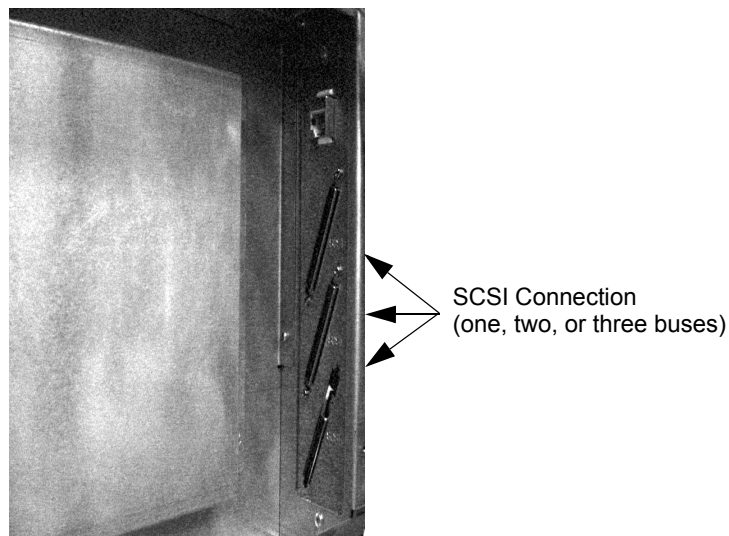

Figure 7. Connecting the SCSI Interface

Loading Media

There are two methods for loading media into the D875 - D2175 libraries:

- **High Speed Bulk Loading (recommended):** This method is intended as the first time solution to mass load the library with media when the library is off-line. This method utilizes all six magazine slots to load the library.
- **I/E Port Magazine Loading:** This is intended for importing and exporting up to ten pieces of media in a removable magazine while the library is on-line.

When loading the library for the first time, use the high speed bulk loading method described below:

1. Turn on the power.
2. From the front panel menu select Set Up Library>Offline Operations>Bulk Load Library.
3. Open the library front door and the magazine access door. Note that when the Bulk Load Library option is selected, the magazine door opens.
4. Place a pre-loaded magazine in each magazine slot (magazine 1 through magazine 6).
5. When the green LED goes out, remove the appropriate empty magazine and install the next full magazine.

NOTE

Third party software is required to operate the library

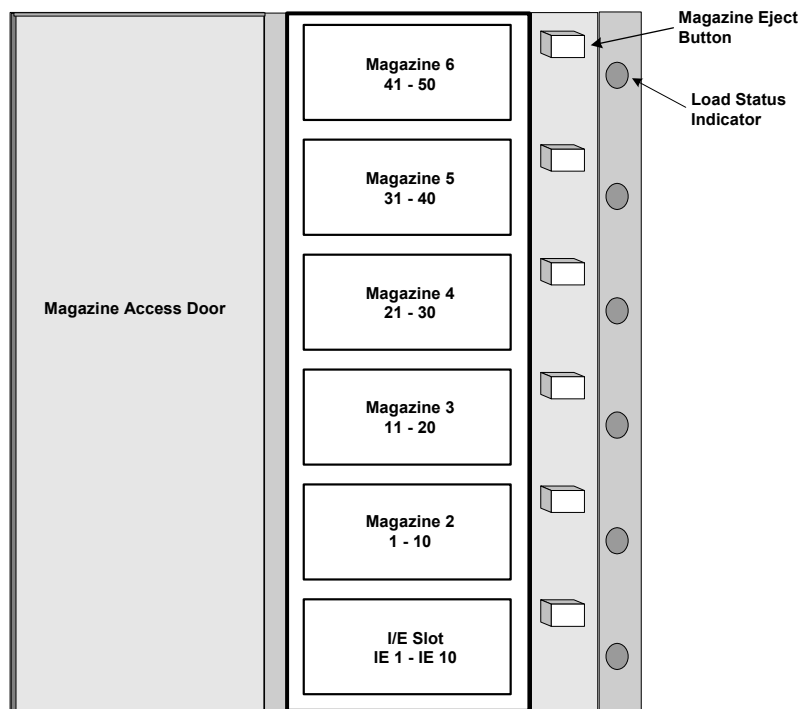

Figure 8. Magazine Slots

Table 3. Magazine Slot LED Indicators

LED State	Description
On	Magazine present or not present
Off	N/A
Blinking	Magazine may be removed
Bulk Loading Indicators	
On	Magazine in use
Off	Remove to reload with media
Blinking	Insert magazine in appropriate position

Identifying Storage Slots

Viewing the system through the open rear access door, the columns are numbered from left to right. The left most column (when the left expansion bay is installed) is column one and the right most column (when the right expansion bay is installed) is column seven. The media slots are numbered from top to bottom, except for the magazine slots. The table below shows the model number, the number of slots, and provides a listing of the columns involved. The column numbers in the table are listed in sequence.

Table 4. Organization of Media in the Library

Model	Number of Slots	Column Numbers
D875	750 to 875	All Magazine Slots + 3, 4, and 5
D1525	1400 to 1525	All Magazine Slots + 3, 4, 5, 1, and 2
D2175	2050 to 2175	All Magazine Slots + 3, 4, 5, 1, 2, 6, and 7

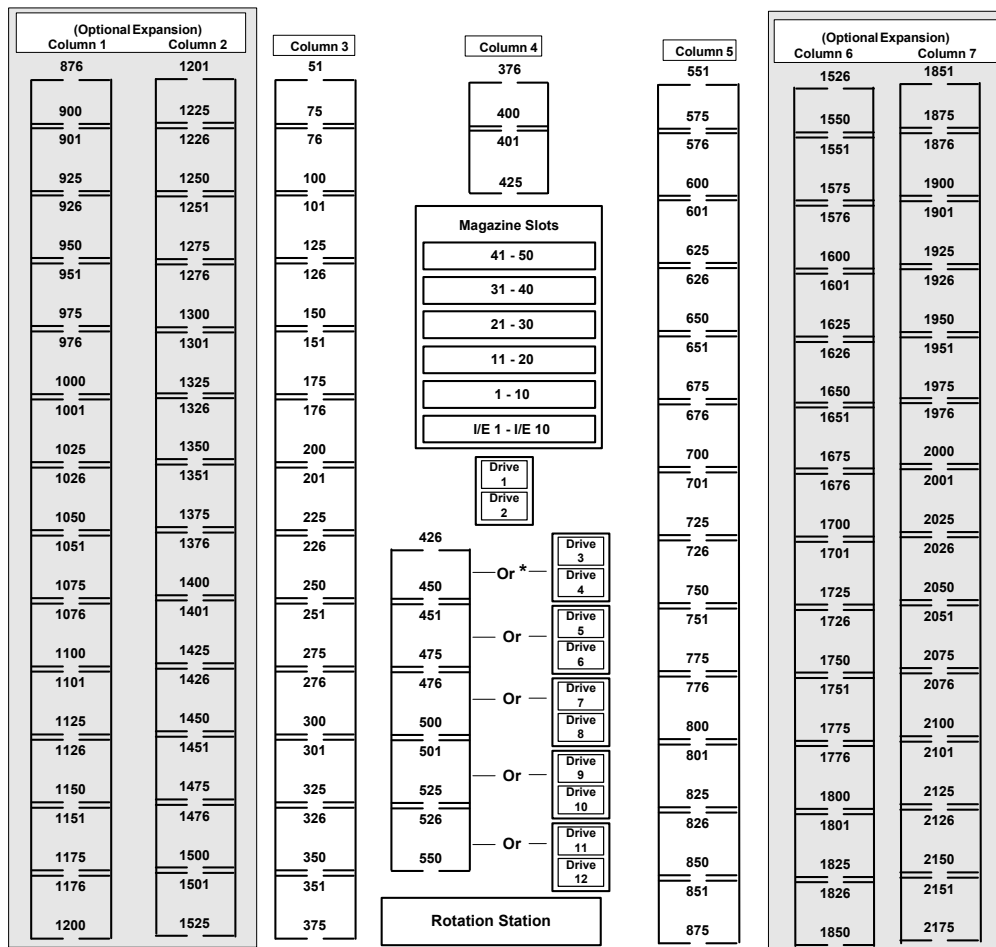

Shaded areas represent the optional expansion modules (650 slots each module)

* = Each drive module takes an equivalent space of 25 storage slots

Figure 9. Slot Storage Map

D1525 - D2175 Bay Installation

The expansion storage bays that attach to the sides of the Plasmon D875 library are shipped separately. The following instructions explain how to mount the bays to the main library chassis.

Note: This operation should be performed by two people.

1. The main library chassis is shipped without side panels as shown below. Remove the side panels if upgrading a standard D875 library to a D1525 and D2175.



Figure 10. Expansion Bay Installation (a)

2. Position the expansion bay flush against the library chassis matching the guide pins on the chassis to the guide holes on the expansion bay.

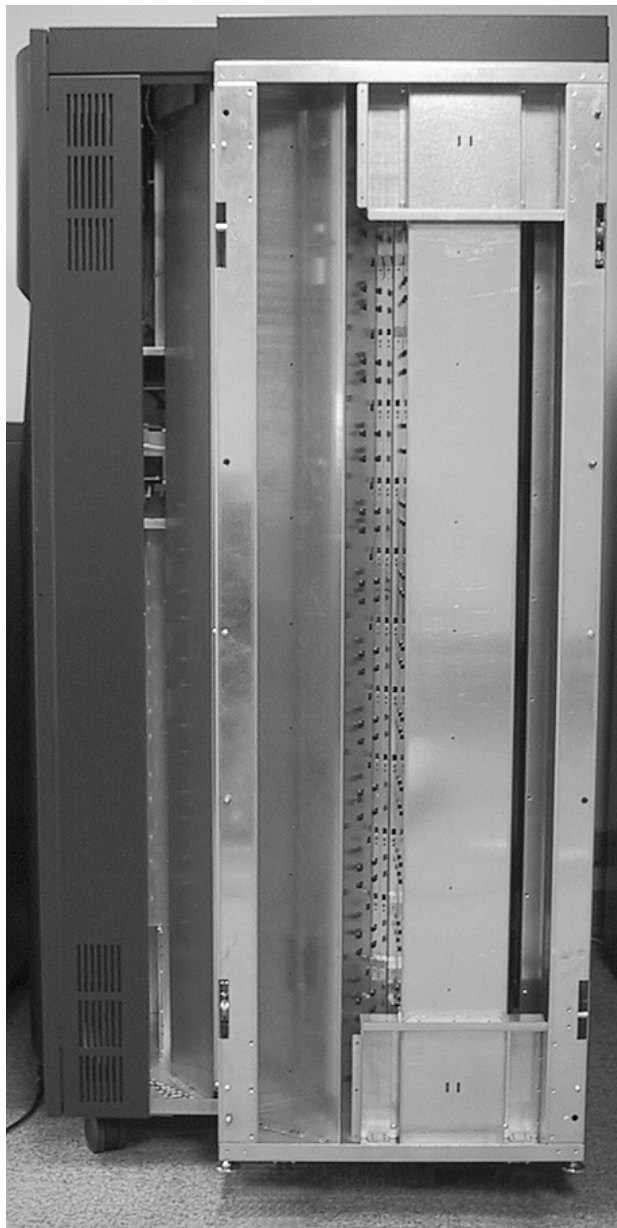

Figure 11. Expansion Bay Installation (b)

- Using a 5/16 in hex wrench, engage the four latch hooks that hold the expansion bays to the library chassis. There are two on each side of the bay.



Figure 12. Expansion Bay Installation (c)

- Using a phillips head screw driver, attach the finish matching cover plate to the back side of the expansion bay with the color coated screws provided.



Figure 13. Expansion Bay Installation (d)

5. Attach the finish matching square column to the front of the bay by hanging it on the screw heads provided.



Figure 14. Expansion Bay Installation (e)

6. Finally, attach the finish matching side panel to the bay by hanging it on the screw heads provided.



Figure 15. Expansion Bay Installation (f)

Library Packing Instructions

This section is provided in case it is necessary to ship the library (without expansion bays) to another location or back to Plasmon. Instructions on how to pack the expansion bays is provided later in this chapter. These procedures must be followed.

CAUTION



Plasmon libraries must be shipped in the original packaging. Shipping a unit in anything other than the manufacturers packaging voids the warranty. Replacement packaging is available from Plasmon.

The library must be parked before packing the system.

Follow these steps to pack the library for shipping:

1. While parking, the library prompts for insertion of the MTE packaging material.
2. Insert the first piece of foam under the Rotation Station. Place this foam so the tab is on the top left side when viewed from the back of the library.
3. Insert the second piece of foam under the MTE being careful not to damage the vertical path emitter. Place this foam so the cut-out is on the left when viewed from the back of the library.

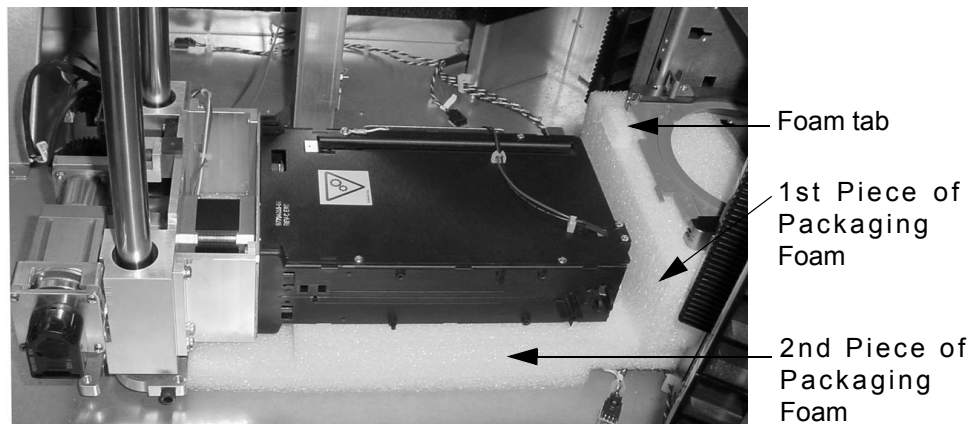

Figure 16. Packing the D875 - D2175 Libraries (a)

4. Place skid ramp on the ground in front of the packaging skid. Connect the velcro on the ramp to velcro on packaging skid.



Figure 17. Packing the D875 - D2175 Libraries (b)

5. Roll the library onto packaging skid. The library's front door goes onto skid first. Push on bottom of library when rolling onto packaging skid.
6. Cover the library with the anti-static bag, and insert back edge-board into slots with foam protected side toward library.



Figure 18. Packing the D875 - D2175 Libraries (c)

7. Remove ramp from skid and place upright in slot provided behind library. Close velcro fasteners.



Figure 19. Packing the D875 - D2175 Libraries (d)

8. Place top foam over library, and fit in place.



Figure 20. Packing the D875 - D2175 Libraries (e)

9. Place cardboard sleeve over library, and place lid on top.



Figure 21. Packing the D875 - D2175 Libraries (f)

10. Finally, strap box to the skid for shipping.

Packing Instructions (D1525 - D2175 Expansion Bays)

This section is provided in case it is necessary to ship the bays to another location, or back to Plasmon. These procedures must be followed.

CAUTION



Plasmon libraries and bays must be shipped in the original packaging. Shipping a unit in anything other than the manufacturer's packaging voids the warranty. Replacement packaging is available from Plasmon.

Follow these steps to pack the bays for shipping:

1. Lay out the pallet & ramp, wheeled skid, and mounting blocks as shown in the picture below. Ensure the ramp is securely attached to the pallet with the velcro strips.



Figure 22. Expansion Bay Packing (a)

2. Place the first bay on the wheeled skid as shown in the picture below.



Figure 23. Expansion Bay Packing (b)

3. Position the bay so the mounting bolt hole lines up as shown below.

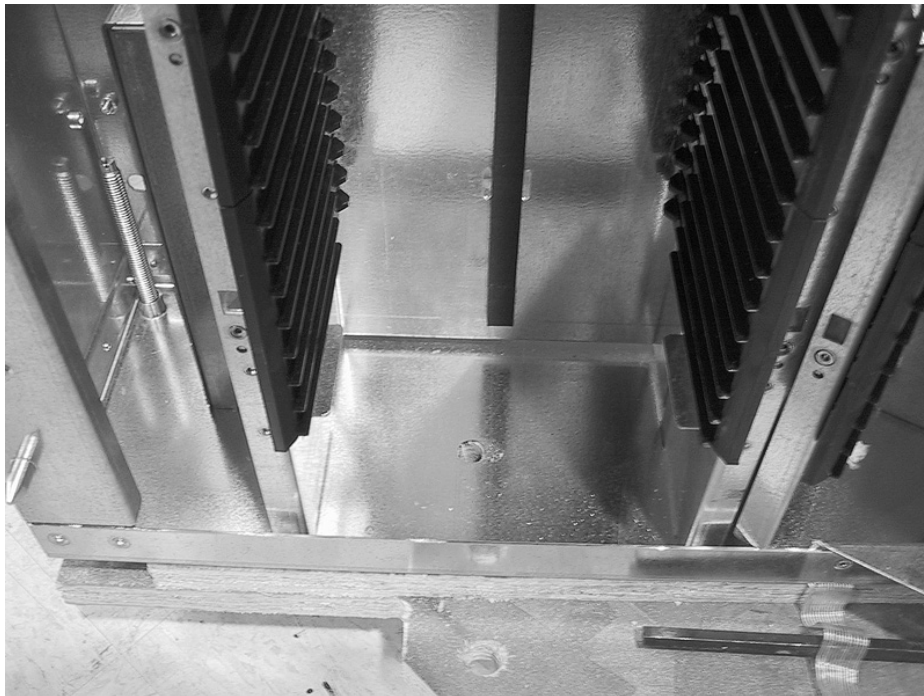

Figure 24. Expansion Bay Packing (c)

4. Use a mounting block and a hex head bolt to secure the bay to the wheeled skid.



Figure 25. Expansion Bay Packing (d)

5. Hang the painted skin and spacer column on their mounting screws as shown.



Figure 26. Expansion Bay Packing (e)

6. Secure a second bay in the same way, but facing the opposite direction.



Figure 27. Expansion Bay Packing (f)

7. With two people steadying the bays, roll the wheeled skid up the ramp onto the pallet.
Push at the bottom to avoid tipping.



Figure 28. Expansion Bay Packing (g)

- Secure the wheeled skid to the pallet with four hex head bolts (two on each side).



Figure 29. Expansion Bay Packing (h)

- Cover each bay with an anti-static bag, and tape the ramp in an upright position as shown.



Figure 30. Expansion Bay Packing (i)

10. Place the shaped foam topper on the bays. Make certain the center spacer foam fits down between the bays. Then slid the cardboard box over the bays and tape the top flaps closed.



Figure 31. Expansion Bay Packing (j)

11. Finally, strap box to skid for shipping.

CHAPTER 3

MENU SYSTEM

Navigating the Menu System

The Plasmon D-Series library modes and functions are controlled using four selection buttons located on the front panel display. A liquid crystal display (LCD) located directly above the buttons, provides system status and other important information.

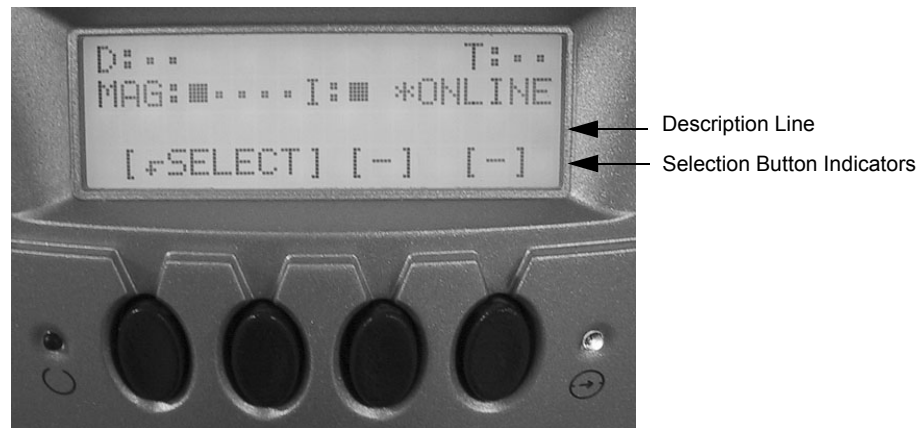













Figure 32. LCD Display Format

The **description line** displays the number and name of the mode or test when navigating menus. An ellipsis (...) following a name indicates that the selection contains submenus.

The **selection button indicators** display the function of the four buttons located directly below the indicators. A dash above a button means that no function is associated with this key. The following *LCD Symbols* table provides an explanation of each symbol.

Table 5. LCD Symbols

LCD symbol	Meaning
	Enter a menu selection
	Exit a menu selection
	Change a mode selection
	Switch to display scroll mode
	Confirm a selection
	Decrement a numeric value or scroll display up
	Increase a numeric value
	Go to the previous menu item
	Go to the next menu item
	Display a list of menu items
	Run a motor or execute a function
X	Indicates a drive is turned off
●	Indicates media exists in an element
■	Indicates magazine exists in an element
•	Indicates the element is empty
—	Indicates an empty tray in a drive

Power Up Menu Options

The following operations can be performed at the initial power up stage:

- Entering the library's main menu system.
- Viewing error information.

When the library powers up, the LCD displays:



Figure 33. Power Up LCD Display

Table 6. Power Up LCD Symbols

Symbol	Meaning
D	Drive status (drive present, media present)
T	Media Transport Element status (media present)
I	I/E Port status (magazine present)
MAG	Ten Slot Magazine slot status (magazine present)
•	Empty element
●	Media in element
■	Magazine in element
—	Empty tray in drive

Main Menu Overview

The D875 - D2175 library LCD menu system starts with nine top-level options. To cycle through the options at any level press [**SELECT**]. To enter a selection press [**ENTER**].

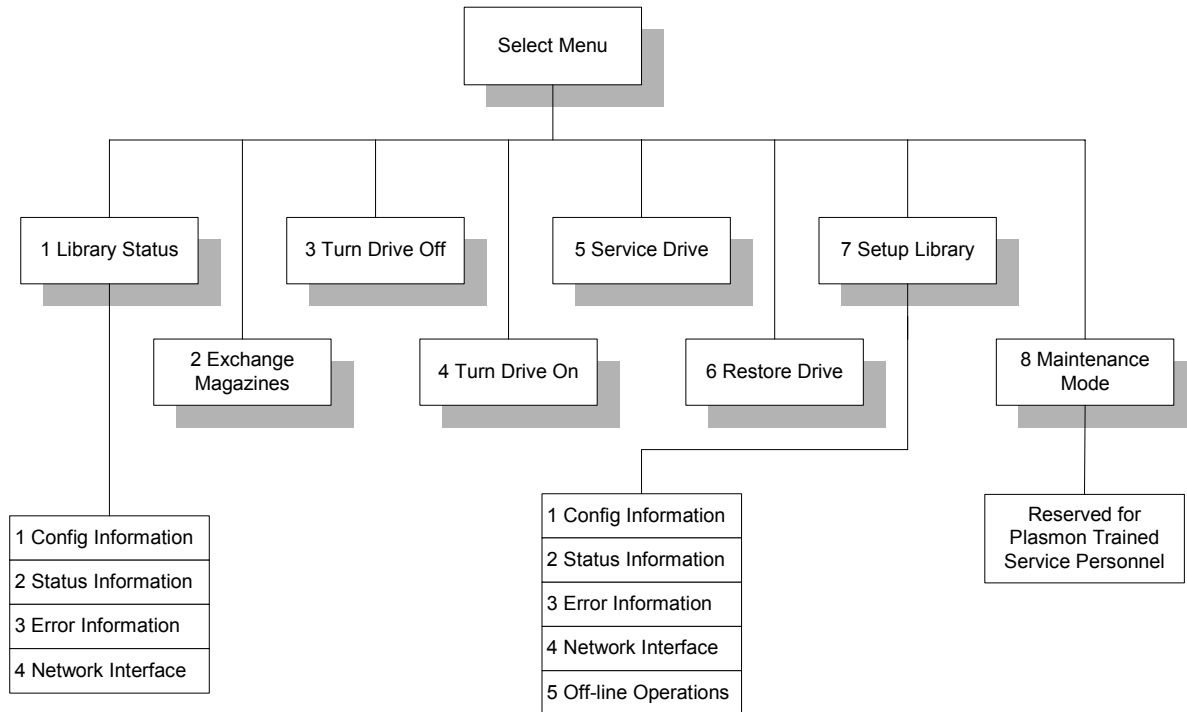

Figure 34. Main Menu Overview

Table 7. Main Menu Selections

Menu Selection	Description
1 Library Status	Allows viewing only of library settings. To make changes, use the Set Up menu.
2 Exchange Magazines	Use to release the magazine from the library.
3 Turn Drive Off	Use to turn off individual drives. Drives may not be hot-swapped in this mode. For password protected operations, the factory default password is "AAAA".
4 Turn Drive On	Use to turn on individual drives. For password protected operations, the factory default password is "AAAA".
5 Service Drives	Use to remove power from the drive to allow removal or replacement. This option takes down the entire SCSI bus the drive is on, and all drives associated with this bus loose SCSI access. For password protected operations, the factory default password is "AAAA".
6 Restore Drives	Use to restore power to the drives after removal or replacement. For password protected operations, the factory default password is "AAAA".
7 Set Up Library	Allows viewing and changing of library settings. When performing operations from the Set Up menu, the library is taken off-line.
8 Maintenance Mode	Allows testing, setting up, or configuring the library. When performing operations from the Maintenance Mode menu, the library is taken off-line. These operations are reserved for Plasmon authorized service personnel. For password protected operations, the factory default password is "AAAA".

Library Status Menu Overview

Use the Library Status menu to view the library's status only. To make changes to the library's status, use the Set Up menu.

The figure below shows the Library Status menu options.

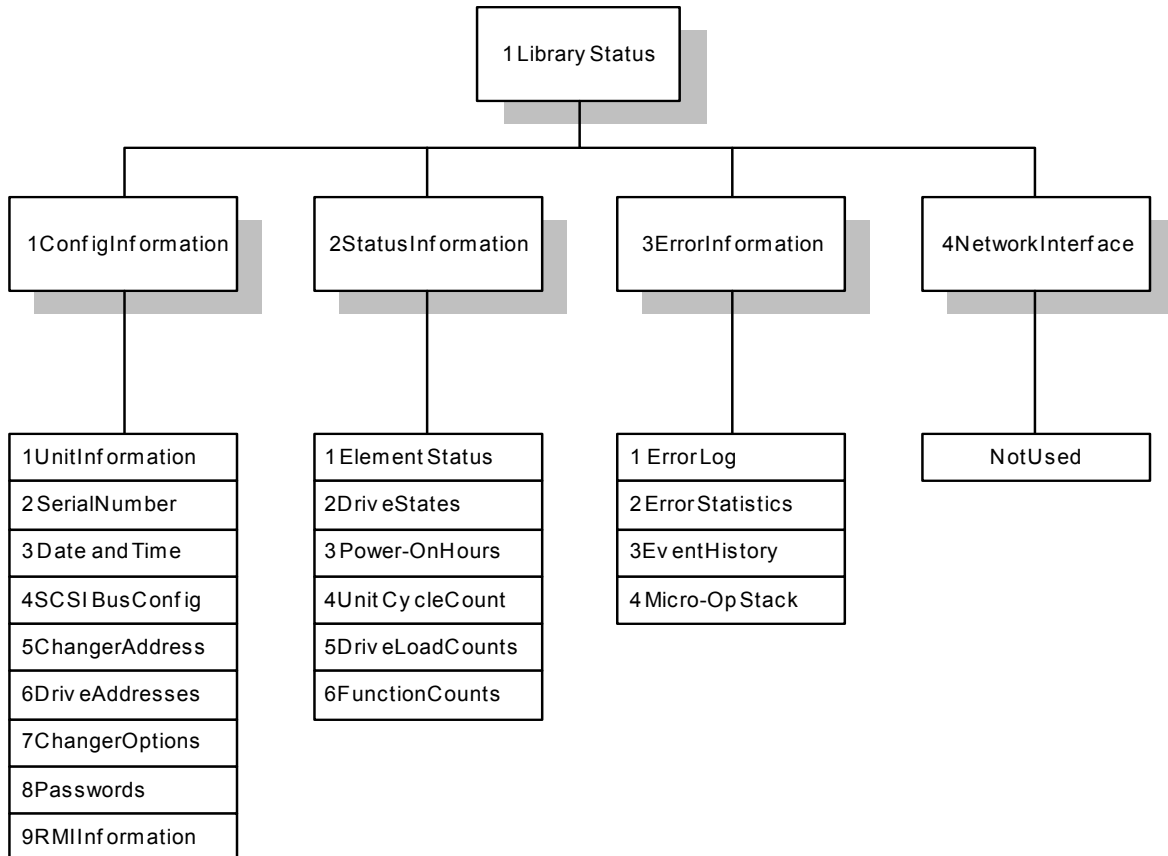

Figure 35. Library Status Menu Options

Table 8. Library Status Menu Selections

Menu Selection	Description
1 Config Information	Allows viewing only of library configuration settings.
1 Unit Information/Config	To view the storage slot count, drive count, and firmware revision.
2 Serial Number	To view the serial number assigned to the library.
3 Date and Time	To view the current date and time settings.
4 SCSI Bus Config	To view the current SCSI Bus configuration
5 Changer Address	To view the changer SCSI ID.
6 Drive Addresses	To view individual drive SCSI IDs.
7 Changer Options	To view changer options: Disable Tray Return (default Y or N) Tray Return on Power (Y or default N) Disable Autoload/Eject (Y or default N) Ignore Recovery Errors (Y or default N) Limit Recovery (Y or default N) Enable All Uattn (Y or default N)
8 Passwords	This option is not available when library is online.
9 RMI Information	Not supported.
2 Status Information	Allows viewing only of library status.
1 Element Status	To view which elements (slots, drives, pickers, or I/E station) are populated by media.
2 Drive States	To view the power on/off state of a drive.
3 Power-On Hours	To view total hours of power to library. Useful for preventive maintenance. Cannot be reset.
4 Unit Cycle Count	To view total cycle count since first startup. Cannot be reset.
5 Drive Load Counts	To view total drive loads since last reset of count.
6 Function Counts	To view total function counts since last reset of count. Lift Movement Count Picker 1 Movement Count Picker 2 Movement Count Change Picker Count Pivot L/R Col Movement Count Mag Door Open Count Disk Flip Count Cumul Lift Dist Cumul Picker Dist Cumul Pivot Rotation

Menu Selection	Description
3 Error Information	Allows viewing only of library error information.
1 Error Log	To view a chronological list of last ten errors since log was last cleared.
2 Error Statistics	To view a list of the ten most frequent errors since list was last cleared.
3 Event History	To view the SCSI command event history since it was last reset. Only SCSI commands which affect library operations are recorded.
4 Micro-Op Stack	To view a list of operations performed for the last failing SCSI command. These micro operations include position, position and flip, pick, store, load, and unload. The list includes forward and backward operations (media movement, and undo and retry for attempted failure recovery). This log is cleared whenever the system is initialized.
4 Network Interface	Not Used.

Set Up Library Menu Overview

Use the Set Up Library menu to change the library's status. When performing operations in the Set Up Library menu, the library is taken off-line.

The figure below shows the Set Up Library menu options.

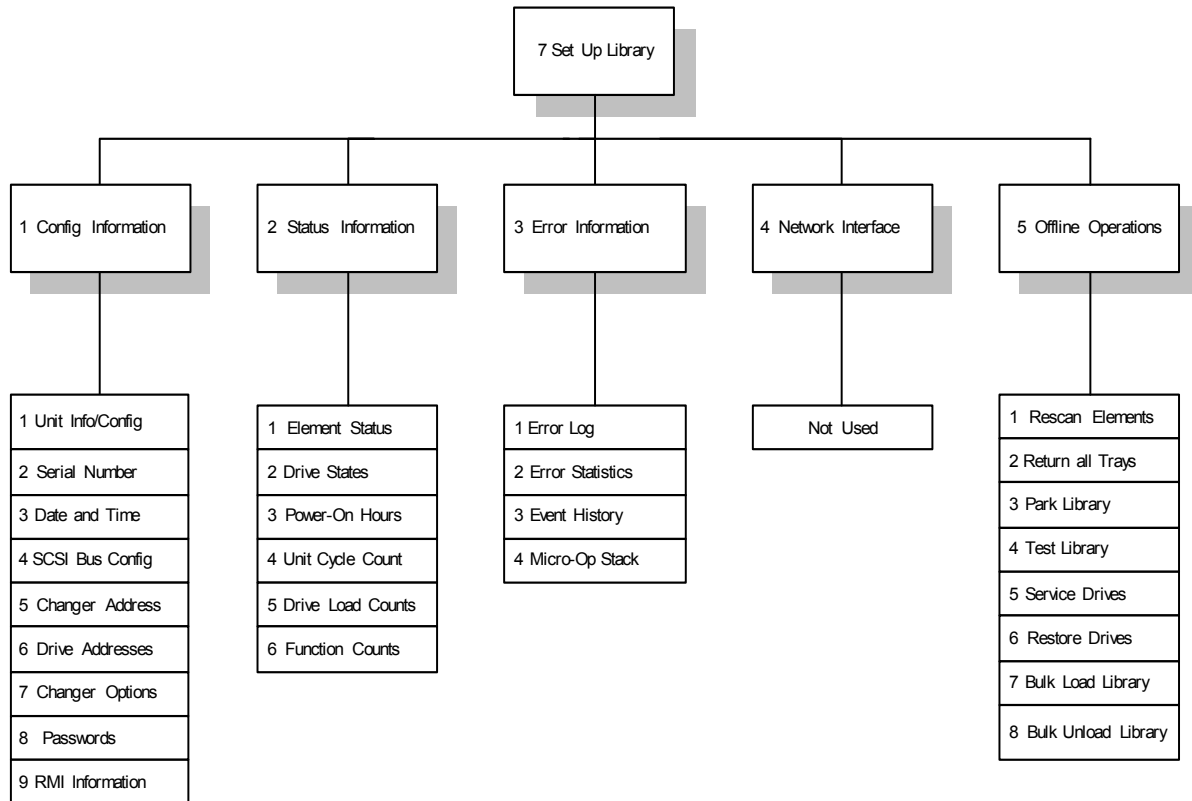

Figure 36. Set Up Library Menu Options

Table 9. Set Up Library Menu Selections

Menu Selection	Description
1 Config Information	Allows viewing and editing of library configuration settings.
1 Unit Information/Config	To view the storage slot count, drive count, and firmware revision.
2 Serial Number	To view the serial number assigned to the library.
3 Date and Time	To view/edit the current date and time settings.
4 SCSI Bus Config	To view the current SCSI bus configuration.
5 Changer Address	To view/set the changer SCSI ID.
6 Drive Addresses	To view/set individual drive SCSI IDs.
7 Changer Options	To view/edit changer options:
Disable Tray Return	Disables return of media trays to their magazines when entering Magazine Exchange mode.
Tray Return On Power	Enables the return of media trays to the magazines upon library power on.
Disable Auto LD/EJ	Disables auto clamping and unclamping of the media tray.
Ignore Recover Errs	If library can recover from an error, it will keep operating and not report the error.
Limit Recovery	To limit error recovery effort to four tries.
Enable All UATTN	Enable all unit attention conditions to host.
8 Passwords	To set or change passwords. To remove password protection from a menu selection, press the check mark without entering any letters. The factory default password is AAAA. If a password is forgotten or lost, please contact Plasmon support.
9 RMI Information	Not supported.
2 Status Information	Allows viewing/editing of library status.
1 Element Status	To view/edit which elements (slots, drives, pickers, or I/O stations) are populated by media trays. Individual slot status can be set to full or empty.
2 Drive States	To view a drive's on/off state.
3 Power-On Hours	To view total hours of power to library. Useful for preventive maintenance. Cannot be reset.
4 Unit Cycle Count	To view total cycle count since first startup. Cannot be reset.
5 Drive Load Counts	To view/reset total drive loads since last reset of count.

Menu Selection	Description
6 Function Counts	To view/reset total function counts since last reset of count. Lift Movement Count Picker 1 Move Count Picker 2 Move Count Change Picker Count Pivot Col Move Count Mag Door Open Count Disk Flip Count Cumul Lift Dist Cumul Picker Dist Cumul Pivot Rotation
3 Error Information	Allows viewing/clearing of library error information.
1 Error Log	To view/clear a chronological list of last ten errors since log was last cleared. The first on the list is the most recent.
2 Error Statistics	To view/clear a list of the ten most frequent errors since list was last cleared.
3 Event History	To view/clear the SCSI command event history since it was last reset. Only SCSI commands which affect library operations are recorded.
4 Micro-Op Stack	To view a list of operations performed for the last failing SCSI command. These micro operations include position, flip, pick, store, load, and unload. The list includes forward and backward operations (media movement, and undo and retry for attempted failure recovery). This log is cleared whenever the system is initialized. This error should be reported to Plasmon for decoding.
4 Network Interface	Not Used.
5 Offline Operations	Allows basic offline operations.
1 Rescan Elements	Scans all storage slots and drives to identify media present.
2 Return All trays	Returns all magazine trays to their magazines.
3 Park Library	To park the picker before shipping or moving the library. Also, remove all media before moving the library.
4 Test Library	To perform basic sensor and motor tests.
5 Service Drives	To turn a drive off and temporarily terminate the SCSI bus for drive replacement.
6 Restore Drives	To turn a drive on and remove temporary SCSI bus termination after drive replacement.
7 Bulk Load Library	Allows initial high speed bulk loading of required media.
8 Bulk Unload Library	Allows unloading the entire library for packing and shipping.

APPENDIX A

SPECIFICATIONS

Overall Library Specifications

The following table provides information about the Plasmon D875 - D2175 libraries. These specifications are subject to change without notice.

Table 10. D875 - D2175 Specifications

Specification	D875	D1525	D2175
Number of Storage Slots ¹	750 - 875	1400 - 1525	2050 - 2175
Library Capacity (TBytes) ¹	7.1 - 8.2	13.1 - 14.3	19.2 - 20.4
Media Transport Times: Swap Times Flip every other access Flip one way Never Flip Exchange Times Flip 1/2 time No Flip	15.3 seconds / 235 swaps per hour 11.9 seconds / 302 swaps per hour 8.5 seconds / 425 swaps per hour 9.8 seconds 6.39 seconds		
Maximum Number of Drives	12	12	12
Library Reliability (MSBF)	>2,500,000	>2,500,000	>2,500,000
Rotation Station TM	Standard	Standard	Standard
Picker Type	Dual	Dual	Dual
Import / Export Port	Ten-Slot Magazine	Ten-Slot Magazine	Ten-Slot Magazine
Removable Storage Slots	Five Ten-Slot Magazines	Five Ten-Slot Magazines	Five Ten-Slot Magazines
Library Interface	LVD (Auto - Sensing), SCSI 2 and SCSI 3 Compliant 68-pin high density female connector		
Warranty	1 Year (First year on-site 5X9 next business day)		
Dimensions - Stand Alone			
Height	68 in (172.3 cm)	68 in (172.3 cm)	68 in (172.3 cm)
Width	27.2 in (69.1 cm)	35 in (89 cm)	41.2 in (105 cm)
Depth	36 in (91.4 cm)	36 in (91.4 cm)	36 in (91.4 cm)
Weight	491 lbs (223 kgs)	631 lbs (286 kgs)	771lbs (350 kgs)

Specification	D875	D1525	D2175
Dimensions - Shipping	Library	One expansion bay	Two expansion bays
Height	76.5 in (194.3 cm)	72.5 in (184.2 cm)	72.5 in (184.2 cm)
Width	49 in (124.5 cm)	34 in (86.3 cm)	34 in (86.3 cm)
Depth	37 in (94 cm)	35 in (89 cm)	35 in (89 cm)
Weight	571 lbs (259 kgs)	185 lbs (84 kgs) ² (see D875 dimensions)	325 lbs (148 kgs) ² (see D875 dimensions)
Operating Temperature	50 to 90F / 10 to 32C		
Non - Operating Temperature	-40 to 158 F / -40 to 70 C		
Operating Humidity	10 to 90% RH (non-condensing)		
Operating Voltage	100 to 240 VAC (Auto ranging power supply)		
Operating Frequency	50 / 60 Hz		
Power Consumption (2 Drives)	145 W / 495 BTU/hr		
Power Consumption (12 Drives)	285 W / 972 BTU/hr If the third power supply is installed, add 37 W / 126 BTU/hr		
Options	Redundant Power Supplies Kit for adding two or three SCSI Busses ³		

¹ = Actual number of slots and library capacity depends on drive configuration.

² = Represents the shipping weight of each expansion bay. The expansion bays are shipped on a separate pallet.

³ = Additional SCSI busses required depending on number of drives.

Table 11. Media Specifications

Specification	Limits
Environmental	
Operating Temperature (at 1000 ft or less ASL)	+10 to +32°C (+50 to +90° F)
Non-Operating Temperature	- 40 to +50°C (- 40 to +122°F)
Max Gradient Temperature / hr	10° C (18°F per hour)
Operating Humidity	10 to 85% RH <i>non-condensing</i>
Non-Operating Humidity	10 to 95% RH <i>non-condensing</i>

Power Cable Specification

The voltage rating and the current rating of the power cord set shall be higher than the rated voltage and current of this unit. The voltage rating of the power cord set shall be higher than the power source.

For the U.S. and Canada:

Power cord must be UL listed and CSA labeled. Type SJT, SVT, ST, SJO or SO, 3-conductors, No. 18 AWG, rated 125v, 10A

For Germany and continental Europe:

STROMANFNAHME: 100-240 VAC, 50/60 Hz, 6A.

Für eine 230V-Anwendung, ist eine harmonisierte <HAR> konfektionierte Leitungsschnur, Typ H05vvf3G1.00, die für 250V/10A oder die Gleichwertigkeit geeignet ist, zu benutzen.

If there are any questions in regards to the proper cord sets, consult the distributor.

SCSI Cable Specification

SCSI Cables and Connectors

Plasmon recommends using Wide LVD SCSI cables and connectors that conform to SCSI-3 specifications.

NOTE

To comply with the regulations and standards in this manual, all SCSI cables and connectors used with the library must be properly shielded.

SCSI Cable Length

Plasmon recommends using SCSI cables that conform to SCSI-3 specifications with high density 68-pin connectors. The following table shows the allowable cable lengths for the LVD SCSI interface.

Table 12. Maximum Allowable SCSI Cable Length (LVD)

	Library Internal Cable Length	Allowable External Cable Length
Bus 1	10 ft (3 M)	29 ft (9 M)
Bus 2	3 ft (1 M)	36 ft (12 M)
Bus 3	3 ft (1 M)	36 ft (12 M)

SCSI Termination

The Plasmon D875 - D2175 libraries are terminated internally. No external termination is required.

APPENDIX B

SCSI BUS INFORMATION

SCSI Bus Configurations

The following three figures show how to connect drives for single, dual and triple SCSI bus configurations. Each bus in the library supports a maximum of four drives. The library address should always be assigned to SCSI Bus 1.

Single Bus Configuration

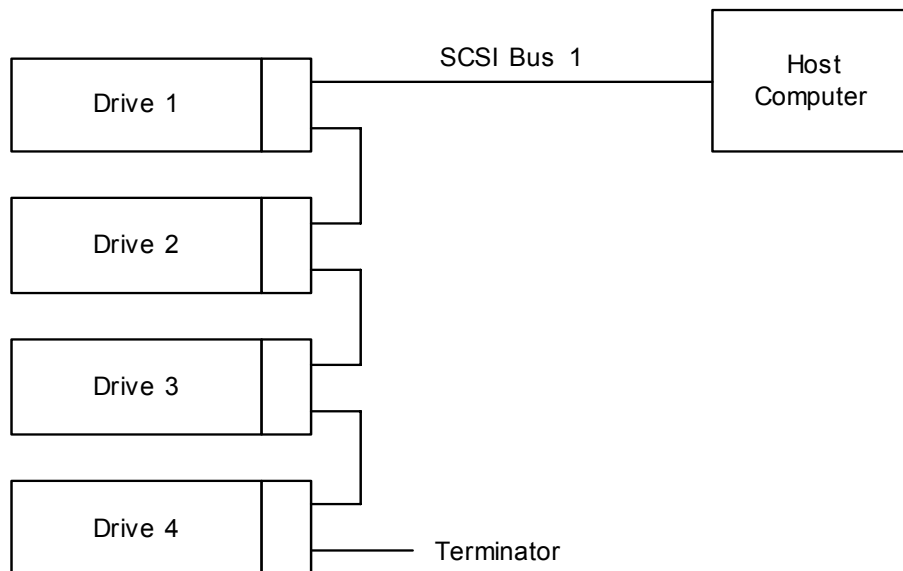

Figure 37. Single Bus Configuration

Dual Bus Configuration

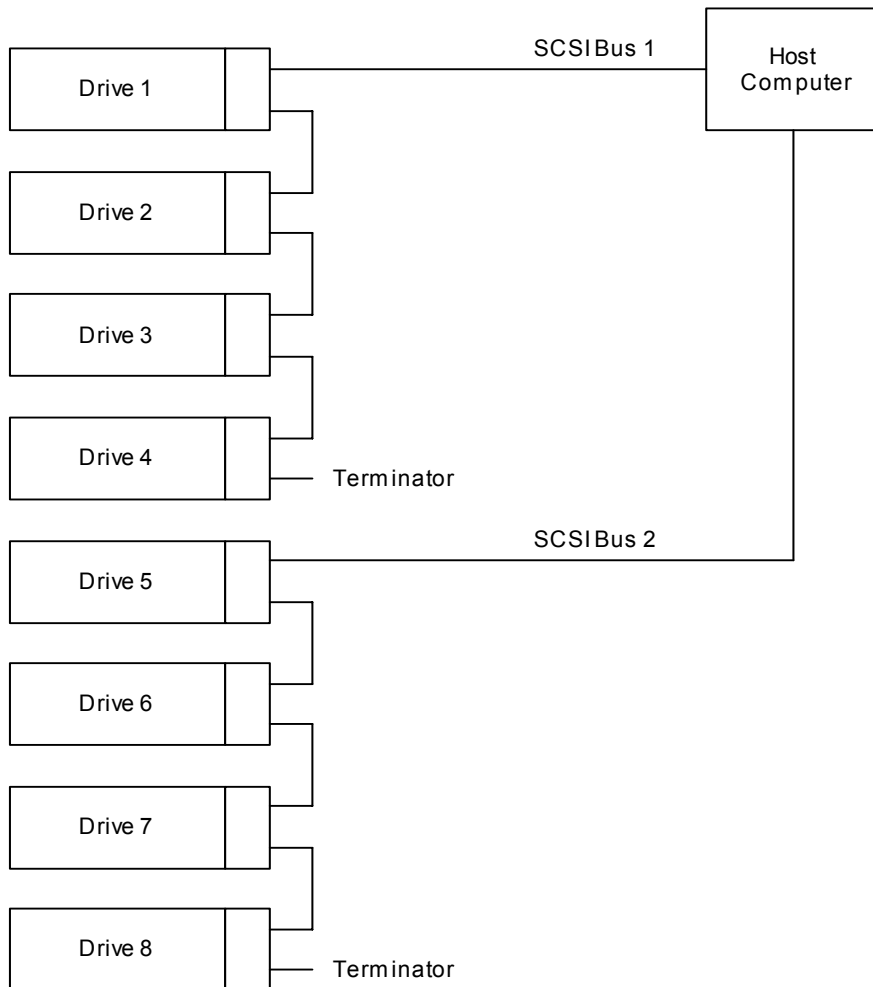

Figure 38. Dual Bus Configuration

Triple Bus Configuration

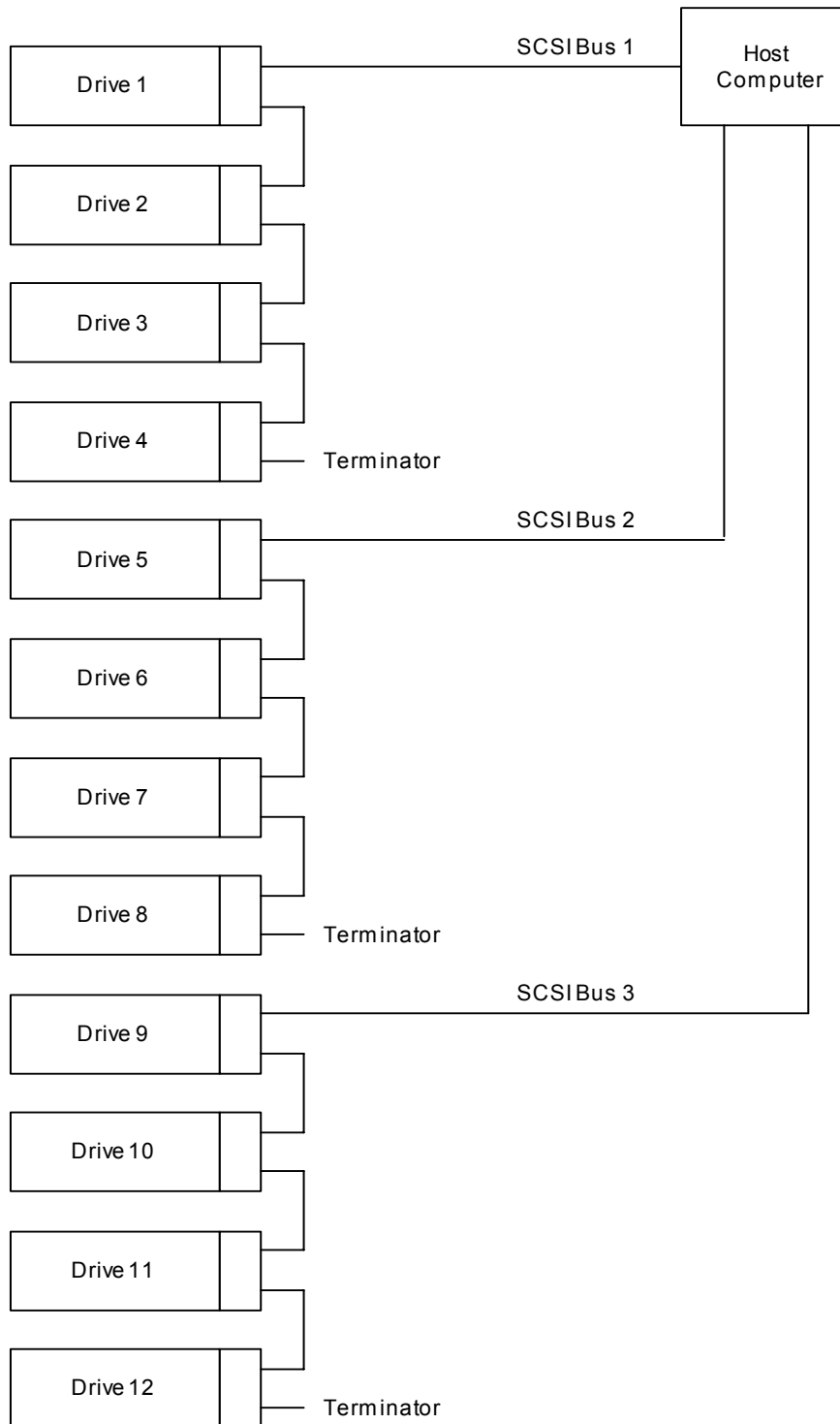

Figure 39. Triple Bus Configuration

SCSI ID Configuration

The SCSI IDs are set at the factory to the following settings for the Plasmon D875 - D2175 libraries:

Table 13. Factory Default SCSI IDs for the D875 - D2175 Libraries

Device	Bus Config 1		Bus Config 2		Bus Config 3		Bus Config 4		Bus Config 5		Bus Config 6		Bus Config 7	
	SCSI Bus	SCSI ID	SCS Bus	SCSI ID	SCSI Bus	SCSI ID	SCSI Bus	SCSI ID	SCSI Bus	SCSI ID	SCSI Bus	SCSI ID	SCSI Bus	SCSI ID
Drive 1	1	0	1	0	1	0	1	0	1	0	1	0	1	0
Drive 2	1	1	1	1	1	1	1	1	1	1	1	1	1	1
Drive 3	1	2	2	0	1	2	1	2	1	2	1	2	1	2
Drive 4	1	3	2	1	1	3	1	3	1	3	1	3	1	3
Drive 5					2	0	2	0	2	0	2	0	2	0
Drive 6					2	1	2	1	2	1	2	1	2	1
Drive 7							2	2	3	0	3	0	2	2
Drive 8							2	3	3	1	3	1	2	3
Drive 9											3	2	3	0
Drive 10											3	3	3	1
Drive 11													3	2
Drive 12													3	3
Changer Device	1	6	1	6	1	6	1	6	1	6	1	6	1	6

Drive Combinations

The information in the table below shows the maximum drive combinations for three SCSI busses.

Note that DVD-R drives may only be used on Bus 2 and Bus 3.

Table 14. SCSI Bus and Drive Combinations

Drive Combination	Bus 1 Maximum Number of Drives	Bus 2 Maximum Number of Drives	Bus 3 Maximum Number of Drives	Maximum Total Number of Drives
DVR - RAM only	4	4	4	12
DVD - R only	0	2	2	4
DVD - RAM / DVD - R	4 (DVD - RAM only)	2 (DVD - R only)	2 (DVD - R only)	8
Multi Drive	4	4	4	12
Maximum Drives per Bus	4	4	4	12 (maximum drives for the library)

APPENDIX C

SAFETY AGENCY STANDARD

The D875 - D2175 library is in compliance with the following domestic and international product safety standards when the unit is properly installed and operated in accordance with the product documents.

Safety	IEC 60950 3rd Edition: (1999), UL 60950 3rd Edition: (2000), CSA C22.2 No.60950
Emission	EN 55011 Class A, EN 55022 / CISPR 22 Class A, FCC Class A, CNS 13438 Class A, EN 61000-3-2, EN 61000 3-3
Immunity	EN 55024

FCC Notice

This equipment has been tested and found to comply with the limits for a Class A digital device, pursuant to part 15 of the FCC Rules. These limits are designed to provide reasonable protection against harmful interference when the equipment is operated in a commercial environment. This equipment generates, uses, and can radiate radio frequency energy and, if not installed and used in accordance with this instruction manual, may cause harmful interference to radio communications. Operation of this equipment in a residential area is likely to cause harmful interference in which case the user will be required to correct the interference at his own expense.

Shielded cables are required for this device to comply with FCC Rules. Use shielded cables when connecting this device to others.

Industry Canadian Notice per ICES-003

English: This Class A digital apparatus meets all requirements of the Canadian Interference-Causing Equipment Regulations.

French: Cet appareil numérique de la classe A respecte toutes les exigences du Règlement sur le matériel brouilleur du Canada.

Australia / New Zealand

This equipment has been tested and complies with AS/NZS 3548.

Taiwan (BSMI) Class A Warning Statement

警告使用者

這是甲類的資訊產品，在居住的環境中使用時，可能會造成射頻干擾，在這種情況下，使用者會被要求採取某些適當的對策。

Laser Safety Notice

This library is a Class 1 Laser Product.

CDRH Regulations

The Center for Devices and Radiological Health (CDRH) of the U.S. Food and Drug Administration implemented regulations for laser products on August 2, 1976. These regulations apply to laser products manufactured from August 1, 1976. Compliance is mandatory for products marketed in the United States.

Lithium Battery

The Main Control Board and the Front Control Panel contain a lithium battery which could explode if incorrectly replaced. Replace only with a qualified replacement battery. Return the old battery to the manufacturer for disposal or dispose of in accordance with local regulations for the disposal of lithium batteries.

“ATTENTION: IL Y A DANGER D’EXPLOSION S’IL Y A REMPLACEMENT INCORRECT DE LA BATTERIE. REMPLACER UNIQUEMENT AVEC UNE BATTERIE DU MEME TYPE OU D’UN TYPE RECOMMANDE PAR LE CONSTRUCTEUR. METTRE AU REBUT LES BATTERIES USAGEES CONFORMEMENT AUX INSTRUCTIIONS DU FABRICANT.”

Vorsicht! Explosionsgefahr bei unsachgemabem Austausch der batterie. Ersatz nur durch denselbel oder einen vom Hersteller empfohlenen gleichwertigen Typ. Entsorgung gebrauchter Batterien nach Angaben des Herstellers.

APPENDIX D

ERROR CODES

If an error occurs while on-line, the library retries the operation that failed. If the retried operation fails, the library attempts to return the media to its location before the operation and sends an error code to the host computer. This error code is displayed on the front panel display of the library.

The following error codes are provided to assist in detecting and finding the corrective action for a library error. Note the error code number displayed on the front panel display, and find the corresponding error code in the following table. The table is sorted by error code number.

CAUTION



The corrective actions shown in the error code table should only be performed by qualified Plasmon trained personnel.

Example:

When a library error occurs, the LCD screen displays the error temporarily as shown below

```
ERROR 03
NVRAM FAIL
SUBCODE: 01
[ F SELECT] [C] [ ]
```

Press [C] to clear the error

After a few seconds the display changes as shown below:

```
D: ----- TT:--
MAG: . . . . . I: . E03
[ F SELECT] [?] [ ]
```

Press [?] to re-display the error

Table 15. D875 - D2175 Error Codes

Error Code (hex)	Sub-code	Error Description	Subcode Description	Component	Corrective Action
00	0	Unknown error	No additional info		No additional info
02	1	Flash checksum	Found during SCSI send diagnostics		Replace Main controller, or flash FW download performed
	2		Found during period check		
03	1	NVRAM fail	Failure in startup	Main controller circuit board	Replace Main controller
0A	1	Bad element code		Firmware	Download new firmware
0C	1	OP stack overflow	Recording operation	Firmware	Download new firmware
	2		Undoing operation		
0D	1	Bad OP stack index	Nothing to undo	Firmware	Download new firmware
	2		Invalid undo operation code		
0E	group #	Flash program fail (main code)	Code down load progress (MAIN code)	Main controller or Firmware	Replace Main controller download new firmware
0F	group #	Flash program fail (DSP)	Code download progress (DSP code)	Main controller or Firmware	Replace Main controller download new firmware
11	1	DSP not responding	No response for lift motor movement command	Main controller or Firmware	Replace Main controller download new firmware
	2		No response for picker motor movement command		
	3		No response for pivot motor movement command		
	4		No response SSC of DSP		

Error Code (hex)	Sub-code	Error Description	Subcode Description	Component	Corrective Action
	5		No communication response from DSP for a command sent		
12	1	Cable connect fail	Bad CJ5 cable, main controller to VP decoder circuit board		
	2		Bad cable, VP decoder CJ2 to upper sensors		
	3		Main circuit board cable fail, CJ4 (To Pivot, Lift circuit board)		
	4		Main circuit board cable fail, CJ5 (to VP decoder circuit board)		
	5		Main circuit board cable fail, CJ7 (interlock, reference sensor)		
	6		Main circuit board cable fail, CJ10 (To PWR dist circuit board - supply monitor)		
	7		Drive interface CJ5 to SCSI converter		
	8		Drive interface CJ11 to SCSI converter		
	9		Magazine interface CJ4 to magazine detector circuit board		
	10		Magazine interface CJ7 to Access door solenoid & sensor		
	11		Magazine interface CJ8 to flipper		
	12		Drive interface circuit board, bad address plug CJ8		
	13		Magazine interface circuit board, bad address plug CJ3		

Error Code (hex)	Sub-code	Error Description	Subcode Description	Component	Corrective Action
13	1	Fuse overload	Main controller fuse 1 overload +24V interface CJ3 to CAN bus		
	2		Main controller fuse 2 overload +5v interface CJ3 to CAN bus		
	3		Main controller fuse 3 overload +24V interface CJ4 to pivot, lift, MTE		
	4		Main controller fuse 4 overload +5V interface CJ4 to pivot, lift, MTE		
	5		Main controller fuse 5 overload +5V interface CJ5 to VP decoder		
	6		Main controller fuse 6 overload +5V interface CJ8 to MC SCSI adapter		
	7		Main controller fuse 7 overload +12V interface CJ8 to MC SCSI adapter		
	8		Main controller fuse 9 overload +5V interface CJ12 to External SCSI interface circuit board		
	9		Main controller fuse 10 overload +24V for lift motor, & interface CJ4 to pivot & lift circuit board's		
	10		Main controller fuse 11 overload +24V for stepper motors, & interface CJ4 to pivot, lift, MTE		
	11		Drive interface 3V regulator overload (U14)		
	12		Drive interface 12V fuse overload (F2)		

Error Code (hex)	Sub-code	Error Description	Subcode Description	Component	Corrective Action
	13		Drive interface 24V fuse overload (F3)		
	14		SCSI Converter SE term pwr fuse overload (F1) to drive modules		
	15		SCSI Converter SE term pwr fuse overload (F1) to drive modules		
	16		SCSI Converter LVD term pwr fuse overload (F2) to bus 1 or bus 3		
	17		SCSI Converter LVD term pwr fuse overload (F2) to bus 2		
	18		Magazine interface 3.3V regulator overload (U4)		
	19		Magazine interface access door solenoid 24V fuse overload (F2)		
	20		Magazine interface flipper 24V fuse overload (F3)		
	21		Power distribution fuse 1 overload +5V interface CJ7 for Power to Mag. circuit board		
	22		Power distribution fuse 2 overload +5V interface CJ7 for Power to RMI circuit board		
	23		Power distribution fuse 3 overload +24V interface CJ7 for Power to Mag. circuit board		
	24		Power distribution fuse 4 overload +24V interface CJ7 for Cabinet cooling fans		
14	1	Circuit board fail	Comm error with VP decoder circuit board		

Error Code (hex)	Sub-code	Error Description	Subcode Description	Component	Corrective Action
	2		VP Decoder circuit board control failure		
	3		More than one column blocked on VP decoder circuit board		
	4		VP Emitter / detector failure		
	5		VP Emitter / Detector circuit board margin test fail		
	6		VP Emitter / Detector circuit board blocked response test fail		
	7		Unblocked response test fail (VP Emitter / Detector circuit board)		
	8		Drive interface I/O loop-back test failed		
	9		Drive interface 3.3V failure		
	10		Drive interface 2V failure		
	11		Drive interface 24V failure		
	12		SCSI Converter SE term power bad bus 1 or bus 3		
	13		SCSI Converter LVD term power bad bus 1 or bus 3		
	14		SCSI Converter SE term power bad bus 2		
	15		SCSI Converter LVD term power bad bus 2		
	16		Mag interface not present		
	17		Main controller crystal failure		

Error Code (hex)	Sub-code	Error Description	Subcode Description	Component	Corrective Action
15	1	Can time out - drive	CAN time out checking drive interface	Drive interface circuit board, CAN cables	Replace drive interface circuit board or CAN cables
	2		CAN time out getting drive status		
	3		CAN time out getting SCSI converter status		
	4		CAN time out getting fan tach values		
	5		CAN time out setting drive loaded		
	6		CAN time out setting drive unloaded		
	7		CAN time out setting drive id		
	8		CAN time out powering on drive		
	9		CAN time out getting drive type		
	10		CAN time out powering off drive		
	11		CAN time out clamping drive		
	12		CAN time out unclamping drive		
	13		CAN time out completing clamp/unclamp drive		
	14		CAN time out isolating bus		
	15		CAN time out restoring bus		
	16		CAN time out blinking LED for drive status		
	17		CAN time out turning off LED for drive status		

Error Code (hex)	Sub-code	Error Description	Subcode Description	Component	Corrective Action
16	1	Can time out - mag board	CAN time out sending command to flipper	Magazine interface circuit board, CAN cables	Replace magazine interface circuit board or CAN G103 cables
	2		CAN time out reading flipper EEPROM		
	3		CAN time out writing flipper EEPROM		
	4		CAN time out checking mag interface circuit board		
	5		CAN time out read mag sensors		
	6		CAN time out reading mag interface circuit board temp		
	7		CAN time out turning on mag LED		
	8		CAN time out turning off mag LED		
	9		CAN time out blinking mag LED		
	10		CAN time out firing mag door solenoid		
	11		CAN time out start verify temp		
	12		CAN time out reset mag door state		
17	1	Main board SCSI termpower	No term pwr at MC SCSI adapter circuit board		
18	1	Power supply voltage	5V out of range during check main circuit board cable check	Bad power supply	Replace power supply
	2		12V out of range during check main circuit board cable check		

Error Code (hex)	Sub-code	Error Description	Subcode Description	Component	Corrective Action
	3		24V out of range during check main circuit board cable check		
19	1	Power supply fail	One of the power supply has been removed	Power supply, or supply cable	Replace power supply, check supply cable
	2		Power supply fan has failed		
	3		Power supply power failure		
1A	1	SCSI bus isolation	Time out waiting for isolate bus command to complete		
	2		Time out waiting for isolate bus to complete while restoring bus		
1B	1	Too few power supplies	More than one drive interface board and only one power supply		Add power supply
22	1	Bus already isolated	Service drives, isolate request and bus already isolated		
	2		Restore drives, isolate request and bus already isolated		
23	1	Bus not isolated	Service drives, un-isolate request and bus not isolated		
	2		Restore drives, un-isolate request and bus not isolated		
31	1	Drive not installed	Positioning to drive	Drive interface cables	Replace cables or drive interface circuit board or configure in drive
	3		Checking a move from a drive		
	4		Checking a move to a drive		

Error Code (hex)	Sub-code	Error Description	Subcode Description	Component	Corrective Action
	5		Checking a SCSI position to drive command		
32	1	Drive not connected	Drive not connected that was previously installed	Drive interface cables	Replace or reconnect drive cables
	2		Drive not connected when restoring drives		
33	1	Drive clamp fail	Drive clamp fail while loading drive	Drive, drive cables	Replace drive or cabling
34	1	Drive unclamp fail	Drive unclamp fail unloading drive retry	Drive, drive cables	Replace drive or cabling
35	1	Drive load fail	Tray not seen in picker while picker moving to load position	MTE sensor	Replace MTE
	2		VP or Tray sensor blocked after retracting picker to fwd position	MTE sensor, VP sensor	Replace MTE, VP sensor, run offsets to correct positioning
	3		Drive not set to loaded		
	4		Drive load retry aborted		
36	1	Drive unload fail	Drive not unclamped	Drive, drive cables	Replace drives or cables
	2		Pick finger did not hold on to tray, VP or Tray sensor blocked	Alignment problem	Run offsets
	3		No tray seen in unload attempt	Alignment problem, MTE tray sensor	Run offsets, replace MTE
	4		Picker Tray sensor blocked during tray only check of drive unload	Alignment problem, MTE tray sensor	Run offsets, replace MTE
	5		Picker Tray sensor unblocked during tray only check of drive unload	Alignment problem, MTE tray sensor	Run offsets, replace MTE
37	1	Drive is clamped	Drive is clamped, can't unclamp (checking move from a drive)	Drive, drive cables	Replace Drive, drive cables

Error Code (hex)	Sub-code	Error Description	Subcode Description	Component	Corrective Action
	2		Drive is clamped, can not unclamp (checking move to a drive)	Drive, drive cables	Replace Drive, drive cables
38	1	Drive in service state	In service state, attempting to turn drive off in maint menu		Follow operating instructions
	2		In service state, attempting to turn drive on in maint menu		
	3		In service state, attempting to put drive in service state via SCSI command		
39	1	Drive not in service state	Restoring drives, not in a service state		Follow operating instructions
3F	1	Drive Addr conflict	Address conflict with changer		Correct address in setup configuration
	2		Address conflict with another drive		
40	1	Not supported by bus config.	Attempt to put drive in service state via SCSI, drive not supported by current bus config.		
	2		Attempt to restore drive via SCSI, drive not supported by current bus config.		
41	1	Drives overheating	Warning for an overheating drive	Cabinet Temp	Check room temp
42	1	Drives shutdown - heat	Drive will be shutdown due to overtemp condition, alert host of 90 sec delay before shutdown	Cabinet Temp	Check room temp
43	1	Low fan speed-drive	Warning for low fan speed in a drive module	Fan	Replace fan
44	1	Drive shutdown-fan	Drive will be shutdown due to fan failure, alert host of 90 sec delay before shutdown	Fan	Replace fan

Error Code (hex)	Sub-code	Error Description	Subcode Description	Component	Corrective Action
51	1	Picker pos fail	Picker position was terminated on home from store attempt	Alignment problems	Run offsets, replace tray
	2		Picker did not reach position intended		
	3		Lift motor not previously homed before picker position attempt		
	4		Unknown picker position destination state		
	5		Picker failed to reach home as its destination		
	6		Picker stalled while picking tray, lost steps going to home position		
	7		Picker stalled while moving out to store a media tray. This problem is detected when the picker returns to the home position		
	8		Picker home sensor not blocked after picking a tray.		
	9		Edge of picker not seen by Tray sensor while positioning to home		
	10		Pick home sensor blocked, positioning to destination other than home	Obstruction or alignment	Clear obstruction, run offsets
52	1	Swap pickers fail	Could not change the active picker (selector nut pawl or spring may be damaged)	MTE	Replace MTE
54	1	Picker misposition	Picker finger is in a danger zone for moving the lift	Alignment problems, MTE	Run offsets or replace MTE

Error Code (hex)	Sub-code	Error Description	Subcode Description	Component	Corrective Action
	2		Lift motor not homed or invalid lift position, Picker edge is blocking the Tray sensor		
	3		Picker edge is blocking the Tray sensor during a position attempt		
55	1	Picker not at drive	Picker not positioned in front of drive during load drive attempt		Position to drive
	2		Picker not positioned in front of drive during unload drive attempt		
57	1	Pick tray fail	VP or Tray sensor blocked by tray, picker finger disengaged from tray after starting to pick media	Alignment problem	Run offsets. Replace tray
	2		Picker Tray sensor blocked on tray only check after picking tray		
	3		Picker Tray sensor not blocked on tray only check after picking tray		
	4		Terminated SCSI task or completion status not started during a pick tray retry		
58	1	Store tray fail	Tray front or back did not block Tray sensor during a store	Alignment or obstruction	Run offsets, replace tray
	2		Both sensors in the flipper not made after store to flipper	Alignment, flipper sensors	
	3		Picker finger did not release from the tray after store attempt, VP or Pemt blocked	Alignment	

Error Code (hex)	Sub-code	Error Description	Subcode Description	Component	Corrective Action
	4		Terminated SCSI task or completion status not started during a store tray retry		
61	1	Lift Position fail	Destination encoder count out of boundaries	Bad Lift motor/ encoder	Replace lift motor
	2		Position lift destination not reached (time-out)		
	3		Destination lift position is invalid		
	4		Position retry aborted		
63	1	Lift blocked	VP sensor blocked, last col Blocked is set	Tray out of slot, Bad Vp	Reseat tray in slot, replace VP
	2		Lift is not in column of a blocked VP sensor during initialization	Bad Vp sensor, tray out slot	
	3		VP or Tray sensor blocked after storing media, during initialization.	Obstruction in slot	
	4		Blocked VP sensor not in the column clear attempt being tried		
	5		VP or Tray sensor blocked after store or load, during clear attempt.	Obstruction in slot or drive	
	6		VP or Tray sensor blocked after store operation (move from lift)	Obstruction in slot	
	7		VP or Tray sensor blocked trying to return a tray to its last known location.	Obstruction in slot, alignment	
69	1	Pivot align fail	Too much gear backlash / gear is loose during home pivot attempt	Pivot motor mounting	Realign or replace pivot motor

Error Code (hex)	Sub-code	Error Description	Subcode Description	Component	Corrective Action
6A	1	Pivot Fail	Pivot is losing position accuracy, not on alignment flag verifying pivot position	Offsets	Run offsets
	2		Outside allowed pivot soft deviation steps, but position will succeed		
	3		Outside allowed pivot soft deviation steps, but position will succeed		
	4		Outside allowed pivot hard deviation steps, position will fail		
	5		Destination pivot value out of range		
	6		Pivot position failed to be reached (time out)		
70	1	Mag door open fail	Time out waiting for mag door status	Mag interface circuit board, mag solenoid	Replace Mag circuit board or solenoid, check mechanical obstruction
71	1	Mag access door is open	Mag door open during initialization		Close door
	2		Mag door opened in online mode (not by solenoid)		
72	1	Door open prevented	SCSI prevent command was issued by host, mag door opening is not allowed		Issue SCSI allow from host
74	1	Rear door is open	Background check of rear door open during initialization		Close Rear door
	2		Background check of rear door open during online operation		
	3		Rear door open during online test ready check		

Error Code (hex)	Sub-code	Error Description	Subcode Description	Component	Corrective Action
80	1	Element not present	Checking move from an invalid fixed slot location		Correct host software
	2		Checking move to an invalid fixed slot location		
	3		SCSI position attempt to an invalid slot location		
81	1	Magazine not present	Magazine not present during verification of installation		Replace magazine
	2		Magazine not present during recovery		
84	1	Source is empty	Online check of NVRAM says source element is empty		Run Check Elements, Host needs to check inventory
	2		Online check of NVRAM says source element is empty, to element is full (not exchange command)		
	3		Src element = 1st destination element during exchange command		
85	1	Destination is full	Online check of NVRAM says destination element is full (not an exchange command)		Run Check Elements, Host needs to check inventory
	2		Online check of NVRAM says destination element is full (picker address not zero)		
	3		1st destination element = 2nd destination element during exchange command		

Error Code (hex)	Sub-code	Error Description	Subcode Description	Component	Corrective Action
	4		Picker is 2nd destination element, src element = 2nd destination element		
86	1	Element unexpectedly empty	No trays to use in cycle Full test		Run Check Elements
	2		Tray not seen during pick attempt		
87	1	Element unexpectedly full	Home sensor blocked after store attempt	Obstruction in path, Alignment problem	Check path, run offsets
	2		Picker is full, attempting to return tray to last element		
8B	1	Picker is full	VP or Pemt sensor blocked by tray moving to the pick position	Firmware, Picker faulty	Tray in picker while picking, initialize and retry, replace picker
	2		VP or Pemt sensor blocked moving to the unload drive position.		
	3		Both pickers are not empty to do an exchange (during check move)		
	4		Picker full, not a move to Lift and from Lift (during check move)		
	5		SCSI exchange 2nd destination picker, source not picker		
8C	1	Both pickers full	Check move, NVRAM says both pickers full	Main controller circuit board, firmware	Firmware recovery issue, replace Main controller circuit board
	2		Check single element, NVRAM says both pickers full		
	3		SCSI Mag door open, both pickers full so magazine can't be checked		

Error Code (hex)	Sub-code	Error Description	Subcode Description	Component	Corrective Action
8D	1	No media to flipper	No media in tray to flipper for move medium command	Need media	Provide media for use
	2		No media in source element to flipper for exchange medium command		
	3		No media in destination element to flipper for exchange medium command		
90	1	Tray in drive	Tray in a drive while attempting to park	Drive	Drive has tray, either in service mode, or bad drive
9C	1	Tray magazine unknown	Source magazine for tray unknown when returning trays to there last known elements		Recovery
9D	1	Element scan fail	Failed to position lift or picker properly while checking elements.	Alignment problem	Run offsets
	2		Invalid Element (current element check)		
B2	1	Flipper invalid position	Both flipper home sensors blocked	Flipper	Replace flipper
B3	1	FS EEPROM write fail	Write flipper EEPROM status failed	Flipper, mag interface circuit board	Replace flipper or mag interface
B4	1	Missing flipper tray	No tray in flipper (at least one required)		Replace tray
B5	1	Flipper is full	Both slots of flipper have trays		Remove tray
B6	1	Flipper comm error	Time out for flipper status command	Flipper, mag interface circuit board	Replace flipper or mag interface
	2		Time out for flipper read version command		
	3		Time out for flipper read sensors command		

Error Code (hex)	Sub-code	Error Description	Subcode Description	Component	Corrective Action
	4		Time out for flipper home CCW command		
	5		Time out for flipper home CW command		
	6		Time out for flipper step CW command		
	7		Time out for flipper step CW command		
	8		Time out for flip to CCW command		
	9		Time out for flip to CW command		
	10		Time out for fliptest command		
	11		Time out for flipper read EEPROM command		
	12		Time out for flipper write EEPROM command		
	13		Time out for flipper unlock EEPROM command		
	14		Time out for flipper lock EEPROM command		
	21		Command resent to flipper 3 times, flipper NAK'd		
	22		Comm error on status command to flipper		
	23		No ACK from flipper, command resent 3 times		
B7	21	Flipper power reset	Flipper to mag interface comm err, SNAK bit for power-up bitmask	Flipper	Replace flipper
	22		Flipper to mag interface, comm err, SNAK bit for brown-out bitmask		

Error Code (hex)	Sub-code	Error Description	Subcode Description	Component	Corrective Action
	23		Flipper to mag interface, comm err, SNAK bit for watchdog bit-mask		
B8	1	Old flipper protocol	Old version of firmware in flipper	Flipper	Replace flipper
BA	1, 2, 3	Flipper not horizontal	Neither of the flipper home sensors are blocked	Flipper	Replace flipper
BB	1	FS EEPROM lock fail	Status of locking flipper EEPROM failed	Flipper, mag interface circuit board	Replace flipper or mag interface circuit board
BC	1	FS EEPROM unlock	Status of unlocking flipper EEPROM failed	Flipper, mag interface circuit board	Replace flipper or mag interface circuit board
BD	1	FS EEPROM read fail	Error sending flipper read EEPROM command	Flipper, mag interface circuit board	Replace flipper or mag interface circuit board
	2		Status of reading flipper EEPROM failed		
BE	1	Flipper status fail	Status of reading flipper read status command failed	Flipper, mag interface circuit board	Replace flipper or mag interface circuit board
BF	1	Flipper time out	Flipper failed to complete command in allotted time	Flipper	Replace flipper
C1	1	Pick offset failure	Pick offset too many counts less than nominal	Picker Belt, Hard stop in chassis, bad picker, pick home sensor	Verify pick home sensors working, mech bind in picker travel, replace MTE
	2		Pick offset too many counts greater than nominal		
C2	1	Lift offset failure	Lift offset too many counts less than nominal	Lift home flag damaged, lift home sensor, lift motor encoder	Verify lift flag Ok, lift home sensor working, mech obstruction, lift motor encoder working

Error Code (hex)	Sub-code	Error Description	Subcode Description	Component	Corrective Action
	2		Lift offset too many counts greater than nominal		
	3		Lift offset less than negative physical boundary count		
	4		Lift offset greater than positive physical boundary count		
C3	1	Pivot offset failure	Pivot offset too many counts less than nominal	Pivot flags, pivot circuit board, pivot cable, pivot gear mesh	Verify pivot flags OK, pivot sensors working, pivot gear mesh is not too tight
	2		Pivot offset too many counts greater than nominal		
	3		Pivot offset less than negative physical boundary count		
	4		Pivot offset greater than positive physical boundary count		
C4	1	Offset target failure	Target could not be found	Offset target, offset sensor on MTE	Verify offset targets not damaged, Offset sensor is working or replace MTE
	2		Target horizontal position found crudely, but not with fine resolution		
	3		Target vertical position found crudely, but not with fine resolution		
	4		Reference target not found		
C5	1	Offset ref failure	Reference could not be found	Offset reference sensor	Verify reference sensor working, Replace MTE or detector in chassis
	2		Reference vertical position found crudely, but not with fine resolution		

Error Code (hex)	Sub-code	Error Description	Subcode Description	Component	Corrective Action
	3		Reference horizontal position found crudely, but not with fine resolution		
F7	1	SCSI parity error	SCSI parity error	Terminator or SCSI cable	Check conflicting SCSI id's
F9	1	Abort mesg received	SCSI abort mesg received	Terminator or SCSI cable	Check conflicting SCSI id's
FD	1	Host commun time out	SCSI host communications time out	Terminator or SCSI cable	Check conflicting SCSI id's

A

access door	
front	14
magazine	14
rear	16
agency standards, safety	61

B

bay installation	24
bay packing instructions	32
bulk loading media	21

C

command processing	11
components, hardware	14

D

description line	39
display, front panel	14, 39
door	
front access	14
magazine access	14
rear access	16
drive combinations	59
drive modules	15
drives, number of	11, 51

E

error codes	63
expansion bay installation	24
expansion bay packing instructions	32

F

front access door	14
front panel display	14, 39

G

general information	11
getting started	17

H

hardware components	14
---------------------------	----

I

I/E port loading	21
import export port	15
initializing library	19
installation	
bay	24
library	17

L

LCD symbols, front panel display	40
LEDs, magazine slot	22
library	
dimensions	51
environment	18
initialization	19
installation	17
models	11
packing instructions	28
position	17
specifications	51
unpacking	17
library status menu	44
lift assembly	16

M

magazine	12
access door	14
eject button	21
handling	13
LEDs	22
slots	14, 21
main menu	42
map	
storage slot	16, 23
media	
handling	13
loading	11, 21
movement	11
slots	11, 16, 23
specifications	51
types	12
media transport element (MTE)	16
media, slots	51
menu	
library status	44
main	42
set up library	47
menu system	
LCD symbols	40
navigating	39
power up display	41
models, library	11
MTE	16

N

number of drives	11, 51
------------------------	--------

P

packing instructions	
bays	32

packing instructions, library	28
packing material, removing	18
power	
cable	15, 18
supplies	15
switch	15, 18

R

rear access door	16
removable storage slots	14, 51
rotation station	16

S

safety agency standards	61
SCSI	
bus configuration	55
connection	20
drive combinations	59
ID configuration	58
interface	15
selection buttons	39
set up library menu	47
slot, storage map	16, 23
specifications	
library	51
media	51
storage slot map	16, 23

U

unpacking library	17
-------------------------	----

W

warranty	4, 51
----------------	-------

CONTACTING PLASMON

Technical Support in the United States	
Plasmon Technical Support	+1-877-585-6793
	+1-719-593-4192 (fax)
e-mail	tech.support@plasmon.com
Internet	www.plasmon.com
Technical Support in Europe, Middle East, and Africa	
Plasmon Technical Support	+44 (0) 1763 262 963
	+44 (0) 1763 264 444 (fax)
e-mail	support@plasmon.co.uk
Internet	www.plasmon.co.uk
Technical Support in Asia/Pacific, South America, and Canada	
International Calls	+1-719-593-4437
	+1-719-593-4192 (fax)

Firmware Updates

Contact Plasmon or your reseller for the latest firmware updates.

Before Placing a Service Call to Plasmon

Register your site on-line at <http://www.plasmontech.com/warranty/index.html>.

Placing a Service Call

Contact your service provider directly. If Plasmon is your service provider, please have the following information available when calling:

- Serial number
- Description of failure
- System information
 - Computer type and SCSI adapter
 - Software configuration
 - Software and version number



**The Leader in Professional
Data Archival Solutions**

Free Manuals Download Website

<http://myh66.com>

<http://usermanuals.us>

<http://www.somanuals.com>

<http://www.4manuals.cc>

<http://www.manual-lib.com>

<http://www.404manual.com>

<http://www.luxmanual.com>

<http://aubethermostatmanual.com>

Golf course search by state

<http://golfingnear.com>

Email search by domain

<http://emailbydomain.com>

Auto manuals search

<http://auto.somanuals.com>

TV manuals search

<http://tv.somanuals.com>