

PLAYSKOOL®

**OVER 18 Months
to 5½ Years
34676**

Dora The Explorer Sit 'n Spin®

Thank you for choosing this PLAYSKOOL brand product!

Includes: SIT 'N SPIN base, center post (2 pieces),
3 screws, turn handle and instructions.

Adult assembly required.

Phillips screwdriver (not included) needed for assembly.

Batteries included.
Replace with 2 x
1.5V "AA" or R6
size batteries.
Alkaline batteries
recommended.
Phillips/cross head
screwdriver needed
to replace batteries.

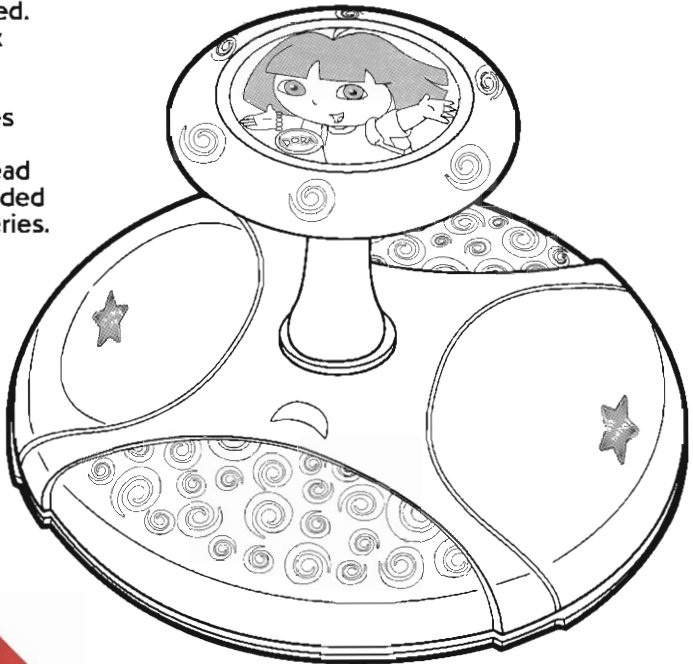

⚠ CAUTION:

This product contains small parts which are necessary for assembly. Prior to and during assembly of this product, keep small parts out of children's reach. Small parts pose a choke hazard to children under 3 years.

ASSEMBLY: Here are the easy-to-follow instructions for assembling your **DORA THE EXPLORER SIT 'N SPIN** toy. Please follow assembly instructions in proper order for best results.

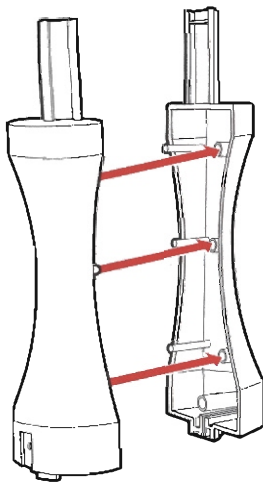

1. Connect the right side and left side of the center post by snapping the two pieces together. This is a one-time assembly.

2. Use a Phillips (cross) head screwdriver (not included) and 2 screws (included) to connect the turn handle to the top of the center post. The screws connect on the sides of the turn handle as shown.

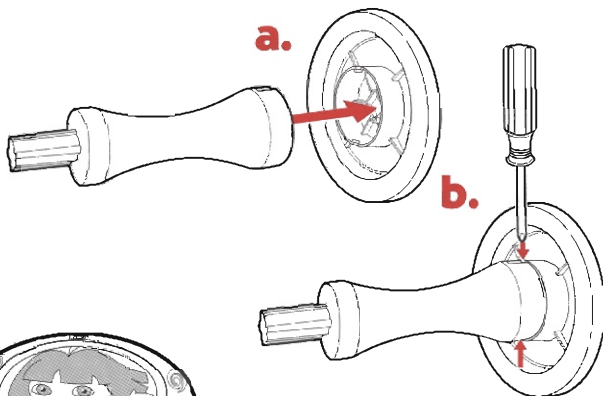

3. Place the center post/turn handle into the SIT 'N SPIN base as shown. Flip the SIT 'N SPIN base over and use a Phillips (cross) head screwdriver and 1 screw (included) to connect the center post/turn handle to the base.

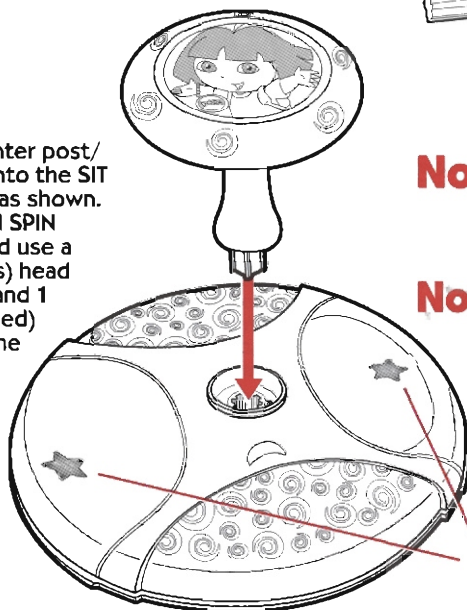

Note: Check to be sure that all assembled parts are securely attached before using the toy.

Note: For best performance, child should be seated on one of the two designated seating areas marked with the yellow star.

seating areas

NOW YOU'RE READY TO PLAY!

PLAY FEATURES: Keep the fun spinning in "Music", "Giggle", or "Counting" mode! Here are some play suggestions to get you started:



NOTE: This toy is packaged in "demo" mode. To enable full play features, switch to "play" mode located on the underside of toy.

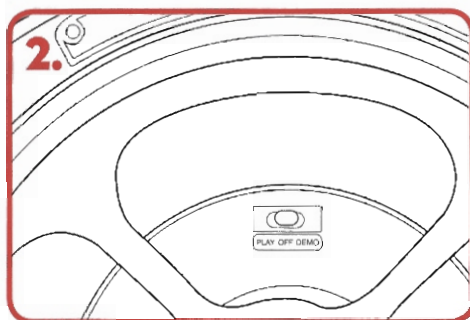
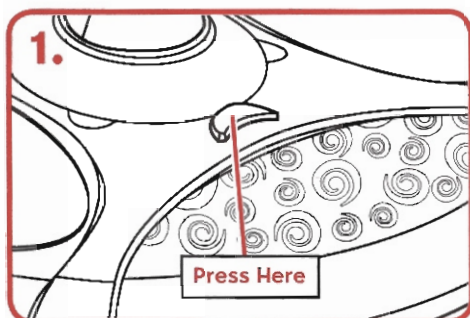

"Music", "Giggle", or "Counting" mode - it's your choice!

1. Push the moon-shaped button on top of the SIT 'N SPIN base or spin the base to start Dora's theme song. Once the song is finished, you may press the moon-shaped button on the top of the SIT 'N SPIN base to toggle through modes, or you may continue spinning and Dora will automatically cycle through each mode.

Music Mode

Dora will start to talk and encourage a sing along.

Giggle Mode

In this mode, Dora will giggle and laugh as your child spins 'round and 'round!

Counting Mode

In this mode, Dora will count each revolution your child makes on the SIT 'N SPIN. Your child can count along in English and Spanish! Once Dora has counted up to five, she returns to the initial "Music" mode.

NOTE: Toy will automatically cycle through all modes of play, even if moon-shaped button is not pressed. You may manually repeat any mode by pressing the moon-shaped button twice.

2. This toy also features "sounds off" mode for quiet play! Simply move the switch at the bottom of the toy to "off".
3. After 30 seconds of inactivity, the toy will automatically shut off. To play again, simply spin the base. When storing, make sure the three-position switch is moved to "off" position to conserve battery life.

TO REPLACE BATTERIES

Use a Phillips/cross head screwdriver (not included) to loosen screw in battery compartment door located on the bottom of the SIT 'N SPIN base (screw remains attached to door). Remove door. Remove and discard old batteries. Insert 2 x 1.5V "AA" or R6 size batteries. Alkaline batteries recommended. Replace door and tighten screw.

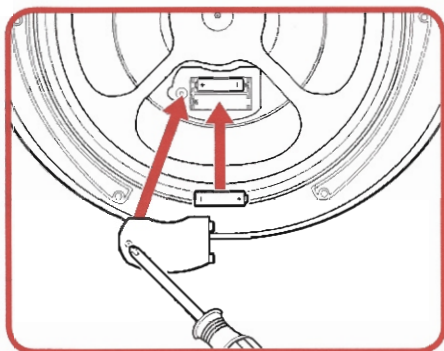

! CAUTION: TO AVOID BATTERY LEAKAGE

1. Be sure to insert the batteries correctly and always follow the toy and battery manufacturers' instructions;
2. Do not mix old and new batteries or alkaline, standard (carbon-zinc) or rechargeable (nickel-cadmium) batteries;
3. Always remove weak or dead batteries from the product.

IMPORTANT: BATTERY INFORMATION

Please retain this information for future reference.

Batteries should be replaced by an adult.

! CAUTION:

1. Always follow the instructions carefully. Use only batteries specified and be sure to insert them correctly by matching the + and - polarity markings.
2. Do not mix old batteries and new batteries, or standard (carbon-zinc) with alkaline batteries.
3. Remove exhausted or dead batteries from the product.
4. Remove batteries if product is not to be played with for a long time.
5. Do not short-circuit the supply terminals.
6. Should this product cause, or be affected by, local electrical interference, move it away from other electrical equipment. Reset (switching off and back on again or removing and re-inserting batteries) if necessary.
7. RECHARGEABLE BATTERIES: Do not mix these with any other types of battery. Always remove from the product before recharging. Recharge batteries under adult supervision. DO NOT RECHARGE OTHER TYPES OF BATTERIES.

FCC STATEMENT

This equipment has been tested and found to comply with the limits for a Class B digital device, pursuant to Part 15 of the FCC Rules. These limits are designed to provide reasonable protection against harmful interference in a residential installation. This equipment generates, uses and can radiate radio frequency energy, and, if not installed and used in accordance with the instructions, may cause harmful interference to radio communications. However, there is no guarantee that interference will not occur in a particular installation. If this equipment does cause harmful interference to radio or television reception, which can be determined by turning the equipment off and on, the user is encouraged to try to correct the interference by one or more of the following measures:

- Reorient or relocate the receiving antenna.
- Increase the separation between the equipment and the receiver.
- Consult the dealer or an experienced radio/TV technician for help.



© 2005 Hasbro. All Rights Reserved.
TM & ® denote U.S. Trademarks.
34676 P/N 649929000



Questions? Call: 1-800-PLAYSKL

Free Manuals Download Website

<http://myh66.com>

<http://usermanuals.us>

<http://www.somanuals.com>

<http://www.4manuals.cc>

<http://www.manual-lib.com>

<http://www.404manual.com>

<http://www.luxmanual.com>

<http://aubethermostatmanual.com>

Golf course search by state

<http://golfingnear.com>

Email search by domain

<http://emailbydomain.com>

Auto manuals search

<http://auto.somanuals.com>

TV manuals search

<http://tv.somanuals.com>