



Mini-Golf Mountain™

50013

Thank you for buying this Playskool® product!
ADULT ASSEMBLY REQUIRED.

Remove parts from plastic bags and discard bags immediately.

PARTS LIST (Before Assembly)

MOUNTAIN BASE

HOLE #1 "ROCK FORMATION"

HOLE #1 MONKEY

BASE RAMP

HOLE #4 WINDMILL/GOPHER

2 PUTTER SHAFTS

2 PUTTER HEADS

2 GOLF BALLS

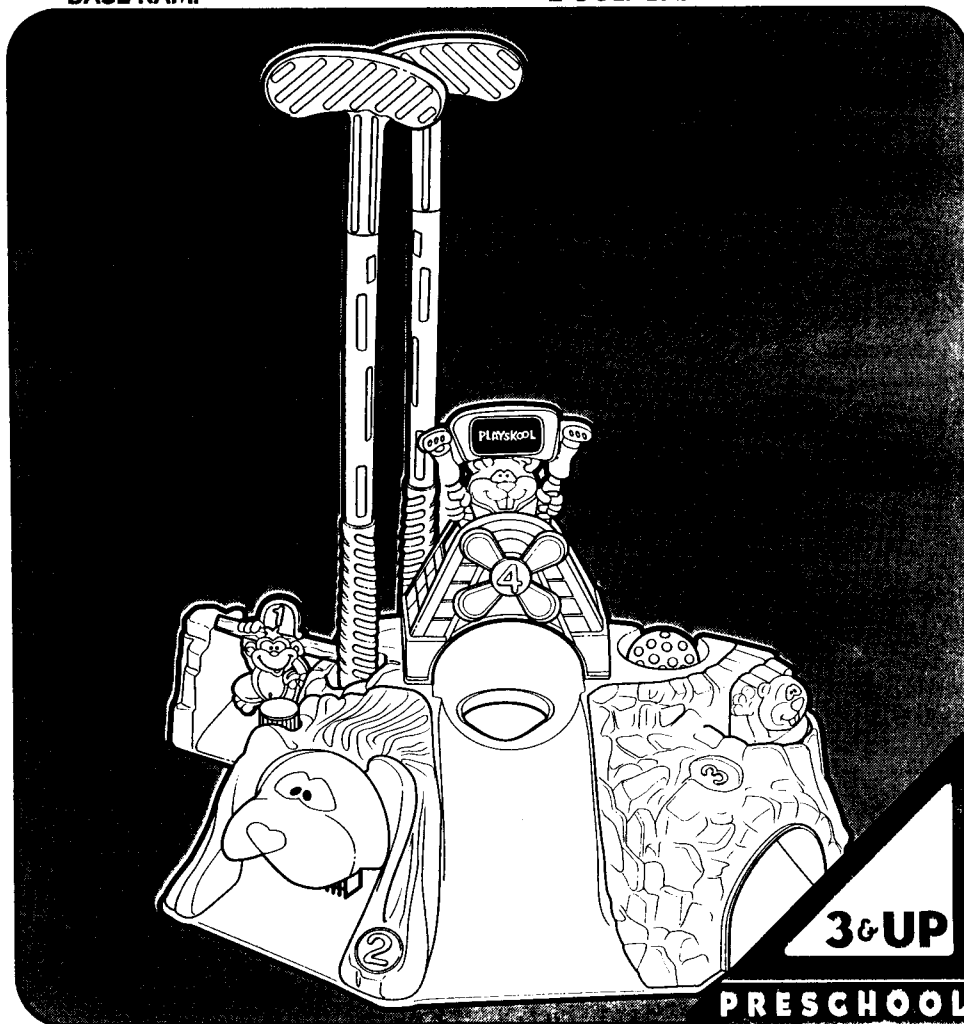

BASE RAMP ASSEMBLY

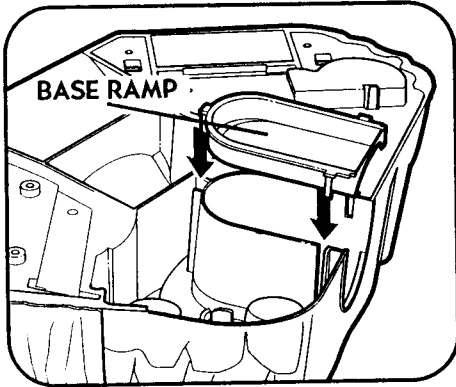

1. Turn mountain base upside down, and press fit base ramp into its place by aligning ramp into slots as shown.

HOLE #1 ASSEMBLY

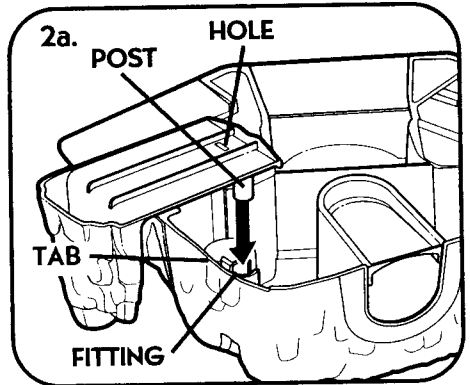

- 2a. Hole #1 (with spinning monkey) attaches to the left-hand side of the Mini-Golf Mountain. Turn the mountain upside down, and assemble the "rock formation" onto mountain by inserting the post piece into fitting on bottom of mountain, then snapping the tab on mountain through the hole on rock formation. Test to be sure assembly is secure.

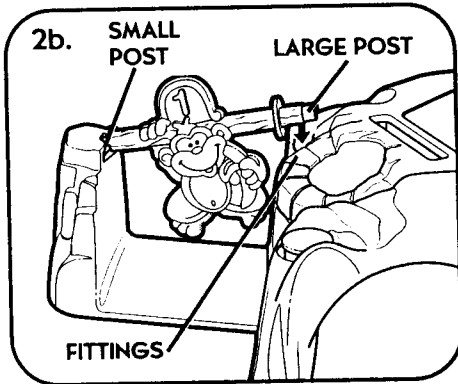

- 2b. Snap the monkey into place as shown by inserting the small post on the end of the monkey's "branch" into the fittings on "rock," and the large post on other end of branch into the slot on mountain. The monkey should spin freely on its axle.

HOLE #4 ASSEMBLY

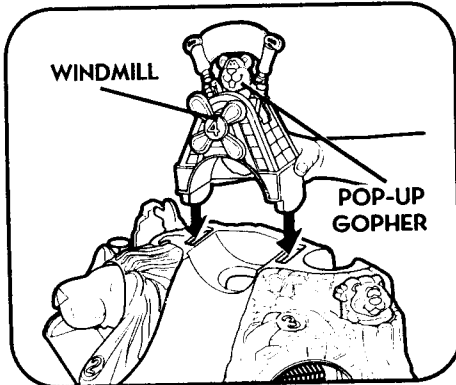

3. Hole #4 (pop-up gopher and windmill) assembles to the top of the mountain as shown. Make sure that the side with the gopher's face and windmill wheel is facing front, the same way as the other animal characters.

PUTTER ASSEMBLY

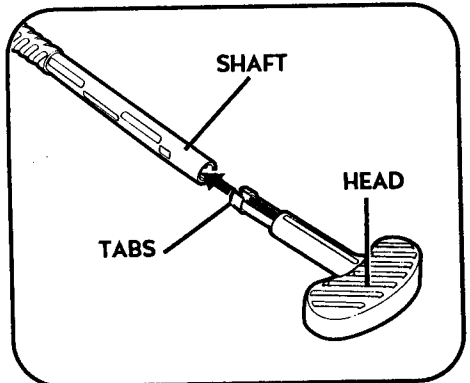

4. Assemble the 2 putter heads to the 2 shafts/handles. For each, push the putter head down into the shaft as shown until the tabs click into place inside shaft. Test to be sure assembly is secure.

PLAY INSTRUCTIONS

Now your child is ready to play - the Mini-Golf Mountain is fun for one or two children, indoors or out!

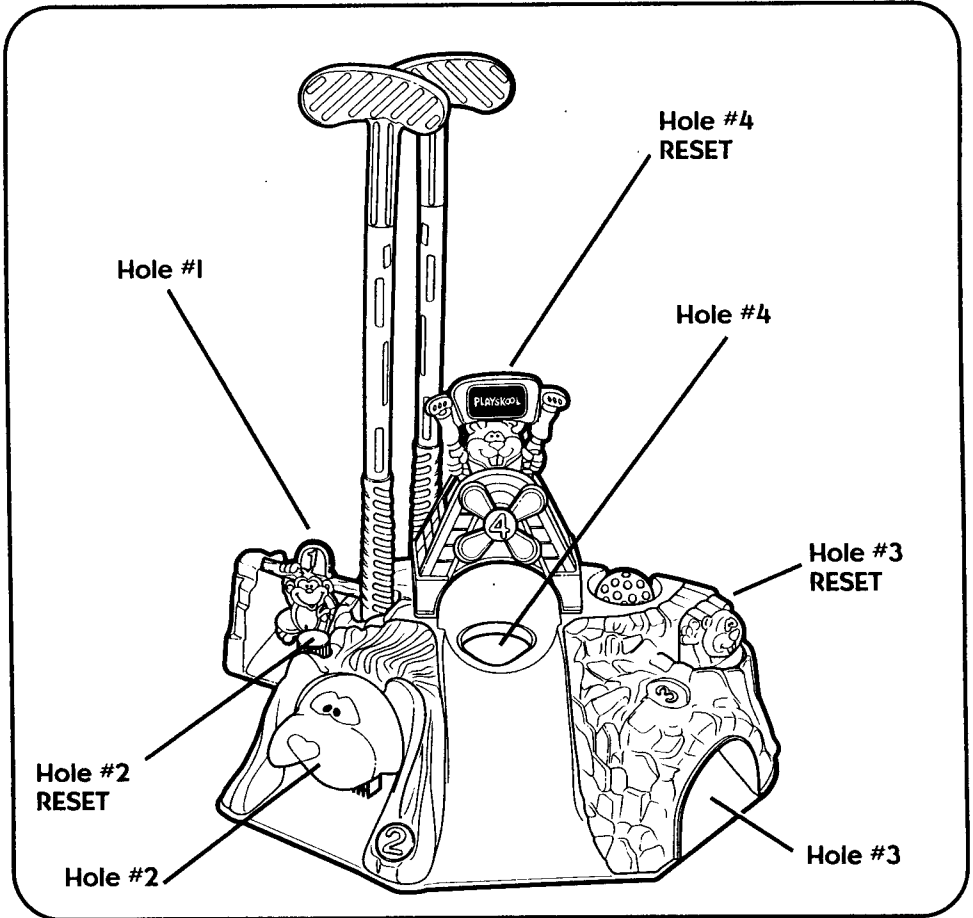

- Hole #1 - Sink the putt, and the monkey swings as the ball rolls through!
- Hole #2 - Set up the hole by pressing down on the button on the top left of the lion's head; sink the putt, and the lion chomps the golf ball, then automatically returns it to you! Press button again to re-set.
- Hole #3 - Set up the hole by pressing the little gopher down into his hole; sink the putt, and the gopher pops up and waves hello - then automatically returns the golf ball to you! Press gopher down again to re-set.
- Hole #4 - Set up the hole by pressing the gopher's sign down into the windmill (you'll just be able to see the gopher's eyes from the top of the windmill and you'll see a little baby gopher inside the hole!); sink the putt, and the gopher pops up as the windmill spins - and the ball disappears through a secret tunnel, just like real miniature golf! Press gopher's sign down again to re-set.

STORAGE:

After play, the 2 putters store inside the slots on left side of the mountain as shown. The 2 golf balls store inside area on right side of mountain.

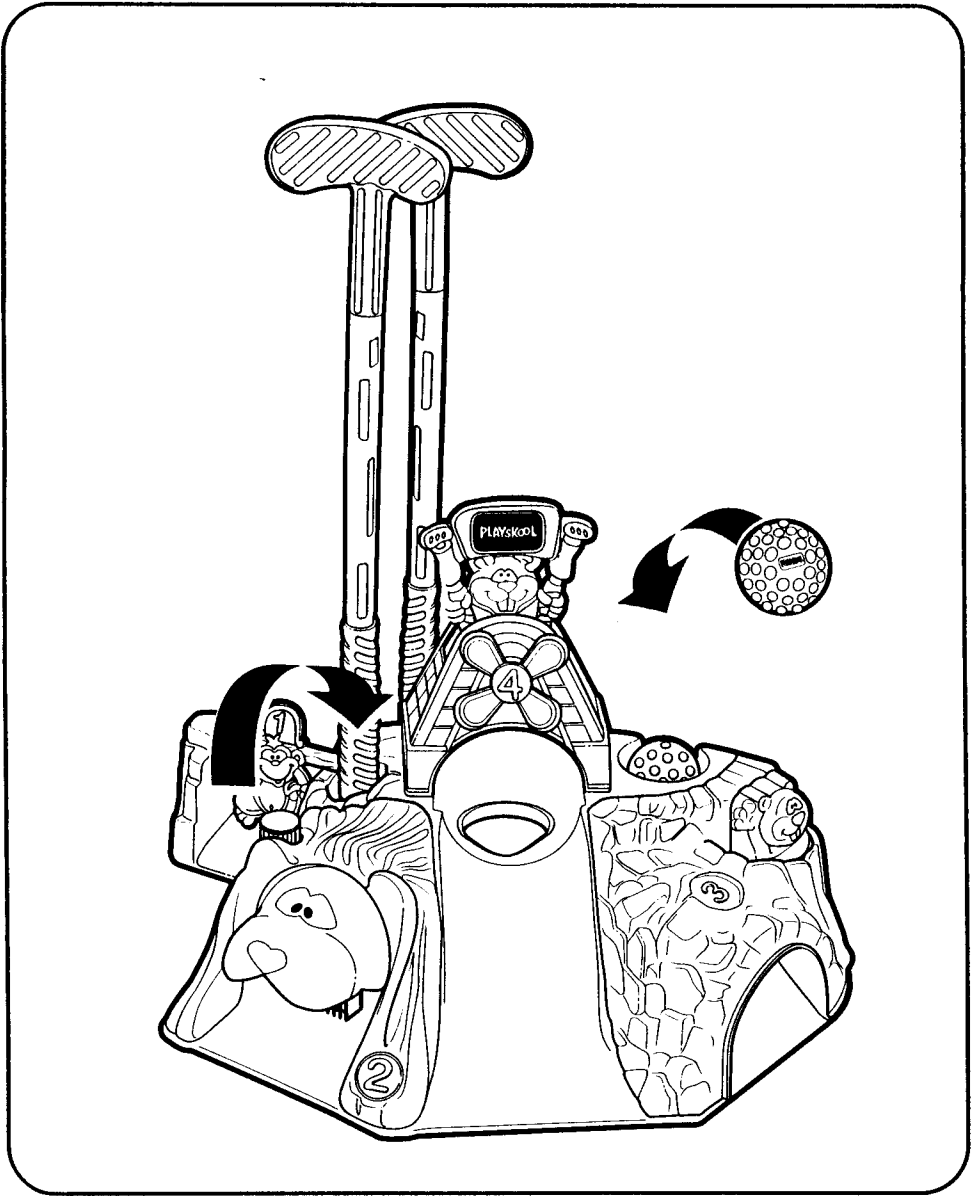

© 1997 Hasbro, Inc., Pawtucket, RI 02862 USA. All Rights Reserved.

® denotes Reg. U.S. Pat. & TM Office.

MADE IN MEXICO.

U.S. Patent Pending.

50013

P/N 47672700

Free Manuals Download Website

<http://myh66.com>

<http://usermanuals.us>

<http://www.somanuals.com>

<http://www.4manuals.cc>

<http://www.manual-lib.com>

<http://www.404manual.com>

<http://www.luxmanual.com>

<http://aubethermostatmanual.com>

Golf course search by state

<http://golfingnear.com>

Email search by domain

<http://emailbydomain.com>

Auto manuals search

<http://auto.somanuals.com>

TV manuals search

<http://tv.somanuals.com>