

❖ SOFTWARE

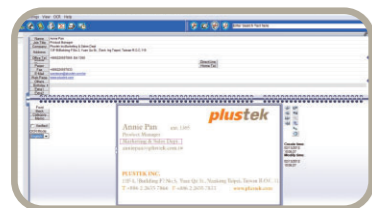

Hotcard BizCard Finder

BizCard Finder, provides Business Card Reading (BCR) Technology and Photo /Document database for contact management. BizCard Finder quickly and easily converts the vital contact information on business cards into a convenient, searchable, digital database that can be easily synchronized between PC, NoteBook, and PDA.

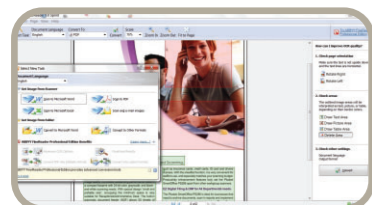

Powered by
ABBYY

ABBYY FineReader 9.0 Sprint

Unlocks the data inside paper-based documents, images and PDF files with enhanced accuracy that eliminates the need for retyping and reformatting. Tool that increases your productivity and efficiency which comes with simple user interface and supports recognition up to 183 languages.



plustek
DI Capture

Plustek DI Capture

Image capture and management software featured with indexed archives. Makes it easy manage and organize documents and images efficiently. Exports files in PDF, JPEG, TXT and XLS with flexible file naming options.



Plustek DI Express

Features accurate and efficient Optical Character Recognition (OCR) for four Asian languages: Traditional Chinese, Simplify Chinese, Japanese and Korean with automatic image processing functions such as Color-Dropout, Threshold, Rotating. Import images, or image PDF and convert to TXT, RTF, Searchable PDF, XLS formats, and editable text.

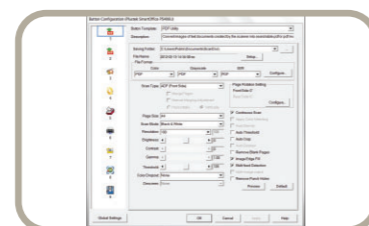

DocAction

Plustek DocAction

Button utility to simplify document scanning. DocAction enables you to specify your personalized scanning configuration settings and scan documents with the touch of a button. Scanned documents are automatically sent directly to Printer, Email, Folder or FTP. DocAction also enables you to scan directly to many imaging and document management applications. DocAction saves scanned documents in all common imaging formats including: JPEG, TIFF, and PDF.

Plustek PS456U

High speed, reliable,
cost effective **departmental class**
document scanner



The Plustek SmartOffice PS 456U is a 80 page per minute, duplex color document scanner that is not only fast, it's reliable and cost effective. Ultrasonic misfeed detection ensures all of your critical documents are imaged correctly. Robust paper handling, advanced image processing and a high daily duty cycle all add up to the perfect departmental scanning solution for document management, content management and forms processing applications.

❖ KEY FEATURES

- Scan speed up to 80ppm/160ipm
- 100 page ADF capacity and a generous daily duty cycle up to 4000 pages
- Improved high quality imaging and robust paper handling.
- Ultrasonic multi-feed detection
- No warm up time. Instant on LED illumination.
- New quiet operation
- Scans plastic cards, insurance cards, license cards, business cards up to 1.2mm
- Scans long documents up to 2500mm (98")
- Single touch scanning to popular formats including Searchable PDF, Word, Excel, JPEG and TIFF
- Automatic wake up when documents are placed in the feeder
- Advanced image enhancement to automatically straighten and rotate pages, adjust brightness, detect color and increase OCR accuracy.

Hardware Requirements

Pentium IV 2.0 GHz processor (Pentium IV 3.0 GHz processor recommended)
CD-ROM Driver
One available USB Port (USB 2.0 recommended)
1GB RAM or higher recommended
800 MB free HDD space (1 GB or larger recommended)



As an international ENERGY STAR Partner, Plustek has determined that this product meets the international ENERGY STAR Program for energy efficiency.

Specification

Image Sensor	CCD Sensor x 2
Optical Resolution	600 dpi
Hardware Resolution	600 x 600 dpi
ADF Capacity	1. 100 sheets (A4/ Letter, 70 g/m ² or 18 Lbs) 2. 30 sheets (Business Cards) 3. Plastic Card, Max. thickness under 1.2 mm. Note: Maximum ADF capacity varies, depending upon paper weight.
Scanning Speed (ADF)	80 ppm/ 160 ipm (Grayscale/B&W mode, 300 dpi, A4 Portrait) 45 ppm/ 90 ipm (Color mode, 200 dpi, A4 Portrait) 30 ppm/ 60 ipm (Color mode, 300 dpi, A4 Portrait) Note: Results may vary depending upon your scanning application, computer processor and system memory.
Scanning Area (W x L)	Max: 216 x 2500 mm (8.5" x 98.42") Min: 13.2 x 13.2 mm (0.52" x 0.52")
Acceptable Paper Sizes (W x L)	Max: 244 x 2530 mm (9.6" x 99.60") Min: 50.8 x 50.8 mm (2" x 2")
Acceptable Paper Weight (Thickness)	40 to 220 g/m ² (10 to 58 Lbs)
Daily Duty Scan (Sheets)	4,000
Roller Lifetime (Scans)	300,000
Pad Lifetime (Scans)	50,000
Action Button	4 Buttons: Up, Down, Scan, Standby 9 Function Keys: Scan, PDF, OCR, File, E-Mail, Copy, BCR, FTP, DI Capture. All Customizable.
Power Supply	24 Vdc/ 1.25 A
Interface	USB 2.0
Net Weight	2.7 Kgs (5.95 Lbs)
Dimensions (W x D x H)	318.7 x 230.7 x 228.3 mm (12.55" x 9.08" x 8.99")
Protocol	ISIS & TWAIN Compliant * EMC ISIS drivers will be available at a later date.
OS	Windows 2000 / XP / Vista / 7

Headquarters: sales@plustek.com

❖ FEATURES

Exceptional Document Handling



The SmartOffice PS456U features one of the most advanced document feeding and separation system in the industry. This system allows the SmartOffice PS456U to scan mixed batches of varying paper sizes and weights. No more wasted time sorting documents based on their size or thickness. Plastic and rigid cards such as ID cards, Drivers Licenses, Membership Cards, Insurance Cards and even log documents up to 2500mm(98") are scanned without additional adjustments or additional set up. The SmartOffice PS456U also features auto wake up that enables users to simply place the paper in the scanner and wake up the scanner from sleep / stand-by mode.

Intelligent Misfeed Function

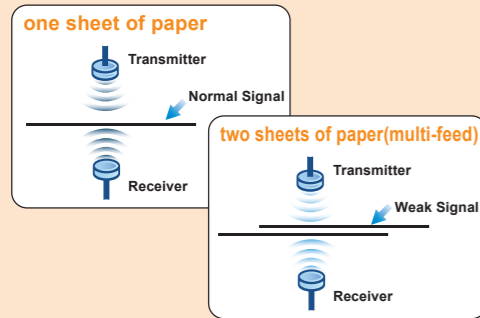

The ultrasonic sensor detects the double feeding of original documents during scanning. The ultrasonic function can be turned off when scanning document with labels, sticky notes, or taped receipts. This innovative design prevents double feeding and effectively scans documents of different weights or thickness. Thanks to double-feed prevention, optimum reliability is assured even when scanning high volumes of documents.

Exceptional Reliability



The 100 sheet feed tray along with a daily duty cycle of 4000 pages means that the SmartOffice PS456U is a scanner that is designed to scan documents every day, all day long.

Exceptional Productivity



Create searchable PDFs at the touch of a button. Single Touch scanning allows you to define 9 different scanning functions that can all be accessed by simply pressing a button. In addition to Searchable PDF, you can transform your paper documents into editable Microsoft Office document formats or common image formats such as JPG and TIFF. The SmartOffice PS456U is bundled with business card reading software and a suite of document management and scanning applications to allow you to be productive right out of the box. Industry standard TWAIN, ISIS and WIA drivers ensure compatibility with thousands of image enabled applications.

Auto Threshold

Automatically thresholds the current image into a binary black and white image.

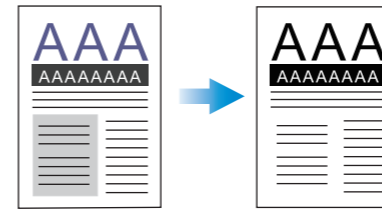

Auto Rotate

Automatically rotates document based on the contents of the document.

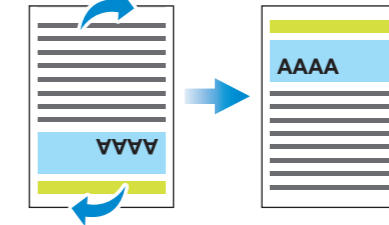

Auto Crop & Deskew

Automatically straightens and crops image to the document's actual size.

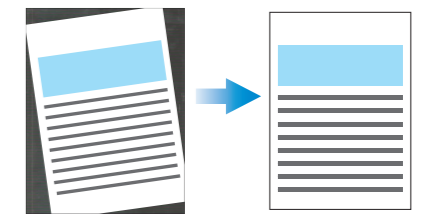

Auto Mode

Automatically detects document color and scans document in color, grayscale or black & white mode.

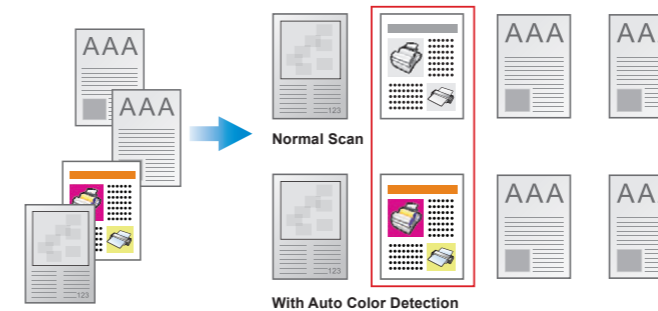

Multi-Image Output

Scans and saves documents in 2 or 3 color modes at same time.

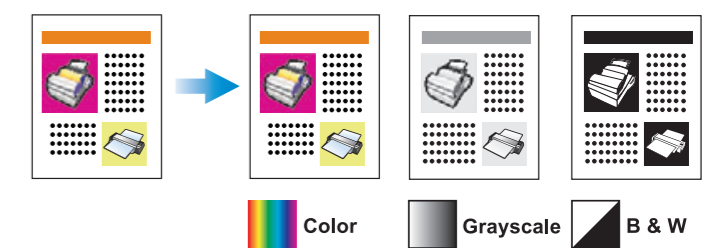

Color Dropout

Removes red, green or blue color when scanning forms.



Blank Page Removal

Automatically removes blank pages without manual editing.

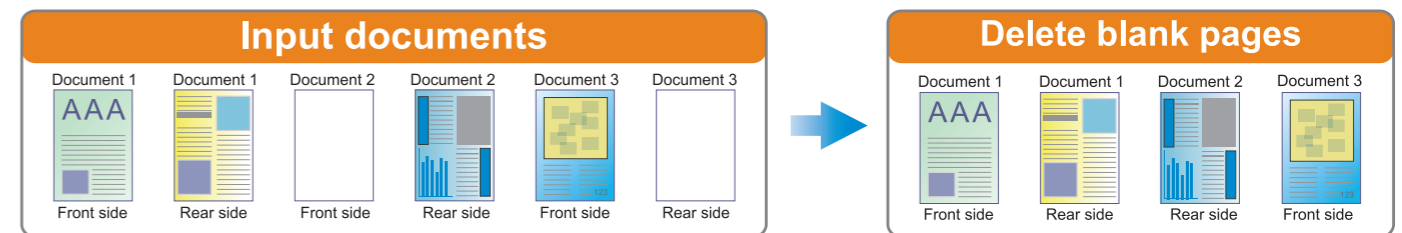

Fast duplex scanning at speeds up to 80 pages per minute in Grayscale mode.



Effective scanning with large Automatic Document Feeder up to 100 pages.



Digitize paper business cards into easily-managed and sorted contacts, and turn your business cards into information.



Scans embossed rigid cards such as ID cards, insurance cards, drivers licenses and credit cards up to 1.2mm. Perfect for vertical applications such as healthcare, pharmacy, accounting, hospitality, etc.



Save paper documents as searchable PDFs at the touch of a button and find your information faster.



Allows you to easily upload files or scanned images to a compatible server of your choice including Google Docs, Microsoft SharePoint, Box, Dropbox, Twitter and FTP servers.

Free Manuals Download Website

<http://myh66.com>

<http://usermanuals.us>

<http://www.somanuals.com>

<http://www.4manuals.cc>

<http://www.manual-lib.com>

<http://www.404manual.com>

<http://www.luxmanual.com>

<http://aubethermostatmanual.com>

Golf course search by state

<http://golfingnear.com>

Email search by domain

<http://emailbydomain.com>

Auto manuals search

<http://auto.somanuals.com>

TV manuals search

<http://tv.somanuals.com>