

RADIO YourWay LX

AM/FM RADIO RECORDER

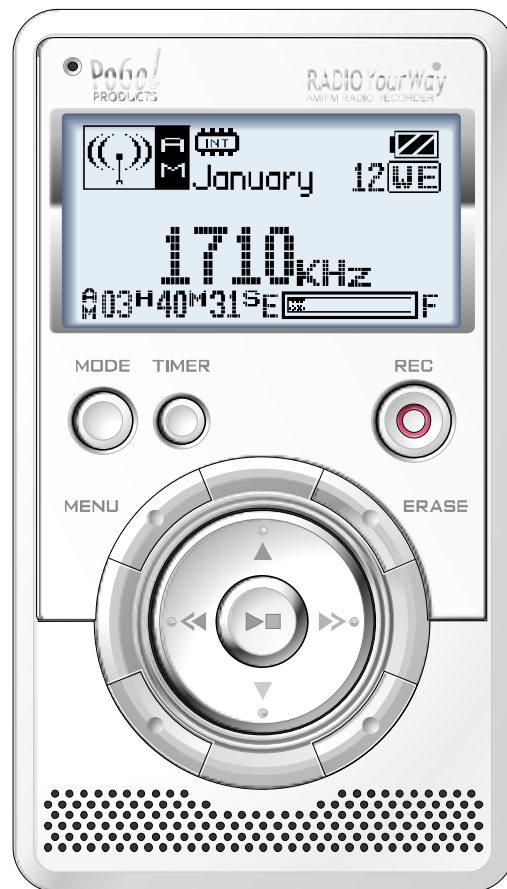

AM/FM Radio Recorder/Voice Recorder/MP3WMA Player



This manual is protected by copyright laws and all rights are reserved. No portion of this manual may be reproduced in any form or translated into other languages without written permission from the manufacturer and publisher of this manual. The content of this manual is provided “as is” and the manufacturer is under NO obligation to notify users of revisions or modifications to the product or procedures. Every effort has been taken to ensure the accuracy of the information herein. However, the manufacturer is not responsible for any inaccuracies or omissions that may affect the units operation. We recommend you read the entire manual to get the most enjoyment out of Radio YourWay LX.

TABLE OF CONTENTS

I Component and LCD Display

- 1 SET
- 2 Accessories
- 3 LCD Display

II Battery Charging and USE

- 1 Charge battery using AC Adapter
- 2 Charging Status
- 3 Battery Level
- 4 Playback and Recording Battery Life

III Memory Card

- 1 Memory Card
- 2 Maximum Recording Time
- 3 Precaution
- 4 Inserting a memory Card
- 5 Reset

IV Basic Operations

V MAIN MENU STRUCTURE

VI Main Menu

- 1 SYSTEM
- 2 PLAY
- 3 RECORDING
- 4 DISPLAY
- 5 SOUND

VII FURTHER OPERATION

- 1 Playback Speed
- 2 ERASING FILES
- 3 AM/FM Radio
- 4 TIMER-RECORDING
- 5 Timer-Recording Settings

VIII PC CONNECTION

- 1 Win XP, 2000 and ME
- 2 Driver Installation for Win98SE
- 3 PC Connection Display
- 4 Safely Removing Hardware from a PC

IX FORMATTING

- 1 Formatting using a PC
- 2 Formatting using the unit

X UPGRADING FIRMWARE and FONT

XI DISPLAY MESSAGES

General Specification

Warranty

I Component and LCD Display

1 SET

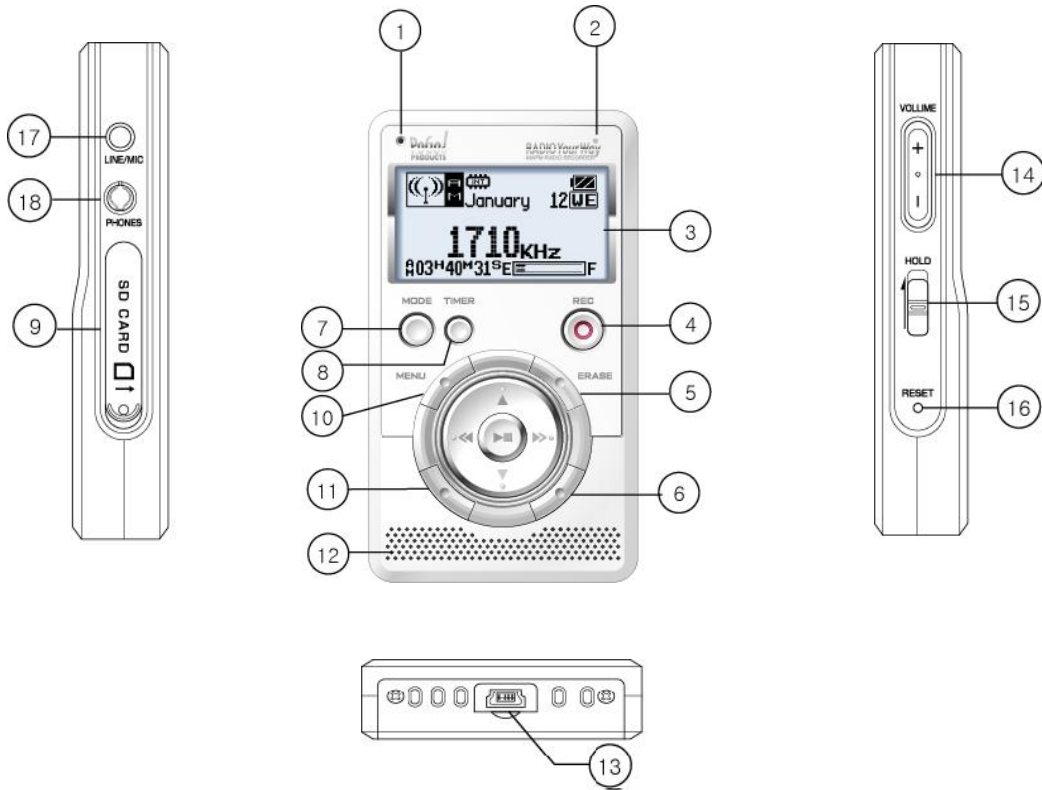

①	Internal Microphone	⑩	MENU
②	LED	⑪	SPEED
③	LCD	⑫	External Speaker
④	REC	⑬	USB/POWER Terminal
⑤	ERASE	⑭	Volume +/-
⑥	A↔B/Repeat	⑮	HOLD
⑦	MODE	⑯	RESET
⑧	TIMER	⑰	LINE IN
⑨	SD/MMC Card Slot	⑱	Earphone Jack

2 Accessory

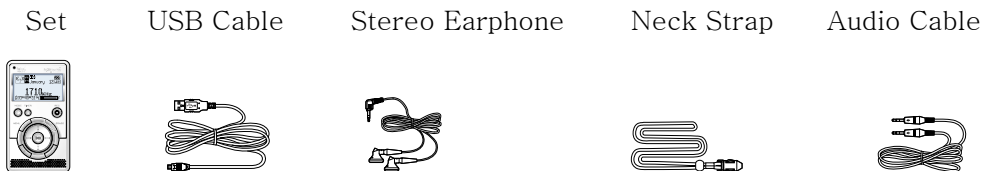

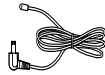

3 LCD Display

■ POWER ON

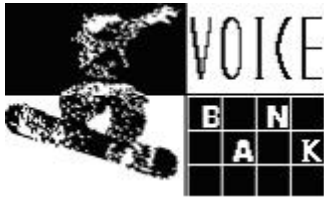

■ POWER OFF



■ AM Display

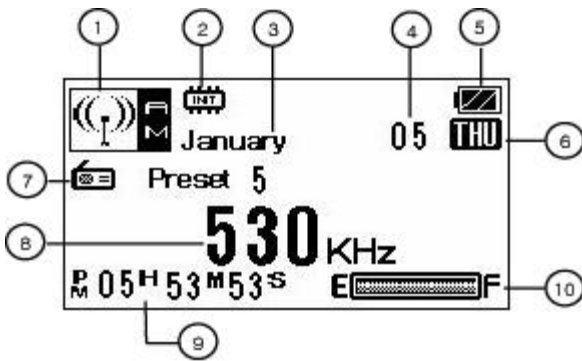

- ① : Radio band
- ② : Memory(Internal/External)
- ③ : Month(Calendar)
- ④ : Day(Calendar)
- ⑤ : Battery Level
- ⑥ : Date(Calendar)
- ⑦ : Preset Frequency NO
- ⑧ : Frequency
- ⑨ : Present Time
- ⑩ : Remaining memory status

■ FM Display

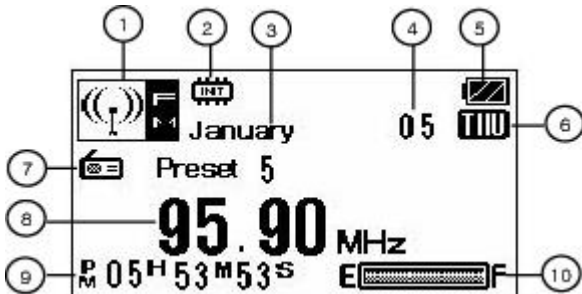

- ① : Radio band
- ② : Memory(Internal/External)
- ③ : Month(Calendar)
- ④ : Day(Calendar)
- ⑤ : Battery Level
- ⑥ : Date(Calendar)
- ⑦ : Preset Frequency NO
- ⑧ : Frequency
- ⑨ : Present Time
- ⑩ : Remaining memory status

■ MUSIC Initial Display

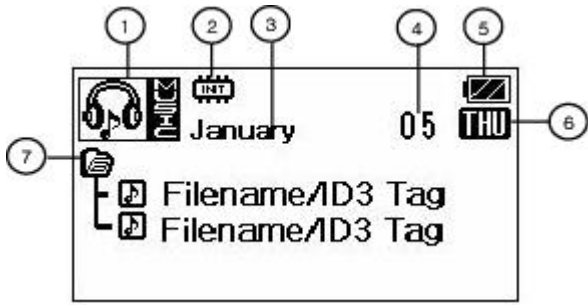

- ① : MUSIC Mode
- ② : Memory(Internal/External)
- ③ : Month(Calendar)
- ④ : Day(Calendar)
- ⑤ : Battery Level
- ⑥ : Date(Calendar)
- ⑦ : Navigation (Music list up)

■ MUSIC Playback Display

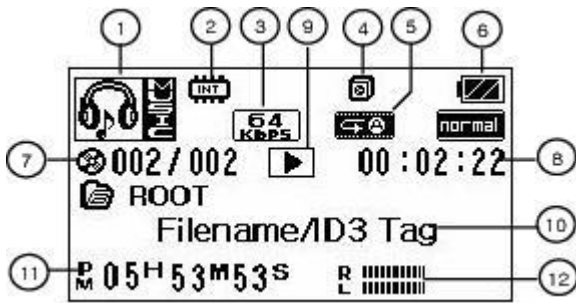

- ① : Radio band
- ② : Memory(Internal/External)
- ③ : Recording bit rate
- ④ : Sound effect
- ⑤ : Repeat
- ⑥ : Battery level
- ⑦ : Playing music NO/Total music No
- ⑧ : Playing time
- ⑨ : Play Status
- ⑩ : Music Information
- ⑪ : Present time
- ⑫ : L/R Sound Level

■ VOICE Initial Display

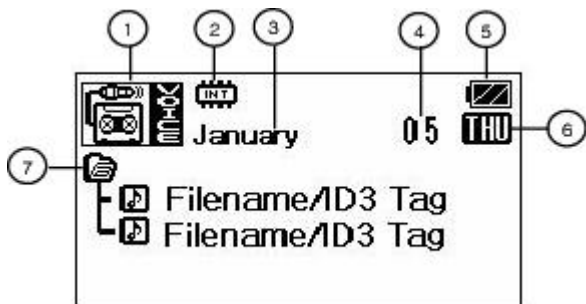

- ① : VOICE Mode
- ② : Memory(Internal/External)
- ③ : Month(Calendar)
- ④ : Day(Calendar)
- ⑤ : Battery Level
- ⑥ : Date(Calendar)
- ⑦ : Navigation

II Battery Charging and USE

1 Charge battery using AC Adapter

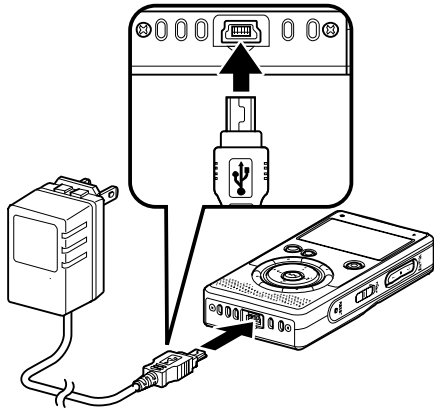

- Connect the adaptor jack as shown in the diagram; taking note of the correct side.
- The battery can be charged using the AC adaptor, or by making a USB connection with a PC or MAC.
- It takes approximately 4hrs to fully charge the battery using either method.
 - ☞ The 4hr charge time (for a full charge) is an estimate only. Actual time may vary depending on charging conditions.

2 Charging Status

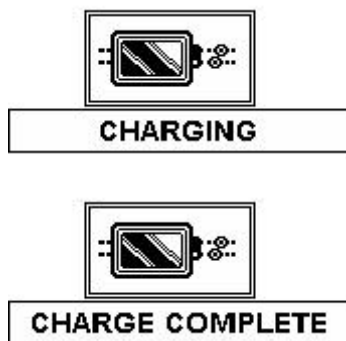

Charging

Charge Complete

3 Battery Level

	Full charge
	Some power consumed
	Power almost drained, should charge battery
	No power, charge battery

4 Playback and Recording Battery Life

BATTERY TYPE	File Playback	Recording(Voice)
Li-polymer	APPROX 15HRS	APPROX 10HRS

☞ Actual battery life may vary depending on use.

Before recording for a long period of time, please fully charge the battery.

A Li-polymer battery has its own battery life, if battery consumption has changed drastically, please replace the battery with a new one from www.pogoproducts.com

III Memory Card

1 Memory Card

- 1) Memory Card Type: SD/MMC Card
- 2) Compatible Capacity: 32MB / 64MB / 128MB / 256MB / 512MB / 1GB

☞ An external memory card is not provided. You can buy one from just about any electronics store in your area.

2 Maximum Recording Time

- 128MB: 8.5hrs at 32Kbps
- 256MB: 17hrs at 32Kbps
- 512MB: 34hrs at 32Kbps
- 1GB: 68hrs at 32Kbps

3 Precaution

- 1) Do not take the memory card out while the unit is playing back or recording a file.
- 2) When using a new memory card, format the card inside the unit BEFORE using it.
- 3) If the memory card has been used in any device, (Digital Camera, MP3 Player etc) you must first format the card using a computer (FAT) and then again in the unit BEFORE using the card.
- 4) We do not recommend using a memory card in multiple devices.

4 Inserting a Memory Card



☞ When inserting a memory card in the unit, be careful and insert the card properly as shown in the diagram (taking note of the correct side up) or you may damage the card and/or Ext card slot.





5 Reset

If the unit is not operating properly, please reset the unit by pushing the reset button (found on the right side of the unit) gently with a thin object for 1 second. Please do not push the reset button using a sharp object.



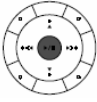



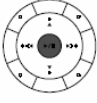
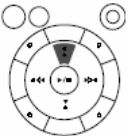

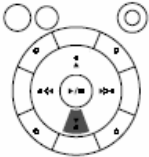
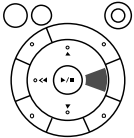
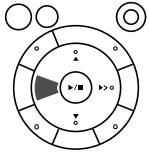

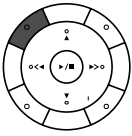
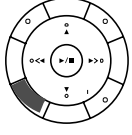
IV Basic Operations

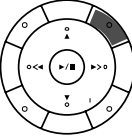
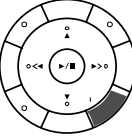
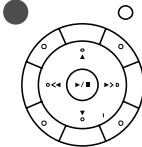
- Please study the chart below “—” means holding the specified key for 1second and “——” means holding the specified key for 2-3seconds. Please make a note of this.

Key	Function
Power On/Off	 <p>Power On: Hold  button for 2-3 seconds. Power Off: Hold  button for 2-3 seconds.</p>
Hold	 <p>Hold Off.</p>
	 <p>Hold On.</p>
Playback and Stop	 <p>Power ON/OFF —— : Power On/Off. MUSIC/VOICE Mode —: Select/Play back file and stop/Pause a file. During a recording and paused recording. —: Stop recording. Selecting a folder in file display mode. —: Select Directory/File. Play style/Main Menu —: Confirm the menu selection. Timer-Recorder(Timer Reservation) —: Save the Timer-Recording. During a timer recording. —: Stop the timer recording.</p>
FILE UP	 <p>MUSIC/VOICE Mode ① In selecting file —: Scroll up through available files. ——: Scroll up through available files faster. ② During Play back —: Skip to the beginning of the current file. ——: Scroll through available files. ③ Player Stopped —: Select a different file/directory or option. AM/FM Mode —: Search for a preset station Play style/Main Menu/ Timer-Recording —: Move up to another directory/option/item</p>

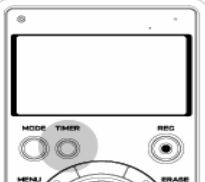
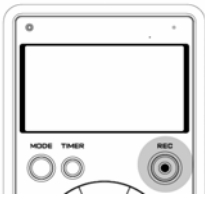
Key		Function
FILE DOWN		<p>MUSIC/VOICE Mode</p> <p>① Selecting a file.</p> <ul style="list-style-type: none"> —: Scroll through available files. —: Scroll through available files faster. <p>② During Play back</p> <ul style="list-style-type: none"> —: Skip to the beginning of the next file. —: Scroll through available files. <p>③ Player Stopped</p> <ul style="list-style-type: none"> —: Return to previous directory. <p>AM/FM Mode</p> <ul style="list-style-type: none"> —: Search for a preset station. <p>Play style/Main Menu/ Timer-Recording</p> <ul style="list-style-type: none"> —: Move up to another directory/option/item.
FF		<p>MUSIC/VOICE Mode</p> <p>① During Play back</p> <ul style="list-style-type: none"> —: 10 Seconds a second fast forward. —: 1 minute a second fast forward. <p>② Player Stopped</p> <ul style="list-style-type: none"> —: 10 Seconds a second fast forward. —: 1 minute a second fast forward. <p>③ Selecting Folder in file display mode</p> <ul style="list-style-type: none"> —: Return to previous directory. <p>AM/FM Mode</p> <ul style="list-style-type: none"> —: Tuning to Next (higher frequency) Station. —: Search through stations. <p>Play style/Main Menu/ Timer-Recording</p> <ul style="list-style-type: none"> —: Move up to another directory/option/item.
REW		<p>MUSIC/VOICE Mode</p> <p>① During Play back</p> <ul style="list-style-type: none"> —: 10 Seconds a second rewind. —: 1 minute a second rewind. <p>② Selecting a Folder in file display mode</p> <ul style="list-style-type: none"> —: Return to previous directory. <p>AM/FM Mode</p> <ul style="list-style-type: none"> —: Tuning to previous (lower frequency) Station. —: Search through stations. <p>Play style/Main Menu/ Timer-Recorder(Reservation)</p> <ul style="list-style-type: none"> —: Move up to another directory/option/item.

Key		Function
MENU		<p>—: Display Main Menu Setup System/Play/Record/Display/Sound options. NOTE: Pressing menu in the Display Main Menu will exit the Display Main Menu.</p>
SPEED		<p>MUSIC/VOICE Mode ① During Playback —: Change Playback speed. Each Press will change playback speed as follows: X1,3spd, X15spd, X05spd, X07spd  Only applicable for MP3 files.</p>
ERASE		<p>MUSIC/VOICE Mode ① Selecting a file —: Erase the selected file or folder. Main Menu —: Escape from the main menu. Timer Recording —: Cancel Timer-Recording.</p>
A↔B/Repeat		<p>MUSIC/VOICE Mode ① Player Stopped (Except in Display Main Menu) —: Select Internal or External Memory. ② During Playback —: Select “A-B Repeat” or “One touch Repeat” —: Change File Repeat Option.</p>
Mode		<p>—: MUSIC, VOICE, AM, FM Mode Selection. MUSIC/VOICE Mode —: Select the play style.</p>
Volume		<p>Volume Up and Down —: Increase/decrease the Volume. —: Increase/decrease the Volume faster.</p>



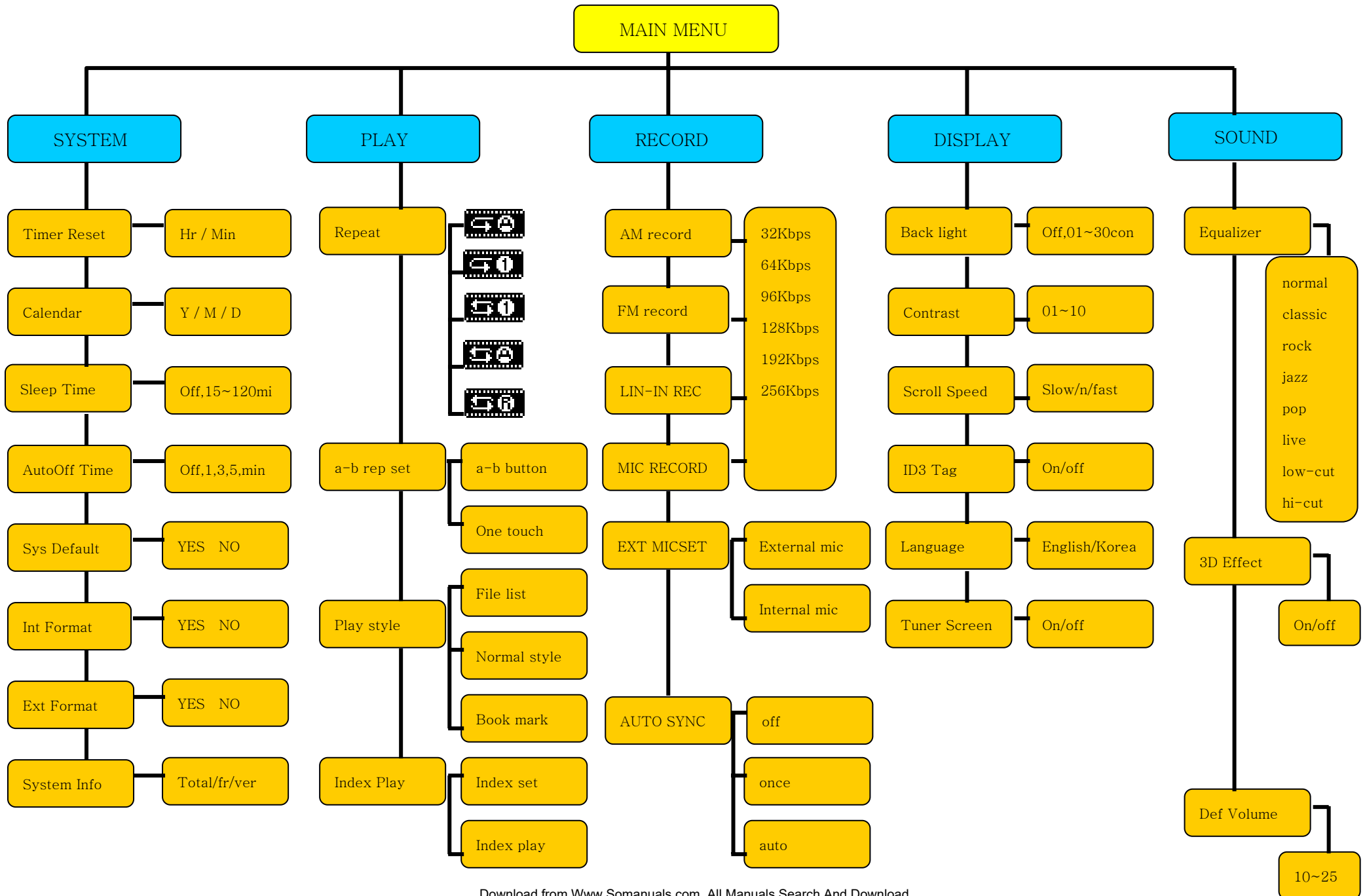

Key		Function
TIMER		<p>—: Display scheduled Timer-Recording(s) ↳ Displays for 10 seconds</p> <p>—: Schedule a Timer-Recording.</p>
REC		<p>MUSIC/VOICE Mode ① In file selection —: Record thru internal or external Microphone.</p> <p>AM/FM Mode —: Record AM/FM Radio.</p> <p>① Recording —: Pause recording.</p> <p>② Paused —: Restart recording.</p> <p>③ Timer-Recording —: Pause Timer-Recording.</p> <p>④ During a paused Timer-Recording —: Restart Timer-Recording.</p>
LED LAMP		<p>LED LAMP During a recording the LED will light up red.</p>
Internal Microphone		<p>High quality internal microphone used for recording.</p>
RESET		<p>– If the unit hangs up, insert a thin object into the reset hole and gently push. After the reset, the unit will operate normally and no settings are lost.</p> <p>– Do not use a sharp object to reset the unit.</p>





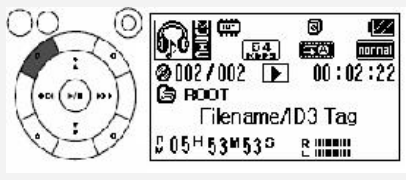
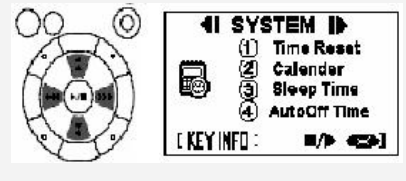
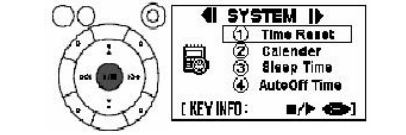
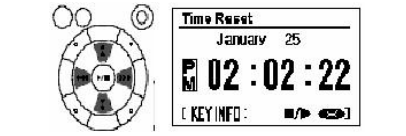

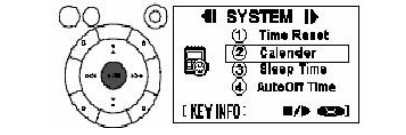
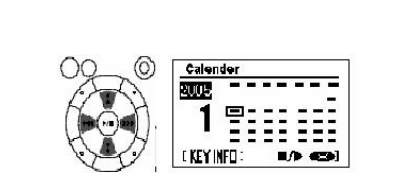

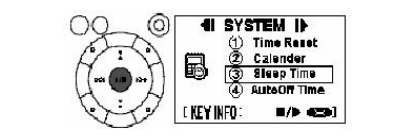
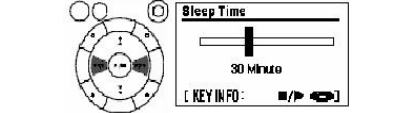
V MAIN MENU STRUCTURE

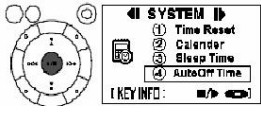
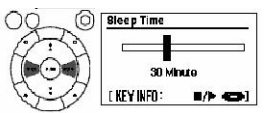

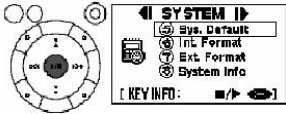
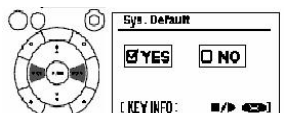
VI Main Menu

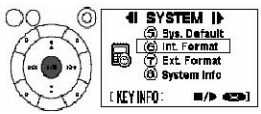
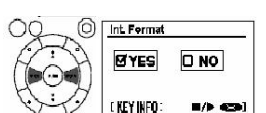

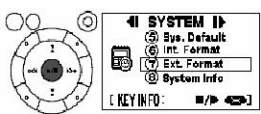
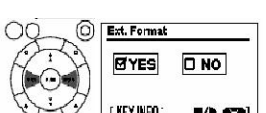
1 SYSTEM

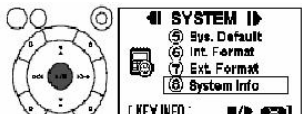



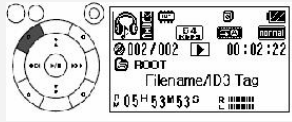

Key		Function	Setting
MENU	Display and Key operation		
SYSTEM		Used to Set: <ul style="list-style-type: none"> - Timer Reset - Calendar - Sleep Time - Auto off - Sys Default - Int Format - Ext Format - Sys Information 	① Press "MENU"
			
TIME SET		Used to set the current time.	③ Select "Time Set" and press ►/■
			④ Setting Hour/Minute <ul style="list-style-type: none"> - Change time: ▲▼ - Moving between Hr and Min: <◀▶>
		Complete Setting	⑤ Press ►/■ to complete setting and exit.
CALENDAR		Used to Set: <ul style="list-style-type: none"> - Present year - Present month - Present date ☞ Up to 2099 	③ Select "Calendar" and press ►/■
			④ Setting <ul style="list-style-type: none"> - Use ▲▼ to move between year, month and date. - Use ◀▶ to Change year, month and date
		Complete Setting	⑤ Press ►/■ to complete setting and exit.
SLEEP TIMER		Set unit to turn off after a designated time (15, 30, 45, 60, 75, 90, 105, 120 min)	③ Select "Sleep Timer" and press ►/■
			④ Use ◀▶ to select desired time.

		Complete Setting	⑤ Press ►/■ to complete setting and exit.
AUTO OFF Time		Unit will turn off when there are no button presses for specified amount of time. (1, 3, 5 Min)	③ Select “Auto Off Time” and press ►/■
		Auto off doesn't work when playing back a file, recording, or when receiving a radio station	④ Use ◀▶ to select desired time.
		Complete Setting	⑤ Press ►/■ to complete setting and exit.
SYS Default		Use System Default to restore the unit to its factory settings.	③ Select “SYS Default” and press ►/■
			④ Use ◀▶ to select “YES” or “NO”
		Complete Setting	⑤ Press ►/■ to complete setting and exit.
INT FORMAT		Use Int Format to format the internal memory and erase all files.	③ Select “Int format” and press ►/■
			④ Use ◀▶ to select “YES” or “NO”
		Complete Setting	⑤ Press ►/■ to complete setting and exit.
EXT Format		Use Ext Format to format an external memory card and erase all its files. You must format a mem-card (using this method) BEFORE using it in the unit.	③ Select “Ext format” and press ►/■
			④ Use ◀▶ to select “YES” or “NO”
		Complete Setting	⑤ Press ►/■ to complete setting and exit.
MEMORY INFO		Used to see available memory.	③ Select “Memory info” and press ►/■

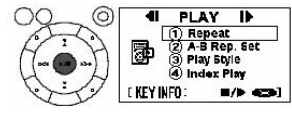
	Complete Setting	⑤ Press ►/■ to exit
---	------------------	---------------------

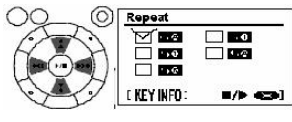

2 PLAY

Key		Function	Setting
MENU	Display and Key operation		
PLAY		Used to Set <ul style="list-style-type: none"> - Repeat - A↔B/Repeat - Play style - Index Play 	① Press “MENU” and use ◀▶ to select the “PLAY” menu.
			② Move to desired setting using ▲▼

REPEAT		 : Play all files in order and stop.	③ Select “REPEAT” and press ►/■
		 : Play only 1 file and stop.  : Play 1 file repeatedly.  : Play files repeatedly in order. (5,4,3,2,1 etc)  : Randomly play all files.	

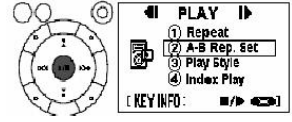
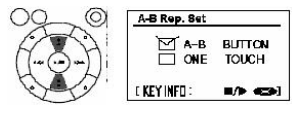
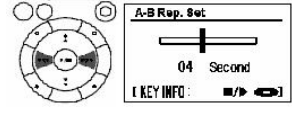
	Complete Setting	⑤ Press ►/■ to complete setting and exit.
---	------------------	---

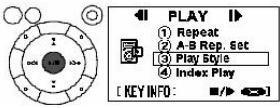
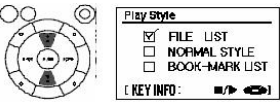
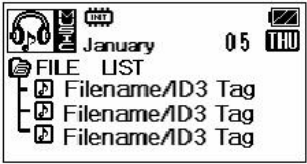
A↔B/Rep		A↔B Button: Repeatedly play a designated section of a file. You select the section by pressing the (A-B) button at a beginning point and then again at an ending point ONE TOUCH: Press (A-B) button during the playback of a file, and the unit will play the section repeatedly per the value selected (02, 04, 08, 16 sec)	③ Select “A↔B/RepSet” and press ►/■
			
		⑤ If using ONE TOUCH option, select desired time (02, 04, 08 and 16 sec) by	

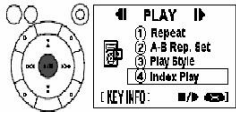
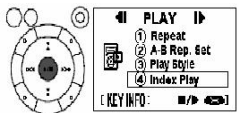
			using ◀▶
		Complete Setting	⑥ Press ▶/■ to complete setting and exit
PLAY STYLE		Use to set playback settings <ul style="list-style-type: none"> - File List - Normal Style - Book-Mark List 	③ Select “Play Style” and press ▶/■
			④ Use ▲▼ to select desired option and press ▶/■
		“FILE LIST” will show all files regardless of directory.	
		“NORMAL STYLE” (Directory View) view folders and/or files.	In this mode select desired folder by pressing ▶, go back to previous folder by pressing ◀
	“BOOK MARK” will only show bookmark files, max 10. ★ Filename/ID3 Tag : In any play style mode, select a desired file to BOOKMARK, & the file will be marked by a star icon (shown above) If you press “SPEED” when a file has a star icon, it will release the bookmark and change the star icon back to a music icon. To see and listen to your book mark files, select BOOK-MARK LIST from the PLAY STYLE menu.	Use the “SPEED” button to bookmark, or release a bookmark.	
INDEX PLAY		Used to select a starting point that a file will begin playback from.	③ While listening to a file, select “INDEX PLAY” and press ▶/■
			④ Press ◀▶ to set index and press ▶/■

		<p>An index file plays from the selected point of the file.</p> <p>Only one point per file is applicable and if another file is indexed, the previous index is released.</p> <p>Index file can be played by pressing ▲▼ to select “Index Play” and pressing ►/■</p>	<p>You can play index file by selecting “Index Play” and pressing ►/■</p>
--	---	---	---



3 RECORDING

🔍 Precaution before recording

Please make sure of the following before recording:

- Select the internal or external memory.
- Check the amount of available memory.
- Select a bit rate.
- Check the battery life.

- We recommend using default bit rates.

Key		Function	Setting
MENU	Display and Key operation		
Memory Type		 : Internal Memory  : External memory	Select Int memory or Ext memory by pressing the A-B/REPEAT button in AM, FM, MUSIC or VOICE mode.

		If you press “A-B/REPEAT” without a memory card in the external memory slot, the error “NOT INSERTED CARD” will appear.	
		The memory remain icon is only displayed in AM/FM Mode.	Press “MODE” to select AM or FM in order to view how much memory remains.

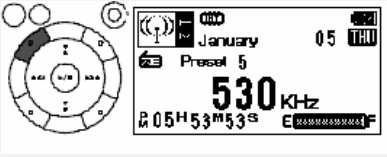
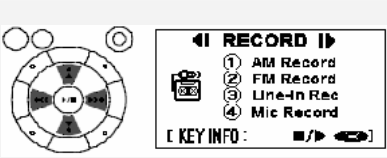
RECORD		Same procedure is used to set: <ul style="list-style-type: none"> - AM Record - FM Record - Line In Rec - Mic Record - Ext Mic Set - Auto Sync 	① Press “MENU” and use ◀▶ to select the “RECORD” menu.
			② Select “AM, FM, Line-in or Mic Record” using ▲▼

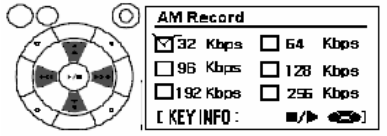
SELECTING BIT RATE		The higher the bit rate the better quality the recording will be. However, the recording will use more memory space. Before recording, Please make sure you have enough memory available.	③ Press ▶/■
			④ Select desired “bit rate” using ▲▼◀▶

		Complete Setting	⑤ Press ▶/■ to complete setting and exit.
--	---	------------------	---

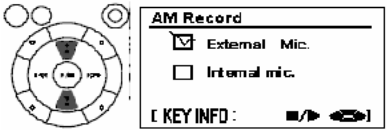
Setting LINE-In/Mic		<p>🔊 When connecting the unit to an external device (lapel mic etc), the unit must be off.</p> <p>NOTE: MIC/Line-In option is used for LINE-IN/MIC-IN recording.</p>	① Select “line-In/Mic” and press ▶/■
			② Use ▲▼ to select desired option and press ▶/■

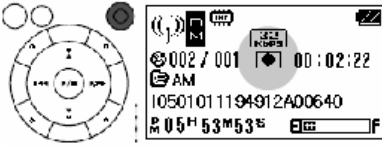
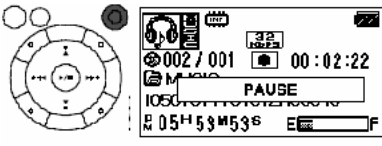
Recording AM/FM Radio		<ul style="list-style-type: none"> - Recording format: MP3 During a recording(“REC”) <ul style="list-style-type: none"> - RED LED is ON - MP3 File automatically created. - Record up to 999 files. - A file recorded from AM Radio, will be saved in the AM Folder. A file recorded from FM radio, will be saved in the FM folder. ☞ To view folders, make sure you set “PLAY STYLE” to NORMAL under the PLAY MENU	② Press “ REC” button to record.
			③ Press” REC” button to Pause. ④ Press “▶/■” to Stop recording.

Recording by External Microphone/Line-in

When trying to record using the External Mic/Line-in, make sure an external microphone and/or Line in cable is securely connected to the LINE/MIC jack (External Input Terminal) and make sure you set “Line-In/Mic” to **MIC/Line-In** under the **RECORD MENU**.

☞ If an external microphone (lapel Mic etc) is connected, the internal microphone will not work.

Recording thru Ext Device

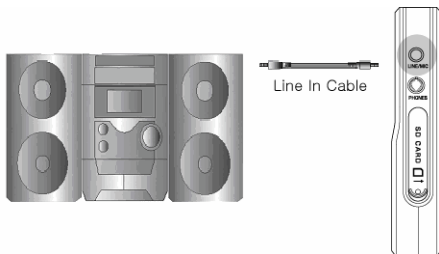

Connect one end of the Line-in cable to the headphone/line-out jack of your external device and the other end to the LINE/MIC jack of the set.

☞ When recording from an external device, adjust the volume of the source to avoid distorting the recording.

AUTO SYNC

AUTO SYNC REC: This separates a line-in recording into files by detecting the end of a file and creating a new file automatically while continuing or stopping the recording. You have 3 options:

① AUTO SYNC “OFF”



The file from the external device is recorded as one file only Simply press **RECORD** to start the recording and **PLAY** to stop it.

② AUTO SYNC “ONCE”

Only **ONE** file from the external device will be recorded Simply press **RECORD** and once the unit detects the end of the file, it will stop recording.

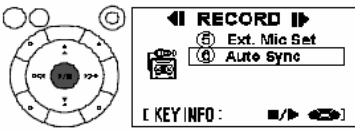
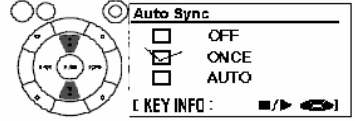

③ AUTO SYNC “AUTO”





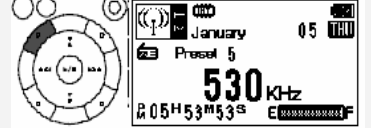

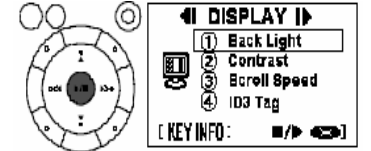

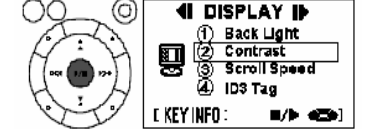

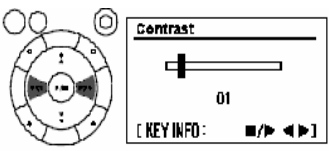
This separates the recording into individual files (one by one) by detecting the end of a file and creating new files until all the files from the external device are recorded. Simply press **RECORD** and once the unit detects that all files have been recorded, it will stop recording.

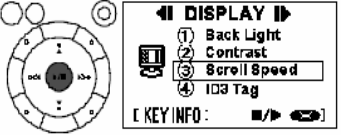
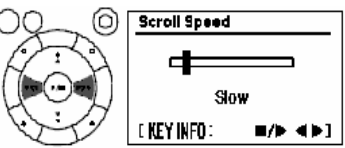

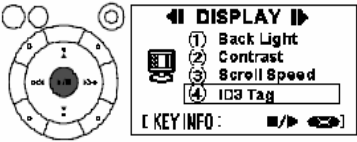
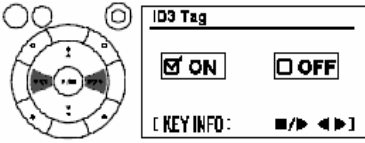
		<p>④ Select “Auto Sync” and press ►/■</p>
		<p>⑤ Select desired option using ▲▼</p>
		<p>Complete Setting Press ►/■ to complete setting and exit.</p>

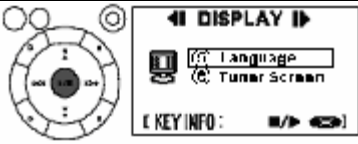
4 DISPLAY

Key		Function	Setting
MENU	Display and Key operation		
DISPLAY		<p>Use to set</p> <ul style="list-style-type: none"> - Back Light - Contrast - Scroll Speed - ID3 TAG - Language - Tuner Screen 	<p>① Press “MENU”</p> <p>② Use ◀▶ to select the “DISPLAY” menu.</p>

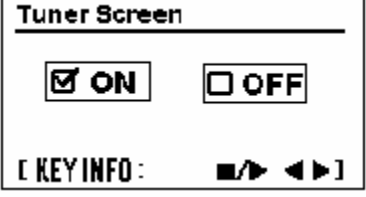

BACK LIGHT		<p>Select Backlight on time</p> <ul style="list-style-type: none"> - OFF : Back Light off - 01, 03, 05, 10, 20, 30 : Back Light on per selected time - Continue: Back Light always on. 	<p>③ Select “BACK LIGHT” using ▲▼ and press ►/■</p> <p>④ Set desired backlight time by using ◀▶</p>
		<p>Complete Setting</p>	<p>Press ►/■ to complete setting and exit.</p>
Contrast		<p>Adjust LCD Contrast</p>	<p>③ Select CONTRAST using ▲▼ and press ►/■</p>

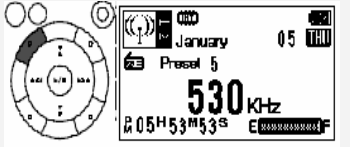
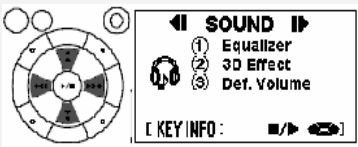

		Contrast Brightness Level 01, 02, 03, 04, 05, 06, 07, 08, 09, 10	④Set Contrast using ◀▶
		Complete Setting	Press ▶/■ to complete setting and exit.
Scroll Speed		Select how fast file info scrolls on the LCD screen.	③Select “SCROLL SPEED” using ▲▼ and press ▶/■
		Scroll Speed Option: – Slow, Normal, Fast	④ Select desired option using ◀▶
		Complete Setting	Press ▶/■ to complete setting and exit
ID3 TAG		Display file information. ON: Title/Artist display. Off: No Title/Artist display.	③ Select “ID3 TAG” using ▲▼ and press ▶/■
			④Select desired option using ◀▶
		Complete Setting	Press ▶/■ to complete setting and exit
Language		Display information on the LCD screen in the selected language.	③ Select “LANGUAGE” using ▲▼ and press ▶/■
			④Select desired option using ▲▼◀▶
		Complete Setting	Press ▶/■ to complete setting and exit.
Tuner Screen		– Will turn off the Tuner Screen when receiving or recording AM/FM Radio.	③ Select “TUNER SCREEN” using ▲▼ and press ▶/■

		<ul style="list-style-type: none"> - Turn OFF the Tuner Screen for better reception and recording quality. - Display will disappear after 5 seconds when Tuner Screen is set to OFF. 	④Select desired option using ◀▶
		Complete Setting	Press ▶/■ to complete setting and exit

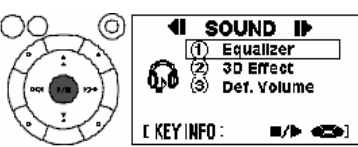
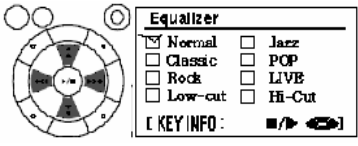
5 SOUND

Key		Function	Setting
MENU	Display and Key operation		
SOUND		Setting <ul style="list-style-type: none"> - Equalizer - 3D Effect - Def Volume 	① Press “MENU”
			②Use ◀▶ to select the “DISPLAY” menu.

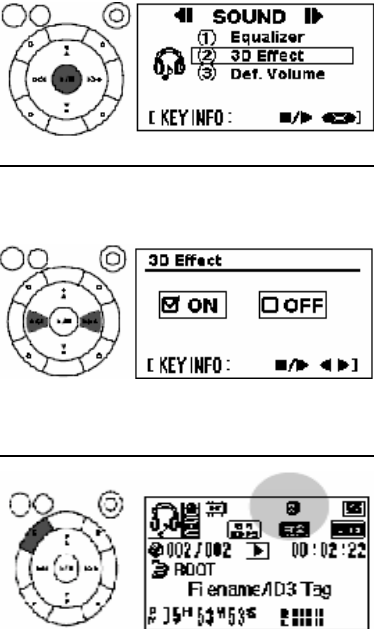
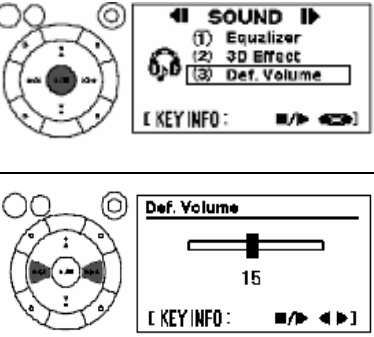
Equalizer		8 Equalizer <ul style="list-style-type: none"> - Normal: “NOR” - Jazz: “JAZ” - Classic: “CLA” - POP: “POP” - ROCK: “ROC” - LIVE: “LIV” - LOW-CUT: “LOW” - Hi-CUT: “HI” LOW-CUT: Remove noise at a low frequency. Good for recording AM/FM Hi-CUT: Remove noise at a high frequency. Good for recording AM/FM	③Select “Equalizer” using ▲▼ and press ▶/■
			④Select desired option using ▲▼◀▶
		Complete Setting	Press ▶/■ to complete setting and exit.

<p>3D Effect</p>			<p>③ Select “3d Effect” using ▲▼ and press ►/■</p> <p>④ Setting 3D Effect</p> <ul style="list-style-type: none"> - Select desired option using ◀▶ - Press ►/■ to complete setting and exit. <p>⑤ 3D Icon will be displayed.</p>
<p>Def Volume</p>		<p>Set the default volume you want the unit to use.</p> <p>Def volume options: 10,11,12,13,14,15,16,17, 18,19,20,21,22,23,24,25</p>	<p>③ Select “Def Volume” using ▲▼ and press ►/■</p> <p>④ Select desired option using ◀▶</p>
		<p>Complete Setting</p>	<p>Press ►/■ to complete setting and exit.</p>





VII FURTHER OPERATION

1. Playback Speed

The playback speed (while playing a file) can be changed using the rewind or fast forward keys. (- short press; 10 seconds a second) (- - long press; 1 minute a second)

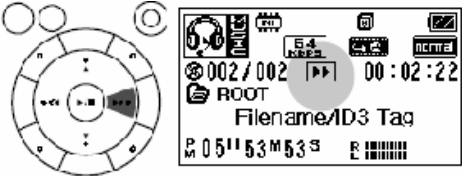
While Playing back

1) Forward and Rewind

Forward (▶▶)	Rewind(<<)
	
<p>▶▶ : Display will show  (- Short) on the LCD and the file will fast forward 10 seconds a second until the end of the file.</p> <p>▶/■ : Return to a normal play speed.</p>	<p><< : Display will show  (- short) on the LCD and the file will rewind 10 seconds a second until the end of the file.</p> <p>▶/■ : Return to a normal play speed .</p>
<p>▼ : Skip current file and play the next file.</p> <p>▲ : Skip current file and play the previous file.</p>	

2) Playback Speed



You can change the playback speed of a file by pressing the “SPEED” button. Each press will speed up or slow down the file as follows: x13, x15, x05, x07 and back to normal. This function only works with MP3 files.

2 ERASING FILES

Erase unwanted files in the internal or external memory.

Display	Key Operation
	① Use ▲▼ to select desired file.
	② Press “ERASE”
	③ Select “YES” by pressing ◀ and press ▶/■ to erase the file.

You can't erase a file that is playing in the unit. ① Please stop playing the file ② so you can erase it per the instructions above.



⚠ Once a file is deleted, it can not be recovered.

When erasing a file, DO NOT press any other key.

3 AM/FM Radio

1) FM Radio Reception

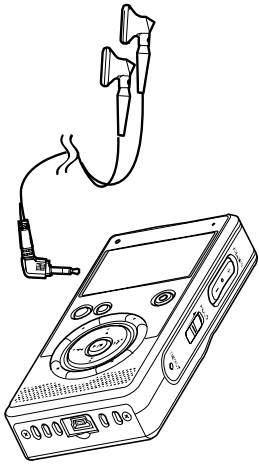
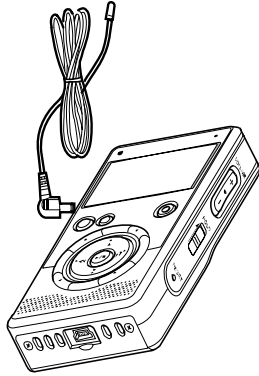
① Stereo Earphone	② External Antenna
	
Stereo earphone acts as the antenna for the FM radio.	Plug in the provided Ext Antenna into the phones jack; in order to listen to FM broadcasts using the speaker.

2) AM Radio Reception

The antenna to receive AM broadcasts is embedded in the unit. You are not required to plug in an external antenna in order to listen to AM radio. Please avoid placing the unit near electrical devices such as PC, iron structure building, TV or in a closed environment as this can interfere with your ability to get good reception. Place the unit near a window to get the best reception.

☞ If you set “**TUNER SCREEN OFF**” in the **DISPLAY MENU**, reception will be better.

Noise from LCD operation is decreased by turning off the LCD.

When the tuner screen is set off, pressing any button, will allow you to view the display.

Auto Seek: If you press and hold <◀ or ▶> about 1 second, the unit will attempt to find an audible broadcast channel. This will save you time in an unfamiliar area. After finding a station, Auto Seek will stop. When using Auto Seek to find a station, precise **TUNING** may not be available, in that case please perform a fine adjustment using the REW or FF key.

Preset: User can save (preset) up to 10 desired radio stations for quick access:

- ① Select a desired station to preset.
- ② Press “▶/■”, and “Preset” will display and flicker on the LCD screen.
- ③ Select a desired preset No (1-10) using ▲▼ and save the preset by pressing ▶/■

Note: If you take too long (4 seconds) to confirm (i.e. push a button during the process) you will have to start all over again.

☞ Selecting a preset radio station

To quickly select a preset station press ▲▼ when in AM/FM mode.

To go back to normal tuning, use ◀▶

4 TIMER-RECORDING

You can program the unit to automatically record radio broadcasts via a daily or weekly timer-function; totally unattended. ☞ Before setting a “TIMER RECORDING”, the current time and date must be correctly set.

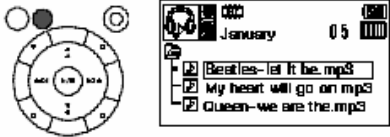
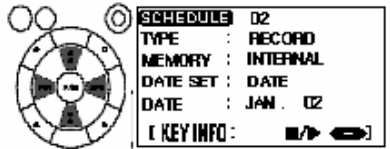
Key and Display	Operation
	<p>① Press and hold TIMER (--)</p> <p>You can not set a timer recording when the unit is playing back a file, recording or in the menu mode.</p>
	<p>② Select different items using ▼</p>
<p>Cancellation of Setting</p>	<p>③ Cancel TIMER RECORDING by pressing ERASE button.</p> <p>④ Use ◀▶ to select YES and press ▶/■</p>
<p>Save setting</p>	<p>③ Save a TIMER RECORDING by pressing ▶/■ during the setting.</p> <p>④ Use ◀▶ to select YES and press ▶/■</p>
<p>☞ If Start and end times are the same, the TIMER RECORDING screen will display the following error</p> <p>NOT USED END TIME and the Timer-Recording will not be set.</p>	

5 Timer Recording Settings

Select an item using ▼▲ and select an option using ◀▶

Setting Item	Option	Function and Operation
① Timer Recording No (SCHEDULE)	01~20	Select Timer Recording No 1-20 using ◀▶ The file recorded by a TIMER RECORDING is saved its BOX folder (No01 will go in BOX01, No02 in BOX02 etc) ☞ The file recorded in BOX01-20 is available in VOICE mode only. You can view folders by setting the Play Style to Normal Style in the Play menu .
② TYPE	DISABLE	TIMER-RECORDING OFF (WILL NOT RECORD/TURN ON)
	RECORD	Start Recording on a set time/date (Timer-Recording)
	PLAY	Play music/radio on a set time/date (Alarm Function)
③ MEMORY	INTERNAL	Record to the Internal Memory Use ▲▼ and highlight "MEMORY", press ◀▶ to select INTERNAL or SD CARD.
	EXTERNAL	Record to an External memory card (refer to procedure above)If a memory card is not inserted in the unit, the error "CAN'T READ SD-CARD" will be displayed for 3 seconds.
④ DATE SET	Setting Day, Month and Year <ul style="list-style-type: none"> - Use ▲▼ and highlight "DATE SET", press ◀▶ to select WEEK or DATE. - If using WEEK, use ▼ and highlight "WEEK" and select day using ◀▶ - If using DATE, use ▼ and highlight "DATE" and select Month using ◀▶ - Next move to day field using ▼ and select a day of the month using ◀▶ - Once you set Month and day use ▼ to move to another setting. 	
	WEEK	Set Day (Mon, Tue, Wed, Thu, Fri, Sat, Sun, M-F) Use setting to record same day(s)/time every week.
	DATE	Set Month and Day (ex Mar 05) Use to record a specific date/time one time during a year.
If ②TYPE is set to PLAY , Source option is AM, FM and MUSIC Use ▲▼ to select Source and ◀▶ for option.		

⑤ SOURCE	SOURCE AM	Use ▲▼ to select FREQ, press ◀▶ to select preset, or ▼ and then ◀▶ to select a station and ▼ to finalize selection.
	SOURCE FM	Use ▲▼ to select FREQ, press ◀▶ to select preset, or ▼ and then ◀▶ to select a station and ▼ to finalize selection.
	SOURCE MUSIC	Use ▼ to highlight folder field and ◀▶ to select a specific folder, Press ▼ to highlight file field and ◀▶ to select a specific file and ▼ to finalize selection.
If ②TYPE is set to RECORD, option is AM, FM, MIC and LINE Use ▲▼ to select Source and ◀▶ for option.		
⑤ SOURCE	SOURCE AM	Use ▲▼ to select FREQ, press ◀▶ to select preset, or ▼ and then ◀▶ to select a station and ▼ to finalize selection.
	SOURCE FM	Use ▲▼ to select FREQ, press ◀▶ to select preset, or ▼ and then ◀▶ to select a station and ▼ to finalize selection.
	SOURCE MIC	Record using the microphone (Ext or Int) a certain day/time per WEEK/DATE setting. External Microphone has priority. - Bit rate: 32, 64, 96,128,192 and 256 selectable
	SOURCE LINE-IN	Record from external device a certain day/time per WEEK/DATE setting; even if external device is not connected. Bit rate: 32, 64, 96,128,192 and 256 selectable
⑥ BITRATE	BITRATE	Use ▲▼ to select BITRATE, ◀▶ to change ▼ to finalize.
⑦ START/END	Hr and Min	Use ▲▼ to select START, ◀▶ to change hour ▼ to select minute, ◀▶ to change minute ▼ to move to End Time and repeat procedure again.
⑧ Save the TIMER-RECORDING		Press ▶/■ and use ◀▶ to select "YES" and press ▶/■

VIII PC CONNECTION

1 Win XP, 2000 and ME

You can connect the unit with a computer using the provided USB cable. No special application is required unless you use Win98SE

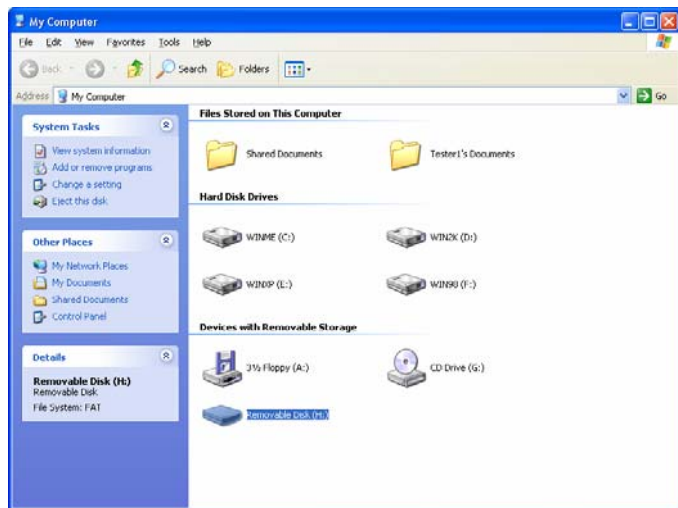
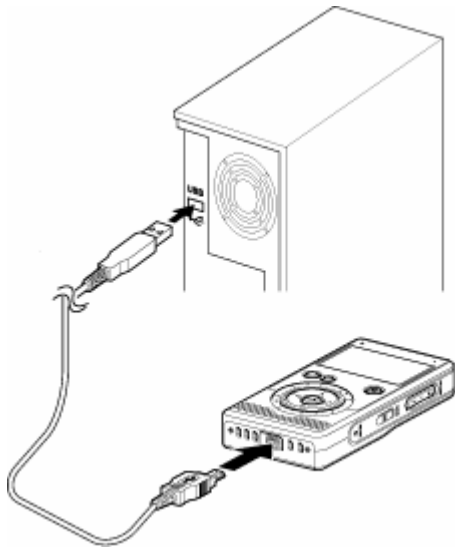

When you connect the unit to a USB port, it will be recognized as a “Removable Disk” in Win XP, 2000, ME

2 Install Driver for Win98SE

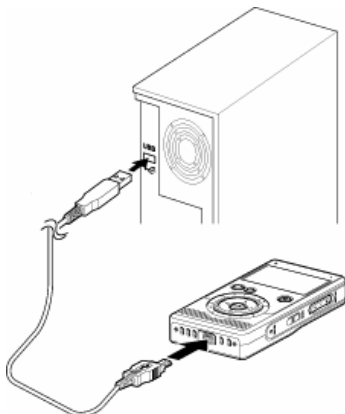

① Connect device to USB port

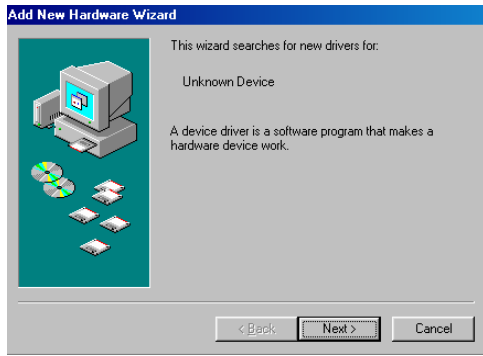

② Click “Unknown Device” window



③ Check ‘Search for the best driver for your device’ and click ‘next’



④ Check ‘Specify a location’

⑤ Insert Driver CD inside your computer’s CDROM

⑥ Click “Next” button

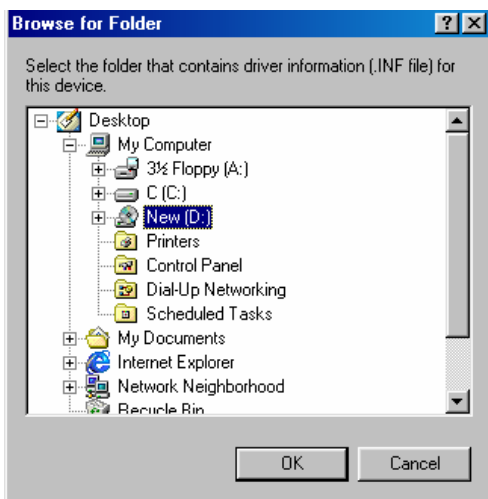

⑦ Click your CDROM drive (D: in most cases) and click “OK”



⑧ Click 'Next'



⑨ Click 'Finish' to complete installation

To make sure the installation has been successfully completed, check for the device in the device manager: [My Computer]-[Control Panel]-[System]-[Device Manager]

3. PC Connection Display

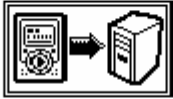
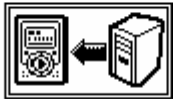
"USB CONNECT"	"FILE UPLOAD"	"FILE DOWNLOAD"
 <p data-bbox="118 1429 456 1480">USB CONNECT</p>	 <p data-bbox="617 1429 956 1480">FILE UPLOAD</p>	 <p data-bbox="1112 1429 1450 1480">FILE DOWNLOAD</p>

4. Safely Removing Hardware from a PC

You are required to safely remove your hardware before disconnecting the device from the USB port.

① Close open files

If there are any open files in the unit, you should close them to avoid any errors.

② Click (), in the tool bar:



③ The following window will show, select USB Mass Storage Device and click ok. After that, select USB Mass Storage device again and click stop.

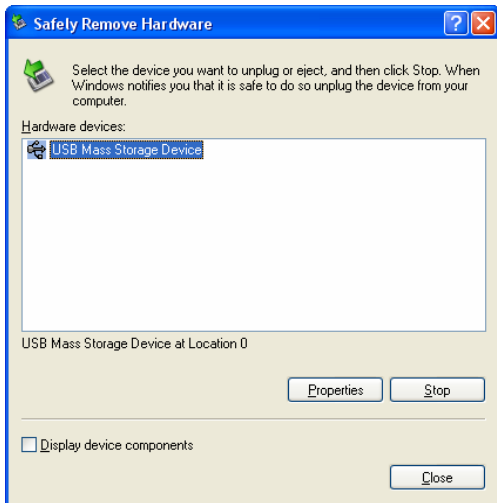

④ When you get the message below, it is safe to disconnect the USB cable from the PC.



IX FORMATTING

1 Formatting Memory using a PC

☞ Format must be done in FAT and all files and settings are lost when you format

① Click [My Computer] and right click Removable Disk (usually E/F:) and the following toolbar will appear

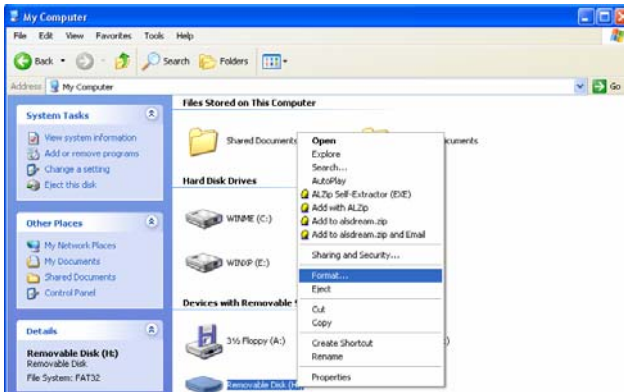

② Click “Format”

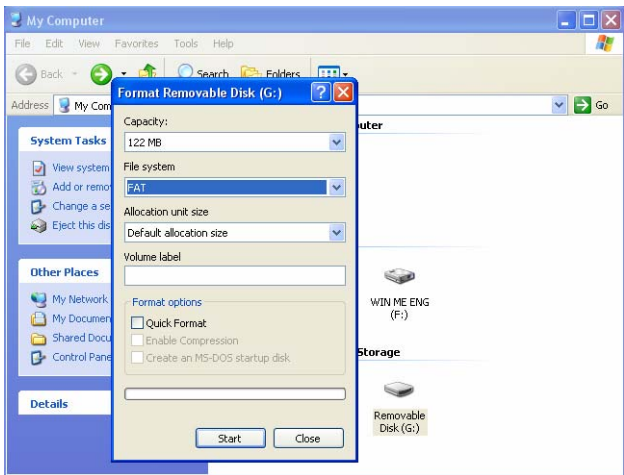

③ Choose FAT and then click ‘start’

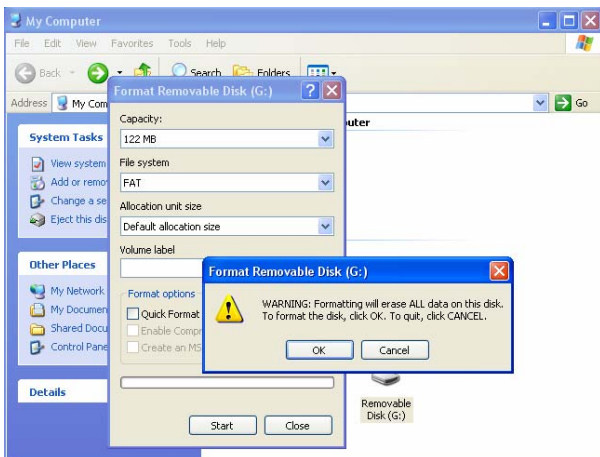

④ Click 'ok'

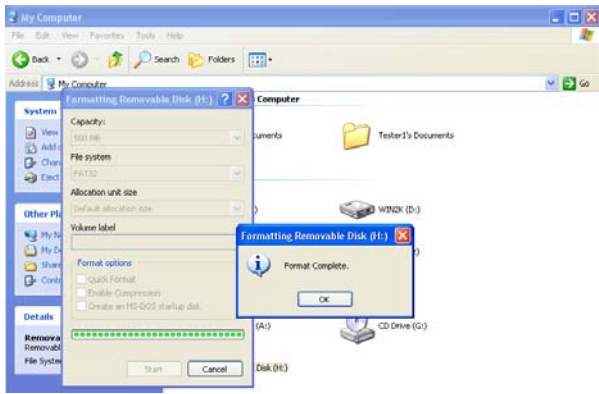

⑤ Format is complete

2. Formatting memory using the unit (without a connection to a PC)

① Press "MENU"

② Move to desired setting (INT/EXT Format) using ▲▼

③ Select "Int format" and press ►/■

④ Use ◀▶ to select "YES" or "NO"

⑤ Press ►/■ to complete setting and exit.

③ Select "Ext format" and press ►/■

④ Use ◀▶ to select "YES" or "NO"

⚠ If you format the memory all files are lost.

3. Formatting current firmware

If the unit stops working normally, (hangs up and does not operate properly despite a normal reset), please try to format the current firmware. If you do this, all the settings except the date and time will initialize.

- ① Hold On
- ② Hold ERASE key for 10seconds
- ③ While holding the ERASE key, gently press the “RESET” hole using a thin object
- ④ Keep holding “ERASE” until “Please Wait……Formatting” is display on the LCD
- ⑤ Hold off
- ⑥ Turn On

✎ After formatting the firmware, the display will be normal. However, we recommend you download and install the latest firmware from <http://www.pogoproducts.com/pogoftp.html>

X UPGRADING FIRMWARE and FONT

You can improve functions and/or correct errors by upgrading firmware:

- ① The latest firmware can be downloaded from <http://www.pogoproducts.com/pogoftp.html>
- ② To do a firmware upgrade, copy the firmware file(*yuf) to the root folder of the unit.
- ③ After transferring the file, disconnect the USB cable and reset the unit to begin the upgrade.
- ④ When you reset the unit, it will automatically try to upgrade the firmware.

✎ The unit automatically detects its firmware version, so if the firmware is older than the current one inside the unit, the upgrade will not take place. If the unit is not operating properly, please format the current firmware before trying to upgrade the firmware.

XI DISPLAY MESSAGES

NO FILE

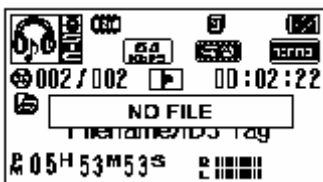

CHARGE NEEDED

CHARGING

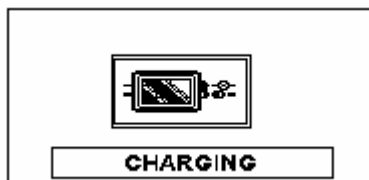

CONNECTING USB TO PC

CHARGING COMPLETE



UPLOADING FILE TO PC



NEED FOR CHARGE

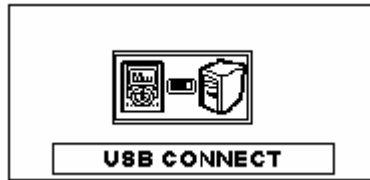

USB CONNECT



FILE UPLOAD

DOWNLOADING FILE TO SET

BOOKMARK ADDED

BOOKMARK FAILED



FILE DOWNLOAD

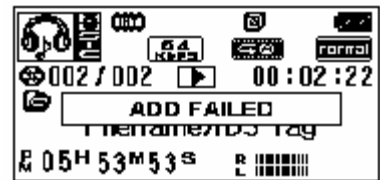
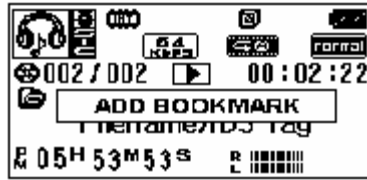

DELETING COMPLETE

NO TIMER RECORDING

INITIALIZING

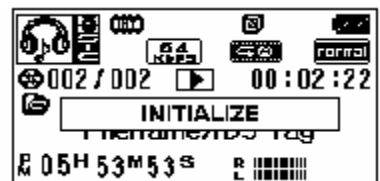
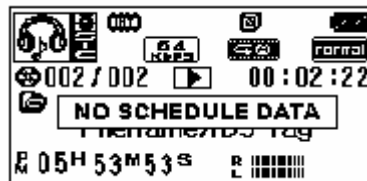
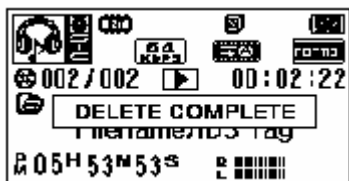

SEARCHING FILE

MEMORY IS FULL

INDEX IS FULL

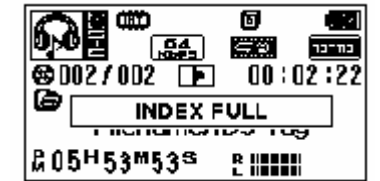
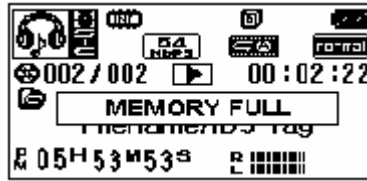

NO MEMORY CARD FOUND

CAN'T READ SD-CARD

NOT ENOUGH MEMORY SPACE

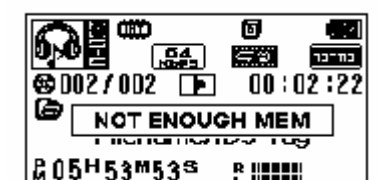
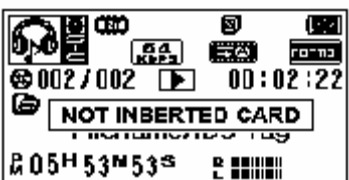

OVERLAPPING SCHEDULE

NEED SETTING TIME

NO BOOKMARK

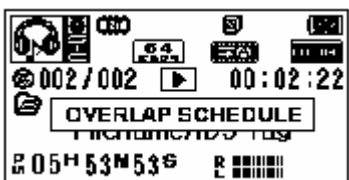

FAILED INITIALIZING

FAILED to DELETE FILE

FAILED UPGRADING

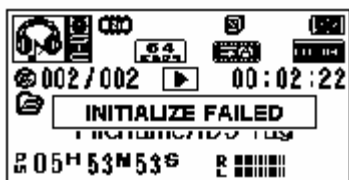

NO INDEX

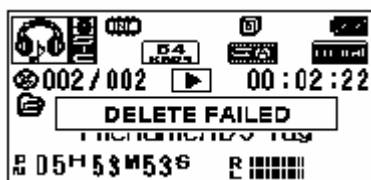

END TIME NOT SET

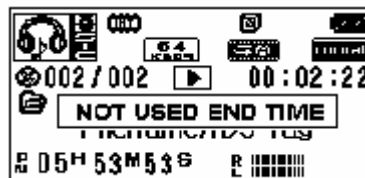
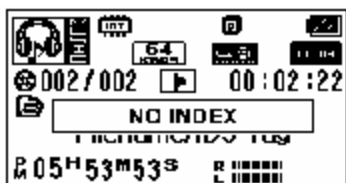
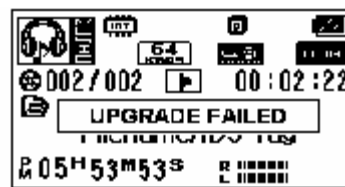

General Specification

MODEL		RadioYourWay LX
VOICE RECORD/ PLAY	RECORD TIME	128MB: 510Min / 512MB: 2040Min at 32Kbps
	MODE	MP3 FORMAT
	FILE	VOICE : 99pcs / MP3
	FM Record	Stereo (875MHz~108MHz)
	AM Record	530 ~ 1710KHz
	Timer Record	Date / Week
	Mic	Built-in Mic / Line (external Mic)
	Record Device	Built-in Flash Memory / EXT (MMC/ SD CARD)
	S/N	45db (62db input 1Khz, speaker output 200mW)75khz
	Distortion	3%±02 (62db input 1Khz , speaker output 100mW : HQ mode)
	Freq. Response	400Hz~32KHz (-6db)
	Output Power	Max 8mW (stereo earphone 16ohm)
	Repeat play	One message repeat / Continue message repeat / A-B repeat
Timer Record	20 Timer Recording Slots	
FM RADIO (stereo)	S/N	45db at 1mv 981MHz
	Distortion	08%(max) at 1mv 981MHz Δf=225KHz
	Freq. Response	350Hz±30Hz,3KHz±025KHz (150Hz~25KHz,60dbuV)
	Sensitivity	5uV at S/N=26db
	Frequency Cover range	875 ~ 108MHz
	Preset Mode	10 Radio station
AM	S/N	35db

RADIO	Distortion	3%
	Freq. Response	150Hz – 15KHz at 0db
	Sensitivity	68dbuV at 1KHz
	Frequency Cover range	530 ~ 1710KHz
	Preset Mode	10 Radio station
MP3	Bit/rate	32Kbps~256Kbps (MPEG 1/2 LAYER 3)
	S/N	85db up (1KHz input 0db)
	Distortion	03%±005 (1KHz input 0db)
	Freq. Response	20Hz~20Khz
	Earphone	Max 8mw (16ohm)
	EQ	EQ : NORMAL, ROCK, POP, CLASSIC, LIVE, Low-Cut, Hi-Cut
	Repeat play	NOR/ NOR1/ 1ALL/ ALL/Random
Sound	3d Sound	
PC interface	communication	USB 1.1
	System	CPU200MHz more than , RAM 64MB more than, 20MB of free space
	OS	Windows98SE , Windows2000 , Windows ME , Windows XP, MAC OS X and above
	Sound card	Sound Blaster 16 compatible
	Display	640X480 more than
IN/OUT JACK	Ext mic/line in	φ 35 plug-in power microphone(mini plug / stereo) IMP less than 3KΩ
	Earphone	φ 35 earphone(mini plug / stereo) IMP less than 16Ω
	DC JACK	USB JACK
	USB	Mini jack (PC : A TYPE)
SPEAKER	Diameter	φ 16(IMP 8Ω)
	Max output	200mw (volume max)
VOLUME	Digital volume (30 step)	
MEMORY	Nand flash Memory	
LED	Recording display LED (RED)	
LCD (FSTN)	MODE	VOICE/AM/FM/MP3
	Messages	01~99(INDEX)
	EQ	NOR, ROC, POP, CLA, LIV
	Repeat	NOR/ NOR1/ 1ALL/ ALL
	CLOCK	CLOCK, SUN, MON, TUE, WED, THU, FRI, SAT
ADAPTOR	DC5V / 500mA(CE, CUL, T, FCC)	
KEY FUNCTION	FF/ PLAY/ STOP/ REW/ FSEARCH/ RSEARCH/ REC/ REPEAT/ MODE/ ERASE/ EQ/ A-B/ TIMER/ VOL+ / VOL-/HOLD/SPEED	
POWER requirement	RECHARGEABLE Li-polymer 37V/1000mA	
Battery life	MP3 PLAY	Approx 15hour during the mp3 play (earphone output: volume middle position)
	VOICE PLAY	Approx 15hour during the voice play (earphone output: volume middle position)

	RADIO RECIEVING	Approx 15hour during the radio play (earphone output: volume middle position)
	RADIO/VOICE REC	Approx 7hour during the radio play (earphone output: volume middle position)
Operating Temp		0℃ - +40℃
Accessory		Line in cable(1)/ Win 98SE Driver CD (1)/ Neck strap (1)/ stereo earphone (1) / EXT ANT (1)/ AC/DC adapter(1) / USB cable (1)/ manual (1)
SIZE		2.36" (W) X 3.93" (H) X 0.78" (D)

Warranty

- If any defect or error occurs, stop using the product and contact PoGo! Products, Inc.
General Directory Number: (714) 671-1854

- Warranty (Warranty Regulation)

PoGo! Products will guarantee a free repair or service for a period of one year from the original date of purchase. If any defect or error occurs during the warranty period, please contact us

A dated order/receipt is **REQUIRED** for all warranty claims Ensure the above information is provided and if it not, consult with the shop you purchased the unit from to obtain it

(Repair or Service)

- A. This product is manufactured under a strict quality control and inspection process
- B. If any defect or error occurs under normal operation, in accordance with the caution or notes in this manual during the warranty period, you are entitled to a free repair or exchange from our company
- C. The repair/service does NOT include shipping charges

● There will be a charge for the following:

- 1) Without a dated purchase order/receipt
- 2) If the original date of purchase is passed the warranty period or the dated purchase order/receipt is modified in any way
- 3) For any defect or damage resulting from misuse, abnormal use, abnormal condition, improper storage and/or exposure to direct sunlight or moisture
- 4) For any defect or damage resulting from any unauthorized modification or repair
- 5) For any defect or damage resulting from disasters such as fire, air pollution, earthquake or war
- 6) For any defect or damage resulting from a leak of the battery
- 7) Consumable item such as the battery

● The warranty is only valid for service in the USA.

(Caution Upon Shipping The Product For Warranty Service)

● If you need to ship the product for warranty service, please do the following:

1. Enclose the original dated purchase order/receipt with the product during the warranty period
2. Avoid damage to the product during shipping/transportation using proper packing materials
3. Use registered and/or insured mail to prevent a loss

● The customer shall bear all costs of shipping the product properly.

● If any defect occurs during the use of this product, contact the shop you purchased or PoGo! Products, Inc.

● Replacement, repairs (charge/free) or refunds must be in accordance with our policy and can be found at:

<http://www.pogoproducts.com/support.html>

● If you have any further questions about this product, please contact PoGo! Products, Inc.



PoGo! Products Inc
590 W Central Ave Suite E
Brea, CA 92821
Phone: 714-671-1854

The warranty may only be used in the USA Please keep your dated purchase order/receipt safely as it is required for any warranty service.

Free Manuals Download Website

<http://myh66.com>

<http://usermanuals.us>

<http://www.somanuals.com>

<http://www.4manuals.cc>

<http://www.manual-lib.com>

<http://www.404manual.com>

<http://www.luxmanual.com>

<http://aubethermostatmanual.com>

Golf course search by state

<http://golfingnear.com>

Email search by domain

<http://emailbydomain.com>

Auto manuals search

<http://auto.somanuals.com>

TV manuals search

<http://tv.somanuals.com>